



ToyotaOwnersOnline.com

CUSTOMER EXPERIENCE CENTER

1-800-331-4331

AVALON

2 0 1 0

QUICK REFERENCE GUIDE



Mixed Sources

Product group from well-managed
forests, controlled sources and
recycled wood or fiber
www.fsc.org Cert no. SGS-COC-005612
© 1996 Forest Stewardship Council



2010 Avalon

This *Quick Reference Guide* is a summary of basic vehicle operations. It contains brief descriptions of fundamental operations so you can locate and use the vehicle's main equipment quickly and easily.

The *Quick Reference Guide* is not intended as a substitute for the *Owner's Manual* located in your vehicle's glove box. We strongly encourage you to review the *Owner's Manual* and supplementary manuals so you will have a better understanding of your vehicle's capabilities and limitations.

Your dealership and the entire staff of Toyota Motor Sales, U.S.A., Inc. wish you many years of satisfied driving in your new Avalon.

! A word about safe vehicle operations

This *Quick Reference Guide* is not a full description of Avalon operations. Every Avalon owner should review the *Owner's Manual* that accompanies this vehicle.

Pay special attention to the boxed information highlighted in color throughout the *Owner's Manual*. Each box contains safe operating instructions to help you avoid injury or equipment malfunction.

All information in this *Quick Reference Guide* is current at the time of printing. Toyota reserves the right to make changes at any time without notice.

Trunk-Internal release

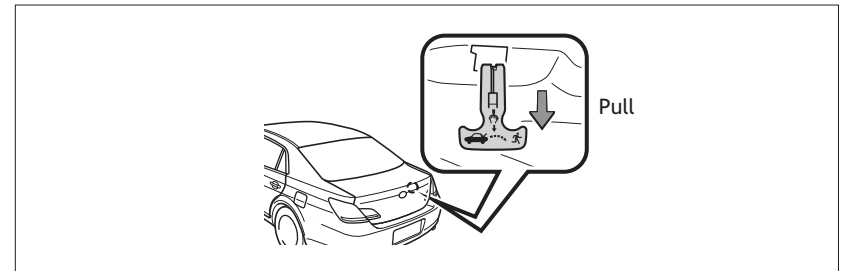

Spare tire & tools

Tool location

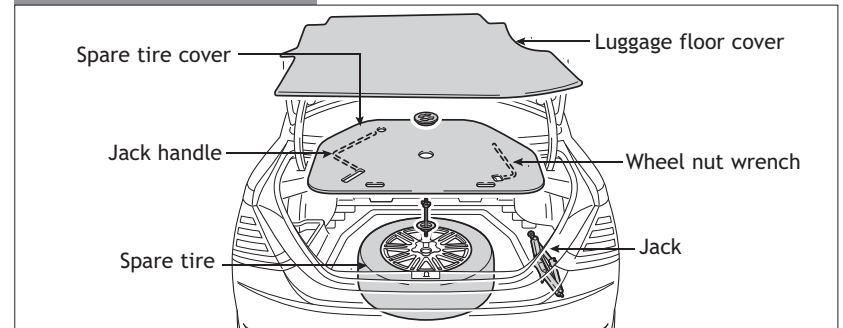

Removing the spare tire

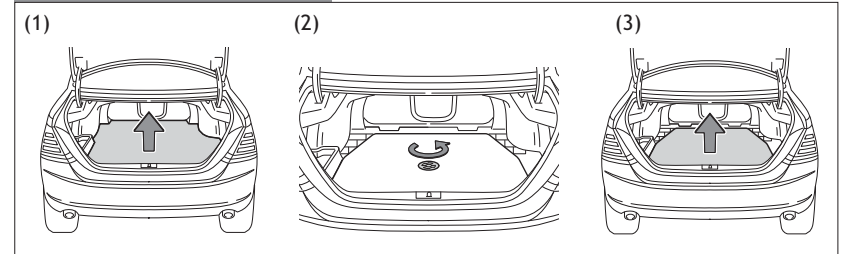

- (1) Remove the luggage cover.
- (2) Loosen and remove the center fastener.
- (3) Remove the spare tire cover.

Refer to the *Owner's Manual* for tire changing and jack positioning procedures.

INDEX

OVERVIEW

Engine maintenance	9
Fuel tank door release and cap	8
Hood release	9
Indicator symbols	4-5
Instrument cluster	4
Instrument panel	2-3
Keyless entry¹	6
Light control-Instrument panel	8
Smart Key system²	7
Trunk release	8

FEATURES/OPERATIONS

Air Conditioning/Heating	20
Audio	18
Auto lock functions²	10
Automatic Transmission	10
Center display	19
Clock	22
Cruise control	16
Cup holders	22
Door locks	21
Dynamic Laser Cruise Control	17
Garage door opener (HomeLink [®]) ³	16
Lights¹ & turn signals	13
Moonroof	14
Parking brake	11
Power outlets	22
Seat adjustments-Front	12
Seat adjustments-Rear	12
Seat ventilators/Heaters	21
Seats-Head restraints	11
Steering lock release	10
Steering wheel switches	19
Sunshade-Rear¹	14
Telephone controls (Bluetooth [®])	15
Tilt and telescopic steering wheel	11
Windows-Power	14
Windshield wipers & washers¹	12

SAFETY AND EMERGENCY FEATURES

Doors-Child safety locks	23
Seatbelt comfort guide	24
Seatbelts	23
Seatbelts-Shoulder belt anchor	23
Spare tire & tools	25
Tire Pressure Monitoring (warning) System	24
Trunk-Internal release	25

¹ Visit your Toyota dealer for information on customizing this feature.

² Programmable by customer. Refer to the Owner's Manual for instructions and more information.

³ HomeLink[®] is a registered trademark of Johnson Controls, Inc.

OVERVIEW

Instrument panel

Steering wheel controls

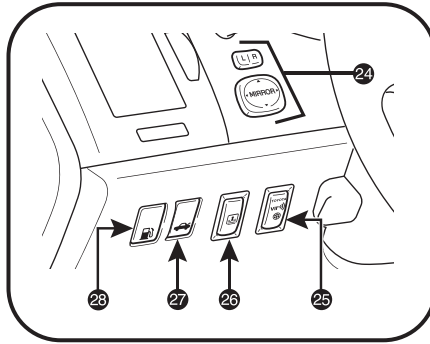
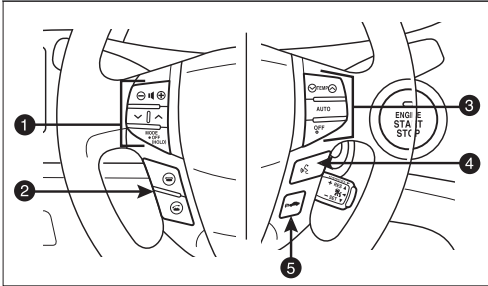

- ❶ Steering wheel audio controls
- ❷ Telephone controls¹
- ❸ Steering wheel climate controls
- ❹ Voice command button^{1,2}
- ❺ Distance button¹
- ❻ Driving position memory switches¹
- ❼ Headlight, turn signal and front fog light¹ controls
- ❽ Ignition switch (standard key)¹
- ❾ Wiper and washer controls
- ❿ "ENGINE START STOP" button (Smart Key)¹
- ⓫ Clock
- ⓬ Center display¹/Navigation system^{1,2}
- ⓭ Emergency flasher button
- ⓮ "AIR BAG ON" and "AIR BAG OFF" indicator and front passenger seatbelt reminder lights
- ⓯ Air Conditioning controls

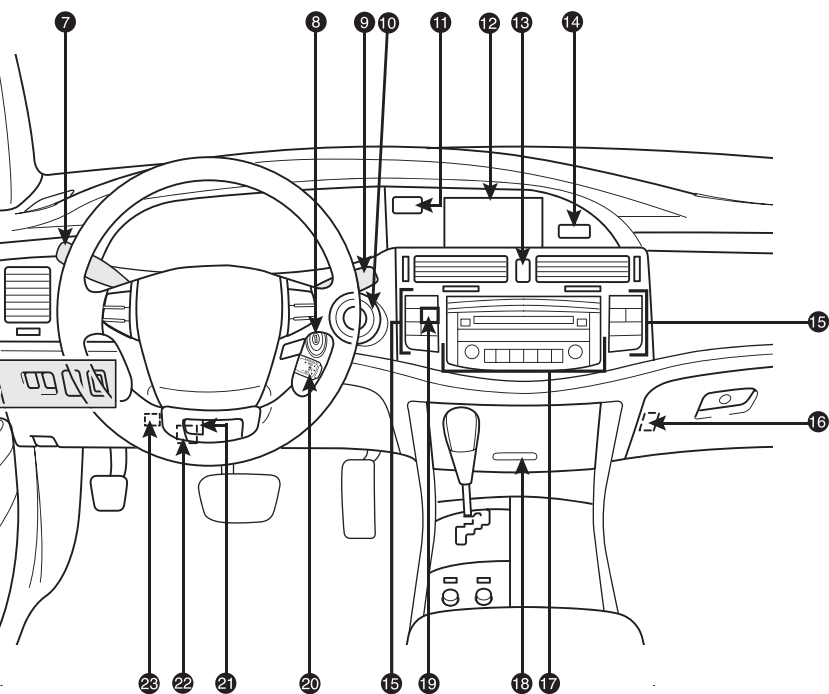

- 16 Trunk opener main switch
- 17 Audio system
- 18 Storage compartment¹/Navigation system switches^{1,2}
- 19 Outside rearview mirror¹/Rear window defogger button
- 20 Cruise control
- 21 Tilt lock release lever
- 22 Tire Pressure Monitoring (warning) System reset
- 23 Telescopic lock release
- 24 Power rearview mirror control
- 25 Glass breakage sensor¹
- 26 Rear sunshade switch¹
- 27 Trunk opener
- 28 Fuel filler door opener

¹ If equipped



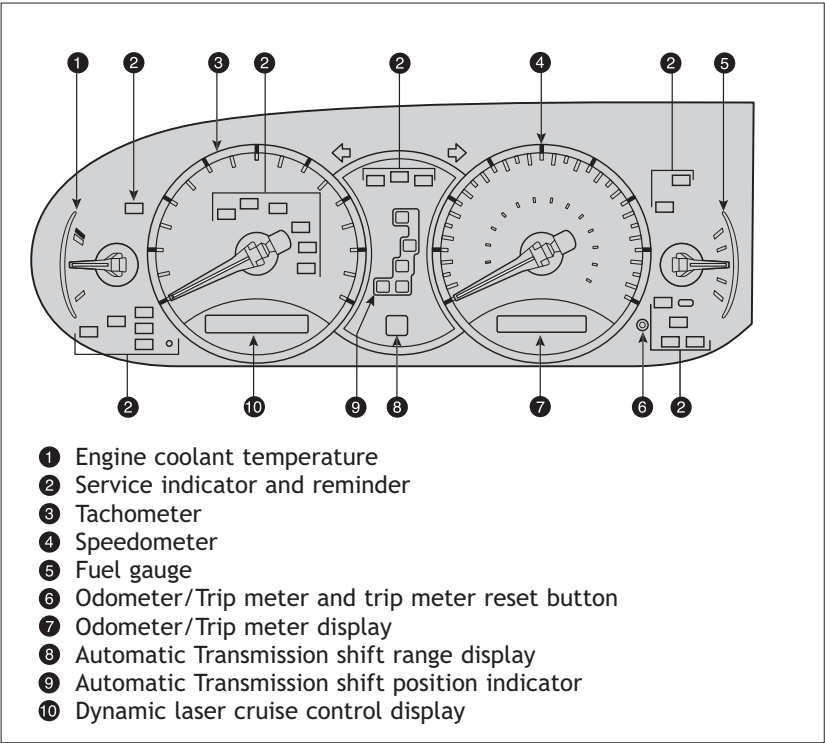

² For vehicles with a navigation system, refer to the "Navigation System Owner's Manual."

Instrument cluster





















Indicator symbols

For details, refer to "Indicators and warning lights," Section 2-2, 2010 *Owner's Manual*.

- BRAKE** Brake system warning¹
-  Driver seatbelt reminder
(alarm will sound if speed is over 9 mph)
- PASSENGER**
 Front passenger seatbelt reminder
(alarm will sound if speed is over 9 mph)
-  Charging system warning¹
- PASSENGER**
AIR BAG
OFF  Front passenger occupant classification indicator/
Front passenger airbag ON/OFF indicator¹
-  Low engine oil pressure warning¹

¹ If indicator does not turn off within a few seconds of starting engine, there may be a malfunction. Have vehicle inspected by your Toyota dealer.

	Malfunction/Check Engine indicator ¹
	Engine oil replacement reminder ¹
	Low fuel level warning
	Open door warning
	Airbag SRS warning ¹
	Tire Pressure Warning ¹
	Low windshield washer fluid level warning ¹
	Security indicator
	Headlight low/high beam indicator
	Turn signal indicator
	Automatic headlight leveling system warning ¹
	Slip indicator
	Vehicle Stability Control system warning ¹
	SET Cruise control indicator ²
	Ready mode indicator ¹
	Conventional cruise
	Dynamic Laser Cruise Control master warning light ¹
	Anti-lock Brake System warning ¹
	Smart Key system warning ¹

² If this light flashes, refer to "Cruise control," Section 2-4, 2010 Owner's Manual.

Keyless entry

Locking operation

Without Smart Key system

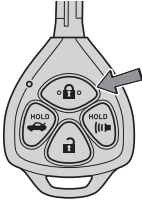

With Smart Key system



Unlocking operation

Without Smart Key system



With Smart Key system



Push ONCE: Driver door
TWICE: All doors



NOTE: If a door is not opened within 60 seconds of unlocking, all doors will relock for safety.

Trunk lid operation

Without Smart Key system

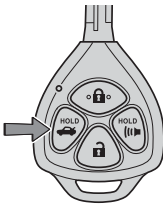

With Smart Key system

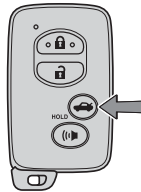

Panic button

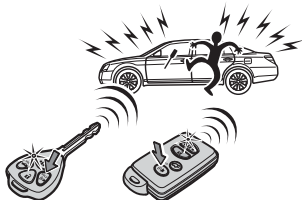

Smart Key system (if equipped)

Start function

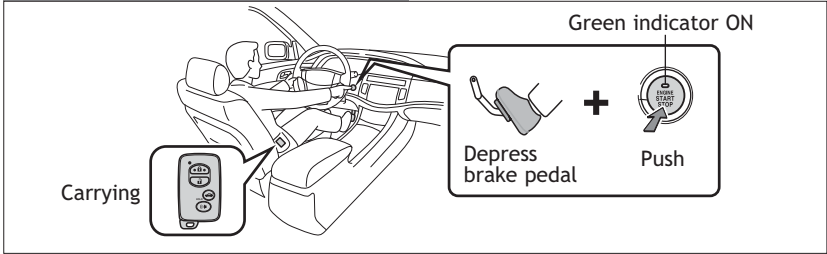

NOTE: Gear shift lever must be in Park and brake pedal depressed.

Power (without starting engine)

Without depressing the brake pedal, pressing the "ENGINE START STOP" switch will change the operation mode in succession from:

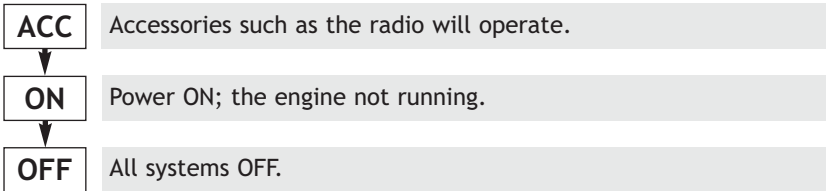

Locking operation

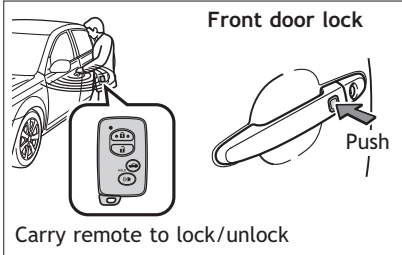

Unlocking operation

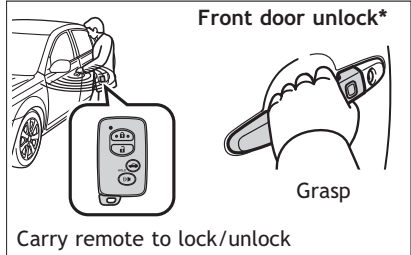

Trunk access

Opening trunk

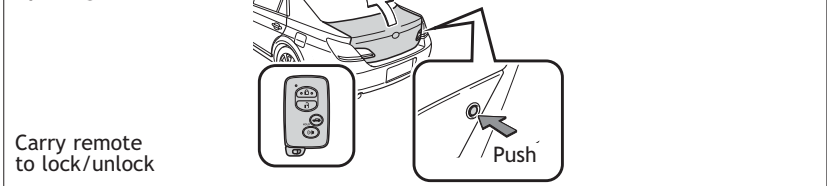

* Driver door unlocking function can be programmed to unlock driver door only, or all doors. Grasping passenger door handle will unlock all doors.

NOTE: Doors may also be locked/unlocked using remote.

Fuel tank door release and cap

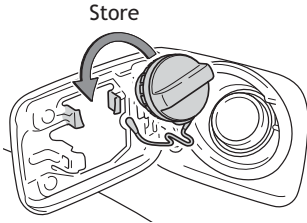
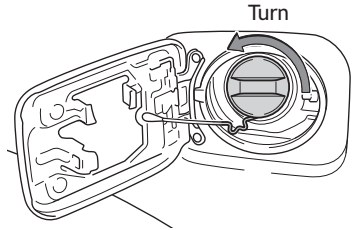
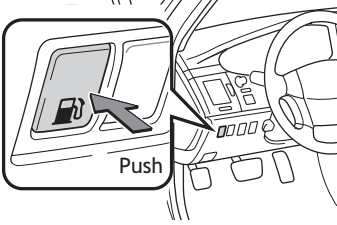

NOTE: Tighten until one click is heard. If the cap is not tightened enough, Check Engine “” indicator may illuminate.

Light control-Instrument panel

Brightness control

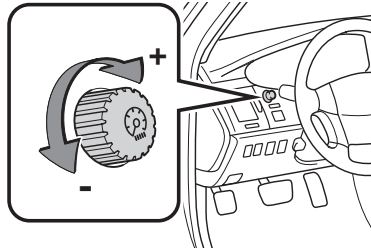

Trunk release

Trunk opener

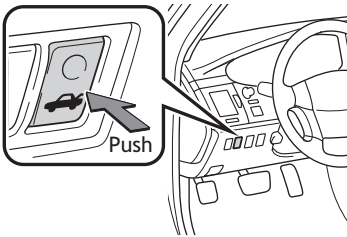

Main switch

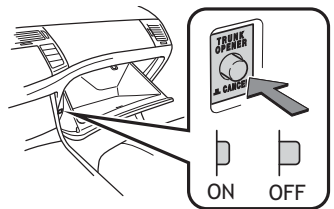

Hood release

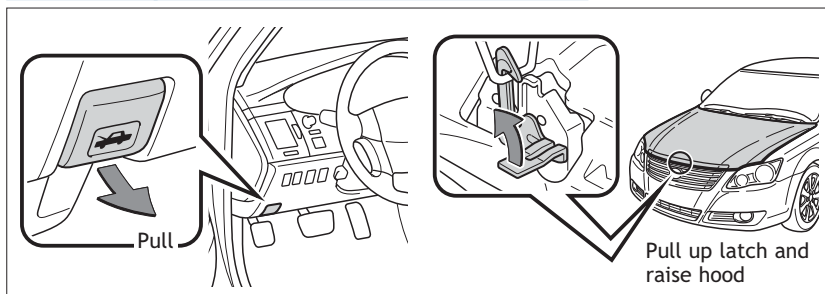

Engine maintenance

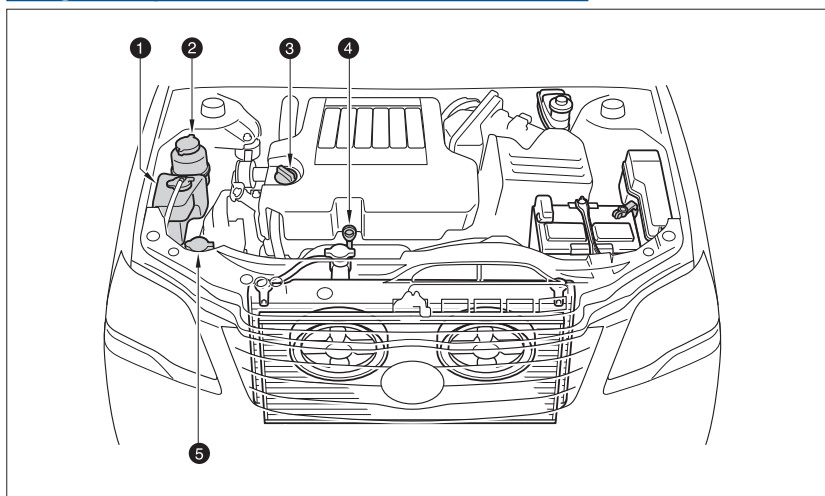

- ① Engine coolant reservoir
- ② Power steering fluid reservoir
- ③ Engine oil filler cap
- ④ Engine oil level dipstick
- ⑤ Windshield washer fluid tank

NOTE: Regularly scheduled maintenance, including oil changes, will help extend the life of your vehicle and maintain performance. Please refer to the "Warranty Maintenance Guide."

FEATURES/OPERATIONS

Auto lock functions

Automatic door locks can be programmed to operate in two different modes, or turned OFF.

1. Doors lock: when shifting from Park.
Doors unlock: when shifting into Park.
2. Doors lock: when the vehicle speed goes above 12 mph.
Doors unlock: when the driver's door is opened within 10 seconds after turning the "ENGINE START STOP" switch or the engine switch OFF.

Refer to the *Owner's Manual* for more details.

Automatic Transmission

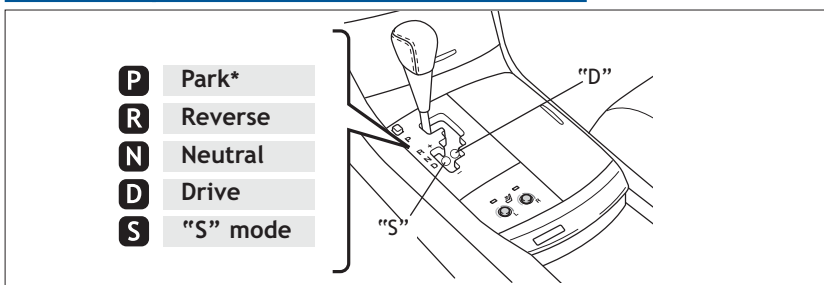

* The "ENGINE START STOP" switch/engine must be "ON" and the brake pedal depressed to shift from Park.

"S" (Sequential) mode

Shift the shift lever to "S" position from "D" position.

Floor shift type:

- + : Upshift (push and release)
- : Downshift (pull and release)

Downshifting increases power going uphill, or provides engine braking downhill. For best fuel economy during normal driving conditions, always drive with the shift lever in the "D" position.

Steering lock release

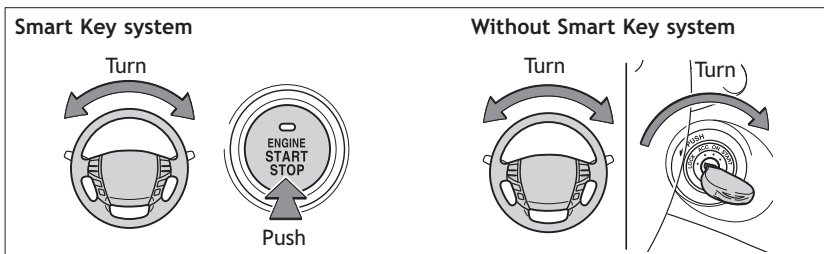

Tilt and telescopic steering wheel

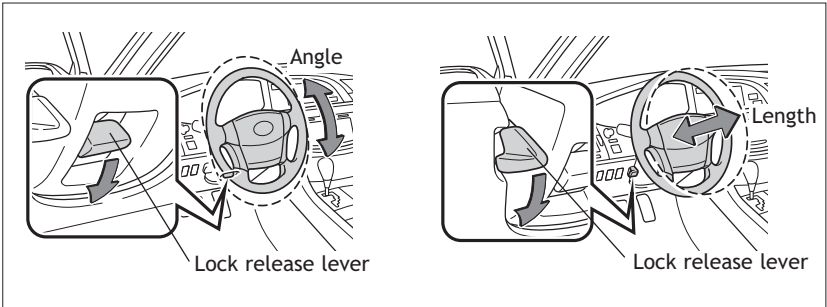

Hold wheel, push lever down, set angle and length, and return lever.

NOTE: Do not attempt to adjust while the vehicle is in motion.

Parking brake

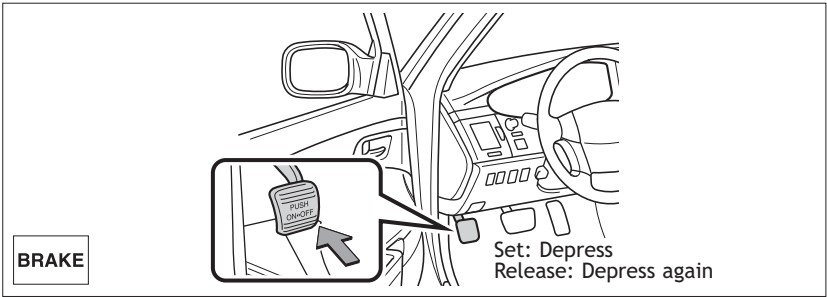

Seats-Head restraints

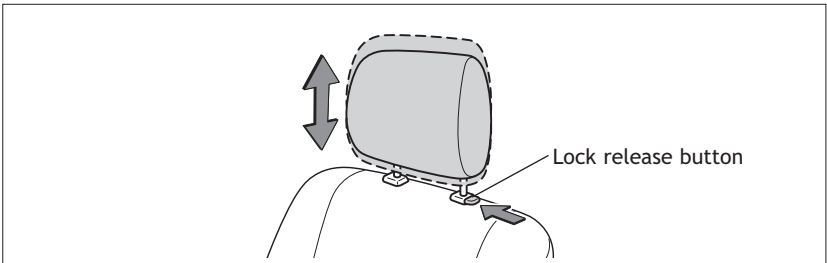

Seat adjustments-Front

Manual seat



Power seat

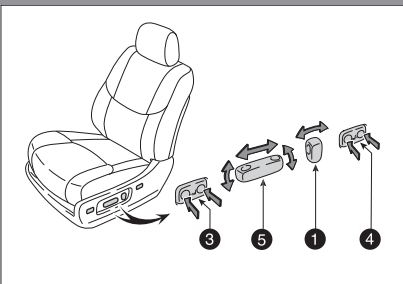

- ① Seatback angle
- ② Seat position (forward/backward)
- ③ Leg support (if equipped)
- ④ Lumbar support (if equipped)
- ⑤ Position, cushion angle (if equipped) and height (if equipped)

Seat adjustments-Rear

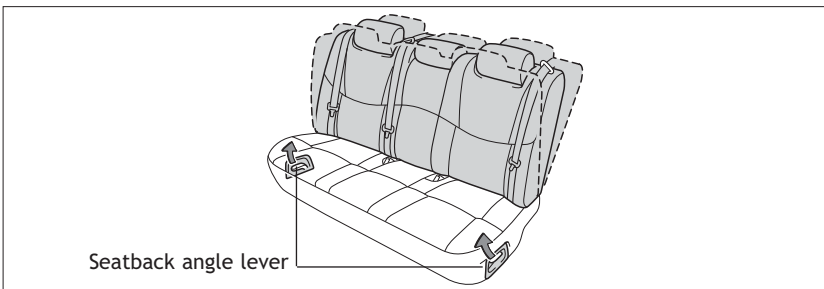

Refer to the *Owner's Manual* for more details.

Windshield wipers & washers

With interval wiper

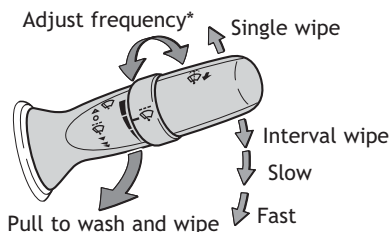

With AUTO rain-sensing wiper

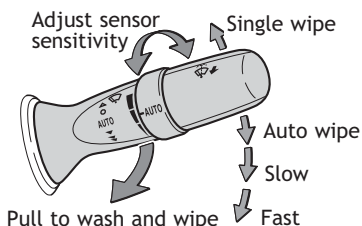

*** Intermittent windshield wiper frequency adjustment**
 Rotate to increase/decrease wipe frequency.

Lights & turn signals

Headlights

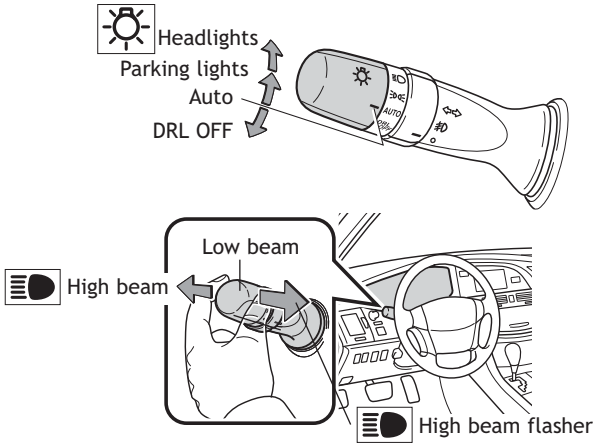

- Daytime Running Light system (DRL) Automatically turns on the headlights at a reduced intensity.
- Automatic light cut off system Automatically turns lights off after a delay of 30 seconds, or the lock switch on remote may be pushed after locking.

Front fog lights (if equipped)

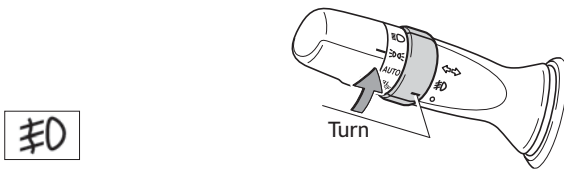

Front fog lights come on only when the headlights are on low beam.

Turn signals

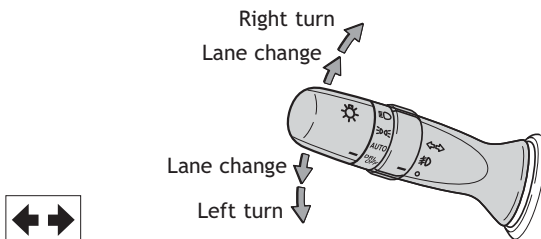

Windows-Power

Driver side

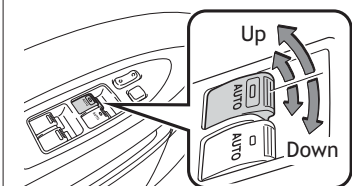

Automatic operation Push the switch completely down or pull it completely up and release to fully open or close. To stop window midway, lightly push the switch in the opposite direction.

Window lock switch Deactivates all passenger windows. Driver's window remains operable.

NOTE: If battery is disconnected, the window needs to be reinitialized. Refer to the *Owner's Manual* for more details.

Moonroof (if equipped)

Sliding operation

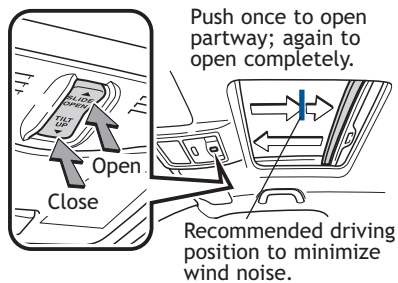

Tilting operation

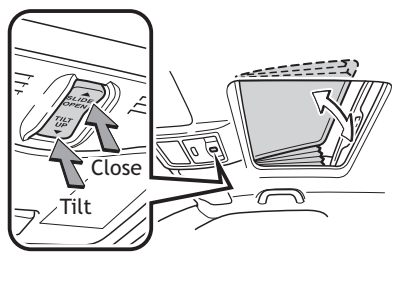

NOTE: If battery is disconnected, the moonroof needs to be reinitialized. Refer to the *Owner's Manual* for more details.

Sunshade-Rear (if equipped)

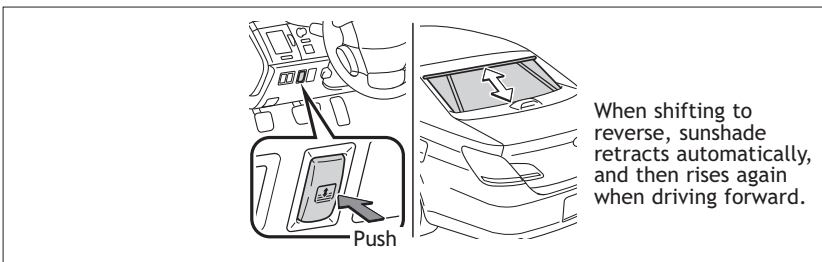

Telephone controls (Bluetooth®) (if equipped)

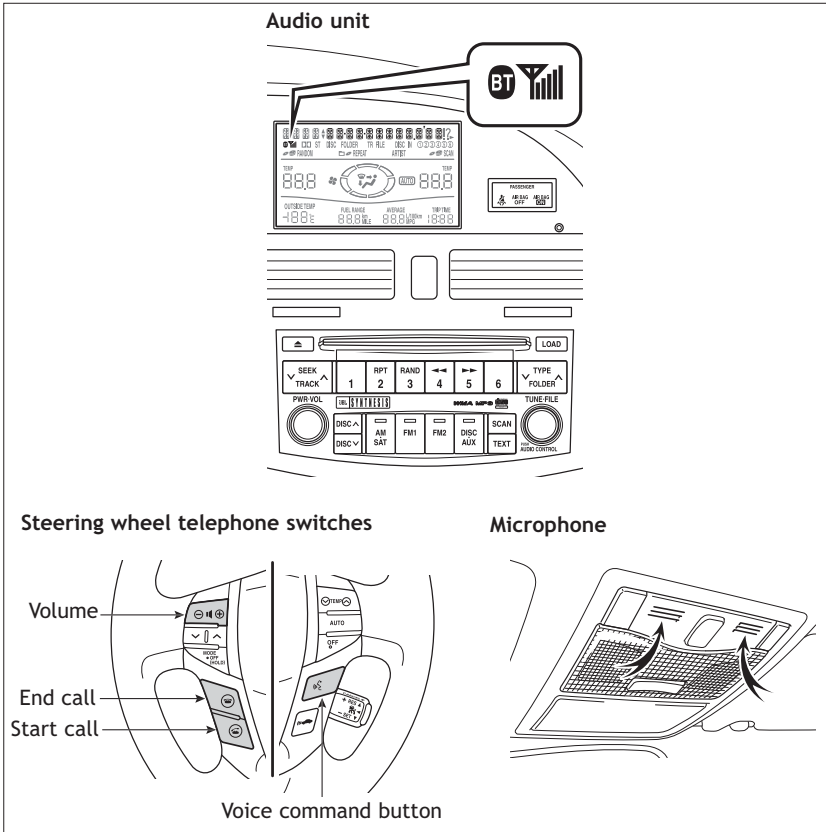

Bluetooth® technology allows dialing or receipt of calls without taking hands from the steering wheel or using a cable to connect the compatible telephone and the system.

Refer to "Hands-free system (for cellular phone)," Section 3-3 in the *Owner's Manual* for more details, or go to Toyota.com and enter "Bluetooth" in the keyword search.

Garage door opener (HomeLink®)* (if equipped)

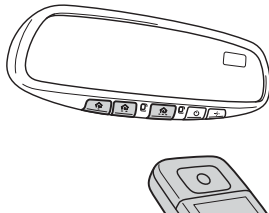

Garage door openers manufactured under license from HomeLink®* can be programmed to operate garage doors, estate gates, security lighting, etc.

Refer to "Garage door opener," Section 3-6 in the *Owner's Manual* for more details.

For programming assistance, contact HomeLink® at 1-800-355-3515, or visit <http://www.homelink.com>.

* HomeLink® is a registered trademark of Johnson Controls, Inc.

Cruise control

Turning system ON/OFF

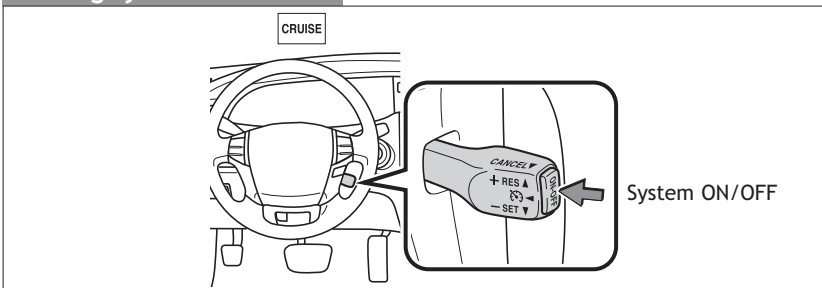

Functions



¹ The set speed may also be cancelled by depressing the brake pedal.

² The set speed may be resumed once vehicle speed exceeds 25 mph.

Dynamic Laser Cruise Control (if equipped)

Refer to the *Owner's Manual* for more details and complete safety precautions before attempting to use "Dynamic Laser Cruise Control."

Fixed speed mode

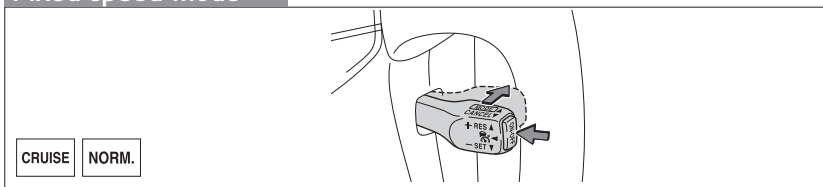

- (1) **To select conventional/fixed speed control** Push the ON-OFF button. Push the lever forward and hold until the "NORM." indicator appears.
- (2) **To set, cancel and resume a speed** Refer to instructions for *Cruise Control* on the previous page.

Distance control mode

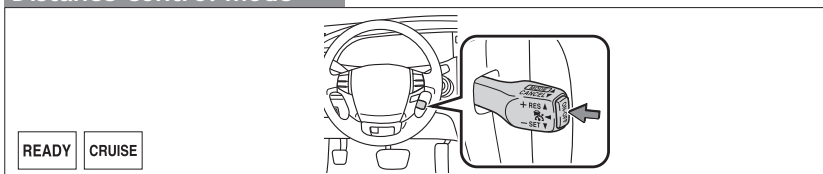

Distance control mode will cruise at a set speed, decelerate to maintain selected distance from a slower vehicle traveling in front of you, and accelerate back up to the selected speed if the vehicle in front of you changes lanes or speeds up.

- (1) **To select distance control mode** Push the ON-OFF button. The "READY" and "CRUISE" indicator will come on.
- (2) **To set, cancel and resume a speed** Refer to instructions for *Cruise Control* on the previous page.

NOTE: Once vehicle speed is set, pushing lever up toward "+ RES" will increase speed to the nearest 5 mph, and then in 5 mph increments. Pushing lever down toward "- SET" will reduce speed in the same way.

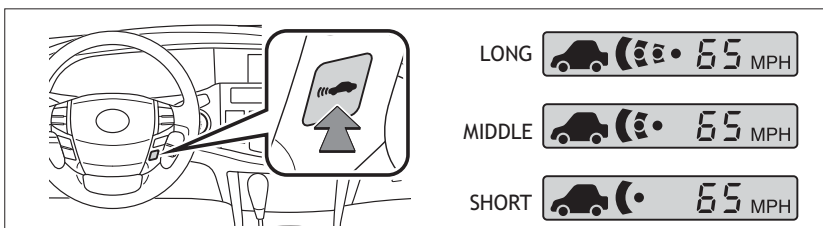

- (3) **To change the vehicle-to-vehicle distance** Push the distance button to cycle through the settings, which will change progressively from LONG to MIDDLE to SHORT.

Audio

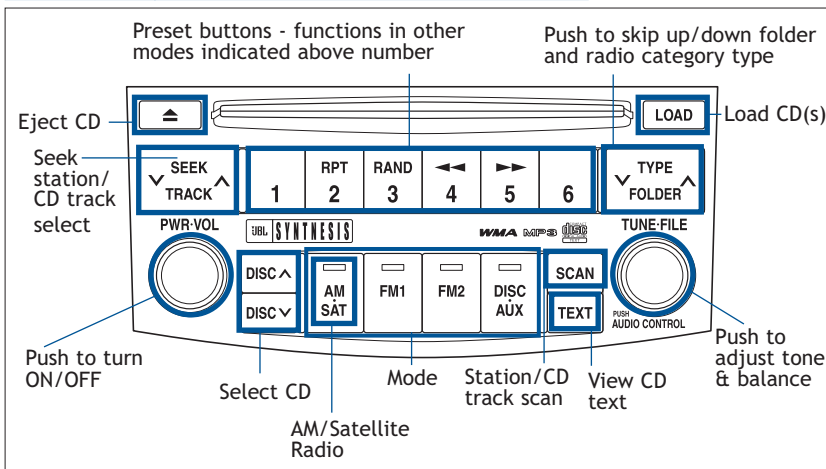

CD PLAYER

To scan tracks on a disc Push "SCAN." Push again to hold selection.

CD changer

-To load one disc Push "LOAD" and insert one disc.

-To load multiple discs Push and hold "LOAD" until you hear a beep. Insert one disc. Shutter will close and then re-open for next disc.

To select a CD Push "DISC ^" or "DISC V."

To select a file (MP3/WMA only) Turn "TUNE-FILE."

To select a folder (MP3/WMA only) Push either side of "FOLDER."

RADIO

To preset stations Tune in the desired station and hold down a preset button (1-6) until you hear a beep. Push desired preset button (1-6) to select.

To scan stations Push and hold "SCAN" to scan preset stations. Push again to hold selection.

AUX audio jack

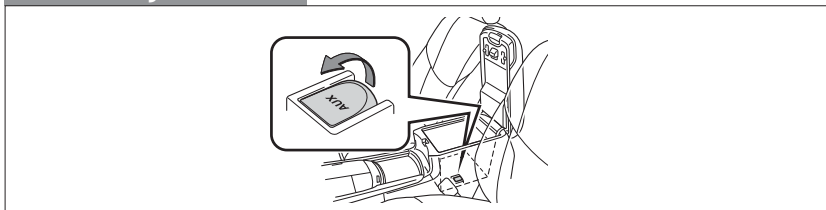

By inserting a mini plug into the AUX audio jack, you can listen to music from a portable audio device through the vehicle's speaker system while in AUX mode.

Steering wheel switches

Audio control

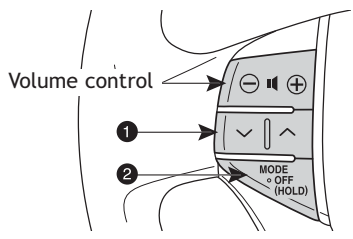

Climate control

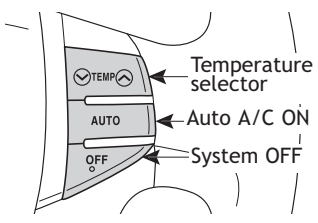

① “V Λ”

Use to search within the selected audio medium (radio, CD, iPod, etc.).

② “MODE”

Push to turn audio ON and select an audio mode. Push and hold to turn audio system OFF.

Center display

Without navigation system

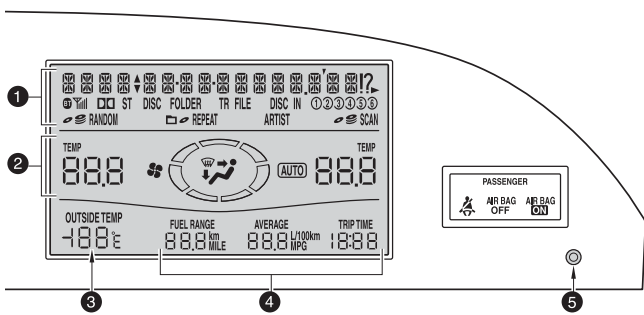

① Audio display

② Air Conditioning display

③ Outside temperature

④ Trip information display

⑤ Pattern selector knob

Display item can be switched by pushing the knob: (1) Entire display (2) Audio display and Air Conditioning display (3) OFF

With navigation system Refer to the “Navigation System Owner’s Manual.”

Air Conditioning/Heating

Display

Without navigation system

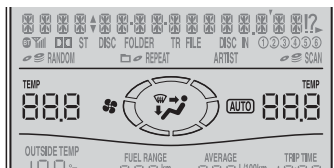

With navigation system

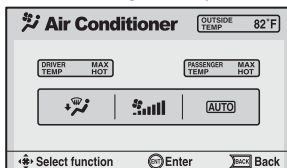

Control

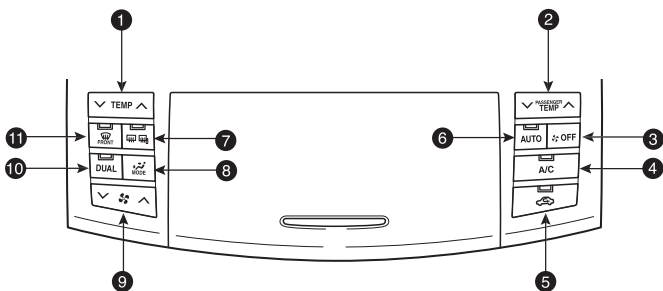

- 1 Temperature selector (driver side)
- 2 Temperature selector (passenger side)
- 3 Climate control OFF
- 4 Air Conditioning ON/OFF
- 5 Fresh or recirculated cabin air
- 6 Automatic climate control ON
- 7 Outside rearview mirror*/Rear defogger
- 8 Airflow vent
In " " mode, use fresh air (" indicator OFF) to reduce window fogging.
- 9 Fan speed
- 10 "DUAL" button
Indicator ON: Separate temperature settings for driver and passenger.
Indicator OFF: Synchronize temperature settings for driver and passenger.
- 11 Windshield defogger

* If equipped

Seat ventilators/Heaters (if equipped)

With ventilator

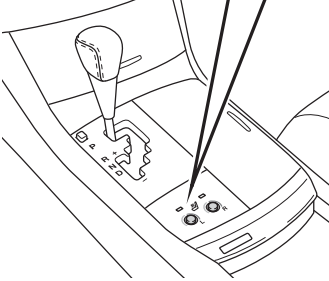
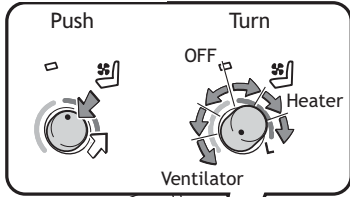

Heater only

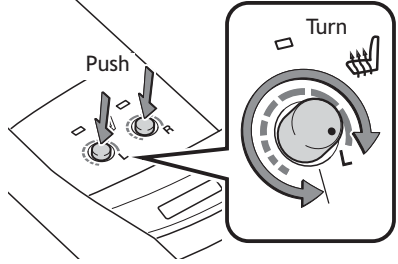

Push knob to pop the controller out. Turn clockwise for heater, counter-clockwise for ventilator.

Door locks

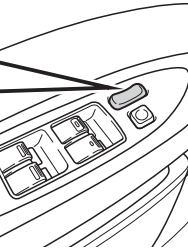
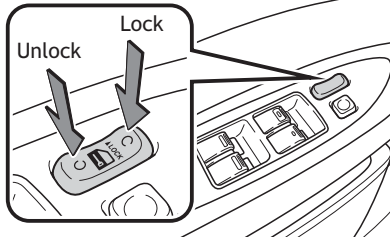

Power outlets

Auxiliary box

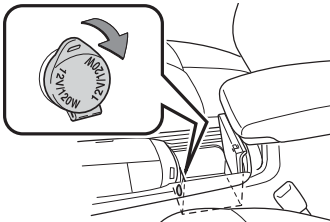

Console box

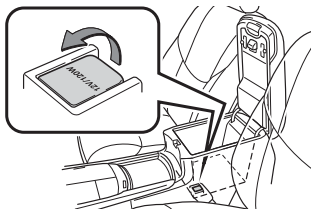

The "ENGINE START STOP" switch/engine switch must be in the "ACC" or "ON" position to be used.

Cup holders

Front

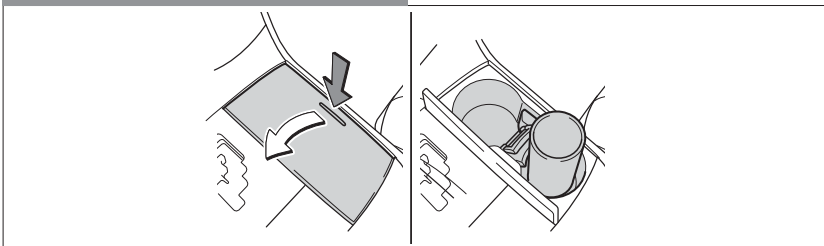

Rear (type A)

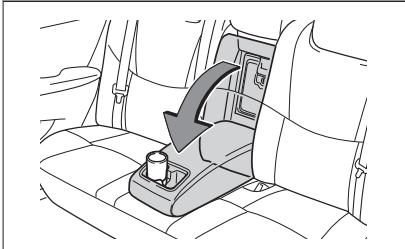

Rear (type B)

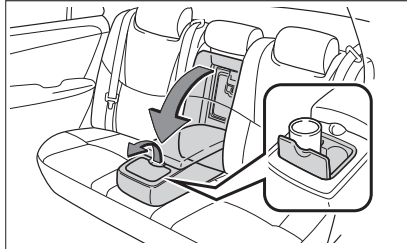

Clock

Without navigation system

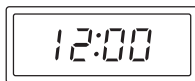

○ H ○ M ○ :88

H-Hour set
M-Minute set
:00-Round off minutes

With navigation system Refer to the "Navigation System Owner's Manual."

SAFETY AND EMERGENCY FEATURES

Doors-Child safety locks

Rear door

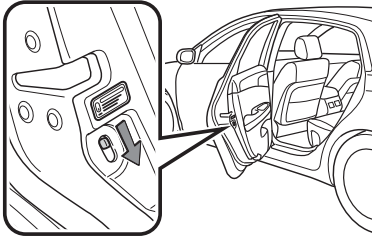

Moving the lever to "LOCK" will allow the door to be opened only from the outside.

Seatbelts

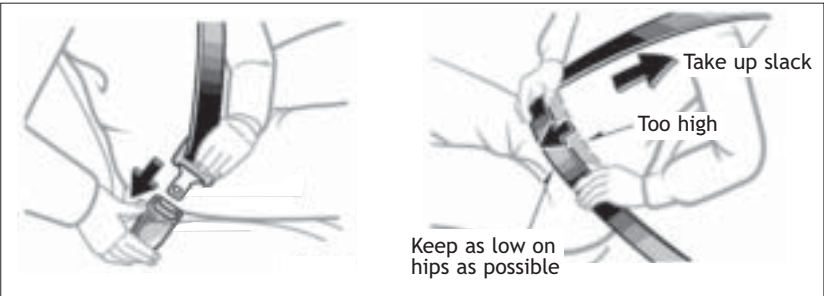

If belt is fully extended, then retracted even slightly, it cannot be re-extended beyond that point, unless fully retracted again. This feature is used to help hold child restraint systems securely.

To find more information about seatbelts, and how to install a child restraint system, refer to the *Owner's Manual*.

Seatbelts-Shoulder belt anchor

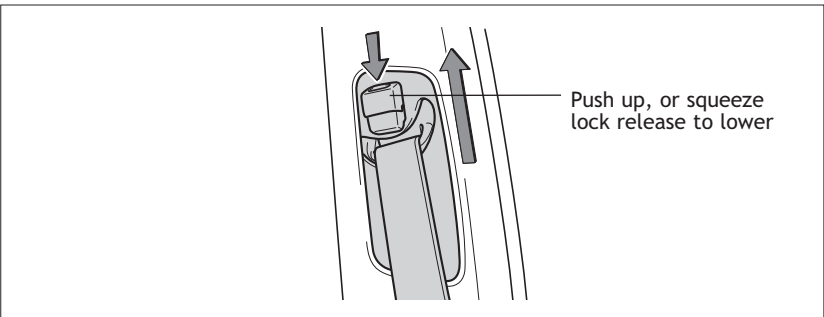

Seatbelt comfort guide



Rear seat outside position guides provide added comfort for children who have outgrown child restraints.

Tire Pressure Monitoring (warning) System

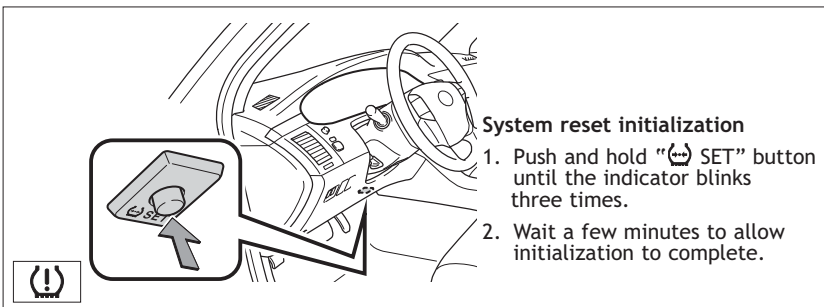

After adjusting tire pressures, or after tires have been rotated or replaced, turn the ignition switch to "ON" and press and hold the "SET" button until indicator blinks three times. Let the vehicle sit for a few minutes to allow initialization to complete.

Refer to the load label on the door jamb or the *Owner's Manual* for tire inflation specifications.

If the tire pressure indicator flashes for more than 60 seconds and then remains on, take the vehicle to your local Toyota dealer.

NOTE: The warning light may come on due to temperature changes or changes in tire pressure from natural air leakage. If the system has not been initialized recently, setting the tire pressures to factory specifications should turn off the light.