

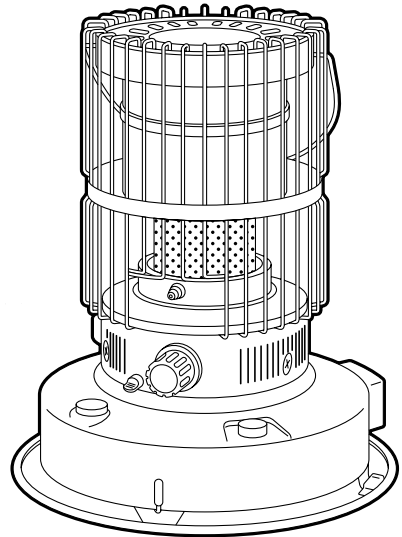

PORTABLE KEROSENE HEATER OPERATION AND MAINTENANCE INSTRUCTIONS

MODEL **DC-100C**



IMPORTANT

READ AND UNDERSTAND INSTRUCTIONS BEFORE USING HEATER.
RETAIN INSTRUCTIONS FOR FUTURE REFERENCE.

SAFETY TIPS	1	ASSEMBLY AND OPERATION	6
FUEL GUIDE	3	CARE AND MAINTENANCE	11
OPERATING CONTROLS AND FEATURES ...	4	REPLACEMENT OF PARTS	12
SPECIFICATIONS	5	STORAGE	15
COMPONENT PARTS	5	TROUBLESHOOTING	16

Congratulations; you are ready to begin enjoying the benefits of one of the most advanced kerosene heaters ever made. TOYOTOMI, the leader in kerosene heater technology, has tested and refined the DC-100C to assure you of long-term safety and satisfaction. Please study the following instructions, use and care for your heater carefully, and it will serve you well for many years.

SAFETY TIPS

BEFORE OPERATING YOUR HEATER, PLEASE review these safety tips:

WARNING

RISK OF EXPLOSION

1. Never use any fuel other than water-clear kerosene (ASTM No.1-K kerosene).
Never use gasoline. Use of gasoline can lead to uncontrollable flames resulting in destructive fire. Even kerosene contaminated with small amounts of gasoline, or similarly volatile materials, can be hazardous. Never use a can for kerosene that has previously been used for gasoline, paint thinner, or solvents.
2. Never refill heater fuel tank when heater is operating or still hot. To do so may cause a "flash back" of flame to the fuel container, resulting in injury to yourself and your property.
3. Never use heater in areas where flammable vapors or gases may be present.
Especially avoid use of heater where gasoline, naphtha, acetone or other volatile solvents are in the air, or whose containers are open. Such vapors could be ignited by the heater, resulting in fire and/or explosion.
4. Never fill heater fuel tank in living space. Fill heater tank outdoors. Never overfill your heater. Always replace heater tank cap securely after refueling. Spillage of kerosene produces strong odor which is hard to remove. Spillage on carpet can be ignited if match or some other ignition source contacts it.
5. Never store or transport kerosene in other than a metal or plastic container that is (1) acceptable for kerosene, (2) non-red in color, and (3) clearly marked, "KEROSENE". Never store kerosene in the living space. Picking up a gasoline can by mistake when fueling is a major cause of heater fires.

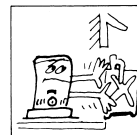
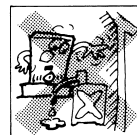
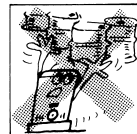
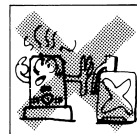
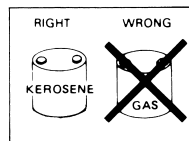

WARNING

RISK OF BURNS OR FIRE

1. Observe the heater carefully for 15-20 minutes after start-up. Problems of improper adjustment of wick height or improperly seated heat chamber should become evident during this warm up period.

NOTE: Carefully follow the instructions for lighting and adjusting the flame.

2. Due to high surface temperatures, keep away from children, furniture and clothing.



3. Do not use heater to heat or boil water or as a cooking appliance. Do not place cooking utensils, tea kettles or any other object on top of heater while in operation.
4. To avoid possible burns or fire, do not move, refuel or attempt to service your heater while it is burning or still hot. If the heater is dropped while it is burning, fuel spillage and flames outside the heater may occur.
5. Do not operate heater less than 1m from walls, draperies, clothing, or furniture. The operation of any heating appliance too close to such materials could cause them to ignite, possibly resulting in a serious fire.
6. To avoid unstable burning, do not operate your heater in areas exposed to strong drafts. Do not operate heater in high-traffic areas such as doorways or hallways where it may be touched, jarred or tipped accidentally.
7. Do not operate heater in direct sunlight to avoid overheating, which may cause abnormal flame behavior. Do not allow room temperature to go above 27°–29°C. If the room temperature exceeds 27°–29°C the flame may increase, thereby producing smoke.
8. Before going out, or at bedtime, turn the heater off, making sure the wick is in its lowest position (see Extinguishing the Flame on page 10) and flame is completely extinguished.

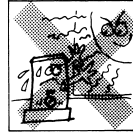
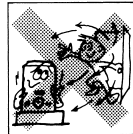
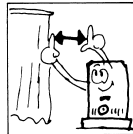
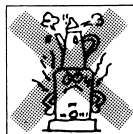

WARNING

RISK OF INDOOR AIR POLLUTION

Use heater only in well-ventilated areas. People with breathing problems should consult a physician before using the heater.

"In a house of typical construction, that is, one that is not of unusually tight construction due to heavy insulation and tight seals against air infiltration, an adequate supply of air for combustion and ventilation is provided through infiltration. However, if the heater is used in a small room where less than 200 cubic feet (5.7 m³) of air space is provided for each 1000 Btu per hour of heater rating (considering the maximum burner adjustment), the door(s) to adjacent room(s) should be kept open or a window to the outside should be opened at least 1 inch (25.4 mm) to guard against potential buildup of indoor air pollution. Do not use the heater in a bathroom or any other small room with the door closed."

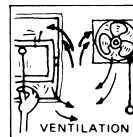

FUEL GUIDE

The DC-100C is designed for use with high-quality kerosene only. Use of low-quality kerosene will cause wick performance to drop, leading to "low flame" and "odor problem" conditions.

Purchase only kerosene in non-red cans reserved exclusively for kerosene and marked accordingly with the word "KEROSENE". Always store your kerosene in a separate area from where you store gasoline for your power equipment, to avoid accidental use of gasoline in your heater.

What to Buy . . .

- ALWAYS : Crystal clear, colorless, high quality KEROSENE, ASTM No.1-K.
- ALWAYS : Kerosene free of contaminants, water or cloudiness.
- NEVER : Gasoline, alcohol, white gas, camp stove fuel or additives.
- NEVER : Yellow or sour-smelling fuel.



How to Use It . . .

- ALWAYS : Fill heater away from living quarters when heater is cool; use siphon.
- ALWAYS : Check wick frequently for tar build-up. (Rapid, heavy build-up may indicate poor quality or deteriorated fuel.)
- ALWAYS : Watch fuel gauge to avoid over-filling heater.

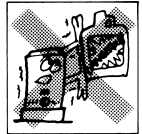

How to Store It . . .

- ALWAYS : In a clean container, clearly marked KEROSENE.
- ALWAYS : AWAY FROM direct sunlight, heat sources or extreme temperature changes.
- NEVER : In a glass container, or one that has been used for other fuels.
- NEVER : For longer than 6 months. (Begin each heating season with fresh kerosene; discard at the end of the season.)



Why It is Important . . .

Pure, clean kerosene is essential for safe and efficient heater operation. Poor quality or contaminated kerosene can cause:

- Low flame
- Excess tar deposits on the wick
- Reduced wick life
- Odor, smoke
- Difficulty in igniting or extinguishing flame

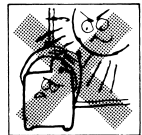

Use of a highly volatile flammable fuel such as gasoline can produce uncontrollable flames, creating a severe fire hazard.

CAUTION

Flames observed emerging from the heater body are a clear indication that fuel is dangerously contaminated with gasoline or other highly flammable material. If this occurs,

- a. Never attempt to move the heater.
- b. Call the Fire Department.
- c. Use only a class "B" fire extinguisher.
- d. Never throw water directly on a burning heater.

OPERATING CONTROLS AND FEATURES

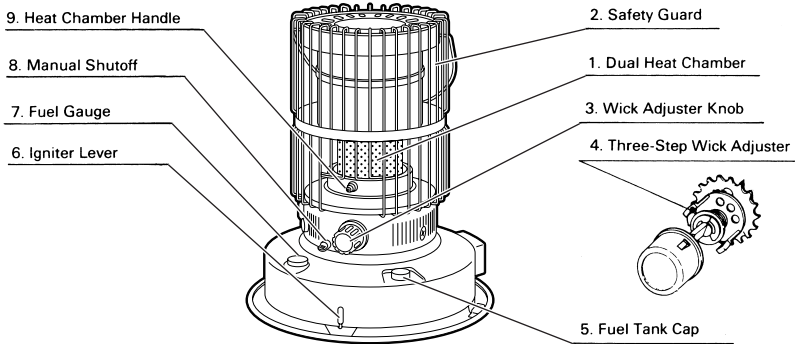

- | | |
|-------------------------|---|
| 1. Dual Heat Chamber: | Permits adjustment of heat output over a wide range without increasing unwanted combustion materials or reducing combustion efficiency. This feature increases comfort and convenience while maximizing fuel savings. |
| 2. Safety Guard: | Extensive grillework covers the hot surfaces of the heater, greatly reducing the possibility of accidental contact burns. |
| 3. Wick Adjuster Knob: | Used to raise and lower wick for heat output adjustment. Includes wick stop mechanism that indicates effective wick height range. To extinguish flame, press red button and turn knob counterclockwise. |
| 4. Wick Life Extender: | Helps maintain good wick performance. |
| 5. Fuel Tank Cap: | Covers filling port of fuel tank.
NOTE: Wipe away any spilled kerosene from tank after filling. |
| 6. Igniter Lever: | Battery-powered electrical igniter is brought in contact with wick to ignite fuel at start-up.
NOTE: Lever should be pushed down gently. |
| 7. Fuel Gauge: | Indicates fuel level in tank.
NOTE: Never fill beyond black line. |
| 8. Manual Shutoff: | Used to rapidly retract wick and extinguish flame.
NOTE: To avoid odor and smoke, do not use routinely to turn heater off. This manual shutoff is not effective when gasoline, gasoline-contaminated kerosene, or other highly flammable fuels are used in the heater. |
| 9. Heat Chamber Handle: | Used to check and insure proper seating of the heat chamber after ignition. Improper seating of the heat chamber will cause erratic flame and smoke. |
| 10. Unique Wick Design: | Triple wick construction combines specially-woven fibers for uniform shape, strength and controlled kerosene absorption; chemically-treated cotton fiber for water resistance; and a vapor barrier for smooth wick retraction. |

SPECIFICATIONS

Portable Kerosene Heater Model DC-100C

Heater rating	17,500 BTU/h (4,430 Kcal/h)
Fuel tank capacity	7.5 ℓ
Buring time/tank*	15-23 Hours
Size (W x H x D)	474 x 560 x 474 mm
Weight	12 kg
Wick adjuster	Wick Life Extender Mechanism
Igniter	Automatic, powered by two (2) "D" size batteries

* Depending on wick setting, condition and fuel quality.

COMPONENT PARTS

REF #	PART NAME
1	Guard assembly
2	Top plate
3	Carrying handle
4	Heat chamber assembly
5	Upper glass cylinder
6	Lower glass cylinder
7	Push ring
8	Cross pin
9	Screw for cover
10	Wick adjuster with pendulum assembly
11	Pendulum assembly
12	Wick adjuster knob
13	Wick height adjuster knob
14	Spring for wick height adjuster
15	Washer for wick height adjuster
16	E ring (L)
17	Screw for pendulum & igniter
18	Wing nut
19	Wick sleeve
20	Glass fiber wick
21	Rubber packing
22	Fuel tank assembly
23	Fuel gauge
24	Fuel tank cap
25	Primary air tube cover
26	Battery holder
27	Igniter coil
28	Igniter unit
29	Igniter lever
30	Spring clip
31	Screw for igniter unit
32	Drip tray
33	Thumbscrew for tray
34	Manual fuel siphon

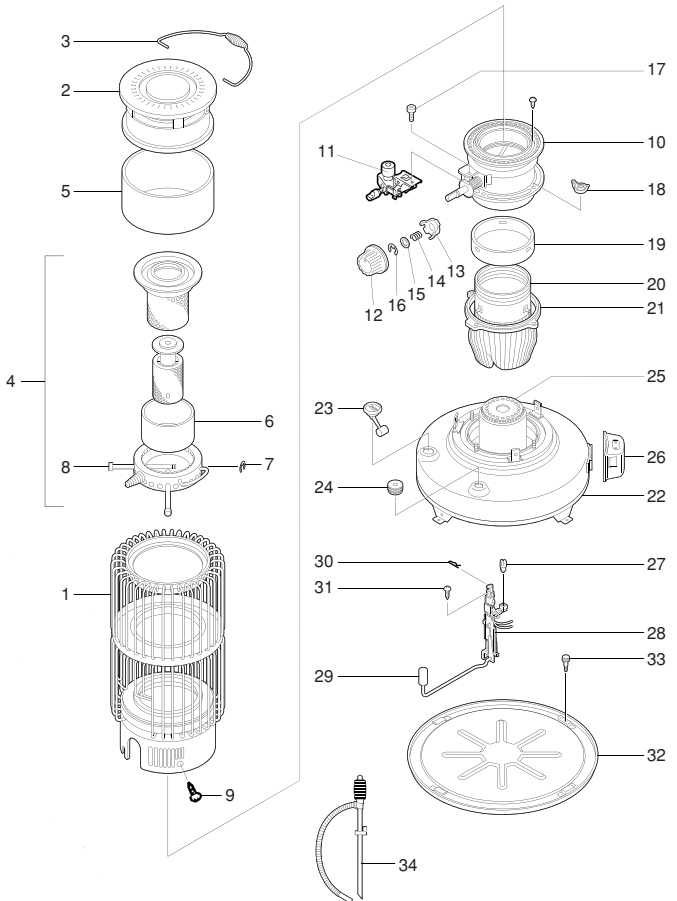

ASSEMBLY AND OPERATION

INSPECTION AND ASSEMBLY

NOTE: Save the shipping carton and packing materials for future storage of your heater.

1. REMOVE PACKING MATERIALS

Remove all packing materials from your heater:

a) Remove the carrying handle.

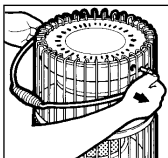

c) Remove the upper glass cylinder and packing material.

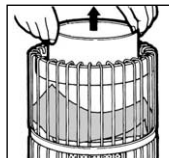

b) Lift up the top plate.

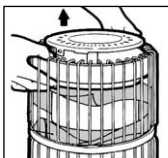

d) Replace the upper glass cylinder, the top plate and the carrying handle.

2. INSTALL DRIP TRAY

NOTE: DO NOT operate your heater without the drip tray.

Place the drip tray on the floor. Remove the thumbscrew.

- Place the heater on the drip tray so the four (4) feet of the heater are next to the four (4) tabs on the tray.
- Turn the heater clockwise until the feet slide into their tabs.
- Replace the thumbscrew to secure the tray.

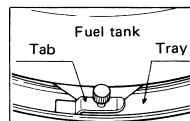

3. INSTALL BATTERIES

Locate the battery holder on the back of your heater. Slide it up slowly to avoid damaging the igniter wires.

- Insert the two (2) "D" size batteries according to the plus (+) and minus (-) markings inside the holder.
- Slide the battery holder back in place.

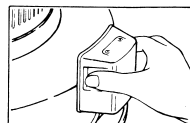

4. CHECK THUMBSCREWS

Make sure that the three (3) thumbscrews around the heater cover above the fuel tank are tight.

FUELING

WARNING: Use only water-clear ASTM No.1-K Kerosene.
Never use gasoline or other flammable liquids.
ALWAYS extinguish heater before refill heater fuel tank.
Fuel heater outside the living area.

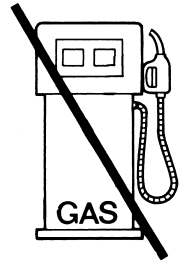

USE KEROSENE ONLY

1. Insert the straight tube of the manual fuel siphon into the kerosene container. Remove the fuel tank cap on the heater, and insert the siphon's flexible hose into the fuel tank opening.

2. Turn the air vent knob on the top of the siphon clockwise to close the air vent.

3. To start the flow of kerosene, squeeze the bulb of the siphon vigorously six or seven times. Once the flow begins, it is no longer necessary to squeeze the bulb. To avoid overfilling the tank, watch the fuel gauge. As the indicator enters the red zone, stop the flow by turning the air vent knob counterclockwise.

NOTE: Be especially careful to avoid overfilling the tank with very cold kerosene; otherwise overflow might occur when the fuel warms up.

4. Remove the siphon carefully, allowing the excess kerosene to drain from the tube back into container. Replace the fuel tank cap and tighten it securely. Be sure to wipe away any spilled kerosene from tank or other heater parts.

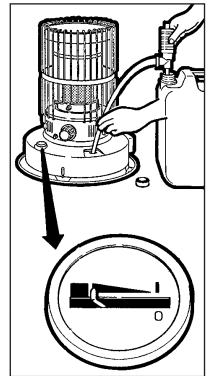

CHECK BEFORE LIGHTING

1. LOCATE YOUR HEATER AWAY FROM WALLS AND AVOID DRAFTS

Allow at least three (3) feet of clearance between the heater and walls, curtains, shelving or other combustible materials. Do not operate your heater in drafty areas or locations where opening doors may create gusts of air. Drafts or strong air currents may make flame unstable and affect heater performance.

2. LEVEL THE HEATER

The heater should be operated on a firm, level floor.

NOTE: If your heater is not level, change locations. Do not attempt to prop it up with books or other objects. An unlevel heater may burn with an uneven flame.

3. CHECK THE WICK LIFE EXTENDER

When you first use your new heater or after replacing the wick, check if the WICK LIFE EXTENDER is on position ①. If not, readjust the wick life extender mechanism to position ② by following the instructions on page 9, ADJUSTMENT OF WICK HEIGHT WITH WICK LIFE EXTENDER.

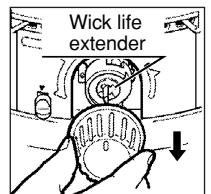

4. ENGAGE THE AUTOMATIC EXTINGUISHER

The automatic extinguisher is engaged automatically by turning the wick adjuster knob clockwise. Check the operation of the automatic extinguisher before lighting your heater. After turning the wick adjuster knob clockwise until it stops, push down on the manual shutoff to be sure the wick moves smoothly down.

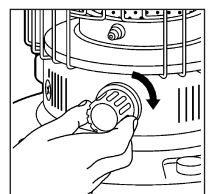

LIGHTING

NOTE: When you first use your new heater, ignite it out of the living area of your house, either in a garage or an outside area protected from strong drafts. Burn it for about 15 minutes to remove all of the protective oil present on the burner parts. If this 15 minute "burn-in" is done inside, some objectionable odor will be observed. This procedure is necessary **ONLY THE FIRST TIME** you ignite your heater.

NOTE: If you have fueled your heater for the first time, or if you are refueling it after it has been out of fuel for a long time, you will need to wait about thirty (30) minutes for the wick to become fully saturated before lighting. Failure to allow enough time for the wick to become fully saturated may cause permanent damage to the wick when it is lighted.

1. Turn the wick adjuster knob clockwise until it stops. This raises the wick to its maximum height. As the wick rises within the heater, the wick adjuster knob turns with some resistance and makes a sound like the winding of a clock. Once the wick has reached its proper height, the automatic extinguisher is fully engaged. The wick adjuster knob will now move freely left or right to adjust the flame.

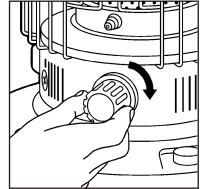

2. AUTOMATIC LIGHTING

Push the igniter lever gently to the right and down. (If you push violently the igniter lever you may cause the heat chamber to be improperly seated.) The igniter coil should glow and touch the wick. When flame appears, release the igniter lever.

NOTE: If you have difficulty igniting wick, let up on the igniter lever very slightly to remove the igniter coil from direct contact with the wick.

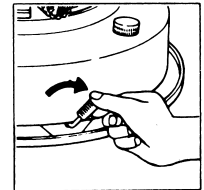

3. LIGHTING WITH A MATCH

You should not have to light the heater with a match, but should it become necessary, push the igniter lever and touch the match to the top of the wick. Do not allow burned parts of the match to fall or remain on the wick.

NOTE: To restore the automatic igniter system to proper operation, replace worn-out batteries; or if the igniter coil is defective, replace it.

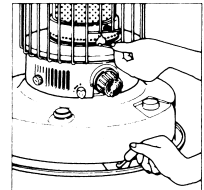

4. Be sure that heat chamber is properly seated by moving the wire heat chamber handle left and right.

NOTE: An improperly seated heat chamber can cause high flame, smoke, and potential damage to the heater itself. Proper seating of the heat chamber is essential for good performance. Do not leave the heater until you have determined that the flame is burning normally, as described in the following section.

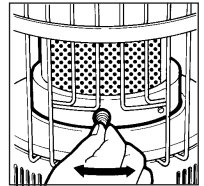

ADJUSTING THE FLAME

1. After lighting, wait for the heat chamber to reach operating temperature. This will take ten-fifteen minutes, after which the flame will be visible through the glass cylinder.
2. CHECK THE FLAME LENGTH
Look at the flame and check its length. Flame length is not necessarily even or uniform around the circumference of the center disk. Some areas may be lower than others, but on maximum wick height, flame length should average between 10 mm to 29 mm.

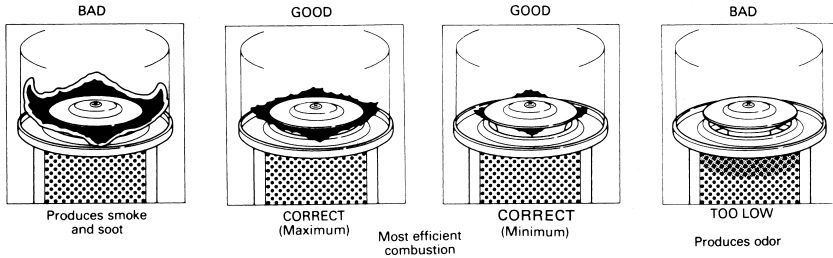

If necessary, raise or lower the wick by turning the wick adjuster knob to produce the proper flame condition.

NOTE: Do not operate your heater with wick set TOO LOW or TOO HIGH. Doing so will decrease combustion efficiency and increase production of unwanted emissions. When operating heater, be sure wick is high enough to keep the primary heat chamber heated to a uniform red glow from top to bottom.

NOTE: The wick-stop serves an important purpose. The wick-stop indicates the lowest level at which the wick should be used. Use of the wick below this wick-stop setting will cause less efficient combustion, possible smoke and odor, and should be avoided. **DO NOT OPERATE THE HEATER UNDER ANY CIRCUMSTANCES WITH THE WICK ADJUSTER KNOB TURNED BELOW THE WICK-STOP POSITION.**

NOTE: Always observe the heater closely for the first 15-20 minutes after it is lighted to be sure it is properly adjusted.

3. ADJUSTMENT OF WICK HEIGHT WITH WICK LIFE EXTENDER

Normal use of the wick and heat chamber over a period of time may make it impossible to achieve a satisfactorily high flame level. Usually this occurs because the wick develops deposits on it that retard fuel flow and evaporation. When this happens, the wick should be cleaned by "burning dry" as described in item 2, page 11 "INSPECTION OF THE WICK".

When the "burning dry" cleaning procedure is no longer effective in restoring proper flame height, adjust the wick life extender mechanism to the next higher position.

NOTE: Do not move the wick life extender to a higher position unless the wick has been cleaned by "burning dry".

To adjust the wick height rising the wick life extender, first release the automatic extinguisher by pushing down on the **MANUAL SHUTOFF**.

Then pull the wick adjuster knob from its shaft by pulling outward.

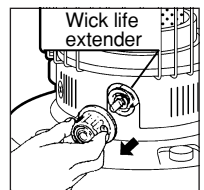
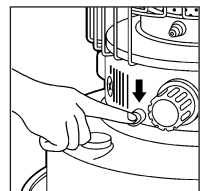

When the wick adjuster knob is removed, the wick life extender control can be seen to contain 3 sequential holes marked ①, ② and ③. By pulling out and turning the control dial counterclockwise, the stem pin of the adjuster can be moved from ① to ② and to ③ position as required. Each step upward from a lower to a higher number increases the maximum wick adjustment range by 2 mm (approx. 1/13 in.).

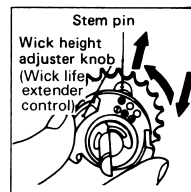

After the wick life extender's dial has been set, be sure the MANUAL SHUTOFF knob is in the "OFF" position. Replace the wick adjuster knob, making sure it is engaged securely on the wick adjuster shaft.

Repeat steps 1 through 3, as needed, in the section titled "ADJUSTING THE FLAME". When suitable flame length can no longer be achieved even on pin position ③, the wick should be replaced.

NOTE: Do not move adjuster to higher position until lower position no longer gives adequate flame length, even after "burning dry".

Before replacing wick, be sure to move the wick life extender dial back to its ① position.

AFTER REPLACING THE WICK, CHECK THE OPERATION OF THE AUTOMATIC EXTINGUISHER BEFORE LIGHTING YOUR HEATER.

EXTINGUISHING THE FLAME

1. Turn the wick adjuster knob counterclockwise until it stops (about 1/8 turn). Push the button on the wick adjuster knob and continue turning counterclockwise until it stops again (about a half turn). Within a few moments, the flame will be completely extinguished and the heater will be off.
2. Make sure the flame is out completely.
3. Do not try to relight the heater for at least three (3) minutes after turning it off, as this may cause smoke and odor.

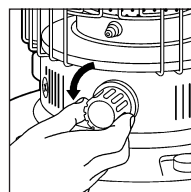

MANUAL SHUTOFF

When quick shutoff is necessary, push down on the manual shutoff.

NOTE: For routine turn-off, DO NOT use the "Manual Shutoff" or activate the "Automatic Extinguisher" by jarring the heater. These methods may cause unwanted odor, soot and smoke. Only the wick adjuster knob should be used for normal shutoff.

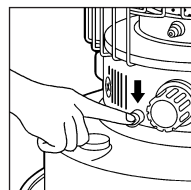

CARE AND MAINTENANCE

As with any good appliance, preventive as well as corrective maintenance is occasionally required. Please read the following section carefully in order to enjoy the greatest benefits from your heater.

INSPECTION OF THE WICK

NOTE: One of the simplest but also the most important components of your heater is the wick. With proper attention, the wick will last at least one heating season and, depending on the quality of the fuel used, possibly longer. It helps to perform routine maintenance operations on the wick.

1. Indications that the wick may need attention are:

- low flame
- tar deposit on the top edge of the wick
- difficulty in turning the wick adjuster knob
- a flickering or dying flame

2. Clean the wick by burning dry as follows:

1) When the fuel gauge indicates empty, but the heater is still burning, raise the wick to its highest position and allow the flame to consume the remaining fuel in the tank.

NOTE: Burning the wick dry can at times create odors. For the burning dry procedure, remove your heater from the living area of your house into a well-ventilated area such as a garage or even a sheltered area outside. If you burn the wick dry outside, be sure that the heater is not exposed to strong drafts during the procedure.

2) After the heater has cooled completely, remove the heater cover as described in items 1 and 2 of the next section.

3) Remove any residue from the wick with a small brush such as an old toothbrush. Cinders or soot in the burner around the wick may be vacuumed away. Be careful when removing such material from the wick with a brush, to do so gently so as not to tear the top surface of the wick.

4) Remove any tar deposits on the top of wick adjuster and primary air tube using a scraper.

NOTE: When good wick performance is no longer achieved by the burning dry process, it may be necessary to replace the burned wick with a new one.

5) Before reassembling the heater, take a few minutes to wipe the parts with a soft cotton cloth or paper towels.

6) Reassemble the heater, following directions in item 11 of the next section.

NOTE: If the flame is still low after cleaning the wick, the wick may contain some water. It is then necessary to replace the wick and empty all kerosene from the fuel tank. Dry the tank thoroughly and refill with fresh, pure No. 1-K kerosene.

INSPECTION OF THE IGNITER COIL

If the wick does not ignite or is hard to ignite, check if the igniter filament is broken.

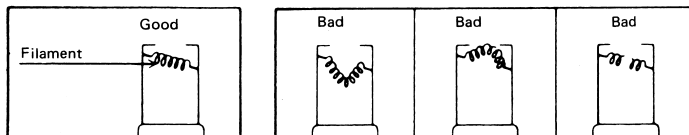

If the igniter coil is found to be defective, replace as described on page 14.

REPLACEMENT OF PARTS

REPLACING THE WICK

USE ONLY GENUINE TOYOTOMI REPLACEMENT WICK. SUBSTITUTE WICKS CAN SEVERELY REDUCE PERFORMANCE AND SAFETY.

WARNING: Before disassembling your heater, allow it to cool completely.

1. Release the automatic extinguisher by pushing down on the manual shutoff.

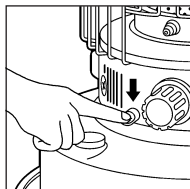

2. Remove the three (3) screws holding the heater cover, and lift cover off.
Remove batteries from the battery holder.

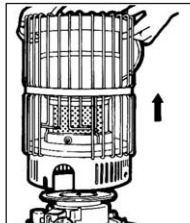
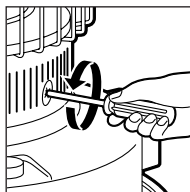

3. Remove the four (4) wing nuts around the wick adjuster. Lift the wick adjuster off the heater while moving it slightly back and forth.

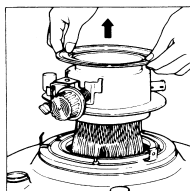

4. Slide two fingers between the orange band on the wick and the silver wick sleeve attached to the wick adjuster. Lift the pins in the wick off the slots in the wick sleeve. After lifting all three (3) pins off the slots, fold the wick and remove it. Leave the wick sleeve in place.

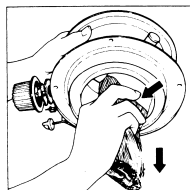

5. Place the wick adjuster on its side. Next, line up the three (3) openings in the wick adjuster: 1) the holes in the sleeve, 2) the diagonal slots in the fixed part of the wick adjuster, and 3) the slots in the moving part of the wick adjuster controlled by the wick adjuster knob.

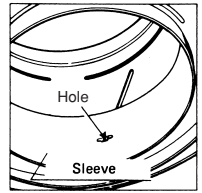

6. Fold the new wick in quarters and insert it into the wick adjuster from wick adjuster bottom. Place one of the pins in one of the lined-up openings. If you experience difficulty, gently turn the wick adjuster knob clockwise. Then insert the two other pins, turning the wick adjuster knob if necessary. Do not bend the sleeve.

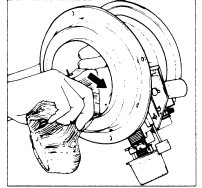

7. Finally, gently press the wick, all along its circumference, against the adjuster to insure that it is firmly in place.

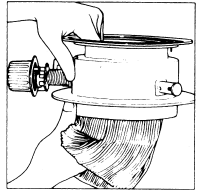

8. Lower the wick adjuster into the fuel tank, guiding the tail of the wick so it fits over the primary air tube and evenly into place.

Point the wick adjuster knob to the front of the heater. Insure that the wick adjuster is centered over the studs on the fuel tank.

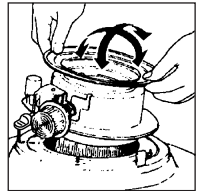

NOTE: The space between the wick adjuster and the primary air tube should be even all around.

NOTE: Make certain the top of the wick adjuster and the top of primary air tube are the same height. If they are uneven, the flames tend to be uneven, too.

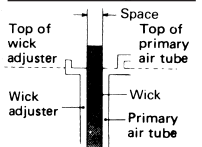

9. Tighten the four (4) wing nuts around the wick adjuster.

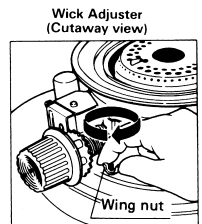

10. Turn the wick adjuster knob to be sure the wick moves smoothly up and down.

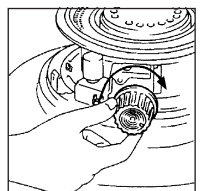

AFTER REPLACING THE WICK, CHECK THE OPERATION OF THE AUTOMATIC EXTINGUISHER.

Wick height on position ① of the wick life extender should be 8 mm (5/16 in.) when wick adjuster knob is turned fully clockwise. Be sure to check.

NOTE: Remember always to start a new wick on position ① of the wick life extender.

NOTE: If wick does not move smoothly and easily, or wick height on position ① of the wick life extender is not in the range of 7-8 mm (9/32-5/16 in.), do not use heater. Disassemble and repeat items 5 through 10.

NOTE: If any ragged edges appear on the top of the wick, trim them with a scissors carefully. DO NOT cut the body of the wick.

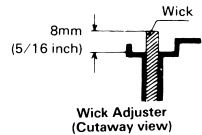
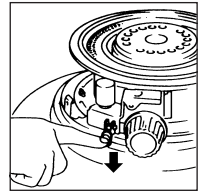

11. Replace the heater cover on the fuel tank and secure it into position with three (3) screws. Replace batteries in the battery holder.

12. Once again, check the proper operation of the automatic extinguisher.

NOTE: Before lighting a new wick for the first time, turn the wick to its lowest position and allow the wick to saturate with kerosene for about thirty (30) minutes.

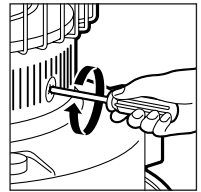

REPLACING THE IGNITER COIL

USE ONLY GENUINE TOYOSTOVE REPLACEMENT IGNITER COIL. SUBSTITUTE IGNITER COILS CAN SEVERELY REDUCE PERFORMANCE AND SAFETY.

WARNING: Before replacing the igniter coil, allow the heater to cool completely.

1. REPLACE BATTERIES

When the igniter coil no longer glows sufficiently to light the wick, replace the batteries. If proper glow is not restored, the igniter coil may be defective.

2. CHANGE IGNITER COIL

- Remove the batteries from the battery holder.
- Disassemble the heater as described in items 1 and 2 of the preceding section.
- Remove the small spring clip on top of the igniter cover and lift the cover out of the way.

d) Push the igniter lever to raise the igniter coil into view.

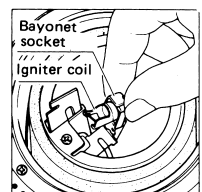
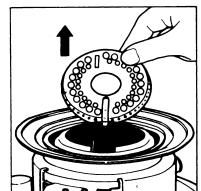

- e) To remove the igniter coil, push it in and twist in either direction while holding the sides of the socket with your other hand. Install the new igniter coil by pressing it into the socket and turning.

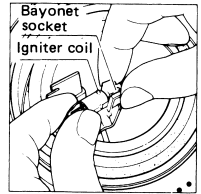

- f) Replace the igniter cover and small spring clip. Reassemble the heater as described in item 11 of the preceding section.

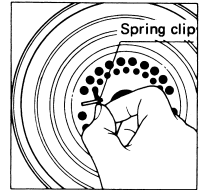

STORAGE

At the end of each heating season, or when you do not plan to use your heater for an extended period of time, the following procedures are recommended:

1. CLEAN WICK AND HEATER

Follow directions in item 2 under "INSPECTION OF THE WICK".

2. DRAIN FUEL TANK

After you have burned your heater dry, a small amount of kerosene will remain in the fuel tank. It should be removed in order to avoid contamination when the heater is refueled at a later date. To do this, remove the fuel cap, tip the heater toward you and insert a small syringe into the bottom-most portion of the fuel tank. Empty the tank completely before storing.

3. REMOVE BATTERIES FROM BATTERY HOLDER

4. STORE HEATER

The original shipping carton is the best place to store your heater. If you do not have original packing materials, cover the heater with a large plastic bag and store in a dry place.

TROUBLESHOOTING

PROBLEM	CAUSE	SOLUTION	PAGE
Wick fails to ignite	Out of fuel	Check fuel gauge; add fuel if necessary.	7
	Igniter coil does not glow	Check wire connections. Replace batteries. Replace igniter coil, if necessary.	6 11, 14
	Water in kerosene/poor quality kerosene	Drain tank. Install new wick. Refill with fresh, clean No. 1-K kerosene.	12
Smoke or odor	Heat chamber tilted or improperly seated	Move wire handle until heat chamber is properly seated and moves smoothly left and right.	8
	Wick set too high	Reduce wick height by turning wick adjuster knob counterclockwise. Check position of the wick life extender.	9
	Dirty wick	Clean wick as described under "Care and Maintenance".	11
	Drafts	Relocate heater.	2
	Contaminated fuel/poor quality kerosene	Drain tank and rinse with clean kerosene. Install new wick and refill with fresh, clean No. 1-K kerosene.	11 12
Flickering, dying or low flame	Dirty wick	Clean wick as described under "Care and Maintenance". If necessary, install new wick.	11 12
	Water in kerosene/poor quality kerosene	Drain tank and rinse with clean kerosene. Install new wick and refill with fresh, clean No. 1-K kerosene.	11 12
	Wick too low to sustain good flame	Raise the wick life extender to step 2 or 3. If already at step 3, replace wick.	9 12
Wick adjuster knob is hard to turn	Dirty wick	Clean wick as described under "Care and Maintenance".	11
	Poor quality kerosene	Drain tank and rinse with clean kerosene. Install new wick and refill with fresh, clean No. 1-K kerosene.	11 12
	Damaged mechanism	Contact your dealer for service.	
Flame too high	Fuel contaminated with gasoline or other highly flammable material	IMMEDIATELY shut off heater. Inspect all components for damage. Drain tank and rinse with clean kerosene. Install new wick and refill tank with fresh, clean No. 1-K kerosene.	3 11 12
	Wick set too high	Check position of the wick life extender.	9

TOYOTOMI CO., LTD.

5-17, Momozono-cho, Mizuho-ku, Nagoya, 467-0855 Japan