

Intellectual Property

All Intellectual Property, as defined below, owned by or which is otherwise the property of Samsung or its respective suppliers relating to the SAMSUNG Phone, including but not limited to, accessories, parts, or software relating there to (the "Phone System"), is proprietary to Samsung and protected under federal laws, state laws, and international treaty provisions. Intellectual Property includes, but is not limited to, inventions (patentable or unpatentable), patents, trade secrets, copyrights, software, computer programs, and related documentation and other works of authorship. You may not infringe or otherwise violate the rights secured by the Intellectual Property. Moreover, you agree that you will not (and will not attempt to) modify, prepare derivative works of, reverse engineer, decompile, disassemble, or otherwise attempt to create source code from the software. No title to or ownership in the Intellectual Property is transferred to you. All applicable rights of the Intellectual Property shall remain with SAMSUNG and its suppliers.

Samsung Telecommunications America (STA), LLC

Headquarters: Customer Care Center:

1301 E. Lookout Drive 1000 Klein St.

Richardson, TX 75082 Plano, TX 75074

Toll Free Tel: 1.888.987.HELP (4357)

Internet Address: <http://www.samsungusa.com>

©2007 Samsung Telecommunications America, LLC is a registered trademark of Samsung Electronics America, Inc. and its related entities.

Do you have questions about your Samsung Mobile Phone?

For 24 hour information and assistance, we offer a new FAQ/ARS System (Automated Response System) at:

www.samsungwireless.com/support

GH68-16013A

Printed in Korea

Licensed by Qualcomm Incorporated under one or more of the following patents:
U.S.

Patent No. 4, 901, 307; 5, 056, 109; 5, 099, 204; 5, 101, 501; 5, 103, 459; 5, 107, 225; 5, 109, 390.

Openwave® is a registered Trademark of Openwave, Inc.

RSA® is a registered Trademark RSA Security, Inc.

Disclaimer of Warranties; Exclusion of Liability

EXCEPT AS SET FORTH IN THE EXPRESS WARRANTY CONTAINED ON THE WARRANTY PAGE ENCLOSED WITH THE PRODUCT, THE PURCHASER TAKES THE PRODUCT "AS IS", AND SAMSUNG MAKES NO EXPRESS OR IMPLIED WARRANTY OF ANY KIND WHATSOEVER WITH RESPECT TO THE PRODUCT, INCLUDING BUT NOT LIMITED TO THE MERCHANTABILITY OF THE PRODUCT OR ITS FITNESS FOR ANY PARTICULAR PURPOSE OR USE; THE DESIGN, CONDITION OR QUALITY OF THE PRODUCT; THE PERFORMANCE OF THE PRODUCT; THE WORKMANSHIP OF THE PRODUCT OR THE COMPONENTS CONTAINED THEREIN; OR COMPLIANCE OF THE PRODUCT WITH THE REQUIREMENTS OF ANY LAW, RULE, SPECIFICATION OR CONTRACT PERTAINING THERETO. NOTHING CONTAINED IN THE INSTRUCTION MANUAL SHALL BE CONSTRUED TO CREATE AN EXPRESS OR IMPLIED WARRANTY OF ANY KIND WHATSOEVER WITH RESPECT TO THE PRODUCT. IN ADDITION, SAMSUNG SHALL NOT BE LIABLE FOR ANY DAMAGES OF ANY KIND RESULTING FROM THE PURCHASE OR USE OF THE PRODUCT OR ARISING FROM THE BREACH OF THE EXPRESS WARRANTY, INCLUDING INCIDENTAL, SPECIAL OR CONSEQUENTIAL DAMAGES, OR LOSS OF ANTICIPATED PROFITS OR BENEFITS.

Table of Contents

Section 1: Getting Started	4
Understanding this User Manual	4
Notes and Tips	4
Turning Your Phone On and Off	5
Setting Up Voicemail	5
Section 2: Understanding Your Phone	7
Features of Your Phone	7
Views of Your Phone	8
Command Keys	13
Navigation Wheel	14
Understanding the Main Screen	16
Battery	19
Phone Memory	25
Section 3: Call Functions	26
Making a Call	26
Answering a Call	27
Call In-progress Options	28
Recent Calls	29
Roaming	32
TTY	33
Voice Commands	34
Section 4: Menu Navigation	43
Menu Navigation	43
Navigation Wheel Shortcuts	44
Menu Outline	44
Section 5: Entering Text	50
Changing the Text Entry Mode	50
Entering Text Using Word Mode	51
Entering Characters in Abc Mode	52
Switching to Upper and Lower Case	52
Entering Symbols	52
Entering Numbers	53
Section 6: Understanding Your Contacts	54
Opening Contacts Menu	54
Contacts Icons	55
Adding a Contact	56
Adding Pauses	59
Contact Groups	60
Finding a Contacts Entry	63
Editing an Existing Contact Entry	63
Deleting a Contact Entry	64

Speed Dialing	64
Emergency Contacts and Your In Case of Emergency List	65
My Name Card	66
Section 7: Messaging	68
Types of Messages	68
Retrieving New Messages	68
Creating and Sending TXT Messages	72
Creating and Sending Picture Messages	73
Message Folders	75
Changing Message Settings	80
Voicemail	81
Mobile IM	81
Section 8: Changing Your Settings	82
Tools	82
Bluetooth Menu	83
Sounds Settings	86
Display Settings	88
Phone Settings	92
Call Settings	101
Memory	104
Phone Info	104
Section 9: Music	105
My Music	105
Music Player	107
Music Player Options	110
Playlist	111
Deleting Songs from the Music Player	113
Section 10: Get It Now	115
Get It Now	115
Tunes & Tones	116
Pictures	117
Games	120
Tools on the Go	120
Extras	121
Section 11: Tools	122
Voice Commands	122
Calculator	122
Calendar	124
Alarm Clock	126
Stop Watch	128
World Clock	129
Notepad	129

Section 12: Health and Safety Information	131
Health and Safety Information	131
Samsung Mobile Products and Recycling	133
UL Certified Travel Adapter	133
Consumer Information on Wireless Phones	133
Road Safety	140
Responsible Listening	141
Operating Environment	143
Using Your Phone Near Other Electronic Devices	143
Potentially Explosive Environments	145
Emergency Calls	145
FCC Notice and Cautions	146
Other Important Safety Information	146
Product Performance	147
Availability of Various Features/Ring Tones	148
Battery Standby and Talk Time	148
Battery Precautions	148
Care and Maintenance	150
Section 13: Warranty Information	151
Standard Limited Warranty	151
Index	156

Section 1: Getting Started

Topics Covered

- Understanding this User Manual
 - Notes and Tips
 - Turning Your Phone On and Off
 - Setting Up Voicemail
-

This section allows you to start using your phone by activating your service, setting up your voicemail, contacting customer support, or getting an understanding of how this manual is put together.

Understanding this User Manual

The chapters of this manual generally follow the same order as the menus and sub-menus in your phone. A robust index for quick reference to most features begins on page 156.

Also included is important safety information that you should know before using your phone. Most of this information is near the back of the manual, beginning on page 131.

Notes and Tips

Throughout this manual are icons and text that are set apart from the rest. These are intended to point out important information, quick methods for activating features, to define terms, and more. The definitions for these methods are as follows:

- **Notes:** Explain alternative options within the current feature, menu, or sub-menu.
- **Tips:** Provide quick or innovative methods for performing functions related to the subject at hand.
- **Important:** Points out important information about the current feature that could affect performance, or even damage your phone.

Turning Your Phone On and Off

Turning Your Phone On

1. Open the swivel, then press .

Note: As with any other radio-transmitting device, do not touch the internal antenna as it affects call quality and may cause the phone to operate at a higher power level than is necessary. The internal antenna is located along the top on the back side of your phone.

2. Once the phone finds a signal, the time, date, and day appear in the display.
3. You're now ready to place and receive calls.

Note: If the phone is outside the Verizon Wireless coverage area the roaming icon ▲ appears in the top of the display.

Turn Your Phone Off







- ▶ Press  for two or more seconds. Your phone powers off.

Setting Up Voicemail

Voicemail allows callers to leave voice messages, which can be retrieved any time.

Note: Once your voicemail account has been set up, you can use the Voicemail selection 5 (under the Messaging menu) to view details of voice messages in your voicemail box.

Voicemail Setup

1. Press and hold  or press     or dial your wireless phone number from any touch-tone phone.
2. When the recorded announcement begins, press  to interrupt (if applicable)
3. An easy-to-follow setup tutorial will begin. Follow the instructions to set up your new password and record a greeting.

Listen to Voicemail

1. Press and hold  or press     or dial your wireless phone number from any touch-tone phone.
2. You are then prompted to enter your password followed by  key.
3. Follow the recorded prompts to listen to messages, change administrative options, and so on.

Note: Airtime and long distance charges apply, IN Calling minutes do not apply to Voicemail setup or retrievals.

Section 2: Understanding Your Phone

Topics Covered

- Features of Your Phone
 - Views of Your Phone
 - Command Keys
 - Understanding the Main Screen
 - Battery
 - Phone Memory
-

This section outlines key features of your phone. It also displays the screen and the icons that are displayed when the phone is in use.

Features of Your Phone

- Domestic and international voice and text messaging service (available on participating networks).
- Global Positioning (GPS) Technology for VZ NavigatorSM and ChaperoneSM
- Personal Organizer (Calculator, Calendar, Alarm Clock, World Clock, Stop Watch, and Notepad)
- Messaging Services (Standard TXT Messaging, Picture Messaging, and Mobile Instant Messenger)
- Messaging Font Size selection
- VGA Camera with Night Shot mode
- Advanced Speech Recognition
- Speakerphone
- Music Player
- Bluetooth[®] Wireless Technology **

Note: The Juke supports the following Bluetooth profiles: A2DP, Headset, Handsfree, Serial Port, Object Push for vCard, and Phonebook Access. The Juke does not support all Bluetooth OBEX profiles. Go to www.verizonwireless.com/bluetoothchart to check car kit and accessory compatibility.

Views of Your Phone

The following illustrations show the main elements of your phone:

How to Open and Close

While holding the closed phone with the Navigation wheel at the top, gently rotate the top of the phone clockwise, revealing the keypad.



Closed position.



Rotate the Juke so that the Navigation Wheel is on the top.



Rotate clockwise to open.



Rotate counter clockwise to close.

Open View



*Screen images simulated

Features

1. **Earpiece:** The earpiece allows you to hear the other caller.
2. **Navigation Wheel:** This key allows you to scroll through the phone menu options. In the music player, you can rotate left or right to scroll through songs.

3. **Camera Key:** This key allows you to activate the camera.
4. **Left Soft Key:** This key is used to navigate through menus and applications by selecting the choice indicated on the lower left area of the display screen.
5. **Send Key:** Allows you to place or receive a call. Press the key once from the main screen to access the recent call log.
6. **Voicemail Key:** Press and hold to dial Voicemail number.
7. **Alpha-numeric Keys:** Use these keys to enter numbers, letters, and characters
8. **Speakerphone Key:** During a call, press and hold to activate the speakerphone.
9. **Microphone:** The Microphone allows the other caller to hear you clearly when you are speaking to them.
10. **Voice Commands Key:** Press and hold to activate VoiceSignal®.
11. **Right Special Function Key:** Press and hold to activate/deactivate Vibrate mode. Also press to enter special characters and perform various functions.
12. **Clear Key:** Deletes characters from the display when you are in text entry mode. Press to return to the previous menu or screen when navigating features on your phone.
13. **End/Power Key:** Ends a call. If you press and hold the END key, the power goes On or Off. When you receive an incoming call, mute the ringer and redirect the call to voicemail.
14. **Right Soft Key:** This key is used to navigate through menus and applications by selecting the choice indicated on the lower right area of the display screen.
15. **Center Select Key:** Pressing when navigating through a menu accepts the highlighted choice in a menu.
16. **Display:** Displays all the information needed to operate your phone. The display shows signal and battery strength, incoming calls, messages, time, day, and date.

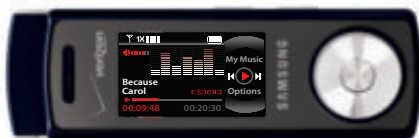

Closed View



Features



1. **Headset Jack:** Allows you to plug in an optional headset for safe, convenient conversations.
2. **Power/Accessory Connector:** The power/accessory interface connector is used to plug in the charging accessories and also connect any available accessory cables to your phone.
3. **Lock Key:** Locks the external keys when handset is closed and the lock key is in locked position (with red showing).
4. **Camera Lens:** The lens of your built-in camera.
5. **Volume Key:** Allows you to adjust the master volume (with the swivel open) or adjust the voice volume during a call. To mute the ringer during an incoming call, press the volume key up or down. When the swivel is closed, press and hold the volume key, to activate the sub LCD backlight. With the swivel open, press and hold the volume down key to activate Sound Off mode/Normal mode.

Command Keys

Functions for the soft keys are defined by what appears above each in the display. There are two soft keys, the **left** soft key () and the **right** soft key ().



Left Soft Key

Some functions of the left soft key are as follows.



- Press the **Message** (left) soft key  to open the Message menu.
- When the left soft key function is **Settings**, press the **Settings** (left) soft key  to view settings for the feature.
- When the left soft key function is **Edit**, press the **Edit** (left) soft key  to edit a Contact or Profile setting.





Right Soft Key

Some functions of the right soft key are as follows.

- Press the (right) soft key  **Contacts** to open your Contacts list.
- When the right soft key function is **Options**, press the **Options** (right) soft key  to view more options for the current menu.





Clear Key

The **CLR** key () is used to erase or clear numbers, text, or symbols from the display. You can also use  to return to a previous menu or to return to the main screen from any menu.

- If you enter an incorrect character, press  to backspace (and delete) the character.
- To erase the previous word in a sentence, press and hold .
- To back up one menu level, press .
- To return to the main screen, press and hold .







End/Power Key

The **End/Power** key () is used to end a call, to turn your phone on/off, to return to the main screen from any menu or cancel the last input.

- Press and hold  to turn your phone off.
- Press  to turn your phone on.
- Press  to disconnect a call.
- Press  to return to the main screen from any menu, or to cancel the last input.

Send Key

The **Send** key () is used to answer calls, dial calls, and to recall the last number(s) dialed, received, or missed.



- Press  to answer calls.
- Enter a number and press  to make a call.
- Press  from the main to display a list of recent calls to and from your phone.
- Press  twice from the main to call the most recently dialed, received, or missed number.
- Press  to pick up a waiting call. Press  again to switch back to the other call.

Navigation Wheel

The Navigation wheel can be used to scroll through menu items. A highlighted menu item may be selected by pressing the **Center Select** key ().

Using the Navigation Wheel

Rotating or pressing the Navigation wheel in any direction allows you to scroll or move through menus, sub-menus and options, all instructions in the User Manual refers to this action as “Use the Navigation wheel.”

1. Use a circular motion to scroll through available onscreen options.
2. Use the Navigation wheel () to scroll **up** or **down** through a list.
3. Press the direction point (top, bottom, left or right) of the Navigation wheel () to navigate through menus, sub-menus and options when using the phone feature.

Scrolling Down

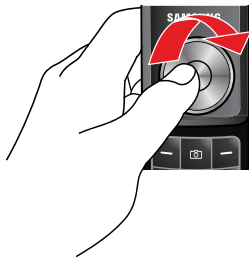



Scrolling Up



Opened Phone

Use the Navigation wheel to browse menus, sub-menus, and lists. Each navigation direction point (up, down, left, right) acts as a shortcut from the main screen to quickly access applications or menu items.

Camera Key

1. With the swivel open, press the **Camera** key () to activate the camera.
2. While in camera mode press the **Camera** key () or the **Center Select** key () to take a photo.

Speakerphone Key

With the swivel open, press and hold the **Speakerphone** key () to switch from using the earpiece to the speakerphone before or during a call. Use the volume keys (located on the left side of your phone) to adjust the volume. Press and hold the speakerphone key to disable the speakerphone option (switch back to using the earpiece) during a call.

Note: With the swivel open or closed, after a call has ended the speakerphone function turns off automatically.

Note: For safety information related to speakerphone use, see "*Responsible Listening*" on page 141.

Understanding the Main Screen

With swivel open, the main screen display icons that indicate network status, battery power, signal strength, connection type and more. ➔





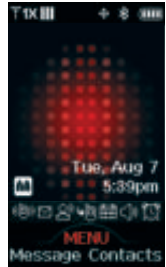







Note: With the swivel open, the main screen will appear like the illustration to the right. This is the default wallpaper and can be changed. For more information, refer to "Wallpaper" on page 90.



The service indicator display line of the main screen (above the word MENU) shows icons that indicate feature and function status. ➔









Display icons

- T 1X III** **1X Signal Strength:** Indicates your phone is using the CDMA 1X protocol. Appears when your phone is on and indicates the current signal strength. More bars indicate a stronger signal.
- T D III** **D Signal Strength:** Always appears when your phone is on and indicates the current signal strength. More bars indicate a stronger signal.
- Off** **Standalone Mode:** Appears when Standalone Mode is on. When on, all RF functions for your phone are disabled, and you cannot use your phone to place or receive calls.
- ▲** **Roaming:** Your phone is outside your home area. While roaming, another wireless provider may be handling your call. The service rate for the call may be higher than those made from within your home area. Please refer to Verizon Wireless for roaming rates.
- S** **SSL:** Indicates the secure socket layer is actively transmits your communications over the internet in an encrypted format.
- P** **Voice Privacy:** Prevents eavesdropping over a CDMA traffic channel.

-  **Phone Lock:** Prevents external keys from being used when phone is closed.
-  **No service:** Your phone cannot find a signal because you're outside a service area. You cannot make or receive calls. Wait for a signal or move to an open area to find a signal. This indicator always appears when you first turn on your phone and disappears once service is located.
-  **Voice Call:** Indicates a call in progress. When dialing a number, this icon flashes until the call connects.
-  **Data Call:** Indicates a data call in progress.
-  **Dormant:** Indicates no incoming or outgoing data.
-  **Location E911 Only:** Global Positioning Service (GPS) for 911 is set to On for emergency calls only. When GPS for 911 is set to On, the icon is displayed.
-  **Location On:** Global Positioning Service is set to On for location and 911 calls.
-  **Sync Music:** Indicates that music is being synchronized between your computer and your phone.
-  **Paused:** Indicates that music playback has been paused while phone is open and incoming call is received.
-  **Play:** Indicates that music is playing in the background while the phone is open.
-  **Battery Level:** More bars indicate a greater charge. When the battery is low, an empty battery icon flashes and the phone sounds an alert, which indicates your phone is about to shut down.
-  **TTY:** Indicates that TTY is enabled.
-  **Bluetooth On:** Indicates that Bluetooth wireless technology is turned on.

-  **Bluetooth Active:** Indicates that Bluetooth wireless technology is connected to another device and receiving or pushing data.
-  **Bluetooth Connected:** Indicates Bluetooth wireless technology is turned on and is paired with another Bluetooth-enabled device.

Bottom Display Icons

-  **Missed Calls:** Your phone displays this icon when calls are missed.
-  **New Msgs:** You've received a new text, or page. You're also notified of a new message by animations and sound. You have one or more unread voicemail messages in your voicemail box. (Only applicable on Verizon Wireless Network.)
-  **Calendar Event:** Your phone displays this icon when you have a calendar appointment scheduled.
-  **Voicemail:** You've received a voicemail message, page or message.
-  **Alarm On:** Indicates that your phone has a set alarm.
-  **Auto Answer:** Automatic answer is enabled. Your phone automatically picks up calls after the designated time with your headset connected.
-  **All Sounds Off:** The ringer is silenced for all alerts, incoming calls, and incoming messages.
-  **Alarm Only:** Your phone will only ring when the set alarm sounds.
-  **Vibrate On:** Your phone vibrates upon receiving a call.
-  **Speakerphone:** Indicates the speakerphone is active.

Dialogue boxes

Dialogue boxes prompt for action, inform you of status, or warn of situations such as low memory. Dialogue boxes and their definitions are outlined below.

- **Choice**
 - Example: "SAVE MESSAGE?"
- **Reconfirm**
 - Example: "ERASE ALL MESSAGES?"
- **Performing**
 - Example: "Sending..." "Connecting..."
- **Completed**
 - Example: "MESSAGE SENT"
- **Information**
 - Example: "New Message"
- **Error**
 - Example: "System Error!"
- **Warning**
 - Example: "BATTERY LOW," "MEMORY FULL"

Battery

Note: This phone comes packaged with a partially charged, rechargeable standard Li-Ion battery, and travel charger.

Important! Although the phone can be used while the battery is charging, the battery must be fully charged before first use, otherwise you could damage the battery.

Using A Non-Supported Battery

Samsung handsets do not support the use of a non-supported battery.

When using a non-supported battery you will hear a series of beeps and you will see a warning message that indicates “**NON SUPPORTED BATTERY SEE USER GUIDE**”. If you receive this warning, battery charging has been disabled.

Samsung charging accessories (i.e. travel adapter, and vehicle power adapter) will only charge a Samsung approved battery. To continue use of your handset press the **Center Select** key (●).

Note: When using a non-supported battery the handset can only be used for the duration of the life of the battery and cannot be recharged.

Important! Using a non-supported battery may cause damage to your phone. Use a Samsung supported battery only.

Install the Battery

1. Insert the top end of the battery into the phone housing with the label side down. The gold contacts on the end of the battery should match up with those on the phone.

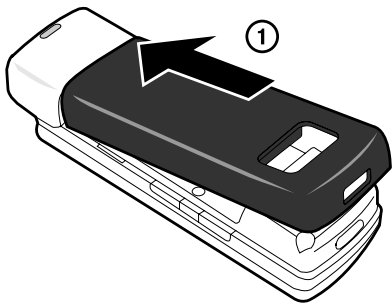

2. Push the bottom end of the battery down until it snaps securely into place over the battery release latch.

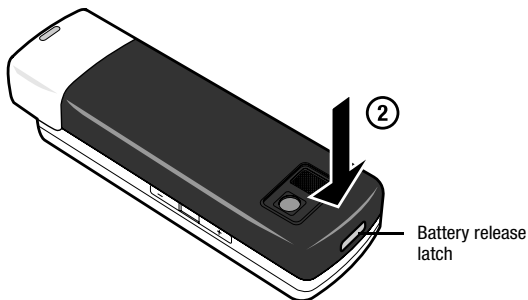

Remove the Battery

1. Press  to turn off the phone (if on).
2. Press the battery release latch at the bottom of the phone. The bottom of the battery should pop up.

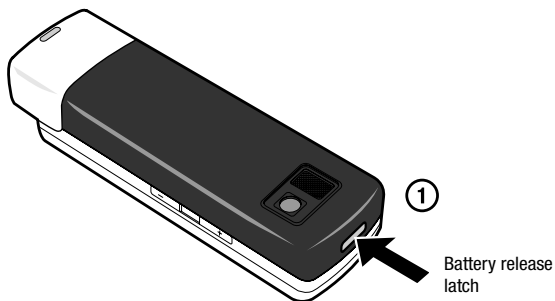

3. Use your finger to lift the battery (bottom end first) up and away from the phone.

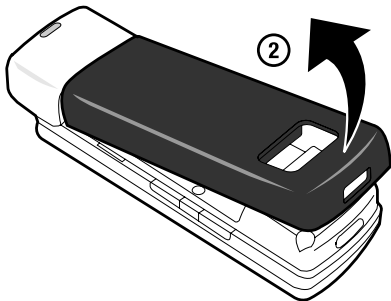

Charge the Battery

Your phone is powered by a rechargeable standard Li-ion battery. Only use Samsung-approved charging devices and batteries. Samsung accessories are designed to maximize battery life. Using other accessories may invalidate your warranty and may cause damage.

Travel Charger

The travel charger is a convenient, light-weight charger that rapidly charges your phone from any 120/ 220 VAC outlet.

1. Plug the large end of the travel charger into a standard 120/220 VAC wall outlet.

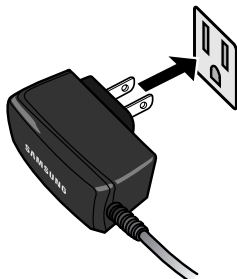

2. Slide the power/ accessory connector cover down.



Note: You can use your phone while charging, however, the battery charges faster if the phone is turned off.

3. Insert the smaller end of the travel charger into the charger/ accessory connector at the left side of the phone.





Note: The following illustration is the incorrect method for connecting the charger. If attempted, damage to the accessory port occurs therefore voiding the phone's warranty.



4. Plug the adapter into a standard AC wall outlet.
5. When you have completed the charging cycle, unplug the Travel Adapter from the power outlet and then disconnect it from the phone.



Battery Indicator

The battery indicator  in the upper-right corner of the display indicates battery power level. Four bars indicate a full charge, while an empty icon  indicates an almost empty battery. Two to three minutes before the battery becomes too low to operate, a blinking empty battery icon  appears and a tone sounds. If you continue to operate the phone without charging, it shuts down.

Phone Memory

The following file types can be saved to the phone memory:

Note: Up to 22MB of memory is available for storing the file types listed below and downloaded applications.

- **My Pictures:** Pictures you have saved from a Picture message, downloaded via the “Get It Now” application, or taken using your phone.
- **My Sounds:** Sounds recorded using your phone, or saved from a Picture message with sound attached.
- **My Ringtones:** Ringtones you have downloaded via the “Get It Now” application.

Music Memory

A separate storage space of up to 2GB* is available for storing music files (.mp3, .wma, wma pro, aac, and .aac+ format files) on your phone for playback using the Music Player.

*Actual formatted capacity is less.

Section 3: Call Functions

Topics Covered

- Making a Call
 - Answering a Call
 - Call In-progress Options
 - Recent Calls
 - Roaming
 - TTY
 - Voice Commands
-

This section describes how to make or answer a call with the phone open. It also includes the features and functionality associated with making or answering a call.

Making a Call

1. From the main screen, enter the number you want to call using the keypad.
2. Press .

Making Calls Using Contacts

Contacts are entries that you create to store names, numbers, and other information for people or groups of interest. If you've already entered information into your Contacts list, you can recall and dial the contact easily. For more information, refer to "Adding a Contact" on page 56.

1. From the main screen, press the right soft key  **Contacts**.
 2. Use the Navigation wheel to highlight the contact you want to call.
-

Tip: Use the **GoTo** field to quickly access a contacts name. Simply, press the keys associated with contacts name and the name(s) associated with keys pressed will appear in the display.



3. When the desired contact is highlighted, press the **Center Select** key  **VIEW**. Details for the contact appear in the display.

4. If the entry contains more than one number, use the Navigation wheel to highlight the desired number.
5. Press  to call the number.

Answering a Call



To answer a call by opening the phone's swivel, the Answer Option should be set to **Swivel Open**. This is the default option.

If the swivel is already open when the call is received:

- Press the  key to answer the call.
- Press the right soft key  **Ignore** to redirect the call immediately to voicemail.
- Press the left soft key  **Quiet** to silence the ringer.

To receive a call with the phone closed, the phone's Answer Option must be set to either: **Any Key** or **Auto w/ Handsfree**.

Note: Any Key only works as described when phone is open.

- **Any Key:** Calls are answered when any key is pressed except . If you press  it will ignore the call and send it to voicemail.
- **Auto w/ Handsfree:** Calls are answered automatically with a 5 second delay.



If the swivel is closed when the call is received, use your Navigation wheel to select one of the following options and then press the **Center Select** key ():

- **Quiet** to silence the ringer.
- **Ignore** to redirect the call immediately to voicemail.
- **Answer (Speaker)** to answer the incoming call. If the Auto w/Handsfree option is enabled, these incoming calls are automatically answered within 5 seconds.

Note: To change the answer options, see "Answer Options" on page 101.

Answering Call-Waiting Calls

When you receive a call while on a call:

- Press  and answer the new call and place your current call on hold or let the new call go to your voicemail.
- Press  to return to your original call when you finish with an incoming call.



Call In-progress Options

Access numerous menus and features while in a call.

Note: If the call is disconnected while accessing the Call In-progress Option, the Options menu disappears from the display and the phone eventually returns to the main screen.

1. While in a call, press the right soft key  **Options**. The following menu items appear in the display.
 - **Messaging:** Open the Messages menu.
 - **Contact List:** Open the contacts to view.
 - **Recent Calls:** Displays your recent incoming, missed and outgoing calls.
 - **Bluetooth Menu:** Displays the Bluetooth Menu so you can easily connect to a Bluetooth device while on a call.
 - **Audio To Phone/Device:** Allows you to switch the audio path from Device to Phone or Phone to Device using Bluetooth.
 - **Main Menu:** Opens the main menu.
 - **Notepad:** Allows you to type in and save a note while on a call.
 - **Voice Record:** Records the caller's conversation.
-

Note: Recording a call may require consent from the person being recorded. User should determine applicable law and take appropriate steps to comply.

- **Whisper Mode:** During a call, you can set Whisper Mode to ON to help the person receiving your call hear you better if you must speak softly. After the call ends, Whisper Mode will be reset to OFF.
2. Use the Navigation wheel to highlight a menu. Press the **Center Select** key () to open the highlighted menu or to activate the feature.
 3. Press the left soft key  **Mute/Unmute** to mute the call. Press again to unmute the call.

Recent Calls

When you place, miss, or receive a call, a record of the call is saved in Recent Calls, which is a listing of the different types of calls you either made or received. These types of calls are listed below.

- **Missed:** Displays any missed calls.
- **Received:** Displays any received calls that were answered.
- **Dialed:** Displays all outgoing calls made from your phone.
- **Blocked:** Displays blocked incoming and outgoing calls. The Blocked call log can only be accessed by entering the Phone Lock Code. The default Phone Lock Code is the last four digits of your telephone number. For more information, refer to "Restrict Calls" on page 96.

Note: The Blocked call log only displays if Call Restrictions are set to Contacts Only, or Block All.

- **All:** Displays all missed, received, and outgoing calls made from your phone.

Call History Icons

When you view Recent Calls, an icon to the left of the number indicates the type of call.



Indicates a Missed call







Indicates a Dialed call





Indicates a Received call

Viewing Call Information

Recent Calls retains information such as the duration, date and time, and whether the call was received, dialed, or missed.





1. From the main screen, press the  key or press the **Center Select** key () **MENU** then use the Navigation wheel to highlight **Recent Calls** () and press the **Center Select** key (). Use the Navigation wheel to highlight the call log category that contains the number you want to view and press the **Center Select** key (.
2. Use the Navigation wheel to highlight the desired number.

3. Once the desired number is highlighted, press the **Center Select** key ( **OPEN**).
4. The following options appear in the display:
 - **Call Type:** The title bar displays if the call is a missed, dialed, or received.
 - **Name:** If the caller is in your Contacts list, their name is listed here as well as the appropriate icon to indicate mobile, work, or home number. This information only appears if the caller is in your Contacts list.
 - **Number:** Displays the telephone number.
 - **Time:** The time of the call.
 - **Date:** The date of the call.
 - **Duration:** The duration of the calls made or received.
5. Press the right soft key ( **Options**) to display the following options:
 - **Details:** Shows details of the entry in your Contacts list associated with the phone number.
 - **Save:** Save the number to your Contacts list.













Note: If Save doesn't appear, that entry is already in your Contacts list.



- **Erase:** Delete the call from Call History.
 - **Lock/Unlock:** Locks or unlocks the entry to prevent accidental deletion.
 - **View Timers:** Select to view the call timers for your phone.
6. Use the Navigation wheel to highlight an option and press the **Center Select** key () to enter the highlighted option's sub-menu.



Making Calls Using Call History

1. From the main screen, press  then use the Navigation wheel to highlight desired number.
2. Press  to call the highlighted number. Or, you can press the **Center Select** key ( **OPEN**), then press  to call the highlighted number.

Creating or Updating Contacts Using Call History

1. From the main screen, press  then Use the Navigation wheel to scroll to highlight desired number.
2. Press the right soft key  **Options**.
3. **Save** is highlighted, press the **Center Select** key ().
4. Use the Navigation wheel to highlight **Add New Contact** or **Update Existing**. Press the **Center Select** key (). If you selected **Update Existing**, use the Navigation wheel to highlight the appropriate contact and press the **Center Select** key ().
5. Use the Navigation wheel to highlight one of the following options and press the **Center Select** key (). The number will be entered into that option:
 -  **Mobile 1**
 -  **Mobile 2**
 -  **Home**
 -  **Work**
 -  **Fax**
6. Enter a name for the entry using the keypad. Press the left soft key  **Abc** if you wish to select a different method of text entry, such as Word, Abc, ABC, 123, or Symbols.
7. To assign a Speed Dial location, use the Navigation wheel to highlight the phone number you would like to assign to a Speed Dial location and press the right soft key  **Options**.

Press  **Set Speed Dial** or press the **Center Select** key (.





Highlight an unassigned location and press the **Center Select** key (). **SET**. A confirmation message appears in the display, Yes is highlighted, press the **Center Select** key () to add Contact to the speed dial location.

Note: Voicemail is assigned to Speed Dial location 1.





You can assign a speed dial location to each phone number associated with the contact (Home, Work, Mobile 1, Mobile 2, and Fax).

8. When you're finished entering information for the entry, press the **Center Select** key (). **SAVE**. The entry is saved to your Contacts.

Delete Call History Entries

1. From the main screen, press  then use the Navigation wheel to highlight desired number.
2. Press the right soft key  **Options**. A pop-up menu appears in the display.
3. Use the Navigation wheel to highlight **Erase** and press the **Center Select** key (). Select **Yes** or **No** at the **ERASE ENTRY?** pop-up screen.
4. Press the **Center Select** key (.

Delete All Call History Entries

1. From the main screen, press .
2. Press the right soft key  **Options**. A pop-up menu appears in the display.
3. Use the Navigation wheel to highlight **Erase All** and press the **Center Select** key (). Select **Yes** or **No** at the **ERASE ALL ENTRIES?** pop-up screen.
4. Press the **Center Select** key (.

Roaming

What is Roaming?

Your phone can roam on other digital networks. Roaming occurs when you travel outside a pre-designated coverage area. The roaming icon displays when roaming is active and extra charges may apply when making or receiving calls.

Note: Some features may be unavailable while roaming.

Roaming Options



The following roaming options may appear in the display:

- **Home Only:** Your phone is available for normal operation only in the designated coverage area.
- **Automatic, Automatic A or Automatic B:** The preferred roaming list is used to acquire service. (At least one of these options may appear in the display)

Note: Contact your service provider for information regarding preferred systems.



Automatic settings are determined by the home location of the phone and the user's price plan.

To change your Roaming option, follow these steps:

1. From the main screen, press the **Center Select** key (○) **MENU**.
2. Use the Navigation wheel to highlight **Settings & Tools**  and then press the **Center Select** key (○).
3. Press  **Phone Settings**.
4. Press  **System Select**.
5. Use the Navigation wheel to choose a setting, and press the **Center Select** key (○).

TTY

Your phone is fully TTY compatible. Connect the TTY equipment to the headset jack, located on the right side of the phone. Before you can use your phone with a TTY device, you'll need to enable TTY functions in the phone.

1. From the main screen, press the **Center Select** key (○) **MENU**.
2. Use the Navigation wheel to highlight **Settings & Tools**  and then press the **Center Select** key (○).
3. Press  **Call Settings**.
4. Press  **TTY Mode**. The TTY Mode screen displays.
5. A warning appears in the display stating **"ENABLING TTY WILL DISABLE HEADSET AUDIO. CONTINUE?"**

Use the Navigation wheel to highlight **Yes** and press the **Center Select** key (○) to proceed to TTY MODE screen.

Use the Navigation wheel to highlight **No** and press the **Center Select** key (○) to return to **Call Settings** menu.

6. Use the Navigation wheel to select one of the following and press the **Center Select** key (○) to make your selection:
 - **TTY Full**
 - **TTY + Talk (VCO)**
 - **TTY + Hear (HCO)**
 - **TTY Off**
7. The **TTY MODE SET** screen displays.

Voice Commands









VoiceSignal™ is an advanced speech recognition software that can be used to activate voice commands for a wide variety of functions on your phone. VoiceSignal software automatically voice activates all contacts for voice dialing and finding contacts. No pre-recording or training is needed. Speak phone numbers naturally to dial, and use voice commands to navigate phone menus. Names should be spoken exactly as they are spelled in the contact list.

Voice Commands Settings

You can adjust the settings and preferences for Voice Commands by opening the Voice Commands menu. Using this menu, you can change the following Voice Command features:



- **Name Dialing:** You can place a call to any name and phone location in your contact list.
- **Menu Shortcuts:** You can use a single command to access certain menu items.

To access the Voice Commands settings menu, follow these steps:

1. From the Main screen, press the **Center Select** key () **MENU**.
2. Use the Navigation wheel to highlight **Settings & Tools**  and then press the **Center Select** key ().
3. Press  **Phone Settings**.
4. Press  **Voice Commands**.
5. Use the Navigation wheel to select the setting you want to change. The following options are available:
 - **Voice Dial:** Select from the following:
 - Voice Key Only: Initiate voice commands by pressing the  key.
 - Voice Key/EarMic: Initiate voice commands by pressing the  key, or by speaking into a headset.
 - Voice Key/Flip: Initiate voice commands by pressing the  key, or by opening the handset.
 - **Voice Settings:**
 - **Choice List:** If Voice Commands is not absolutely confident that it has correctly identified a name or number, it can display a choice list of up to three possibilities, and prompt you to confirm the correct one. You can control when choice lists appear by changing the Choice Lists setting to the following:
 - **Automatic:** Voice Commands displays a choice list when it is not confident it has identified the correct choice from among multiple alternatives.
 - **Always On:** When there are multiple alternatives, VoiceSignal always displays a choice list.

- **Always Off:** Voice Commands never displays a choice list. Instead, the application picks the best from among the possible choices.
- **Sensitivity:** In Voice Commands, sensitivity controls the balance between rejecting too much, which means the phone frequently does not recognize names, numbers, or commands, and rejecting too little, which means it frequently recognizes something even if nothing was said. When Voice Commands rejects an utterance, it displays a message such as “Please repeat. . .” or “No match found.” If you frequently experience these messages, you might be able to get better recognition by adjusting the Sensitivity setting toward Reject Less. If you frequently experience false activations (Voice Commands detects a wrong match), you might be able to get better performance by adjusting the Sensitivity setting toward Reject More.
- **Digit Dialing:** Use the dialing Digit Dialing menu to adapt digit dialing to your voice.
 - **Adapt Digits:** Lets you adapt digits, which can improve speech recognition of phone numbers. Adaptation takes about 180 seconds.
 - **Reset Digits:** Erases any digit adaptation you have done and resets digit recognition to the factory default. If you have not adapted digits, this option is grayed out.
- **Sound:** You can customize the VoiceSignal user interface by turning playback on or off for prompts, names, and numbers.
 - **Prompts:** Turns audio prompts playback (i.e. “Say a name or shortcut”) on or off.
 - **Digits:** Turns playback on or off for digits, for example, when confirming a phone number.
 - **Names:** Turns name playback on or off.
 - **Name Settings:** Adjusts the speed and volume of name playback.
 - **Speakerphone:** Plays the prompts through the speaker.
- **About:** Displays information about Voice Commands including version number, build number, and device model.
- **Digit Dial Readout:** Reads out the numbers pressed when dialing a phone number.
- **Call Alert:** Provides audible readout of the phone number and/or name (if in your contact list) of an incoming call.

You can also access the Voice Commands Settings menu by following these steps:

1. Press and hold the **Voice Commands** key ().
2. Press the right soft key  for **Settings**.
3. Use the Navigation wheel to select the setting you want to change.

Adapting Voice Commands

Voice dialing works well for most people without special adaptation. However, people with strong accents or unique voice characteristics may receive better results after adapting the system to match their voices.

You should adapt Digit Dial only if the system is frequently unable to recognize your speech. After you adapt Digit Dial, your phone is customized to your voice, and your voice only. Others will not be able to use it unless they reset the phone to factory defaults.











Adaptation involves recording several digit sequences to adapt the system to the unique properties of your voice. The adaptation process takes about three minutes.

Tips for adapting Digit Dial

- Adapt digits in a quiet place.
- Make sure you wait for the beep before starting to speak.
- Speak clearly, and say each digit distinctly.
- If you make a mistake while recording a sequence of digits, or if there is an unexpected noise that spoils the recording, re-record that sequence.
- Only adapt digits if you regularly have problems with digit dialing. Once adapted, digit dialing will not work as well for other people using your phone.
- Adapt Digit Dial to your voice.

Digit Dial Adaptation

To access the Adapt Digits menu, follow these steps:

1. From the main screen, press the **Center Select** key () **MENU**.
2. Use the Navigation wheel to highlight **Settings & Tools**  and then press the **Center Select** key ().
3. Press  **Phone Settings**, then  **Voice Commands**.
4. Press  **Voice Settings**, then  **Digit Dialing**.
5. **Adapt Digits** is highlighted. Press  or **Center Select** key ().
6. A short description of the Adapt Digits displays.
7. Read the description until you are comfortable to proceed, then press the **Center Select** key ().
8. Your phone displays the first digit sequence and “Please say” plays through the speakerphone followed by the four digits appearing in the display.

Wait for the beep and repeat the digits using your normal tone of voice.









9. After a moment, the phone plays back the recording and prompts “Did the recording sound ok?” If the recording was good, say “Yes.” If you need to re-record, say “No.”

If you say “No,” the phone prompts you to pronounce the digits again. Wait for the beep and then re-record. Repeat this step until you’re satisfied with the recording.

10. After confirming that the recording sounds ok, repeat the recording process with the next set of digits. After ten sets of digits, the phone indicates that adaptation is complete.

Reset Digit Dial Adaptation

This option erases an adaptation and resets Digit Dial to its original state.

1. From the main screen, press the **Center Select** key () **MENU**.
2. Use the Navigation wheel to highlight **Settings & Tools**  and then press the **Center Select** key ().
3. Press  **Tools**, then  **Voice Commands**.
4. Press the right soft key  **Settings**, then  **Digit Dialing**.
5. Highlight  **Reset Digits** and press the **Center Select** key (). The Reset Digit Adaptation screen displays requesting confirmation of reset.

Note: If you have not performed the Adapt Digits function, the Reset Digits option will not be accessible.

6. Press **Center Select** key () to proceed. Digit Adaptation Reset is completed.

VoiceSignal Commands

The following is a list of functions that you can perform using VoiceSignal speech recognition on your phone.

- **Call <Name or #>**: Dial by saying a Name in your Contacts List or a Name and a Location (home, work, mobile).
- **Send <Msg Type>**: Send a text or picture message to a number or to someone in your Contacts List.
- **Lookup <Name>**: Open the contact record for any name in your Contacts List.
- **Play <Playlist>**: If the exact name of a playlist (saved in My Music) is spoken, the song in that playlist will begin to play. Otherwise, you will be prompted to play **All Songs** or the names of **playlists** saved in My Music.
- **Go To <Menu>**: Opens the specified Main Menu item.
- **Check <Item>**: Provides details of your phone status, voicemail, messages, missed calls, time, battery level, signal strength and master volume level.
- **Help Guide**: Provides a helpful tutorial on how to use VoiceSignal.



Call Name Dialing: Contact Name

To use Name Dial, you'll need to have entries stored in your Contacts list. For more information, refer to *"Adding a Contact"* on page 56.

1. From the main screen, press and hold the **Voice Commands** key ().
2. After a brief pause, a list of optional commands appears in the display and the audio prompt "Please say a command" plays through the speakerphone.
3. Say "Call" at a distance of 3-12 inches from the phone in a natural voice.
4. "Please say the Name, Number, Voicemail or Last Number" plays through the speakerphone.
5. To use Name Dialing, say the name of the contact that you want to dial.
6. The name that you said is repeated through the speakerphone and your phone dials the number (or prompts you to select which number to dial if more than one phone number is stored for that contact).
7. If VoiceSignal is not sure of the name that you said, a list of possible matches appears in the display.
8. You're asked to confirm the correct name as VoiceSignal displays the results. Say "Yes" or "No" to confirm or reject the number when prompted.
9. VoiceSignal repeats the number that you selected and dials that number.

Send Text Msg: New Message

1. From the main screen, press and hold the **Voice Commands** key ().
2. A list of commands appears in the display and the audio prompt "Please say a command" plays through the speakerphone.
3. Say "Send Text" or "Send Picture" at a distance of 3-12 inches from the microphone.
4. "Please say the name or number" plays through the speakerphone. Say a phone number or a contact name exactly as it is displayed in your Contacts list.
5. The NEW TXT MSG screen or NEW PICTURE MSG screen will appear in the display with the To field filled in with the contact name or number that you specified.
6. To complete the message, refer to Step 5 in see *"Creating and Sending TXT Messages"* on page 72 or see *"Creating and Sending Picture Messages"* on page 73.

Name Lookup: Contact List

To perform a name lookup, you'll need to have some entries in your Contacts list.

1. From the main screen, press and hold the **Voice Commands** key ().
2. A list of commands appears in the display and the audio prompt "Please say a command" plays through the speakerphone.
3. Say "Lookup" at a distance of 3-12 inches from the microphone. "Please say the name" plays through the speakerphone.
4. Say the name exactly as it is displayed in your Contacts list.
5. The contact name appears in the display with other information that you've entered for that contact.

Play <Playlist name>

Play

Play allows you to choose from the following selections.

- **All Songs:** Allows you to play all songs on your handset. If all your music is stored on a microSD card it must be inserted to use this function.
- **Playlist:** Allows you to play a playlist.
 1. From the main screen, press and hold the **Voice Commands** key ().
 2. A list of commands appears in the display and the audio prompt "Please say a command" plays through the earpiece or speakerphone.
 - Say "Play" or "Play All Songs" at a distance of 3-12 inches from the microphone to begin playing all songs.
 - Say the "Play <Playlist Name>" at a distance of 3-12 inches from the microphone to begin playing a Playlist saved on your Music Player.

Note: The playlist name must be spoken exactly as saved in Music Player.



3. "Please Choose" plays through the earpiece or speakerphone.
4. Say "All Songs" to play all songs in your music player, say a playlist name to play that playlist.
5. You will be prompted to "**CLOSE PHONE TO CONTINUE**".
6. The selected song(s) will begin playing once the phone is closed.

Opening Menus

To begin navigation of menu items on your phone using VoiceSignal perform the following.



1. From the main screen, press and hold the **Voice Commands** key ().
2. A list of commands appears in the display and the audio prompt "Please say a command" plays through the speakerphone.
3. To begin navigation of menu items, say "Go To" at a distance of 3-12 inches from the microphone. The main menu list displays and a prompt of "Please choose" plays through the speakerphone.
4. Select one of the following menus:
 - **Music**
 - **Get It Now**
 - **Messaging**
 - **Contacts**
 - **Recent Calls**
 - **Settings & Tools**
5. The menu option spoken opens.

Checking Phone Status

1. From the main screen, press and hold the **Voice Commands** key ().
2. A list of commands appears in the display and the audio prompt "Please say a command" plays through the speakerphone.
3. Say "Check" at a distance of 3-12 inches from the microphone. "Please choose" plays through the speakerphone. Say one of the following commands:
 - **"Status"** — Displays and announces all of the available status indicators in sequence.
 - **"Voicemail"** — Displays the number of new voicemail messages.
 - **"Messages"** — Displays and announces the number of new voicemail, TXT, and Picture messages.
 - **"Missed Calls"** — Displays the missed call log.
 - **"Time"** — Displays and announces the current time.
 - **"Battery"** — Displays and announces the current battery level.
 - **"Signal Strength"** — Displays and announces the current 1x signal strength levels.
 - **"Volume"** — Displays and announces the current master volume setting.
4. After viewing or hearing the requested information, press  to return to the main screen.

Help Guide

Provides helpful information on how to use VoiceSignal.

1. From the main screen, press the **Voice Commands** key ().
2. A list of commands appears in the display and the audio prompt "Please say a command" plays through the speakerphone.
3. Say "Help Guide" at a distance of 3-12 inches from the phone in a natural voice.
4. The tutorial appears in the display. Use the Navigation wheel to page down and read the guide.
5. Press the **Center Select** key () to return to the Voice Commands screen, or press  to return to the main screen.



Section 4: Menu Navigation



Topics Covered

- Menu Navigation
 - Navigation Wheel Shortcuts
 - Menu Outline
-

This section explains the menu navigation for your phone. It also includes an outline of all the available menus associated with your phone.

Menu Navigation

Access menus using the Navigation wheel, two soft keys   , or use a shortcut.



1. Press the **Center Select** key () **MENU**. The first of several menus appear in the display.
2. Use the Navigation wheel to browse phone menus.
3. Press the **Center Select** key () to enter the menu or sub-menu presently appearing in the display.

Return to the Previous Menu

Press  to return to the previous menu.

Navigate Using Shortcuts

You can also access menus and sub-menus using menu numbers. This method is often called a “shortcut.” To shortcut to a menu or sub-menu, press the **Center Select** key () **MENU**, then enter the menu and/or sub-menu number(s) for the feature in question. For more information, refer to “*Navigation Wheel Shortcuts*” on page 44.





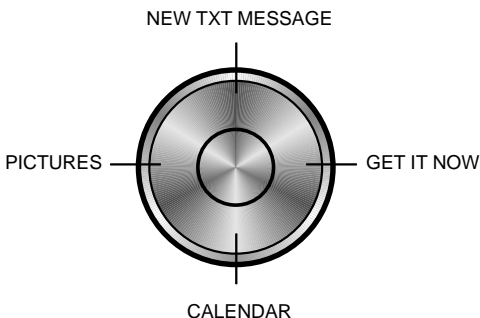

1. From the main screen, press the **Center Select** key () **MENU**.
2. Press the number of the menu you want to access. Example, press  for **Get It Now**.

Navigation Wheel Shortcuts

Use the Navigation wheel (as illustrated below) to launch it's corresponding application.



Each Navigation wheel location may be customized to select other functions. For more information, refer to "Set Shortcut Keys" on page 92.

1. From the main screen press the **Center Select** key () **MENU**.
2. Use the Navigation wheel to highlight **Settings & Tools**  and press the **Center Select** key ().
3. Press  **Phone Settings**.
4. Press  **Set Shortcut Keys**.
5. Use the Navigation wheel to select which shortcut key you want to change and press the **Center Select** key ().
6. Use the Navigation wheel to highlight the desired function for the shortcut and press the **Center Select** key () to save your selection.

Menu Outline

The following list shows the menu structure and indicates the number assigned to each option.

Music

- 1: My Music
- 2: Sync Music

GET IT NOW

- 1: Tunes & Tones
 - 1: Get New Ringtones
 - 1: Get New Applications
 - 2: My Ringtones
 - 1: Get New Ringtones
 - 3: My Sounds
 - 1: Record New
- 2: Pictures
 - 1: Get New Pictures
 - 1: Get New Applications
 - 2: My Pictures
 - 3: Take Picture
- 3: Games
 - 1: Get New Applications
- 4: Tools on the Go
 - 1: Get New Applications
- 5: Extras
 - 1: Get New Applications

MESSAGING

- 1: New Message
 - 1: TXT Message
 - 2: Picture Message
- 2: Inbox
- 3: Sent
- 4: Drafts
- 5: Voicemail
- 6: Mobile IM

CONTACTS

- 1: New Contact
- 2: Contact List
- 3: Groups
 - 1: No Group

- 2: Business
- 3: Colleague
- 4: Family
- 5: Friends
- 4: Speed Dials
- 5: In Case of Emergency
- 6: My Name Card

RECENT CALLS

- 1: Missed
- 2: Received
- 3: Dialed
- 4: All
- 5: View Timers

SETTINGS & TOOLS

- 1: Tools
 - 1: Voice Commands
 - 2: Calculator
 - 1: Normal
 - 2: Tip
 - 3: Converter
 - 3: Calendar
 - 4: Alarm Clock
 - 5: Stop Watch
 - 6: World Clock
 - 7: Notepad
- 2: Bluetooth Menu
 - 1: Add New Device
- 3: Sounds Settings
 - 1: Call Sounds
 - 1: Call Ringtone
 - 1: Get New Ringtones
 - 2: Call Vibrate
 - 2: Alert Sounds

- 1: TXT Message
 - 1: Tone
 - 1: Get New Ringtones
 - 2: Vibrate
 - 3: Reminder
- 2: Picture Message
 - 1: Tone
 - 1: Get New Ringtones
 - 2: Vibrate
 - 3: Reminder
- 3: Voicemail
 - 1: Tone
 - 1: Get New Ringtones
 - 2: Vibrate
 - 3: Reminder
- 4: Device Connect
- 3: Keypad Sounds
- 4: Keypad Volume
- 5: Service Alerts
 - 1: ERI
 - 2: Minute Beep
 - 3: Call Connect
 - 4: Service Change
- 6: Power On/Off
 - 1: Power On
 - 2: Power Off
- 4: Display Settings
 - 1: Banner
 - 1: Personal Banner
 - 2: ERI Banner
 - 2: Backlight
 - 1: Display
 - 1: Duration
 - 2: Brightness
 - 2: Keypad

- 3: Wallpaper
- 4: Display Themes
- 5: Dial Fonts
 - 1: Style
 - 2: Size
- 6: Clock Format
- 5: Phone Settings
 - 1: Standalone Mode
 - 2: Set Shortcut Keys
 - 1: Left Key
 - 2: Up Key
 - 3: Right Key
 - 4: Down Key
 - 5: Reset All
 - 3: Voice Commands
 - 1: Voice Dial
 - 2: Voice Settings
 - 3: Digit Dial Readout
 - 4: Call Alert
 - 4: Language
 - 5: Location
 - 6: Security
 - 1: Edit Codes
 - 1: Phone Only
 - 2: Calls & Services
 - 2: Restrictions
 - 1: Location Setting
 - 2: Calls
 - 3: Messages
 - 3: Phone Lock Setting
 - 4: Lock Phone Now
 - 5: Restore Phone
 - 7: System Select
 - 8: NAM Selection

- 1: NAM Selection
- 2: Auto NAM Selection

9: Quick Search

6: Call Settings

- 1: Answer Options
- 2: Auto Retry
- 3: TTY Mode
- 4: One Touch Dial
- 5: Voice Privacy
- 6: DTMF Tones

7: Memory

- 1: Phone Memory
 - 1: Memory Usage
 - 2: My Pictures
 - 3: My Ringtones
 - 4: My Sounds
- 2: Music Memory

8: Phone Info

- 1: My Number
- 2: SW Version
- 3: Icon Glossary

Section 5: Entering Text

Topics Covered

- Changing the Text Entry Mode
 - Entering Text Using Word Mode
 - Entering Characters in Abc Mode
 - Switching to Upper and Lower Case
 - Entering Symbols
 - Entering Numbers
-

This section outlines how to select the desired text input mode when entering characters into your phone. This section also describes how to use the T9 predictive text entry system to reduce the amount of key strokes associated with entering text.

Changing the Text Entry Mode

1. While composing a message, press left soft key  **Abc** to display a pop-up menu with the following Text Entry Mode options:
 - **Word**
 - **Abc**
 - **ABC**
 - **123**
 - **Symbols**
 - **Shortcuts****
 - **Quick Text***







Note: The Shortcuts option is only available when the **To** field is highlighted. Use the Shortcuts option to quickly enter @, .com, .net, or .edu to an Email address.**

The Quick Text option is only available when the **Text** field is highlighted. Use this option to quickly enter common phrases*.

Tip: Press and hold the  to cycle between text entry modes (Abc, 123, and Word).

Entering Text Using Word Mode

Word recognizes the most commonly used word for any sequence of key presses and inserts that word into your message. It's much faster than the traditional method of text entry (Abc) and requires only one key press per letter of the word that you're spelling.

1. From the main screen, press the left soft key  **Message**, then press  **New Message**,  **TXT Message** to compose a new text message.
2. Enter the phone number or email address of the recipient, then use the Navigation wheel or the **Center Select** key () to move to the **Text** field.
3. Press the left soft key  **Abc** to display a pop-up menu containing text entry mode options.
4. **Abc** is highlighted by default. Use the Navigation wheel to highlight **Word**, then press the **Center Select** key ()

Now, for practice, enter the word "Hello" into your message by pressing each of the following keys only once:



H



E



L





L





O

Word mode displays the most frequently used word for the sequence of numbers entered. The word you just entered is "Hello". If more than one word shares the same sequence, Word mode can display other matches for the entered sequence of numbers as found in the default or user dictionary. Press  to display other words in the dictionary, if available.

- **If Word mode does not find the match that you desire, you can enter a new word into the user dictionary by doing the following:**
 1. Switch to Abc mode by pressing the left soft key  **Word**. Highlight Abc and press the **Center Select** key ()
 2. Use Abc mode to enter the desired word on the screen. For more information, refer to "Entering Characters in Abc Mode" on page 52. Be sure the word is spelled correctly before pressing the space key.
 3. When you press  to enter space after the word, the new word is automatically added to the user dictionary.

Entering Characters in Abc Mode









- Enter characters while in **Abc** mode by pressing the key that contains the desired characters  for “G”.
- Press the key repeatedly to cycle through other available characters for that key.
- Pause briefly when the desired character appears in the display to accept the character and insert it into the message.
- Press  to enter a space.

Switching to Upper and Lower Case

- To cycle between initial caps, upper case, and lower case for characters in **Abc** or **Word** mode, briefly press .









Entering Symbols

Symbol mode enables you to enter symbols such as @ or % into a text message.

1. From the main screen, press the left soft key  **Message**, then press  **New Message**,  **TXT Message** to compose a new text message.
2. Enter the phone number or email address of the recipient, then use the Navigation wheel or **Center Select** key () to move to the Text field.
3. Press the left soft key  **Abc** to display a pop-up menu containing the text entry mode options.
4. **Abc** is highlighted by default. Use the Navigation wheel to highlight **Symbols**, then press the **Center Select** key (). The first of three screens containing symbols appears in the display.
5. Press the left soft key  **Prev** or the right soft key  **Next** to page through the other symbols, if necessary.
6. Enter the key that corresponds with the symbol that you wish to enter. For example, press  for an exclamation point (!) on the first page of symbols.
7. Repeat steps 3 through 6 to insert as many symbols into your message as desired.

Entering Numbers

Enter numbers into a text message while in number mode (123). For more information, refer to *"Changing the Text Entry Mode"* on page 50.

1. From the main screen, press the left soft key  **Message**, then press  **New Message**,  **TXT Message** to compose a new text message.
2. Enter the phone number or email address of the recipient, then press the down navigation or the **Center Select** key () key to move to the Text field.
3. Press the left soft key  **Abc** to display a pop-up menu containing the text entry mode options.
4. **Abc** is highlighted by default. Use the Navigation wheel to highlight **123**, then press the **Center Select** key () .
5. Enter the key that corresponds with the number that you wish to enter. For example, press  for the number **4**.
6. When you are finished adding numbers, press the left soft key  **123** to select a different method of text entry or press the **Center Select** key () **SEND** to send your message.

Section 6: Understanding Your Contacts



Topics Covered



- Opening Contacts Menu
 - Contacts Icons
 - Adding a Contact
 - Adding Pauses
 - Contact Groups
 - Finding a Contacts Entry
 - Editing an Existing Contact Entry
 - Deleting a Contact Entry
 - Speed Dialing
 - Emergency Contacts and Your In Case of Emergency List
 - My Name Card
-

This section describes how you to manage your daily contacts by storing their name and number in your Address Book. Address Book entries can be sorted by name, entry, or group.

Opening Contacts Menu

The Contacts menu provides access to powerful features such as adding Groups, creating and sending vCards and viewing the phone number assigned to your phone by Verizon Wireless.

1. From the main screen, press the **Center Select** key () **MENU**.
2. Scroll to **CONTACTS**  and press the **Center Select** key ().
 - **New Contact**: Add a phone number, or Email to your Contacts.
 - **Contact List**: Find a phone number by Name.
 - **Groups**: Add new or rename one of your five default groups.
 - **Speed Dials**: Set a speed dial for a contact.
 - **In Case of Emergency**: Designate up to 3 contacts as those who should be called in case of emergency. Also enter any important emergency information (for example, medical history or severe allergies).

- **My Name Card:** Create a business card, which can be sent to others as an attachment.
3. Use the Navigation wheel to highlight the **CONTACTS**  sub-menu of your choice, then press the **Center Select** key ().

Contacts Icons

You can assign multiple entries to a contact. The icons in the following table represent all available entry types.



Mobile 1: Enter a mobile number for the entry in this field.



Home: Enter a home number for the entry in this field.



Work: Enter the work number for the entry in this field.



Email 1: Enter an email address for the entry in this field.



Group: Select an available group to associate with the entry in this field.



Picture: Select an available picture from the Picture Gallery to associate with the contact.



Ringtone: Select a ringtone to associate with the entry in this field.



Mobile 2: Enter a secondary mobile number for the entry in this field.



Fax: Enter a fax number for the entry in this field.



Email 2: Enter a secondary email address for the entry in this field.



Notes: Enter a note for the entry in this field.

Note: Enter up to 64-character note associated with this contact.

Adding a Contact

When you add information to your Contacts, you can add it as a new entry or as an existing entry.

Creating a new Contact from the main screen

1. From the main screen, press the **Center Select** key (○) **MENU**.
2. Scroll to **CONTACTS** (👤) and press the **Center Select** key (○).
3. Press **1** **New Contact** to enter the contact information.
4. Enter a name for the entry using the keypad.
5. Use the Navigation wheel to highlight the appropriate type (**Name**, **Mobile 1**, **Home**, **Work**, **Email1**, etc.). Once highlighted, use the keypad to enter required information.

Use the Navigation wheel to highlight other type fields, if desired. Enter information using the keypad.

6. To assign a **Speed Dial** location after entering the number, press the right soft key (≡) **Options**. Highlight **Set Speed Dial** and press the **Center Select** key (○).

Highlight an unassigned location and press the **Center Select** key (○) **SET**. A confirmation message appears in the display, **Yes** is highlighted, press the **Center Select** key (○) to add the Contact to the speed dial location.

Note: Voicemail is assigned to Speed Dial location 1 and cannot be changed by the user.



Note: You can assign a speed dial location to each number associated with the contact (Mobile 1, Mobile 2, Home, Work, and Fax.).

7. When you're finished entering information for the entry, press the **Center Select** key (○) **SAVE** to save the entry to your Contacts.





Adding a number to a new or existing Contact from the main screen





You can add new numbers to the Contacts by simply entering the number from the main screen, then following the necessary prompts to complete the process.



1. From the main screen, enter the number that you wish to save using the keypad, then press the left soft key (≡) **Save**. You're prompted to select from **Add New Contact**, **Update Existing** or **Notepad**.

2. Press  **Add New Contact** to add the number as a new contact, press  **Update Existing** to add the number to an existing contact or press  **Notepad** to save the number in the Notepad.

3. If you selected **Add New Contact**, the following types are available.



-  **Mobile 1**
-  **Mobile 2**
-  **Home**
-  **Work**
-  **Fax**



4. If you selected **Update Existing**, proceed to step 9. If you selected **Notepad**, proceed to step 11.
5. Use the Navigation wheel to highlight the desired entry type (**Mobile 1**, **Mobile 2**, **Home**, **Work**, etc.) then press the **Center Select** key ().
6. Enter a name for the entry using the keypad. Press the left soft key  **Abc** if you wish to select a different method of text entry, such as Word, Abc, ABC, 123, or Symbols.
7. To assign a **Speed Dial** location, use the Navigation wheel to highlight the number you would like to assign to a **Speed Dial** location and press the right soft key  **Options**. Highlight **Set Speed Dial** and press the **Center Select** key ().

Highlight an unassigned location and press the **Center Select** key (). **SET**. A confirmation message appears in the display, **Yes** is highlighted, press the **Center Select** key () to add Contact to the speed dial location.

Note: Voicemail is assigned to Speed Dial location 1 and cannot be changed by the user.

You can assign a speed dial location to each number associated with the contact (Mobile 1, Mobile 2, Home, Work, and Fax).





8. When you're finished entering information for the entry, press the **Center Select** key () **SAVE**. The entry is saved to your Contacts.
9. If you selected **Update Existing**, the Contact List opens in Search mode. Use the Navigation wheel to browse through entries, or enter the name of the entry using the keypad. Once you've highlighted the contact entry, press the **Center Select** key ().

10. An **Update Existing** pop-up screen with a selection list of entry types displays. use the Navigation wheel to highlight the desired type then press the **Center Select** key (). The number is added to the selected entry and saved to your Contacts.
11. If you selected **Notepad**, the number is inserted on the **ADD NEW NOTE** screen. When finished entering any other text, press the **Center Select** key () **SAVE** to save the text to the Notepad list.









Storing Numbers After a Call



Once you've finished a call, you can store the number of the caller to your Contact List.



Note: If the call was incoming and Caller ID information was unavailable, then the store option is also unavailable.

1. After a call ends, the screen will briefly display "**Save**" in the lower right corner. Press the right soft key  **Save**. Or, from the main screen, press  and use the Navigation wheel to highlight the phone number.
2. Press the right soft key  **Options**. **Save** is highlighted, press the **Center Select** key ().

Note: If Save does not appear in the Options list, the number is already saved in your Contacts.



3. You're prompted to select from **Add New Contact** or **Update Existing**.
4. Press  **Add New Contact** to add the number as a new contact, or press  **Update Existing** to add the number to an existing contact.
5. If you selected **Add New Contact**, the following types are available.
 -  **Mobile 1**
 -  **Mobile 2**
 -  **Home**
 -  **Work**
 -  **Fax**
6. If you selected **Update Existing**, proceed to step 11.
7. Use the Navigation wheel to highlight the desired entry type (**Mobile 1**, **Mobile 2**, **Home**, **Work**, etc.) then press the **Center Select** key ().

8. Enter a name for the entry using the keypad. Press the left soft key  **Abc** if you wish to select a different method of text entry, such as Word, Abc, ABC, 123, or Symbols.
9. To assign a **Speed Dial** location, use the Navigation wheel to highlight the number you would like to assign to a **Speed Dial** location and press the right soft key  **Options**. Highlight **Set Speed Dial** and press the **Center Select** key ().

Highlight an unassigned location and press the **Center Select** key () **SET**. A confirmation message appears in the display, **Yes** is highlighted, press the **Center Select** key () to add Contact to the speed dial location.

Note: Voicemail is assigned to Speed Dial location 1 and cannot be changed by the user.

Note: You can assign a speed dial location to each number associated with the contact (Mobile 1, Mobile 2, Home, Work, and Fax).



10. When you're finished entering information for the entry, press the **Center Select** key () **SAVE**. The entry is saved to your Contacts.
11. If you selected **Update Existing**, the Contact List opens in Search mode. Use the Navigation wheel to browse through entries, or enter the name of the entry using the keypad. Once you've highlighted the contact entry, press the **Center Select** key ().
12. An **Update Existing** pop-up screen with a selection list of entry types displays. Use the Navigation wheel to highlight the desired type then press the **Center Select** key (). The number is added to the selected entry and saved to your Contacts.

Adding Pauses

Calls to automated systems often require a password or account number. Instead of manually entering numbers each time, store the numbers to your Contacts along with special characters called pauses.

- **Wait:** A hard pause stops the calling sequence until further input from you.
- **Pause:** A two-second pause stops the calling sequence for two seconds and then automatically sends the remaining digits.

1. From the main screen, enter the number.

2. Press the right soft key  **Options** use the Navigation wheel to highlight **Add Wait** (A “W” appears in the display.) or **Add Pause** (A “P” appears in the display.) and press the **Center Select** key ().
3. When you're finished entering information for the entry, press the left soft key  **SAVE**.
4. Continue with Step 2, Method 2 of **Adding a Contact**.





Note: Entering multiple two-second pauses extends the length of a pause. For example, two consecutive two-second pauses cause a total pause time of four seconds. Keep in mind pauses count as digits towards the 48-digit maximum.

Contact Groups



You can place Contact entries into categories, called “**Groups**.” Groups allow you to search your Contacts faster, quickly send messages to one or more group members, and more.



Note: By default, new entries to your Contacts are placed into the No Group unless another group is specified.

View Groups

1. From the main screen, press the **Center Select** key () **MENU**.
2. Scroll to **CONTACTS**  and press the **Center Select** key (.
3. Press  **Groups**. The following groups appear in the display.
 - **No Group**
 - **Business**
 - **Colleague**
 - **Family**
 - **Friends**
4. Use the Navigation wheel to highlight the desired group, then press the **Center Select** key () **VIEW** to access the group and view its contents.







Move an Entry to Another Group

1. From the main screen, press the right soft key  **Contacts**. Use the Navigation wheel to highlight the contact you wish to move.
2. Press the left soft key  **Edit**. Use the Navigation wheel to scroll to the  **Group** option.

3. Press the left soft key  **Set**. Choose from the following groups:
 - **No Group**
 - **Business**
 - **Colleague**
 - **Family**
 - **Friends**
4. Use the Navigation wheel to highlight the group containing the entry that you wish to move, then press the **Center Select** key ().
5. Press the **Center Select** key () **SAVE**. The selection has been saved to the designated group.

Create a New Group







In addition to the five groups already in your phone, you can create additional groups (a maximum of 30). New groups can be named anything you like as long as their names are within the 32-character limit.

1. From the main screen, press the **Center Select** key () **MENU**.
2. Scroll to **CONTACTS**  and press the **Center Select** key ().
3. Press  **Groups**. Your existing groups appear in the display.
4. Press the left soft key  **New**. A **New Group** pop-up menu displays with the “**Enter New Name**” field highlighted.
5. Enter the Groups name.
6. Press the **Center Select** key () **SAVE** to save. The Groups list now displays the new group added.

Send a Text Message to Members of a Group

Use Send Message in the Group feature to send a message to as many as 10 members of a group at once.

Note: Text messaging availability varies when roaming off the Verizon Wireless Network.

1. From the main screen, press the **Center Select** key () **MENU**.
2. Scroll to **CONTACTS**  and press the **Center Select** key ().
3. Press  **Groups**. Your existing groups appear in the display.
4. Highlight the desired group name and press the right soft key  **Options**. Highlight **New TXT Msg** and press the **Center Select** key ().







- Use the Navigation wheel to highlight the contacts in the group you want to send a message. Press the **Center Select** key (○) **MARK** to place a checkmark next to each selection you want to receive the TXT message.
- Press the left soft key  **Done** after selecting up to 10 contacts.





Note: You can mark up to 10 members of a group for message distribution. If you try and mark an 11th member, you'll be notified that "MAXIMUM NUMBER OF RECIPIENTS IS 10".

- Use the Navigation wheel or the **Center Select** key (○) to place the cursor in the **Text** field.
- Enter the content of your message using the keypad.
- To send the text message, press the **Center Select** key (○) **SEND**.

Send a Picture Msg to Members of a Group

Note: Only available within Verizon Wireless Enhanced Services Area.

- From the main screen, press the **Center Select** key (○) **MENU**.
- Scroll to **CONTACTS**  and press the **Center Select** key (○).
- Press  **Groups**. Your existing groups appear in the display.
- Highlight the desired group name and press the right soft key  **Options**. Highlight **New Picture Msg** and press the **Center Select** key (○).
- Press the Navigation wheel down to highlight the contacts in the group you want to send a message. Press the **Center Select** key (○) **MARK** to place a checkmark next to each selection you want to receive the Picture message.
- Press the left soft key  **Done** after selecting up to 10 contacts.
- Press the Navigation wheel down to move the cursor into the following entry fields:
 - Text:** Add text to the Picture Msg.
 - Picture:** Add an image from My Pictures to the message. Press the left soft key  **My Pics** to add an image to the message. Select an image and press the **Center Select** key (○).
 - Sound:** Add sound to the Picture Msg. Press the left soft key  **Sound** to add sound to the message. Select a sound and press the **Center Select** key (○).
 - Subject:** Add a subject line to the Picture Msg.









- **Name Card:** Add a name card to the Picture Msg. Press the left soft key  **Add.** Press  **My Name Card** to insert your own personal name card or  **Contacts** to insert a contacts name card, select a name card and press the **Center Select** key ().
8. Once you've finished adding the desired content to your Picture Msg, press the **Center Select** key () **SEND** to send the Picture Msg to the intended recipients.

Finding a Contacts Entry







Contacts is a quick way of viewing entries you've stored in the Contacts list.

1. From the main screen, press the right soft key  **Contacts**. The Contact List displays.
2. In the **Go To** field, enter the first few letters of the name you wish to find until it is highlighted.

Editing an Existing Contact Entry

1. From the main screen, press the **Center Select** key () **MENU**.
2. Scroll to **CONTACTS**  and press the **Center Select** key ().
3. Press  **Contact List**.
4. Use the Navigation wheel to highlight the contact list entry and press the left soft key  **Edit**.
5. Use the Navigation wheel to highlight the name, number, email address, or other field that you wish to edit.
6. Press  to backspace and delete numbers, text, or symbols.
7. Press and hold  to erase everything in the highlighted field.
8. Use the keypad to re-enter numbers, text, or symbols.
9. When you're finished editing the entry, press the **Center Select** key () **SAVE**. Your changes are saved.

Deleting a Contact Entry

1. From the main screen, press the **Center Select** key () **MENU**.
2. Scroll to **CONTACTS** () and press the **Center Select** key ().
3. Press  **Contact List**.
4. Use the Navigation wheel to highlight the contact list entry and press the **Center Select** key () **VIEW**.
5. Press the left soft key () **Erase**.
6. A pop-up “**ERASE CONTACT?**” screen displays.
7. Highlight **Yes** or **No**, then press the **Center Select** key ().

Speed Dialing

Note: 1-Touch, 2-Touch, and 3-Touch dialing allows you to call numbers stored in your Contact List quicker.



Speed dialing allows you to press and hold a key (or keys) to dial the number associated with those key(s). There are three types of speed dialing; **1-touch**, **2-touch**, and **3-touch dialing**.

Note: Memory location 001 is reserved for voicemail.



1-touch dialing

Call phone numbers assigned to memory locations 002 - 009 by pressing and holding the any of the 2 - 9 keys. For example, to speed dial the number assigned to location 2, press and hold  until the name and number appear in the display and the number is dialed.









2-touch dialing

Call phone numbers assigned to keys 010 through 099 by briefly pressing the first key, then pressing and holding the second key. For example, to speed dial the number assigned to 013, briefly press  , then press and hold  until the number dials.

3-touch dialing







Call phone numbers assigned to memory locations 100 through 999 by briefly pressing the first and second keys, then pressing and holding the third key. For example, to dial location number 113, briefly press  ,  , then press and hold  until the number dials.

Assign a speed dial location

1. From the main screen, press the **Center Select** key () **MENU**.
2. Scroll to **CONTACTS**  and press the **Center Select** key ().
3. Press  **Speed Dials**. The Speed Dials screen displays with the first available number highlighted.
4. Use the Navigation wheel to highlight the Speed Dial location you wish to assign a number or enter the speed dial location using the keypad, press the **Center Select** key () **SET**.
5. The **Set Speed Dial** screen displays.
6. Use the Navigation wheel to highlight the entry, then press the **Center Select** key ().
7. At the pop-up screen, "**SET SPEED DIAL TO CONTACT?**" use the Navigation wheel to highlight **Yes** or **No** and press the **Center Select** key ().
8. Continue to assign speed dial entries or press the  key to return to the main screen.

Emergency Contacts and Your In Case of Emergency List

The **In Case of Emergency** (ICE) menu allows you to store emergency information.

1. From the main screen, press the **Center Select** key () **MENU**.
2. Scroll to **CONTACTS**  and press the **Center Select** key ().
3. Press  **In Case of Emergency**.
4. Select a Contact location and press the **Center Select** key () **ADD**. The following options appear in the display:
 - **From Contacts:** Allows you choose a contact entry. Highlight a contact entry and press the **Center Select** key (). The "**Ice Contact Assigned**" pop-up displays.
 - **New Contact:** Allows you to enter a new emergency number. Enter the Name and Number of your emergency contact and press the **Center Select** key () **SAVE**. The "**Contact Saved And Set As ICE Contact**" pop-up displays.







Note: Emergency number 911 is hard-coded into your phone. You can dial this number any time, even when the phone is locked or restricted. If you call 911 an audible tone is heard and an emergency prompt appears in the display for the duration of the call.

Important! DO NOT depend on this phone as a primary method of calling 911 or for any other essential or emergency communications.

Remember to always turn your phone on and check for adequate signal strength before placing a call.

Calling Emergency Numbers when the Phone is Locked





Two types of calls can be made if the phone is locked.

1. Pressing     will call 911.
2. Pressing the left soft key  labeled **ICE** on the main screen will access the **In Case of Emergency Call list** that you have set up. Highlight a contact in the **ICE CONTACTS list** and press the **Center Select** key () to call.

Note: If you dial 911, your phone dials the emergency number immediately (no prompt).

My Name Card

My Name Card allows you to create a virtual business card. Once completed, you can send the card to recipients as a vCard attachment.





1. From the main screen, press the **Center Select** key () **MENU**.
2. Scroll to **CONTACTS**  and press the **Center Select** key ()
3. Press  **My Name Card**. My Name Card opens with the Name field highlighted.
4. Enter information in each of the fields as desired. Use the Navigation wheel to move between fields, then use the keypad to enter information.
5. When finished, press the **Center Select** key () **SAVE** to save the Name Card.

Sending Contact Information (vCard) to another Bluetooth enabled phone



You can send individual contacts or your entire contact list to or from another device that is Bluetooth enabled*.

Note: The receiving device must support **vCard** transfer in order to send contact information.

Note: *If Bluetooth is not powered on, or your Juke is not paired with another device, see "Bluetooth Menu" on page 83.

1. From the main screen, press right soft key  **Contacts**.
2. Highlight the contact to receive vCard.
3. Press right soft key  **Options**.
4. Press  **Send Name Card**. The following options display:
 - **TXT Message:** Allows you to send a name card via TXT Message. A name card with a picture cannot be sent in a TXT Message because it exceeds the maximum number of characters allowed.
 - **Picture Message:** Allows you to send a name card via Picture Message.
 - **Bluetooth:** Allows you to send a name card to a Bluetooth enabled device.
5. Press  **Bluetooth**.
6. Highlight the desired contact and press the **Center Select** key () **MARK**. To choose all contacts, press right soft key  **Mark All**.**
7. When finished, press left soft key  **Done**.

Note: If you are not already paired to the destination device, please see Step 3 of Search on page 84.

8. Highlight the destination device and press the **Center Select** key ()
9. Highlight **Yes** to connect to the other device and press the **Center Select** key ()
10. The other device will ask to connect. Press the **Center Select** key ()
11. "CONNECTING" appears in the display.
12. When the information is exchanged, a message will appear that the transfer is complete.

Note: **All information in the contact entry can be transferred except for assigned group or ringtones.

Section 7: Messaging

Topics Covered

- Types of Messages
 - Retrieving New Messages
 - Creating and Sending TXT Messages
 - Creating and Sending Picture Messages
 - Message Folders
 - Changing Message Settings
 - Voicemail
 - Mobile IM
-

This section describes how to send or receive different types of messages. It also includes the features and functionality associated with messaging.

Types of Messages





Your phone is capable of sending Email, text, picture and voicemail messages. Send Email, text, and picture messages by simply entering the Email address or the phone number of the recipient in the To: <.....> or Send To field when creating a new message.

Retrieving New Messages

While text messages from other phones are delivered directly to your phone, Picture messages and Emails will be stored in the Inbox of the message server and the server will alert you to new messages. Therefore you need to retrieve new messages to your phone and read them on the phone.

Receiving Text Messages

When you receive a message on the main screen, the message ringer sounds, (unless turned off), and **NEW TXT MESSAGE** appears in the display with the prompt to **View Now** or **View Later**. The date and time of the message also appear in the display.

1. When you receive a new TXT message, press the **Center Select** key (●) to **View Now**, or press the Navigation wheel down to highlight **View Later** and press the **Center Select** key (●). The message is saved to your Inbox where you can view it later.
2. With the message open, press the  **Erase** or  **Options** soft keys to display the following options.
 - Press the left soft key  **Erase** to erase the message.
 - Press the right soft key  **Options**. The following options may appear in the display:
 - **Forward**: Forward the message to another recipient.
 - **Reply w/copy**: Sends original message and the reply to the recipient.
 - **Save Quick Text**: Saves the text received in the message to the Quick Text list.
 - **Lock/Unlock**: Locks or unlocks the entry to prevent accidental deletion.
 - **Add To Contacts**: Save the number of the sender to your Contacts as a new entry or add to an existing entry.
 - **Message Info**: Provides the following information: From and Callback Number, Priority, Msg Type, Size and Attachments (including Picture filename and Sound filename, if any).
 - **Find Number & Address**: Tries to isolate any phone numbers or email addresses within the body of the message to save to your contacts. On the NUMBER & ADDR screen, you can press the **Center Select** key (●) to CALL a highlighted phone number, or you can press the **Center Select** key (●) to SEND a new message to a highlighted email address.
3. With the message open, press the **Center Select** key (●) **REPLY** to return a message to the sender.





Note: When viewing a TXT message, you can view the previous TXT message by pressing the Navigation wheel left and view the next TXT message by pressing the Navigation wheel right.

Receiving Picture Messages



When you receive a new Picture Message, **NEW PICTURE MSG** appears in the display along with the options **View Now**, or **View Later**.



Note: For the option Reject to appear in the display when you receive a Picture Msg, Auto Receive mode must be set to Off in the Message Settings menu.

1. When you receive a new Picture Msg, press the **Center Select** key () to **View Now**, or press the Navigation wheel down to highlight **View Later**.
2. If you select **View Now**, Loading... appears in the display.
3. After loading, the image (and text if any) contained in the Picture Msg appear in the display.
4. Use the Navigation wheel to scroll through the message or view the entire picture if necessary.
5. Press the left soft key () **Erase/Mute** or the right soft key () **Options** to display the following options.



Note: The left soft key () **Mute** only displays when a sound byte is attached to a message.

- Press the left soft key () **Erase/Mute** to erase the message or mute the sound sent with the picture message.
- Press the right soft key () **Options**. The following options may appear in the display:
 - **Play Again:** Replays the sound in the message.
 - **Forward:** Forwards the message to another recipient.
 - **Erase:** Deletes the message.
 - **Save Picture:** Saves the picture to My Pictures.
 - **Save As Ringtone:** Saves the sound to My Ringtones.
 - **Save Sound:** Saves the sound to My Sounds.
 - **Save Quick Text:** Saves the text received in the message to the Quick Text list.
 - **Lock/Unlock:** Locks or unlocks the entry to prevent accidental deletion.
 - **Add To Contacts:** Saves the number of the sender to your Contacts as a new entry or add to an existing entry.

- **Message Info:** Provides the following information: From and Callback Number, Priority, Msg Type, Size and Attachments (including Picture filename and Sound filename, if any).
- **Find Number & Address:** Tries to isolate any phone numbers or email addresses within the body of the message to save to your contacts. On the NUMBER & ADDR screen, you can press the **Center Select** key () to CALL a highlighted phone number, or you can press the **Center Select** key () to SEND a new message to a highlighted email address.

Note: When viewing a Picture message, you can view the previous Picture message by pressing the Navigation wheel left and view the next Picture message by pressing the Navigation wheel right.







Receive Messages While in a Call

1. When you receive a message while in a call, the **NEW TXT MESSAGE** or **NEW PICTURE MSG** dialog box appears in the display.

Note: Text messages can only be viewed during a call. Picture messages can not be downloaded during a call.

2. You can view the message without disconnecting your call by selecting **View Now** and press the **Center Select** key ().





To reference a message(s) while in a call

1. Press the right soft key  **Options**.
2. **Messaging** is highlighted, press the **Center Select** key ().
3. To select a folder, press  **Inbox**,  **Sent**,  **Drafts** and press the Navigation wheel up or down to highlight the message you want to view and press the **Center Select** key () **OPEN** to view the message.

View a Picture Message Later







1. When you receive a new Picture message that you would like to view later, highlight **View Later** and press the **Center Select** key ().

Note: If you receive a Picture message while on a call, a pop-up box will display with a New Picture message and message information. You cannot choose to view now or view later. You can only press the **Center Select** key  to clear the pop-up box from the screen. After the call has ended, you may view the picture by following steps 2 and 3.



2. To view the message, press the left soft key  **Message**,  **Inbox**.
3. Use the Navigation wheel to highlight the unopened message, and press the **Center Select** key () **OPEN**. Then press the **Center Select** key () **DOWN** to download the picture from the message server.

Creating and Sending TXT Messages



You can send text messages to another mobile phone or to an Email address.

1. From the main screen, press the left soft key () **Message**.
2. Press  **New Message**.
3. Press  **TXT Message** to compose a new text message.
4. Enter the phone number or Email address of the recipient. At any point while entering your recipient(s) phone number or Email address, press the left soft key  **123** or the right soft key  **Add** to display additional options.
 - Press the left soft key  **123** to change Text Entry Mode. Choose Word, Abc, ABC, 123, Symbols or Shortcuts modes of text entry.
 - Press the right soft key  **Add** to add a recipient From Contacts, Recent Calls or Groups. If you have entered a new phone number in the To field, you will also see an option to save it To Contacts.

Note: If you do not select an option press the  to return to your message.



5. Press the Navigation wheel down or the **Center Select** key () to move to the **Text** field. In the text field, compose your message using the keypad. At any point while composing a message, press the left soft key  **Abc** or right soft key  **Options** to display additional options.

Tip: For more information on entering text and text entry modes see "Entering Text" on page 50.

- Press the left soft key  **Abc** to change Text Entry Mode. Choose Word, Abc, ABC, 123, Symbols, or Quick Text modes of text entry.
- Press the right soft key  **Options** to display a pop-up menu with the options listed:
 - **Save As Draft:** Save the message to your Draft folder.
 - **Add Graphic:** Lists preloaded and downloaded graphics.
 - **Add Animation:** Lists preloaded and downloaded animations.
 - **Add Sound:** Lists preloaded and downloaded sounds.
 - **Add Quick Text:** Displays a list of phrases that you can quickly insert into the message.
 - **Add Name Card:** Allows you to attach your name card to the message.
 - **Edit Text Format:** Allows you to edit the text size, alignment, style, color, and background color.
 - **Priority Level:** Save the message with a High or Normal priority.
 - **Callback #:** Provides the ability to send a callback # with the message.

- **Enh. Delivery Ack:** Displays a pop-up screen notifying the message sent has been received.
- **Cancel Message:** Cancels the message and allows you to save it in the Drafts folder.







Note: If you do not select an option press the  to return to your message.

6. Use the Navigation wheel to highlight an option. Press the **Center Select** key () to perform the function for the option, or to enter its sub-menu.
7. To send the message, press the **Center Select** key () **SEND**.



Creating and Sending Picture Messages

Note: Only available within Verizon Wireless Enhanced Services Area.

Picture Messages allow you to add sounds and images to your message.



1. From the main screen, press the left soft key () **Message**.
2. Press  **New Message**.
3. Press  **Picture Message** to compose a new message.
4. Enter the phone number or Email address of the recipient. At any point while entering your recipient(s) phone number or Email address, press the left soft key  **123** or the right soft key  **Add** to display additional options.
 - Press the left soft key  **123** to change Text Entry Mode. Choose Word, Abc, ABC, 123, Symbols or Shortcuts modes of text entry.
 - Press the right soft key  **Add** to add a recipient From Contacts, Groups, Recent Calls, or To PIX Place.

Note: If you do not select an option press the  to return to your message.















5. Press the Navigation wheel down or the **Center Select** key () to move to the **Text** field. In the text field, compose your message using the keypad. At any point while composing a message, press the left soft key  **Abc** or the right soft key  **Options** to display additional options.

Tip: For more information on entering text and text entry modes see "Entering Text" on page 50.

- Press the left soft key  **Abc** to change Text Entry Mode. Choose Word, Abc, ABC, 123, Symbols or Quick Text modes of text entry.

- Press the right soft key  **Options** to display a pop-up menu with the options listed:
 - **Preview:** Shows the message before it is sent.
 - **Save As Draft:** Save the message to your Draft folder.
 - **Add Quick Text:** Choose from up to 12 pre-loaded messages. You can add 15 additional messages by pressing the right soft key  New and erase messages by pressing the left soft key  Erase.
 - **Priority Level:** Save the message with a High or Normal priority.
 - **Cancel Message:** Cancels the message and allows you to save it in the Drafts folder.

Note: If you do not select an option press the  to return to your message.

6. Press the Navigation wheel down to highlight the **Picture** field. Press the left soft key  **My Pics** to add a Picture, using the Navigation wheel highlight a picture you want to attach and press the **Center Select** key () to attach the picture.
7. Press the Navigation wheel up or down to highlight the **Sound** field. Press the left soft key  **Sounds** to select a sound. Press the Navigation wheel up or down to highlight the desired sound and press the **Center Select** key ().
8. Press the Navigation wheel down to highlight the **Subject** field. Press the left soft key  **Abc** to change entry mode. Select the desired entry mode, and press the **Center Select** key ().
 Press the right soft key  **Options**, to highlight **Add Quick Text** and press the **Center Select** key (). Press the Navigation wheel up or down to highlight the desired Quick Text phrase, and press the **Center Select** key ().
9. Press the Navigation wheel down to highlight the **Name Card** field. Press the left soft key  **Add** to add a Name Card, the **Add** pop-up menu displays.
 - Press  **My Name Card** to create and add your Name Card, press the **Center Select** key ().
 - Press  **Contact** to add a Contact entry as a Name Card, press the **Center Select** key ().
10. Once all fields are complete, press the **Center Select** key () to send the message to the intended recipient(s).



Message Folders

Your phone provides default message folders for your Text and Picture messages.

Note: To quickly view all messages in the Inbox, or Sent folders, open one message and then use the Navigation wheel to view the next message or use the Navigation wheel to view the previous message.

Inbox

Received messages of all types are stored in the Inbox folder.

1. Press the left soft key  **Message** then press  **Inbox**.
2. Use the Navigation wheel to highlight the message you want to view.
3. Press the **Center Select** key () **OPEN** to view contents of the highlighted message.

Tip: While viewing a message press the left or right navigation to view other messages.

4. While viewing a message press the right soft key  **Options**. The following options may appear in the display:
 - **Play Again:** Replays a Picture message with sound.
 - **Forward:** Forward the message to another recipient.
 - **Erase:** Deletes the message. This option only displays if a sound byte is attached to the message.
 - **Reply w/copy:** Sends original message and the reply to the recipient.
 - **Save Picture:** Saves the picture sent in a Picture message to My Pictures.
 - **Save As Ringtone:** Saves the sound received with the Picture message to My Ringtones.
 - **Save Sound:** Saves the sound received with the message to My Sounds.
 - **Save Object:** Saves the graphics sent in a message to My Pictures.
 - **Save Quick Text:** Saves text in the Text field to the Quick Text list.
 - **Lock/Unlock:** Locks or unlocks the entry to prevent accidental deletion.
 - **Add To Contacts:** Save the number of the sender to your Contacts as a new entry or add to an existing entry.
 - **Find Number & Address:** Tries to isolate any phone numbers or email addresses within the body of the message to save to your contacts. On the NUMBER & ADDR screen, you can press the **Center Select** key () to CALL a highlighted phone number, or you can press the **Center Select** key () to SEND a new message to a highlighted email address.
 - **Message Info:** Provides the following information: From (also provides the date and time the message was received), Callback Number, Priority, Msg Type, Size

(if a Picture, or Sound were included in the message) and Attachments (if a Picture, or Sound were included in the message).

Press the left soft key  **Erase** to delete the message from the Inbox. Highlight **Yes** to delete, or **No** to return to the message.

5. Press the **Center Select** key () **REPLY** to return a message to the sender.



Note: When Auto Erase is turned on, the oldest read TXT message is replaced by an incoming TXT message when 0 TXT messages are stored in the Inbox, and the oldest read Picture message is replaced by an incoming Picture message when 50 Picture messages are stored in the Inbox. For information on how to set Auto Erase and Auto Receive, see "Changing Message Settings" on page 80.

Sent



Your phone stores messages in the Sent folder, regardless of whether the message was successfully transmitted. Verify if and when a TXT message or Email was successfully transmitted by enabling the **Enh. Delivery Ack** feature. Press the right soft key  **Options** to set the Enh. Delivery Ack feature On when creating a new message.





Note: Enhanced Delivery Acknowledgement can't be set for Picture messages.

Review Messages in the Sent Folder

1. From the main screen, press the left soft key  **Message** then press  **Sent**.
2. Use the Navigation wheel to highlight the message you wish to review, then press the **Center Select** key () **OPEN**.

Tip: While viewing a message press the left or right navigation to view other messages.

3. While viewing the message, press the right soft key  **Options**. Use the Navigation wheel to highlight the desired option. Press the **Center Select** key () to perform the function for the highlighted option. Options are dependent on the message type:
 - For Text Messages the following options may appear in the display:
 - **Forward:** Forwards the message to another recipient.
 - **Lock/Unlock:** Locks or unlocks the entry to prevent accidental deletion.
 - **Save Quick Text:** Saves the text sent in the message to the Quick Text list.
 - **Add To Contacts:** Adds the sender's information to your contact list.

- **Find Number & Address:** Tries to isolate any phone numbers or email addresses within the body of the message to save to your contacts. On the NUMBER & ADDR screen, you can press the **Center Select** key () to CALL a highlighted phone number, or you can press the **Center Select** key () to SEND a new message to a highlighted email address.
 - **Message Info:** Provides the following information: Send To Number or Email address, Priority, Msg Type, Size, Status and Cause Code.
- For Picture Messages the following options may appear in the display:
 - **Play Again:** Plays the sound byte attached to the message.
 - **Forward:** Forwards the message to another recipient.
 - **Erase:** Erases the message.
 - **Lock/Unlock:** Locks or unlocks the entry to prevent accidental deletion.
 - **Save Quick Text:** Saves the text sent in the message to the Quick Text list.
 - **Add To Contacts:** Adds the sender's information to your contact list.
 - **Find Number & Address:** Tries to isolate any phone numbers or email addresses within the body of the message to save to your contacts. On the NUMBER & ADDR screen, you can press the **Center Select** key() to CALL a highlighted phone number, or you can press the **Center Select** key () to SEND a new message to a highlighted email address.
 - **Message Info:** Provides the following information: Send To Number or Email address, Priority, Msg Type, Size, Attachment, Status and Cause Code.
4. Use the Navigation wheel to highlight the desired option.
 5. Press the **Center Select** key () to perform the function for the highlighted option.

Note: If no sound byte is attached to the message, press the left soft key  **Erase** to delete the message from the Sent folder. Highlight Yes to delete, or No to return to the message.





If a sound byte is attached to the message, press the left soft key  **Mute/Unmute** to mute/unmute the sound playback.

6. Press the **Center Select** key () **SEND** to compose the message with same contents to the recipient again.



Drafts

Draft messages are those that have been composed but never sent. You can return to the Drafts folder at any time to view, edit, or send a draft message.

Create a Draft Text Message

1. From the main screen, press the left soft key  **Message** then press  **New Message**.
2. Select the type of message you want to create.
3. Enter the phone number of the recipient, then press the Navigation wheel down.
4. Compose your message using the keypad, then press the right soft key  **Options**. A pop-up menu appears in the display.
5. **Save As Draft** is highlighted, press the **Center Select** key (.

View and Edit Draft Messages

1. From the main screen, press the left soft key  **Message** then press  **Drafts**.
2. Use the Navigation wheel to highlight the message you wish to view, then press the **Center Select** key () **EDIT**.







Note: Press  to backspace and delete any current characters in the display, if desired.

Press and hold  to erase a word.

3. Edit the **To** field. Press the down navigation to move to the **Text** field.
4. Edit the **Text** field.

Press the right soft key  **Options**. A pop-up menu appears in the display with the options listed.



- For Text Messages the following options appear in the display:
 - **Save As Draft:** Saves the message in the draft folder.
 - **Add Graphic:** Lists all graphics pre-loaded and downloaded.

- **Add Animation:** Lists all animations pre-loaded and downloaded.
 - **Add Sound:** Lists all sounds pre-loaded and downloaded.
 - **Add Quick Text:** Choose from up to 12 pre-loaded messages. You can add 15 additional messages by pressing the right soft key  New and erase messages by pressing the left soft key  Erase.
 - **Add Name Card:** Allows you to attach your name card to the message.
 - **Edit Text Format:** Allows you to edit the text size, alignment, style, color, and background color.
 - **Priority Level:** Save the message with a High or Normal priority.
 - **Callback #:** Provides the ability to send a callback # with the message.
 - **Enh. Delivery Ack:** Displays a pop-up screen notifying the message sent has been received.
 - **Cancel Message:** Cancel the current message.
- For Picture Messages the following options appear in the display:
 - **Preview:** Allows you to preview the message.
 - **Save As Draft:** Saves the message in the draft folder.
 - **Add Quick Text:** Choose from up to 12 pre-loaded messages. You can add 15 additional messages by pressing the right soft key  New and erase messages by pressing the left soft key  Erase.
 - **Priority Level:** Save the message with a High or Normal priority.
 - **Cancel Message:** Cancels the message and allows you to save it in the Drafts folder.
5. Use the Navigation wheel to highlight the desired option. Press the **Center Select** key () to perform the function for the highlighted option.
 6. Once you've returned to the message composer, press the **Center Select** key () to send the message, if desired.

Erase Options

You can erase unlocked messages in your Inbox, Drafts folder, or Sent folder. Locked messages are not erased.

To erase messages:

1. Press the left soft key  **MESSAGE**.
2. Press the right soft key  **Options**. The following options are available:
 - **Erase Inbox:** Erases unlocked messages in your Inbox.
 - **Erase Drafts:** Erases unlocked messages in your Drafts folder.
 - **Erase Sent:** Erases unlocked messages in your Sent folder.
 - **Erase All:** Erases unlocked messages in all message folders (Inbox, Drafts and Sent).

Changing Message Settings

This menu allows you to define settings for messages sent or received on your phone. To access your message settings, use the following steps:



1. From the main screen, press the left soft key  **Message** and then press the left soft key  **Settings**.
 - **Entry Mode:** Sets the default entry mode for messaging. Choose from Word, Abc, ABC, or 123.
 - **Auto Save Sent:** Saves all messages sent. Use the Navigation wheel to select On, Off, or Prompt.
 - **Auto Erase Inbox:** Erases the oldest message of the same type (TXT or Picture) when the maximum number of received messages of that type is exceeded in the Inbox. For example, the oldest read TXT message is replaced by an incoming TXT message when 100 TXT messages are stored in the Inbox, and the oldest read Picture message is replaced by an incoming Picture message when 50 Picture messages are stored in the Inbox. Choose from On or Off.
 - **Messaging Font Size:** Allows you to change the font size for viewing messages to Normal or Large.
 - **TXT Auto View:** Automatically displays the TXT message when received. Choose from On or Off.
 - **Pic Auto Receive:** Automatically receives a Picture message into your Inbox. Choose from On or Off.
 - **Quick Text:** Displays the Quick Text list, and allows you to erase or add a new phrase.
 - **Voicemail #:** Displays the speed dial entry set for your voicemail, , and allows you to change it. Press the right soft key  **Cancel** if you don't want to change the entry.
 - **Callback #:** Displays the callback number in the text message. Choose from On or Off.
 - **Signature:** Adds the signature text to each message sent. Choose from None or Custom.

Voicemail

When you receive a new voicemail message you'll hear a sound and a prompt screen appears in the display.

1. Press the Navigation wheel up or down to select **Listen Now** or **Listen Later**.
2. Press the **Center Select** key ().

View Voicemail Messages in the Inbox Folder

1. From the main screen, press the **left soft key**  **Message**.
2. Press  **Voicemail**.
3. Press the **Center Select** key () **CALL** to call voicemail.

Note: You can also press and hold  from the main screen to call voicemail.





Mobile IM

The Instant Messaging function allows you to send and receive instant messages using one of the following communities:

- **AOL® Instant Messenger™**
- **Windows Live (WL)® Messenger**
- **Yahoo!® Messenger**

Note: You can set up your Mobile IM account from your home computer. After setting up your Mobile IM account you can log in through your handset. You cannot use your handset to set up a new IM account. Messages will be charged according to your Text Messaging plan.

Using Mobile IM

1. From the main screen, press the **left soft key**  **Message**.
2. Press  **Mobile IM**.
3. Highlight **Mobile IM** and press the **Center Select** key ().
4. Select your instant message community using the Navigation wheel **left** or **right** and press the **Center Select** key ().
5. Use the on-screen application specific functions and options to use the instant message applications.

Section 8: Changing Your Settings

Topics Covered

- Tools
 - Bluetooth Menu
 - Sounds Settings
 - Display Settings
 - Phone Settings
 - Call Settings
 - Memory
 - Phone Info
-

This section explains the sound and phone settings for your phone. It includes display settings, security settings, and extra settings associated with your phone.

Tools

The Tools menu provides the ability to access the following menus:

- Voice Commands: For more information, refer to "*Voice Commands*" on page 34.
- Calculator: For more information, refer to "*Calculator*" on page 122.
- Calendar: For more information, refer to "*Calendar*" on page 124.
- Alarm Clock: For more information, refer to "*Alarm Clock*" on page 126.
- Stop Watch: For more information, refer to "*Stop Watch*" on page 128.
- World Clock: For more information, refer to "*World Clock*" on page 129.
- Notepad: For more information, refer to "*Notepad*" on page 129.

Bluetooth Menu

About Bluetooth

Bluetooth is a short-range wireless communications technology capable of exchanging information over a distance of about 30 feet without requiring a physical connection.

Unlike infrared, you don't need to line up the devices to beam information with Bluetooth. If the devices are within a range of one another, you can exchange information between them, even if they are located in different rooms.

Note: When connected to your Bluetooth headset, press the headset multi-function key to use VoiceSignal's Voice Dial feature.

Bluetooth Service Profiles

Actually, the Bluetooth specification is a protocol that describes how the short-range wireless technology works, whereas individual profiles describe the services supported by individual devices. Profiles reduce the chance that different devices will not work together.

Your phone supports the following Bluetooth profile services:





- Voice Calls are supported using any of the following depending on the accessory:
HSP - Headset or **HFP** - Hands-free profiles. *
- Bluetooth Stereo uses **A2DP** - Advanced Audio Distribution Profile and **AVRCP** - Audio/Video Remote Control Profile.
- Transfer Object allows sending an **OPP** - Object Push Profile which allows transfer of vCard (i.e., Contact information) between devices.
- Automobile Kits can use any of the following: **HFP** - Hands-free or **PBAP** - Phone Book Access Profiles. *
- Connectivity Connections (i.e. computer) are supported using **SPP** - Serial Port (connecting two BT devices).

* For vehicle/accessory compatibility, go to www.verizonwireless.com/bluetooth/chart. Phone does not support all Bluetooth OBEX profiles.

On/Off

When the Bluetooth radio is turned on, you can use the Bluetooth features available. When the Bluetooth radio is turned off, you cannot send or receive information via Bluetooth. To save battery life or in situations where radio use is prohibited, such as airline traveling, you can turn off the Bluetooth wireless technology.





Warning: To ensure that the Hearing Aid Compatibility rating for your phone is maintained, secondary transmitters such as Bluetooth and WLAN components must be disabled during a call. For instructions to disable these components, see "Changing Your Settings" on page 82.

1. From the main screen, press the **Center Select** key (.
2. Use the Navigation wheel to highlight **Settings & Tools**  and press the **Center Select** key (.
3. Press  **Bluetooth Menu**.
4. Press the left soft key  to turn Bluetooth **On** or **Off**.



Note: If Bluetooth is turned on, the  Bluetooth icon displays in the top line of the display.

Search

This option searches for a recognized Bluetooth wireless technology device.





1. From the main screen, press the **Center Select** key (.
2. Use the Navigation wheel to highlight **Settings & Tools**  and press the **Center Select** key (.
3. Press  **Bluetooth Menu**.
4. **Add New Device** is highlighted, press the **Center Select** key ( twice.

Note: If you have NOT already activated Bluetooth on the phone, the message "TURN BLUETOOTH POWER ON?" displays. Highlight Yes to activate or No to exit and press the Center Select key (.

5. A list of found Bluetooth devices will be displayed. Use the Navigation wheel to highlight a Bluetooth device. Press the **Center Select** key () to pair the devices.
6. The phone automatically attempts to send a passkey of "0000" to a hands-free device and shows the message "ATTEMPTING TO AUTO PAIR". If the default passkey is not successful, the phone will display the message " FAILED IN AUTO PAIR . ENTER PASSKEY". (If you are attempting to pair with a car kit, be sure to clear any error message on the car kit display first.) Enter the correct passkey for the device you want to pair, and press the **Center Select** key (.
7. Select **Yes** to connect the devices. Once connected the Bluetooth Connected icon  appears in the upper half of the display.

Bluetooth Settings

The Bluetooth wireless technology settings menu provides the ability to view and change the device name, show the visibility, and set the security for the device.

1. From the main screen, press the **Center Select** key (.
2. Use the Navigation wheel to highlight **Settings & Tools**  and press the **Center Select** key (.
3. Press  **Bluetooth Menu**.

4. Press the right soft key  **Options**. The Bluetooth menu displays with the following options:
 - **My Phone Name**: Allows you enter a customized name.
 - **Discovery Mode**: Allows other users to see your accessibility. Select On for other devices to see your device, or Off for no visibility.

Note: After selecting On, users have one minute to see your accessibility. After which Discovery Mode will automatically default back to off.









- **Supported Profiles**: Displays a list of supported Bluetooth profiles. Highlight a profile and press the Center Select key () to view a description.
- **My Phone Info**: Shows the handset information.

Sounds Settings

The Sounds menu provides the ability to access the following menus:

Call Sounds





Call Ringtones

1. From the main screen, press the **Center Select** key (.
2. Use the Navigation wheel to highlight **Settings & Tools**  and press the **Center Select** key (.
3. Press  **Sounds Settings**.
4. Press  **Call Sounds**.
5. Press  **Call Ringtone** to choose:
 - Preloaded ringtone(s)
 - Custom ringtone(s)
 - Press  **Get New Ringtones**.
 - Press  **Get New Applications**. Select a ringtone app and press the **Center Select** key () to follow the on screen prompts.

Note: Selecting an application can incur a fee.







6. Press  **Call Vibrate** to turn Call Vibrate On or Off. Highlight On or Off, and press the **Center Select** key (.

Alert Sounds







1. From the main screen, press the **Center Select** key (.
2. Use the Navigation wheel to highlight **Settings & Tools**  and press the **Center Select** key (.
3. Press  **Sounds Settings**.
4. Press  **Alert Sounds**. For the following options, you can set the tone for the message alerts. You can also set vibration on and set a reminder.
 - **TXT Message**: Allow you to set a notification for TXT message.
 - **Picture Message**: Allow you to set a notification for Picture message.
 - **Voicemail**: Allow you to set a notification for Voicemail Message.
 - **Device Connect**: Allow you to set a notification when you connect to a device.

Keypad Sounds



Select the sound of the keypad when pressed.

1. From the main screen, press the **Center Select** key (.
2. Use the Navigation wheel to highlight **Settings & Tools**  and press the **Center Select** key (.
3. Press  **Sounds Settings**.
4. Press  **Keypad Sounds**.
5. Use the Navigation wheel to select **Default** or **Xylophone**.
6. Press the **Center Select** key () to set the new dial sound.



Keypad Volume

1. From the main screen, press the **Center Select** key (.
2. Use the Navigation wheel to highlight **Settings & Tools**  and press the **Center Select** key (.
3. Press  **Sounds Settings**.
4. Press  **Keypad Volume**.
5. Use the Navigation wheel, or volume key to adjust the keypad volume.
6. Press the **Center Select** key () **SET** to save.

Service Alerts



1. From the main screen, press the **Center Select** key (○).
2. Use the Navigation wheel to highlight **Settings & Tools**  and press the **Center Select** key (○).
3. Press  **Sounds Settings**.
4. Press  **Service Alerts**. For the following options, you can turn the Service Alert **On** or **Off**.
 - **ERI**: Sounds an alert when you go into and out of your coverage areas.
 - **Minute Beep**: While on a call your phone beeps after every minute of usage.
 - **Call Connect**: Sounds an alert when a call is connected and when a call has ended.
 - **Service Change**: Allows you to turn the Service Change alert On or Off.

Power On/Off

1. From the main screen, press the **Center Select** key (○).
2. Use the Navigation wheel to highlight **Settings & Tools**  and press the **Center Select** key (○).
3. Press  **Sounds Settings**.
4. Press  **Power On/Off**. You can set the sounds for Power On and Power Off to either **On** or **Off**.

Display Settings





The **Display** menu affects the menu style, main screen animation, backlight settings, and more.

1. From the main screen, press the **Center Select** key (○).
2. Use the Navigation wheel to highlight **Settings & Tools**  and press the **Center Select** key (○).
3. Press  **Display Settings**.
4. Use the Navigation wheel to highlight the display menu that you wish to edit, then press the **Center Select** key (○).
5. Use the Navigation wheel to select an option and press the **Center Select** key (○).

Banner

Banner allows you to create your own personalized greeting that appears in main screen. Or you can display the network to which you are subscribed.





To create a personal banner:

1. From the main screen, press the **Center Select** key (○).
2. Use the Navigation wheel to highlight **Settings & Tools**  and press the **Center Select** key (○).
3. Press  **Display Settings**.
4. Press  **Banner**.
5. Press  **Personal Banner** to create a customized banner for your handset.

Note: Press and hold  to erase an existing banner, if necessary.

6. Enter a word or short phrase (18 characters or less) to appear in the main screen.
7. Use the Navigation wheel to highlight the **Select Text Color** field and to select **White** or **Black**.
8. Press the **Center Select** key (○) to save the new banner and text color.



To turn on an ERI banner:

1. From the main screen, press the **Center Select** key (○).
2. Use the Navigation wheel to highlight **Settings & Tools**  and press the **Center Select** key (○).
3. Press  **Display Settings**.
4. Press  **Banner**.
5. Press  to set the **ERI Banner** for your handset.
6. Select **On** or **Off** and press the **Center Select** key (○).



Backlight

Set the **backlight** for the display or keypad to remain on for a specified period of time or to remain on as long as the swivel is open.



Note: Prolonged backlight use drains your battery faster.



1. From the main screen, press the **Center Select** key (○).
2. Use the Navigation wheel to highlight **Settings & Tools**  and press the **Center Select** key (○).
3. Press  **Display Settings**.
4. Press  **Backlight**.
 - **Display:** The following options are for the Main LCD.
 - **Duration:** Can be set to 7 seconds, 15 seconds, 30 seconds, Always On, or Always Off.
 - **Brightness:** Use the Navigation wheel to adjust the brightness.
 - **Keypad:** The following options are for the keypad.
 - **7 Seconds:** The keypad is on for 7 seconds.
 - **15 Seconds:** The keypad is on for 15 seconds.
 - **30 Seconds:** The keypad is on for 30 seconds.
 - **Always On:** The keypad is always on.
 - **Always Off:** The keypad is always off.
5. Use the Navigation wheel to highlight a menu.
6. Press the **Center Select** key (○) to enter the highlighted option's menu and change settings as desired.

Wallpaper





1. From the main screen, press the **Center Select** key (○).
2. Use the Navigation wheel to highlight **Settings & Tools**  and press the **Center Select** key (○).
3. Press  **Display Settings**.
4. Press  **Wallpaper**.
5. Use the Navigation wheel to highlight your selection, then press the **Center Select** key (○) to select the wallpaper that will appear in the display.

Display Themes

1. From the main screen, press the **Center Select** key (○).
2. Use the Navigation wheel to highlight **Settings & Tools**  and press the **Center Select** key (○).
3. Press  **Display Settings**.
4. Press  **Display Themes**.
5. Use the Navigation wheel to select **Boom Box** or **Vivace** display theme, and press the **Center Select** key (○).



Note: Press the left soft key  **View** to view the Display Theme. When viewing a Display Theme, use the Navigation wheel to scroll through the themes. Press the left soft key  **List** to return to the list.





Dial Fonts

1. From the main screen, press the **Center Select** key (○).
2. Use the Navigation wheel to highlight **Settings & Tools**  and press the **Center Select** key (○).
3. Press  **Display Settings**.
4. Press  **Dial Fonts**.
5. Press  **Style** or  **Size** and press the **Center Select** key (○).
 - **Style:** Choose Normal, Rainbow, Quill Pen, or Sticky.
 - **Size:** Choose Normal or Large Only.
6. Use the Navigation wheel to select a dialing font preference, then press the **Center Select** key (○).

Clock Format

This menu allows you to have time displayed in digital or analog format.

1. From the main screen, press the **Center Select** key (○).
2. Use the Navigation wheel to highlight **Settings & Tools**  and press the **Center Select** key (○).
3. Press  **Display Settings**.
4. Press  **Clock Format**.
5. The following options appear in the display. Use the Navigation wheel to select an options.







- **Digital:** Time appears in digital format, for example, 12:54pm.
 - **Analog:** Time appears in clock format. Digital format is still present in the display.
 - **Off:** No time is displayed.
6. Press the right soft key  **Options** to display the Options pop-up menu. Press  **Time & Date Color**. Use the Navigation wheel to select **Black** or **White** and press the **Center Select** key () to set the **Time & Date Color**.
 7. Press the **Center Select** key () to save.

Phone Settings

The Phone Settings menu provides the ability to access the following menus:







Standalone Mode

With **Standalone Mode** on, all RF functions for your phone are disabled, and you cannot use your phone to place or receive calls.

1. From the main screen, press the **Center Select** key ().
2. Use the Navigation wheel to highlight **Settings & Tools**  and press the **Center Select** key ().
3. Press  **Phone Settings**.
4. Press  **Standalone Mode**. Use the Navigation wheel to select **On** or **Off** and press the **Center Select** key ().

Set Shortcut Keys

Shortcut Keys allows you to select from up to 18 applications that appear in the display when you press the left/right/up/down directional keys on the Navigation wheel from the main screen.

1. From the main screen, press the **Center Select** key ().
2. Use the Navigation wheel to highlight **Settings & Tools**  and press the **Center Select** key ().
3. Press  **Phone Settings**.
4. Press  **Set Shortcut Keys**.
5. Use the Navigation wheel to select the directional key you want to change and press the **Center Select** key ().

Note: Press  **Reset All** to return to the Navigation wheel defaults settings. For default settings see "Menu Navigation" on page 43.







6. Select a menu item and press the **Center Select** key ().

Voice Commands

For more information, refer to "Voice Commands" on page 34.

Language





Change the display language from English to Spanish or vice versa using the **Language** menu.

1. From the main screen, press the **Center Select** key ().
2. Use the Navigation wheel to highlight **Settings & Tools**  and press the **Center Select** key ().
3. Press  **Phone Settings**.
4. Press  **Language**.
5. Use the Navigation wheel to select **English** or **Español**, and press the **Center Select** key ().

Location

Note: This feature is only available on the Verizon Wireless network.

The Location (GPS) setting identifies your location to the network. You can fully enable this setting or set GPS to work only in the case that you dial 911 from your phone.

1. From the main screen, press the **Center Select** key ().
2. Use the Navigation wheel to highlight **Settings & Tools**  and press the **Center Select** key ().
3. Press  **Phone Settings**.

Note: If you have set the Location Setting to "Lock Setting" via the Security Restrictions screen, you will need to enter the Calls & Services Code to access this menu.

4. Press  **Location**. The following options appear in the display:
 - **Location On:** GPS location setting is on wherever the feature is available.
 - **E911 Only:** GPS location setting is on whenever you dial 911 only.
5. Use the Navigation wheel to highlight an option.

6. Press the **Center Select** key (○) to select the highlighted setting.



Security

The **Security** menu allows you to lock your phone, set restrictions, and other security options.

1. From the main screen, press the **Center Select** key (○).
2. Use the Navigation wheel to highlight **Settings & Tools**  and press the **Center Select** key (○).
3. Press  **Phone Settings**.
4. Press  **Security**.
5. Enter the Phone Lock Code (default code is your last 4 digits of your phone number) and press the **Center Select** key (○). The following options appear in the display:
 - **Edit Codes:** Allows you to change the Lock Code for Phone Only or for Calls & Services.
 - **Restrictions:** Allows you to restrict the Location Setting (Lock/Unlock Setting), Calls (Outgoing or Incoming calls), Messages (Outgoing or Incoming messages). To access the restricted functions, the Calls & Services Code must be entered.
 - **Phone Lock Setting:** Allows you to set the phone to Unlocked or lock the phone On Power Up.
 - **Lock Phone Now:** Allows you to temporarily lock the handset. The Phone Lock Code must be entered to unlock the handset.
 - **Restore Phone:** All settings are reset to factory default settings.

Lock Phone

Lock Phone restricts the use of your phone with the exception of outgoing calls to 911 or the contacts listed in your In Case of Emergency list (For more information, refer to *"Emergency Contacts and Your In Case of Emergency List"* on page 65.) Lock Phone allows you to answer calls, but to place calls (except to emergency numbers) you have to unlock the phone.

1. From the main screen, press the **Center Select** key (○).
2. Use the Navigation wheel to highlight **Settings & Tools**  and press the **Center Select** key (○).
3. Press  **Phone Settings**.
4. Press  **Security**. You're prompted to enter the lock code. The Phone Lock Code is the last four digits of your telephone number.

5. Enter the **Lock Code** and press the **Center Select** key (○). Several security menus appear in the display.
6. Press **3** def **Phone Lock Setting**. The following options display:
 - **Unlocked**: If locked, unlocks the device or phone, depending on your selection.
 - **On Power Up**: The Phone Lock Code is required whenever you power up the phone.
7. Use the Navigation wheel to select an option and press the **Center Select** key (○).

Lock Phone Now

1. From the main screen, press the **Center Select** key (○).
2. Use the Navigation wheel to highlight **Settings & Tools**  and press the **Center Select** key (○).
3. Press **5** jk **Phone Settings**.
4. Press **6** mno **Security**. You're prompted to enter the Phone Lock Code. The default lock code is the last four digits of your telephone number.
5. Enter the **Phone Lock Code**, and press the **Center Select** key (○). The Security menu appears.
6. Press **4** ghi **Lock Phone Now**.

Your phone returns to the main screen. The Phone Lock Code is required immediately to access any functions other than receive calls or make emergency calls.

Restrict Access to Location Menu

With the Location "Lock Setting" enabled, the Calls & Services Code is required to access the Phone Settings Location menu. This prevents anyone else from changing the Location setting on the Phone Settings menu.

1. From the main screen, press the **Center Select** key (○).
2. Use the Navigation wheel to highlight **Settings & Tools**  and press the **Center Select** key (○).
3. Press **5** jk **Phone Settings**.
4. Press **6** mno **Security**. You're prompted to enter the Phone Lock Code. The default Phone Lock Code is the last four digits of your telephone number.
5. Enter the **Phone Lock Code** then press the **Center Select** key (○). The Security menu appears.
6. Press **2** abc **Restrictions**.

7. Enter the **Calls & Services Code** then press the **Center Select** key (○). The default Phone Lock Code is the last four digits of your telephone number.
8. Press **1** **Location Setting**. The following options appear in the display:
 - **Lock Setting**: Restricts access to the Location menu.
 - **Unlock Setting**: Opens access to the Location menu.
9. Highlight **Lock Setting** and press the **Center Select** key (○).

Restrict Calls

You may restrict incoming and/or outgoing calls to allow calls from/to Contacts Only, or to Block All calls.





1. From the main screen, press the **Center Select** key (○).
2. Use the Navigation wheel to highlight **Settings & Tools**  and press the **Center Select** key (○).
3. Press **5** **Phone Settings**.
4. Press **6** **Security**. You're prompted to enter the Phone Lock Code. The default Phone Lock Code is the last four digits of your telephone number.
5. Enter the **Phone Lock Code**, then press the **Center Select** key (○). The Security menu appears.
6. Press **2** **Restrictions**.
7. Enter the **Calls & Services Code**, then press the **Center Select** key (○). The default Calls & Services Code is the last four digits of your telephone number.
8. Press **2** **Calls**.
9. Highlight one of the following and press the **Center Select** key (○) to select:
 - **Incoming Calls**: Select from Allow All, Contacts Only, or Block All.
 - **Outgoing Calls**: Select from Allow All, Contacts Only, or Block All.

Note: If Contacts Only is selected, the Contacts list cannot be modified until this setting is changed to Allow All.

Note: If Block All is selected for Outgoing Calls, only emergency calls may be made.



Restrict Messages





You may restrict incoming and/or outgoing messages to Block All messages.

1. From the main screen, press the **Center Select** key (○).
2. Use the Navigation wheel to highlight **Settings & Tools**  and press the **Center Select** key (○).
3. Press **5**  **Phone Settings**.
4. Press **6**  **Security**. You're prompted to enter the Phone Lock Code. The default Phone Lock Code is the last four digits of your telephone number.
5. Enter the **Phone Lock Code**, then press the **Center Select** key (○). The Security menu appears.
6. Press **2**  **Restrictions**.
7. Enter the **Calls & Services Code**, then press the **Center Select** key (○). The default Calls & Services Code is the last four digits of your telephone number.
8. Press **3**  **Messages**.
9. Highlight one of the following and press the **Center Select** key (○) to select:
 - **Incoming Messages**: Select Allow All or Block All.
 - **Outgoing Messages**: Select Allow All or Block All.

Edit Lock Codes

The default lock codes are the last four digits of your phone number. The **Edit Code** function allows you to change the Phone Lock Code or the Calls & Services Code to the code of your preference.











1. From the main screen, press the **Center Select** key (○).
2. Use the Navigation wheel to highlight **Settings & Tools**  and press the **Center Select** key (○).
3. Press **5**  **Phone Settings**.
4. Press **6**  **Security**. You're prompted to enter the Phone Lock Code. The default Phone Lock Code is the last four digits of your telephone number.
5. Enter the **Phone Lock Code** and press the **Center Select** key (○). The Security menu appears.

6. Press  **Edit Codes**. The following options display:
 - **Phone Only**: Allows you to edit the Phone Lock Code for only the handset.
 - **Calls & Services**: Allows you to edit the Phone Lock Code for all Calls & Services.
7. Highlight an option and press the **Center Select** key (). If you selected Calls and Services, you are prompted to “**ENTER CURRENT CODE**”. Enter the current Calls & Services Code, and press the **Center Select** key ().
8. At the “**ENTER NEW CODE**” prompt, enter the new Phone Lock Code and press the **Center Select** key ().
9. You're prompted to confirm the new Phone Lock Code.
10. At the “**RE-ENTER NEW CODE**” prompt, re-enter lock code and press the **Center Select** key ().
11. “**PHONE ONLY CODE SET**” or “**CALLS & SERVICE CODE SET**” message appears in the display confirming that your lock code was changed.

Note: Your phone does not allow you to view the lock code for obvious security reasons. If you change the lock code, be sure to write down or memorize the new code.

Restoring Your Phone

Restore Phone returns all setup options to their factory default.

1. From the main screen, press the **Center Select** key ().
2. Use the Navigation wheel to highlight **Settings & Tools**  and press the **Center Select** key ().
3. Press  **Phone Settings**.
4. Press  **Security**, enter the **Phone Lock Code** and press the **Center Select** key ().
5. Press  **Restore Phone**. A popup appears in the display asking if you wish to “**PERMANENTLY ERASE ALL USER DATA & RESET SETTINGS TO FACTORY DEFAULTS?**”
6. Highlight **Yes** and press the **Center Select** key (). A popup appears in the display, informing you to “**PRESS *228 SEND AFTER POWER CYCLE TO RE-PROGRAM PHONE**”.
7. Press the **Center Select** key (), you are prompted to “**ENTER PHONE LOCK CODE**”. Enter phone lock code, and press the **Center Select** key () to restore phone.

Important! After the phone power cycles back on, you must press *228 SEND to re-program your phone number.



Call Emergency Numbers in Lock Mode

In Phone Lock Mode, you can dial 911 or the contacts listed in your In Case of Emergency list to place an emergency call. (For more information, refer to "Emergency Contacts and Your In Case of Emergency List" on page 65.)

Note: If you dial 911, your phone dials the emergency number immediately (no prompt).

System Select

The **System Select** menu allows you to set your roaming options. For more information, refer to "Roaming Options" on page 32.

1. From the main screen, press the **Center Select** key (○).
 2. Use the Navigation wheel to highlight **Settings & Tools**  and press the **Center Select** key (○).
 3. Press  **Phone Settings**.
 4. Press  **System Select**. The following options may appear in the display:
 - **Home Only**
 - **Automatic, Automatic A, Automatic B** (at least one of these options will appear in the display)
-



Note: Contact your service provider for information regarding preferred systems.

Automatic settings are determined by the home location of the phone and the user's price plan.

5. Make your selection and press the **Center Select** key (○).

NAM Selection





Your phone provides the option of selecting between two NAMs (Number Assignment Modules) or phone numbers. Select either NAM1 or NAM2.

1. From the main screen, press the **Center Select** key (○).
2. Use the Navigation wheel to highlight **Settings & Tools**  and press the **Center Select** key (○).
3. Press  **Phone Settings**.
4. Press  **NAM Selection**. The following options appear in the display:

- **NAM Selection:** Choose either NAM1 or NAM2.
 - **Auto NAM Selection:** Choose either Enable or Disable.
5. Make your selection and press the **Center Select** key (○).

Quick Search

Quick Search is an easy way to locate contacts in your Address Book and Menu items.

1. From the main screen, press the **Center Select** key (○).
2. Use the Navigation wheel to highlight **Settings & Tools**  and press the **Center Select** key (○).
3. Press  **Phone Settings**.
4. Press  **Quick Search**.
5. Press the right soft key  **Info** to display detail information about **Quick Search**. Press the **Center Select** key (○) to return to Quick Search Menu.
6. Select **On** or **Off** and press the **Center Select** key (○).

Searching for a Contact

1. From the main screen, press the **first three** numeric keys that correspond to the letters of the contacts name.

For example, to search for “Sally” you would enter:

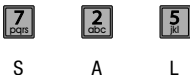

2. Press the up Navigation wheel to search for Contacts. If a match is found, the name(s) appear in the display.
3. Press the  key to call the contact.

Searching for a Menu Item

1. From the main screen, press the **first three** numeric keys that correspond to the letters of the Menu item name.

For example, to search for “Inbox” you would enter:

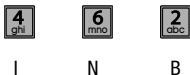







2. Use the Navigation wheel to search for Menu items. If a match is found, the menu item(s) appear in the display.
3. Press the **Center Select key** (●) to access the content of the menu item.

Call Settings

The **Call Settings** menu allows you to select the method for answering incoming calls, setting redial options, setting data options, voice privacy, and more.



Answer Options

The Answer Options menu allows you to select the method for answering incoming calls.

1. From the main screen, press the **Center Select key** (●).
2. Use the Navigation wheel to highlight **Settings & Tools**  and press the **Center Select key** (●).
3. Press  **Call Settings**.
4. Press  **Answer Options**. The following options appear in the display:
 - **Swivel Open**: Calls are answered when the swivel is opened.
 - **Any Key**: Calls are answered when any key is pressed except . If you press  it will ignore the call and send it to voicemail.
 - **Auto w/ Handsfree**: Calls are answered automatically with a 5 second delay.
5. Use the Navigation wheel to highlight the method you wish to use for answering calls, then press the **Center Select key** (●) **MARK**.
6. Press the right soft key  **Mark All** to select all options.
7. Press the left soft key  **Done**.

Auto Retry

Auto Retry automatically redials voice/data calls after a preset period of time.



1. From the main screen, press the **Center Select** key (○).
2. Use the Navigation wheel to highlight **Settings & Tools**  and press the **Center Select** key (○).
3. Press  **Call Settings**.
4. Press  **Auto Retry**. The following options appear in the display:
 - **Off**
 - **Every 10 Seconds**
 - **Every 30 Seconds**
 - **Every 60 Seconds**
5. Use the Navigation wheel to select an option and press the **Center Select** key (○).

TTY Mode

Before you can use your phone with a TTY device, you'll need to enable TTY functions in the phone. For more information, refer to "TTY" on page 33.

One Touch Dial

You can use this option to enable or disable the speed dialing feature.







1. From the main screen, press the **Center Select** key (○).
2. Use the Navigation wheel to highlight **Settings & Tools**  and press the **Center Select** key (○).
3. Press  **Call Settings**.
4. Press  **One Touch Dial**. Select **On** or **Off** and press the **Center Select** key (○).

For more information, refer to "Speed Dialing" on page 64.

Voice Privacy







Note: This feature is only available on the Verizon Wireless network.

Voice Privacy when enabled turns on advanced voice encryption. Voice privacy can be set to **On** or **Off**.

1. From the main screen, press the **Center Select** key (.
2. Use the Navigation wheel to highlight **Settings & Tools**  and press the **Center Select** key (.
3. Press  **Call Settings**.
4. Press  **Voice Privacy**. The following options appear in the display:
 - **On**
 - **Off**
5. Use the Navigation wheel to select an option and press the **Center Select** key (.

DTMF Tones

Use this menu to set DTMF settings to **Normal**, or **Long**.

1. From the main screen, press the **Center Select** key (.
2. Use the Navigation wheel to highlight **Settings & Tools**  and press the **Center Select** key (.
3. Press  **Call Settings**.
4. Press  **DTMF Tones**. The following options appear in the display:
 - **Normal**: Select for a normal tone.
 - **Long**: Select for an extended tone.
5. Use the Navigation wheel to select an option and press the **Center Select** key (.





Memory

The Memory menu allows you to view the memory usage for pictures, sounds, and ringtones on your phone.

1. From the main screen, press the **Center Select** key (○).
2. Use the Navigation wheel to highlight **Settings & Tools**  and press the **Center Select** key (○).
3. Press  **Memory**.
4. Press  **Phone Memory**. The following options are available:
 - **Memory Usage**: Displays the current memory usage and allocation figures for the various applications and folders stored on the phone. These include: Total Used, Available, My Pictures, My Ringtones, My Sounds, Applications, and Picture Msg.
 - **My Pictures**: Pictures you have saved from a Picture message, downloaded via the “Get It Now” application, or taken using your phone.
 - **My Ringtones**: Ringtones you have downloaded via the “Get It Now” application.
 - **My Sounds**: Sounds you have downloaded, recorded using your phone, or saved from a Picture message with Sound attached.
5. Press  **Music Memory** to view the **Available**, **Used** and **Total** memory usage for music files.

Phone Info

The **Phone Info** menu allows you to view the software and hardware information, your assigned number, and an icon glossary for your phone.

1. From the main screen, press the **Center Select** key (○).
2. Use the Navigation wheel to highlight **Settings & Tools**  and press the **Center Select** key (○).
3. Press  **Phone Info**.
4. **My Number** is highlighted. Press  **My Number** to display the Mobile Device and Identification numbers.
5. Press  **SW Version** to view the version of Software, PRL, ERI, Get it Now, MSUI, Hardware, and MEID on your phone.
6. Press  **Icon Glossary** to view the list of icons with a brief description.
7. Press the **Center Select** key (○) to return to the **Phone Info** menu.

Section 9: Music

Topics Covered

- My Music
 - Sync Music
-

This section explains how the Music Player functions.

My Music

Your Music Player can be used to play music files that you have transferred from your PC using V CAST Music Manager. Music can be played with the swivel open or closed. Your Juke Music Player can play music in the following Digital Audio Formats:

- AAC and AAC+
- WMA and WMA Pro
- MP3

Sync Music

Download music to your PC using V CAST Music Manager

1. Open V CAST Music Manager. Don't have V CAST Music Manager? Download it for free at www.verizonwireless.com/musicmanager.
2. Select the **Buy Music** tab.
3. Log in.
4. Go to **My Purchases**.
5. Songs that you've purchased but have not yet downloaded are indicated by an icon in the "d/l" column on the right-hand side of the song list.
6. Check the box(es) of songs you wish to download.
7. Select **Download**.
8. To play the song, you can find it by selecting the **Music On My PC** tab.

Note: V CAST Over The Air Music downloads are not available on the Juke. Music can be purchased and downloaded via V CAST Music Manager through your PC. V CAST Music will work with Windows XP, Windows Vista and Windows Media Player 10 or higher. Mac OS operating system is not supported.

Sync Music from your PC to your device using V CAST Music Manager

This option allows you to transfer music files from your PC. In order to use this option, you must load V CAST Music Manager on your PC.

1. Plug in the USB cable to your phone and connect it to a USB port on your PC.

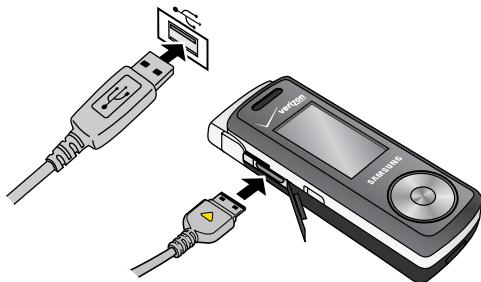

2. The Portable Device window display on your PC. Select **Synchronize your music using V CAST Music Manager** (🔴) icon and click **OK**.

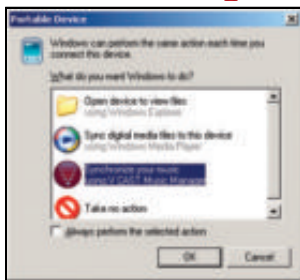

3. With V CAST Music Manager opened on your PC, click the **Sync List** button (⏮) on the bottom bar. Drag and drop your music selection(s).
4. Press the **Sync Now** button (▶).
5. When synchronization is complete, disconnect the USB cable. To return to the main screen, press the **End/Power** key (⏻).

Music Player

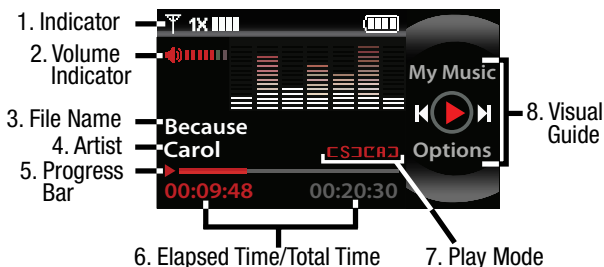

Music Player Icons



Sync Music: Indicates that music is being synchronized between your computer and your phone.



Paused: Indicates that music playback has been paused while phone is open and incoming call is received.



Play: Indicates that music is playing while the phone is open.



Shuffle: Indicates that music will play in a re-sorted playlist order.



Repeat One: Indicates the selected song will repeat.



Repeat All: Indicates all music in current playlist will repeat in list order.



Shuffle Repeat All: Indicates all music will repeat in a re-sorted playlist order.

Opening the Music Player

- With the swivel closed, press and hold the **Center Select** key ().

Using the Navigation Wheel and Center Select Key

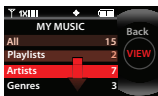

To scroll through My Music menus, Sub menus and Options, turn the Navigation Wheel clockwise to scroll down or counter clockwise to scroll up.

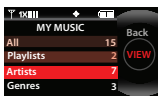

To view the highlighted menu selection, press the Center Select key **VIEW**.

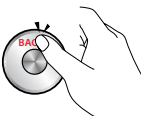
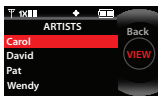

To move **Back** a menu item press the Navigation Wheel **Up**.

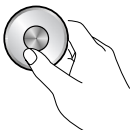
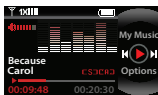

When playing music, press the Navigation Wheel Up, for **My Music** to return to Music Player home screen.

Press the Center Select key:

- To Play or Pause music.

Press the Navigation Wheel right:

- A long press to fast forward or rotate the Navigation Wheel clockwise to fast forward.
- A short press to move forward one complete song.

Press the Navigation Wheel left:

- A long press to rewind or rotate the Navigation Wheel counter clockwise to rewind.
- A short press to move back one complete song.

Press the Navigation Wheel down Options:

- To display additional options.



Operating the Music Player

1. With the phone's swivel closed and the Music Player opened, the following items may appear in the display:
 - **Resume:** Allows you to resume music playback at the point where music was last stopped.

Note: The Resume list is deleted when Music Sync is performed. You will have to make your music selection again.

- **All:** Allows you to view and play all of your songs in list order.
- **Playlists:** Any playlists that you have created are displayed in this option.
- **Artists:** Allows you to view and play your songs by artist.
- **Genres:** Allows you to view and play your songs by music type (genre). For example, Folk, Rock, Country, Classical, Soul, Unknown and so on. Each folder will contain all songs within that genre.
- **Albums:** Allows you to view and play your songs by album title. Even if you only have one song from an album, a folder for the album will display.

Note: The number listed outside the options denotes the number of item listed under the option.

2. Press the Navigation wheel up to go **Back** to the previous menu, or press the **Center Select** key () to **VIEW** the items listed under the option highlighted.
3. Rotate the Navigation wheel to highlight a category or song, and press the **Center Select** key () to **VIEW** your selection.
4. Once a song is highlighted (indicated by music notes to the left of the title), press the **Center Select** key () to **PLAY** the song.

Note: With the swivel open, your music will continue to play in the background and the Play icon () appears on the top line of the display.

Important! Music will pause when you receive an incoming call and the Pause icon () appears on the top line of the display. Music playback will resume when the call ends.

Note: Music will stop when you do any of the following:

Place an outgoing call
Launch an application (i.e., games, speech recognition)
Sync Music

Stopping the Music Player

Method 1 (Swivel Closed)

To stop the Music Player when the swivel is closed, and with the music player in operation, press and hold the **Center Select** key ().

Method 2 (Swivel Open)

To stop the Music Player when the swivel is opened, and with the music player in operation, press  from the main screen.



Music Player Options

While the Music Player screen is displaying, press the Navigation wheel down to see the following Options. Rotate the Navigation wheel left or right to scroll through the options, and press the **Center Select** key () to select it.

- **Play Mode:** Normal, Shuffle, Repeat One, Repeat All, Shuffle Repeat All.
- **Add To Playlist:** Add current playing song to playlist.
- **Skin:** Select Simple, Album Artwork, Visualizer, Lyrics.
- **Equalizer:** Select Basic, Rock, Jazz, Live, Classic, Full Bass, Full Bass and Treble, Dance, Pop, Full Treble, Club, Party, Large Hall, Soft, Soft Rock, User Setting.
- **3D Sound:** Select Wide, Dynamic, Surround, Off.
- **Backlight:** Select 15 Seconds, 30 Seconds, 1Minute.
- **Song Info:** Displays song information.
- **Memory Info:** Displays available, used and total memory for song storage.

Playlist

Creating a Playlist

1. With the swivel closed, from the main screen, press and hold the **Center Select** key (●). The Music Player is now active.
2. Rotate the Navigation wheel to highlight **Playlists** and press the **Center Select** key (●) **VIEW**.
3. Press the Navigation wheel down to open **Options**.
4. **Add New Playlist** is highlighted, press the **Center Select** key (●). The **OPEN PHONE TO CONTINUE** pop up displays.
5. Open the swivel, and use the alphanumeric keypad to enter a name for your playlist and press the **Center Select** key (●). Press  to remove unwanted text.
6. Press the left soft  key to change Text Entry mode.
7. Close the swivel to view your new playlist.

Adding a Song to a Playlist

1. With the swivel closed, from the main screen, press and hold the **Center Select** key (●). The Music Player is now active.
2. Rotate the Navigation wheel to highlight **All** and press the **Center Select** key (●) to **VIEW** the songs.
3. With **Play All Songs** highlighted, press down on the Navigation wheel to open **Options**.
4. Highlight **Add To Playlist** and press the **Center Select** key (●).
5. To select all songs- highlight **Mark All** and press the **Center Select** key (●). A check mark displays beside each song.
-or-
To select a specific song - use the Navigation wheel to highlight the song and press the **Center Select** key (●). A check mark displays beside the selected song.
6. Press the Navigation wheel down when **Done**.
7. Rotate the Navigation wheel to highlight the name of the Playlist to which you wish to add the song, and press the **Center Select** key (●).

Changing Song Order in a Playlist

1. With the swivel closed, from the main screen, press and hold the **Center Select** key (●). The Music Player is now active.
2. Rotate the Navigation wheel to highlight **Playlists** and press the **Center Select** key (●).
3. Highlight a **Playlist**.
4. Press down on the Navigation wheel to open **Options**.
5. Highlight **View** and press the **Center Select** key (●).
6. Press down on the Navigation wheel to open **Options**.
7. Highlight **Reorder** and press the **Center Select** key (●).
8. Highlight the song you would like to move and press the **Center Select** key (●). A checkmark displays.
9. Press Navigation wheel up to move the selection up in the song order or press the Navigation wheel down to move the selection down in the song order.
10. Press the **Center Select** key (●) when **Done**.
11. Repeat step 6-10 if needed.

Deleting a Playlist

1. With the swivel closed, from the main screen, press and hold the **Center Select** key (●). The Music Player is now active.
2. Rotate the Navigation wheel to highlight **Playlists** and press the **Center Select** key (●) **VIEW**.
3. Highlight the name of the playlist to be deleted and Press down on the Navigation wheel to open **Options**.
4. Highlight **Remove** and press the **Center Select** key (●). The **Remove** popup displays.
5. With **Yes** highlighted, press the **Center Select** key (●) to confirm the removal of the playlist.
-or-
Rotate the Navigation wheel to highlight **No** to cancel and press the **Center Select** key (●).

Note: Only the Playlist is deleted. But the songs will not be deleted from the Music Player.

Deleting Songs from the Music Player

1. Plug in the USB cable to your phone and connect it to a USB port on your PC.

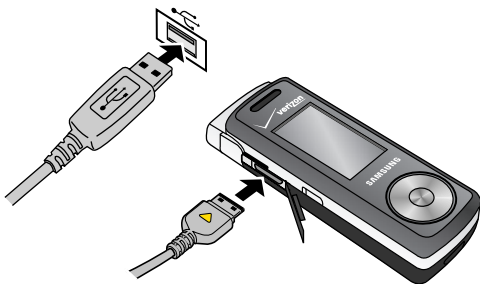

2. The Portable Device window display on your PC. Select **Synchronize your music using V CAST Music Manager** () icon and click **OK**.

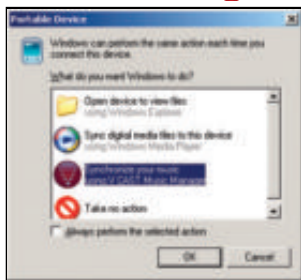

3. With the V CAST Music Manager opened on your PC, click the **Music on My Phone** tab.
4. Right click on the song title, and select **Delete**.
5. You will be prompted **“Are you sure that you want to delete ...?”**
6. Click **OK**, the song will be deleted from the Music Player.
7. When finished, remove the USB cable.

Section 10: Get It Now











Topics Covered

- Get It Now
 - Tune & Tones
 - Pictures
 - Games
 - Tool on the Go
 - Extras
-

This section describes how to receive tones, and images. It also outlines how to take and store images, sounds, and ringtones using your phone.

Get It Now

The Get It Now menu provides sub-menus to Tunes & Tones, Pictures, Games, Tools on the Go and Extras. You can also view memory info to see how much space you've used (and have left) for stored media. Use the following steps for each **GET IT NOW** sub-menu.





1. From the main screen, use the Navigation wheel to access the **GET IT NOW**  menu.
2. Press the right soft key  **Info**.
3. Press  **App. Memory** to display the memory available. Press the  key to return.
4. Press  **Phone Memory** to view the internal memory availability. Press the  key to return.
5. Press  **View Log** to see the file transfer activity.
6. Press the  key to return.
7. Press  **Help** to display a list of frequently asked questions. Use the Navigation wheel to highlight an item and press the **Center Select** key () to display help text.
8. Press the  key to return.

Tunes & Tones





This menu allows you to get new tunes and tones, record new sounds, and set tunes and tones as your ringtone.

Get New Ringtones

You can use this option to download new ringtones from the Internet.

1. From the main screen, use the Navigation wheel to access the **GET IT NOW**  menu.
2. Press  **Tunes & Tones**.
3. Press  **Get New Ringtones**.
4. Press  **Get New Applications**.
5. You are connected to the Get It Now store and presented with available provider ringtone applications.
6. To return to the main screen, press .









My Ringtones

1. From the main screen, use the Navigation wheel to access the **GET IT NOW**  menu.
2. Press  **Tunes & Tones**.
3. Press  **My Ringtones**.
4. Use the Navigation wheel to highlight a ringtone.
5. Press the **Center Select** key () to **Play** the highlighted ringtone.
6. Press the left soft key  **Set As** to set the ringtone as a Ringtone, Contact ID, or Alert Tones.

Press the right soft key  **Info** to view detailed information about the ringtone.

7. To return to the main screen, press .





My Sounds

1. From the main screen, use the Navigation wheel to access the **GET IT NOW**  menu.
2. Press  **Tunes & Tones.**
3. Press  **My Sounds.**
4. **Record New** is highlighted. Press the **Center Select** key () to launch the **RECORD NEW** screen.
5. Press the left soft key () **RecMode** to select a recording mode and press the **Center Select** key (). Select one of the following:
 - **Limit for Pic Msg:** Records a 60 sec message.
 - **Normal:** Records for an extended message.
6. Press the **Center Select** key () **REC** to begin recording. Press the left soft key () **Pause** to pause and resume the recording appropriately.
7. Press the **Center Select** key () **STOP** to stop and save the message automatically to My Sounds.

Pictures







This menu allows you to get new Pictures via the Get It Now store or take new Pictures using your phone's camera. You can also view the saved pictures.

Get New Pictures

1. From the main screen, use the Navigation wheel to access the **GET IT NOW**  menu.
2. Press  **Pictures.**
3. Press  **Get New Picture.**
4. Press  **Get New Applications.** Follow the on-screen prompts.

My Pictures

My Pictures allows you to review the pictures taken with the camera feature or downloaded and stored into your phone.



- From the main screen, use the Navigation wheel to access the **GET IT NOW**  menu.
- Press  **Pictures**.
- Press  **My Pictures**.
- Use the Navigation wheel to select a photo, and press the **Center Select** key () **VIEW** to view the highlighted picture. Press the left soft key  **Erase** to erase the highlighted image. Press the right soft key  **Options** to select from the following options:
 - Send**: Launches the Create Picture Message screen.
 - Set As**: Set the picture as the Wallpaper, or Picture ID.
 - To PIX Place**: Sends picture to PIX Place
 - Take Picture**: Activates the camera.
 - Get New Picture**: Allows you to get pictures from **Get New Applications**.
 - Slide Show**: Allows you to view in a series of pictures.
 - Edit**: Allows you to edit the photo.
 - Rename**: Allows you to rename the picture.
 - Lock/Unlock**: Locks the picture to prevent deletion.
 - Erase Files**: Allows you to erase pictures.
 - File Info**: Provides the file name, date, time, resolution, size and rights to the selected picture.
- Use the Navigation wheel to make your selection and press the **Center Select** key ().

Take Picture

This menu launches the camera.

- From the main screen, use the Navigation wheel to access the **GET IT NOW**  menu.





Tip: Alternatively to launch the camera, press Camera Key ().

- Press  **Pictures**.
- Press  **Take Picture**. The camera is now active.

4. Press the right soft key  **Options**, to choose the specific camera settings. Use the Navigation wheel to highlight the desired setting category, and press the **Center Select** key (). Use the Navigation wheel to make selections within each category. The following categories are available:
 - **Resolution**: Select High (640X480), Med (320X240), Low (160X120)
 - **Night Shot**: Select On or Off.
 - **Self Timer**: Select Off, 5 Sec., 10 Sec.
 - **White Balance**: Select Auto, Sunny, Cloudy, Tungsten, or Fluorescent.
 - **Quality**: Select Economy, Normal, Fine
 - **Ready Sound**: Select Off, Say Cheese!, Look Here!, 1, 2, 3!
 - **Shutter Sound**: Select Shutter, Okay, Chime or No Sound.
 - **Color Effects**: Select Normal, Black&White, Sepia, Negative, Emboss, Green, or Aqua.
 - **Preview Mode**: Select Full Screen or Standard Screen
5. Press the **Center Select** key () **TAKE** to capture a picture.
 - Press the **Center Select** key () **SEND** to create a New Picture Message
 - Press the right soft key  **Erase** to delete the picture.
 - Press the left soft key  **Save** to save the picture to the galley.
6. To exit the camera, press  .





Games

Select from several fun and interesting applications or a broad category of games that you can play on your phone.

1. From the main screen, use the Navigation wheel to access the **GET IT NOW**  menu.
2. Press  **Games**.
3. Press  **Get New Applications**.
4. Use the Navigation wheel to make a selection and press the **Center Select** key ().
5. Choose the charge Either Subscription or Unlimited, then press the **Center Select** key (). Follow in screen prompts to apply.





Tools on the Go

Download applications that keep you in touch with the world, keep you organized, and help you find the coolest spots.

1. From the main screen, use the Navigation wheel to access the **GET IT NOW**  menu.
2. Press  **Tools on the Go**.
3. **Get New Applications** is highlighted. Press the **Center Select** key ().
4. Highlight the application you wish to download and press the **Center Select** key ().
5. Follow on screen subscription prompts and press the **Center Select** key (). The download process begins.
6. At the “App installed successfully. Would you like to run it?” prompt, press **Yes** to launch application, or **No** to return to category list.

Note: The Tools on the Go menu will display all downloaded applications, with the most current download first.

Extras

1. From the main screen, use the Navigation wheel to access the **GET IT NOW**  menu.
2. Press  **Extras**.
3. **Get New Applications** is highlighted.
4. Press the **Center Select** key ().
5. Highlight the application you wish to download and press the **Center Select** key ().
6. Follow on screen subscription prompts and press the **Center Select** key (). The download process begins.
7. At the “App installed successfully. Would you like to run it?” prompt, press **Yes** to launch application, or **No** to return to category list.

Section 11: Tools

Topics Covered

- Voice Commands
 - Calculator
 - Calendar
 - Alarm Clock
 - Stop Watch
 - World Clock
 - Notepad
-











The topics covered in this section allow you to schedule appointments, view the calendar, set an alarm, view time zones, take notes, and perform simple math calculations

Voice Commands

For more information, refer to "Voice Commands" on page 34.

Calculator







You can perform calculations, including addition, subtraction, multiplication and division using your phone.

1. From the Main screen, press the **Center Select** key () **MENU**.
2. Use the Navigation wheel to highlight **Settings & Tools**  and then press the **Center Select** key ().
3. Press  **Tools**,  **Calculator**,  **Normal**. The Calculator opens.
4. Enter the first number in your equation using the keypad. (Numbers can be up to nine digits long.)
5. Press the right soft key  **Operator** to display a pop-up menu which allows you to enter a Parenthesis or Power if desired.
6. Press the left soft key  **Clear** to clear all data entered or press  to delete one character at a time.
7. Press  to change the sign for a number to a negative.
8. Press the  to add a decimal point.

- Use the navigation directional keys to set the type of calculation that you wish to perform. Your choices are as follows:
 - Up key:** [+] Addition
 - Down key:** [-] Subtraction
 - Right key:** [x] Multiplication
 - Left key:** [÷] Division
- Use the keypad to enter the second number into your equation.
- Press the **Center Select** key () to perform the calculation and view the result.

Tip

Calculates the tip and determine how much each person should pay for the meal.

- From the Main screen, press the **Center Select** key () **MENU**.
- Use the Navigation wheel to highlight **Settings & Tools**  and then press the **Center Select** key () .
- Press  **Tools**,  **Calculator**,  **Tip**. The **Tip Calculator** opens.
- Populate the following fields:
 - Bill:** enter the amount of the bill.
 - Tip:** enter the tip percentage.
 - # Paying:** enter the amount of people paying.



Note: Press the  key to enter a decimal point.





- In the section below, the calculator will automatically display the Tip, total bill including the tip, and the share of the bill for each person.



Converter

The **Converter** menu provides the following conversion categories:

- Temperature
- Length
- Weight
- Area
- Volume
- Currency

- From the Main screen, press the **Center Select** key () **MENU**.
- Use the Navigation wheel to highlight **Settings & Tools**  and then press the **Center Select** key () .

- Press  **Tools**,  **Calculator**,  **Converter**.
- Scroll to the conversion feature you wish to use and press the **Center Select** key ().
- Use the Navigation wheel to select the **From units of money or measure for the quantity** you want converted.
- Enter the quantity you want converted in the text box.





Note: Press the  key to enter a decimal point. Press  to change the sign for a number to a negative.

Use the Navigation wheel to select the **To units of money or measure** for the quantity you want converted.

Calendar

Schedule up to eight events for any day by indicating each event's start and end time. Set alarms for events so that you can be alerted before an event takes place. Events scheduled for future dates automatically appear on your Today events schedule for the present day.

Add a new event





- From the Main screen, press the **Center Select** key ( **MENU**).
- Use the Navigation wheel to highlight **Settings & Tools**  and then press the **Center Select** key ().
- Press  **Tools**,  **Calendar**. A calendar appears in the display with the current date highlighted.

Note: From the main screen, press the Navigation wheel down to access the Calendar. The calendar appears in the display with the current date highlighted. If you change the shortcut to another function, then proceed with the first two steps.





- To view available options, press the right soft key  **Options**. A pop-up menu appears in the display that contains the menu items.
 - Go To Date:** Go to any date that you specify.
 - Go to Today:** Go to today on monthly calendar.
 - Erase Old:** Select a past event to delete.
 - Erase All:** Delete all events in your calendar
- Press the left soft key  **Add** to add a new event.









6. The **Appointment name** field is highlighted. Enter the name and press the Navigation wheel down to move to the following fields:
 - **Start Date:** Enter the start date for the event.
 - **Start Time:** Enter the start time for the event.
 - am/pm: Select from am or pm for the start time.
 - **End Date:** Enter the end date for the event.
 - **End Time:** Enter the end time for the event.
 - am/pm: Select from am or pm for the end time.
 - **Recurrence:** Select the frequency of the event.
 - **Alert:** Sets the alarm for the event. Select from Tone, Vibrate, or Light Only.
 - **Reminder:** Set a reminder before the event. Select Off, Once, Every 2 Minutes, Every 15 Minutes.
 - **Alert Time:** Set the Alert Time to sound before the event takes place.
7. Fill in and select event details using the Navigation wheel and the alphanumeric keypad.
8. Press the **Center Select** key () . The event is saved.

View an event

1. From the Main screen, press the **Center Select** key () **MENU**.
2. Use the Navigation wheel to highlight **Settings & Tools**  and then press the **Center Select** key () .
3. Press  **Tools**,  **Calendar**. A calendar appears in the display with the current date highlighted.

Note: From the main screen, press the Navigation wheel down to access the Calendar. The calendar appears in the display with the current date highlighted. If you change the shortcut to another function, then proceed with the first two steps.







4. If you want to view events for a date other than today, press the right soft key  **Options**.
 - In the pop-up menu that appears in the display, use the Navigation wheel to highlight Go To Date, then press the **Center Select** key () .
 - Enter the desired date in the box, then press the **Center Select** key () . The monthly calendar for the date that you entered appears in the display with the event date highlighted.
5. Press the **Center Select** key () **VIEW** to view event.
6. Press the **Center Select** key () **VIEW** to view event details for the date.

7. To edit the event being viewed, press the left soft key  **Edit**. Use the Navigation wheel to highlight the field(s) that needs to be edited. Make changes, then press the **Center Select** key () **SAVE**.
8. Press the right soft key  **Options**. A pop-up menu appears in the display.
 - To see the selected date in a month view, press  **Monthly**.
 - To erase the current event, press  **Erase**. A pop-up menu appears with **Yes** highlighted. press the **Center Select** key () to erase, or highlight **No** to cancel and press the **Center Select** key ()
 - To erase all calendar events, press  **Erase All**. In the pop-up menu that appears, highlight **Yes** to erase all events, or highlight **No** to cancel and return to the calendar, and press the **Center Select** key ()

Alarm Clock









Your phone has an alarm clock that can be set to go off once, or recur daily at a specific time. Once set, the alarm clock is easy to change or turn off.

Set An Alarm

1. From the Main screen, press the **Center Select** key () **MENU**.
2. Use the Navigation wheel to highlight **Settings & Tools**  and then press the **Center Select** key ()
3. Press  **Tools**,  **Alarm Clock**. The **Alarm Clock** menu displays with the **Alarm 1** highlighted.
4. The following options appear in the display:
 - **Alarm 1**
 - **Alarm 2**
 - **Alarm 3**
5. Use the Navigation wheel to highlight the alarm that you wish to enable, then press the **Center Select** key ()
6. The Alarm field is highlighted. Use the Navigation wheel to select **On** or **Off**.
7. Use the Navigation wheel to highlight the **Time** field, then enter the time that you wish for the alarm to sound.
8. Use the Navigation wheel to highlight the am/pm field and to select **am** or **pm**.

9. Use the Navigation wheel to highlight the **Frequency** field and to set the frequency (occurrence) of the alarm. Below lists and defines the options for this field.
 - **Once**: The alarm sounds only once, at the time specified.
 - **Daily**: The alarm sounds every day at the time specified.
 - **Mon-Fri**: The alarm sounds Monday through Friday at the time specified.
 - **Weekends**: The alarm sounds Saturday through Sunday at the time specified.
10. Use the Navigation wheel to highlight the first **Ringer** field and to set the ringer to Tone, Vibrate, or Light Only.
11. If you selected Tone, use the Navigation wheel to highlight the second field to set the alert tone to VZW Default Tone, or select a tone from Alert Tone.
12. When all fields have correct information entered, press the **Center Select** key () **SAVE** to save your settings.

Disable an alarm before it sounds

1. From the Main screen, press the **Center Select** key () **MENU**.
2. Use the Navigation wheel to highlight **Settings & Tools**  and then press the **Center Select** key ().
3. Press  **Tools**,  **Alarm Clock**. The **Alarm Clock** menu displays with the **Alarm 1** highlighted.
4. Use the Navigation wheel to highlight the alarm you wish to disable, then press the right soft key  **Options**. A pop-up menu appears in the display.
5. Press  **Turn Off** to turn the highlighted alarm off. Press  **Reset** to reset the highlighted alarm or press  **Reset All** to reset all of the alarms.

Snooze





When an alarm sounds, a menu screen displays that allows you to either turn the alarm off or to have the alarm ring again after 5 minutes. This is called Snooze.

To use this feature follow these steps:

1. Set one of your phone's 3 alarms. For more information, refer to "Set An Alarm" on page 126.
2. When an alarm sounds, press Navigation wheel up or down to highlight **Snooze** or **Dismiss**. To snooze, highlight **Snooze** and press the **Center Select** key (○) to set it to ring again after 5 minutes. Or, highlight **Dismiss** to turn the alarm off completely. The alarm turns off and the main screen displays.









Stop Watch

This feature allows you to use a stop watch. Press the **Center Select** key (○) **START** to start the stop watch. Press the **Center Select** key (○) **STOP** to stop the stop watch. Press the right soft key  **Reset** to erase recorded stop watch time.

1. From the Main screen, press the **Center Select** key (○) **MENU**.
2. Use the Navigation wheel to highlight **Settings & Tools**  and then press the **Center Select** key (○).
3. Press  **Tools**,  **Stop Watch**. The **Stop Watch** appears in the display.
4. Press the **Center Select** key (○) **START** to start the stop watch.
5. Press the left soft key  **Record** to record split times.
6. Press the **Center Select** key (○) **STOP** to stop the stop watch.
7. Press the right soft key  **Reset** to erase recorded stop watch time.







World Clock

World Clock allows you to view the time of day or night in any part of the world.

1. From the Main screen, press the **Center Select** key ( **MENU**).
2. Use the Navigation wheel to highlight **Settings & Tools**  and then press the **Center Select** key ().
3. Press  **Tools**,  **World Clock**.
4. Use the left soft key  **Cities** to display the 45 supported cities. Press the **Center Select** key () to see that city's current time.
5. Press the right soft key  **Options** to view the following options:
 - **Set As Local Time**: Sets the time according to the city chosen in the Cities field.
 - **DST On**: Sets the Daylight Savings time option.
6. You can scroll through other cities by pressing the Navigation wheel.
7. To return to the main screen, press .



Notepad

Create and store notes in Notepad. Return to Notepad anytime to review and edit your notes.









1. From the Main screen, press the **Center Select** key ( **MENU**).
2. Use the Navigation wheel to highlight **Settings & Tools**  and then press the **Center Select** key ().
3. Press  **Tools**,  **Notepad**.
4. If you have any stored notes, they appear as a list in the display. If this is your first time in Notepad, **No Notes** displays.
5. To add a new note, press the left soft key  **Add**, then enter the note using the keypad.
6. While entering a note, press the left soft key  **Abc**, to display a pop-up menu with the following text entry modes
 - **Word**
 - **Abc**
 - **ABC**
 - **123**
 - **Symbols**

Tip: Press and hold * () to cycle through text entry mode types (word, Abc, and 123).

Press * () to cycle between lower case, all caps, and initial caps.

- Use the Navigation wheel to select a text entry modes and press the **Center Select** key () or press  to exit the pop-up menu.
- When you're finished entering details for the note, press the **Center Select** key (). The note is saved.

Review, Edit, and Erase Notes

- From the Main screen, press the **Center Select** key () **MENU**.
- Use the Navigation wheel to highlight **Settings & Tools**  and then press the **Center Select** key () .
- Press  **Tools**,  **Notepad**. The **Notepad** menu opens. If you have any stored notes, they appear as a list in the display.
- With a note highlighted, press the right soft key  **Options**. A pop-up menu with the options listed in the following table appears in the display:
 - Edit**: Edit the note currently highlighted or appearing in the display.
 - Erase**: Erase the note currently highlighted or appearing in the display.
 - Erase Notes**: Erase notes marked with a checkmark.
 - Lock/Unlock**: Locks or unlocks the entry to prevent accidental deletion.
- Use the Navigation wheel to highlight an option or press  to exit the pop-up menu.
- Press the **Center Select** key () to perform the highlighted option's function.

Section 12: Health and Safety Information

Topics Covered

- Health and Safety Information
- Samsung Mobile Products and Recycling
- UL Certified Travel Adapter
- Consumer Information on Wireless Phones
- Road Safety
- Responsible Listening
- Operating Environment
- Using Your Phone Near Other Electronic Devices
- Potentially Explosive Environments
- Emergency Calls
- FCC Notice and Cautions
- Other Important Safety Information
- Product Performance
- Availability of Various Features/Ring Tones
- Battery Standby and Talk Time
- Battery Precautions
- Care and Maintenance

This section outlines the safety precautions associated with using your phone. These safety precautions should be followed to safely use your phone.

Health and Safety Information

Exposure to Radio Frequency (RF) Signals

Certification Information (SAR)

Your wireless phone is a radio transmitter and receiver. It is designed and manufactured not to exceed the exposure limits for radio frequency (RF) energy set by the Federal Communications Commission (FCC) of the U.S. government.

These FCC exposure limits are derived from the recommendations of two expert organizations, the National Council on Radiation Protection and Measurement (NCRP) and the Institute of Electrical and Electronics Engineers (IEEE).

In both cases, the recommendations were developed by scientific and engineering experts drawn from industry, government, and academia after extensive reviews of the scientific literature related to the biological effects of RF energy.

The exposure limit set by the FCC for wireless mobile phones employs a unit of measurement known as the Specific Absorption Rate (SAR). The SAR is a measure of the rate of absorption of RF energy by the human body expressed in units of watts per kilogram (W/kg). The FCC requires wireless phones to comply with a safety limit of 1.6 watts per kilogram (1.6 W/kg). The FCC exposure limit incorporates a substantial margin of safety to give additional protection to the public and to account for any variations in measurements.

SAR tests are conducted using standard operating positions accepted by the FCC with the phone transmitting at its highest certified power level in all tested frequency bands. Although the SAR is determined at the highest certified power level, the actual SAR level of the phone while operating can be well below the maximum value. This is because the phone is designed to operate at multiple power levels so as to use only the power required to reach the network. In general, the closer you are to a wireless base station antenna, the lower the power output.

Before a new model phone is available for sale to the public, it must be tested and certified to the FCC that it does not exceed the exposure limit established by the FCC. Tests for each model phone are performed in positions and locations (e.g. at the ear and worn on the body) as required by the FCC. For body worn operation, this phone has been tested and meets FCC RF exposure guidelines when used with an accessory that contains no metal and that positions the handset a minimum of 1.5 cm from the body. Use of other accessories may not ensure compliance with FCC RF exposure guidelines.

The FCC has granted an Equipment Authorization for this mobile phone with all reported SAR levels evaluated as in compliance with the FCC RF exposure guidelines. The maximum SAR values for this model phone as reported to the FCC are:

- Head: 1.31 W/kg.
- Body-worn: 0.558 W/kg.

SAR information on this and other model phones can be viewed on-line at <http://www.fcc.gov/oet/ea>. To find information that pertains to a particular model phone, this site uses the phone FCC ID number which is usually printed somewhere on the case of the phone.

Sometimes it may be necessary to remove the battery pack to find the number. Once you have the FCC ID number for a particular phone, follow the instructions on the website and it should provide values for typical or maximum SAR for a particular phone. Additional product specific SAR information can also be obtained at www.fcc.gov/cgb/sar.

Samsung Mobile Products and Recycling

Samsung cares for the environment and encourages its customers to recycle Samsung mobile phones and genuine Samsung accessories.

Go to: <http://www.samsung.com/us/consumer/type/type.do?group=mobilephones&type=mobilephones> for more information.

UL Certified Travel Adapter

The Travel Adapter for this phone has met applicable UL safety requirements. Please adhere to the following safety instructions per UL guidelines.

FAILURE TO FOLLOW THE INSTRUCTIONS OUTLINED MAY LEAD TO SERIOUS PERSONAL INJURY AND POSSIBLE PROPERTY DAMAGE

IMPORTANT SAFETY INSTRUCTIONS - SAVE THESE INSTRUCTIONS.

DANGER - TO REDUCE THE RISK OF FIRE OR ELECTRIC SHOCK, CAREFULLY FOLLOW THESE INSTRUCTIONS.

FOR CONNECTION TO A SUPPLY NOT IN NORTH AMERICA, USE AN ATTACHMENT PLUG ADAPTOR OF THE PROPER CONFIGURATION FOR THE POWER OUTLET. THIS POWER UNIT IS INTENDED TO BE CORRECTLY ORIENTATED IN A VERTICAL OR HORIZONTAL OR FLOOR MOUNT POSITION.

Consumer Information on Wireless Phones

The U.S. Food and Drug Administration (FDA) has published a series of Questions and Answers for consumers relating to radio frequency (RF) exposure from wireless phones. The FDA publication includes the following information:

What kinds of phones are the subject of this update?

The term wireless phone refers here to hand-held wireless phones with built-in antennas, often called "cell," "mobile," or "PCS" phones. These types of wireless phones can expose the user to measurable radio frequency energy (RF) because of the short distance between the phone and the user's head. These RF exposures are limited by Federal Communications Commission safety guidelines that were developed with the advice of FDA and other federal health and safety agencies.

When the phone is located at greater distances from the user, the exposure to RF is drastically lower because a person's RF exposure decreases rapidly with increasing distance from the source. The so-called "cordless phones," which have a base unit connected to the telephone wiring in a house, typically operate at far lower power levels, and thus produce RF exposures well within the FCC's compliance limits.

Do wireless phones pose a health hazard?

The available scientific evidence does not show that any health problems are associated with using wireless phones. There is no proof, however, that wireless phones are absolutely safe. Wireless phones emit low levels of radio frequency energy (RF) in the microwave range while being used. They also emit very low levels of RF when in the stand-by mode. Whereas high levels of RF can produce health effects (by heating tissue), exposure to low level RF that does not produce heating effects causes no known adverse health effects. Many studies of low level RF exposures have not found any biological effects. Some studies have suggested that some biological effects may occur, but such findings have not been confirmed by additional research. In some cases, other researchers have had difficulty in reproducing those studies, or in determining the reasons for inconsistent results.

What is FDA's role concerning the safety of wireless phones?

Under the law, FDA does not review the safety of radiation-emitting consumer products such as wireless phones before they can be sold, as it does with new drugs or medical devices. However, the agency has authority to take action if wireless phones are shown to emit radio frequency energy (RF) at a level that is hazardous to the user. In such a case, FDA could require the manufacturers of wireless phones to notify users of the health hazard and to repair, replace or recall the phones so that the hazard no longer exists.

Although the existing scientific data do not justify FDA regulatory actions, FDA has urged the wireless phone industry to take a number of steps, including the following:

- Support needed research into possible biological effects of RF of the type emitted by wireless phones;
- Design wireless phones in a way that minimizes any RF exposure to the user that is not necessary for device function; and
- Cooperate in providing users of wireless phones with the best possible information on possible effects of wireless phone use on human health.

FDA belongs to an interagency working group of the federal agencies that have responsibility for different aspects of RF safety to ensure coordinated efforts at the federal level. The following agencies belong to this working group:

- National Institute for Occupational Safety and Health
- Environmental Protection Agency
- Federal Communications Commission
- Occupational Safety and Health Administration
- National Telecommunications and Information Administration

The National Institutes of Health participates in some interagency working group activities, as well.

FDA shares regulatory responsibilities for wireless phones with the Federal Communications Commission (FCC). All phones that are sold in the United States must comply with FCC safety guidelines that limit RF exposure. FCC relies on FDA and other health agencies for safety questions about wireless phones.

FCC also regulates the base stations that the wireless phone networks rely upon. While these base stations operate at higher power than do the wireless phones themselves, the RF exposures that people get from these base stations are typically thousands of times lower than those they can get from wireless phones. Base stations are thus not the primary subject of the safety questions discussed in this document.

What are the results of the research done already?

The research done thus far has produced conflicting results, and many studies have suffered from flaws in their research methods. Animal experiments investigating the effects of radio frequency energy (RF) exposures characteristic of wireless phones have yielded conflicting results that often cannot be repeated in other laboratories. A few animal studies, however, have suggested that low levels of RF could accelerate the development of cancer in laboratory animals. However, many of the studies that showed increased tumor development used animals that had been genetically engineered or treated with cancer-causing chemicals so as to be pre-disposed to develop cancer in absence of RF exposure. Other studies exposed the animals to RF for up to 22 hours per day. These conditions are not similar to the conditions under which people use wireless phones, so we don't know with certainty what the results of such studies mean for human health.

Three large epidemiology studies have been published since December 2000. Between them, the studies investigated any possible association between the use of wireless phones and primary brain cancer, glioma, meningioma, or acoustic neuroma, tumors of the brain or salivary gland, leukemia, or other cancers. None of the studies demonstrated the existence of any harmful health effects from wireless phones RF exposures. However, none of the studies can answer questions about long-term exposures, since the average period of phone use in these studies was around three years.

What research is needed to decide whether RF exposure from wireless phones poses a health risk?

A combination of laboratory studies and epidemiological studies of people actually using wireless phones would provide some of the data that are needed. Lifetime animal exposure studies could be completed in a few years. However, very large numbers of animals would be needed to provide reliable proof of a cancer promoting effect if one exists. Epidemiological studies can provide data that is directly applicable to human populations, but ten or more years' follow-up may be needed to provide answers about some health effects, such as cancer. This is because the interval between the time of exposure to a cancer-causing agent and the time tumors develop - if they do - may be many, many years. The interpretation of epidemiological studies is hampered by difficulties in measuring actual RF exposure during day-to-day use of wireless phones. Many factors affect this measurement, such as the angle at which the phone is held, or which model of phone is used.

What is FDA doing to find out more about the possible health effects of wireless phone RF?

FDA is working with the U.S. National Toxicology Program and with groups of investigators around the world to ensure that high priority animal studies are conducted to address important questions about the effects of exposure to radio frequency energy (RF).

FDA has been a leading participant in the World Health Organization international Electromagnetic Fields (EMF) Project since its inception in 1996. An influential result of this work has been the development of a detailed agenda of research needs that has driven the establishment of new research programs around the world. The Project has also helped develop a series of public information documents on EMF issues.

FDA and Cellular Telecommunications & Internet Association (CTIA) have a formal Cooperative Research and Development Agreement (CRADA) to do research on wireless phone safety. FDA provides the scientific oversight, obtaining input from experts in government, industry, and academic organizations. CTIA-funded research is conducted through contracts to independent investigators. The initial research will include both laboratory studies and studies of wireless phone users. The CRADA will also include a broad assessment of additional research needs in the context of the latest research developments around the world.

What steps can I take to reduce my exposure to radio frequency energy from my wireless phone?

If there is a risk from these products - and at this point we do not know that there is - it is probably very small. But if you are concerned about avoiding even potential risks, you can take a few simple steps to minimize your exposure to radio frequency energy (RF). Since time is a key factor in how much exposure a person receives, reducing the amount of time spent using a wireless phone will reduce RF exposure.

- If you must conduct extended conversations by wireless phone every day, you could place more distance between your body and the source of the RF, since the exposure level drops off dramatically with distance. For example, you could use a headset and carry the wireless phone away from your body or use a wireless phone connected to a remote antenna.

Again, the scientific data do not demonstrate that wireless phones are harmful. But if you are concerned about the RF exposure from these products, you can use measures like those described above to reduce your RF exposure from wireless phone use.

What about children using wireless phones?

The scientific evidence does not show a danger to users of wireless phones, including children and teenagers. If you want to take steps to lower exposure to radio frequency energy (RF), the measures described above would apply to children and teenagers using wireless phones. Reducing the time of wireless phone use and increasing the distance between the user and the RF source will reduce RF exposure.

Some groups sponsored by other national governments have advised that children be discouraged from using wireless phones at all. For example, the government in the United Kingdom distributed leaflets containing such a recommendation in December 2000. They noted that no evidence exists that using a wireless phone causes brain tumors or other ill effects. Their recommendation to limit wireless phone use by children was strictly precautionary; it was not based on scientific evidence that any health hazard exists.

Do hands-free kits for wireless phones reduce risks from exposure to RF emissions?

Since there are no known risks from exposure to RF emissions from wireless phones, there is no reason to believe that hands-free kits reduce risks. Hands-free kits can be used with wireless phones for convenience and comfort. These systems reduce the absorption of RF energy in the head because the phone, which is the source of the RF emissions, will not be placed against the head. On the other hand, if the phone is mounted against the waist or other part of the body during use, then that part of the body will absorb more RF energy. Wireless phones marketed in the U.S. are required to meet safety requirements regardless of whether they are used against the head or against the body. Either configuration should result in compliance with the safety limit.

Do wireless phone accessories that claim to shield the head from RF radiation work?

Since there are no known risks from exposure to RF emissions from wireless phones, there is no reason to believe that accessories that claim to shield the head from those emissions reduce risks. Some products that claim to shield the user from RF absorption use special phone cases, while others involve nothing more than a metallic accessory attached to the phone. Studies have shown that these products generally do not work as advertised. Unlike "hand-free" kits, these so-called "shields" may interfere with proper operation of the phone. The phone may be forced to boost its power to compensate, leading to an increase in RF absorption.

In February 2002, the Federal Trade Commission (FTC) charged two companies that sold devices that claimed to protect wireless phone users from radiation with making false and unsubstantiated claims. According to FTC, these defendants lacked a reasonable basis to substantiate their claim.

What about wireless phone interference with medical equipment?

Radio frequency energy (RF) from wireless phones can interact with some electronic devices. For this reason, FDA helped develop a detailed test method to measure electromagnetic interference (EMI) of implanted cardiac pacemakers and defibrillators from wireless telephones. This test method is now part of a standard sponsored by the Association for the Advancement of Medical Instrumentation (AAMI). The final draft, a joint effort by FDA, medical device manufacturers, and many other groups, was completed in late 2000. This standard will allow manufacturers to ensure that cardiac pacemakers and defibrillators are safe from wireless phone EMI. FDA has tested wireless phones and helped develop a voluntary standard sponsored by the Institute of Electrical and Electronic Engineers (IEEE). This standard specifies test methods and performance requirements for hearing aids and wireless phones so that no interference occurs when a person uses a compatible phone and a compatible hearing aid at the same time. This standard was approved by the IEEE in 2000.

FDA continues to monitor the use of wireless phones for possible interactions with other medical devices. Should harmful interference be found to occur, FDA will conduct testing to assess the interference and work to resolve the problem.

Additional information on the safety of RF exposures from various sources can be obtained from the following organizations (Updated 12/1/2006):

- FCC RF Safety Program:
<http://www.fcc.gov/oet/rfsafety/>
- Environmental Protection Agency (EPA):
<http://www.epa.gov/radiation/>
- Occupational Safety and Health Administration's (OSHA):
<http://www.osha.gov/SLTC/radiofrequencyradiation/index.html>
- National Institute for Occupational Safety and Health (NIOSH):
<http://www.cdc.gov/niosh/homepage.html>
- World Health Organization (WHO):
<http://www.who.int/peh-emf/>

- International Commission on Non-Ionizing Radiation Protection:
<http://www.icnirp.de>
- National Radiation Protection Board (UK):
<http://www.hpa.org.uk/radiation>
- US Food and Drug Administration
<http://www.fda.gov/cellphones>

Road Safety

Your wireless phone gives you the powerful ability to communicate by voice, almost anywhere, anytime. But an important responsibility accompanies the benefits of wireless phones, one that every user must uphold.

When driving a car, driving is your first responsibility. When using your wireless phone behind the wheel of a car, practice good common sense and remember the following tips:

1. Get to know your wireless phone and its features, such as speed dial and redial. If available, these features help you to place your call without taking your attention off the road.
2. When available, use a hands-free device. If possible, add an additional layer of convenience and safety to your wireless phone with one of the many hands free accessories available today.
3. Position your wireless phone within easy reach. Be able to access your wireless phone without removing your eyes from the road. If you get an incoming call at an inconvenient time, let your voice mail answer it for you.
4. Let the person you are speaking with know you are driving; if necessary, suspend the call in heavy traffic or hazardous weather conditions. Rain, sleet, snow, ice and even heavy traffic can be hazardous.
5. Do not take notes or look up phone numbers while driving. Jotting down a "to do" list or swiveling through your address book takes attention away from your primary responsibility, driving safely.
6. Dial sensibly and assess the traffic; if possible, place calls when you are not moving or before pulling into traffic. Try to plan calls when your car will be stationary. If you need to make a call while moving, dial only a few numbers, check the road and your mirrors, then continue.

7. Do not engage in stressful or emotional conversations that may be distracting. Make people you are talking with aware you are driving and suspend conversations that have the potential to divert your attention from the road.
8. Use your wireless phone to call for help. Dial 9-1-1 or other local emergency number in the case of fire, traffic accident or medical emergencies. Remember, it is a free call on your wireless phone!
9. Use your wireless phone to help others in emergencies. If you see an auto accident, crime in progress or other serious emergency where lives are in danger, call 9-1-1 or other local emergency number, as you would want others to do for you.
10. Call roadside assistance or a special non-emergency wireless assistance number when necessary. If you see a broken-down vehicle posing no serious hazard, a broken traffic signal, a minor traffic accident where no one appears injured, or a vehicle you know to be stolen, call roadside assistance or other special non-emergency number.

"The wireless industry reminds you to use your phone safely when driving."

For more information, please call 1-888-901-SAFE, or visit our web-site www.wow-com.com.

Important! If you are using a handset other than a standard numeric keypad, please call 1-888-901-7233.

Provided by the Cellular Telecommunications & Internet Association.

Responsible Listening

Caution! Avoid potential hearing loss.

Damage to hearing occurs when a person is exposed to loud sounds over time. The risk of hearing loss increases as sound is played louder and for longer durations. Prolonged exposure to loud sounds (including music) is the most common cause of preventable hearing loss. Some scientific research suggests that using portable audio devices, such as portable music players and cellular telephones, at high volume settings for long durations may lead to permanent noise-induced hearing loss. This includes the use of headphones (including headsets, earbuds, and Bluetooth or other wireless devices). Exposure to very loud sound has also been associated in some studies with tinnitus (a ringing in the ear), hypersensitivity to sound and distorted hearing.

Individual susceptibility to noise-induced hearing loss and potential hearing problem varies. Additionally, the amount of sound produced by a portable audio device varies depending on the nature of the sound, the device settings, and the headphones that are used. As a result, there is no single volume setting that is appropriate for everyone or for every combination of sound, settings and equipment.

You should follow some commonsense recommendations when using any portable audio device:

- Set the volume in a quiet environment and select the lowest volume at which you can hear adequately.
- When using headphones, turn the volume down if you cannot hear the people speaking near you or if the person sitting next to you can hear what you are listening to.
- Do not turn the volume up to block out noisy surroundings. If you choose to listen to your portable device in a noisy environment, you noise-cancelling headphones to block out background environmental noise. By blocking background environment noise, noise cancelling headphones should allow you to hear the music at lower volumes than when using earbuds.
- Limit the amount of time you listen. As the volume increases, less time is required before your hearing could be affected.
- Avoid using headphones after exposure to extremely loud noises, such as rock concerts, that might cause temporary hearing loss. Temporary hearing loss might cause unsafe volumes to sound normal.
- Do not listen at any volume that causes you discomfort. If you experience ringing in your ears, hear muffled speech or experience any temporary hearing difficulty after listening to your portable audio device, discontinue use and consult your doctor.

You can obtain additional information on this subject from the following sources:

American Academy of Audiology

11730 Plaza American Drive, Suite 300

Reston, VA 20190

Voice: (800) 222-2336

Email: info@audiology.org

Internet: <http://www.audiology.org>

National Institute on Deafness and Other Communication Disorders

National Institutes of Health

31 Center Drive, MSC 2320

Bethesda, MD 20892-2320

Voice: (301) 496-7243

Email: nidcdinfo@nih.gov

Internet: <http://www.cdc.gov/niosh/topics/noise/default.html>

National Institute for Occupational Safety and Health

Hubert H. Humphrey Bldg.

200 Independence Ave., SW

Washington, DC 20201

Voice: 1-800-35-NIOSH (1-800-356-4647)

Internet: <http://www.cdc.gov/niosh/topics/noise/default.html>

Operating Environment

Remember to follow any special regulations in force in any area and always switch your phone off whenever it is forbidden to use it, or when it may cause interference or danger. When connecting the phone or any accessory to another device, read its user's guide for detailed safety instructions. Do not connect incompatible products.

As with other mobile radio transmitting equipment, users are advised that for the satisfactory operation of the equipment and for the safety of personnel, it is recommended that the equipment should only be used in the normal operating position (held to your ear with the antenna pointing over your shoulder if you are using an external antenna).

Using Your Phone Near Other Electronic Devices

Most modern electronic equipment is shielded from radio frequency (RF) signals. However, certain electronic equipment may not be shielded against the RF signals from your wireless phone. Consult the manufacturer to discuss alternatives.

Implantable Medical Devices

A minimum separation of six (6) inches should be maintained between a handheld wireless phone and an implantable medical device, such as a pacemaker or implantable cardioverter defibrillator, to avoid potential interference with the device. Persons who have such devices:

- Should ALWAYS keep the phone more than six (6) inches from their implantable medical device when the phone is turned ON;
- Should not carry the phone in a breast pocket;
- Should use the ear opposite the implantable medical device to minimize the potential for interference;
- Should turn the phone OFF immediately if there is any reason to suspect that interference is taking place.
- Should read and follow the directions from the manufacturer of your implantable medical device. If you have any questions about using your wireless phone with such a device, consult your health care provider.

For more information see, <http://www.fcc.gov/oet/rfsafety/rf-faqs.html>

Hearing Aid Compatibility with Mobile Phones

Some digital wireless phones may interfere with some hearing aids. In the event of such interference, you may wish to consult your hearing aid manufacturer to discuss alternatives.

Other Medical Devices

If you use any other personal medical devices, consult the manufacturer of your device to determine if it is adequately shielded from external RF energy. Your physician may be able to assist you in obtaining this information. Switch your phone off in health care facilities when any regulations posted in these areas instruct you to do so. Hospitals or health care facilities may be using equipment that could be sensitive to external RF energy.

Vehicles

RF signals may affect improperly installed or inadequately shielded electronic systems in motor vehicles. Check with the manufacturer or its representative regarding your vehicle. You should also consult the manufacturer of any equipment that has been added to your vehicle.

Posted Facilities

Switch your phone off in any facility where posted notices require you to do so.

Potentially Explosive Environments

Switch your phone off when in any area with a potentially explosive atmosphere and obey all signs and instructions. Sparks in such areas could cause an explosion or fire resulting in bodily injury or even death.

Users are advised to switch the phone off while at a refueling point (service station). Users are reminded of the need to observe restrictions on the use of radio equipment in fuel depots (fuel storage and distribution areas), chemical plants or where blasting operations are in progress.

Areas with a potentially explosive atmosphere are often but not always clearly marked. They include below deck on boats, chemical transfer or storage facilities, vehicles using liquefied petroleum gas (such as propane or butane), areas where the air contains chemicals or particles, such as grain, dust or metal powders, and any other area where you would normally be advised to turn off your vehicle engine.

Emergency Calls

This phone, like any wireless phone, operates using radio signals, wireless and landline networks as well as user-programmed functions, which cannot guarantee connection in all conditions. Therefore, you should never rely solely on any wireless phone for essential communications (medical emergencies, for example).

Remember, to make or receive any calls the phone must be switched on and in a service area with adequate signal strength. Emergency calls may not be possible on all wireless phone networks or when certain network services and/or phone features are in use. Check with local service providers.

To make an emergency call:

1. If the phone is not on, switch it on.
2. Key in the emergency number for your present location (for example, 911 or other official emergency number). Emergency numbers vary by location.
3. Press the  key.

If certain features are in use (call barring, for example), you may first need to deactivate those features before you can make an emergency call. Consult this document and your local cellular service provider.

When making an emergency call, remember to give all the necessary information as accurately as possible. Remember that your phone may be the only means of communication at the scene of an accident; do not cut off the call until given permission to do so.

Restricting Children's access to your Phone

Your phone is not a toy. Children should not be allowed to play with it because they could hurt themselves and others, damage the phone or make calls that increase your phone bill.

FCC Notice and Cautions

FCC Notice

The phone may cause TV or radio interference if used in close proximity to receiving equipment. The FCC can require you to stop using the phone if such interference cannot be eliminated.

Vehicles using liquefied petroleum gas (such as propane or butane) must comply with the National Fire Protection Standard (NFPA-58). For a copy of this standard, contact the National Fire Protection Association, One Batterymarch Park, Quincy, MA 02269, Attn: Publication Sales Division.

Cautions

Any changes or modifications to your phone not expressly approved in this document could void your warranty for this equipment, and void your authority to operate this equipment. Only use approved batteries, antennas and chargers. The use of any unauthorized accessories may be dangerous and void the phone warranty if said accessories cause damage or a defect to the phone.

Although your phone is quite sturdy, it is a complex piece of equipment and can be broken. Avoid dropping, hitting, bending or sitting on it.

Other Important Safety Information

- Only qualified personnel should service the phone or install the phone in a vehicle. Faulty installation or service may be dangerous and may invalidate any warranty applicable to the device.
- Check regularly that all wireless phone equipment in your vehicle is mounted and operating properly.
- Do not store or carry flammable liquids, gases or explosive materials in the same compartment as the phone, its parts or accessories.
- For vehicles equipped with an air bag, remember that an air bag inflates with great force. Do not place objects, including both installed or portable wireless equipment in the area over the air bag or in the air bag deployment area. If wireless equipment is improperly installed and the air bag inflates, serious injury could result.

- Switch your phone off before boarding an aircraft. The use of wireless phone in aircraft is illegal and may be dangerous to the aircraft's operation.
- Failure to observe these instructions may lead to the suspension or denial of telephone services to the offender, or legal action, or both.

Product Performance

Getting the Most Out of Your Signal Reception

The quality of each call you make or receive depends on the signal strength in your area. Your phone informs you of the current signal strength by displaying a number of bars next to the signal strength icon. The more bars displayed, the stronger the signal.

If you're inside a building, being near a window may give you better reception.

Understanding the Power Save Feature

If your phone is unable to find a signal after searching, a Power Save feature is automatically activated. If your phone is active, it periodically rechecks service availability or you can check it yourself by pressing any key.

Anytime the Power Save feature is activated, a message displays on the screen. When a signal is found, your phone returns to standby mode.

Understanding How Your Phone Operates

Your phone is basically a radio transmitter and receiver. When it's turned on, it receives and transmits radio frequency (RF) signals. When you use your phone, the system handling your call controls the power level. This power can range from 0.006 watts to 0.2 watts in digital mode.

Maintaining Your Phone's Peak Performance

For the best care of your phone, only authorized personnel should service your phone and accessories. Faulty service may void the warranty.

There are several simple guidelines to operating your phone properly and maintaining safe, satisfactory service.

- If your phone is equipped with an external antenna, hold the phone with the antenna raised, fully-extended and over your shoulder.
- Do not hold, bend or twist the phone's antenna, if applicable.
- Do not use the phone if the antenna is damaged.
- If your phone is equipped with an internal antenna, obstructing the internal antenna could inhibit call performance.
- Speak directly into the phone's receiver.

- Avoid exposing your phone and accessories to rain or liquid spills. If your phone does get wet, immediately turn the power off and remove the battery. If it is inoperable, call Customer Care for service.

Availability of Various Features/Ring Tones

Many services and features are network dependent and may require additional subscription and/or usage charges. Not all features are available for purchase or use in all areas. Downloadable Ring Tones may be available at an additional cost. Other conditions and restrictions may apply. See your service provider for additional information.

Battery Standby and Talk Time

Standby and talk times will vary depending on phone usage patterns and conditions. Battery power consumption depends on factors such as network configuration, signal strength, operating temperature, features selected, frequency of calls, and voice, data, and other application usage patterns.

Battery Precautions

- Avoid dropping the cell phone. Dropping it, especially on a hard surface, can potentially cause damage to the phone and battery. If you suspect damage to the phone or battery, take it to a service center for inspection.
- Never use any charger or battery that is damaged in any way.
- Do not modify or remanufacture the battery as this could result in serious safety hazards.
- If you use the phone near the network's base station, it uses less power; talk and standby time are greatly affected by the signal strength on the cellular network and the parameters set by the network operator.
- Follow battery usage, storage and charging guidelines found in the user's guide.
- Battery charging time depends on the remaining battery charge and the type of battery and charger used. The battery can be charged and discharged hundreds of times, but it will gradually wear out. When the operation time (talk time and standby time) is noticeably shorter than normal, it is time to buy a new battery.
- If left unused, a fully charged battery will discharge itself over time.
- Use only Samsung-approved batteries and recharge your battery only with Samsung-approved chargers. When a charger is not in use, disconnect it from the power source. Do not leave the battery connected to a charger for more than a week, since overcharging may shorten its life.

- Do not use incompatible cell phone batteries and chargers. Some Web sites and second-hand dealers, not associated with reputable manufacturers and carriers, might be selling incompatible or even counterfeit batteries and chargers. Consumers should purchase manufacturer or carrier recommended products and accessories. If unsure about whether a replacement battery or charger is compatible, contact the manufacturer of the battery or charger.
- Misuse or use of incompatible phones, batteries, and charging devices could result in damage to the equipment and a possible risk of fire, explosion, leakage, or other serious hazard.
- Extreme temperatures will affect the charging capacity of your battery: it may require cooling or warming first.
- Do not leave the battery in hot or cold places, such as in a car in summer or winter conditions, as you will reduce the capacity and lifetime of the battery. Always try to keep the battery at room temperature. A phone with a hot or cold battery may temporarily not work, even when the battery is fully charged. Li-ion batteries are particularly affected by temperatures below 0 °C (32 °F).
- Do not place the phone in areas that may get very hot, such as on or near a cooking surface, cooking appliance, iron, or radiator.
- Do not get your phone or battery wet. Even though they will dry and appear to operate normally, the circuitry could slowly corrode and pose a safety hazard.
- Do not short-circuit the battery. Accidental short-circuiting can occur when a metallic object (coin, clip or pen) causes a direct connection between the + and - terminals of the battery (metal strips on the battery), for example when you carry a spare battery in a pocket or bag. Short-circuiting the terminals may damage the battery or the object causing the short-circuiting.
- Do not permit a battery out of the phone to come in contact with metal objects, such as coins, keys or jewelry.
- Do not crush, puncture or put a high degree of pressure on the battery as this can cause an internal short-circuit, resulting in overheating.
- Dispose of used batteries in accordance with local regulations. In some areas, the disposal of batteries in household or business trash may be prohibited. For safe disposal options for Li-Ion batteries, contact your nearest Samsung authorized service center. Always recycle. Do not dispose of batteries in a fire.

Care and Maintenance

Your phone is a product of superior design and craftsmanship and should be treated with care. The suggestions below will help you fulfill any warranty obligations and allow you to enjoy this product for many years.

- Keep the phone and all its parts and accessories out of the reach of small children.
- Keep the phone dry. Precipitation, humidity and liquids contain minerals that will corrode electronic circuits.
- Do not use the phone with a wet hand. Doing so may cause an electric shock to you or damage to the phone.
- Do not use or store the phone in dusty, dirty areas, as its moving parts may be damaged.
- Do not store the phone in hot areas. High temperatures can shorten the life of electronic devices, damage batteries, and warp or melt certain plastics.
- Do not store the phone in cold areas. When the phone warms up to its normal operating temperature, moisture can form inside the phone, which may damage the phone's electronic circuit boards.
- Do not drop, knock or shake the phone. Rough handling can break internal circuit boards.
- Do not use harsh chemicals, cleaning solvents or strong detergents to clean the phone. Wipe it with a soft cloth slightly dampened in a mild soap-and-water solution.
- Do not paint the phone. Paint can clog the device's moving parts and prevent proper operation.
- Do not put the phone in or on heating devices, such as a microwave oven, a stove or a radiator. The phone may explode when overheated.
- If your phone is equipped with an external antenna, use only the supplied or an approved replacement antenna. Unauthorized antennas or modified accessories may damage the phone and violate regulations governing radio devices.
- If the phone, battery, charger or any accessory is not working properly, take it to your nearest qualified service facility. The personnel there will assist you, and if necessary, arrange for service.

Section 13: Warranty Information

Topics Covered

- Standard Limited Warranty
-

Standard Limited Warranty

What is Covered and For How Long? SAMSUNG

TELECOMMUNICATIONS AMERICA, LLC ("SAMSUNG") warrants to the original purchaser ("Purchaser") that SAMSUNG's Phones and accessories ("Products") are free from defects in material and workmanship under normal use and service for the period commencing upon the date of purchase and continuing for the following specified period of time after that date:

Phone	1 Year
Batteries	1 Year
Leather Case/ Pouch	90 Days
Holster	90 Days
Other Phone Accessories	1 Year

What is Not Covered? This Limited Warranty is conditioned upon proper use of Product by Purchaser. This Limited Warranty does not cover: (a) defects or damage resulting from accident, misuse, abuse, neglect, unusual physical, electrical or electromechanical stress, or modification of any part of Product, including antenna, or cosmetic damage; (b) equipment that has the serial number removed or made illegible; (c) any plastic surfaces or other externally exposed parts that are scratched or damaged due to normal use; (d) malfunctions resulting from the use of Product in conjunction with accessories, products, or ancillary/peripheral equipment not furnished or approved by SAMSUNG; (e) defects or damage from improper testing, operation, maintenance, installation, or adjustment; (f) installation, maintenance, and service of Product, or (g) Product used or purchased outside the United States or Canada.

This Limited Warranty covers batteries only if battery capacity falls below 80% of rated capacity or the battery leaks, and this Limited Warranty does not cover any battery if (i) the battery has been charged by a battery charger not specified or approved by SAMSUNG for charging the battery, (ii) any of the seals on the battery are broken or show evidence of tampering, or (iii) the battery has been used in equipment other than the SAMSUNG phone for which it is specified.

What are SAMSUNG's Obligations? During the applicable warranty period, SAMSUNG will repair or replace, at SAMSUNG's sole option, without charge to Purchaser, any defective component part of Product. To obtain service under this Limited Warranty, Purchaser must return Product to an authorized phone service facility in an adequate container for shipping, accompanied by Purchaser's sales receipt or comparable substitute proof of sale showing the date of purchase, the serial number of Product and the sellers' name and address. To obtain assistance on where to deliver the Product, call Samsung Customer Care at 1-888-987-4357. Upon receipt, SAMSUNG will promptly repair or replace the defective Product. SAMSUNG may, at SAMSUNG's sole option, use rebuilt, reconditioned, or new parts or components when repairing any Product or replace Product with a rebuilt, reconditioned or new Product. Repaired/replaced leather cases, pouches and holsters will be warranted for a period of ninety (90) days. All other repaired/replaced Product will be warranted for a period equal to the remainder of the original Limited Warranty on the original Product or for 90 days, whichever is longer. All replaced parts, components, boards and equipment shall become the property of SAMSUNG. If SAMSUNG determines that any Product is not covered by this Limited Warranty, Purchaser must pay all parts, shipping, and labor charges for the repair or return of such Product.

WHAT ARE THE LIMITS ON SAMSUNG'S WARRANTY/LIABILITY? EXCEPT AS SET FORTH IN THE EXPRESS WARRANTY CONTAINED HEREIN, PURCHASER TAKES THE PRODUCT "AS IS," AND SAMSUNG MAKES NO WARRANTY OR REPRESENTATION AND THERE ARE NO CONDITIONS, EXPRESS OR IMPLIED, STATUTORY OR OTHERWISE, OF ANY KIND WHATSOEVER WITH RESPECT TO THE PRODUCT, INCLUDING BUT NOT LIMITED TO:

- THE MERCHANTABILITY OF THE PRODUCT OR ITS FITNESS FOR ANY PARTICULAR PURPOSE OR USE;
- WARRANTIES OF TITLE OR NON-INFRINGEMENT;
- DESIGN, CONDITION, QUALITY, OR PERFORMANCE OF THE PRODUCT;
- THE WORKMANSHIP OF THE PRODUCT OR THE COMPONENTS CONTAINED THEREIN; OR

- COMPLIANCE OF THE PRODUCT WITH THE REQUIREMENTS OF ANY LAW, RULE, SPECIFICATION OR CONTRACT PERTAINING THERETO.

NOTHING CONTAINED IN THE INSTRUCTION MANUAL SHALL BE CONSTRUED TO CREATE AN EXPRESS WARRANTY OF ANY KIND WHATSOEVER WITH RESPECT TO THE PRODUCT. ALL IMPLIED WARRANTIES AND CONDITIONS THAT MAY ARISE BY OPERATION OF LAW, INCLUDING IF APPLICABLE THE IMPLIED WARRANTIES OF MERCHANTABILITY AND FITNESS FOR A PARTICULAR PURPOSE, ARE HEREBY LIMITED TO THE SAME DURATION OF TIME AS THE EXPRESS WRITTEN WARRANTY STATED HEREIN. SOME STATES/PROVINCES DO NOT ALLOW LIMITATIONS ON HOW LONG AN IMPLIED WARRANTY LASTS, SO THE ABOVE LIMITATION MAY NOT APPLY TO YOU. IN ADDITION, SAMSUNG SHALL NOT BE LIABLE FOR ANY DAMAGES OF ANY KIND RESULTING FROM THE PURCHASE, USE, OR MISUSE OF, OR INABILITY TO USE THE PRODUCT OR ARISING DIRECTLY OR INDIRECTLY FROM THE USE OR LOSS OF USE OF THE PRODUCT OR FROM THE BREACH OF THE EXPRESS WARRANTY, INCLUDING INCIDENTAL, SPECIAL, CONSEQUENTIAL OR SIMILAR DAMAGES, OR LOSS OF ANTICIPATED PROFITS OR BENEFITS, OR FOR DAMAGES ARISING FROM ANY TORT (INCLUDING NEGLIGENCE OR GROSS NEGLIGENCE) OR FAULT COMMITTED BY SAMSUNG, ITS AGENTS OR EMPLOYEES, OR FOR ANY BREACH OF CONTRACT OR FOR ANY CLAIM BROUGHT AGAINST PURCHASER BY ANY OTHER PARTY. SOME STATES/PROVINCES DO NOT ALLOW THE EXCLUSION OR LIMITATION OF INCIDENTAL OR CONSEQUENTIAL DAMAGES, SO THE ABOVE LIMITATION OR EXCLUSION MAY NOT APPLY TO YOU. THIS WARRANTY GIVES YOU SPECIFIC LEGAL RIGHTS, AND YOU MAY ALSO HAVE OTHER RIGHTS, WHICH VARY FROM STATE TO STATE/PROVINCE TO PROVINCE. THIS LIMITED WARRANTY SHALL NOT EXTEND TO ANYONE OTHER THAN THE ORIGINAL PURCHASER OF THIS PRODUCT AND STATES PURCHASER'S EXCLUSIVE REMEDY. IF ANY PORTION OF THIS LIMITED WARRANTY IS HELD ILLEGAL OR UNENFORCEABLE BY REASON OF ANY LAW, SUCH PARTIAL ILLEGALITY OR UNENFORCEABILITY SHALL NOT AFFECT THE ENFORCEABILITY FOR THE REMAINDER OF THIS LIMITED WARRANTY WHICH PURCHASER ACKNOWLEDGES IS AND WILL ALWAYS BE CONSTRUED TO BE LIMITED BY ITS TERMS OR AS LIMITED AS THE LAW PERMITS. THE PARTIES UNDERSTAND THAT THE PURCHASER MAY USE THIRD-PARTY SOFTWARE OR EQUIPMENT IN CONJUNCTION WITH THE PRODUCT. SAMSUNG MAKES NO WARRANTIES OR REPRESENTATIONS AND THERE ARE NO CONDITIONS, EXPRESS OR IMPLIED, STATUTORY OR OTHERWISE, AS TO THE QUALITY, CAPABILITIES, OPERATIONS, PERFORMANCE OR SUITABILITY OF ANY THIRDPARTY SOFTWARE OR EQUIPMENT, WHETHER SUCH THIRD-PARTY SOFTWARE OR EQUIPMENT IS INCLUDED WITH THE PRODUCT DISTRIBUTED BY SAMSUNG OR OTHERWISE, INCLUDING THE ABILITY TO INTEGRATE ANY SUCH SOFTWARE OR

EQUIPMENT WITH THE PRODUCT. THE QUALITY, CAPABILITIES, OPERATIONS, PERFORMANCE AND SUITABILITY OF ANY SUCH THIRD-PARTY SOFTWARE OR EQUIPMENT LIE SOLELY WITH THE PURCHASER AND THE DIRECT VENDOR, OWNER OR SUPPLIER OF SUCH THIRD-PARTY SOFTWARE OR EQUIPMENT, AS THE CASE MAY BE.

This Limited Warranty allocates risk of Product failure between Purchaser and SAMSUNG, and SAMSUNG's Product pricing reflects this allocation of risk and the limitations of liability contained in this Limited Warranty. The agents, employees, distributors, and dealers of SAMSUNG are not authorized to make modifications to this Limited Warranty, or make additional warranties binding on SAMSUNG. Accordingly, additional statements such as dealer advertising or presentation, whether oral or written, do not constitute warranties by SAMSUNG and should not be relied upon.

Precautions for Transfer and Disposal

If data stored on this device is deleted or reformatted using the standard methods, the data only appears to be removed on a superficial level, and it may be possible for someone to retrieve and reuse the data by means of special software.

To avoid unintended information leaks and other problems of this sort, it is recommended that the device be returned to Samsung's Customer Care Center for an Extended File System (EFS) Clear which will eliminate all user memory and return all settings to default settings. Please contact the **Samsung Customer Care Center** for details.

Important! Please provide warranty information (proof of purchase) to Samsung's Customer Care Center in order to provide this service at no charge. If the warranty has expired on the device, charges may apply.

Customer Care Center:

1000 Klein St.

Plano, TX 75074

Toll Free Tel: 1.888.987.HELP (4357)

Samsung Telecommunications America, LLC

1301 East Lookout Drive

Richardson, Texas 75082

Phone: 1-800-SAMSUNG (726-7864)

Important! If you are using a handset other than a standard numeric keypad, dial the numbers listed in brackets.

Phone: 1-888-987-HELP (4357)

©2007 Samsung Telecommunications America. All rights reserved.

No reproduction in whole or in part allowed without prior written approval.

Specifications and availability subject to change without notice.

Index

Numerics

- 1-touch dialing** 64
- 2-touch dialing** 64
- 3-touch dialing** 64
- 911, notes about** 65

A

Adding a New Contact Entry 56

Alarm clock

- icon 18
- snooze 128
- turn off the alarm 127

Answer options 101

Auto answer icon 18

Auto retry 102

B

Backup to last menu 43

Battery 19

- charging 22
- indicator 25
- installing 20
- removing 21
- strength icon 17

Bluetooth 83

- about 83

C

Calendar

- add a new event 124

Call Functions 26

- answering a call 27
- Recent Calls 29
- roaming 32

Call history

- calls using 30

definition 29

deleting entry 32

icons 29

new contact 31

updating existing contact 31

Call In-progress menu 28

Change lock code 97

Changing Message Settings 80

Clear key 13

Clock Format 91

Command Keys 13

Contact List

- finding a contact entry 63

Contacts

- adding a new contact entry 56
- deleting a contact entry 64
- editing an existing contact entry 63
- speed dialing 64
- wait pause & 2-second pause 59

Contacts Icons 55

Creating and Sending Picture Messages 73

Creating and Sending TXT Messages 72

D

Dial Fonts 91

Dialing

- one-touch 64
- three-touch 64
- two-touch 64

Disable alarm 127

Display 88

- backlight 90
- banner 89
- language 93
- screen icons 16

Display Theme 91
Download music to your PC using V CAST Music Manager 105
Draft messages 78
Drafts folder 78

E

End key 13
Entering Text
 changing text entry mode 50
 entering numbers 53
 entering symbols 52
 using Word Mode 51

F

Finding a Contacts Entry 63

Folder

 drafts 78
 inbox 75
 sent 76

G

Get It Now 115
Getting Started 4
 understanding this user manual 4

Groups

 creating 61
 move entries from/to 60
 send messages to 61
 send picture messages to 62
 viewing 60

H

Health and Safety Information 131

I

Icons

 alarm on 18
 alarm only 18
 battery strength 17
 display 16
 signal strength 16
 silent mode 18
 TTY 17

Inbox folder 75

Indicator

 calendar appointment 18
 missed calls 18
 new message 18
 no service 17
 roaming 16
 signal strength 16
 speakerphone 18

Installing battery 20

L

Language setting 93

Left soft key 13

Lock code, changing 97

Lock Mode

 placing an emergency call 99

Lock phone 94

M

Making a call 26

Menu Navigation 43

 menu outline 44

Menu shortcuts 43

Menu, Call In-progress option 28

Messages, receive in call 71

Messaging 68

 types of messages 68

Mode

 call answer 101

N

- Navigation key 14
- Navigation key shortcuts 44
- Navigation wheel 14
- New message icon 18
- No service indicator 17
- Non-Supported Battery 20
- Notes and tips 4
- Notes, description 4
- Notes, editing 130

P

- Phone Info 104
- Phone Settings 92
 - Shortcut Key 92
 - Standalone Mode 92
- Picture messages
 - view later 71
- Powering off 5
- Powering on 5

R

- Receive messages in call 71
- Receive text messages 68
- Receiving a Message 69
- Receiving Picture Messages 70
- Removing battery 21
- Return to last menu 43
- Reviewing sent 76
- Right soft key 13
- Roaming
 - definition 32
 - options 32
- Roaming indicator 16

S

- Safe Use of your phone 133
- Security
 - edit lock code 97

- lock phone 94
- voice privacy 103

- Security settings 94
- Send key 14
- Sent, reviewing messages 76
- Set an alarm 126
- Settings 82
 - backlight 90
 - banner 89
 - display settings 88
 - edit lock code 97
 - language 93
 - lock phone 94
 - resetting your phone 98
 - security settings 94
 - Tools 82

- Shortcut to menus 43
- Signal strength icon 16
- Silent mode icon 18
- Snooze 128
- Sounds 86

- Alert Sounds 87
- Call Sounds 86
- Keypad Volume 87
- Power On/Off 88
- Service Alerts 88

- Speakerphone Key 15
- Speed dial, assigning 65
- Standard Limited
- Warranty 151
- Sync Music from your PC to your device using V CAST Music Manager 106

T

- Text messages, receiving 68
- Tip, description 4

Tools 82

- Alarm Clock 82, 126
- Calculator 82, 122
- Calendar 82, 124
 - converter 123
- Notepad 82, 129
- Stop Watch 128
- Tip, calculator 123
- view an event 125
- Voice Commands 82, 122
- World Clock 82, 129

Travel Charger 22

TTY Mode 33, 102

Turning Your Phone On and Off 5

Two-touch dialing 64

U

Understanding Your Contacts 54

Understanding Your Phone 7

- features of your phone 7
- main screen 16

V

Vibrate mode icon 18

View an event, calendar 125

Voice Call Icon 17

Voice privacy 103

Voicemail

- listening to 6
- setting up 5
- voicemail icon 18

VoiceSignal

- commands 38
- description 38
- name dial 39
- name lookup 40
- open menu 41
- send text 39

W

Wallpaper 90

Warranty Information 151