



Catalog

Performance Climate Changer™ Air Handlers Sizes 3-120 Indoor and Outdoor Units Application and Performance Information





Introduction

Performance Climate Changer air handlers combine the Trane tradition of engineering excellence with the latest in manufacturing technology to give you an energy efficient air handler with superior performance, the highest quality and reliability, and the lowest installed cost in the industry. This air handler was designed to incorporate such features as component flexibility, integrated control options, and proven performance to give you the optimal system to clean, filter, dehumidify, heat, and cool your building.

Superior Performance

- ASHRAE 111 Class 6 low-leak casing design achieving less than 1.0 percent leakage rate at +/- 8 inches w.g.
- Less than L/240 @ +/- 8 inches w.g. panel and door deflection
- 2-inch R13 foam-insulated, mid-span thermal break panels and thermal break doors
- Casing thermal resistance ratio TR-value of 0.6
- New filter technology that exceeds LEED requirements and reduces filter pressure drops up to 50 percent versus previous designs

Industry-Leading Energy Efficiency

- AMCA 611-certified Traq airflow monitoring station
- Total energy-recovery wheels
- Cool Dry Quiet (CDQ™) desiccant dehumidification wheels
- Discharge plenums and plenum fan sections available with variable size, type, and location of openings to reduce static pressure loss and lower energy consumption
- 50,000 hour LED service lights
- Low-leak, high thermal performance casing design
- All airfoil-bladed dampers and Traq dampers meet ASHRAE 90.1 lowest specified leakage requirements
- High-efficiency coil fins deliver superior heat transfer while allowing face velocities in excess of 625 fpm without moisture carryover

System Optimization

- Optimal design to meet the Trane EarthWise™ design philosophy incorporating high-efficiency air handlers and water chillers with low flow rates and low temperatures.
- Factory-engineered, -mounted, and -tested control packages with properly sealed casing openings.
- Variety of coil types with high-efficiency coil fins allow lower coil approach temperature and reduce chance of moisture carryover
- Ability to choose the exact number of fins per foot of coil surface to enhance heat transfer and air pressure performance
- Wide array of fan options, including direct-drive plenum fans, belt-drive plenum fans, and housed fans
- Control options to easily incorporate fan pressurization and demand control ventilation strategies.
- Design and analysis tools provide whole building analysis, acoustical design guidance, equipment performance data, and suggested control strategies to help achieve optimum system design with tailored energy, IAQ, and project budget solutions.

Highest Quality

- UL/CUL listed
- AHRI Standard 430-certified air-handling unit
- AHRI Standard 410-certified coils are all factory tested
- AHRI Standard 1060-certified energy wheels
- All fans are dynamically balanced in the horizontal and vertical planes.
- All fans with VFDs undergo inverter balancing
- Formulated panels and integral base frame minimize seams that could introduce air leak paths
- Integrated raceway for wiring protection
- Integrated, fully-enclosed control panel for starters, VFDs, and unit-mounted controllers
- Pre-engineered, factory-mounted controls, including end devices, motor controllers, VFDs, unit-mounted DDC controllers, Traq™ damper ventilation control section, UL-listed turnkey control packages

Lowest Installed Cost

- Lifting lugs included on the integral base frame
- Indoor units ship with skid designed for forklift transport
- Variable height, size, type, and location of openings on discharge plenums minimize duct transitions
- Factory-installed interoperable controls shorten construction cycles, simplify job-site coordination, reduce installation time and expense, and provide single-source responsibility for warranty and service issues
- Single-point power is available with high-voltage distribution block and external main unit disconnect with lockout/tagout capabilities.
- External service module with 15 amp GFCI receptacle, light switch, and controller display and communications port
- Quick-connect wiring minimizes installation costs and provides wiring integrity between sections
- Factory-installed conduit connectors eliminate penetrations in the wrong location
- Motor leads can be run through flexible metal conduits to NEMA 4 external motor junction box
- Building Information Modeling (BIM) drawings to minimize jobsite ductwork, electrical, piping and structural interference
- Duct supports designed into factory roof curbs for pre-connection of ductwork

For dimensional information on Performance Climate Changer air handlers see Trane catalog CLCH-PRC023-EN.



Table of Contents

Introduction	2
Superior Performance	2
Industry-Leading Energy Efficiency	2
System Optimization	2
Highest Quality	3
Lowest Installed Cost	3
Features and Benefits - Unit	11
Form, Function and Flexibility	11
Reduces Footprint when Stacked	11
Eases Retrofit, Renovation, and Replacement	11
Airside Options	12
Construction and Integrity	12
Engineered for Good IAQ	12
Sound-Sensitive Solutions	13
Provide Accurate, Tested Sound Data	13
Minimize Sound Source	14
Increase Operating Efficiency	14
Turnkey Control Solutions	14
Single-Source Responsibility	15
Single-Point Power	16
Reduced Installation Costs	16
Reliable Operation	16
Open Protocol	17
Service Module	17
Proven Performance	17
AHRI Standards	17
Miami/Dade County Notice of Compliance (NOA)	18
UL Listing	18
IBC Seismic Certification	18
AMCA Certification	18
Canadian Registration Number (CRN)	18
ISO Certification	18
HVAC Design Fundamentals	19
Provide Proper Ventilation	19
Maintain Building Pressure	19
Protect Coils from Freezing	20
Filter Contaminants	21
Particulate Filter Guidelines	21
Gases and Vapors	22
Minimize Microbial Growth	23
Water Management	23
Dehumidification	24

Humidification	25
Provide Quiet Comfort	25
Application Considerations	27
Air Handler Design	27
Single-Path Design	27
Dual-Path Design	28
Standard AHU Arrangements	29
Draw-Thru Arrangements	29
Blow-Thru Arrangements	29
Stacked Units	30
Arrangements for Specific Applications	30
Building Pressurization	30
Building Pressurization with Return Fan and Economizer	30
Building Pressurization with Exhaust Fan and Economizer	31
Building Pressurization with Barometric Relief Economizer	32
Dehumidification	32
Dehumidification with CDQ™ (Cool, Dry, Quiet) Desiccant Wheels	33
Dehumidification with Coil Runaround Loops	33
Dehumidification with a Split Dehumidification Unit (SDU)	34
Dehumidification with Hot-Water Heat-Recovery Coils	37
Energy Recovery	37
Energy Recovery with a Total Energy Wheel	37
Energy Recovery with Coil Runaround Loops	39
Energy Recovery with Air-to-Air Plate Frame Heat Exchangers	40
Acoustics	41
Components and Options	42
Access/Blank and Turning Section	42
Blender	42
CDQ™ Desiccant Dehumidification Wheel	43
Coils	44
Coil Optimization	44
Drain Pans	45
Electric Heat	45
Integral Face-and-Bypass Coil	45
Dampers	46
Face-and-Bypass Dampers	46
Traq™ Dampers and Low Flow Traq Dampers	49
.....	49
Diffuser	49
Discharge Plenum	50
Economizer	50
Energy Recovery	50

Energy Wheels	51
Coil Runaround Loop	51
Air-to-Air Plate Frame Heat Exchanger	52
Fans	52
Fan Choices	52
Constant Volume vs. VAV Systems	53
Airflow Measuring Systems	54
Filtration and Air Cleaning	54
Filtration Options	54
Air Cleaning Options	55
Gas Heat	56
Humidifier	56
Inlet Hood	57
Mixing Box and Economizer	57
Multizone	58
Silencers	58
General Data	59
Unit Size 3	59
Unit Size 4	62
Unit Size 6	66
Unit Size 8	70
Unit Size 10	74
Unit Size 12	78
Unit Size 14	82
Unit Size 17	86
Unit Size 21	90
Unit Size 22	94
Unit Size 25	97
Unit Size 26	101
Unit Size 30	104
Unit Size 31	108
Unit Size 35	111
Unit Size 36	115
Unit Size 40	118
Unit Size 41	122
Unit Size 50	125
Unit Size 51	129
Unit Size 57	132

Unit Size 58	136
Unit Size 66	139
Unit Size 80	143
Unit Size 100	147
Unit Size 120	151
Coils	155
Drain Pans	155
Coil Connections	155
Hydronic and Steam Coil Connections	155
Refrigerant Coil Connections	156
Coil Circuiting	160
Distributor Arrangement	160
Distributor Circuiting	160
Face-Velocity Limits for Moisture Carryover	165
Performance Data	170
Air-to-Air Plate Heat Exchangers	170
Blenders	171
Dampers	172
Energy Wheel Dampers	172
Mixing Box Dampers	174
Mixing box with airfoil blade dampers	174
Mixing box with Traq dampers	176
AMCA 610 Test Performance for Traq Damper	178
Multizone Dampers	178
Diffuser	179
Discharge Plenums	180
Horizontal or Vertical Discharge Plenum with Factory Openings	180
Economizer for Outdoor Units	182
Electric Heat	183
Filters	184
Gas Heat	187
Hoods	187
Humidifiers	188
Multizone	190
Silencers	190
Trane Catalytic Air Cleaning Systems (TCACS)	191
Electrical Data	191
Mechanical Specifications	192

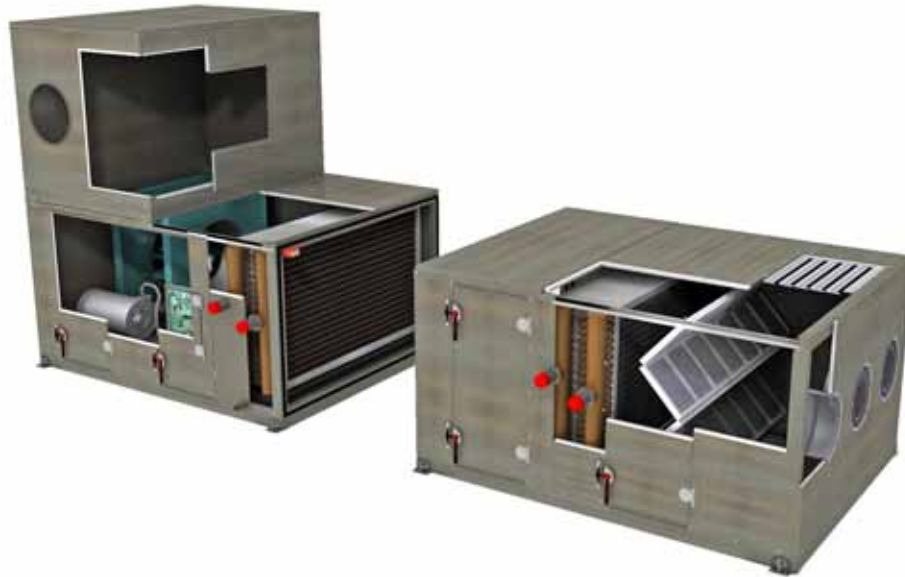
Seismic Certification	192
Unit Construction	193
Casing Construction	193
Unit Flooring	193
Casing Leakage	193
Insulation	193
Drain Pans	193
Access Doors	194
View Windows	194
Marine Lights	194
Fans	194
FC Fan	195
BC Fan	195
AF Fan	195
Belt-Drive Plenum Fan	195
Direct-Drive Plenum Fan	195
Fan Isolation	195
1-Inch, Seismic Spring Isolators	195
2-Inch, Seismic Spring Isolators	195
Fan Drives	195
Fan Motors	196
Motor Options	196
Grease Lines	196
Fan Section Options	196
Multiple Belt Drive	196
External Motor Junction Box	196
Motor wiring conduit	196
Flow Meter	196
Belt Guard	197
Door Guard	197
Fan Modulation	197
Variable-Frequency Drives (VFDs)	197
Inverter Test	197
Coils	197
Horizontal and Vertical Coil Sections	197
Inspection Section	197
Water Coils (UW, UU, W, 5W, 5A, WD, 5D, D1, D2, P, or TT)	197
Refrigerant Cooling Coils (UF, FD)	198
Steam Heating Coil (NS)	198
Coil Coating	198
Electric Heat Coil Section	199
Integral Face-and-Bypass Coils	199
Dampers	200

Barometric Relief Dampers	200
Energy Recovery Wheel Section	200
Performance and Certification	200
Wheel Construction	200
Wheel Motor	201
Maintenance and Access	201
Wheel Control	201
Frost Control	201
Wheel Warranty	201
Cool Dry Quiet (CDQ™) Desiccant Wheel	201
Wheel Construction	201
CDQ Wheel Drive System	201
Maintenance and Access Doors	202
Humidifiers	202
Direct Steam	202
Atmospheric steam	202
Filters and Air Cleaners	202
Permanent Filters	202
Throwaway Filters	202
Pleated Media Filters	202
Bag Filters	202
Cartridge Filters	203
4-Inch High-Efficiency Filters	203
HEPA Filters	203
Ultraviolet (UVC) Lights	203
Air Cleaning Systems	204
Filter Section Options	205
Differential Pressure Gage	205
Mixing Section	205
Mixing Section, Filter Mixing Section, Airflow Measurement Station (Traq™ Dampers), and Economizer Sections	205
Dampers	205
Airflow Measurement Station (Traq Dampers)	205
Internal and External Face-and-Bypass Damper Section	206
Internal Face Damper Section	206
Gas Heat Section	206
Air-to-Air Plate Frame Heat Exchanger	206
Construction	206
Performance	206
Corrosion Coating (Optional)	207
Frost Damper (Optional)	207
Bypass Dampers (Optional)	207
Multizone Sections	207
Two-Deck Multizone	207
Three-Deck Multizone	207

Double-Duct Section	207
Triple-Duct Section	207
Paint Options	208
Outdoor Unit Paint	208
Optional Indoor Unit Paint	208
Pipe Cabinet	208
Outdoor Unit Roof	208
Silencers	208
Other Sections and Options	208
Access/Inspection Sections	208
Blender Section	208
Diffuser Section	209
Turning and Discharge Plenum Sections	209
Plenum Attenuation Panels	209
Controls	209
Combination Starter–Disconnects	209
Combination VFD and Disconnects	209
Starter/Disconnect or VFD Enclosure Options	210
Factory-Mounted DDC System	210
Direct Digital Controller	210
Factory-Mounted Control Options—Electronic End Devices	210
Field-Mounted Control Options	212

Features and Benefits - Unit

Figure 1. Trane Performance Climate Changer™ air handler



Form, Function and Flexibility

Flexibility and versatility are standard in the Performance air handler. As a customizable cataloged air handler, standard components can be arranged to meet most commercial, institutional and industrial applications for the indoor air handler market. Pre-engineered custom options expand that flexibility while ensuring proven, tested performance and dependability, and reducing the costs and long lead times associated with most custom units. Some projects call for an air handler that incorporates new, emerging technologies or a job-specific requirement. Trane's experienced team of professionals can tailor the Performance air handler to meet these requirements.

The Performance air handler design adopts a "building-block" approach that allows you to design a unit specifically for your project. Choose the "blocks" you need from the wide range of standard and custom-engineered sections, and arrange them to satisfy the air-handling requirements of the application.

Reduces Footprint when Stacked

The Performance unit's design makes it easy to stack sections - even coil sections. Reducing the unit footprint is very advantageous, especially in tight mechanical rooms or limited roof space. The structural integrity remains intact, even when panels are removed for service or maintenance activities.

Eases Retrofit, Renovation, and Replacement

Buildings age, usage changes, loads change, new technology emerges, codes and standards are revised. Change is inevitable. The Performance air handler readily lends itself to the special needs of the renovation, retrofit, and replacement markets. The Performance air handler can be shipped in small segments that can easily be moved into tight spaces of existing buildings.



Features and Benefits - Unit

Airside Options

Many standard options are available for specific applications, including:

- Exhaust or return fan economizers
- Direct space pressurization control
- Thermal break double-wall access doors
- Thermal break casing
- Factory-mounted and run-tested controls
- Versatile access section lengths to meet specific needs
- Multiple belt drives
- Full array of pre- and final filter sections
- Extended grease lines
- Single-point power
- LED service lights
- Variable sizes, types and opening locations for discharge plenums, plenum fans, and mixing boxes
- Variable height vertical discharge plenums
- Variable length horizontal discharge plenums
- Positional controls section
- Multiple base frame heights/multiple curb heights
- Single-handle, multiple latch doors
- External motor junction box
- Low-flow Traq dampers
- Silencers
- Gas heat
- Flush-mounted dial-type filter gauge
- Stainless steel inner liners
- Treadplate floor

Construction and Integrity

Trane engineered panels and doors incorporate mid-span, internal thermal breaks to eliminate thermal conduction paths from the interior of the air handler to the exterior. Likewise, door frames also feature thermal breaks to minimizing heat transfer.

The panels and doors are designed to provide extraordinary insulating capabilities for efficient and cost effective performance. Panels are formulated with interlocking seam features and integral gasket seals optimized to drive down casing air leakage. The Performance air handler design is capable of meeting an ASHARE 111 Class 6 leakage level, better than most custom designs, up to +/-8 inches w.g. Standard double-wall panels and doors include two-inch closed cell foam insulation providing a minimum R-value of 13, in addition to unsurpassed panel strength and L/240 deflection at +/- 8 inches w.g.

The no-through-metal design and low casing air leakage delivers thermal performance that assures condensation will not form on the casing exterior even under 55°F supply air temperature and design conditions on the unit exterior of 81°F dry bulb and 73°F wet bulb. In addition to the low air leakage, these standard features prevent equipment from unnecessarily creating slip hazards in the mechanical equipment room or premature corrosion of the casing. With this level of casing performance and thorough testing of Trane engineers, Trane is able to deliver predictable thermal performance and key guidance to consulting engineers.

Heavy-duty door handles and hinges are surface-mounted, eliminating a potential leakage path since they do not pierce the casing. A removable hinge pin allows for easy door removal; the symmetrical handle and hinge mounting allows for easy field modification if it becomes necessary to change from a left-hand to a right-hand door.

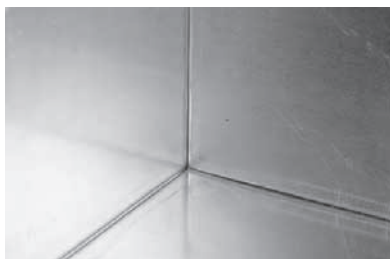
Engineered for Good IAQ

The building industry is continuously evolving and the rate of change is accelerating. The Performance air handler is engineered to address today's multifaceted design issues required to provide good indoor air quality (IAQ). Building owners must give particular attention to maintaining and documenting IAQ to ensure occupant comfort and to meet industry and government regulatory standards.

In Standard 62.1, the American Society of Heating, Refrigerating, and Air Conditioning Engineers (ASHRAE) provides guidance regarding suitable outside air volume to be brought into the building, recommended air filtration, and design recommendations and procedures to control microbial growth. However, applying these principles may lead to greater energy consumption, larger and noisier units, and increased risk of coil freeze-up. The flexibility of the Performance air handler enables you to configure a unique, IAQ-ready air-handling system that can address all of these concerns.

Serviceability/Cleanability

Figure 2. Smooth, interior surfaces make cleaning easy



- Full-size access doors and access sections are available for easy cleaning of internal components
- Fully removable coil and access panels
- Smooth, cleanable interior double-wall surfaces help improve indoor air quality.
- Coils are raised up out of the drain pan to make all coils removable from the side and provide easier access to the drain pan for cleaning.
- Optional antimicrobial treatments for drain pans and filters.

Sound-Sensitive Solutions

Figure 3. Schools and auditoriums are low noise criterion (NC) applications



Acceptable space sound levels enhance occupant comfort and productivity. However, system designs that promote good IAQ can adversely affect acoustics: unlined ductwork, air handlers with solid double-wall construction, and increased fan static pressures (resulting from the addition of energy recovery and increased filtration) can magnify the building's background noise.

Trane air handlers have unique product flexibility that allow designers to use them in many low-NC (noise criteria) applications.

NC curves define not-to-exceed limits for a noise source to achieve a level of occupant acceptance. (See applications engineering manual FND-AM-5, "Acoustics in Air Conditioning," for more information about NC levels.) Performance air handlers can be used successfully in NC 35 offices and schools.

Provide Accurate, Tested Sound Data

Traditionally, ASHRAE algorithms have been used to predict the sound power levels of air-handling units. Although this method is easy to do, it can be inaccurate. It can produce results that deviate from tested data by as much as ± 15 dB. For more accurate sound data, AHRI has established Standard 260, which is a method of rating sound data for ducted air-handling equipment. It is intended to be a guide for the industry, including HVAC manufacturers, engineers, installers, contractors, and consumers. AHRI Standard 260:

- Strengthens testing and calibration procedures
- Provides repeatable results
- Uses a reverberant-room approach, a mapped sound-rating concept, and reference sound-source calibration
- Is application driven
- Includes ducted outlet, ducted inlet, and casing (radiated) test configurations

It is important to note that sound data for Trane air handlers is taken per AHRI Standard 260. This sound power standard covers eight octave bands (63–8000 Hz) and is unweighted (no dB corrections). AHRI Standard 260-tested sound data can be found in TOPSS.

Features and Benefits - Unit

Minimize Sound Source

Trane air handlers have many features to optimize the source sound level for job requirements while minimizing the cost of the air handler including:

Figure 4. Plenum fans help reduce noise levels



- A variety of fan types to minimize the sound generated by the fan and to optimize cost no matter the application.
- Double-wall perforated insulation helps attenuate high-frequency noise.
- Two-inch discharge plenums reduce turbulence and create an end reflection that dampens low-frequency sound. The 2-inch perforated liner option attenuates higher frequency sound.
- Turning modules used to turn the air and reduce turbulence work as effective, low-cost silencers.
- Silencers for horizontal or vertical discharge in the plenum fan section come in 3-ft. and 5-ft lengths. They are dissipative or film-lined for hospital and clean-room applications.

For more information on how to apply these options in your air handler, contact your local Trane sales representative.

Increase Operating Efficiency

The Trane EarthWise™ system is a design philosophy that uses low flow rate and low temperature on both the waterside and airside, along with high-efficiency equipment. Along with reducing emissions, it also reduces first cost, lowers operating costs, and improves the acoustical characteristics and comfort of the HVAC system. Low-temperature, low-flow systems can challenge conventional cataloged air-handling units. The flexibility of the Performance air handler makes it ideally suited for low temperature applications. In addition:

- Trane has developed a unique high-efficiency fin surface that allows face velocities in excess of 625 fpm without moisture carryover. The fins have been engineered and tested to meet these higher face velocities at a given set of design conditions. This allows you to utilize the latest in airside heat transfer to further improve the efficiency of the overall system by lowering the coil approach temperature.
- The ability to choose the exact number of fins per foot of coil surface allows heat transfer and air-pressure-drop performance to be tuned to specifically meet project needs.
- The wide array of fan options lets you choose the right fan for the application.
- Factory-engineered, -mounted, and -tested controls provide the added insurance that the airflow sensors and sequences meet your requirements.
- Further system enhancements can be made by taking advantage of the latest controls technology with fan pressurization control (required in most variable-air-volume systems per ASHRAE Standard 90.1) and/or ventilation reset of the outside air damper based upon occupancy levels in the space.

Turnkey Control Solutions

Trane air handlers offer one of the most comprehensive factory-packaged controls systems available, from end devices to total system integration, with industry-standard open protocols. An air handler turnkey control package can be used in a stand-alone operation, or it can be fully integrated into a comprehensive control system. Trane's Integrated Comfort™ system (ICS) incorporates the benefits of factory-installed controls and links the air handler to the Tracer Summit™ building management system.

These options are designed to lower installation costs and risk while dramatically improving the quality of the application and the performance of the air handler. The entire air handler control system is engineered, mounted, wired, and tested before leaving the factory. As a result of strict quality manufacturing methods, Tracer control options bring consistency and reliability to the control-system package and provide single-source responsibility.

The following control devices are available as standard mounted on fan sections or within the positional controls section:

- Combination starters and disconnects
 - International Electrotechnical Commission (IEC) standards
- Variable-frequency drives (VFDs)
 - Drive/OFF/Bypass selector switch
 - Digital manual speed control
 - Three-year parts and labor warranty
 - Open drive to provide easy serviceability
- Unit-mounted direct digital controllers (DDCs).
 - A factory-wired and mounted Tracer programmable controller is available.

The following end devices are also available:

- Valves
- Electronic damper actuators
- Temperature and pressure sensors
 - Available in multiple temperature sensor materials
- Averaging temperature sensors
 - Available in multiple temperature sensor materials
- Fan and filter status switches
- Low-limit switches (see [Figure 6](#))
 - Double pole, single throw, manual reset
 - Available wired to low voltage and high voltage
- Condensate overflow switches
- Humidity sensors

Figure 5. Integral controls cabinet for starters, variable frequency drives, and unit controllers



Figure 6. Factory-mounting ensures quality installation, as shown with the low-limit radius bend



Single-Source Responsibility

Equipment and interoperable controls, engineered and provided by a single manufacturer, provide faster construction cycles and simplify job-site coordination efforts. This simplification reduces installation time, expense, and risk. Trane equipment and controls package provides the optimal performance when integrated with a Tracer building management system, forming a Trane Integrated Comfort™ system (ICS). ICS is a powerful system architecture that unifies Trane HVAC equipment, direct digital control, and building management into a cohesive whole with an assured source of support. This system is managed with the Tracer Summit building management system.

The Tracer Summit building management system is based on ASHRAE and American National Standards Institute (ANSI) BACnet Standard 135.

Features and Benefits - Unit

Single-Point Power

For air-handling units requiring a supply fan with a return/exhaust fan, electric heat, gas heat or CDQ, we can supply single-point power. Single-point power wiring includes a high voltage distribution block and main unit disconnect with lockout/tagout capabilities. From a single line voltage connection, power is provided to all components including controls and service lights. Single-point power wiring does not compromise the UL or ETL certification of the unit.

Reduced Installation Costs

Figure 7. Quick-connect wiring



While the air-handling system is in the factory, trained technicians install the control end devices and controllers using state-of-the-art equipment and agency-approved wiring practices. The system is pre-designed, pre-engineered, and checked out, making jobsite installation and commissioning fast and easy.

While many of these tasks and procedures could be done in the field, it is beneficial to do them in the factory due to time and accessibility constraints. As a result, field expenses for installation costs of conduit and wire are minimized, additional lead-time is alleviated, and jobsite coordination is simplified. Casing integrity is also maintained by minimized penetrations.

Factory wiring minimizes installation costs, too. Quick-connect wiring (see [Figure 7](#)) ensures integrity between sections without having to identify or check continuity.

After installation, Tracer controllers enable information-sharing and complex control strategies, such as ventilation reset, throughout the HVAC system. They also ensure that each subsystem operates in the most efficient manner possible while continuing to satisfy current loads. The result is reduced building energy consumption through effective operation of the entire HVAC system at part-load conditions.

Trane ICS incorporates the latest energy-saving concepts to produce comfort at the lowest possible cost. In addition, it offers sophisticated building management features, such as after-hours billing, for commercial properties. This revenue opportunity enables developers and owners to accurately monitor and bill the cost incurred by a single tenant in after-hours usage of a facility. An optional DDC variable-air-volume (VAV) capability helps to accurately control each tenant space so that only an individual tenant's HVAC systems are activated. This helps minimize operating costs while providing flexible work hours.

Reliable Operation

Controller end devices, such as low-limit switches and averaging temperature sensors, are properly sized, selected, laboratory-tested, and mounted for optimal system performance. Trane engineers its unit-mounted controllers to provide the highest level of useful information possible. A computer-based test station tests low-voltage end-device functionality and surveys the input devices. This procedure ensures trouble-free installation and reliable operation when the Performance air handler reaches the job site. This feature can limit the number of call-backs and punch-list tasks.

Incorporating a Performance air handler with Trane ICS provides an engineered system of proven components and comfort concepts that is both state-of-the-art and reliable. Standard components are used to aid in serviceability and uniformity from building to building. These components, when tied to a Tracer Summit system, provide a powerful tool for scheduling preventive maintenance, reducing equipment downtime, and controlling service expense.

Open Protocol

Trane Tracer™ controllers bring open communication protocols to the product offering. For building-level and unit level communications, Tracer controllers use BACnet®. BACnet is a standard, open communications protocol that allows integration and interoperability, enabling the controllers to not only tie into a Tracer Summit system, but also other building automation systems.

At the unit level, Trane can also use LonTalk® for peer-to-peer communication between Trane controllers and other approved LonTalk controllers. Trane can provide a factory-wired terminal strip that can be wired into a field-mounted controller. The programmable controller (MP581) follows the certified Space Comfort Controller (SCC) profile for constant-volume systems and the Discharge Air Controller (DAC) profile for constant-volume or VAV systems. Adherence of this controller to these standardized, certified profiles enables it to communicate with other controllers that use the same certified LonTalk profiles. Go to www.lonmark.org for more information.

Service Module

Figure 8. The service module can include a 15-amp GFCI.



Performance air handlers can be equipped with an easy access Service Module when a Trane programmable controller and/or service lights are factory mounted. All service lights are wired to a common switch within the Service Module, located either on the fan section or the controller cabinet. The Service Module can also include a 15-amp ground-fault circuit interrupter (GFCI) receptacle separate from the load side of the equipment, a National Electrical Code (NEC) requirement. When an MP580 controller is factory mounted, the Service Module will have communications and portable display ports allowing service personnel to perform diagnostics without opening the unit or controller panel.

Proven Performance

AHRI Standards

Figure 9. AHRI Standard 430



Figure 10. AHRI Standard 410



Trane combines comprehensive performance certification by AHRI with thorough laboratory testing and advanced manufacturing methods. Together, these elements help assure that each Trane air handler operates predictably and reliably throughout the life of the unit.

Unlike other rating methods that check fan performance alone, Trane units are performance-tested in accordance with AHRI Standard 430. This certification process evaluates the air handler on the basis of airflow, static pressure, fan speed, and brake horsepower.

Heating and cooling coils are rigorously tested and certified with AHRI Standard 410 to assure that they, too, deliver published performance.

AHRI Standard 260 is the first ducted-air-handler sound rating procedure. It is intended to provide engineers with better, more accurate, ducted sound power levels so that they can design quieter and more cost-effective comfort systems. Sound ratings for Trane air handlers have been developed from extensive AHRI Standard 260 testing and laboratory data.



Features and Benefits - Unit

Miami/Dade County Notice of Compliance (NOA)

Performance Climate Changer air handlers size 3-30 are approved and have been designed to comply with the High Velocity Hurricane Zone of the Florida Building Code. Each qualified unit shall bear a permanent label with the Trane name and logo and the statement “Miami-Dade County Product Control Approved.” Notice of compliance and additional product construction details can be found at the Miami-Dade County, Building Code Compliance Office Web site, under NOA No. 11-0926.08). Testing is currently underway for unit sizes 35-120.

UL Listing

Trane air handlers are UL-listed to U.S. and Canadian safety standards.



IBC Seismic Certification

Air handling equipment manufactured by Trane is capable of structurally and operationally withstanding the seismic response criteria as required by the International Building Codes (IBC) 2000, 2003, 2006, 2009. Trane has third-party certification for IBC compliance for seismic applications for unit sizes 3-30. Certification for larger sizes is in process.

AMCA Certification



Trane utilizes AMCA certification for airflow measuring stations. Trane certifies that the Traq™ damper shown herein is licensed to bear the AMCA Seal. The ratings shown are based on tests and procedures performed in accordance with AMCA Publication 611 and comply with the requirements of the AMCA Certified Ratings Program.

This certification program provides the engineer and owner assurance that manufacturer-published performance ratings for airflow measurement stations are accurate and repeatable. Trane Traq dampers are certified with the integral ventilation control module (VCM) which converts differential pressure to an electronic signal for control.

Canadian Registration Number (CRN)

The Canadian Registration Number, or CRN, is given to companies that comply with Canada’s Technical Safety Standards Act concerning pressure vessel safety. In Trane air-handling systems, the CRN applies to coils classified as Category H fittings. Most government and industrial customers require the HVAC supplier to have a CRN. Trane has earned a CRN for all steam and water coils. used in the Performance air handler.

ISO Certification



Certification by the International Standardization Organization (ISO) ensures that an organization can consistently deliver a product or service that meets the customer’s contractual requirements by following documented processes. The ISO 9001 quality assurance model establishes the requirements for an organization whose business processes range from design and development to production. Having the quality management system of our manufacturing plants ISO 9001-certified directly benefits Trane customers because our continuous process improvements can reduce business costs, improve product quality, and enable faster ship cycles

HVAC Design Fundamentals

In essence, an air-handling unit, or AHU, is exactly what its name implies: a device that “handles” (moves and/or conditions) air. It accomplishes this based on the functions required by a given application, as well as the arrangement of components necessary for those functions.

Trane air handlers can accommodate an extraordinary degree of design versatility, but in order to apply that versatility to each unique application, an HVAC designer must:

- Design the air handler in a manner consistent with good HVAC design practices.
- Understand the impact of ASHRAE Standard 62.1, *Ventilation for Acceptable Indoor Air Quality*, and ASHRAE Standard 90.1, *Energy Standard for Buildings Except Low-Rise Residential Buildings*, on AHU functions and design.
- Know how specific components can address application requirements, with arrangements optimized for job requirements, thermal performance, and acoustical performance.
- Deliver the performance you have designed with a well-functioning control system.

Provide Proper Ventilation

Ventilation is the process of diluting the build-up of contaminants by introducing clean, fresh outdoor air into buildings. The lack of proper ventilation is identified as a leading cause of poor indoor air quality (IAQ) problems. ASHRAE Standard 62.1 sets the minimum ventilation rates and specifies basic HVAC equipment and system requirements to provide “acceptable indoor air quality.” ASHRAE Standard 62.1 is considered the standard of care for designers to assure good IAQ in commercial buildings.

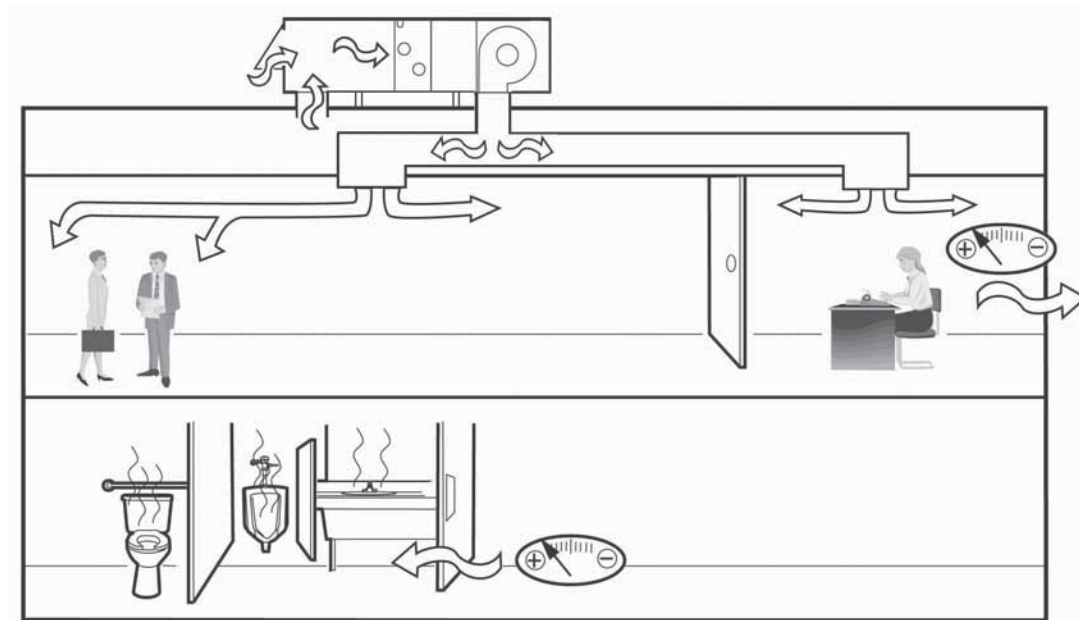
Assuring proper ventilation levels at all operating conditions can be challenging for a designer. Fixed outdoor-air damper arrangements on variable-air-volume systems can result in severe under-ventilation of the occupied spaces at part-load conditions. The Performance air handler is available with the patented Traq™ outdoor airflow measurement and control damper, which can precisely control the volume of ventilation air entering the system and even dynamically vary the amount in response to specific operating conditions. With the Traq damper, the amount of outdoor air can be continuously logged using a Tracer Summit™ building automation system to document proper ventilation.

Maintain Building Pressure

An important aspect of establishing outdoor-air requirements is equalizing outdoor-air and exhaust-air volumes to maintain proper building pressurization (see [Figure 11](#)). *Building pressurization* describes an air-handling strategy that regulates pressure differences across the building envelope and between zones or rooms by adjusting the amount of air that is supplied and removed. The goals of this strategy are to:

- Assure proper distribution of conditioned and ventilation air throughout the occupied space
- Avoid discomfort due to temperature stratification and drafts
- Prevent infiltration of unconditioned air
- Confine odors and contaminants to specific areas within the building

Figure 11. Maintain proper building pressurization



Building-envelope pressurization is typically achieved by incorporating either an exhaust fan and economizer or a return fan and economizer in the air handler design. Careful analysis is required to determine which approach best suits the unique requirements of each application. To better understand the differences between exhaust-fan and return-fan systems, consult your local Trane sales representative or refer to applications engineering manual, *Building Pressurization Control* (AM-CON-17).

Protect Coils from Freezing

Figure 12. Protect coils from freezing by addressing air stratification

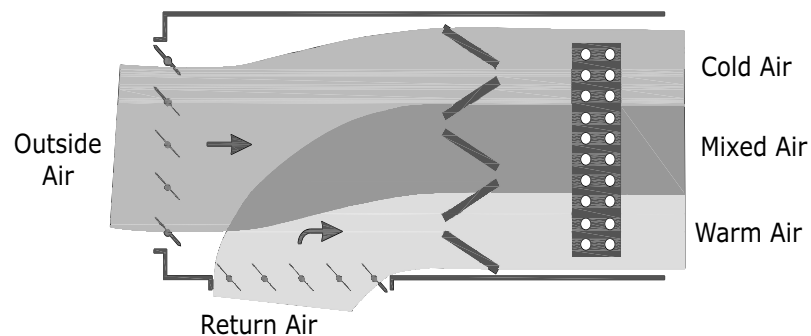
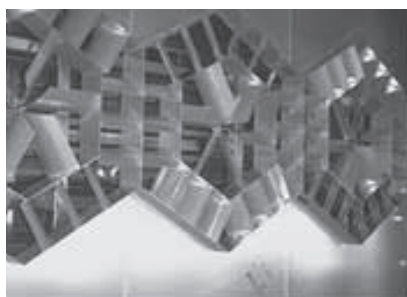


Figure 13. Low-limit sensor



Figure 14. Blender



When bringing more outdoor air into the air handler to satisfy the ventilation requirements of ASHRAE Standard 62.1, it increases the likelihood of air stratification (see [Figure 12](#)). If a layer of freezing air moves through the air handler, it can damage unprotected, hydronic cooling and heating coils. Traditional freeze protection includes a low-limit thermostat (see [Figure 13](#)) (installed on the face of the cooling coil) that trips when it detects a dangerously low air temperature. When this happens, it stops the supply fan, closes the outdoor air damper, and ultimately degrades the building IAQ.

It is important to design the air handler so that it effectively treats the required amount of outdoor air—regardless of temperature—without risking coil damage, tripping the low-limit thermostat, or compromising indoor air quality. Trane has several means of providing coil protection. Choose the technique that best suits the application requirements.

- *Drain the coils.* This approach necessitates vent and drain connections on every coil, plus shutoff valves to isolate them from the chiller(s).
- *Add glycol and an inhibitor to the cooling system water.* The glycol lowers the water freezing point, and the inhibitor helps to resist corrosion.
- *Introduce ventilation air downstream of the cooling coil* with dual-path or bypass techniques.
- *Preheat the outdoor air stream.* Use a traditional or integral face-and-bypass steam coil or a hot hydronic coil to raise the air-stream temperature above freezing.
- Use a blender section (see [Figure 14](#)). This approach mixes the outdoor and recirculated air streams to address air stratification.

Filter Contaminants

Particulate Filter Guidelines

The Environmental Protection Agency (EPA) and ASHRAE recommend that the concentration of particulates in the air not exceed 0.05 mg/m^3 (measured as an annual mean). This guideline is established in an EPA PM-10 standard which focuses on smaller particulates (<10 microns) that are likely responsible for adverse health effects because of their ability to reach the lower regions of the respiratory tract.

ASHRAE Standard 62.1 and the U.S. Green Building Council LEED rating system emphasize the importance of including appropriate filters in the air handling system to effectively control particulate contaminants. Both establish minimum requirements for filter performance applied within a commercial building based on ASHRAE Standard 52.2, Method of Testing General Ventilation Air-Cleaning Devices for Removal Efficiency by Particle Size. This standard establishes a test procedure for evaluating the performance of air-cleaning devices as a function of particle size (0.3 to 10 microns). A minimum efficiency reporting value (MERV) is assigned to a filter based on its efficiency in three different particle-size ranges (0.3 to 1 microns, 1 to 3 microns, and 3 to 10 microns). A higher MERV rating indicates a greater ability to remove high quantities of small particles from air.

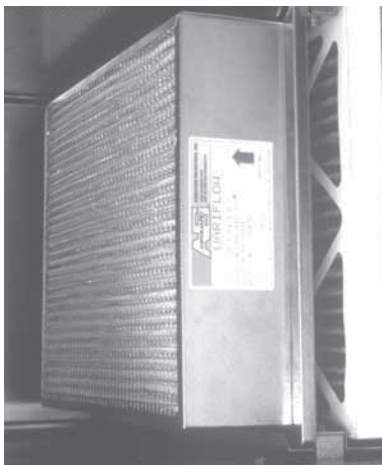
ASHRAE Standard 62.1 recommends a minimum MERV 6 filter, while the USGBC LEED rating system recommends a minimum MERV 8 during the construction cycle and MERV 13 during normal operation. National, state, or local codes established by government bodies or occupational groups may dictate more specific or stringent filtration requirements.

Selecting the appropriate filter relies on understanding the particles that need to be filtered and their size. [Table 1](#) provides design guidance for which filter option should be applied in your air handler.

Table 1. MERV ratings versus particle size efficiencies

MERV Value	Group 1 Avg. Eff.% 0.3 to 1.0 microns	Group 2 Avg. Eff.% 1.0 to 3.0 microns	Group 3 Avg. Eff.% 3.0 to 10.0 microns	General Applications
1	n/a	n/a	E3<20	
2	n/a	n/a	E3<20	Residential
3	n/a	n/a	E3<20	Light Commercial
4	n/a	n/a	E3<20	
5	n/a	n/a	20<35	
6	n/a	n/a	35<50	Commercial Industrial
7	n/a	n/a	50<70	Better Residential
8	n/a	n/a	70	
9	n/a	E2<50	85	
10	n/a	50<65	85	Commercial Telecommunications Industrial
11	n/a	65<80	85	
12	n/a	80	90	
13	E1<75	90	90	Superior Commercial Health Care
14	75<85	90	90	Hospitals
15	85<95	90	90	General Surgery
16	95	95	95	
17	99.7			Surgery, pharmaceutical manufacturing

Figure 15. Use proper filtration



Gases and Vapors

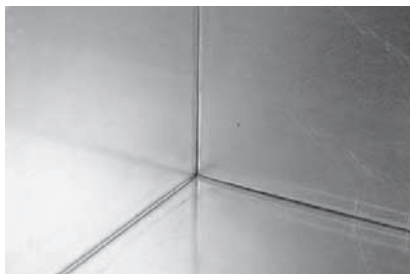
The presence of various undesirable gases and vapors (particularly formaldehyde, radon, oxidants, and volatile organic compounds, or VOCs) indoors can be detrimental to building occupants, materials, and contents. Controlling VOC concentrations is particularly challenging—hundreds of them are present, few are unique to any one source, and there are many potential sources, some of which emit several VOCs.

A common way to control gaseous contaminants is to dilute them with outdoor air. This approach is appealing because many VOCs defy individual treatment. However, it is only practical if the quality of the outdoor air is suitable *and* if the resulting supply airflow is consistent and appropriate *and* if it mixes effectively with the air in the occupied space.

Another approach is to neutralize the contaminants in the air. This can be done through air cleaning mechanisms UVc/PCO technology to reduce volatile organic compounds (VOC's) through photocatalytic oxidation without the creation of ozone or by-products.

Minimize Microbial Growth

Figure 16. Keep surfaces clean



Although filtration effectively removes a number of common particulate and gaseous contaminants from the building environment, microbiological, or *microbial*, contaminants such as fungi (mold and mildew) and bacteria are sometimes too small to be filtered entirely from the air stream. To help control microbial growth, design the air handler to include:

- Non-porous, cleanable interior wet surfaces
- Easy access to all areas of the air handler for inspection, service, and cleaning.
- Use of ultraviolet (UV) germicidal irradiation lights

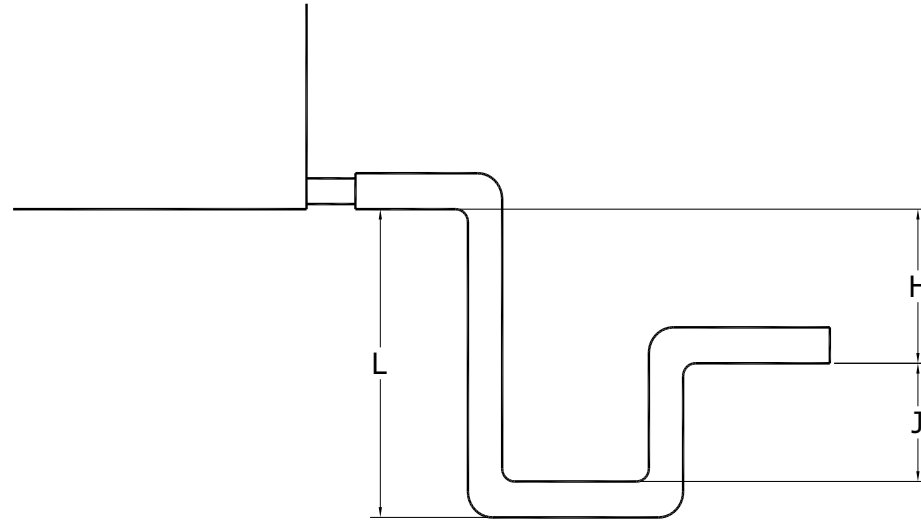
Regular cleaning and disinfecting with nonpolluting cleansers and antimicrobial coatings also helps, but none of these measures totally eliminates the growth of ever-present microorganisms. Consequently, moisture control becomes another important means of combating microbial contaminants.

Water Management

Cooling coils collect water from the passing air stream as they cool and dehumidify it. If not properly addressed, this condensed moisture encourages mold, mildew, and other microorganisms to colonize and breed. To reduce the likelihood of microbial growth:

- Reduce moisture carryover by sizing the cooling coils for proper airflow velocities. Trane coils can be sized for velocities in excess of 625 fpm without moisture carryover, depending on air conditions, coil size, and coil-fin type and spacing. Refer to “[Coils](#)” section on page 155 for the moisture-carryover curves and details about allowable velocities.
- Specify drain pans sloped in two planes to eliminate stagnant water conditions and to promote positive drainage.
- Locate coils on the second level of a stacked air handler to provide adequate trapping height.
- Properly size condensate traps to ensure proper drainage. See [Figure 17](#).
- Promote cleanability by providing adequate space around the unit, easily removable access panels, and a solid steel liner to isolate insulation from the air stream and to facilitate cleaning. Also, provide extended drain pans to allow for periodic cleaning.
- Condition the mechanical equipment room to prevent condensation on piping, ductwork, mechanical equipment, and other surfaces.

Figure 17. Drain pan trapping for positive and negative pressure applications



Drain pan trapping for section under negative pressure

$L = H + J + \text{pipe diameter}$ where:
 $H = 1 \text{ inch}$ for each inch of negative pressure plus 1 inch
 $J = 1/2 H$

Drain pan trapping for section under positive pressure

$L = H + J + \text{pipe diameter}$ where:
 $H = 1/2 \text{ inch}$ (minimum)
 $J = 1/2 \text{ inch}$ plus the unit positive static pressure at coil discharge (loaded filters)

Dehumidification

ASHRAE Standard 62.1 observes that “high humidities can support the growth of pathogenic or allergenic organisms” and suggests that the relative humidity of the occupied space not exceed 60 percent. Higher humidities also require lower supply-air temperatures for thermal comfort. Most climates require dehumidification to achieve this design goal. Dehumidification can be accomplished by removing moisture from the air, that is, condensing the water vapor on cooling coils.

However, cooling coils can over cool the occupied space when dehumidifying at sensible part-load conditions. There are several ways to control to both humidity and temperature at part load conditions.

- Use a VAV air handler versus a constant volume air handler. This can improve part load dehumidification.
- Use desiccant dehumidification systems to dehumidify and control humidity to very tight tolerances.
- Use a split dehumidification unit (SDU) to improve dehumidification by treating the ventilation air separately.
- Use a s Dedicated Outside Air Unit, DOAS, to dehumidify the ventilation air.

- Use a reheat coil, which can be accomplished using recovered condenser heat energy or with standard electric or hot water coils.

Humidification

Low relative humidity - below 30 percent - in an occupied space is also undesirable because it requires higher supply-air temperatures for thermal comfort and promotes static electricity. Raising the space humidity to an appropriate level requires a humidifier to inject water particles into the passing air stream. To avoid promoting microbial growth, the unit design must assure that the injected water is fully absorbed within the air handler *without* collecting on its walls or components.

Three types of commercial humidifiers are generally used in central-station air-handling systems: wetted media, atomized water, and steam. Of these types, ASHRAE Standard 62.1 prefers steam "as the moisture source for humidifiers." The temperature and pressure properties of steam make it easy to introduce directly into the passing air stream and encourages complete absorption in a short distance. Trane standard humidifier sections incorporate all the distance required for absorption to occur.

Application Considerations:

- Never position the humidification section immediately downstream of a housed fan or blow-thru coil section.
- Extra dispersion distance may be needed if the humidification section is placed upstream of a final filter or electric heat coil.
- Vertical airflow turns immediately upstream and downstream of the humidification section necessitate a large section.

Provide Quiet Comfort

Figure 18. Trane acousticians collect and test sound data



Acceptable sound levels inside a building can improve occupant comfort and productivity. In fact, achieving an acceptable acoustical environment today is almost as important as simply conditioning it. To meet space sound levels, be sure to optimize the noise source (the air handler) using path attenuation (ducts, wall, and room carpeting).

The sound source can be projected using Trane TOPSS selection program or with the Trane *CLCHL_w* program. The sound path can be projected using the Trane Acoustical Program (TAP). Compare the resulting NC projection with the designed value. If the NC projection is too high, the air handler can be made quieter with a selection focused on acoustics, or the path attenuation can be increased—or both strategies can be combined. In the end, the projection should meet the NC requirements for your job.

Creating quiet spaces is increasingly difficult because of the trend toward "IAQ-hardened" systems. "IAQ hardening" involves removing fiberglass insulation, which acts as a sound absorber, from inside the ducts and even the units. Without this insulation, the air handler makes too much noise.

With Trane's acoustic options and the TOPSS selection program, you can create the unit you need for your quiet application. With these options, you can select an air handler that is more than 20 dB quieter than a conventional unit. The starting point is the Trane AHRI Standard 260 sound database.

Trane sound power ratings cover eight octave bands (63–8000 Hz). Data is collected in one of Trane's ANSI 12.32-qualified reverberant rooms.

To determine the most cost-effective acoustical solution for a given application, follow these steps:

Select the unit and predict the unit sound power using the TOPSS selection program.

Project the sound to the space using TAP.

Optimize the unit sound (fan, plenums) with the path attenuation (ductwork and ceiling) for the lowest first cost that meets the sound requirements.

Table 2 summarizes the noise reduction ideas accumulated by Trane engineers during four decades of experience with central-station air handlers. Use the TOPSS program to predict the effect of each idea.

However, for acoustically sensitive applications, we strongly recommend that you work with your local Trane sales representative to find the most cost-effective solution that meets your job requirements.

Table 2. Noise reduction suggestions

Targeted Sound	Suggestions
Overall unit sound power (L_w)	<ul style="list-style-type: none"> • In VAV systems, use variable-frequency drives for fan modulation. • Change fan types. • Increase the fan size. • Use a central exhaust fan rather than a return fan.
Discharge sound power	<ul style="list-style-type: none"> • Use discharge plenums. • Use outlet silencers. • Use perforated walls. • Use multiple-discharge plenum outlet ducts. • Use discharge plenums with side openings.
Inlet sound power	<ul style="list-style-type: none"> • Use a large inlet plenum. • Use inlet silencers. • Stack the inlet sections.

Application Considerations

The first things to consider when selecting an air handler for any given application include:

- *Design.* Which overall system design best suits the required function?
- *Arrangements.* What is the best section arrangement for the specified function and layout?
- *Components.* Which components should be selected to support the function, layout, and arrangement of the application?

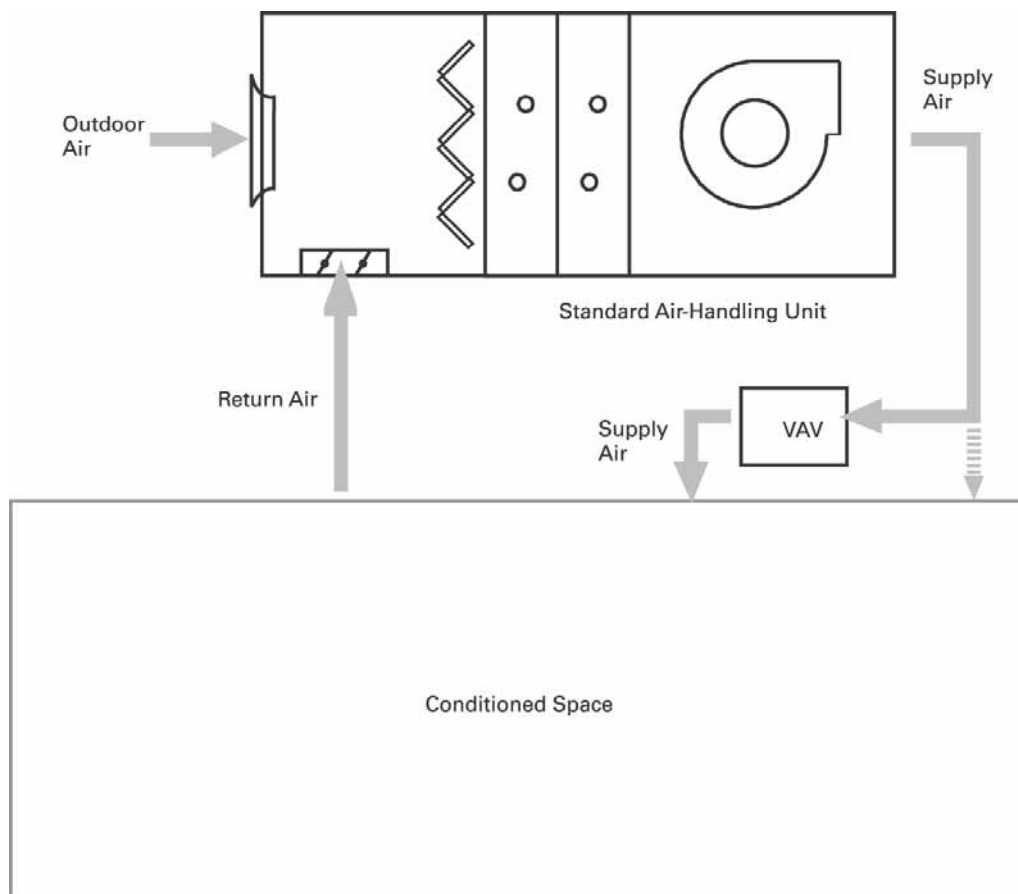
Air Handler Design

Which design best suits the application? After determining the required airflows and functions for a particular application, the HVAC designer must determine which one of two path layouts for outdoor air best serves the application: single-path or dual-path.

Single-Path Design

Single-path AHUs (see [Figure 19](#)) rely on one outdoor air path. Depending on application requirements, that path may provide ventilation air only or both ventilation air and economizing air for natural, non-mechanical cooling. Components for filtering and tempering the air are arranged in series. The single-path layout can accommodate passive or powered return- and/or exhaust-air paths as well as energy recovery.

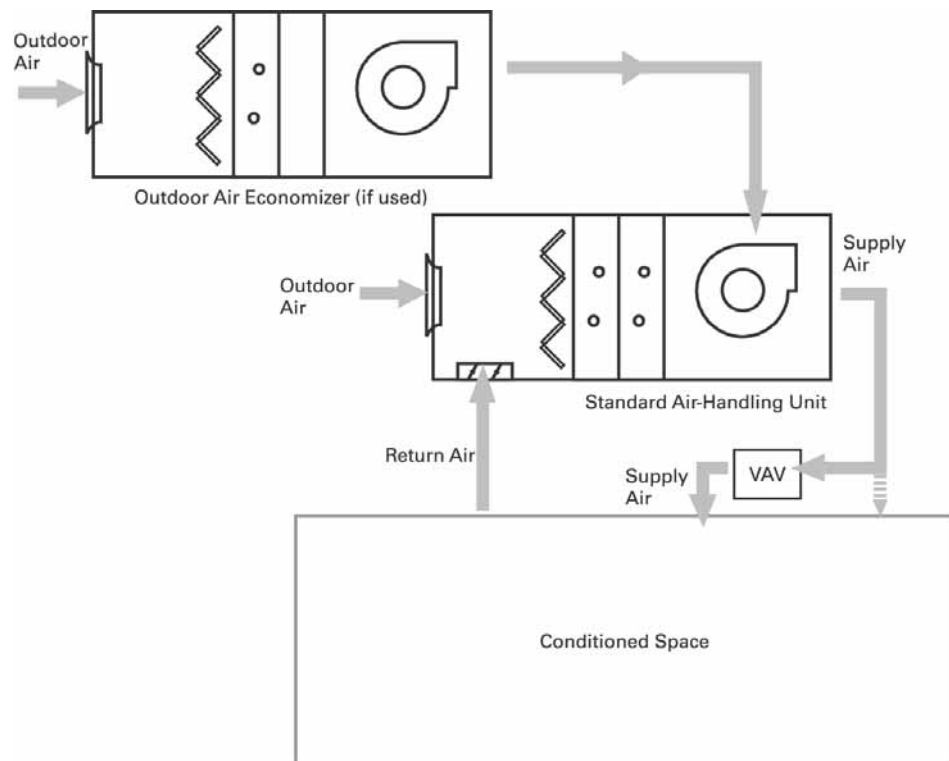
Figure 19. Single-path design



Dual-Path Design

Dual-path AHU (see [Figure 20](#)) layouts provide two air paths. Like a single-path design, dual-path designs can incorporate basic outdoor air, recirculation, exhaust-air, and energy-recovery functions. However, one path is dedicated to handling ventilation air to specifically address ASHRAE Standard 62.1 requirements. Each path is provided with its own air treatment components such as filters and heating and cooling coils.

Figure 20. Dual-path design



Application considerations:

- Reduces or eliminates reheat requirements, while providing an effective means of dehumidification for loads with low sensible-heat ratios (high latent cooling requirements)
- Avoids increasing supply-fan static pressure due to high pressure drop components in the ventilation air stream (increases latent cooling and filtration capacity without increasing fan size)
- Permits downsizing of the ventilation-path components
- Enables compliance with the ASHRAE Standard 62.1 requirement for measuring outdoor airflow without significantly increasing the first cost of the air handler
- Provides a cost-effective means to increase ventilation airflow in an existing system
- Reduces cost by reducing the number of units (dedicated outdoor-air units can be eliminated).

[Figure 20](#) represents a sample dual path configuration. For more design options, see Trane Application Engineering Manual for Dehumidification in HVAC systems (SYS-APM004-EN).

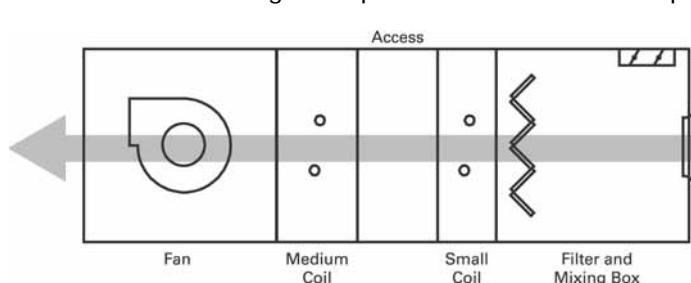
Standard AHU Arrangements

To complete the air-handling system, the sections must be physically arranged in a way that fits the available space. Conventional descriptions of air handler arrangements, *draw-thru* and *blow-thru*, reflect the means of establishing airflow through the coil based on the position of the coil relative to the fan: the fan either draws air through a coil located upstream or blows air through a downstream coil.

Trane adds another dimension to air handler arrangements, letting you combine sections by stacking them on top of each other in space-saving configurations, by coupling them together with transition panels, or by combining both techniques. Careful evaluation of the merits of each arrangement is a critical part of the design process.

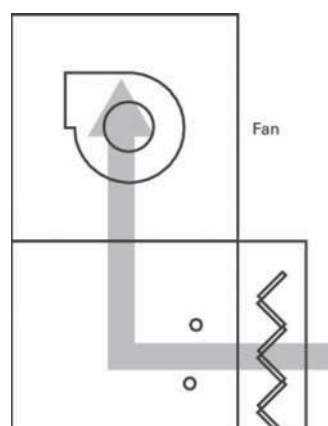
Draw-Thru Arrangements

A draw-thru AHU arrangement places the coils and filters upstream of a ducted supply fan. It can be single- or dual-path.



Horizontal Draw-Thru

Accepted system design practices are generally the only restrictions in a horizontal draw-thru application. However, certain application rules must be followed to promote proper airflow through filters and coils.



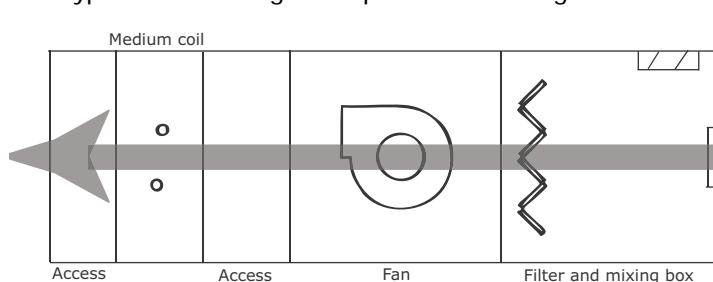
Vertical Draw-Thru

Trane air handlers in a vertical draw-thru arrangement typically result in a shorter footprint than horizontal draw-thru units. This arrangement stacks a fan on top of a vertical coil section. When designing an air handler in this configuration:

- The bottom deck must be equal to or longer than the fan section to avoid creating a “cantilever” effect.
- A vertical draw-thru fan performance curve should be used to account for the airflow impingement by a coil installed in a vertical coil section.

Blow-Thru Arrangements

This type of AHU arrangement places the cooling coil downstream of the supply fan.



Single-Zone Blow-Thru

This type of arrangement can provide only one supply-air temperature from the unit. To promote proper air distribution through each section and to reduce the risk of moisture carryover, certain application considerations apply based on the fan type.

Stacked Units

A stacked AHU arrangement can be either draw-thru or blow-thru. It places the air handler sections on top of each other. This strategy can significantly reduce the length of the unit and provide better acoustical performance, yet has very little effect on unit static pressure drops.

Application considerations:

- Stacked section weight must not exceed the maximum stacking weight of the casing.
- Ductwork and dampers must not interfere with stacked sections.
- “Upper-deck” sections cannot overhang lower sections.
- Intermediate support brackets should be used if the width of the upper deck is less than that of the bottom deck.

Arrangements for Specific Applications

Draw-thru and blow-thru arrangements for Trane air handlers can be engineered for specific applications, including those to maintain proper building pressure, dehumidify, and recover energy.

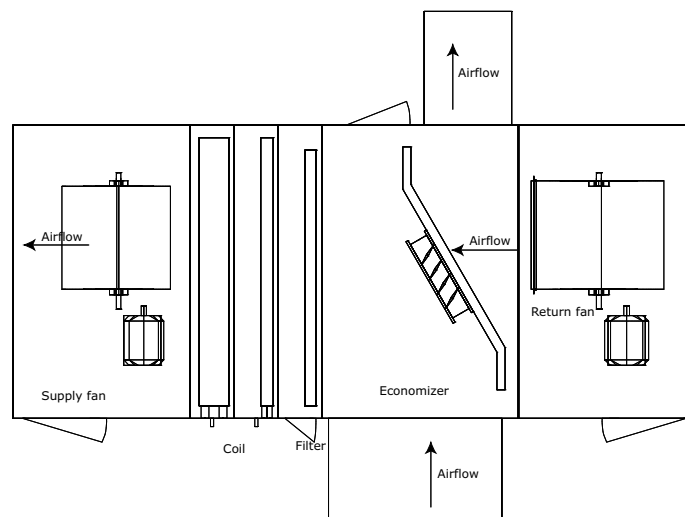
Building Pressurization

Return fans and exhaust fans are used to maintain building pressurization. A Trane air handler can include either of these components. To better understand the differences between exhaust-fan and return-fan systems, consult your local Trane sales engineer or refer to the Trane applications engineering manual, *Building Pressurization Control (AM-CON-17)*.

Building Pressurization with Return Fan and Economizer

Figure 21 depicts a standard air handler with a return fan and an economizer for outdoor air. The return fan typically runs continuously to balance the amount of air supplied to and removed from the occupied space. Although this approach makes precise space pressurization control more difficult, it is better suited to applications with high return static pressures than the exhaust-fan alternative. If the supply fan is unable to handle system static pressure, the return fan is sized to overcome the external static pressure of the return duct. Of course, the larger size and constant operation of the return fan also means higher first and operating costs.

Figure 21. Return fan and economizer arrangement for outdoor units



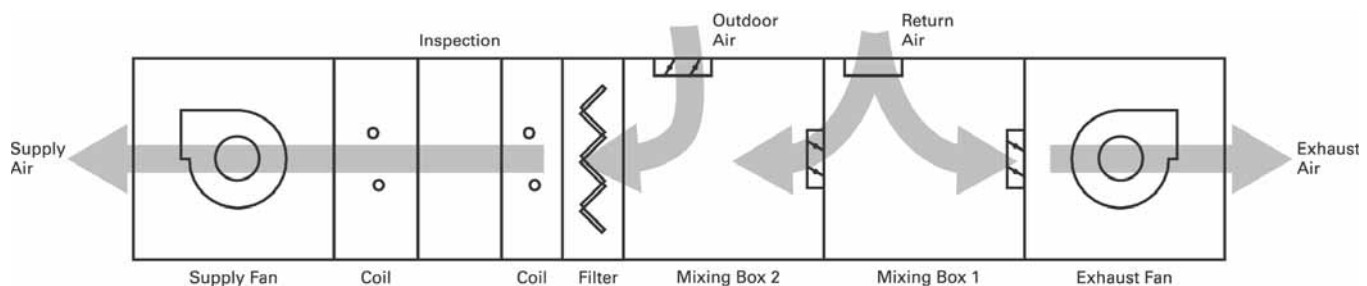
Application considerations:

- Size the *supply fan* to handle the static pressure requirements of a 100-percent *economizer* operation, including outdoor-air ductwork, dampers, filters, coils, other accessories in the outdoor air stream, and supply-duct static pressure.
- Size the *return fan* to handle the static pressure requirements of a 100-percent *return air* operation, including return duct, exhaust duct, and exhaust damper.
- Control the return fan to keep the outdoor/indoor static-pressure differential within design limits.
- Control the mixing box dampers to prevent all of them from closing simultaneously; otherwise, serious equipment damage could result.

Building Pressurization with Exhaust Fan and Economizer

Figure 22 depicts a standard air handler with an exhaust fan and an economizer for outdoor air. To balance the amount of air exhausted from the building with the amount of air brought into the building, the exhaust fan modulates, running at full capacity only when the economizer brings in 100 percent outdoor air. When the economizer is at minimum and the exhaust fan is idle, dampers on the mixing box close to prevent outdoor air from being drawn into the air handler through the exhaust section.

Figure 22. Exhaust fan and economizer arrangement



The exhaust-fan-and-economizer combination provides strict space pressurization control, provided that the supply fan is sized to handle total system static pressure. Its first cost and operating cost are usually lower than the return-fan-and-economizer alternative, too. (An exhaust fan requires less capacity than a return fan and runs less often.)

Application considerations:

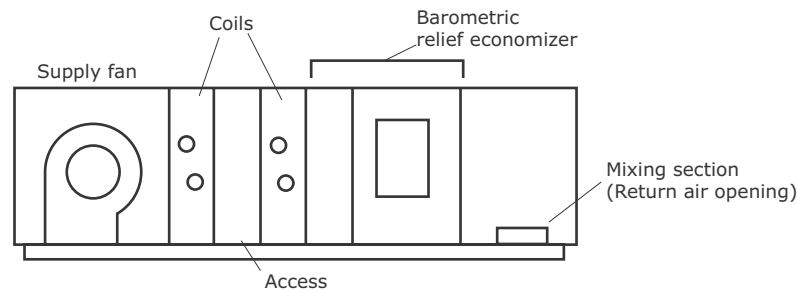
- Size the *supply fan* to handle the static pressure requirements of the higher of either a 100-percent *economizer* operation or 100-percent *return-air* operation.
- Size the *exhaust fan* to handle the static pressure requirements of a 100-percent *return-air* operation, including return duct, exhaust duct, and shutoff damper, when the unit is in full economizer mode.
- Control exhaust airflow to keep the outdoor/indoor static-pressure differential within design limits.
- Control the mixing box dampers to prevent all of them from closing simultaneously; otherwise, serious equipment damage could result.

Building Pressurization with Barometric Relief Economizer

Figure 23 depicts a typical air handler with a barometric relief economizer. Barometric relief offers some positive space pressure control. The equipment consists of an economizer section with a damper in the return air path that opens upon an increase in pressure difference between the space and the outside.

The supply fan must over-pressurize the space to allow for proper operation of the barometric damper. It should only be used in systems that have extremely low return air static requirements. In other systems, it is recommended that a powered system such as return fan or exhaust fan economizer be used instead of barometric relief.

Figure 23. Building pressurization with a barometric relief economizer arrangement



Application Considerations:

- Size the supply fan to handle 100 percent outside air operation (i.e. OA hood, OA dampers, filters, coil(s) and other accessories, plus supply air ductwork).
- Set up system for maximum delivery at 100 percent OA economizer mode. Turn on all remote exhaust fans. Measure the space static pressure, and adjust barometric relief damper to produce a slight positive space pressure.
- Only when the unit is at or near 100 percent OA (return air damper is closed) will the exhaust section become sufficiently pressurized to open the barometric damper.

Dehumidification

Excessive humidity in buildings can encourage mold and mildew growth and thermal discomfort. To cost effectively address these issues, first isolate the conditioned space from the unconditioned space. (See Trane applications engineering manual, *Managing Building Moisture*, SYS-AM-15.) Next, remove the humidity.

The two primary humidity sources in most buildings are people and outdoor air. In any coil-based HVAC system, it is the cooling coil that dehumidifies the air. This coil must be on and air must pass through it for dehumidification to occur. In Trane air handler enhanced dehumidification units, the priority for the cooling coil is humidity control. Temperature control is secondary and is generally provided by a separate reheat source.

Dehumidification can be obtained using:

- CDQ™ (Cool, Dry, Quiet) units with desiccant dehumidification wheels
- Series, coil run-around loops
- Split dehumidification units (SDU)

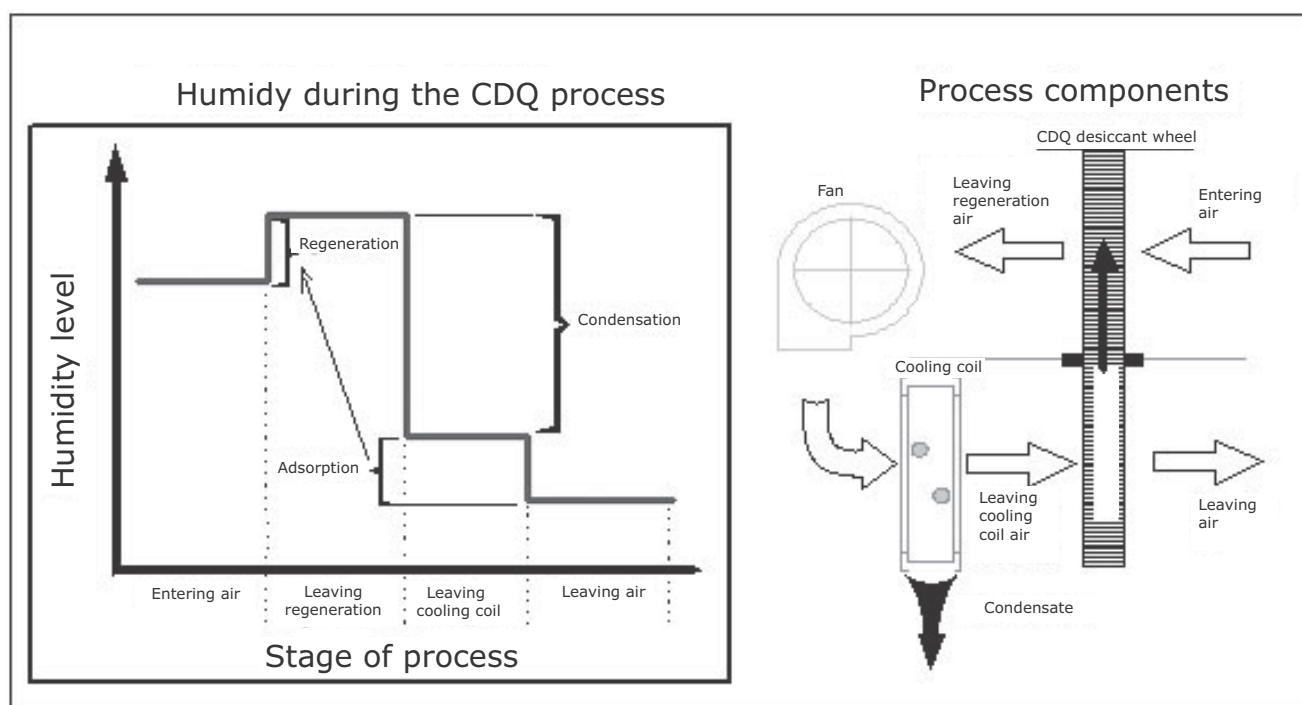
Free reheat options with dehumidification include:

- Hot water heat-recovery coils
- Refrigerant heat-recovery H coils

Dehumidification with CDQ™ (Cool, Dry, Quiet) Desiccant Wheels

The addition of the CDQ desiccant wheel to the system enhances the dehumidification performance of the traditional cooling coil (see [Figure 24](#)). The CDQ wheel transfers water vapor and the cooling coil does all the dehumidification work in the system. The latent capacity of the cooling coil increases without increasing its total cooling capacity. The system can achieve a lower supply air dew point without lowering the coil temperature. Unlike a system with a cooling coil alone, the dew point of the air leaving the coil can be lower than the dry bulb temperature leaving the coil.

Figure 24. Dehumidification with CDQ (Cool, Dry, Quiet) desiccant dehumidification units



Application Considerations:

- Increased cooling coil latent (dehumidification) capacity
- Lower achievable supply-air dew points.
- Decreased need for reheat
- Lower unit cooling sensible heat ratios.
- Warmer required chilled water temperatures.
- Improved energy efficiency for dehumidification.
- Decreased required cooling capacity when dehumidifying.
- Eliminates exhaust air as a requirement

For application guidelines concerning CDQ, refer to Trane engineering bulletin CLCH-PRB020-EN.

Dehumidification with Coil Runaround Loops

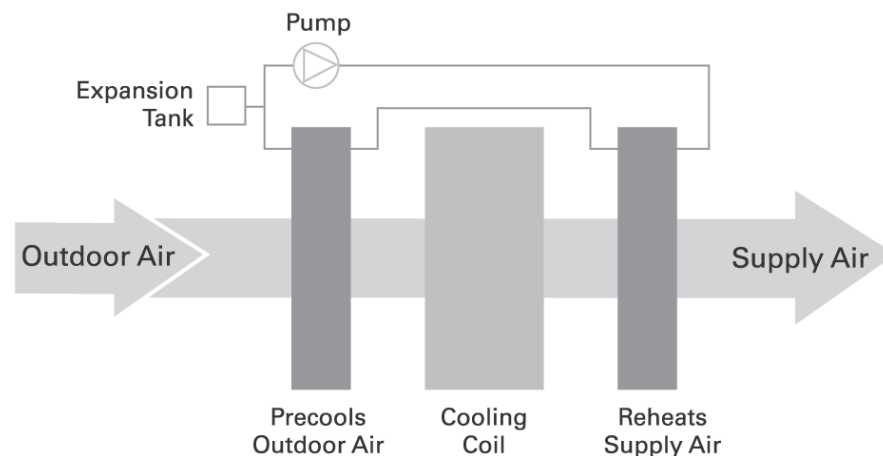
Series, coil run-around loops (see [Figure 25](#)) consist of finned-tube water coils connected in a closed loop that is “wrapped” around an active cooling coil. Operation is psychrometrically similar

Application Considerations

to the air-to-air, fixed-plate heat exchanger. The first coil in the loop precools the incoming outdoor air. The active cooling coil absorbs more heat from the air stream and further dehumidifies the air to the design point. The second coil in the loop is placed after the active cooling coil and reheats the air with the heat absorbed by the first coil. Loop components include a pump to move the fluid within the loop and an expansion tank.

Series, coil runaround loops occupy little space and have a relatively low first cost. Like the series air-to-air, fixed-plate heat exchangers, series coil loops are only effective during the cooling season. Additional heating may be required on cool, humid or cold days.

Figure 25. Series dehumidification with coil run-around loops



Application Considerations:

- Provide free reheat at design conditions
- Allow downsizing of new energy cooling and reheat coils
- Add a minimal pressure drop through each coil (only 0.3 to 0.6 in. wg)
- Are available in all Trane units
- Can be fully modulated by varying water flow

Dehumidification with a Split Dehumidification Unit (SDU)

The SDU is a dual-path, return-air-bypass air handler. It consists of two units that are stacked together in a draw-thru arrangement that share one supply fan (see [Figure 26](#)). All of the ventilation (outdoor) air is ducted to the upper unit where it is dehumidified, typically down to 50°F or lower.

The lower unit is sized to handle the return air needed to achieve the desired air-change rate in the space. The warmer return air in the lower unit mixes with the cooler, drier air from the upper unit. The resulting mixed air provides humidity control by achieving a sensible heat ratio (SHR) of down to 0.4, but also provides sensible reheat without using any new energy.

A vertical unit stacks the supply fan on top of a vertical coil module; the outdoor air enters the back of the fan module. This unit is shorter than the horizontal SDU.

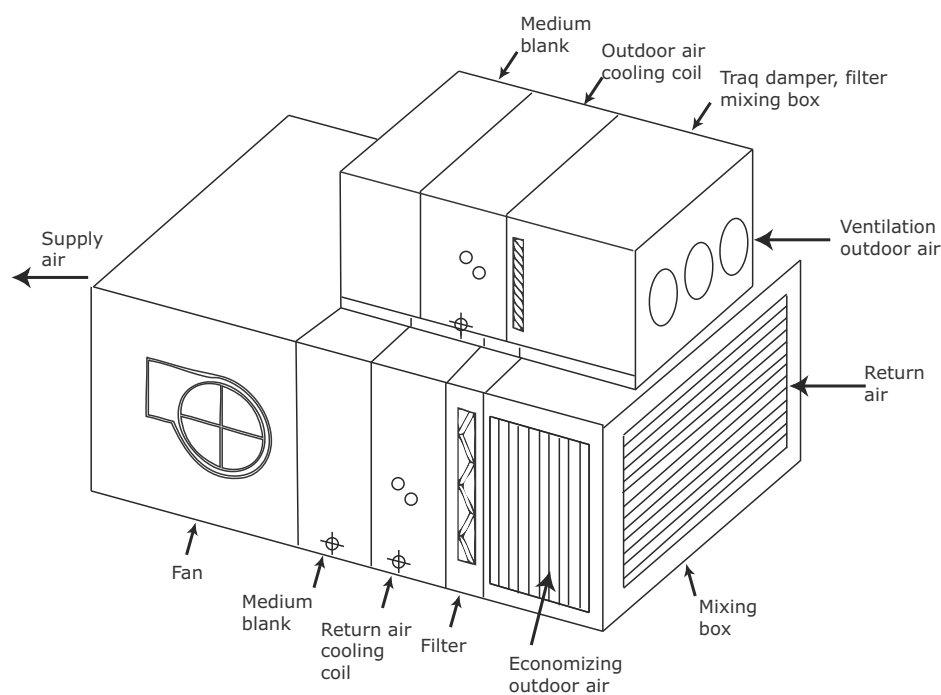
Outdoor air economizers can also be used with an SDU. Simply add a mixing module to the return-air unit and bring outdoor air into this mixing module when conditions permit economizing.

This configuration, sometimes called a “winterizer,” uses a combination of two different-sized air-handling units configured to allow the outdoor air to be introduced downstream of the cooling coil

whenever the outdoor air is colder than 32°F (0°C). The smaller air-handling unit, sized for the minimum required ventilation airflow, contains filters and possibly a small preheat coil.

This “winterizer” configuration removes the length and pressure drop associated with a preheat coil from the main air path, resulting in a shorter air-handling unit than if a conventional preheat coil, air-mixing baffles, or an energy-recovery device is used. And, since it adds no static pressure drop to the design of the supply fan, it has less impact on fan energy than these other approaches. However, the cost of the second, smaller air-handling unit is typically higher than an air-mixing baffles, and it requires a second, smaller set of filters that need to be replaced periodically.

Figure 26. Horizontal split dehumidification indoor unit (SDU)



Application Considerations:

- Provides excellent humidity control in recirculating units, achieving SHR down to 0.4 without using new energy for reheat.
- Can offer significantly lower operating costs and a low first cost.
- Can be used in retrofits.
- Uses standard components.
- Does not require field-installed structural bracing.
- Has a small foot print.
- Is available in sizes 3-50, with the upper unit being sized between 20 to 50 percent of the lower unit.

Dehumidifying with outdoor units can be achieved with an outdoor air pretreating SDU or by using two units. See [Figure 27](#) and [Figure 28](#).

Figure 27. Outdoor air pre-treating split dehumidification unit

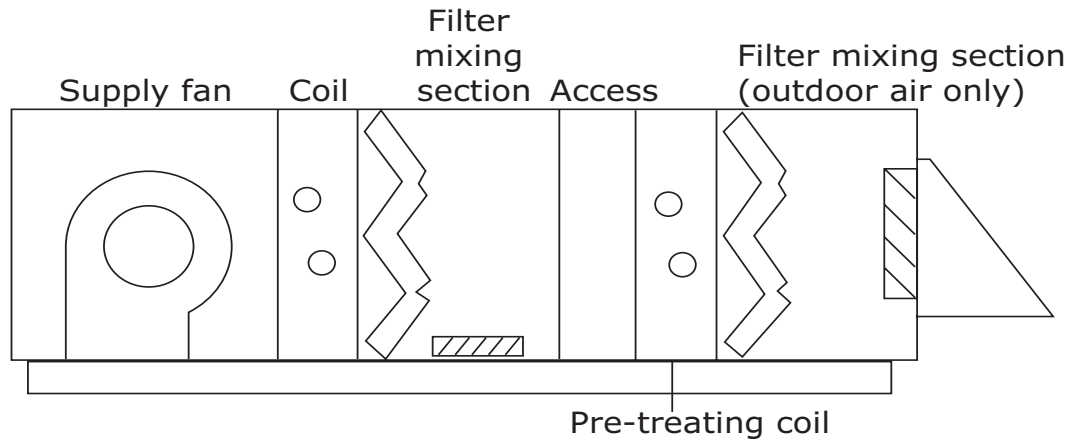
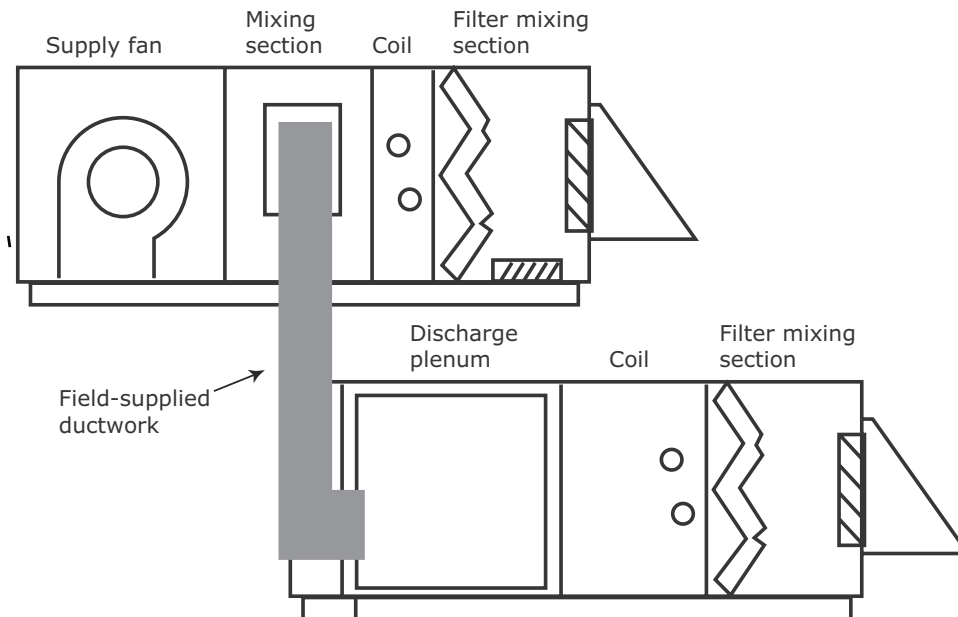


Figure 28. Split dehumidification with outdoor units



Dehumidification with Hot-Water Heat-Recovery Coils

Using waste condenser heat from the chiller or compressor is a simple way to provide dehumidification reheat. With this dehumidification strategy, a hot-water coil is installed after the active cooling coil. Hot water from the chiller—or from an auxiliary condenser on the chiller—is piped to this coil. Free reheat is available any time the chiller is on.

Application Considerations:

- Work with recirculating or 100-percent makeup-air units.
- Provide excellent humidity control at any sensible-heat-ratio condition without using new-energy reheat.
- Can reduce operating costs significantly.
- Can be used in retrofits.
- Use standard Trane components.
- Provide proven, low-cost technology.

Energy Recovery

Trane air handlers offer high-performance solutions for airside energy recovery:

- Total energy recovery wheels
- Run-around coil loops
- Air-to-Air plate frame heat exchangers

These technologies transfer energy between the exhaust and outdoor air streams. Total energy recovery wheels transfer both sensible and latent energy between the air streams, while the coil loop transfers sensible energy.

Energy-recovery arrangements:

- Reduce operating costs.
- Can reduce first cost by allowing downsizing of chillers and boilers.

Energy-recovery systems can offer excellent energy savings when properly applied. Economic considerations must be carefully evaluated to determine the payback period of any energy-recovery system.

For more information, refer to Trane applications engineering manual Air-to-Air Energy Recovery in HVAC Systems SYS-APM003-EN.

Energy Recovery with a Total Energy Wheel

This type of application is used to recover energy and moisture from the exhaust air stream. The wheel preheats and humidifies the supply air during the winter season and precools and dehumidifies the supply air during the summer season. [Figure 29](#) and [Figure 30](#) show an air handler arrangement with an exhaust fan, an economizer, and a total-energy wheel.

Application Considerations

Figure 29. Energy-recovery with a total energy wheel in indoor unit

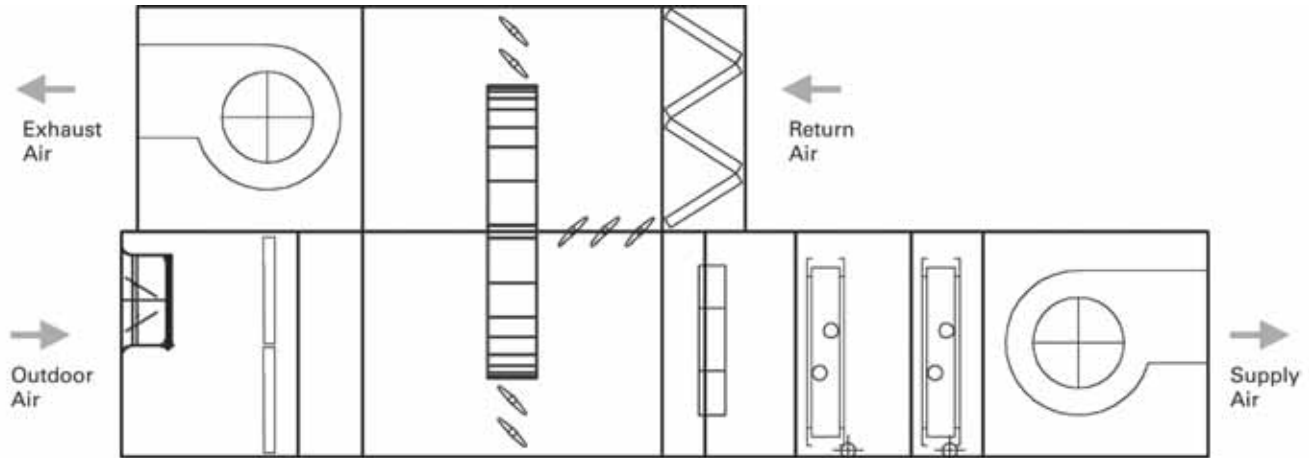
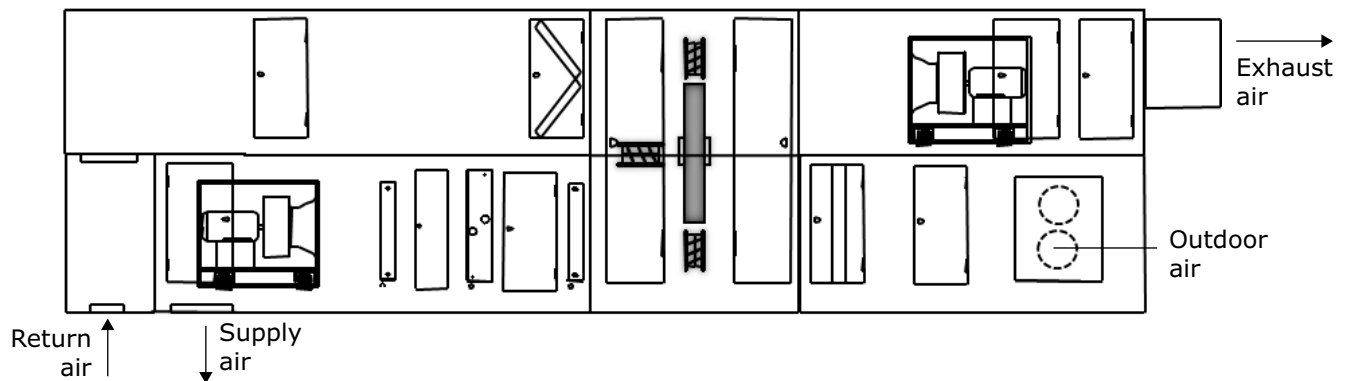


Figure 30. Energy-recovery with a total energy wheel in outdoor unit



As the return air enters the unit, a portion is recirculated through the return-air damper and the remainder goes through the wheel and is exhausted to maintain the required building pressure. Outdoor air enters an outdoor-air damper, then goes through the wheel and mixes with return air. During the economizing mode, the energy wheel is not used, and both wheel bypass dampers are open to allow up to 100-percent outdoor and exhaust airflow.

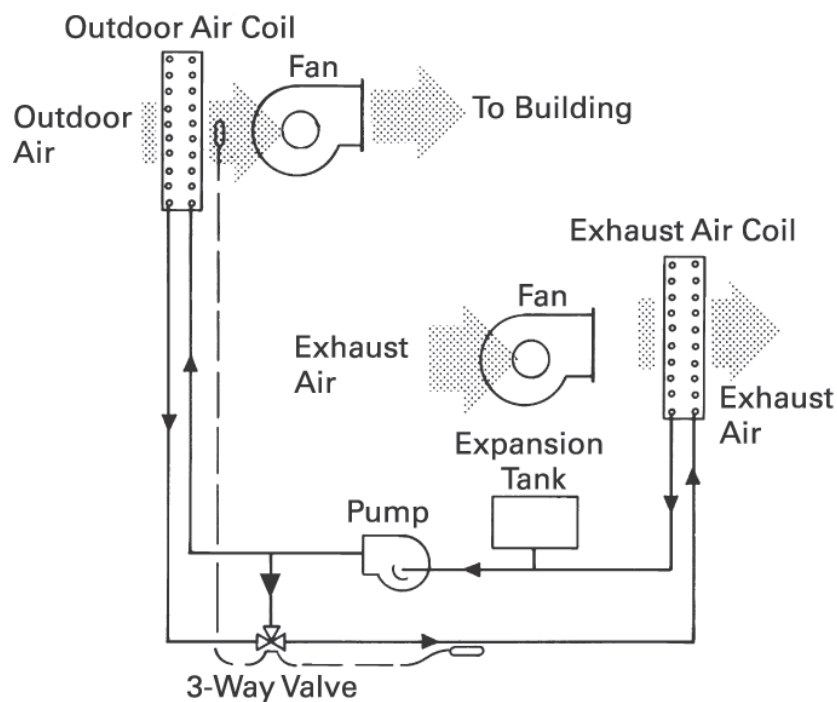
If the energy wheel module is used in a VAV system or in a unit that supplies cold supply air, modulating the exhaust-air bypass damper at the wheel can prevent the air from overheating during onset of the heating mode. If frosting conditions exist, modulating the outdoor-air bypass damper at the wheel can prevent vapor in the exhaust air from freezing on the wheel. If bypass frost control is used as freeze protection for the wheel, add a blender module to adequately mix the outdoor and exhaust air streams. If bypass frost control is not used, add outdoor-air preheat or return-air reheat.

Energy Recovery with Coil Runaround Loops

Outdoor-air and exhaust-air coil runaround loops recover energy that would normally be exhausted. They precool the outdoor air during the cooling season and preheat the outdoor air during the heating season. With coil loops, the outdoor and exhaust air streams do not need to be adjacent. This provides design flexibility for building renovations and new construction—at a first cost that is often lower than other methods of energy recovery.

Multiple exhaust and outdoor-air coils can be piped together with relative ease. Coil runaround loops use finned-tube hydronic coils in a closed loop to transfer energy. A typical runaround system is shown in [Figure 31](#). The heat-transfer fluid pumped within the loop is usually an inhibited solution of ethylene glycol and water to avoid freeze up.

Figure 31. Energy recovery with a runaround coil loop



Application considerations:

- Typical coil-loop effectiveness ranges from 45 to 65 percent with equal airflow and no condensation. Adhere to standard guidelines regarding coil construction, based on conditions. (See Trane catalog COIL-DS-1 and engineering bulletin COIL-EB-19 for more information.)
- Coil performance and airside pressure drops can be determined using Trane selection tools.

Coil loops offer complete separation of the air streams, thus eliminating any risk of cross-contamination. Loop components include the coils, a pump, expansion tank, and a three-way valve or variable-frequency drive (VFD). The expansion tank accommodates expansion and contraction of the internal fluid. The three-way valve or VFD modulates coil capacity. To prevent moisture in the exhaust air from freezing on the exhaust coil, the three-way valve can divert the warm fluid returning from the exhaust coil to the supply side of the coil.

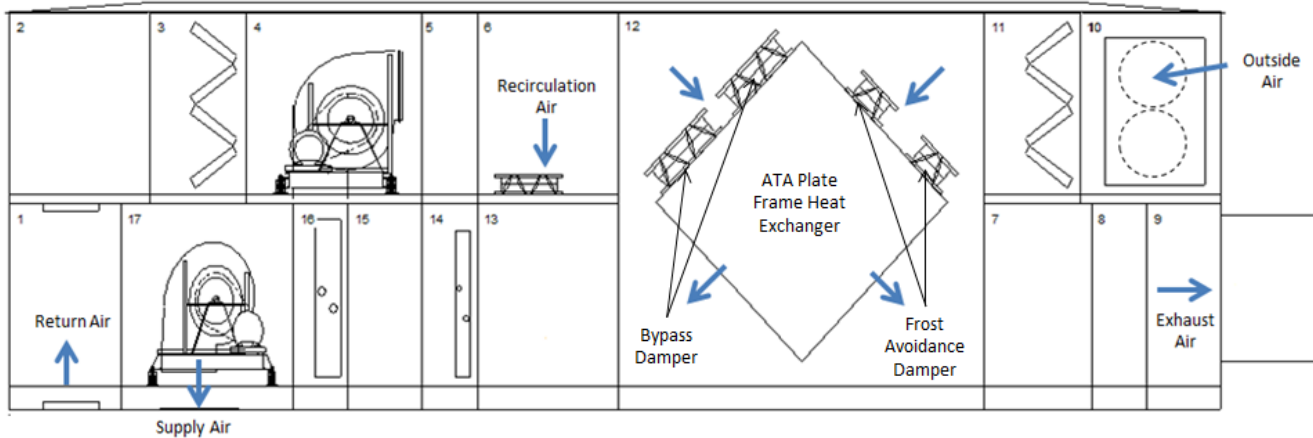
Energy Recovery with Air-to-Air Plate Frame Heat Exchangers

This type of application is used to recover energy from the exhaust air stream using cross-flow aluminum plates. The air-to-air (ATA) plate frame heat exchanger preheats the supply air during the winter season and precools the supply air during the summer season. Figure 32 shows an air handler arrangement with an exhaust fan, economizer and ATA heat exchanger.

As the return air enters the unit, a portion is recirculated through the return-air damper in the mixing box and the remainder goes through the air-to-air plate frame heat exchanger and is exhausted to maintain the required building pressure. Outdoor air enters an outdoor-air damper, then goes through the ATA heat exchanger and mixes with return air. During the economizing mode, the ATA heat exchanger is not used, and bypass dampers are open to allow up to 100-percent outdoor and exhaust airflow. The center bypass dampers can be selected for either the outside air or exhaust air path, but not both.

If the ATA heat exchanger is used in a VAV system or in a unit that supplies cold supply air, modulating the exhaust-air bypass damper at the ATA heat exchanger can prevent the air from overheating during onset of the heating mode. If frosting conditions exist, frost avoidance dampers that block part of the outdoor air face of the exchangers close to minimize frosting potential. Frost control can also be achieved by modulating bypass dampers placed on the outside air side versus the exhaust side. If outside air bypass is used, freeze protection needs to be applied to any downstream hydronic coils.

Figure 32. Energy recovery with air-to-air plate from heat exchanger



Acoustics

Designers are often challenged to select and arrange the air handler components so that the inlet, discharge and casing-radiated fan generated sound power levels help create a quiet space. To accomplish this, the designer must choose the right fan and determine whether additional unit attenuation is necessary.

Choosing the Right Fan

Obviously, the quieter the noise source (in this case, the fan), the less attenuation is needed along sound transmission paths. Selecting a quieter fan often increases the initial cost of the air handler, but can be a cost-effective system solution because it:

- Reduces the need for path attenuation (e.g., silencers) by diminishing the sound level along all transmission paths
- Reduces energy consumption (i.e., a fan is normally quietest when running at the most efficient point on its operating curve), providing operating cost savings to offset the initial cost.

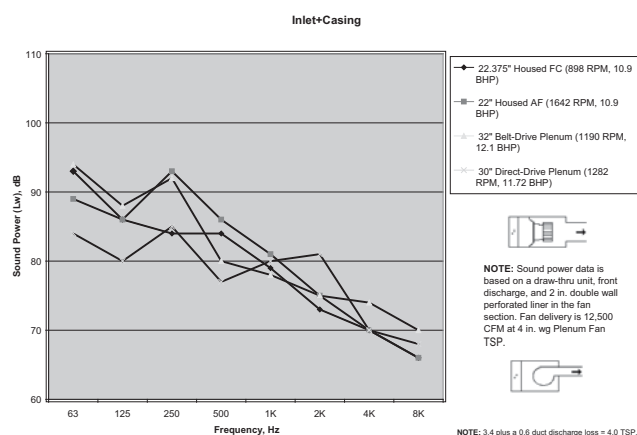
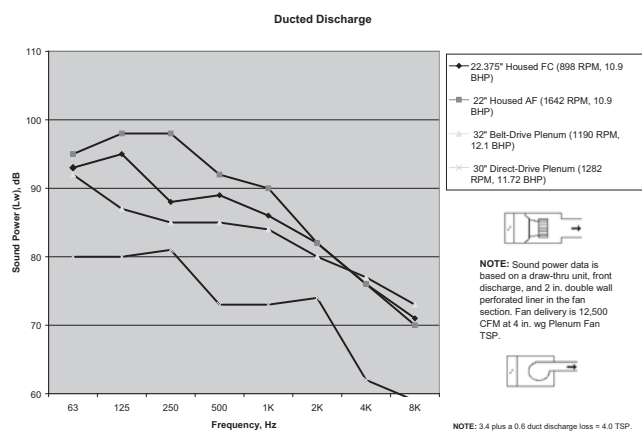
Trane acoustical tests have shown that a fan's sound power (Lw) level depends on three factors:

- Type/design
- Operating point on the fan curve
- Application requirements (e.g., critical octave band frequency)

Figure 33 and Figure 34 compare the inlet and outlet sound power levels of four different fans. Together, these charts demonstrate that fan inlet sound is not equivalent to fan outlet sound. More importantly, they underscore the need to obtain accurate, AHRI 260 tested sound data from the manufacturer so that appropriate source and/or path attenuation methods can be applied.

Trane gives designers a choice of many different fan types. See "Fans" section on page 52 for a summary of different fan application considerations and acoustical characteristics.

Figure 33. Comparison of discharge sound power by fan type **Figure 34. Comparison of inlet plus casing sound power by fan type**





Components and Options

Performance air handlers adopt a 'building-block' approach to air-handling design. Each 'building block' or section contains one or more components that serve a specific purpose unique to each application. The required function, layout, and arrangement of the air-handling system determines which sections must be included for a particular application.

Access/Blank and Turning Section

Access or blank sections can provide access to internal components for cleaning, maintenance, and service or to promote proper airflow through the unit.

A turning section is a blank section that alters the direction of airflow and reduces turbulence. It can also serve as an effective sound attenuator. When compared to a field-mounted, rectangular duct silencer, the turning section is less expensive to install, has a lower pressure drop, and provides more predictable performance. Perforated lining in the turning module attenuates mid- to high-frequency sound.

Note: Only large and extra-large blank sections can be selected as turning sections.

Blender

Blender sections contain air-mixing baffles, or blenders, that rotate the passing air streams, boosting their velocity for improved mixing. It is usually placed immediately downstream of a mixing box section, and should always be positioned upstream of filters and coils. [Figure 36](#) documents blender performance at a downstream coil entering air temperature of 55°F and return-air temperatures of 70°F and 75°F.

Application considerations:

- Blender face velocity should be in the range of 500 to 2000 fpm for proper mixing.
- When operated at temperatures within its design range, a blender may eliminate the need for preheat.
- Space is required both upstream and downstream of the blender to allow complete air mixing. The standard design of the blender section satisfies these spacial requirements.
- Select the mixing box such that the dampers are positioned at the top, back, or bottom when used with a blender.

Figure 35. Use blenders for coil protection

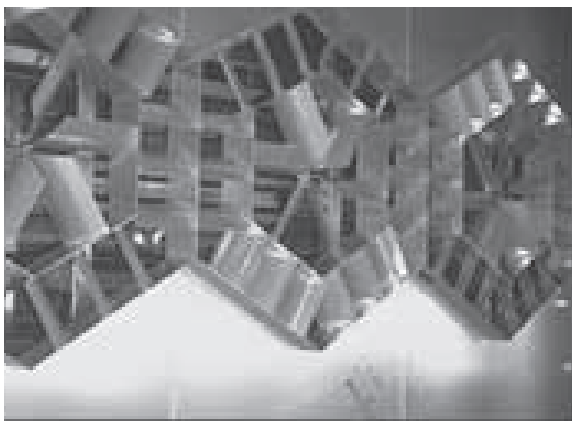
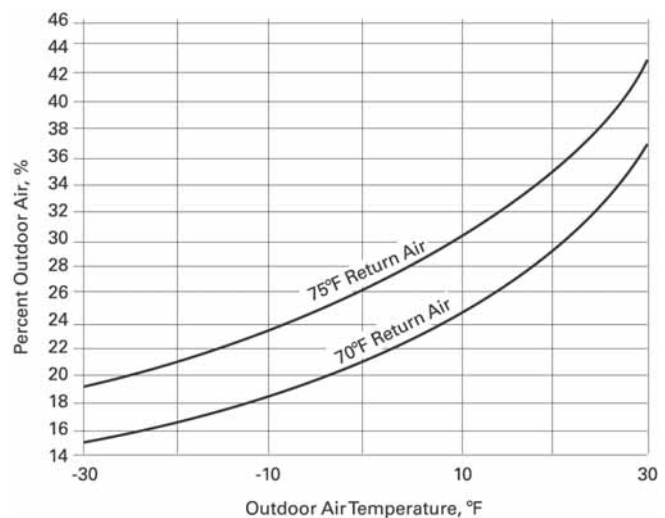


Figure 36. Blender performance with 55°F leaving air temperature



CDQ™ Desiccant Dehumidification Wheel

The CDQ wheel section (see [Figure 37](#)) is used to enhance the dehumidification performance of a traditional cooling coil. It utilizes a Type III desiccant (activated alumina) chosen specifically for air-handling applications. The wheel is configured in series with a cooling coil, and requires only one air stream. The CDQ wheel rotates between the entering and leaving sides of the cooling coil. CDQ wheels are sized based on supply fan airflow. Unlike conventional equipment, the dew point of the supply air is not equal to the dew point of the air leaving the cooling coil. The required cooling coil capacity and air temperature leaving the coil are determined by the CDQ wheel performance. For more application information, refer to engineering bulletin CLCH-PRB020-EN.

Figure 37. CDQ wheel



Application Considerations:

- Available in 14 unit sizes, ranging from 1000 to 25,000 cfm
- Single wheel for unit sizes 3 to 50 with up to two wheels available per unit size
- Can be applied in mixed air and dedicated outdoor air systems
- Required cooling coil capacity is decreased when dehumidifying
- Entering water temperatures to the coil can be increased
- Section includes required space upstream and downstream of the wheel
- Required access and doors in section
- Variable effectiveness control using bypass dampers

Additional dehumidification options

- Dual-path split dehumidification units (SDUs)
- Low sensible-heat ratio coil selections
- Series recovery supply air tempering 100 percent outdoor air units in conjunction with other Trane airside products

Coils

Figure 38. Coil with copper header

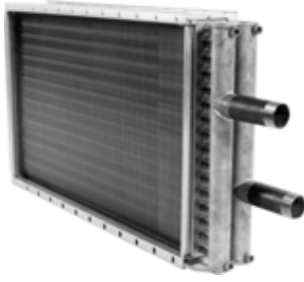


Figure 39. Coil with cast iron header



Coil Optimization

The variety of Trane coil types, sizes, arrangements, and materials allows you to select a coil that is optimized for pressure drop and capacity requirements. Published coil performance is certified in accordance with AHRI Standard 410 and meets CRN (Canadian Registration Number) standards.

Trane is at the leading edge of coil technology. Through extensive laboratory testing and numerous job-site installations, Trane has developed unique fin surfaces for its coil offerings. These enhanced fin surfaces have superior heat transfer characteristics and allow greater velocities of air to move through the cooling coil without causing moisture carryover.

The industry is familiar with the 500-fpm limit through a cooling coil as a “rule of thumb” to safeguard against moisture carryover. However, some applications have tight dimensional constraints that require high coil face velocities. Trane fin designs extend this limit in excess of 625 fpm, depending upon air conditions, coil size, and coil-fin type, and spacing. Tested data for moisture carryover is incorporated in the Trane Official Product Selection System (TOPSS™). In cases where moisture carryover is possible, the TOPSS program alerts you to this fact with a moisture carryover warning. See [“Face-Velocity Limits for Moisture Carryover,” p. 165](#) for moisture carryover curves.

Coil options include but are not limited to the following:

- Two- to eight-row, 1/2-inch OD (outside diameter) chilled water or refrigerant coils
- Two- to 10-row, 5/8-inch OD chilled water or refrigerant coils
- One- or two-row 5/8-inch OD hot water coils
- Two-row, 1/2-inch OD hot water coils
- One-row, 1-inch OD distributing-type steam coils
- Half, full, and dual-serpentine, circuited water coils
- Full face, split face, and intertwined circuited refrigerant coils

A variety of fin surfaces are also available, with the following options:

- Variable fin spacing on all fin types to fine-tune coil capacity and air-pressure drop
- Aluminum Delta-Flo™ H and Prima-Flo™ H fins that maximize the heat transfer and moisture carryover limits of the coils
- Aluminum Delta-Flo E and Prima-Flo E fins that minimize the coil air-pressure drop
- Copper Prima-Flo™ fins for corrosion protection

For additional information on coils, see Air Heating and Cooling Coils Quick Select COIL-PRC002-EN.

Drain Pans

Figure 40. Extended drain pans for easy cleaning



- Galvanized or stainless steel drain pans sloped in two directions to assure positive drainage helps prevent corrosion.
- Drain pans that can extend beyond the cooling coil (see [Figure 40](#)) for periodic cleaning are standard options.
- A variety of cooling coil fin options, including the high-efficiency H-fin design, are available. These fins allow for coil selections with face velocities in excess of 625 fpm without moisture carryover.
- UV-C lights help preventing mold, bacteria and viruses from reproducing and also maintains or improve the system efficiency. Factory engineering and UV-C lights installation allows us to maximize the benefits of UV technology without jeopardizing the expected reliability and safety of the equipment.

Electric Heat

Figure 41. Typical 1-inch steam coil



An electric heat coil is a relatively inexpensive first cost heating option compared to central plant boiler systems. Electric heat is a factory-installed, UL-listed option for unit sizes 3-66 draw-thru arrangements and 3-30 blow-thru arrangements in constant-volume or VAV applications.

Application considerations:

- Blow-thru arrangements require a minimum of a medium blank section between the supply fan and the electric heat section to ensure even air distribution across the electric heater.
- A large access or discharge plenum section with a door for field-wiring access is required downstream of the electric heat section in a blow-thru arrangement.

Integral Face-and-Bypass Coil

Conventional preheat systems are subject to coil freeze-up, stratification, and air-volume variation. An integral face-and-bypass (IFB) coil is specifically designed to minimize these problems, alternating heating and bypass channels with face-and-bypass dampers before and after the coil. If heat is needed, both dampers modulate open; otherwise, they remain closed to prevent “coil wiping” on the leaving side of the coil and to avoid unwanted heat pickup. This design effectively provides good freeze protection, constant airflow, and uniformly mixed and unstratified air. The IFB coil comes as a complete package (including heating coil, linkage, and dampers), thus assuring maximum system reliability. The section uses horizontal coil-tube arrangements in unit sizes 6 to 40 and vertical coil-tube arrangements in unit sizes 50 to 100.

These coils are capable of maintaining a constant heating discharge air temperature regardless of variations in entering air temperatures, with full steam pressure of hot water flow on the coils at all times. IFB coils consist of rectangular aluminum fin (.010-inch thick) elements, with 5/8-inch O.D. .035 thick copper tubes completely enclosed in a 14-gauge galvanized steel casing, with 16-gauge dampers. Dampers are arranged to completely enclose and isolate the heating coil elements when no temperature rise is required. Holes in the unit casing for supply and return connections are factory provided to facilitate field piping of the coils. Factory-mounted electronic actuators are available when specified.

[Figure 3](#) and [Figure 4](#) list the sections required to house the integral face-and-bypass coil, and the downstream section required for proper air mixing space. External piping cabinets are required on

Components and Options

both sections. An optional access door can be added to the downstream section on units with an integral face-and-bypass coil. On units with a vertical integral face-and-bypass coil, an access door must be included in the downstream section, on the opposite side of the coil connection, to facilitate field piping of the supply and return connections on the coil.

Table 3. Requirements for horizontal IFB coils

Unit size	3	6	8	10	12	14	17	21	25	30	35	40
IFB section	n/a	Large	Large	Large	Large	Large	Large	Large	Large	Large	Med-Large	Med-Large
Downstream section	n/a	Medium	Medium	Medium	Medium	Medium	Medium	Medium	Medium	Medium	Medium	Medium

Table 4. Requirements for vertical IFB Coils

Unit size	50	57	66	80	100
IFB section	Med-Large	Med-Large	Med-Large	Med-Large	Med-Large
Downstream section	Medium	Medium	Medium	Medium	Medium

External piping cabinets are required on both the IFB coil and the section immediately downstream of the coil. An optional access door can be added to the downstream section. On units with vertical IFB coils, an access door must be included in the downstream section to facilitate field piping of the supply and return connections on the coil.

It is recommended that a factory selection of a coil be made based on scheduled performance prior to configuring a unit with an IFB coil, so as to determine whether the unit should be configured around an integral face-and-bypass coil or a vertical integral face-and-bypass coils.

Dampers

Face-and-Bypass Dampers

Figure 42. Internal face-and-bypass damper



Designed to divert airflow around a coil, the face-and-bypass damper can be used to control humidity or provide freeze protection for hydronic coils. Face-and-bypass dampers are available in two module configurations, internal and external.

Internal Face-and-Bypass Dampers

Typically used immediately upstream of a modified-size (less than 100-percent airflow) coil, this arrangement enables temperature control while operating the preheat coil at full flow. The dampers modulate to bypass air around the heating coil when the outdoor air temperature is warm enough to preclude freezing. See [Figure 42](#).

Application considerations:

- To ensure full airflow coverage across downstream coil banks, provide extra distance after the modified-size coil section (see [Table 5](#)).
- Consider the effect of reduced bypass area, higher velocities, and higher pressure drops when designing internal face-and-bypass configurations that require 100-percent bypass. External face-and-bypass dampers may be better suited for these configurations.

Figure 43. Internal face-and-bypass configuration

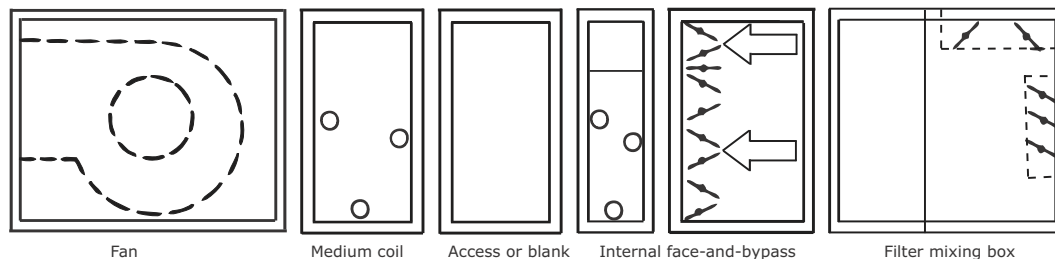
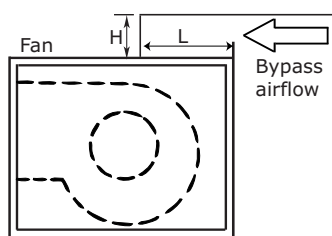


Table 5. Recommended distance between coils to ensure full airflow coverage

Unit size	Distance between coils (inches)
3, 6	12.00
8, 10	18.00
12, 14	24.00
17	30.00
21	33.00
25-40	36.00
50	48.00
57, 66	57.00
80	69.00
100, 120	78.00

Figure 44. External bypass



External Face-and-Bypass Dampers

External face-and-bypass dampers perform the same function as their internal counterpart. However, they are used upstream of a full-face coil, and they route air around the coil through an external bypass duct. See [Table 6](#) for recommended duct sizes that permit 100-percent bypass. Duct placement varies with each air handler arrangement. Ensure that the external bypass duct does not interfere with stacked modules. Use [Table 6](#) in conjunction with [Figure 44](#).

Table 6. Recommended bypass duct sizes (inches)

Unit size	H	W	L
3	16.00	20.00	14.00
4	18.00	33.00	16.00
6	18.00	33.00	16.00
8	18.00	39.00	16.00
10	18.00	50.00	16.00
12	22.00	55.00	20.00
14	22.00	61.00	20.00
17	22.00	61.00	20.00
21	28.00	69.00	26.00
25	28.00	69.00	26.00
30	28.00	82.00	26.00
35	45.00	80.00	36.00
40	45.00	93.00	36.00
50	45.00	106.00	36.00
57	47.00	106.00	40.00
66	48.00	121.00	40.00
80	56.00	121.00	48.00
100	56.00	135.00	48.00
120	56.00	162.00	48.00

Components and Options

Figure 45. Configuration A

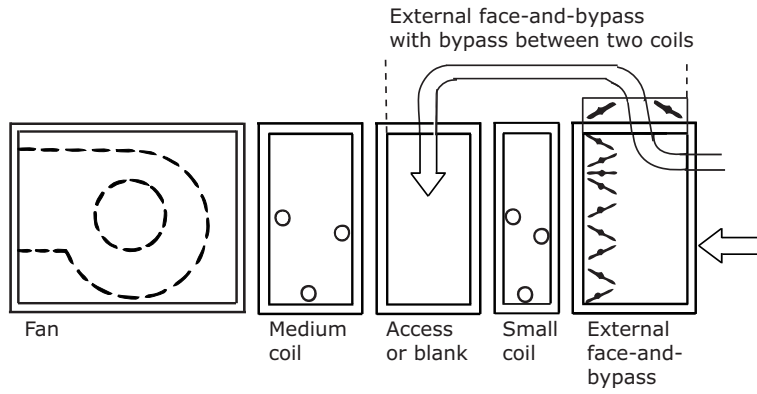


Table 7. Table for Configuration A

Unit Size	Blank Size
3-12	Extended Medium
14-17	Medium- Large
21-120	Large

Figure 46. Configuration B

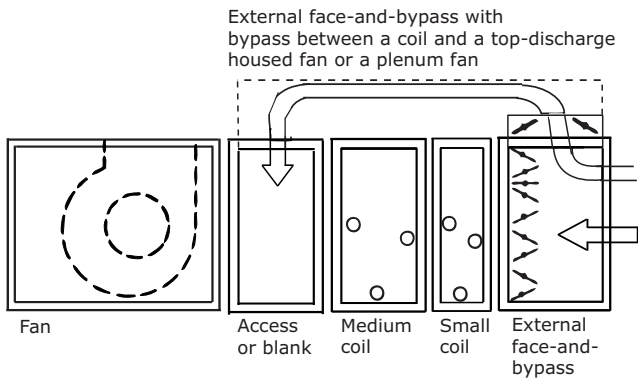
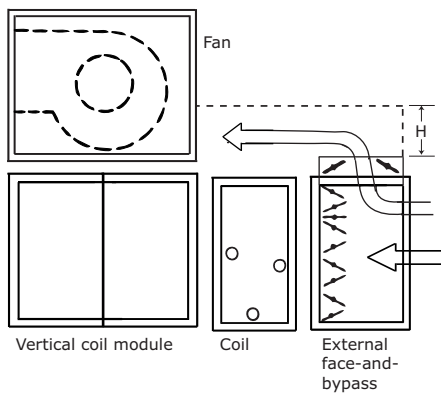


Table 8. Table for Configuration B

Unit Size	Blank Size
3-57	Extended Medium
66-120	Large

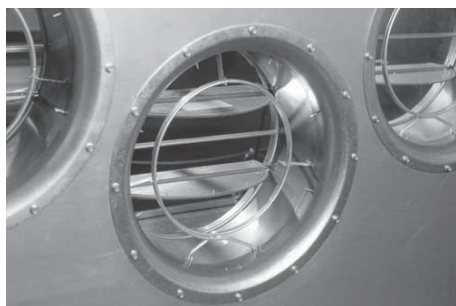
Figure 47. Configuration C



Area of opening in fan module should be equal to "H" and "W" dimensions from [Table 6](#).

Traq™ Dampers and Low Flow Traq Dampers

Figure 48. Traq dampers measure and control ventilation airflow.



The Trane AMCA 611-certified Traq™ airflow-monitoring solution (see Figure 48), allows direct measurement and control of outdoor and/or return airflow and is rated for a maximum leakage rate of 4 cfm/ft² at 1 inch w.g. complying with ASHRAE Standard 90.1 maximum damper leakage. The low-flow Traq option can be used as a key part of a demand control ventilation strategy to help drive down energy costs. When applied as part of an Integrated Comfort™ system (ICS) with the Tracer Summit™ building automation system, ventilation airflow can be controlled dynamically and documented to verify compliance with ASHRAE Standard 62.1. (See Trane product catalog BAS-PRC001-EN for more information on Tracer Summit systems.) Factory-mounted and tested to reduce installation and startup costs, the Traq damper also requires significantly less straight duct than traditional airflow-monitoring stations and does not require upstream straightening vanes for proper operation that could become clogged with debris.

The bell-mouth inlet of each damper guides air uniformly through a flow-sensing ring that accurately measures total and static pressure from 100 percent of nominal airflow down to 300 fpm through the damper. The damper assembly's ventilation control module (VCM) produces a 2-to-10-Vdc signal that is proportional to airflow, recalibrates itself once every 60 seconds, and automatically adjusts for temperature variations. Depending on unit size and controls configurations Traq dampers can measure from 100 percent of design CFM, down to five percent design CFM.

Application considerations:

- The Traq damper mixing box requires only one duct diameter of straight inlet duct (as much as 80 percent less than other airflow monitoring techniques).
- Connecting a Traq-damper-equipped air handler to a building automation system, such as a Tracer building management system, permits:
 - Dynamic calculation of the outdoor air needed to adequately ventilate a multispace VAV system and reset the outdoor-air setpoint accordingly to save energy.
 - Trend logs and custom reports to document compliance with ASHRAE Standard 62.1.

Diffuser

Figure 49. Diffusers provide even airflow.



A diffuser consists of pressure-equalizing baffles that are designed to provide even airflow across components downstream of a fan. The diffuser section is typically used immediately downstream of a centrifugal fan in a blow-thru filter, coil application.

Discharge Plenum

Figure 50. Discharge plenums can lessen low-frequency sound.



Before leaving the air handler, supply air can be ducted to a discharge plenum section. The rapid air-stream expansion as it passes into the plenum reduces turbulence and creates an acoustical end reflection that dampens low-frequency sound. Perforated panels can be selected as an additional attenuation option. Two configurations enable supply-duct connections from any side:

- *Vertical-mounted* plenum sections mount atop an adjacent section and can be increased 1.5 times or reduced 0.5 times to standard height minimizing field duct transitions. Openings can be factory- or field-cut.
- *Horizontal-mounted* plenum sections mount on the front of an adjacent section. Openings can be factory- or field-cut.

Vertical and horizontal discharge plenum openings can be tailored to the size, type and location to best fit the velocity and static pressure requirements, improving energy efficiency and sound. Round, rectangular, and bell mouth openings are all available.

Economizer

Figure 51. Outdoor economizer section



An economizer section, for outdoor use only, provides an exhaust path for return air, allowing the system to provide natural, non-mechanical cooling when outdoor air conditions are suitable.

Energy Recovery

Increased ventilation airflow requires more energy to heat or cool and can significantly affect operating costs. Bringing in more fresh air when it is cold outside also increases the risk of coil freeze-up. Trane airside energy-recovery solutions address both energy consumption and coil protection by recovering heat from the exhaust air stream to pre-condition outdoor air entering the building. Trane has many factory-packaged energy-recovery solutions including:

- Total energy recovery wheels to recover both sensible and latent energy. See [Figure 52](#).
- Coil-runaround loops to recover sensible energy (see [Figure 53](#)).
- Air-to-air plate frame heat exchangers recover sensible energy.

Energy Wheels

Figure 52. Energy wheel



The energy wheel section is a total-energy-recovery device; it recovers both sensible and latent energy. It consists of a rotating wheel that contains heat exchange media surfaces. A desiccant material specifically designed for adsorption and desorption of water vapor is permanently bonded into the heat exchanger matrix. The wheel rotates between the outdoor- and return-air paths, whose air streams are counter-flow.

Energy wheels are sized based on the ventilation air requirement and can be applied in a 100-percent-outdoor-air unit or a recirculation unit. Internal wheel-bypass dampers vary the effectiveness of the wheel.

For more application information on energy recovery, refer to these Trane applications manual SYS-APM003-EN.

Application considerations:

- Certified in accordance to AHRI Standard 1060
- Available in 18 sizes, depending on ventilation requirements ranging from 900 to 25,000 cfm
- Single wheels for sizes 3-50 with up to seven wheels available per unit size
- Greater than 70 percent total effectiveness at a pressure drop of 1 to 1.15 in. w.g. and nominal airflow through the wheel
- Bypass dampers are standard for partial-flow energy wheel sections
- Standard, built-in return damper for partial-flow, recirculating wheels for sizes 6-50
- Section includes required space upstream and downstream of the wheel
- Required access and doors in the section
- Variable effectiveness control using air bypass
- Frost protection using an air bypass damper or a separate pre-heat module

Coil Runaround Loop

Figure 53. Coil-runaround loops recover sensible energy



A runaround loop, used to recover sensible energy, consists of two finned-tube coils (air-to-water heat exchangers) piped together; one coil resides in the outdoor airstream and the other in the exhaust airstream. An expansion tank, pump, three-way temperature control valve and working fluid (usually an inhibited solution of ethylene glycol and water) complete the recovery system.

Since the outdoor and exhaust airstreams need not be adjacent, the runaround loop provides design versatility well-suited to building renovations – at a lower first cost than other methods of energy recovery. Complete separation of the airstreams also eliminates the risk of cross-contamination.

Application Considerations:

- Recovery is limited to sensible energy with effectiveness that typically ranges from 60-65 percent.

Components and Options

- Together, the two finned-tube coils may contribute approximately 0.3 to 0.6 in. wg to system static pressure.

Air-to-Air Plate Frame Heat Exchanger

Figure 54. Air-to-air plate frame heat exchanger



Air-to-air plate frame heat exchangers is a sensible-energy-recovery device. The exchanger consists of aluminum plates that are stamped into a dimpled or channeled shape. The plates are stacked on each other with the alternate edges crimped and sealed to prevent cross leakage.

These can handle high pressure differentials, some up to 10 inches between the exhaust and outdoor air side. They also can handle higher temperatures and can be coated for corrosion protection.

Application Considerations:

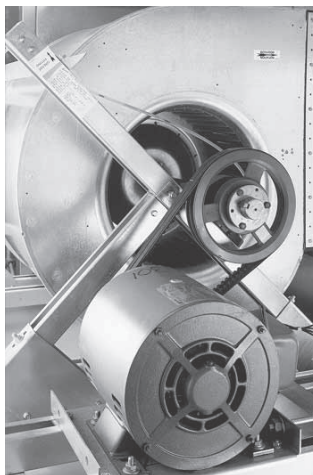
- Certified in accordance to AHRI Standard 1060.
- Three plate spacings available.
- Bypass options available for variable effectiveness and frost prevention.
- Up to 70 percent total effectiveness with close spacing.
- Drain pans always required.
- Can be used in a series arrangement for dehumidification.

Fans

Fan Choices

An extensive array of fan types and options, including variable-frequency drives (VFDs) for modulation in variable-air-volume systems, lets you optimize the fan to best fit not only the airflow and static pressure requirements, but also the acoustical, efficiency, and discharge requirements.

Figure 55. Trane offers a wide variety of fan choices



- Fan types include:
- Double-width/double-inlet (DWDI) centrifugal fans with front, top, or bottom discharges in the following available types:
 - Forward-curved (FC)
 - Backward-curved (BC)
 - Airfoil (AF)
 - Single-width/single-inlet (SWSI) plenum fans with multiple or single discharges on the front, top, bottom, or sides of the section
 - Direct-drive plenum fans
 - Belt-drive plenum fans

Plenum fan openings can be tailored to the size, type and location to best fit your velocity and static pressure requirements improving energy and sound. Round, rectangular, and bell mouth openings are all available.

Each fan is rated in accordance with Standard 430 of the Air Conditioning Heating and Refrigeration Institute (AHRI) and all DWDI fans are AHRI Standard 430-certified to assure published performance.

Table 9 summarizes and compares the characteristics and application considerations of these fans. When evaluating the merits of each fan type for a given application, consider the volumetric rate of airflow, static pressure, required sound characteristics, and space.

Table 9. Fan summary information

Fan type	FC Fan Centrifugal, housed	Backward-curved (BC) Fan Centrifugal, housed	AF Fan Centrifugal, housed	Plenum Fan Unhoused
Inlet	Double	Double	Double	Single
Airflow direction	Radial	Radial	Radial	Pressurized, all directions
Optimal pressure range	Low to medium (0 to 5 in. wg)	High (4 to 8 in. wg)	High (4 to 8 in. wg)	Medium to high (2 to 8 in. wg)
First cost (relative)	Low	Medium	Medium	High
Operating cost (relative)	Medium	Medium-high	Medium-high	Medium
Typical speed range	400–1,600 rpm	1,000–2,600 rpm	1,000–2,600 rpm	600–1,600 rpm
Blade shape	Curved	Curved	Airfoil	Airfoil
Acoustical characteristics	Significant air turbulence that quickly abates; little blade-tone noise	Significant air turbulence; strong blade tones in 250-Hz octave band	Significant air turbulence; strong blade tones in 250-Hz octave band	Discharge sound but higher inlet noise ¹
Suggested source attenuation	Add a discharge plenum	Avoid using inlet vanes; use discharge plenums and/or silencers	Avoid using inlet vanes; use discharge plenums and/or silencers	Add a discharge plenum or outlet/inlet silencer
Direct upstream space required in draw-thru arrangements	None	None	None	Medium module
Direct downstream space required in blow-thru arrangements	Medium blank or diffuser module	Medium blank or diffuser module	Medium blank or diffuser module	Medium blank module
When to use?	Low-pressure applications	High-pressure applications	High-pressure applications	Multiple-duct arrangement, blow-thru applications ²
K _t loss, abrupt discharge ³	1.80	1.00	1.00	n/a

Note: 1. Add duct takeoff losses from the plenum fan module to external static pressure; see Trane fan performance catalog CLCH-PRC008-EN for details. 2. Same as Note 1; the uniform discharge velocity of the plenum fan may eliminate the need for turns in supply-air ductwork and diffusers, suiting it for installations with limited equipment room space. 3. In draw-thru applications, fan curves assume three diameters of straight duct downstream of the fan. Refer to AMCA 201-02, Fans and Systems, for more information when this assumption is not valid.

To verify that fan performance will satisfy design requirements, use the TOPSS selection program. The AHRI Standard 430-certified fan curves include the fan section casing effect. TOPSS also takes into account ductwork connections, air density, fan and motor heat, drive losses, and use of high-performance (MERV 11 and higher) filters affect fan performance.

Constant Volume vs. VAV Systems

Depending on the fan-control method used, the fan can provide either a constant or variable volume of supply air. In a constant-volume system, the fan delivers a consistent amount of air and cooling and heating devices adjust the air temperature for occupant comfort. Because the fan runs at constant horsepower under all load conditions, system operating costs are higher than those of a VAV system.

A VAV system provides occupant comfort by delivering a modulated amount of constant-temperature air. Usually, supply-duct static pressure determines how much air the fan provides. Varying fan horsepower with building load can offer substantial energy savings and do a better job of controlling space humidity.

Fan modulation is accomplished with a variable-frequency drive (VFD) that adjusts fan speed and airflow by varying motor speed. VFD modulation is quiet and energy efficient; it can also prolong the life of the fan motor by “soft starting” it.

Airflow Measuring Systems

Figure 56. Piezometer ring measures inlet air flow.



A fan inlet airflow measuring system with a piezometer ring is also available on many centrifugal and plenum fans. Each system comes with a differential pressure transmitter (see [Figure 56](#)). The piezometer ring is connected to the LO port of the transmitter and the reference pressure point is connected to the HI port of the transmitter.

Filtration and Air Cleaning

Effectively controlling particulate and gaseous contaminants by reducing their concentrations or removing them from the air stream altogether is key to good IAQ. That necessitates proper filter selection. Filtration and cleaning options include:

- Pleated media (MERV 8 to 14 based on ASHRAE Standard 52.2)
- Bag or cartridge filters (MERV 11 to 15 based on ASHRAE Standard 52.2)
- HEPA filters (MERV 17 based on ASHRAE Standard 52.2)
- Trane Catalytic Air Cleaners (TCACS) reduce microorganisms to a non-viable state
- Antimicrobial treatments for filters inhibiting microbial growth (MERV 7 based on ASHRAE Standard 52.2)

Filtration Options

Figure 57. Bag filter section - entering side



Figure 58. Bag filter section - leaving side



Figure 59. HEPA filter section



Air handlers can be equipped with a variety of filtration options, all tested in accordance with ASHRAE Standard 52.2. The continuous operating range of both the high-efficiency filters and the disposable prefilter is typically 0°F to 150°F, but can be as high as 200°F. Available filters and minimum efficiency reporting values (MERV) are:

- Two-inch permanent-MERV 2
- Two-inch disposable-MERV 5
- Two-inch and four-inch pleated media-MERV 8-14
- Eighteen-inch and 30-inch bag or 12-inch cartridge filters-MERV 11-15
- Two-inch and four-inch antimicrobial-treated filters-MERV 7
- HEPA
- Multiple side-loading and front-loading filter options

Application considerations:

- Higher filter efficiencies cost more, but provide cleaner air and better system performance. National, state, and local codes may also specify filter performance.
- Operating resistance to airflow (i.e. pressure drops). Filter resistance and first cost may increase with efficiency.
- High filtration efficiencies sometimes require more space, which lowers velocity, and may enlarge the air handler footprint.
- A high degree of filtration can lower cleaning costs in the occupied space.
- Exceeding the face velocity limit of the filter increases its resistance (as well as fan energy consumption) and necessitates more frequent maintenance or replacement.
- Exercise special care to avoid moisture carryover whenever final filters are used. Never place a blow-thru final filter section directly downstream of a cooling coil without providing an intervening source of reheat (such as fan motor). Tests have shown that certain entering-coil conditions can create water vapor that *will* collect on the final filter. The only known solution for this intermittent application issue is two degrees of reheat.
- Treating filter media with an antimicrobial coating can reduce the likelihood of microbial contamination. Trane coated pleated media filters can be treated with an antimicrobial coating.
- Install bag filters with the pleats vertical to the floor of the unit.
- Provide easy access to encourage regular filter maintenance.
- High-efficiency filters and disposable pre-filters may be operated near 100 percent relative humidity; however, they may not come in direct contact with water droplets.
- Keep filters dry.

Air Cleaning Options

Figure 60. TCACS uses three air cleaning technologies.

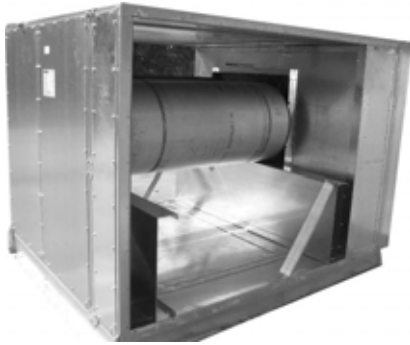


The Trane Catalytic Air Cleaning System (TCACS) is a factory engineered and installed combination of three air cleaning technologies: MERV 13 particle collection, high-intensity UVc light, and photo-catalytic oxidation (PCO). The high efficiency MERV 13 filters are very good at removing small, respirable particles from the airstream. The UVc/PCO combination reduces volatile organic compounds (VOC's) through photocatalytic oxidation without the creation of ozone or by-products. The combination of the three technologies also has a significant capability to reduce the spread of airborne biological contaminants including viruses, bacteria and fungi/mold.

The UV energy in the TCACS creates hydroxyl radicals on the surface of the titanium dioxide which oxidizes contaminants that they contact. All reactions occur within the air cleaner and no by-products leave the unit. The factory installed system comes complete with appropriate safety mechanisms protecting the owners and operators of the system. These safeties include an external disconnect with lock-out/tag-out capabilities, door interlock switches, and UVc viewport.

Gas Heat

Figure 61. Gas heat module



Gas heat can be an economical source of heat when compared to traditional heat sources such as central plant boilers with hot water or steam coils installed inside air handlers, or electric resistance heating installed inside air handlers.

Gas heat can be a good heating option for any of the following applications:

- Climates and applications with large heat loads
- Applications with high outside air requirements to comply with ASHRAE Standard 62
- Buildings without a central boiler plant
- Remote locations where boiler capacity or water piping expense is prohibitive
- Areas with relatively inexpensive natural gas or expensive electricity

Application considerations:

- Gas heater must be applied in a blow-thru configuration to insure that combustion gases will not enter the airstream due to the positive static pressure.
- Maximum discharge air temperature is 101° F.
- When reducing airflow, the control system should not allow the temperature rise through the gas heat section to exceed the nominal at full airflow.
- On high altitude applications, derate the heating capacity (MBh) by 4 percent for every 1,000 feet over 2,000 feet.

Humidifier

Figure 62. Humidifier section



ASHRAE Standard 62.1 suggests maintaining a relative humidity of no less than 30 percent to provide a comfortable, healthy indoor environment. The humidifier uses low-pressure steam distributors to add moisture to the air. This can be accomplished by using either building steam or an atmospheric steam generator. It includes accessories such as valves, strainers, and traps. Factory mounting within the air handler lowers the installed cost of the humidifier and keeps moisture out of the supply duct.

Application considerations:

- Airflow through the humidifier must be horizontal and of relatively uniform velocity (400 to 700 fpm).
- Do not locate the humidifier upstream of filters, gas heat, electric heat, or active cooling coils.
- Blow-thru applications with housed fans require at least a four-row coil between the fan and humidifier modules. The diffuser alone is unacceptable.
- To prevent condensate formation, the relative humidity leaving the humidifier should not exceed 83 percent. Contact your local Trane sales engineer for application-specific guidance.
- The required dispersion distance is designed into the humidifier section.
- Vertical airflow turning immediately upstream and downstream of the humidifier section requires a large turning section.

Inlet Hood

Inlet hoods include a moisture eliminator. Eliminator face velocities below 950 fpm will avoid pulling water through the eliminator fins and into the unit. It is possible for the moisture to be carried over into the unit when elimination face velocities are above 950 fpm.

OA Inlet Hood Requirements

Many specifications require that there be a minimum distance between the point that outside air enters an air handler and the roof of a building. This distance is to minimize the possible introduction of contaminants into the conditioned air.

ASHRAE 62 recommends that there be at least 9 inches (or 8 inches above maximum snow depth) separation from the roof to the outside air intake, however, some specifications, specifically for units in the health care industry require at least 36 inches of separation distance. When configuring and air handler, ensure that the unit in conjunction with a roof curb will meet the specifications requirements on separation distance.

Mixing Box and Economizer

Figure 63. Mixing Box



A mixing box section typically combines the incoming outdoor air with recirculated return air collected from the occupied space. It is commonly included in an air handler design to control this mixture. When equipped with an optional Traq damper, the mixing box module permits direct measurement of outdoor airflow to assure compliance with ASHRAE Standard 62.1.

Application considerations:

- The Traq damper mixing box requires only one duct diameter of straight inlet duct (as much as 80 percent less than other airflow monitoring techniques).
- Connecting a Traq-damper-equipped air handler to a building automation system, such as a Tracer building management system, permits:
 - Dynamic calculation of the outdoor air needed to adequately ventilate a multispace VAV system and reset the outdoor-air setpoint accordingly to save energy.
 - Trend logs and custom reports to document compliance with ASHRAE Standard 62.1.
- For indoor units, an additional mixing box can be used as an economizer to provide an exhaust path for return air, allowing the main mixing box to provide natural, non-mechanical cooling when outdoor air conditions are suitable.
- For outdoor units, and economizer section can be used to provide a path for outside air, return air and exhaust air in a single section.
- Use freeze protection for coils downstream of the mixing box when incoming outdoor air is below 35°F (see [“Protect Coils from Freezing,” p. 20](#)).

Multizone

The multizone module consists of a cooling coil, heating coil, and dampers with multiple zones. It can be split into either two decks or three decks, each with a separate air stream. The “cold” deck cools one air stream and the “hot” deck heats another air stream. A third deck can be used for bypass air. The damper then mixes these air streams to achieve a certain mixed-air temperature. The damper is divided into segments so that one AHU can deliver multiple supply air temperatures. Baffles ensure equal pressure drops through each deck of the unit.

The multizone module is always used in a blow-thru arrangement and is typically placed directly downstream of the supply fan.

Note: The number of zones that one multizone AHU can supply varies by unit size. Be aware that ASHRAE Standard 90.1 does not allow for multizone configurations without bypass for new construction.

Silencers

Figure 64. Sound attenuators used in low NC level applications



Controlling noise at its source is the most cost-effective solution for providing quiet comfort in the space. Source attenuation can eliminate the need for duct-mounted silencers and thereby lower fan operating costs. The key to a quiet design is to know which options and layouts have a sound source that achieves the target noise criterion (NC) level when reduced by space attenuation. It all starts with accurate, tested sound data, and Trane has the most complete sound power data in the industry.

The design process involves predicting the unit sound power and projecting it into the space, then optimizing the path attenuation (ductwork, ceilings) and the unit sound (fans, plenums) to get the lowest cost system that meets the requirements. Designing the right unit is a matter of experience and solid acoustical data. Obviously, the quieter the sound source, the less path attenuation is needed in the sound paths. Minimizing the sound source, using a quieter fan, or using more source attenuation increases the initial cost of the air handler, but is generally offset by significant path-reduction cost savings.



General Data

This section includes summary information per unit size, including section dimensions and weights, coil availability, filter areas and sizes, fan section weights and application data, and damper areas.

Note: For specific dimensional and weight information, refer to the unit submittals. The dimensions and weights in this manual are approximate. Trane has a policy of continuous product and product data improvement and reserves the right to change design and specifications without notice.

Unit Size 3

Table 10. Section dimensions (inches) and weights (pounds) - unit size 3

Nominal airflow	1500	
Airflow at 625 fpm	2169	
Height - indoor unit (in.)	29.00	
Width (in.)	31.50	
Height - outdoor unit (in.) includes base drip lip	36.25	
Weight add for outdoor unit (lbs./in. of unit length)	1.66	
Section type	Length (in.)	Weight (lb.)
Access or blank		
-Small horizontal	10.00	48.05
-Medium horizontal	14.00	59.91
-Extended-medium horizontal	19.00	74.73
-Medium-large horizontal	24.50	121.60
-Large horizontal or turning	34.00	137.75
-Extra-large horizontal or turning	36.00	143.68
-Ducted inlet or ducted outlet section	10.00	48.10
Blender	19.00	94.86
Cool Dry Quiet (CDQ) Desiccant Dehumidification Section	52.00	495.00
Coils		
-Small horizontal (with 4-row UW)	10.00	116.10
-Medium horizontal (with 8-row UW)	14.00	168.65
-Extended-medium horizontal (with 8-row UW)	19.00	185.58
-Medium-large horizontal (with 10-row W)	24.50	270.61
-Large horizontal or vertical (with 10-row W)	34.00	302.77
-Electric Heat Coil	36.00	295.00
-Integral-face-and-bypass (IFB) coil	n/a	n/a
Controls section (includes largest available VFD)	28.50	184.00
Diffuser	10.00	45.70
Discharge plenum		
-Horizontal	34.00	135.40
-Vertical	36.00	159.90
Energy Wheel	n/a	n/a
Face-and-Bypass Dampers		
-Face-and-bypass	19.00	105.60
-External face-and-bypass	19.00	122.68
-Internal face-and-bypass or face damper only	19.00	107.95



General Data

Table 10. Section dimensions (inches) and weights (pounds) - unit size 3

Fan	Length (in.)	Weight (lb.)
-Belt-drive plenum (BDP) fan with motor	36.00	397.87
-Housed fan FC with motor	36.00	368.77
-Housed AF/BC fans with motor	36.00	378.87
-Direct-drive plenum fan with motor	36.00	373.16
Filters		
-Side load 2-in. angled	24.50	134.55
-Side load 4-in. angled	24.50	141.89
-Side load cartridge 12-in. or short bag 18-in.	24.50	125.03
-Side load 2-in. flat	14.00	70.27
-Side load 4-in. flat	14.00	81.56
Filters		
-Side load 2-in. and 4-in. combination flat	19.00	100.62
-Long bag 30-in.	36.00	159.54
-Front-load HEPA	40.00	240.36
-Front-load cartridge, 2-inch and 4-inch	40.00	215.15
-Front-load short bag	45.00	222.35
Gas heat	n/a	n/a
Humidifier		
-Building Steam	14.00	125.00
-Atmospheric	14.00	127.00
Mixing box		
-with angled filters	34.00	137.75
-with front/back Traq and top Traq dampers	36.00	191.06
- reduced length mixing box with side/top/back/bottom airfoil damper	23.40	131.80
Multizone	n/a	n/a
Silencer		
-3 feet	38.00	198.00
-5 feet	62.00	308.00
Trane Catalytic Air Cleaning System (TCACS)	36.00	334.73
UV light	14.00	76.02
SECTIONS BELOW ARE FOR OUTDOOR UNITS ONLY		
Diagonal economizer		
-with airfoil dampers	46.00	187.00
-with airfoil damper and one side Traq damper	46.00	204.00
Exhaust damper section	19.00	93.30
Hoods		
- Back inlet hood - airfoil and Traq	22.25	22.00
- Side inlet hood - airfoil and Traq	20.00	17.00
- Exhaust hood - airfoil	20.00	12.00
- Economizer inlet hood	45.50	41.00
Pipe Cabinets		
15 in. long - 24-in. depth	15.00	77.00
15 in. long - 36-in. depth	15.00	104.00
15 in. long - 48-in. depth	15.00	132.00
24 in. long - 24-in. depth	24.00	91.00
24 in. long - 36-in. depth	24.00	122.00
24 in. long - 48-in. depth	24.00	153.00

Table 10. Section dimensions (inches) and weights (pounds) - unit size 3

Pipe Cabinets	Length (in.)	Weight (lb.)
48 in. long - 24-in. depth	48.00	130.00
48 in. long - 36-in. depth	48.00	169.00
48 in. long - 48-in. depth	48.00	208.00
96 in. long - 24-in. depth	96.00	207.00
96 in. long - 36-in. depth	96.00	263.00
96 in. long - 48-in. depth	96.00	319.00

Table 11. Filter data for unit size 3

Filter Type	Area ft ²	Qty-Size (in.)
Flat (2-in., 4-in., and 2-in/4-in high efficiency) pleated, permanent, throwaway media	3.47	1 - 20x25
Angled (2-in. or 4-in.) Pleated, permanent, throwaway media	5.56	2 - 16x25
Side load bag or cartridge	3.33	1 - 20x24
Front load bag or cartridge	2.00	1 - 12x24
Front load HEPA	2.00	1 - 12x24

Note: 2-inch filters available in permanent, throwaway, or pleated media; 4-inch filters available in pleated media, 65%, 85%, or 95% efficiency; Bag or cartridge filters available in 65%, 85%, or 95% efficiency.

Table 12. Coil availability - unit size 3

Section Type	1/2-in Unit Coils	5/8-in Unit Coils, 1/2-in and 5/8-in Modified Coils
Small	2-4 rows	1-2 rows
Medium	2-8 rows	1-4 rows
Extended-medium	2-8 rows	1-8 rows
Medium-large	2-8 rows	1-10 rows
-with access	2-6 rows	1-3 rows
Large horizontal	2-8 rows	1-10 rows
-with access	2-8 rows	1-6 rows
Large vertical	2-8 rows	1-6 rows
-with access	2-8 rows	1-4 rows

Table 13. Coil data for unit size 3

Coil Type	Rows	Fin Type	Area ft ²	Qty-Size (in.)
1/2-inch unit coils				
-UA, UW, UF	2, 4, 6, 8	Aluminum	2.92	1-20 × 21
5/8-inch unit coils				
-W, 5A, 5W, D1, TT, P2, P4, P8	1, 2, 3, 4, 6, 8, 10	Aluminum or Copper	2.50	1-18 × 20
-WD, D2	6, 8, 10	Aluminum or Copper	2.38	1-18 × 19
1-inch unit coil				
-NS	1	Aluminum or Copper	2.50	1-18 × 20
1/2-inch modified coil				
-WL	2, 4, 6, 8	Aluminum	1.74	1-12.50 × 20
5/8-inch modified coils				
-W, 5A, 5W, D1, TT, P2, P4	1, 2, 3, 4, 6, 8, 10	Aluminum or Copper	1.67	1-12 × 20
1-inch modified coil				
-NS	1	Aluminum or Copper	1.67	1-12 × 20



General Data

Table 14. Fan data for unit size 3

Size/type Fan name	Housed Fans							
	Low Pressure				High Pressure			
	9-in FC 9FA	9-6-in FC 5FA	9-4-in FC 4FA	9-in BC 9BA	9-in FC 9FB	9-6-in FC 5FB	9-4-in FC 4FB	9-in BC 9BB
Max TSP/rpm	4/2250	4.5/2250	4.5/2250	6.5/4375	5/2900	6.5/2900	7/2900	8/5000
ODP NEMA Prem motor hp range	0.75-3	0.75-3	0.75-3	0.75-3	0.75-3	0.75-3	0.75-3	0.75-5
Outlet area (ft ²)	0.85	0.60	0.50	0.85	0.85	0.60	0.50	0.85
Bearing/Shaft size (in.)	0.75	0.75	0.75	0.75	0.75	0.75	0.75	0.75

Size/type Fan name	Belt-drive Plenum Fans		Direct-Drive Plenum Fans	
	High Pressure		High Pressure	
	11-in BC 11PB	10-in BC 10PB	10.5-in. AF Nominal Width 10NF	10.5-in. AF Extended Width 10NW
Max TSP/rpm	9/4735	8/5200	5195	5195
ODP NEMA Prem motor hp range	0.75-5	0.75-3	1-5	1.5-5
Outlet area (ft ²)			n/a	n/a
Bearing/Shaft size (in.)			n/a	n/a

Unit Size 4

Table 15. Section dimensions (inches) and weights (pounds) - unit size 4

Nominal airflow	2000	
Airflow at 625 fpm	3475	
Height - indoor unit (in.)	29.00	
Width (in.)	44.00	
Height - outdoor unit (in.) includes base drip lip	36.38	
Weight add for outdoor unit (lbs./in. of unit length)	1.91	
Section type	Length (in.)	Weight (lb.)
Access or blank		
-Small horizontal	10.00	57.43
-Medium horizontal	14.00	71.18
-Extended-medium horizontal	19.00	88.37
-Medium-large horizontal	24.50	107.28
-Large horizontal or turning	34.00	164.85
-Extra-large horizontal or turning	41.00	188.92
-Ducted inlet or ducted outlet section	10.00	57.40
Blender	24.50	132.71
Cool Dry Quiet (CDQ) Desiccant Dehumidification Section	52.00	651.00
Coils		
-Small horizontal (with 4-row UW)	10.00	148.55
-Medium horizontal (with 8-row UW)	14.00	220.23
-Extended-medium horizontal (with 8-row UW)	19.00	239.53
-Medium-large horizontal (with 10-row W)	24.50	359.79
-Large horizontal or vertical (with 10-row W)	34.00	396.45
-Electric Heat Coil	41.00	364.00
-Integral-face-and-bypass (IFB) coil		
--Less than 4 rows	26.50	355.20
--4 rows	43.00	543.54

Table 15. Section dimensions (inches) and weights (pounds) - unit size 4

Section type	Length (in.)	Weight (lb.)
Controls section (includes largest available VFD)	28.50	208.00
Diffuser	10.00	55.08
Discharge plenum		
-Horizontal	34.00	162.50
-Vertical	41.00	211.48
Energy Wheel	52.00	609.00
Face-and-Bypass Dampers		
-Face-and-bypass	19.00	129.06
-External face-and-bypass	19.00	155.15
-Internal face-and-bypass or face damper only	19.00	140.46
Fan		
-Belt-drive plenum (BDP) fan with motor	41.00	538.34
-Housed fan FC with motor	41.00	449.75
-Housed AF/BC fans with motor	41.00	467.35
-Direct-drive plenum fan with motor	41.00	516.35
Filters		
-Side load 2-in. angled	24.50	163.83
-Side load 4-in. angled	24.50	176.87
-Side load cartridge 12-in. or short bag 18-in.	24.50	159.79
Filters		
-Side load 2-in. flat	14.00	86.53
-Side load 4-in. flat	14.00	104.62
-Side load 2-in. and 4-in. combination flat	19.00	128.19
-Long bag 30-in.	41.00	203.31
-Front-load HEPA	40.00	262.50
-Front-load cartridge	40.00	237.79
-Front-load short bag	45.00	246.75
Gas heat	n/a	n/a
Humidifier		
-Building Steam	14.00	146.00
-Atmospheric	14.00	168.00
Mixing box		
-with angled filters	34.00	164.85
-with front/back Traq and top Traq dampers	41.00	247.07
- reduced length mixing box with side/top/back/bottom airfoil damper	23.40	158.30
Multizone	n/a	n/a
Silencer		
-3 feet	38.00	256.00
-5 feet	62.00	391.00
Trane Catalytic Air Cleaning System (TCACS)	36.00	367.14
UV light	14.00	93.64
SECTIONS BELOW ARE FOR OUTDOOR UNITS ONLY		
Diagonal economizer		
-with airfoil dampers	49.00	231.00
-with airfoil damper and one side Traq damper	49.00	247.00
Exhaust damper section	19.00	113.30



General Data

Table 15. Section dimensions (inches) and weights (pounds) - unit size 4

Hoods	Length (in.)	Weight (lb.)
- Back inlet hood - airfoil and Traq	44.00	45.00
- Side inlet hood - airfoil and Traq	20.00	17.00
- Exhaust hood - airfoil	20.00	12.00
- Economizer inlet hood	49.00	37.00
Pipe Cabinets		
15 in. long - 24-in. depth	15.00	77.00
15 in. long - 36-in. depth	15.00	104.00
15 in. long - 48-in. depth	15.00	132.00
24 in. long - 24-in. depth	24.00	91.00
24 in. long - 36-in. depth	24.00	122.00
24 in. long - 48-in. depth	24.00	153.00
48 in. long - 24-in. depth	48.00	130.00
48 in. long - 36-in. depth	48.00	169.00
48 in. long - 48-in. depth	48.00	208.00
96 in. long - 24-in. depth	96.00	207.00
96 in. long - 36-in. depth	96.00	263.00
96 in. long - 48-in. depth	96.00	319.00

Table 16. Filter data for unit size 4

Filter Type	Area ft ²	Qty-Size (in.)
Flat (2-in., 4-in., and 2-in/4-in high efficiency) pleated, permanent, throwaway media	5.56	2 - 20x20
Angled (2-in. or 4-in.) pleated, permanent, throwaway media	8.89	4 - 16x20
Side load bag or cartridge	5.56	2 - 20x20
Front load bag or cartridge	2.00	1 - 12x24
Front load HEPA	2.00	1 - 12x24

Note: 2-inch filters available in permanent, throwaway, or pleated media; 4-inch filters available in pleated media, 65%, 85%, or 95% efficiency; Bag or cartridge filters available in 65%, 85%, or 95% efficiency.

Table 17. Coil availability - unit size 4

Section Type	1/2-in Unit Coils	5/8-in Unit Coils, 1/2-in and 5/8-in Modified Coils
Small	2-4 rows	1-2 rows
Medium	2-8 rows	1-4 rows
Extended-medium	2-8 rows	1-8 rows
Medium-large	2-8 rows	1-10 rows
-with access	2-6 rows	1-3 rows
Large horizontal	2-8 rows	1-10 rows
-with access	2-8 rows	1-6 rows
Large vertical	2-8 rows	1-6 rows
-with access	2-8 rows	1-4 rows

Table 18. Coil data for unit size 4

Coil Type	Rows	Fin Type	Area ft ²	Qty-Size (in.)
1/2-inch unit coils				
-UA, UW, UF	1, 2, 4, 6, 8	Aluminum	4.51	1-20 × 32.50
5/8-inch unit coils				
-W, 5A, 5W, D1, TT, P2, P4, P8	1, 2, 3, 4, 6, 8, 10	Aluminum or Copper	4.00	1-18 × 32
-WD, D2	6, 8, 10	Aluminum or Copper	3.88	1-18 × 31
1-inch unit coil				
-NS	1	Aluminum or Copper	4.00	1-18 × 32
1/2-inch modified coil				
-WL	1, 2, 4, 6, 8	Aluminum	2.78	1-12.50 × 32
5/8-inch modified coils				
-W, 5A, 5W, D1, TT, P2, P4	1, 2, 3, 4, 6, 8, 10	Aluminum or Copper	2.67	1-12 × 32
1-inch modified coil				
-NS	1	Aluminum or Copper	2.67	1-12 × 32

Table 19. Fan data for unit size 4

Size/type Fan name	Housed Fans									
	Low Pressure					High Pressure				
	10-in. FC 10FA	9-in. FC 9FA	9-6-in. FC 5FA	10-in. BC 10BA	9-in. BC 9BA	10-in. FC 10FB	9-in. FC 9FB	9-6-in. FC 5FB	10-in. BC 10BB	9-in. BC 9BB
Max TSP/rpm	4.5/2100	4/2250	4.5/2250	5/4070	6/4375	6/2525	6/2900	6.5/2900	8/4650	8/5000
ODP NEMA Premium motor hp range	0.75-5	0.75-3	0.75-3	0.75-3	0.75-3	0.75-5	0.75-5	0.75-5	0.75-5	0.75-5
Outlet area (ft ²)	1.04	0.84	0.60	1.04	0.85	1.04	0.84	0.60	1.03	0.85
Bearing/Shaft size (in.)	0.75	0.75	0.75	0.75	0.75	0.75	0.75	0.75	0.75	0.75
Size/type Fan name	Belt-drive Plenum Fans			Direct-Drive Plenum Fans						
	Low Pressure		High Pressure	High Pressure						
	12-in. AF 12PA	12-in. AF 12PB	11-in. BC 11PB	13.5-in AF Reduced Width 13NR		13.5-in AF Nominal Width 13NF				
Max TSP/rpm	7/4130	7.5/4500	9/4735	4038		4038				
ODP NEMA Premium motor hp range	0.75-5	0.75-7.5	0.75-5	1.5-7.5		1.5-7.5				
Outlet area (ft ²)	n/a	n/a	n/a	n/a		n/a				
Bearing/Shaft size (in.)	1.00	1.19	0.75	n/a		n/a				



General Data

Unit Size 6

Table 20. Section dimensions (inches) and weights (pounds) - unit size 6

Nominal airflow	3000	
Airflow at 625 fpm	4338	
Height - indoor unit (in.)	35.25	
Width (in.)	44.00	
Height - outdoor unit (in.) includes base drip lip	42.63	
Weight add for outdoor unit (lbs./in. of unit length)	1.91	
Section type	Length (in.)	Weight (lb.)
Access or blank⁵		
-Small horizontal	10.00	60.55
-Medium horizontal	14.00	75.25
-Extended-medium horizontal	19.00	93.62
-Medium-large horizontal	24.50	113.84
-Large horizontal or turning	34.00	179.46
-Extra-large horizontal or turning	41.00	205.18
-Ducted inlet or ducted outlet section	10.00	60.50
Blender	24.50	146.30
Cool Dry Quiet (CDQ) Desiccant Dehumidification Section	52.00	694.00
Coils		
-Small horizontal (with 4-row UW)	10.00	174.35
-Medium horizontal (with 8-row UW)	14.00	265.58
-Extended-medium horizontal (with 8-row UW)	19.00	286.06
-Medium-large horizontal (with 10-row W)	24.50	433.08
-Large horizontal or vertical (with 10-row W)	34.00	471.99
-Electric Heat Coil	41.00	413.00
-Integral-face-and-bypass (IFB) coil		
--Less than 4 rows	26.50	367.21
--4 rows	43.00	560.74
Controls section (includes largest available VFD)	28.50	253.00
Diffuser	10.00	58.20
Discharge plenum		
-Horizontal	34.00	177.11
-Vertical	41.00	233.54
Energy Wheel	52.00	663.00
Face-and-Bypass Dampers		
-Face-and-bypass	19.00	141.70
-External face-and-bypass	19.00	167.79
-Internal face-and-bypass or face damper only	19.00	149.91
Fan		
-Belt-drive plenum (BDP) fan with motor	41.00	631.36
-Housed fan FC with motor	41.00	544.28
-Housed AF/BC fans with motor	41.00	574.68
-Direct-drive plenum fan with motor	41.00	535.05

Table 20. Section dimensions (inches) and weights (pounds) - unit size 6

Filters	Length (in.)	Weight (lb.)
-Side load 2-in. angled	24.50	175.66
-Side load 4-in. angled	24.50	192.86
-Side load cartridge 12-in. or short bag 18-in.	24.50	176.46
-Side load 2-in. flat	14.00	91.98
-Side load 4-in. flat	14.00	114.08
-Side load 2-in. and 4-in. combination flat	19.00	139.09
-Long bag 30-in.	41.00	224.00
-Front-load HEPA	40.00	346.00
-Front-load cartridge	40.00	286.00
-Front-load short bag	45.00	280.00
Gas heat		
- 200 MBH	57.00	752.90
- 300 MBH	73.00	901.30
Humidifier		
-Building Steam	14.00	165.00
-Atmospheric	14.00	178.00
Mixing box		
-with angled filters	34.00	179.46
-with front/back Traq and top Traq dampers	41.00	272.06
- reduced length mixing box with side/top/back/bottom airfoil damper	23.40	177.90
Multizone		
- 3-deck vertical discharge	61.00	1125.00
- 2-deck vertical discharge	61.00	763.00
- 3-deck horizontal discharge	52.00	1031.00
- 2-deck horizontal discharge	52.00	701.00
Silencer		
-3 feet	38.00	286.00
-5 feet	62.00	436.00
Trane Catalytic Air Cleaning System (TCACS)	36.00	389.00
UV light	14.00	98.69
SECTIONS BELOW ARE FOR OUTDOOR UNITS ONLY		
Diagonal economizer		
-with airfoil dampers	50.00	256.00
-with airfoil damper and one side Traq damper	50.00	271.00
Exhaust damper section	19.00	124.30
Hoods		
- Back inlet hood - airfoil and Traq	44.00	47.00
- Side inlet hood - airfoil and Traq	20.00	22.00
- Exhaust hood - airfoil	20.00	16.00
- Economizer inlet hood	49.50	45.00
Pipe Cabinets		
15 in. long - 24-in. depth		
15 in. long - 36-in. depth	15.00	116.00
15 in. long - 48-in. depth	15.00	146.00
24 in. long - 24-in. depth	24.00	101.00
24 in. long - 36-in. depth	24.00	135.00
24 in. long - 48-in. depth	24.00	168.00



General Data

Table 20. Section dimensions (inches) and weights (pounds) - unit size 6

Pipe Cabinets	Length (in.)	Weight (lb.)
48 in. long - 24-in. depth	48.00	142.00
48 in. long - 36-in. depth	48.00	184.00
48 in. long - 48-in. depth	48.00	226.00
96 in. long - 24-in. depth	96.00	226.00
96 in. long - 36-in. depth	96.00	284.00
96 in. long - 48-in. depth	96.00	343.00

Table 21. Filter data for unit size 6

Filter Type	Area ft ²	Qty-Size (in.)
Flat (2-in., 4-in., and 2-in/4-in high efficiency) pleated, permanent, throwaway media	5.56	2 - 20x25
Angled (2-in. or 4-in.) Pleated, permanent, throwaway media	8.89	4 - 16x20
Side load bag or cartridge	6.67	2 - 24x20
Front load bag or cartridge	6.00	1 - 24x24 1 - 24x12
Front load HEPA	6.00	1 - 24x24 1 - 24x12

Note: 2-inch filters available in permanent, throwaway, or pleated media; 4-inch filters available in pleated media, 65%, 85%, or 95% efficiency; Bag or cartridge filters available in 65%, 85%, or 95% efficiency.

Table 22. Coil availability - unit size 6

Section Type	5/8-in Unit Coils,	
	1/2-in Unit Coils	1/2-in and 5/8-in Modified Coils
Small	2-4 rows	1-2 rows
Medium	2-8 rows	1-4 rows
Extended-medium	2-8 rows	1-8 rows
Medium-large	2-8 rows	1-10 rows
-with access	2-6 rows	1-3 rows
Large horizontal	2-8 rows	1-10 rows
-with access	2-8 rows	1-6 rows
Large vertical	2-8 rows	1-6 rows
-with access	2-8 rows	1-4 rows

Table 23. Coil data for unit size 6

Coil Type	Rows	Fin Type	Area ft ²	Qty-Size (in.)
1/2-inch unit coils				
-UA,UW, UF	1, 2, 4, 6, 8	Aluminum	6.11	1-26.25 x 33.50
5/8-inch unit coils				
-W, 5A, 5W, D1, TT, P2, P4, P8	1, 2, 3, 4, 6, 8, 10	Aluminum or Copper	5.33	1-24 x 32
-WD, D2	6, 8, 10	Aluminum or Copper	5.17	1-24 x 31
1-inch unit coil				
-NS	1	Aluminum or Copper	5.33	1-24 x 32
1/2-inch modified coil				
-WL	1, 2, 4, 6, 8	Aluminum	2.78	1-12.50 x 32
5/8-inch modified coils				
-W, 5A, 5W, D1, TT, P2, P4	1, 2, 3, 4, 6, 8, 10	Aluminum or Copper	2.67	1-12 x 32

Table 23. Coil data for unit size 6

Coil Type	Rows	Fin Type	Area ft ²	Qty–Size (in.)
1-inch modified coil				
-NS	1	Aluminum or Copper	2.67	1–12 x 32
Multizone coils				
-5A, 5W, NS, TT	1, 2	Aluminium or Copper	2.67	1-12 x 32
-WL	2	Aluminum	2.67	1-12 x 32

Table 24. Fan data for unit size 6

Size/Type Fan Name	Housed Fans - Low Pressure					
	12-in. FC 12FA	10-in. FC 10FA	9-in. FC 9FA	12-in. AF 12AA	10-in. BC 10BA	9-in. BC 9BA
Max rpm	1900	2100	2250	3700	4070	4375
ODP NEMA Premium motor hp range	0.75-5	0.75-5	0.75-3	0.75-7.5	0.75-3	0.75-3
Outlet area (ft ²)	1.46	1.03	0.84	1.46	1.03	0.84
Bearing/Shaft size (in.)	1.00	0.75	0.75	1.00	0.75	0.75
Size/Type Fan name	Housed Fans - High Pressure					
	12-in. FC 12FB	10-in. FC 10FB	9-in. FC 9FB	12-in. AF 12AB	10-in. BC 10BB	9-in. BC 9BB
Max rpm	2115	2525	2900	4350	4650	5000
ODP NEMA Premium motor hp range	0.75-7.5	0.75-7.5	0.75-5	0.75-7.5	0.75-5	0.75-5
Outlet area (ft ²)	1.46	1.03	0.84	1.46	1.03	0.84
Bearing/Shaft size (in.)	1.19	0.75	0.75	1.44	0.75	0.75
Size/Type Fan name	Belt-drive Plenum Fans				Direct-Drive Plenum Fans	
	Low Pressure		High Pressure		High Pressure	
	16-in. AF 16PA	14-in. AF 14PA	16-in. AF 16PB	14-in. AF 14PB	15-in. AF Reduced Width 15NR	15-in. AF Nominal Width 15NF
Max rpm	3300	3670	3700	4000	3650	3650
ODP NEMA Premium motor hp range	0.75-10	0.75-7.5	0.75-10	0.75-10	1.5-10	1.5-10
Outlet area (ft ²)	n/a	n/a	n/a	n/a	n/a	n/a
Bearing/Shaft size (in.)	1.19	1.00	1.4	1.19	n/a	n/a



General Data

Unit Size 8

Table 25. Section dimensions (inches) and weights (pounds) - unit size 8

Nominal airflow	4000	
Airflow at 625 fpm	4581	
Height - indoor unit (in.)³	37.75	
Width (in.)	50.50	
Height - outdoor unit (in.)⁴ includes base drip lip	45.13	
Weight add for outdoor unit (lbs./in. of unit length)	2.04	
Section type	Length (in.)	Weight (lb.)
Access or blank⁵		
-Small horizontal	10.00	66.67
-Medium horizontal	14.00	82.74
-Extended-medium horizontal	19.00	102.82
-Medium-large horizontal	26.50	132.94
-Large horizontal or turning	36.00	208.50
-Extra-large horizontal or turning	44.00	240.63
-Ducted inlet or ducted outlet section	10.00	66.70
Blender	26.50	173.34
Cool Dry Quiet (CDQ) Desiccant Dehumidification Section	52.00	792.00
Coils		
-Small horizontal (with 4-row UW)	10.00	205.79
-Medium horizontal (with 8-row UW)	14.00	318.97
-Extended-medium horizontal (with 8-row UW)	19.00	341.16
-Medium-large horizontal (with 10-row W)	26.50	554.88
-Large horizontal or vertical (with 10-row W)	36.00	597.03
-Electric Heat Coil	44.00	480.00
-Integral-face-and-bypass (IFB) coil		
--Less than 4 rows	26.50	470.21
--4 rows	43.00	725.48
Controls section (includes largest available VFD)	28.50	272.00
Diffuser	14.00	80.39
Discharge plenum		
-Horizontal	36.00	206.15
-Vertical	44.00	275.69
Energy Wheel	52.00	765.00
Face-and-Bypass Dampers		
-Face-and-bypass	19.00	157.63
-External face-and-bypass	19.00	190.70
-Internal face-and-bypass or face damper only	19.00	174.82
Fan		
-Belt-drive plenum (BDP) fan with motor	44.00	682.55
-Housed fan FC with motor	44.00	589.00
-Housed AF/BC fans with motor	44.00	649.40
-Direct-drive plenum fan with motor	44.00	692.86

Table 25. Section dimensions (inches) and weights (pounds) - unit size 8

Filters	Length (in.)	Weight (lb.)
-Side load 2-in. angled	26.50	202.44
-Side load 4-in. angled	26.50	209.64
-Side load cartridge 12-in. or short bag 18-in.	26.50	220.46
-Side load 2-in. flat	14.00	103.59
-Side load 4-in. flat	14.00	117.09
-Side load 2-in. and 4-in. combination flat	19.00	144.56
-Long bag 30-in.	44.00	269.00
-Front-load HEPA	40.00	368.00
-Front-load cartridge	40.00	310.00
-Front-load short bag	45.00	306.00
Gas heat		
- 200 MBH	57.00	797.90
- 300 MBH	73.00	953.50
Humidifier		
-Building Steam	14.00	184.00
-Atmospheric	14.00	203.00
Mixing box		
-with angled filters	36.00	208.50
-with front/back Traq and top Traq dampers	44.00	321.58
- reduced length mixing box with side/top/back/bottom airfoil damper	23.40	202.80
Multizone		
- 3-deck vertical discharge	61.00	1313.00
- 2-deck vertical discharge	61.00	899.00
- 3-deck horizontal discharge	52.00	1219.00
- 2-deck horizontal discharge	52.00	832.00
Silencer		
-3 feet	38.00	376.00
-5 feet	62.00	483.00
Trane Catalytic Air Cleaning System (TCACS)	36.00	435.00
UV light	14.00	120.26
SECTIONS BELOW ARE FOR OUTDOOR UNITS ONLY		
Diagonal economizer		
-with airfoil dampers	48.00	276.00
-with airfoil damper and one side Traq damper	48.00	290.00
Exhaust damper section	19.00	140.20
Hoods		
- Back inlet hood - airfoil and Traq	50.38	47.00
- Side inlet hood - airfoil and Traq	20.00	22.00
- Exhaust hood - airfoil	20.00	16.00
- Economizer inlet hood	48.00	61.00
Pipe Cabinets		
15 in. long - 24-in. depth	15.00	89.00
15 in. long - 36-in. depth	15.00	120.00
15 in. long - 48-in. depth	15.00	152.00
24 in. long - 24-in. depth	24.00	105.00
24 in. long - 36-in. depth	24.00	140.00
24 in. long - 48-in. depth	24.00	174.00

General Data

Table 25. Section dimensions (inches) and weights (pounds) - unit size 8

Pipe Cabinets	Length (in.)	Weight (lb.)
48 in. long - 24-in. depth	48.00	148.00
48 in. long - 36-in. depth	48.00	191.00
48 in. long - 48-in. depth	48.00	234.00
96 in. long - 24-in. depth	96.00	233.00
96 in. long - 36-in. depth	96.00	293.00
96 in. long - 48-in. depth	96.00	352.00

Table 26. Filter data for unit size 8

Filter Type	Area ft ²	Qty—Size (in.)
Flat (2-in., 4-in., and 2-in/4-in high efficiency) pleated, permanent, throwaway media	7.33	1 - 24x20 1 - 24x24
Angled (2-in. or 4-in.) Pleated, permanent, throwaway media	11.11	4 - 20x20
Side load bag or cartridge	8.00	4 - 24x12
Front load bag or cartridge	6.00	1 - 24x24 1 - 24x12
Front load HEPA	7.00	1 - 24x30 1 - 24x12

Note: 2-inch filters available in permanent, throwaway, or pleated media; 4-inch filters available in pleated media, 65%, 85%, or 95% efficiency; Bag or cartridge filters available in 65%, 85%, or 95% efficiency

Table 27. Coil availability - unit size 8

Section Type	5/8-in Unit Coils, 1/2-in and 5/8-in Modified Coils	
	1/2-in Unit Coils	5/8-in Unit Coils, 1/2-in and 5/8-in Modified Coils
Small	2-4 rows	1-2 rows
Medium	2-8 rows	1-4 rows
Extended-medium	2-8 rows	1-8 rows
Medium-large	2-8 rows	1-10 rows
-with access	2-6 rows	1-3 rows
Large horizontal	2-8 rows	1-10 rows
-with access	2-8 rows	1-6 rows
Large vertical	2-8 rows	1-6 rows
-with access	2-8 rows	1-6 rows

Table 28. Coil data for unit size 8

Coil Type	Rows	Fin Type	Area ft ²	Qty—Size (in.)
1/2-inch unit coils				
-UA, UW, UF	1, 2, 4, 6, 8	Aluminum	7.99	1-28.75 × 40
5/8-inch unit coils				
-W, 5A, 5W, D1	1, 2, 3, 4, 6, 8, 10	Aluminum or Copper	7.31	1-27 × 39
-WD, D2	6, 8, 10	Aluminum or Copper	7.13	1-27 × 38
-TT, P2, P4, P8	1, 2, 4, 6, 8	Aluminum or Copper	6.50	1-24 × 39
1-inch unit coil				
-NS	1	Aluminum or Copper	6.50	1-24 × 39
1/2-inch modified coils				
-WL, LL, FD	2, 4, 6, 8	Aluminum	4.95	1-18.75 × 38

Table 28. Coil data for unit size 8

Coil Type	Rows	Fin Type	Area ft ²	Qty–Size (in.)
5/8-inch modified coils				
-W, 5A, 5W, D1, TT, P2, P4, P8	1, 2, 3, 4, 6, 8,10	Aluminum or Copper	4.88	1–18 x 39
-WD, D2	6, 8, 10	Aluminum or Copper	4.75	1–18 x 38
1-inch modified coil				
-NS	1	Aluminum or Copper	4.88	1–18 x 39
Multizone coils				
-5A, 5W, NS, TT	1, 2	Aluminium or Copper	3.25	1-12 x 39
-WL	2	Aluminum	3.25	1-12 x 39

Table 29. Fan data for unit size 8

Size/Type Fan name	Housed Fans - Low Pressure					
	12-in. FC 12FA	10-in. FC 10FA	9-in. FC 9FA	12n. AF 12AA	10-in. BC 10BA	9-in. BC 9BA
Max rpm	1900	2100	2250	3700	4070	4375
ODP NEMA Premium motor hp range	1-5	1-5	1-3	1-7.5	1-3	1-3
Outlet area (ft ²)	1.46	1.03	0.84	1.46	1.03	0.84
Bearing/Shaft size (in.)	1.00	0.75	0.75	1.00	0.75	0.75
Size/Type Fan name	Housed Fans - High Pressure					
	12-in. FC 12FB	10-in. FC 10FB	9-in. FC 9FB	12-in. AF 12AB	10-in. BC 10BB	9-in. BC 9BB
Max rpm	2115	2525	2900	4350	4650	5000
ODP NEMA Premium motor hp range	1-7.5	1-7.5	1-5	1-10	1-5	1-5
Outlet area (ft ²)	1.46	1.03	0.84	1.46	1.03	0.84
Bearing/Shaft size (in.)	1.19	0.75	0.75	1.44	0.75	0.75
Size/Type Fan name	Belt-drive Plenum Fans				Direct-Drive Plenum Fans	
	Low Pressure		High Pressure		High Pressure	
	16-in. AF 16PA	14-in. AF 14PA	16-in. AF 16PB	14-in. AF 14PB	18-in. AF Reduced Width 18NR	18-in. AF Nominal Width 18NF
Max rpm	3300	3670	3700	4000	2979	2979
ODP NEMA Premium motor hp range	1-10	1-7.5	1-10	1-10	2-15	3-15
Outlet area (ft ²)	n/a	n/a	n/a	n/a	n/a	n/a
Bearing/Shaft size (in.)	1.19	1.00	1.34	1.19	n/a	n/a



General Data

Unit Size 10

Table 30. Section dimensions (inches) and weights (pounds) - unit size 10

Nominal airflow	5000	
Airflow at 625 fpm	6075	
Height - indoor unit (in.)	37.75	
Width (in.)	61.50	
Height - outdoor unit (in.) includes base drip lip	45.13	
Weight add for outdoor unit (lbs./in. of unit length)	2.27	
Section type	Length (in.)	Weight (lb.)
Access or blank		
-Small horizontal	10.00	74.92
-Medium horizontal	14.00	92.66
-Extended-medium horizontal	19.00	114.83
-Medium-large horizontal	26.50	148.08
-Large horizontal or turning	36.00	235.01
-Extra-large horizontal or turning	42.50	263.83
-Ducted inlet or ducted outlet section	10.00	74.90
Blender	36.00	238.64
Cool Dry Quiet (CDQ) Desiccant Dehumidification Section	55.00	1011.00
Coils		
-Small horizontal (with 4-row UW)	10.00	244.49
-Medium horizontal (with 8-row UW)	14.00	382.53
-Extended-medium horizontal (with 8-row UW)	19.00	406.80
-Medium-large horizontal (with 10-row W)	26.50	656.63
-Large horizontal or vertical (with 10-row W)	36.00	702.74
-Electric Heat Coil	42.50	563.00
-Integral-face-and-bypass (IFB) coil		
--Less than 4 rows	26.50	541.93
--4 rows	43.00	835.34
Controls section (includes largest available VFD)	28.50	295.00
Diffuser	14.00	90.31
Discharge plenum		
-Horizontal	36.00	232.66
-Vertical	42.50	306.29
Energy Wheel	55.00	911.00
Face-and-Bypass Dampers		
-Face-and-bypass	19.00	178.68
-External face-and-bypass	19.00	219.68
-Internal face-and-bypass or face damper only	19.00	203.43
Fan		
-Belt-drive plenum (BDP) fan with motor	42.50	875.00
-Housed fan FC with motor	42.50	721.69
-Housed AF/BC fans with motor	42.50	849.71
-Direct-drive plenum fan with motor	46.75	795.54

Table 30. Section dimensions (inches) and weights (pounds) - unit size 10

Filters	Length (in.)	Weight (lb.)
-Side load 2-in. angled	26.50	225.96
-Side load 4-in. angled	26.50	247.16
-Side load cartridge 12-in. or short bag 18-in.	26.50	234.88
-Side load 2-in. flat	14.00	117.74
-Side load 4-in. flat	14.00	143.40
-Side load 2-in. and 4-in. combination flat	19.00	174.73
-Long bag 30-in.	42.50	289.00
-Front-load HEPA	40.00	408.00
-Front-load cartridge	40.00	341.00
-Front-load short bag	45.00	335.00
Gas heat		
- 200 MBH	59.00	852.50
- 300 MBH	n/a	n/a
- 360 MBH	77.00	1093.20
Humidifier		
-Building Steam	14.00	226.00
-Atmospheric	14.00	252.00
Mixing box		
-with angled filters	36.00	235.01
-with front/back Traq and top Traq dampers	42.50	356.08
- reduced length mixing box with side/top/back/bottom airfoil damper	23.40	231.60
Multizone		
- 3-deck vertical discharge	66.00	1671.00
- 2-deck vertical discharge	66.00	1099.00
- 3-deck horizontal discharge	52.00	1511.00
- 2-deck horizontal discharge	52.00	982.00
Silencer		
-3 feet	38.00	359.00
-5 feet	62.00	541.00
Trane Catalytic Air Cleaning System (TCACS)	36.00	470.00
UV light	14.00	135.22
SECTIONS BELOW ARE FOR OUTDOOR UNITS ONLY		
Diagonal economizer		
-with airfoil dampers	53.00	334.00
-with airfoil damper and one side Traq damper	53.00	349.00
Exhaust damper section	19.00	159.60
Hoods		
- Back inlet hood - airfoil and Traq	61.50	52.00
- Side inlet hood - airfoil and Traq	22.88	31.00
- Exhaust hood - airfoil	22.88	21.00
- Economizer inlet hood	53.00	68.00
Pipe Cabinets		
15 in. long - 24-in. depth	15.00	89.00
15 in. long - 36-in. depth	15.00	120.00
15 in. long - 48-in. depth	15.00	152.00



General Data

Table 30. Section dimensions (inches) and weights (pounds) - unit size 10

Pipe Cabinets	Length (in.)	Weight (lb.)
24 in. long - 24-in. depth	24.00	105.00
24 in. long - 36-in. depth	24.00	140.00
24 in. long - 48-in. depth	24.00	174.00
48 in. long - 24-in. depth	48.00	148.00
48 in. long - 36-in. depth	48.00	191.00
48 in. long - 48-in. depth	48.00	234.00
96 in. long - 24-in. depth	96.00	233.00
96 in. long - 36-in. depth	96.00	293.00
96 in. long - 48-in. depth	96.00	352.00

Table 31. Filter data for unit size 10

Filter Type	Area ft ²	Qty–Size (in.)
Flat (2-in., 4-in., and 2-in/4-in high efficiency) pleated, permanent, throwaway media	9.72	2 - 20x25 1 - 16x25
Angled (2-in. or 4-in.) pleated, permanent, throwaway media	13.89	4 - 25x20
Side load bag or cartridge	8.67	2 - 24x20 1 - 24x12
Front load bag or cartridge	8.00	2 - 24x24
Front load HEPA	9.00	1 - 24x30 1 - 24x24

Note: 2-inch filters available in permanent, throwaway, or pleated media; 4-inch filters available in pleated media, 65%, 85%, or 95% efficiency; Bag or cartridge filters available in 65%, 85%, or 95% efficiency.

Table 32. Coil availability-size 10

Section Type	5/8-in Unit Coils,	
	1/2-in Unit Coils	1/2-in and 5/8-in Modified Coils
Small	2-4 rows	1 - 2 rows
Medium	2-8 rows	1-4 rows
Extended-medium	2-8 rows	1-8 rows
Medium-large	2-8 rows	1-10 rows
-with access	2-6 rows	1-3 rows
Large horizontal	2-8 rows	1-10 rows
-with access	2-8 rows	1-6 rows
Large vertical	2-8 rows	1-6 rows
-with access	2-8 rows	1-6 rows

Table 33. Coil data for unit size 10

Coil Type	Rows	Fin Type	Area ft ²	Qty–Size (in.)
1/2-inch unit coils				
-UA, UW, UF	1, 2, 4, 6, 8	Aluminum	9.98	1-28.75 x 50
5/8-inch unit coils				
-W, WD, 5A, 5W, D1, D2	1, 2, 3, 4, 6, 8, 10	Aluminum or Copper	9.19	1-27 x 49
-TT, P2, P4, P8	1, 2, 4, 6, 8	Aluminum or Copper	8.17	1-24 x 49
1-inch unit coil				
-NS	1	Aluminum or Copper	8.17	1-24 x 49

Table 33. Coil data for unit size 10

Coil Type	Rows	Fin Type	Area ft ²	Qty-Size (in.)
1/2-inch modified coils				
-WL, LL, FD	2, 4, 6, 8	Aluminum	6.38	1-18.75 x 49
5/8-inch modified coils				
-W, 5A, 5W, WD, D1, D2, TT, P2, P4, P8	1, 2, 3, 4, 6, 8, 10	Aluminum or Copper	6.13	1-18 x 49
1-inch modified coil				
-NS	1	Aluminum or Copper	6.13	1-18 x 49
Multizone coils				
-5A, 5W, NS, TT	1, 2	Aluminium or Copper	6.13	1-18 x 49
-WL	2	Aluminum	6.13	1-18 x 49

Table 34. Fan data for unit size 10

Size/Type Fan name	Housed Fans - Low Pressure					
	15-in. FC 15FA	12-in. FC 12FA	10-in. FC 10FA	15-in. AF 15AA	12-in. AF 12AA	10-in. BC 10BA
Max rpm	1600	1900	2100	2900	3700	4070
ODP NEMA Premium motor hp range	1-7.5	1-5	1-5	1-10	1-7.5	1-3
Outlet area (ft ²)	2.05	1.46	1.03	2.05	1.46	1.03
Bearing/Shaft size (in.)	1.00	1.00	0.75	1.19	1.00	0.75
Size/Type Fan name	Housed Fans - High Pressure					
	15-in. FC 15FB	12-in. FC 12FB	10-in. FC 10FB	15-in. AF 15AB	12-in. AF 12AB	10-in. BC 10BB
Max rpm	1720	2115	2525	3500	4350	4650
ODP NEMA Premium motor hp range	1-10	1-10	1-7.5	1-15	1-10	1-5
Outlet area (ft ²)	2.05	1.46	1.03	2.05	1.46	1.03
Bearing/Shaft size (in.)	1.19	1.19	0.75	1.44	1.44	1.00
Size/Type Fan name	Belt-drive Plenum Fans				Direct-Drive Plenum Fans	
	Low Pressure		High Pressure		High Pressure	
	18-in. AF 18PA	16-in. AF 16PA	18-in. AF 18PB	16-in. AF 16PB	20-in. AF Reduced Width 20NR	20-in. AF Nominal Width 20NF
Max rpm	3000	3300	3300	3700	2771	2771
ODP NEMA Premium motor hp range	1-10	1-10	1-15	1-10	3-15	3-15
Outlet area (ft ²)	n/a	n/a	n/a	n/a	n/a	n/a
Bearing/Shaft size (in.)	1.19	1.19	1.50	1.34	n/a	n/a



General Data

Unit Size 12

Table 35. Section dimensions (inches) and weights (pounds) - unit sizes 12

Nominal airflow	6000	
Airflow at 625 fpm	8331	
Height - indoor unit (in.)	41.50	
Width (in.)	66.50	
Height - outdoor unit (in.) includes base drip lip	49.25	
Weight add for outdoor unit (lbs./in. of unit length)	2.40	
Section type	Length (in.)	Weight (lb.)
Access or blank		
-Small horizontal	10.00	80.55
-Medium horizontal	14.00	99.61
-Extended-medium horizontal	19.00	123.43
-Medium-large horizontal	26.50	159.18
-Large horizontal or turning	36.00	257.70
-Extra-large horizontal or turning	42.50	288.68
-Ducted inlet or ducted outlet section	10.00	80.50
Blender	36.00	264.12
Cool Dry Quiet (CDQ) Desiccant Dehumidification Section	58.00	1165.00
Coils		
-Small horizontal (with 4-row UW)	10.00	285.13
-Medium horizontal (with 8-row UW)	14.00	450.07
-Extended-medium horizontal (with 8-row UW)	19.00	476.00
-Medium-large horizontal (with 10-row W)	26.50	777.26
-Large horizontal or vertical (with 10-row W)	36.00	826.53
-Electric Heat Coil	42.50	622.00
-Integral-face-and-bypass (IFB) coil		
--Less than 4 rows	26.50	585.86
--4 rows	43.00	901.70
Controls section (includes largest available VFD)	28.50	315.00
Diffuser	14.00	97.26
Discharge plenum		
-Horizontal	36.00	255.35
-Vertical	42.50	339.58
Energy Wheel	58.00	1085.00
Face-and-Bypass Dampers		
-Face-and-bypass	19.00	199.15
-External face-and-bypass	19.00	241.45
-Internal face-and-bypass or face damper only	19.00	227.60
Fan		
-Belt-drive plenum (BDP) fan with motor	42.50	951.91
-Housed fan FC with motor	42.50	882.15
-Housed AF/BC fans with motor	42.50	920.08
-Direct-drive plenum fan with motor	48.50	912.52

Table 35. Section dimensions (inches) and weights (pounds) - unit sizes 12

Filters	Length (in.)	Weight (lb.)
-Side load 2-in. angled	26.50	251.82
-Side load 4-in. angled	26.50	254.22
-Side load cartridge 12-in. or short bag 18-in.	26.50	284.12
-Side load 2-in. flat	14.00	133.81
-Side load 4-in. flat	14.00	142.66
-Side load 2-in. and 4-in. combination flat	19.00	185.69
-Long bag 30-in.	42.50	331.00
-Front-load HEPA	40.00	440.00
-Front-load cartridge	40.00	386.00
-Front-load short bag	45.00	370.00
Gas heat		
- 200 MBH	57.00	912.60
- 300 MBH	n/a	n/a
- 360 MBH	73.00	1131.40
- 560 MBH	n/a	n/a
Humidifier		
-Building Steam	14.00	269.00
-Atmospheric	14.00	276.00
Mixing box		
-with angled filters	36.00	257.70
-with front/back Traq and top Traq dampers	42.50	396.49
- reduced length mixing box with side/top/back/bottom airfoil damper	23.40	257.60
Multizone		
- 3-deck vertical discharge	71.00	1899.00
- 2-deck vertical discharge	71.00	1266.00
- 3-deck horizontal discharge	57.00	1729.00
- 2-deck horizontal discharge	57.00	1145.00
Silencer		
-3 feet	38.00	442.00
-5 feet	62.00	678.00
Trane Catalytic Air Cleaning System (TCACS)	36.00	498.00
UV light	14.00	146.68
SECTIONS BELOW ARE FOR OUTDOOR UNITS ONLY		
Diagonal economizer		
-with airfoil dampers	53.00	365.00
-with airfoil damper and one side Traq damper	53.00	378.00
Exhaust damper section	19.00	176.70
Hoods		
- Back inlet hood - airfoil and Traq	66.38	69.00
- Side inlet hood - airfoil and Traq	22.88	42.00
- Exhaust hood - airfoil	22.88	29.00
- Economizer inlet hood	53.00	76.00



General Data

Table 35. Section dimensions (inches) and weights (pounds) - unit sizes 12

Pipe Cabinets	Length (in.)	Weight (lb.)
15 in. long - 24-in. depth	15.00	94.00
15 in. long - 36-in. depth	15.00	127.00
15 in. long - 48-in. depth	15.00	161.00
24 in. long - 24-in. depth	24.00	111.00
24 in. long - 36-in. depth	24.00	147.00
24 in. long - 48-in. depth	24.00	184.00
48 in. long - 24-in. depth	48.00	155.00
48 in. long - 36-in. depth	48.00	200.00
48 in. long - 48-in. depth	48.00	245.00
96 in. long - 24-in. depth	96.00	244.00
96 in. long - 36-in. depth	96.00	305.00
96 in. long - 48-in. depth	96.00	367.00

Table 36. Filter data for unit size 12

Filter Type	Area ft ²	Qty-Size (in.)
Flat (2-in., 4-in., and 2-in/4-in high efficiency) pleated, permanent, throwaway media	13.33	3 - 16x20 3 - 16x20
Angled (2-in. or 4-in.) pleated, permanent, throwaway media	16.67	6 - 20x20
Side load bag or cartridge	12.33	3 - 20x20 2 - 12x24
Front load bag or cartridge	10.00	1 - 12x24 2 - 24x24
Front load HEPA	10.00	2 - 30x24

Table 37. Coil availability - size 12

Section Type	1/2-in Unit Coils	5/8-in Unit Coils, 1/2-in and 5/8-in Modified Coils
Small	2-4 rows	1-2 rows
Medium	2-8 rows	1-4 rows
Extended-medium	2-8 rows	1-8 rows
Medium-large	2-8 rows	1-10 rows
-with access	2-6 rows	1-3 rows
Large horizontal	2-8 rows	1-10 rows
-with access	2-8 rows	1-6 rows
Large vertical	2-8 rows	1-6 rows
-with access	2-8 rows	1-6 rows

Table 38. Coil data for unit size 12

Coil Type	Rows	Fin Type	Area ft ²	Qty–Size (in.)
1/2-inch unit coils				
-UA, UW, UF, UU	1, 2, 4, 6, 8	Aluminum	12.30	1–32.50 x 54.50
5/8-inch unit coils				
-W, WD, D1, D2	4, 6, 8, 10	Aluminum or Copper	11.81	1–31.50 x 54
-W, 5A, 5W, D1, TT, P2, P4, P8	1, 2, 3, 4, 6, 8	Aluminum or Copper	11.25	1 - 30 x 54
1-inch unit coil				
-NS	1	Aluminum or Copper	11.25	1–30 x 54
1/2-inch modified coils				
-WL, LL, FD	2, 4, 6, 8	Aluminum	9.38	1-25 x 54
5/8-inch modified coils				
-W, WD, 5A, 5W, D1, D2, TT, P2, P4, P8	1, 2, 3, 4, 6, 8, 10	Aluminum or Copper	9.00	1–24 x 54
1-inch modified coil				
-NS	1	Aluminum or Copper	9.00	1–24 x 54
Multizone coils				
-5A, 5W, NS, TT	1, 2	Aluminium or Copper	6.75	1-18 x 54
-WL	2	Aluminum	6.75	1-18 x 54

Table 39. Fan data for unit size 12

Size/Type Fan name	Housed Fans - Low Pressure					
	18-in FC 18FA	15-in FC 15FA	12-in FC 12FA	18-in AF 18AA	15-in AF 15AA	12-in AF 12AA
Max rpm	1215	1600	1900	2450	2900	3700
ODP NEMA Premium motor hp range	1-7.5	1-7.5	1-5	1-10	1-10	1-7.5
Outlet area (ft ²)	2.88	2.05	1.46	2.88	2.05	1.46
Bearing/Shaft size (in.)	1.00	1.00	1.00	1.19	1.19	1.00
Size/Type Fan name	Housed Fans - High Pressure					
	18-in FC 18FB	15-in FC 15FB	12-in FC 12FB	18-in AF 18AB	15-in AF 15AB	12-in AF 12AB
Max rpm	1500	1720	2115	3100	3500	4350
ODP NEMA Premium motor hp range	1-15	1-10	1-10	1-15	1-15	1-10
Outlet area (ft ²)	2.88	2.05	1.46	2.88	2.05	1.46
Bearing/Shaft size (in.)	1.44	1.19	1.19	1.50	1.44	1.44
Size/Type Fan name	Belt-drive Plenum Fans				Direct-Drive Plenum Fans	
	Low Pressure		High Pressure		High Pressure	
	20-in AF 20PA	18-in AF 18PA	20-in AF 20PB	18-in AF 18PB	22-in. AF Reduced Width 22NR	22-in. AF Nominal Width 22NF
Max rpm	2650	3000	2850	3300	2454	2454
ODP NEMA Premium motor hp range	1-15	1-10	1-15	1-15	3-15	5-20
Outlet area (ft ²)	n/a	n/a	n/a	n/a	n/a	n/a
Bearing/Shaft size (in.)	1.50	1.19	1.69	1.50	n/a	n/a



General Data

Unit Size 14

Table 40. Section dimensions (inches) and weights (pounds) - unit size 14

Nominal airflow	7000	
Airflow at 625 fpm	9025	
Height - indoor unit (in.)	41.50	
Width (in.)	72.00	
Height - outdoor unit (in.) includes base drip lip	49.25	
Weight add for outdoor unit (lbs./in. of unit length)	2.51	
Section type	Length (in.)	Weight (lb.)
Access or blank		
-Small horizontal	10.00	84.67
-Medium horizontal	14.00	104.57
-Extended-medium horizontal	19.00	129.44
-Medium-large horizontal	26.50	166.74
-Large horizontal or turning	36.00	271.35
-Extra-large horizontal or turning	42.50	303.68
-Ducted inlet or ducted outlet section	10.00	84.70
Blender	36.00	276.73
Cool Dry Quiet (CDQ) Desiccant Dehumidification Section	58.00	1326.00
Coils		
-Small horizontal (with 4-row UW)	10.00	307.44
-Medium horizontal (with 8-row UW)	14.00	488.32
-Extended-medium horizontal (with 8-row UW)	19.00	516.35
-Medium-large horizontal (with 10-row W)	26.50	884.93
-Large horizontal or vertical (with 10-row W)	36.00	938.18
-Electric Heat Coil	42.50	666.00
-Integral-face-and-bypass (IFB) coil		
--Less than 4 rows	26.50	619.66
--4 rows	43.00	950.23
Controls section (includes largest available VFD)	28.50	327.00
Diffuser	14.00	102.22
Discharge plenum		
-Horizontal	36.00	269.00
-Vertical	42.50	358.68
Energy Wheel	58.00	1208.00
Face-and-Bypass Dampers		
-Face-and-bypass	19.00	209.53
-External face-and-bypass	19.00	255.80
-Internal face-and-bypass or face damper only	19.00	241.91
Fan		
-Belt-drive plenum (BDP) fan with motor	42.50	1069.39
-Housed fan FC with motor	42.50	904.21
-Housed AF/BC fans with motor	42.50	942.14
-Direct-drive plenum fan with motor	48.50	936.26

Table 40. Section dimensions (inches) and weights (pounds) - unit size 14

Filters	Length (in.)	Weight (lb.)
-Side load 2-in. angled	26.50	265.94
-Side load 4-in. angled	26.50	273.54
-Side load cartridge 12-in. or short bag 18-in.	26.50	303.60
-Side load 2-in. flat	14.00	141.07
-Side load 4-in. flat	14.00	154.67
-Side load 2-in. and 4-in. combination flat	19.00	201.97
-Long bag 30-in.	42.50	349.00
-Front-load HEPA	40.00	453.00
-Front-load cartridge	40.00	399.00
-Front-load short bag	45.00	384.00
Gas heat		
- 200 MBH	57.00	937.10
- 300 MBH	n/a	n/a
- 360 MBH	68.00	1127.90
- 560 MBH	n/a	n/a
Humidifier		
-Building Steam	14.00	286.00
-Atmospheric	14.00	312.00
Mixing box		
-with angled filters	36.00	271.35
-with front/back Traq and top Traq dampers	42.50	418.78
- reduced length mixing box with side/top/back/bottom airfoil damper	28.40	298.40
Multizone		
- 3-deck vertical discharge	71.00	2063.00
- 2-deck vertical discharge	71.00	1380.00
- 3-deck horizontal discharge	57.00	1892.00
- 2-deck horizontal discharge	57.00	1253.00
Silencer		
-3 feet	38.00	461.00
-5 feet	62.00	704.00
Trane Catalytic Air Cleaning System (TCACS)		
	36.00	514.00
UV light		
	14.00	155.07
SECTIONS BELOW ARE FOR OUTDOOR UNITS ONLY		
Diagonal economizer		
-with airfoil dampers	57.00	407.00
-with airfoil damper and one side Traq damper	57.00	426.00
Exhaust damper section		
	19.00	186.80
Hoods		
- Back inlet hood - airfoil and Traq	71.88	74.00
- Side inlet hood - airfoil and Traq	31.38	50.00
- Exhaust hood - airfoil	31.38	30.00
- Economizer inlet hood	56.50	137.00
Pipe Cabinets		
15 in. long - 24-in. depth	15.00	94.00
15 in. long - 36-in. depth	15.00	127.00
15 in. long - 48-in. depth	15.00	161.00



General Data

Table 40. Section dimensions (inches) and weights (pounds) - unit size 14

Pipe Cabinets	Length (in.)	Weight (lb.)
24 in. long - 24-in. depth	24.00	111.00
24 in. long - 36-in. depth	24.00	147.00
24 in. long - 48-in. depth	24.00	184.00
48 in. long - 24-in. depth	48.00	155.00
48 in. long - 36-in. depth	48.00	200.00
48 in. long - 48-in. depth	48.00	245.00
96 in. long - 24-in. depth	96.00	244.00
96 in. long - 36-in. depth	96.00	305.00
96 in. long - 48-in. depth	96.00	367.00

Table 41. Filter data for unit size 14

Filter Type	Area ft ²	Qty-Size (in.)
Flat (2-in., 4-in., and 2-in/4-in high efficiency) pleated, permanent, throwaway media	14.44	4 - 16x20
		2 - 16x25
Angled (2-in. or 4-in.) pleated, permanent, throwaway media	18.06	2 - 20x25
		4 - 20x20
Side load bag or cartridge	13.44	2 - 20x24
		1 - 20x20
Front load bag or cartridge	10.00	2 - 12x24
		1 - 12x24
Front load HEPA	10.00	2 - 24x24
Front load HEPA	10.00	2 - 30x24

Note: 2-inch filters available in permanent, throwaway, or pleated media; 4-inch filters available in pleated media, 65%, 85%, or 95% efficiency; Bag or cartridge filters available in 65%, 85%, or 95% efficiency.

Table 42. Coil availability - size 14

Section Type	5/8-in Unit Coils,	
	1/2-in Unit Coils	1/2-in and 5/8-in Modified Coils
Small	2-4 rows	1-2 rows
Medium	2-8 rows	1-4 rows
Extended-medium	2-8 rows	1-8 rows
Medium-large	2-8 rows	1-10 rows
-with access	2-6 rows	1-3 rows
Large horizontal	2-8 rows	1-10 rows
-with access	2-8 rows	1-6 rows
Large vertical	2-8 rows	1-6 rows
-with access	2-8 rows	1-6 rows

Table 43. Coil data for unit size 14

Coil Type	Rows	Fin Type	Area ft ²	Qty–Size (in.)
1/2-inch unit coils				
-UA, UW, UF, UU	1, 2, 4, 6, 8	Aluminum	13.65	1-32.50 x 60.50
5/8-inch unit coils				
-W, D1	4, 6, 8, 10	Aluminum or Copper	13.13	1-31.50 x 60
W, 5A, 5W, D1, TT, P2, P4, P8	1, 2, 3, 4, 6, 8	Aluminum or Copper	12.50	1-30 x 60
-WD, D2	6, 8, 10	Aluminum or Copper	12.91	1-31.50 x 59
1-inch unit coil				
-NS	1	Aluminum or Copper	12.50	1-30 x 60
1/2-inch modified coils				
-WL, LL, FD	2, 4, 6, 8	Aluminum	10.42	1-25 x 60
5/8-inch modified coils				
-W, 5A, 5W, D1, TT, P2, P4, P8	1, 2, 3, 4, 6, 8, 10	Aluminum or Copper	10.00	1-24 x 60
-WD, D2	6, 8, 10	Aluminum or Copper	9.83	1-24 x 59
-WD	6, 8	Copper	9.83	1-24 x 59
1-inch modified coil				
-NS	1	Aluminum or Copper	10.00	1-24 x 60
Multizone coils				
-5A, 5W, NS, TT	1, 2	Aluminium or Copper	7.50	1-18 x 60
-WL	2	Aluminum	7.50	1-18 x 60

Table 44. Fan data for unit size 14

Size/Type Fan name	Housed Fans - Low Pressure					
	18-in FC 18FA	15-in FC 15FA	12-in FC 12FA	18-in AF 18AA	15-in AF 15AA	12-in AF 12AA
Max rpm	1215	1600	1900	2450	2900	3700
ODP NEMA Premium motor hp range	1-7.5	1-7.5	1-5	1-10	1-7.5	1-7.5
Outlet area (ft ²)	2.88	2.05	1.46	2.88	2.05	1.46
Bearing/Shaft size (in.)	1.00	1.00	1.00	1.19	1.19	1.00
Size/Type Fan name	Housed Fans - High Pressure					
	18-in FC 18FB	15-in FC 15FB	12-in FC 12FB	18-in AF 18AB	15-in AF 15AB	12-in AF 12AB
Max rpm	1500	1720	2115	3100	3500	4350
ODP NEMA Premium motor hp range	1-10	1-10	1-10	1-15	1-15	1-10
Outlet area (ft ²)	2.88	2.05	1.46	2.88	2.05	1.46
Bearing/Shaft size (in.)	1.44	1.19	1.19	1.50	1.44	1.44
Size/Type Fan name	Belt-drive Plenum Fans				Direct-Drive Plenum Fans	
	Low Pressure		High Pressure		High Pressure	
	22-in AF 22PA	20-in AF 20PA	22-in AF 22PB	20-in AF 20PB	22-in. AF Nominal Width 22NF	22-in. AF Extended Width 22NW
Max rpm	2320	2650	2650	2850	2454	2454
ODP NEMA Premium motor hp range	1-15	1-15	1-20	1-20	5-20	5-20
Outlet area (ft ²)	n/a	n/a	n/a	n/a	n/a	n/a
Bearing/Shaft size (in.)	1.50	1.50	1.69	1.69	n/a	n/a



General Data

Unit Size 17

Table 45. Section dimensions (inches) and weights (pounds) - unit size 17

Nominal airflow	8500	
Airflow at 625 fpm	11,806	
Height - indoor unit (in.)	49.00	
Width (in.)	72.00	
Height - outdoor unit (in.) includes base drip lip	56.75	
Weight add for outdoor unit (lbs./in. of unit length)	2.51	
Section type	Length (in.)	Weight (lb.)
Access or blank		
-Small horizontal	10.00	88.41
-Medium horizontal	14.00	109.45
-Extended-medium horizontal	19.00	135.74
-Medium-large horizontal	24.50	164.66
-Large horizontal or turning	36.00	293.42
-Extra-large horizontal or turning	44.00	335.49
-Ducted inlet or ducted outlet section	10.00	88.40
Blender	36.00	303.71
Cool Dry Quiet (CDQ) Desiccant Dehumidification Section	58.00	1390.00
Coils		
-Small horizontal (with 4-row UW)	10.00	352.47
-Medium horizontal (with 8-row UW)	14.00	569.79
-Extended-medium horizontal (with 8-row UW)	19.00	599.24
-Medium-large horizontal (with 10-row W)	24.50	1013.57
-Large horizontal or vertical (with 10-row W)	36.00	1081.30
-Electric Heat Coil	44.00	731.00
-Integral-face-and-bypass (IFB) coil		
--Less than 4 rows	26.50	733.14
--4 rows	43.00	1131.90
Controls section (includes largest available VFD)	28.50	350.00
Diffuser	14.00	107.10
Discharge plenum		
-Horizontal	36.00	291.07
-Vertical	44.00	401.43
Energy Wheel	58.00	1269.00
Face-and-Bypass Dampers		
-Face-and-bypass	19.00	224.50
-External face-and-bypass	19.00	270.77
-Internal face-and-bypass or face damper only	19.00	255.18
Fan		
-Belt-drive plenum (BDP) fan with motor	44.00	1239.89
-Housed fan FC with motor	44.00	1054.64
-Housed AF/BC fans with motor	44.00	1098.21
-Direct-drive plenum fan with motor	50.00	991.99
Filters		
-Side load 2-in. angled	24.50	314.12
-Side load 4-in. angled	24.50	352.07
-Side load cartridge 12-in. or short bag 18-in.	24.50	335.02

Table 45. Section dimensions (inches) and weights (pounds) - unit size 17

Filters	Length (in.)	Weight (lb.)
-Side load 2-in. flat	14.00	148.02
-Side load 4-in. flat	14.00	202.82
-Side load 2-in. and 4-in. combination flat	19.00	252.57
-Long bag 30-in.	44.00	383.00
-Front-load HEPA	40.00	569.00
-Front-load cartridge	40.00	470.00
-Front-load short bag	45.00	432.00
Gas heat		
- 200 MBH	60.00	1011.80
- 300 MBH	n/a	n/a
- 360 MBH	71.00	1211.10
- 560 MBH	71.00	1192.00
Humidifier		
-Building Steam	14.00	324.00
-Atmospheric	14.00	339.00
Mixing box		
-with angled filters	36.00	293.42
-with front/back Traq and top Traq dampers	44.00	463.57
- reduced length mixing box with side/top/back/bottom airfoil damper	28.40	328.40
Multizone		
- 3-deck vertical discharge	71.00	2211.00
- 2-deck vertical discharge	71.00	1526.00
- 3-deck horizontal discharge	57.00	2034.00
- 2-deck horizontal discharge	57.00	1396.00
Silencer		
-3 feet	38.00	512.00
-5 feet	62.00	780.00
Trane Catalytic Air Cleaning System (TCACS)	36.00	544.00
UV light	14.00	162.95
SECTIONS BELOW ARE FOR OUTDOOR UNITS ONLY		
Diagonal economizer		
-with airfoil dampers	52.00	414.00
-with airfoil damper and one side Traq damper	52.00	431.00
Exhaust damper section	19.00	204.00
Hoods		
- Back inlet hood - airfoil and Traq	72.00	74.00
- Side inlet hood - airfoil and Traq	25.75	50.00
- Exhaust hood - airfoil	25.75	30.00
- Economizer inlet hood	52.00	174.00
Pipe Cabinets		
15 in. long - 24-in. depth	15.00	105.00
15 in. long - 36-in. depth	15.00	141.00
15 in. long - 48-in. depth	15.00	178.00
Pipe Cabinets		
24 in. long - 24-in. depth	24.00	122.00
24 in. long - 36-in. depth	24.00	162.00
24 in. long - 48-in. depth	24.00	202.00

General Data

Table 45. Section dimensions (inches) and weights (pounds) - unit size 17

Pipe Cabinets	Length (in.)	Weight (lb.)
48 in. long - 24-in. depth	48.00	170.00
48 in. long - 36-in. depth	48.00	218.00
48 in. long - 48-in. depth	48.00	267.00
96 in. long - 24-in. depth	96.00	266.00
96 in. long - 36-in. depth	96.00	331.00
96 in. long - 48-in. depth	96.00	396.00

Table 46. Filter data for unit size 17

Filter Type	Area ft ²	Qty-Size (in.)
Flat (2-in., 4-in., and 2-in/4-in high efficiency) pleated, permanent, throwaway media	18.89	4 - 20x24 2 - 20x20
Angled (2-in. or 4-in.) Pleated, permanent, throwaway media	28.89	4 - 16x25 8 - 16x20
Side load bag or cartridge	18.89	4 - 20x24 2 - 20x20
Front load bag or cartridge	14.00	3 - 12x24 2 - 24x24
Front load HEPA	14.00	2 - 24x30 2 - 12x24

Note: 2-inch filters available in permanent, throwaway, or pleated media; 4-inch filters available in pleated media, 65%, 85%, or 95% efficiency; Bag or cartridge filters available in 65%, 85%, or 95% efficiency.

Table 47. Coil availability - size 17

Section Type	1/2-in Unit Coils	5/8-in Unit Coils, 1/2-in and 5/8-in, Modified Coils
Small	2-4 rows	1-2 rows
Medium	2-8 rows	1-4 rows
Extended-medium	2-8 rows	1-8 rows
Medium-large	2-8 rows	1-10 rows
-with access	2-6 rows	1-3 rows
Large horizontal	2-8 rows	1-10 rows
-with access	2-8 rows	1-6 rows
Large vertical	2-8 rows	1-6 rows
-with access	2-8 rows	1-6 rows

Table 48. Coil data for unit size 17

Coil Type	Rows	Fin Type	Area ft ²	Qty-Size (in.)
1/2-inch unit coils				
-UA, UW, UF, UU	1, 2, 4, 6, 8	Aluminum	16.81	1-40 × 60.50
5/8-inch unit coils				
-D1	4, 6, 8	Aluminum or Copper	15.63	1-37.50 × 60
-W, D1	4, 6, 8, 10	Aluminum	15.63	1-37.50 × 60
-W, D1	4, 6, 8	Copper	15.63	1-37.50 × 60
-WD, D2	6, 8	Aluminum or Copper	15.36	1-37.50 × 59
-WD, D2	10	Aluminum	15.36	1-37.50 × 59
-WD, D2	8	Copper	15.36	1-37.50 × 59
-W, 5A, 5W, D1	1, 2, 3	Aluminum or Copper	15.00	1-36 × 60
-TT	2	Aluminum or Copper	13.75	1-33 × 60
1-inch unit coil				
-NS	1	Aluminum or Copper	13.75	1-33 × 60

Table 48. Coil data for unit size 17

Coil Type	Rows	Fin Type	Area ft ²	Qty-Size (in.)
1/2-inch modified coils				
-WL, LL, FD	2, 4, 6, 8	Aluminum	13.02	1-31.25 x 60
5/8-inch modified coils				
-W, 5A, 5W, D1, TT, P2, P4, P8	1, 2, 3, 4, 6, 8, 10	Aluminum or Copper	12.50	1-30 x 60
-WD, D2	6, 8, 10	Aluminum or Copper	12.29	1-30 X 59
1-inch modified coil				
-NS	1	Aluminum or Copper	12.50	1-30 x 60
Multizone coils				
-5A, 5W, NS, TT	1, 2	Aluminium or Copper	7.50	1-18 x 60
-WL	2	Aluminum	7.50	1-18 x 60

Table 49. Fan data for unit size 17

Size/Type Fan name	Housed Fans - Low Pressure					
	20-in FC 20FA	18-in FC 18FA	15-in FC 15FA	20-in AF 20AA	18-in AF 18AA	15-in AF 15AA
Max rpm	1050	1215	1600	2300	2450	2900
ODP NEMA Premium motor hp range	1.5-20	1.5-7.5	1.5-7.5	1.5-15	1.5-10	1.5-10
Outlet area (ft ²)	4.38	2.88	2.05	4.38	2.88	2.05
Bearing/Shaft size (in.)	1.50	1.00	1.00	1.50	1.19	1.19
Size/Type Fan name	Housed Fans - High Pressure					
	20-in FC 20FB	18-in FC 18FB	15-in FC 15FB	20-in AF 20AB	18-in AF 18AB	15-in AF 15AB
Max rpm	1330	1500	1720	2750	3100	3500
ODP NEMA Premium motor hp range	1.5-20	1.5-15	1.5-10	1.5-20	1.5-20	1.5-15
Outlet area (ft ²)	4.38	2.88	2.05	4.38	2.88	2.05
Bearing/Shaft size (in.)	1.69	1.44	1.188	1.69	1.50	1.44
Size/Type Fan name	Belt - Drive Plenum Fans				Direct - Drive Plenum Fans	
	Low Pressure		High Pressure		High Pressure	
	25-in AF 25PA	22-in AF 22PA	25-in AF 25PB	22-in AF 22PB	24.5-in. AF Reduced Width 24NR	24.5-in. AF Nominal Width 24NF
Max rpm	2070	2320	2350	2650	2269	2269
ODP NEMA Premium motor hp range	1.5-20	1.5-15	1.5-25	1.5-20	5-20	5-20
Outlet area (ft ²)	n/a	n/a	n/a	n/a	n/a	n/a
Bearing/Shaft size (in.)	1.69	1.50	1.69	1.69	n/a	n/a



General Data

Unit Size 21

Table 50. Section dimensions (inches) and weights (pounds) - unit sizes 21

Nominal airflow	10,500	
Airflow at 625 fpm	13,456	
Height - indoor unit (in.)	52.75	
Width (in.)	80.00	
Height - outdoor unit (in.) includes base drip lip	60.50	
Weight add for outdoor unit (lbs./in. of unit length)	2.68	
Section type	Length (in.)	Weight (lb.)
Access or blank		
-Small horizontal	10.00	96.28
-Medium horizontal	14.00	119.10
-Extended-medium horizontal	19.00	147.62
-Medium-large horizontal	24.50	178.99
-Large horizontal or turning	34.00	314.60
-Extra-large horizontal or turning	50.25	407.29
-Ducted inlet or ducted outlet section	10.00	96.30
Blender	34.00	323.59
Cool Dry Quiet (CDQ) Desiccant Dehumidification Section	56.00	1793.00
Coils		
-Small horizontal (with 4-row UW)	10.00	433.37
-Medium horizontal (with 8-row UW)	14.00	700.27
-Extended-medium horizontal (with 8-row UW)	19.00	737.96
-Medium-large horizontal (with 10-row W)	24.50	1262.10
-Large horizontal or vertical (with 10-row W)	34.00	1333.70
-Electric Heat Coil	50.30	876.00
-Integral-face-and-bypass (IFB) coil		
--Less than 4 rows	26.50	792.88
--4 rows	43.00	1216.48
Controls section (includes largest available VFD)	28.50	428.00
Diffuser	14.00	116.75
Discharge plenum		
-Horizontal	34.00	312.25
-Vertical	50.25	486.37
Energy Wheel	56.00	1484.00
Face-and-Bypass Dampers		
-Face-and-bypass	19.00	248.05
-External face-and-bypass	19.00	300.08
-Internal face-and-bypass or face damper only	19.00	291.55
Fan		
-Belt-drive plenum (BDP) fan with motor	50.25	1443.26
-Housed fan FC with motor	50.25	1329.38
-Housed AF/BC fans with motor	50.25	1432.10
-Direct-drive plenum fan with motor	50.25	1380.92
Filters		
-Side load 2-in. angled	24.50	347.50
-Side load 4-in. angled	24.50	379.13
-Side load cartridge 12-in. or short bag 18-in.	24.50	365.40

Table 50. Section dimensions (inches) and weights (pounds) - unit sizes 21

Filters	Length (in.)	Weight (lb.)
-Side load 2-in. flat	14.00	165.52
-Side load 4-in. flat	14.00	213.64
-Side load 2-in. and 4-in. combination flat	19.00	268.17
-Long bag 30-in.	50.25	462.00
-Front-load HEPA	40.00	692.00
-Front-load cartridge	40.00	526.00
-Front-load short bag	45.00	474.00
Gas heat		
- 200 MBH	60.00	1074.90
- 300 MBH	n/a	n/a
- 360 MBH	69.00	1264.50
- 560 MBH	69.00	1246.60
- 700 MBH	75.00	1503.40
- 860 MBH	81.00	1606.40
- 1000 MBH	87.00	1364.20
- 1250-1750 MBH	87.00	1364.20
Humidifier		
-Building Steam	14.00	354.00
-Atmospheric	14.00	396.00
Mixing box		
-with angled filters	34.00	314.60
-with front/back Traq and top Traq dampers	50.25	555.65
- reduced length mixing box with side/top/back/bottom airfoil damper	28.40	370.10
Multizone		
- 3-deck vertical discharge	82.00	2757.00
- 2-deck vertical discharge	82.00	1882.00
- 3-deck horizontal discharge	72.00	2603.00
- 2-deck horizontal discharge	72.00	1755.00
Silencer		
-3 feet	38.00	573.00
-5 feet	62.00	873.00
Trane Catalytic Air Cleaning System (TCACS)	36.00	599.00
UV light	14.00	1779.84
SECTIONS BELOW ARE FOR OUTDOOR UNITS ONLY		
Diagonal economizer		
-with airfoil dampers	63.00	534.00
-with airfoil damper and one side Traq damper	63.00	555.00
Exhaust damper section	19.00	229.10
Hoods		
- Back inlet hood - airfoil and Traq	79.88	74.00
- Side inlet hood - airfoil and Traq	29.13	50.00
- Exhaust hood - airfoil	29.13	30.00
- Economizer inlet hood	62.50	179.00
Pipe Cabinets		
15 in. long - 24-in. depth	15.00	110.00
15 in. long - 36-in. depth	15.00	148.00
15 in. long - 48-in. depth	15.00	187.00



General Data

Table 50. Section dimensions (inches) and weights (pounds) - unit sizes 21

Pipe Cabinets	Length (in.)	Weight (lb.)
24 in. long - 24-in. depth	24.00	128.00
24 in. long - 36-in. depth	24.00	170.00
24 in. long - 48-in. depth	24.00	211.00
48 in. long - 24-in. depth	48.00	178.00
48 in. long - 36-in. depth	48.00	228.00
48 in. long - 48-in. depth	48.00	278.00
96 in. long - 24-in. depth	96.00	277.00
96 in. long - 36-in. depth	96.00	343.00
96 in. long - 48-in. depth	96.00	410.00

Table 51. Filter data for unit size 21

Filter Type	Area ft ²	Qty-Size (in.)
Flat (2-in., 4-in., and 2-in/4-in high efficiency) pleated, permanent, throwaway media	21.53	3 - 25x20
		1 - 25x16
		3 - 16x25
Angled (2-in. or 4-in.) Pleated, permanent, throwaway media	33.33	12 - 25x16
Side load bag or cartridge	22.00	3 - 24x24
		3 - 20x24
Front load bag or cartridge	18.00	3 - 12x24
		3 - 24x24
Front load HEPA	21.00	3 - 30x24
		3 - 12x24

Note: 2-inch filters available in permanent, throwaway, or pleated media; 4-inch filters available in pleated media, 65%, 85%, or 95% efficiency; Bag or cartridge filters available in 65%, 85%, or 95% efficiency.

Table 52. Coil availability - size 21

Section Type	5/8-in Unit Coils,	
	1/2-in Unit Coils	1/2-in and 5/8-in Modified Coils
Small	2-4 rows	1-2 rows
Medium	2-8 rows	1-4 rows
Extended-medium	2-8 rows	1-8 ¹ rows
Medium-large	2-8 rows	1-10 rows
-with access	2-6 rows	1-4 rows
Large horizontal	2-8 rows	1-10 rows
-with access	2-8 rows	1-6 rows
Large vertical	2-8 rows	1-6 rows
-with access	2-8 rows	1-4 rows

Note: ¹6-row maximum for stacked coils.

Table 53. Coil data for unit size 21

Coil Type	Rows	Fin Type	Area ft ²	Qty-Size (in.)
1/2-inch unit coils				
-UA, UW, UF, UU	1, 2, 4, 6, 8	Aluminum	20.81	1-43.75 x 68.50
5/8-inch unit coils				
-W, 5A, 5W, D1, D2	1, 2, 3, 4, 6, 8	Aluminum or Copper	19.83	1-42 x 68
-W, D1	4, 6, 8, 10	Aluminum	19.83	1-42 x 68
-W, WD, D1, D2	4, 6, 8	Copper	19.83	1-42 x 68
-WD, D2	6, 8	Aluminum or Copper	19.54	1-42 x 67
-D2, WD	10	Aluminum	19.54	1-42 x 67
-TT, P2, P4, P8 (stacked)	1, 2, 4, 6, 8	Aluminum or Copper	17.00	2-18 x 68

Table 53. Coil data for unit size 21

Coil Type	Rows	Fin Type	Area ft ²	Qty–Size (in.)
1-inch unit coil				
-NS (stacked)	1	Aluminum or Copper	17.00	2–18 x 68
1/2-inch modified coils				
-WL, LL, FD	2, 4, 6, 8	Aluminum	15.94	1-33.75 x 68
5/8-inch modified coils				
-W, 5A, 5W, D1, TT	1, 2, 3, 4, 6, 8, 10 ¹	Aluminum or Copper	15.58	1-33 x 68
-D2	6, 8, 10 ¹	Aluminum or Copper	15.35	1-33 x 67
-WD	6, 8, 10	Aluminum	15.35	1-33 x 67
-WD	6, 8	Copper	15.35	1-33 x 67
1-inch modified coil				
-NS	1	Aluminum or Copper	15.58	1-33 x 68
Multizone coils				
-5A, 5W, NS, TT	1, 2	Aluminium or Copper	11.33	1-24 x 68
-WL	2	Aluminum	11.33	1-24 x 68

Note: ¹Copper not available for 10 row

Table 54. Fan data for unit size 21

Size/Type Fan name	Housed Fans-Low Pressure					
	22-in FC 22FA	20-in FC 20FA	18-in FC 18FA	22-in AF 22AA	20-in AF 20AA	18-in AF 18AA
Max rpm	950	1050	1215	1900	2300	2450
ODP NEMA Premium motor hp range	2-20	2-20	2-7.5	2-15	2-15	2-10
Outlet area (ft ²)	5.54	4.38	2.88	5.54	4.38	2.88
Bearing/Shaft size (in.)	1.5	1.5	1	1.5	1.5	1.19
Size/Type Fan name	Housed Fans-High Pressure					
	22-in FC 22FB	20-in FC 20FB	18-in FC 18FB	22-in AF 22AB	20-in AF 20AB	18-in AF 18AB
Max rpm	1200	1330	1500	2500	2750	3100
ODP NEMA Premium motor hp range	2-20	2-20	2-15	2-25	2-25	2-20
Outlet area (ft ²)	5.54	4.38	2.88	5.54	4.38	2.88
Bearing/Shaft size (in.)	2.00	1.69	1.44	2.00	1.69	1.50
Size/Type Fan name	Belt-drive Plenum Fans				Direct-Drive Plenum Fans	
	Low Pressure		High Pressure		High Pressure	
	28-in AF 28PA	25-in AF 25PA	28-in AF 28PB	25-in AF 25PB	2-20-in AF 20NR	2-20-in AF 20NF
Max rpm	1850	2070	2100	2350	2771	2771
ODP NEMA Premium motor hp range	2-25	2-20	2-30	2-30	3-15	3-15
Outlet area (ft ²)	n/a	n/a	n/a	n/a	n/a	n/a
Bearing/Shaft size (in.)	2.00	1.69	1.69	1.69	n/a	n/a



General Data

Unit Size 22

Table 55. Section dimensions (inches) and weights (pounds) - unit size 22

Nominal airflow	11,000	
Airflow at 625 fpm	13,194	
Height - indoor unit (in.)	67.25	
Width (in.)	61.50	
Height - outdoor unit (in.) includes base drip lip	Available for indoor use only	
Weight add for outdoor unit (lbs./in. of unit length)	n/a	n/a
Section type	Length (in.)	Weight (lb.)
Access or blank		
-Small horizontal	10.00	89.63
-Medium horizontal	14.00	111.84
-Extended-medium horizontal	19.00	139.60
-Medium-large horizontal	26.50	170.14
-Large horizontal or turning	36.00	315.97
-Extra-large horizontal or turning	n/a	n/a
-Ducted inlet or ducted outlet section	10.00	89.60
Blender	30.50	300.15
Cool Dry Quiet (CDQ) Desiccant Dehumidification Section	n/a	n/a
Coils		
-Small horizontal (with 4-row UW)	10.00	433.22
-Medium horizontal (with 8-row UW)	14.00	690.67
-Extended-medium horizontal (with 8-row UW)	19.00	721.58
-Medium-large horizontal (with 10-row W)	26.50	1175.58
-Large horizontal or vertical (with 10-row W)	36.00	1234.32
-Electric Heat Coil	n/a	n/a
-Integral-face-and-bypass (IFB) coil		
--Less than 4 rows	26.50	858.31
--4 rows	43.00	1313.83
Controls section (includes largest available VFD)	28.50	419.00
Diffuser	14.00	109.49
Discharge plenum		
-Horizontal	36.00	313.62
-Vertical	n/a	n/a
Energy Wheel	n/a	n/a
Face-and-Bypass Dampers		
-Face-and-bypass	19.00	137.25
-External face-and-bypass	22.00	153.91
-Internal face-and-bypass or face damper only	19.00	137.25
Fan		
-Belt-drive plenum (BDP) fan with motor	n/a	n/a
-Housed fan FC with motor	69.00	1399.90
-Housed AF/BC fans with motor	69.00	1548.63
-Direct-drive plenum fan with motor	69.00	1237.09
Filters		
-Side load 2-in. angled	24.50	348.70
-Side load 4-in. angled	24.50	361.27
-Side load cartridge 12-in. or short bag 18-in.	24.50	342.50

Table 55. Section dimensions (inches) and weights (pounds) - unit size 22

Filters	Length (in.)	Weight (lb.)
-Side load 2-in. flat	14.00	160.19
-Side load 4-in. flat	14.00	189.17
-Side load 2-in. and 4-in. combination flat	19.00	252.01
-Long bag 30-in.	50.25	396.00
-Front-load HEPA	40.00	595.00
-Front-load cartridge	40.00	468.00
-Front-load short bag	45.00	488.00
Gas heat	n/a	n/a
Humidifier		
-Building Steam	14.00	368.00
-Atmospheric	14.00	344.00
Mixing box		
-with angled filters	36.00	315.97
-with front/back Traq and top Traq dampers	51.00	549.18
- reduced length mixing box with side/top/back/bottom airfoil damper	n/a	n/a
Multizone	n/a	n/a
Silencer		
-3 feet	38.00	562.00
-5 feet	62.00	858.00
Trane Catalytic Air Cleaning System (TCACS)	36.00	691.00
UV light	n/a	n/a

Table 56. Filter data for unit size 22

Filter Type	Area (ft ²)	Qty-Size (in.)
Flat (2-in., 4-in., and 2-in/4-in high efficiency) pleated, permanent, throwaway media	21.53	3 - 25x20
		1 - 25x16
		3 - 16x25
Angled (2-in. or 4-in.) Pleated, permanent, throwaway media	33.33	12 - 25x16
Side load bag or cartridge	22.00	3 - 24x24
		3 - 20x24
Front load bag or cartridge	18.00	3 - 12x24
		3 - 24x24
Front load HEPA	21.00	3 - 30x24
		3 - 12x24

Note: 2-inch filters available in permanent, throwaway, or pleated media; 4-inch filters available in pleated media, 65%, 85%, or 95% efficiency; Bag or cartridge filters available in 65%, 85%, or 95% efficiency.

Table 57. Coil availability - size 22

Section Type	5/8-in Unit Coils	
	1/2-in Unit Coils	1/2-in and 5/8-in Modified Coils
Small	2-4 rows	1-2 rows
Medium	2-8 rows	1-4 rows
Extended-medium	2-8 rows	1-8 rows
Medium-large	2-8 rows	1-10 rows
-with access	2-6 rows	1-4 rows
Large horizontal	2-8 rows	1-10 rows
-with access	2-8 rows	1-6 rows
Large vertical	n/a	n/a
-with access	n/a	n/a



General Data

Table 58. Coil data for unit size 22

Coil Type	Rows	Fin Type	Area ft ²	Qty-Size (in.)
1/2-inch unit coils				
-UA, UW, UF, UU	2, 4, 6, 8	Aluminum	19.97	1-57.50 x 50
5/8-inch unit coils				
-W, WD, D1, D2	4, 6, 8	Aluminum or Copper	18.89	1-55.50 x 49
-W, WD, 5D, D1, D2	6, 8, 10	Aluminum or Copper	18.89	1- 55.50 x 49
-W, 5A, 5W, D1	1, 2, 3	Aluminum or Copper	18.38	1-54 x 49
1-inch unit coil				
-NS (stacked)	1	Aluminum or Copper	17.35	1 - 33 x 49 1 - 18 x 49
1/2-inch modified coils				
-WL, LL, FD	2, 4, 6, 8	Aluminum	12.34	1-36.25 x 49
5/8-inch modified coils				
-W, WD, 5A, 5W, D1, D2	1, 2, 3, 4, 6, 8	Aluminum or Copper	12.25	1-36 x 49
W, WD, D1, D2	10	Aluminum	12.25	1-36 x 49
1-inch modified coil				
-NS (stacked)	1	Aluminum or Copper	12.25	2-18 x 49
Multizone coils			n/a	n/a

Table 59. Fan data for unit size 22

Size/Type Fan name	Housed Fans - Low Pressure					
	22-in FC 22FA	20-in FC 20FA	18-in FC 18FA	22-in AF 22AA	20-in AF 20AA	18-in AF 18AA
Max rpm	950	1050	1215	1900	2300	2450
ODP NEMA Premium motor hp range	2-20	2-20	2-7.5	2-15	2-15	2-10
Outlet area (ft ²)	5.54	4.38	2.88	5.54	4.38	2.88
Bearing/Shaft size (in.)	1.50	1.50	1.00	1.50	1.50	1.19
Size/Type Fan name	Housed Fans - High Pressure					
	22-in FC 22FB	20-in FC 20FB	18-in FC 18FB	22-in AF 22AB	20-in AF 20AB	18-in AF 18AB
Max rpm	1200	1330	1500	2500	2750	3100
ODP NEMA Premium motor hp range	2-20	2-20	2-15	2-25	2-25	2-20
Outlet area (ft ²)	5.54	4.38	2.88	5.54	4.38	2.88
Bearing/Shaft size (in.)	2.00	1.69	1.44	2.00	1.69	1.50
Size/Type Fan name	Belt-drive Plenum Fans				Direct-Drive Plenum Fans	
	Low Pressure		High Pressure		High Pressure	
	28-in AF	25-in AF	28-in AF	25-in AF	27-in AF Reduced Width	27-in AF Nominal Width
	28PA	25PA	28PB	25PB	27NR	27NF
Max rpm	1850	2070	2100	2350	2035	2035
ODP NEMA Premium motor hp range	2-25	2-20	2-30	2-30	5-25	7.5-25
Outlet area (ft ²)	n/a	n/a	n/a	n/a	n/a	n/a
Bearing/Shaft size (in.)	2.00	1.69	1.69	1.69	n/a	n/a

Unit Size 25

Table 60. Section dimensions (inches) and weights (pounds) - unit size 25

Nominal airflow	12,500	
Airflow at 625 fpm	16,944	
Height - indoor unit (in.)	61.50	
Width (in.)	80.00	
Height - outdoor unit (in.) includes base drip lip	69.25	
Weight add for outdoor unit (lbs./in. of unit length)	2.68	
Section type	Length (in.)	Weight (lb.)
Access or blank		
-Small horizontal	10.00	100.65
-Medium horizontal	14.00	124.79
-Extended-medium horizontal	19.00	154.97
-Medium-large horizontal	24.50	188.17
-Large horizontal or turning	46.00	413.45
-Extra-large horizontal or turning	56.50	476.83
-Ducted inlet or ducted outlet section	10.00	100.60
Blender	46.00	427.13
Cool Dry Quiet (CDQ) Desiccant Dehumidification Section	56.00	1876.00
Coils		
-Small horizontal (with 4-row UW)	10.00	502.46
-Medium horizontal (with 8-row UW)	14.00	817.63
-Extended-medium horizontal (with 8-row UW)	19.00	858.03
-Medium-large horizontal (with 10-row W)	24.50	1478.66
-Large horizontal or vertical (with 10-row W)	46.00	1652.36
-Electric Heat Coil	46.00	1012.00
-Integral-face-and-bypass (IFB) coil		
--Less than 4 rows	26.50	805.52
--4 rows	43.00	1399.66
Controls section (includes largest available VFD)	28.50	453.00
Diffuser	19.00	152.62
Discharge plenum		
-Horizontal	46.00	411.10
-Vertical	56.50	570.00
Energy Wheel	56.00	1595.00
Face-and-Bypass Dampers		
-Face-and-bypass	19.00	265.62
-External face-and-bypass	19.00	317.53
-Internal face-and-bypass or face damper only	19.00	306.62
Fan		
-Belt-drive plenum (BDP) fan with motor	50.25	1494.52
-Housed fan FC with motor	56.50	1487.55
-Housed AF/BC fans with motor	56.50	1572.28
-Direct-drive plenum fan with motor	56.50	1541.05
Filters		
-Side load 2-in. angled	24.50	403.70
-Side load 4-in. angled	24.50	409.37
-Side load cartridge 12-in. or short bag 18-in.	24.50	439.69

Table 60. Section dimensions (inches) and weights (pounds) - unit size 25

Filters	Length (in.)	Weight (lb.)
-Side load 2-in. flat	14.00	182.07
-Side load 4-in. flat	14.00	217.75
-Side load 2-in. and 4-in. combination flat	19.00	288.98
-Long bag 30-in.	46.00	489.00
-Front-load HEPA	40.00	750.00
-Front-load cartridge	40.00	580.00
-Front-load short bag	45.00	518.00
Gas heat		
- 200 MBH	n/a	n/a
- 300 MBH	n/a	n/a
- 360 MBH	69.00	1348.00
- 560 MBH	65.00	1307.50
- 700 MBH	75.00	1599.40
- 860 MBH	81.00	1711.20
- 1000 MBH	90.00	1497.30
Humidifier		
-Building Steam	14.00	398.00
-Atmospheric	14.00	432.00
Mixing box		
-with angled filters	46.00	413.45
-with front/back Traq and top Traq dampers	56.50	646.61
- reduced length mixing box with side/top/back/bottom airfoil damper	28.40	408.10
Multizone		
- 3-deck vertical discharge	82.00	2991.00
- 2-deck vertical discharge	82.00	2108.00
- 3-deck horizontal discharge	72.00	2829.00
- 2-deck horizontal discharge	72.00	1975.00
Silencer		
-3 feet	38.00	699.00
-5 feet	62.00	1073.00
Trane Catalytic Air Cleaning System (TCACS)	36.00	665.00
UV light	14.00	188.71
SECTIONS BELOW ARE FOR OUTDOOR UNITS ONLY		
Diagonal economizer		
-with airfoil dampers	57.00	548.00
-with airfoil damper and one side Traq damper	57.00	565.00
Exhaust damper section	19.00	250.50
Hoods		
- Back inlet hood - airfoil and Traq	79.88	128.00
- Side inlet hood - airfoil and Traq	25.75	84.00
- Exhaust hood - airfoil	25.75	59.00
- Economizer inlet hood	57.00	214.00
Pipe Cabinets		
15 in. long - 24-in. depth	15.00	122.00
15 in. long - 36-in. depth	15.00	164.00
15 in. long - 48-in. depth	15.00	207.00

Table 60. Section dimensions (inches) and weights (pounds) - unit size 25

Pipe Cabinets	Length (in.)	Weight (lb.)
24 in. long - 24-in. depth	24.00	142.00
24 in. long - 36-in. depth	24.00	187.00
24 in. long - 48-in. depth	24.00	233.00
48 in. long - 24-in. depth	48.00	195.00
48 in. long - 36-in. depth	48.00	249.00
48 in. long - 48-in. depth	48.00	303.00
96 in. long - 24-in. depth	96.00	302.00
96 in. long - 36-in. depth	96.00	373.00
96 in. long - 48-in. depth	96.00	443.00

Table 61. Filter data for unit size 25

Filter Type	Area ft ²	Qty-Size (in.)
Flat (2-in., 4-in., and 2-in/4-in high efficiency) pleated, permanent, throwaway media	27.11	6 - 20x20
		2 - 20x16
		3 - 12x24
Angled (2-in. or 4-in.) Pleated, permanent, throwaway media	50.00	18 - 25x16
Side load bag or cartridge	26.00	6 - 20x24
		3 - 12x24
Front load bag or cartridge	24.00	6 - 24x24
Front load HEPA	24.00	2 - 24x30
		1 - 24x12
		2 - 24x30
		1 - 24x12

Note: 2-inch filters available in permanent, throwaway, or pleated media; 4-inch filters available in pleated media, 65%, 85%, or 95% efficiency; Bag or cartridge filters available in 65%, 85%, or 95% efficiency.

Table 62. Coil availability - size 25

Section Type	5/8-in Unit Coils	
	1/2-in Unit Coils	1/2-in and 5/8-in Modified Coils
Small	2-4 rows	1-2 rows
Medium	2-8 rows	1-4 rows
Extended-medium	2-8 rows	1-8 ¹ rows
Medium-large	2-8 rows	1-10 ¹ rows
-with access	2-6 rows	1-3 rows
Large horizontal	2-8 rows	1-10 rows
-with access	2-8 rows	1-10 rows
Large vertical	2-8 rows	1-10 rows
-with access	2-8 rows	1-10 rows

Note: ¹6-row maximum for stacked coils.

Table 63. Coil data for unit size 25

Coil Type	Rows	Fin Type	Area ft ²	Qty-Size (in.)
1/2-inch unit coils				
-UA, UW, UF, UU	1, 2, 4, 6, 8	Aluminum	24.97	1-52.50 x 68.50
5/8-inch unit coils				
-W, 5A, 5W, D1	1, 2, 3, 4, 6, 8	Aluminum or Copper	24.08	1-51 x 68
-W, D1	4, 6, 8, 10	Aluminum	24.08	1-51 x 68
-W, WD, 5D, D1, D2	4, 6, 8	Copper	24.08	1-51 x 68
WD, 5D, D2	6, 8, 10	Aluminum or Copper	23.73	1-51 x 67
-TT, P2, P4, P8 (stacked)	1, 2, 4, 6, 8	Aluminum or Copper	22.67	2-24 x 68



General Data

Table 63. Coil data for unit size 25

Coil Type	Rows	Fin Type	Area ft ²	Qty-Size (in.)
1-inch unit coil				
-NS (stacked)	1	Aluminum or Copper	22.67	2-24 x 68
1/2-inch modified coils				
-WL, LL, FD	2, 4, 6, 8	Aluminum	17.12	1-36.25 x 68
5/8-inch modified coils				
-W, 5A, 5W, D1	1, 2, 3, 4, 6, 8	Aluminum or Copper	17.00	1-36 x 68
-W, D1	10	Aluminum	17.00	1-36 x 68
-W, WD, D1, D2	8	Copper	17.00	1-36 x 68
-D2	6, 8	Aluminum or Copper	16.75	1-36 x 67
-D2, WD	6, 8, 10	Aluminum	16.75	1-36 x 67
-WD	6, 8	Copper	16.75	1-36 x 67
-TT, P2, P4, P8 (stacked)	1, 2, 4, 6, 8	Aluminum or Copper	17.00	2-18 x 68
1-inch modified coil				
-NS (stacked)	1	Aluminum or Copper	17.00	2-18 x 68
Multizone coils				
-5A, 5W, NS, TT	1, 2	Aluminium or Copper	11.00	1-24 x 68
-WL	2	Aluminum	11.33	1-24 x 68

Table 64. Fan data for unit size 25

Size/Type Fan name	Housed Fans - Low Pressure					
	22-in FC 22FA	20-in FC 20FA	18-in FC 18FA	22-in AF 22AA	20-in AF 20AA	18-in AF 18AA
Max rpm	950	1050	1215	1900	2300	2450
ODP NEMA Premium motor hp range	3-20	3-20	3-7.5	3-15	3-15	3-10
Outlet area (ft ²)	5.54	4.38	2.88	5.54	4.38	2.88
Bearing/Shaft size (in.)	1.50	1.50	1.00	1.50	1.50	1.1875
Size/Type Fan name	Housed Fans - High Pressure					
	22-in FC 22FB	20-in FC 20FB	18-in FC 18FB	22-in AF 22AB	20-in AF 20AB	18-in AF 18AB
Max rpm	1200	1330	1500	2500	2750	3100
ODP NEMA Premium motor hp range	3-25	3-25	3-15	3-30	3-30	3-20
Outlet area (ft ²)	5.54	4.38	2.88	5.54	4.38	2.88
Bearing/Shaft size (in.)	2.00	1.69	1.44	2.00	1.69	1.50
Size/Type Fan name	Belt-drive Plenum Fans				Direct-Drive Plenum Fans	
	Low Pressure		High Pressure		High Pressure	
	28-in AF 28PA	25-in AF 25PA	28-in AF 28PB	25-in AF 25PB	2-22-inAF Reduced Width 22NR	2-22-inAF Nominal Width 22NF
Max rpm	1850	2070	2100	2350	2454	2454
ODP NEMA Premium motor hp range	3-25	3-20	3-30	3-30	3-15	5-20
Outlet area (ft ²)	n/a	n/a	n/a	n/a	n/a	n/a
Bearing/Shaft size (in.)	2.00	1.69	1.69	1.69	n/a	n/a

Unit Size 26

Table 65. Section dimensions (inches) and weights (pounds) - unit size 26

Nominal airflow	13,000	
Airflow at 625 fpm	18,231	
Height - indoor unit (in.)	85.50	
Width (in.)	61.50	
Height - outdoor unit (in.) includes base drip lip	Available for indoor use only	
Weight add for outdoor unit (lbs./in. of unit length)	n/a	n/a
Section type	Length (in.)	Weight (lb.)
Access or blank		
-Small horizontal	10.00	98.73
-Medium horizontal	14.00	123.71
-Extended-medium horizontal	19.00	154.93
-Medium-large horizontal	26.50	189.27
-Large horizontal or turning	46.00	428.50
-Extra-large horizontal or turning	n/a	n/a
-Ducted inlet or ducted outlet section	10.00	98.70
Blender	36.00	385.06
Cool Dry Quiet (CDQ) Desiccant Dehumidification Section	n/a	n/a
Coils		
-Small horizontal (with 4-row UW)	10.00	523.01
-Medium horizontal (with 8-row UW)	14.00	840.58
-Extended-medium horizontal (with 8-row UW)	19.00	878.74
-Medium-large horizontal (with 10-row W)	26.50	1503.93
-Large horizontal or vertical (with 10-row W)	46.00	1652.73
-Electric Heat Coil	n/a	n/a
-Integral-face-and-bypass (IFB) coil		
--Less than 4 rows	26.50	1047.84
--4 rows	43.00	1613.03
Controls section (includes largest available VFD)	28.50	464.00
Diffuser	19.00	152.58
Discharge plenum		
-Horizontal	46.00	426.15
-Vertical	n/a	n/a
Energy Wheel	n/a	n/a
Face-and-Bypass Dampers		
-Face-and-bypass	19.00	152.58
-External face-and-bypass	27.75	207.22
-Internal face-and-bypass or face damper only	19.00	152.58
Fan		
-Belt-drive plenum (BDP) fan with motor	n/	n/a
-Housed fan FC with motor	69.00	1589.43
-Housed AF/BC fans with motor	69.00	1687.15
-Direct-drive plenum fan with motor	69.00	1600.04
Filters		
-Side load 2-in. angled	24.50	418.53
-Side load 4-in. angled	24.50	470.37
-Side load cartridge 12-in. or short bag 18-in.	24.50	440.65



General Data

Table 65. Section dimensions (inches) and weights (pounds) - unit size 26

Filters	Length (in.)	Weight (lb.)
-Side load 2-in. flat	14.00	177.12
-Side load 4-in. flat	14.00	254.10
-Side load 2-in. and 4-in. combination flat	19.00	326.16
-Long bag 30-in.	37.25	462.00
-Front-load HEPA	40.00	837.00
-Front-load cartridge	40.00	553.00
-Front-load short bag	45.00	574.00
Gas heat	n/a	n/a
Humidifier		
-Building Steam	14.00	500.00
-Atmospheric	14.00	396.00
Mixing box		
-with angled filters	46.00	428.50
-with front/back Traq and top Traq dampers	n/a	n/a
- reduced length mixing box with side/top/back/bottom airfoil damper	n/a	n/a
Multizone	n/a	n/a
Silencer		
-3 feet	38.00	659.00
-5 feet	62.00	1005.00
Trane Catalytic Air Cleaning System (TCACS)	36.00	778.00
UV light	n/a	n/a

Table 66. Filter data for unit size 26

Filter Type	Area (ft ²)	Qty-Size (in.)
Flat (2-in., 4-in., and 2-in/4-in high efficiency) pleated, permanent, throwaway media	27.11	6 - 20x20 2 - 20x16 3 - 12x24
Angled (2-in. or 4-in.) Pleated, permanent, throwaway media	50.00	18 - 25x16
Side load bag or cartridge	26.00	6 - 20x24 3 - 12x24
Front load bag or cartridge	24.00	6 - 24x24 2 - 24x30 1 - 24x12 2 - 24x30 1 - 24x12
Front load HEPA	24.00	1 - 24x12

Note: 2-inch filters available in permanent, throwaway, or pleated media; 4-inch filters available in pleated media, 65%, 85%, or 95% efficiency; Bag or cartridge filters available in 65%, 85%, or 95% efficiency.

Table 67. Coil availability - size 26

Section Type	5/8-in Unit Coils	
	1/2-in Unit Coils	1/2-in and 5/8-in Modified Coils
Small	2-4 rows unstacked, 2 row stacked	1-2 rows
Medium	2-8 rows unstacked, 2-6 rows stacked w/out IDP, 2-4 rows with IDP	1-4 rows
Extended-medium	2-8 rows	1-8 rows w/out IDP, 1-6 rows w/ IDP
Medium-large	2-8 rows	1-10 rows
-with access	2-6 rows unstacked, 2-4 stacked without IDP, 2 row stacked with IDP	1-4 rows unstacked, 1-3 rows stacked w/out IDP, 1-2 rows stacked w/ IDP
Large horizontal	2-8 rows	1-10 rows
-with access	2-8 rows	1-10 rows
Large vertical	n/a	n/a

Note: IDP = intermediate drain pan

Table 68. Coil data for unit size 26

Coil Type	Rows	Fin Type	Area (ft ²)	Qty-Size (in.)
1/2-inch unit coils				
-UA, UW, UF, UU (stacked)	2, 4, 6, 8	Aluminum	24.67	2-36.25 x 49
5/8-inch unit coils				
-W, WD, 5A, 5W, D1, D2 (stacked)	1, 2, 3, 4, 6, 8	Aluminum or Copper	24.50	2-36 x 49
W, WD, D1, D2 (stacked)	4, 6, 8, 10	Aluminum	24.50	2-36 x 49
1-inch unit coil				
-NS (stacked)	1	Aluminum or Copper	22.46	1 - 30 x 49 2 - 18 x 49
1/2-inch modified coils				
-WL, LL	2, 4, 6, 8	Aluminum	18.72	1-55 x 49
-FD (stacked)	4, 6	Aluminum	19.14	1-31.25 x 49 1-25 x 49
5/8-inch modified coils				
-W, WD, 5A, 5W, D1, D2	1, 2, 3, 4, 6, 8	Aluminum or Copper	18.38	1-54 x 49
-WD, D1, D2	4, 6, 8, 10	Aluminum	18.38	1-54 x 49
1-inch modified coil				
-NS (stacked)	1	Aluminum or Copper	18.38	1-30 x 49 1-24 x 49
Multizone coils			n/a	n/a

Table 69. Fan data for unit size 26

Size/Type Fan name	Housed Fans - Low Pressure					
	22-in FC 22FA	20-in FC 20FA	18-in FC 18FA	22-in AF 22AA	20-in AF 20AA	18-in AF 18AA
Max rpm	950	1050	1215	1900	2300	2450
ODP NEMA Premium motor hp range	3-20	3-20	3-7.5	3-15	3-15	3-10
Outlet area (ft ²)	5.54	4.38	2.88	5.54	4.38	2.88
Bearing/Shaft size (in.)	1.50	1.50	1.00	1.50	1.50	1.19
Size/Type Fan name	Housed Fans - High Pressure					
	22-in FC 22FB	20-in FC 20FB	18-in FC 18FB	22-in AF 22AB	20-in AF 20AB	18-in AF 18AB
Max rpm	1200	1330	1500	2500	2750	3100
ODP NEMA Premium motor hp range	3-25	3-25	3-15	3-30	3-30	3-20
Outlet area (ft ²)	5.54	4.38	2.88	5.54	4.38	2.88
Bearing/Shaft size (in.)	2.00	1.69	1.44	2.00	1.69	1.50
Size/Type Fan name	Belt-drive Plenum Fans				Direct-Drive Plenum Fans	
	Low Pressure		High Pressure		High Pressure	
	28-in AF 28PA	25-in AF 25PA	28-in AF 28PB	25-in AF 25PB	30-in AF Reduced Width 30NR	30-in AF Nominal Width 30NF
Max rpm	1850	2070	2100	2350	1851	1851
ODP NEMA Premium motor hp range	3-25	3-20	3-30	3-30	7.5-25	10-40
Outlet area (ft ²)	n/a	n/a	n/a	n/a	n/a	n/a
Bearing/Shaft size (in.)	2.00	1.69	1.69	1.69	n/a	n/a



General Data

Unit Size 30

Table 70. Section dimensions (inches) and weights (pounds) - unit size 30

Nominal airflow	15,000	
Airflow at 625 fpm	19,025	
Height - indoor unit (in.)	61.50	
Width (in.)	93.50	
Height - outdoor unit (in.) includes base drip lip	69.25	
Weight add for outdoor unit (lbs./in. of unit length)	2.94	
Section type	Length (in.)	Weight (lb.)
Access or blank		
-Small horizontal	10.00	110.78
-Medium horizontal	14.00	136.97
-Extended-medium horizontal	19.00	169.71
-Medium-large horizontal	24.50	205.72
-Large horizontal or turning	46.00	457.18
-Extra-large horizontal or turning	56.50	525.93
-Ducted inlet or ducted outlet section	10.00	110.80
Blender	46.00	470.25
Cool Dry Quiet (CDQ) Desiccant Dehumidification Section	58.00	2029.00
Coils		
-Small horizontal (with 4-row UW)	10.00	572.50
-Medium horizontal (with 8-row UW)	14.00	941.48
-Extended-medium horizontal (with 8-row UW)	19.00	985.30
-Medium-large horizontal (with 10-row W)	24.50	1701.77
-Large horizontal or vertical (with 10-row W)	46.00	1890.19
-Electric Heat Coil	56.50	1244.00
-Integral-face-and-bypass (IFB) coil		
--Less than 4 rows	26.50	940.46
--4 rows	43.00	1439.40
Controls section (includes largest available VFD)	28.50	487.00
Diffuser	19.00	167.36
Discharge plenum		
-Horizontal	46.00	454.83
-Vertical	56.50	634.27
Energy Wheel	58.00	1868.00
Face-and-Bypass Dampers		
-Face-and-bypass	19.00	291.36
-External face-and-bypass	19.00	353.22
-Internal face-and-bypass or face damper only	19.00	341.36
Fan		
-Belt-drive plenum (BDP) fan with motor	52.50	1751.34
-Housed fan FC with motor	56.50	1710.85
-Housed AF/BC fans with motor	56.50	1797.21
-Direct-drive plenum fan with motor	56.50	1652.91

Table 70. Section dimensions (inches) and weights (pounds) - unit size 30

Filters	Length (in.)	Weight (lb.)
-Side load 2-in. angled	24.50	454.19
-Side load 4-in. angled	24.50	465.65
-Side load cartridge 12-in. or short bag 18-in.	24.50	479.36
-Side load 2-in. flat	14.00	198.93
-Side load 4-in. flat	14.00	249.73
-Side load 2-in. and 4-in. combination flat	19.00	326.58
-Long bag 30-in.	46.00	523.00
-Front-load HEPA	40.00	822.00
-Front-load cartridge	40.00	651.00
-Front-load short bag	45.00	567.00
Gas heat		
- 200 MBH	n/a	n/a
- 300 MBH	n/a	n/a
- 360 MBH	66.00	1298.90
- 560 MBH	66.00	1441.80
- 700 MBH	76.00	1745.60
- 860 MBH	76.00	1804.80
- 1000 MBH	85.00	1560.00
Humidifier		
-Building Steam	14.00	452.00
-Atmospheric	19.00	528.00
Mixing box		
-with angled filters	46.00	457.18
-with front/back Traq and top Traq dampers	56.50	715.15
- reduced length mixing box with side/top/back/bottom airfoil damper	32.50	485.80
Multizone		
- 3-deck vertical discharge	82.00	3425.00
- 2-deck vertical discharge	82.00	2413.00
- 3-deck horizontal discharge	72.00	3267.00
- 2-deck horizontal discharge	72.00	2264.00
Silencer		
-3 feet	38.00	800.00
-5 feet	62.00	1215.00
Trane Catalytic Air Cleaning System (TCACS)	36.00	711.00
UV light	14.00	218.33
SECTIONS BELOW ARE FOR OUTDOOR UNITS ONLY		
Diagonal economizer		
-with airfoil dampers	63.00	649.00
-with airfoil damper and one side Traq damper	63.00	689.00
Exhaust damper section	19.00	280.40
Hoods		
- Back inlet hood - airfoil and Traq	93.38	166.00
- Side inlet hood - airfoil and Traq	27.88	96.00
- Exhaust hood - airfoil	27.88	67.00
- Economizer inlet hood	62.50	224.00



General Data

Table 70. Section dimensions (inches) and weights (pounds) - unit size 30

Pipe Cabinets		
15 in. long - 24-in. depth	15.00	122.00
15 in. long - 36-in. depth	15.00	164.00
15 in. long - 48-in. depth	15.00	207.00
24 in. long - 24-in. depth	24.00	142.00
24 in. long - 36-in. depth	24.00	187.00
24 in. long - 48-in. depth	24.00	233.00
48 in. long - 24-in. depth	48.00	195.00
48 in. long - 36-in. depth	48.00	249.00
48 in. long - 48-in. depth	48.00	303.00
96 in. long - 24-in. depth	96.00	302.00
96 in. long - 36-in. depth	96.00	373.00
96 in. long - 48-in. depth	96.00	443.00

Table 71. Filter data for unit size 30

Filter Type	Area (ft ²)	Qty–Size (in.)
Flat (2-in., 4-in., and 2-in/4-in high efficiency) pleated, permanent, throwaway media	30.44	6 - 20x24
		2 - 20x16
		3 - 12x24
Angled (2-in. or 4-in.) Pleated, permanent, throwaway media	56.67	6 - 16x25
		18 - 16x20
Side load bag or cartridge	28.22	8 - 20x20
		3 - 12x24
Front load bag or cartridge	28.00	6 - 24x24
		2 - 12x24
		2 - 24x30
Front load HEPA	28.00	1 - 24x24
		2 - 24x30
		1 - 24x24

Note: 2-inch filters available in permanent, throwaway, or pleated media; 4-inch filters available in pleated media, 65%, 85%, or 95% efficiency; Bag or cartridge filters available in 65%, 85%, or 95% efficiency.

Table 72. Coil availability - size 30

Section Type	5/8-in Unit Coils,	
	1/2-in Unit Coils	1/2-in and 5/8-in Modified Coils
Small	2-4 rows	1-2 rows
Medium	2-8 rows	1-4 rows
Extended-medium	2-8 rows	1-8 ¹ rows
Medium-large	2-8 rows	1-10 ¹ rows
-with access	2-6 rows	1-3 rows
Large horizontal	2-8 rows	1-10 rows
-with access	2-8 rows	1-10 ¹ rows
Large vertical	2-8 rows	1-10 rows
-with access	2-8 rows	1-10 rows

Note: ¹6-row maximum for stacked coils.

Table 73. Coil data for unit size 30

Coil Type	Rows	Fin Type	Area ft ²	Qty–Size (in.)
1/2-inch unit coils				
-UA, UW, UF, UU	1, 2, 4, 6, 8	Aluminum	29.90	1–52.50 x 82
5/8-inch unit coils				
-W, WD, 5D, 5A, 5W, D1, D2	1, 2, 3, 4, 6, 8	Aluminum or Copper	28.69	1-51 x 81
-W, WD, 5D, D1, D2	4, 6, 8, 10	Aluminum	28.69	1-51 x 81
-W, WD, 5D, D1, D2	4, 6, 8	Copper	28.69	1-51 x 81
-TT, P2, P4, P8 (stacked)	1, 2, 4, 6, 8	Aluminum or Copper	27.00	2-24 x 81
1-inch unit coil				
-NS (stacked)	1	Aluminum or Copper	27.00	2–24 x 81
1/2-inch modified coils				
-WL, LL, FD	2, 4, 6, 8	Aluminum	20.39	1-36.25 x 81
5/8-inch modified coils				
-W, 5A, 5W, D1, D2	1, 2, 3, 4, 6, 8	Aluminum or Copper	20.25	1-36 x 81
-W, WD, D1, D2	6, 8, 10	Aluminum	20.25	1-36 x 81
-W, WD, D1, D2	8	Copper	20.25	1-36 x 81
-TT, P2, P4, P8 (stacked)	1, 2, 4, 6, 8	Aluminum or Copper	20.25	2-18 x 81
1-inch modified coil				
-NS (stacked)	1	Aluminum or Copper	20.25	2-18 x 81
Multizone coils				
-5A, 5W, NS, TT	1, 2	Aluminium or Copper	13.50	1-24 x 81
-WL	2	Aluminum	13.50	1-24 x 81

Table 74. Fan data for unit size 30

Size/Type Fan name	Housed Fans - Low Pressure					
	25-in FC 25FA	22-in FC 22FA	20-in FC 20FA	25-in AF 25AA	22-in AF 22AA	20-in AF 20AA
Max rpm	850	950	1050	1650	1900	2300
ODP NEMA Premium motor hp range	3-20	3-20	3-20	3-20	3-15	3-15
Outlet area (ft ²)	6.94	5.54	4.38	6.94	5.54	4.38
Bearing/Shaft size (in.)	1.69	1.50	1.50	1.69	1.50	1.50
Size/Type Fan name	Housed Fans - High Pressure					
	25-in FC 25FB	22-in FC 22FB	20-in FC 20FB	25-in AF 25AB	22-in AF 22AB	20-in AF 20AB
Max rpm	1025	1200	1330	2200	2500	2750
ODP NEMA Premium motor hp range	3-30	3-30	3-25	3-40	3-30	3-30
Outlet area (ft ²)	6.94	5.54	4.38	6.94	5.54	4.38
Bearing/Shaft size (in.)	2.44	2.00	1.69	2.00	2.00	1.69
Size/Type Fan name	Belt-drive Plenum Fans				Direct-Drive Plenum Fans	
	Low Pressure		High Pressure		High Pressure	
	32-in AF 32PA	28-in AF 28PA	32-in AF 32PB	28-in AF 28PB	2-24.5-in AF Reduced Width 24NR	2-24.5-in AF Nominal Width 24NF
Max rpm	1600	1850	1800	2100	2269	2269
ODP NEMA Premium motor hp range	3-25	3-25	3-40	3-40	5-20	5-20
Outlet area (ft ²)	n/a	n/a	n/a	n/a	n/a	n/a
Bearing/Shaft size (in.)	2.00	2.00	1.69	1.69	n/a	n/a



General Data

Unit Size 31

Table 75. Section dimensions (inches) and weights (pounds) - unit size 31

Nominal airflow	15,500	
Airflow at 625 fpm	22,138	
Height - indoor unit (in.)	85.50	
Width (in.)	72.00	
Height - outdoor unit (in.) includes base drip lip	Available for indoor use only	
Weight add for outdoor unit (lbs./in. of unit length)	n/a	n/a
Section type	Length (in.)	Weight (lb.)
Access or blank		
-Small horizontal	10.00	106.61
-Medium horizontal	14.00	133.18
-Extended-medium horizontal	19.00	166.39
-Medium-large horizontal	26.50	202.93
-Large horizontal or turning	46.00	467.28
-Extra-large horizontal or turning	n/a	n/a
-Ducted inlet or ducted outlet section	10.00	106.60
Blender	40.00	449.80
Cool Dry Quiet (CDQ) Desiccant Dehumidification Section	n/a	n/a
Coils		
-Small horizontal (with 4-row UW)	10.00	594.43
-Medium horizontal (with 8-row UW)	14.00	968.56
-Extended-medium horizontal (with 8-row UW)	19.00	1009.31
-Medium-large horizontal (with 10-row W)	26.50	1737.73
-Large horizontal or vertical (with 10-row W)	46.00	1896.66
-Electric Heat Coil	n/a	n/a
-Integral-face-and-bypass (IFB) coil		
--Less than 4 rows	26.50	1190.19
--4 rows	43.00	1836.97
Controls section (includes largest available VFD)	28.50	496.00
Diffuser	19.00	164.04
Discharge plenum		
-Horizontal	46.00	464.93
-Vertical	n/a	n/a
Energy Wheel	n/a	n/a
Face-and-Bypass Dampers		
-Face-and-bypass	19.00	164.04
-External face-and-bypass	27.75	222.16
-Internal face-and-bypass or face damper only	19.00	164.04
Fan		
-Belt-drive plenum (BDP) fan with motor	n/a	n/a
-Housed fan FC with motor	73.25	1832.18
-Housed AF/BC fans with motor	73.25	1979.55
-Direct-drive plenum fan with motor	73.25	1673.71
Filters		
-Side load 2-in. angled	24.50	469.97
-Side load 4-in. angled	24.50	477.66
-Side load cartridge 12-in. or short bag 18-in.	24.50	487.55

Table 75. Section dimensions (inches) and weights (pounds) - unit size 31

Filters	Length (in.)	Weight (lb.)
-Side load 2-in. flat	14.00	198.17
-Side load 4-in. flat	14.00	241.97
-Side load 2-in. and 4-in. combination flat	19.00	322.00
-Long bag 30-in.	37.25	506.00
-Front-load HEPA	40.00	874.00
-Front-load cartridge	40.00	637.00
-Front-load short bag	45.00	623.00
Gas heat	n/a	n/a
Humidifier		
-Building Steam	14.00	561.00
-Atmospheric	19.00	471.00
Mixing box		
-with angled filters	46.00	467.28
-with front/back Traq and top Traq dampers	n/a	n/a
- reduced length mixing box with side/top/back/bottom airfoil damper	n/a	n/a
Multizone	n/a	n/a
Silencer		
-3 feet	38.00	826.00
-5 feet	62.00	1272.00
Trane Catalytic Air Cleaning System (TCACS)	36.00	826.00
UV light	n/a	n/a

Table 76. Filter data for unit size 31

Filter Type	Area (ft ²)	Qty-Size (in.)
Flat (2-in., 4-in., and 2-in/4-in high efficiency) pleated, permanent, throwaway media	30.44	6 - 20x24
		2 - 20x16
		3 - 12x24
Angled (2-in. or 4-in.) Pleated, permanent, throwaway media	56.67	6 - 16x25
		18 - 16x20
Side load bag or cartridge	28.22	8 - 20x20
		3 - 12x24
Front load bag or cartridge	28.00	6 - 24x24
		2 - 12x24
Front load HEPA	28.00	2 - 24x30
		1 - 24x24
		2 - 24x30
		1 - 24x24

Note: 2-inch filters available in permanent, throwaway, or pleated media; 4-inch filters available in pleated media, 65%, 85%, or 95% efficiency; Bag or cartridge filters available in 65%, 85%, or 95% efficiency.

Table 77. Coil availability - size 31

Section Type	5/8-in Unit Coils, 1/2-in and 5/8-in Modified Coils	
	1/2-in Unit Coils	
Small	2-4 rows unstacked, 2 rows stacked	1-2 rows
Medium	2-8 rows unstacked, 2-6 rows stacked without IDP, 2-4 rows stacked with IDP	1-4 rows
Extended-medium	2-8 rows	1-8 without IDP 1-6 rows with IDP
Medium-large	2-8 rows	1-10 rows
-with access	2-6 rows unstacked, 2-4 rows stacked without IDP	1-4 rows unstacked, 1-3 rows stacked without IDP, 1-2 rows stacked with IDP
Large horizontal	2-8 rows	1-10 rows
-with access	2-8 rows	1-10 rows
Large vertical	n/a	n/a



General Data

Table 78. Coil data for unit size 31

Coil Type	Rows	Fin Type	Area (ft ²)	Qty–Size (in.)
1/2-inch unit coils				
-UA, UW, UF, UU (stacked)	2, 4, 6, 8	Aluminum	29.96	1–36.25 x 59.50
5/8-inch unit coils				
-W, WD, 5A, 5W, D1, D2 (stacked)	1, 2, 3, 5, 6, 8	Aluminum or Copper	29.50	1-36 x 59
-W, WD, D1, D2 (stacked)	10	Aluminum	29.50	2-36 x 59
1-inch unit coil				
-NS (stacked)	1	Aluminum or Copper	27.04	1-30 x 59 2-18 x 59
1/2-inch modified coils				
-WL, LL	2, 4, 6, 8	Aluminum	22.53	1-55 x 59
-FD (stacked)	4, 6	Aluminum	23.05	1-31.25 x 59 1-25 x 59
5/8-inch modified coils				
-W, WD, 5A, 5W, D1, D2	1, 2, 3, 4, 6, 8	Aluminum or Copper	22.13	1-54 x 59
W, WD, D1, D2	4, 6, 8, 10	Aluminum	22.13	1-54 x 59
1-inch modified coil				
-NS (stacked)	1	Aluminum or Copper	22.13	1-30 x 59 1-24 x 59
Multizone coils			n/a	n/a

Table 79. Fan data for unit size 31

Size/Type Fan name	Housed Fans - Low Pressure					
	25-in FC 25FA	22-in FC 22FA	20-in FC 20FA	25-in AF 25AA	22-in AF 22AA	20-in AF 20AA
Max rpm	850	950	1050	1650	1900	2300
ODP NEMA Premium motor hp range	3-20	3-20	3-20	3-20	3-15	3-15
Outlet area (ft ²)	6.94	5.54	4.38	6.94	5.54	4.38
Bearing/Shaft size (in.)	1.69	1.50	1.50	1.69	1.50	1.50
Size/Type Fan name	Housed Fans - High Pressure					
	25-in FC 25FB	22-in FC 22FB	20-in FC 20FB	25-in AF 25AB	22-in AF 22AB	20-in AF 20AB
Max rpm	1025	1200	1330	2200	2500	2750
ODP NEMA Premium motor hp range	3-30	3-30	3-25	3-40	3-30	3-30
Outlet area (ft ²)	6.94	5.54	4.38	6.94	5.54	4.38
Bearing/Shaft size (in.)	2.44	2.00	1.69	2.00	2.00	1.69
Size/Type Fan name	Belt-drive Plenum Fans			Direct-Drive Plenum Fans		
	Low Pressure		High Pressure	High Pressure		
	n/a	n/a	n/a	n/a	2-24.5-in AF Reduced Width 24NR	2-24.5-in AF Nominal Width 24NF
Max rpm					2269	2269
ODP NEMA Premium motor hp range					5-20	5-20
Outlet area (ft ²)					n/a	n/a
Bearing/Shaft size (in.)					n/a	n/a

Unit Size 35

Table 80. Section dimensions (inches) and weights (pounds) - unit size 35

Nominal airflow	17,500	
Airflow at 625 fpm	23,263	
Height - indoor unit (in.)	67.25	
Width (in.)	100.00	
Height - outdoor unit (in.) includes base drip lip	75.00	
Weight add for outdoor unit (lbs./in. of unit length)	3.02	
Section type	Length (in.)	Weight (lb.)
Access or blank		
-Small horizontal	10.00	211.11
-Medium horizontal	14.00	241.53
-Extended-medium horizontal	19.00	279.57
-Medium-large horizontal	24.50	321.40
-Large horizontal or turning	48.00	514.42
-Extra-large horizontal or turning	63.75	624.86
-Ducted inlet or ducted outlet section	10.00	211.10
Blender	48.00	540.76
Cool Dry Quiet (CDQ) Desiccant Dehumidification Section	56.00	2914.00
Coils		
-Small horizontal (with 4-row UW)	10.00	690.59
-Medium horizontal (with 8-row UW)	14.00	1094.27
-Extended-medium horizontal (with 8-row UW)	19.00	1148.70
-Medium-large horizontal (with 10-row W)	24.50	1955.08
-Large horizontal or vertical (with 10-row W)	48.00	2131.70
-Electric Heat Coil	63.80	1666.00
-Integral-face-and-bypass (IFB) coil		
-Less than 4 rows	29.50	1129.66
--4 rows	43.00	1677.52
Controls section (includes largest available VFD)	28.50	637.00
Diffuser	24.50	319.05
Discharge plenum		
-Horizontal	48.00	627.24
-Vertical	63.75	876.48
Energy Wheel	61.00	2403.00
Face-and-Bypass Dampers		
-Face-and-bypass	19.00	473.39
-External face-and-bypass	22.00	566.46
-Internal face-and-bypass or face damper only	19.00	502.53
Fan		
-Belt-drive plenum (BDP) fan with motor	53.50	2368.54
-Housed fan FC with motor	63.75	2400.18
-Housed AF/BC fans with motor	63.75	2429.71
-Direct-drive plenum fan with motor	63.75	2057.87
Filters		
-Side load 2-in. angled	24.50	593.86
-Side load 4-in. angled	24.50	594.02
-Side load cartridge 12-in. or short bag 18-in.	24.50	681.24

General Data
Table 80. Section dimensions (inches) and weights (pounds) - unit size 35

Filters	Length (in.)	Weight (lb.)
-Side load 2-in. flat	14.00	319.66
-Side load 4-in. flat	14.00	359.20
-Side load 2-in. and 4-in. combination flat	19.00	476.00
-Long bag 30-in.	37.25	657.00
-Front-load HEPA	40.00	986.00
-Front-load cartridge	40.00	868.00
-Front-load short bag	45.00	751.00
Gas heat		
- 200 MBH	n/a	n/a
- 300 MBH	n/a	n/a
- 360 MBH	66.00	1402.10
- 560 MBH	66.00	1594.60
- 700 MBH	73.00	1895.20
- 860 MBH	80.00	2046.30
- 1000 MBH	80.00	1723.70
- 1250-1750 MBH	101.00	2540.80
- 2000 MBH	n/a	n/a
- 2400 MBH	n/a	n/a
Humidifier		
-Building Steam	14.00	544.00
-Atmospheric	19.00	581.00
Mixing box		
-with angled filters	48.00	519.12
-with front/back Traq and top Traq dampers	63.75	966.49
- reduced length mixing box with side/top/back/bottom airfoil damper	35.50	708.50
Multizone		
- 3-deck vertical discharge	92.00	4263.00
- 2-deck vertical discharge	92.00	2965.00
- 3-deck horizontal discharge	78.00	4020.00
- 2-deck horizontal discharge	78.00	2725.00
Silencer		
-3 feet	38.00	918.00
-5 feet	62.00	1335.00
Trane Catalytic Air Cleaning System (TCACS)	36.00	882.00
UV light	14.00	325.48
SECTIONS BELOW ARE FOR OUTDOOR UNITS ONLY		
Diagonal economizer		
-with airfoil dampers	75.00	931.00
-with airfoil damper and one side Traq damper	75.00	973.00
Exhaust damper section	24.50	450.80
Hoods		
- Back inlet hood - airfoil and Traq	99.88	176.00
- Side inlet hood - airfoil and Traq	40.88	122.00
- Exhaust hood - airfoil	40.88	73.00
- Economizer inlet hood	75.00	195.00

Table 80. Section dimensions (inches) and weights (pounds) - unit size 35

Pipe Cabinets	Length (in.)	Weight (lb.)
15 in. long - 24-in. depth	15.00	130.00
15 in. long - 36-in. depth	15.00	175.00
15 in. long - 48-in. depth	15.00	220.00
24 in. long - 24-in. depth	24.00	151.00
24 in. long - 36-in. depth	24.00	199.00
24 in. long - 48-in. depth	24.00	247.00
48 in. long - 24-in. depth	48.00	207.00
48 in. long - 36-in. depth	48.00	263.00
48 in. long - 48-in. depth	48.00	320.00
96 in. long - 24-in. depth	96.00	319.00
96 in. long - 36-in. depth	96.00	392.00
96 in. long - 48-in. depth	96.00	466.00

Table 81. Filter data for unit size 35

Filter Type	Area (ft ²)	Qty-Size (in.)
Flat (2-in., 4-in., and 2-in/4-in high efficiency) pleated, permanent, throwaway media	37.22	8 - 20x24
		3 - 16x25
		1 - 16x20
Angled (2-in. or 4-in.) Pleated, permanent, throwaway media	63.33	18 - 16x25
		6 - 16x20
Side load bag or cartridge	34.67	8 - 20x24
		4 - 12x24
Front load bag or cartridge	34.00	5 - 12x24
		6 - 24x24
Front load HEPA	30.00	3 - 24x30
		3 - 30x24

Note: 2-inch filters available in permanent, throwaway, or pleated media; 4-inch filters available in pleated media, 65%, 85%, or 95% efficiency; Bag or cartridge filters available in 65%, 85%, or 95% efficiency.

Table 82. Coil availability - size 35

Section Type	1/2-in Unit Coils	5/8-in Unit Coils, 1/2-in and 5/8-in Modified Coils
Small	2-4 rows	1-2 rows
Medium	2-8 rows	1-4 rows
Extended-medium	2-8 rows	1-8 rows ¹
Medium-large	2-8 rows	1-10 rows
-with access	2-4 rows	1-3 rows
Large horizontal	2-8 rows	1-10 rows
-with access	2-8 rows	1-10 rows
Large vertical	2-8 rows	1-6 rows
-with access	2-8 rows	1-6 rows

Note: ¹6-row maximum for stacked coils.



General Data

Table 83. Coil data for unit size 35

Coil Type	Rows	Fin Type	Area ft ²	Qty–Size (in.)
1/2-inch unit coils				
-UA, UW, UF, UU	2, 4, 6, 8	Aluminum	34.94	1–57.50 x 87.50
5/8-inch unit coils				
-W, WD, 5D, D1, D2	4, 6, 8, 10	Aluminum or Copper	33.53	1-55.50 x 87
- W, 5A, 5W, D1	1, 2, 3	Aluminum or Copper	32.63	1-54 x 87
1-inch unit coil				
-NS (stacked)	1	Aluminum or Copper	30.81	1-33 x 87 1-18 x 87
1/2-inch modified coils				
-WL, LL, FD	2, 4, 6, 8	Aluminum	21.90	1-36.25 x 87
5/8-inch modified coils				
-W, WD, 5A, 5W, D1, D2	1, 2, 3, 4, 6, 8, 10	Aluminum or Copper	21.75	1-36 x 87
1-inch modified coil				
-NS (stacked)	1	Aluminum or Copper	21.75	2-18 x 87
Multizone coils				
-5A, 5W, NS	1, 2	Aluminium or Copper	18.13	1-30 x 87
-WL	2	Aluminum	18.13	1-30 x 87

Table 84. Fan data for unit size 35

Size/Type Fan name	Housed Fans - Low Pressure					
	25-in. FC 25FA	22-in. FC 22FA	20-in. FC 20FA	25-in. AF 25AA	22-in. AF 22AA	20-in. AF 20AA
Max rpm	850	950	1050	1650	1900	2300
ODP NEMA Premium motor hp range	7.5-20	7.5-20	7.5-20	7.5-20	7.5-15	7.5-15
Outlet area (ft ²)	6.95	5.54	4.38	6.95	5.54	4.38
Bearing/Shaft size (in.)	1.69	1.50	1.50	1.69	1.50	1.50
Size/Type Fan name	Housed Fans - High Pressure					
	25-in. FC 25FB	22-in. FC 22FB	20-in. FC 20FB	25-in. AF 25AB	22-in. AF 22AB	20-in. AF 20AB
Max rpm	1025	1200	1330	2200	2500	2750
ODP NEMA Premium motor hp range	7.5-40	7.5-30	7.5-25	7.5-40	7.5-40	7.5-30
Outlet area (ft ²)	6.95	5.54	4.38	6.95	5.54	4.38
Bearing/Shaft size (in.)	2.44	2.00	1.69	2.00	2.00	1.69
Size/Type Fan name	Belt-drive Plenum Fans				Direct-Drive Plenum Fans	
	Low Pressure		High Pressure		High Pressure	
	36-in. AF 36PA	32-in. AF 32PA	36-in. AF 36PB	32-in. AF 32PB	2-24.5-inAF Nominal Width 24NF	2-24.5-inAF Extended Width 24NW
Max rpm	1350	1600	1600	1800	2269	2269
ODP NEMA Premium motor hp range	7.5-30	7.5-25	7.5-50	7.5-50	5-20	5-20
Outlet area (ft ²)	n/a	n/a	n/a	n/a	n/a	n/a
Bearing/Shaft size (in.)	2.44	2.00	2.19	1.69	n/a	n/a

Unit Size 36

Table 85. Section dimensions (inches) and weights (pounds) - unit size 36

Nominal airflow	18,000	
Airflow at 625 fpm	25,000	
Height - indoor unit (in.)	89.00	
Width (in.)	80.00	
Height - outdoor unit (in.) includes base drip lip	Available for indoor use only	
Weight add for outdoor unit (lbs./in. of unit length)	n/a	n/a
Section type	Length (in.)	Weight (lb.)
Access or blank		
-Small horizontal	10.00	207.98
-Medium horizontal	14.00	238.68
-Extended-medium horizontal	19.00	277.04
-Medium-large horizontal	29.50	319.24
-Large horizontal or turning	46.00	509.00
-Extra-large horizontal or turning	n/a	n/a
-Ducted inlet or ducted outlet section	10.00	208.00
Blender	40.00	495.07
Cool Dry Quiet (CDQ) Desiccant Dehumidification Section	n/a	n/a
Coils		
-Small horizontal (with 4-row UW)	10.00	675.23
-Medium horizontal (with 8-row UW)	14.00	1095.29
-Extended-medium horizontal (with 8-row UW)	19.00	1138.74
-Medium-large horizontal (with 10-row W)	29.50	2017.86
-Large horizontal or vertical (with 10-row W)	46.00	2161.23
-Electric Heat Coil	n/a	n/a
-Integral-face-and-bypass (IFB) coil		
--Less than 4 rows	29.50	1407.86
--4 rows	43.00	2148.28
Controls section (includes largest available VFD)	28.50	649.00
Diffuser	24.50	316.89
Discharge plenum		
-Horizontal	46.00	621.68
-Vertical	n/a	n/a
Energy Wheel		
Face-and-Bypass Dampers		
-Face-and-bypass	19.00	274.69
-External face-and-bypass	27.75	341.83
-Internal face-and-bypass or face damper only	19.00	274.69
Fan		
-Belt-drive plenum (BDP) fan with motor	n/a	n/a
-Housed fan FC with motor	80.50	2423.46
-Housed AF/BC fans with motor	80.50	2568.99
-Direct-drive plenum fan with motor	80.50	2804.47
Filters		
-Side load 2-in. angled	24.50	562.37
-Side load 4-in. angled	24.50	567.56
-Side load cartridge 12-in. or short bag 18-in.	24.50	637.25

General Data

Table 85. Section dimensions (inches) and weights (pounds) - unit size 36

Filters	Length (in.)	Weight (lb.)
-Side load 2-in. flat	14.00	322.85
-Side load 4-in. flat	14.00	350.39
-Side load 2-in. and 4-in. combination flat	19.00	484.13
-Long bag 30-in.	37.25	701.00
-Front-load HEPA	40.00	1176.00
-Front-load cartridge	40.00	797.00
-Front-load short bag	45.00	778.00
Gas heat	n/a	n/a
Humidifier		
-Building Steam	14.00	622.00
-Atmospheric	19.00	508.00
Mixing box		
-with angled filters	46.00	513.70
-with front/back Traq and top Traq dampers	n/a	n/a
- reduced length mixing box with side/top/back/bottom airfoil damper	n/a	n/a
Multizone	n/a	n/a
Silencer		
-3 feet	38.00	951.00
-5 feet	62.00	1478.00
Trane Catalytic Air Cleaning System (TCACS)	36.00	916.00
UV light	n/a	n/a

Table 86. Filter data for unit size 36

Filter Type	Area (ft ²)	Qty-Size (in.)
Flat (2-in., 4-in., and 2-in/4-in high efficiency) pleated, permanent, throwaway media	37.22	8 - 20x24
		3 - 16x25
		1 - 16x20
Angled (2-in. or 4-in.) Pleated, permanent, throwaway media	63.33	18 - 16x25
		6 - 16x20
Side load bag or cartridge	34.67	8 - 20x24
		4 - 12x24
Front load bag or cartridge	34.00	5 - 12x24
		6 - 24x24
Front load HEPA	30.00	3 - 24x30
		3 - 30x24

Note: 2-inch filters available in permanent, throwaway, or pleated media; 4-inch filters available in pleated media, 65%, 85%, or 95% efficiency; Bag or cartridge filters available in 65%, 85%, or 95% efficiency.

Table 87. Coil availability - size 36

Section Type	5/8-in Unit Coils, 1/2-in and 5/8-in Modified Coils	
	1/2-in Unit Coils	
Small	2 rows	1-2 rows
Medium	2-6 rows (4 row cooling)	1-4 rows without IDP
Extended-medium	2-8 rows	1-8 rows without IDP
Medium-large	2-8 rows	1-10 rows
-with access	2-8 rows	1-6 rows
Large horizontal	2-8 rows	1-10 rows
-with access	2-8 rows	1-10 rows
Large vertical	n/a	n/a
-with access	n/a	n/a

Table 88. Coil data for unit size 36

Coil Type	Rows	Fin Type	Area ft ²	Qty–Size (in.)
1/2-inch unit coils				
-UW, UA, UF, UU (stacked)	2, 4, 6, 8	Aluminum	34.11	1–37.50 x 65.50
5/8-inch unit coils				
-W, WD, 5A, 5W, D1, D2 (stacked)	1, 2, 3, 4, 6, 8	Aluminum or Copper	34.38	2-37.50 x 66
- W, WD, D1, D2 (stacked)	10	Aluminum	34.38	2-37.50 x 66
1-inch unit coil				
-NS (stacked)	1	Aluminum or Copper	31.63	1-33 x 66 2-18 x 66
1/2-inch modified coils				
-WL, LL, FD (stacked)	2, 4, 6, 8	Aluminum	26.93	1-33.75 x 66 1-25 x 66
5/8-inch modified coils				
-W, 5A, 5W, D1, D2 (stacked)	1, 2, 3, 4, 6, 8	Aluminum or Copper	26.13	1-33 x 66 1-24 x 66
-W, WD, D1, D2 (stacked)	4, 6, 8, 10	Aluminum	26.13	1-33 x 66 1-24 x 66
1-inch modified coil				
-NS (stacked)	1	Aluminum or Copper	26.13	1-33 x 66 1- 24 x 66
Multizone coils			n/a	n/a

Table 89. Fan data for unit size 36

Size/Type Fan name	Housed Fans - Low Pressure					
	25-in. FC 25FA	22-in. FC 22FA	20-in. FC 20FA	25-in. AF 25AA	22-in. AF 22AA	20-in. AF 20AA
Max rpm	850	950	1050	1650	1900	2300
ODP NEMA Premium motor hp range	7.5-20	7.5-20	7.5-20	7.5-20	7.5-15	7.5-15
Outlet area (ft ²)	6.95	5.54	4.38	6.95	5.54	4.38
Bearing/Shaft size (in.)	1.69	1.50	1.50	1.69	1.50	1.50
Size/Type Fan name	Housed Fans - High Pressure					
	25-in. FC 25FB	22-in. FC 22FB	20-in. FC 20FB	25-in. AF 25AB	22-in. AF 22AB	20-in. AF 20AB
Max rpm	1025	1200	1330	2200	2500	2750
ODP NEMA Premium motor hp range	7.5-40	7.5-30	7.5-25	7.5-40	7.5-40	7.5-30
Outlet area (ft ²)	6.95	5.54	4.38	6.95	5.54	4.38
Bearing/Shaft size (in.)	2.44	2.00	1.69	2.00	2.00	1.69
Size/Type Fan name	Belt-drive Plenum Fans				Direct-Drive Plenum Fans	
	Low Pressure		High Pressure		High Pressure	
	n/a	n/a	n/a	n/a	2-22-inAF Nominal Width	2-22-inAF Extended Width
					22SF	22SW
Max rpm					2675	2675
ODP NEMA Premium motor hp range					5-25	5-25
Outlet area (ft ²)					n/a	n/a
Bearing/Shaft size (in.)					n/a	n/a



General Data

Unit Size 40

Table 90. Section dimensions (inches) and weights (pounds) - unit size 40

Nominal airflow	20,000	
Airflow at 625 fpm	25,519	
Height - indoor unit (in.)	67.25	
Width (in.)	112.50	
Height - outdoor unit (in.) includes base drip lip	75.00	
Weight add for outdoor unit (lbs./in. of unit length)	3.28	
Section type	Length (in.)	Weight (lb.)
Access or blank		
-Small horizontal	10.00	227.92
-Medium horizontal	14.00	260.24
-Extended-medium horizontal	19.00	300.64
-Medium-large horizontal	24.50	345.09
-Large horizontal or turning	48.00	557.22
-Extra-large horizontal or turning	63.75	675.12
-Ducted inlet or ducted outlet section	10.00	227.90
Blender	48.00	593.46
Cool Dry Quiet (CDQ) Desiccant Dehumidification Section	56.00	3122.00
Coils		
-Small horizontal (with 4-row UW)	10.00	754.61
-Medium horizontal (with 8-row UW)	14.00	1219.78
-Extended-medium horizontal (with 8-row UW)	19.00	1279.06
-Medium-large horizontal (with 10-row W)	24.50	2216.68
-Large horizontal or vertical (with 10-row W)	48.00	2401.84
-Electric Heat Coil	63.80	1825.00
-Integral-face-and-bypass (IFB) coil		
--Less than 4 rows	29.50	1168.40
--4 rows	43.00	1720.20
Controls section (includes largest available VFD)	28.50	674.00
Diffuser	24.50	342.74
Discharge plenum		
-Horizontal	48.00	677.47
-Vertical	63.75	949.58
Energy Wheel	65.00	2742.00
Face-and-Bypass Dampers		
-Face-and-bypass	19.00	556.23
-External face-and-bypass	22.00	660.36
-Internal face-and-bypass or face damper only	19.00	575.62
Fan		
-Belt-drive plenum (BDP) fan with motor	53.50	2740.37
-Housed fan FC with motor	63.75	2603.08
-Housed AF/BC fans with motor	63.75	2695.61
-Direct-drive plenum fan with motor	63.75	2406.73
Filters		
-Side load 2-in. angled	24.50	649.06
-Side load 4-in. angled	24.50	631.64
-Side load cartridge 12-in. or short bag 18-in.	24.50	668.25

Table 90. Section dimensions (inches) and weights (pounds) - unit size 40

Filters	Length (in.)	Weight (lb.)
-Side load 2-in. flat	14.00	358.18
-Side load 4-in. flat	14.00	375.13
-Side load 2-in. and 4-in. combination flat	19.00	504.37
-Long bag 30-in.	37.25	716.00
-Front-load HEPA	40.00	1128.00
-Front-load cartridge	40.00	923.00
-Front-load short bag	45.00	800.00
Gas heat		
- 200 MBH	n/a	n/a
- 300 MBH	n/a	n/a
- 360 MBH	n/a	n/a
- 560 MBH	64.00	1468.10
- 700 MBH	75.00	1804.10
- 860 MBH	75.00	2098.70
- 1000 MBH	81.00	1844.70
- 1250-1750 MBH	105.00	2717.90
Humidifier		
-Building Steam	14.00	599.00
-Atmospheric	19.00	665.00
Mixing box		
-with angled filters	48.00	561.92
-with front/back Traq and top Traq dampers	63.75	1073.80
- reduced length mixing box with side/top/back/bottom airfoil damper	38.50	795.10
Multizone		
- 3-deck vertical discharge	92.00	4732.00
- 2-deck vertical discharge	92.00	3267.00
- 3-deck horizontal discharge	78.00	4471.00
- 2-deck horizontal discharge	78.00	3006.00
Silencer		
-3 feet	38.00	974.00
-5 feet	62.00	1439.00
Trane Catalytic Air Cleaning System (TCACS)	36.00	935.00
UV light	14.00	352.71
SECTIONS BELOW ARE FOR OUTDOOR UNITS ONLY		
Diagonal economizer		
-with airfoil dampers	83.00	1062.00
-with airfoil damper and one side Traq damper	83.00	1101.00
Exhaust damper section	24.50	489.90
Hoods		
- Back inlet hood - airfoil and Traq	112.38	195.00
- Side inlet hood - airfoil and Traq	40.88	128.00
- Exhaust hood - airfoil	40.88	77.00
- Economizer inlet hood	83.00	275.00
Pipe Cabinets		
15 in. long - 24-in. depth	15.00	130.00
15 in. long - 36-in. depth	15.00	175.00
15 in. long - 48-in. depth	15.00	220.00



General Data

Table 90. Section dimensions (inches) and weights (pounds) - unit size 40

Pipe Cabinets	Length (in.)	Weight (lb.)
24 in. long - 24-in. depth	24.00	151.00
24 in. long - 36-in. depth	24.00	199.00
24 in. long - 48-in. depth	24.00	247.00
48 in. long - 24-in. depth	48.00	207.00
48 in. long - 36-in. depth	48.00	263.00
48 in. long - 48-in. depth	48.00	320.00
96 in. long - 24-in. depth	96.00	319.00
96 in. long - 36-in. depth	96.00	392.00
96 in. long - 48-in. depth	96.00	466.00

Table 91. Filter data for unit size 40

Filter Type	Area ft ²	Qty-Size (in.)
Flat (2-in., 4-in., and 2-in/4-in high efficiency) pleated, permanent, throwaway media	40.83	8 - 20x20
		2 - 20x25
		4 - 16x20
		1 - 16x25
		6 - 16x25
Angled (2-in. or 4-in.) Pleated, permanent, throwaway media	70.00	24 - 16x20
		8 - 24x24
Side load bag or cartridge	36.00	2 - 24x12
		4 - 12x24
Front load bag or cartridge	40.00	8 - 24x24
		3 - 24x30
Front load HEPA	37.00	1 - 24x12
		4 - 30x24

Note: 2-inch filters available in permanent, throwaway, or pleated media; 4-inch filters available in pleated media, 65%, 85%, or 95% efficiency; Bag or cartridge filters available in 65%, 85%, or 95% efficiency.

Table 92. Coil availability - size 40

Section Type	1/2-in Unit Coils	5/8-in Unit Coils, 1/2-in and 5/8-in Modified Coils
Small	2-4 rows	1-2 rows
Medium	2-8 rows	1-4 rows
Extended-medium	2-8 rows	1-8 ¹ rows
Medium-large	2-8 rows	1-10 rows
-with access	2-4 rows	1-3 rows
Large horizontal	2-8 rows	1-10 rows
-with access	2-8 rows	1-10 rows
Large vertical	2-8 rows	1-6 rows
-with access	2-8 rows	1-6 rows

Note: ¹6-row maximum for stacked coils.

Table 93. Coil data for unit size 40

Coil Type	Rows	Fin Type	Area ft ²	Qty-Size (in.)
1/2-inch unit coils				
-UA, UW, UF, UU	2, 4, 6, 8	Aluminum	39.93	1-57.50 x 100
5/8-inch unit coils				
-W, WD, D1, D2	4, 6, 8	Aluminum or Copper	38.54	1-55.50 x 100
-W, WD, 5D, D1, D2	6, 8, 10	Aluminum	38.54	1-55.50 x 100
-W, 5A, 5W, D1	1, 2, 3	Aluminum or Copper	37.50	1-54 x 100
1-inch unit coil				
-NS (stacked)	1	Aluminum or Copper	35.42	1-33 x 100 1-18 x 100
1/2-inch modified coils				
-WL, LL, FD	2, 4, 6, 8	Aluminum	25.17	1-36.25 x 100
5/8-inch modified coils				
-W, WD, 5A, 5W, D1, D2	1, 2, 3, 4, 6, 8	Aluminum or Copper	25.00	1-36 x 100
-W, WD, D1, D2	10	Aluminum	25.00	1-36 x 100
1-inch modified coil				
-NS (stacked)	1	Aluminum or Copper	25.00	2-18 x 100
Multizone coils				
-5A, 5W, NS	1, 2	Aluminium or Copper	20.83	1-30 x 100
-WL	2	Aluminum	20.83	1-30 x 100

Table 94. Fan data for unit size 40

Size/Type Fan name	Housed Fans - Low Pressure					
	28-in. FC 28FA	25-in. FC 25FA	22-in. FC 22FA	28-in. AF 28AA	25-in. AF 25AA	22-in. AF 22AA
Max rpm	750	850	950	1500	1650	1900
ODP NEMA Premium motor hp range	7.5-25	7.5-20	7.5-20	7.5-20	7.5-20	7.5-15
Outlet area (ft ²)	8.81	6.95	5.54	8.81	6.95	5.54
Bearing/Shaft size (in.)	1.94	1.69	1.50	1.94	1.69	1.50
Size/Type Fan name	High Pressure - High Pressure					
	28-in. FC 28FB	25-in. FC 25FB	22-in. FC 22FB	28-in. AF 28AB	25-in. AF 25AB	22-in. AF 22AB
Max rpm	860	1025	1200	2050	2200	2500
ODP NEMA Premium motor hp range	7.5-40	7.5-40	7.5-30	7.5-50	7.5-50	7.5-50
Outlet area (ft ²)	8.81	6.95	5.54	8.81	6.95	5.54
Bearing/Shaft size (in.)	2.44	2.44	2.00	2.19	2.00	2.00
Size/Type Fan name	Belt-drive Plenum Fans				Direct-Drive Plenum Fans	
	Low Pressure		High Pressure		High Pressure	
	40-in. AF 40PA	36-in. AF 36PA	40-in. AF 40PB	36-in. AF 36PB	2-27-in AF Reduced Width 27NR	2-27-in AF Nominal Width 27NF
Max rpm	1150	1350	1400	1600	2035	2035
ODP NEMA Premium motor hp range	7.5-30	7.5-30	7.5-50	7.5-50	5-20	7.5-25
Outlet area (ft ²)	n/a	n/a	n/a	n/a	n/a	n/a
Bearing/Shaft size (in.)	2.44	2.44	2.19	2.19	n/a	n/a



General Data

Unit Size 41

Table 95. Section dimensions (inches) and weights (pounds) - unit size 41

Nominal airflow	20,500	
Airflow at 625 fpm	30,138	
Height - indoor unit (in.)	104.00	
Width (in.)	80.00	
Height - outdoor unit (in.) includes base drip lip	Available for indoor use only	
Weight add for outdoor unit (lbs./in. of unit length)	n/a	n/a
Section type	Length (in.)	Weight (lb.)
Access or blank		
-Small horizontal	10.00	224.38
-Medium horizontal	14.00	257.35
-Extended-medium horizontal	19.00	298.56
-Medium-large horizontal	29.50	343.89
-Large horizontal or turning	46.00	561.11
-Extra-large horizontal or turning	n/a	n/a
-Ducted inlet or ducted outlet section	10.00	224.40
Blender	48.00	616.31
Cool Dry Quiet (CDQ) Desiccant Dehumidification Section	n/a	n/a
Coils		
-Small horizontal (with 4-row UW)	10.00	792.51
-Medium horizontal (with 8-row UW)	14.00	1290.73
-Extended-medium horizontal (with 8-row UW)	19.00	1337.01
-Medium-large horizontal (with 10-row W)	29.50	2355.51
-Large horizontal or vertical (with 10-row W)	46.00	2508.26
-Electric Heat Coil	n/a	n/a
-Integral-face-and-bypass (IFB) coil		
--Less than 4 rows	29.50	1449.00
--4 rows	43.00	2196.84
Controls section (includes largest available VFD)	28.50	698.00
Diffuser	24.50	341.54
Discharge plenum		
-Horizontal	46.00	682.71
-Vertical	n/a	n/a
Energy Wheel	n/a	n/a
Face-and-Bypass Dampers		
-Face-and-bypass	19.00	296.21
-External face-and-bypass	27.75	368.32
-Internal face-and-bypass or face damper only	19.00	296.21
Fan		
-Belt-drive plenum (BDP) fan with motor	n/a	n/a
-Housed fan FC with motor	80.50	2771.01
-Housed AF/BC fans with motor	80.50	2863.54
-Direct-drive plenum fan with motor	80.50	3039.54
Filters		
-Side load 2-in. angled	24.50	652.32
-Side load 4-in. angled	24.50	663.25
-Side load cartridge 12-in. or short bag 18-in.	24.50	762.69

Table 95. Section dimensions (inches) and weights (pounds) - unit size 41

Filters	Length (in.)	Weight (lb.)
-Side load 2-in. flat	14.00	358.29
-Side load 4-in. flat	14.00	404.69
-Side load 2-in. and 4-in. combination flat	19.00	570.61
-Long bag 30-in.	37.25	803.00
-Front-load HEPA	40.00	1268.00
-Front-load cartridge	40.00	931.00
-Front-load short bag	45.00	885.00
Gas heat	n/a	n/a
Humidifier		
-Building Steam	14.00	684.00
-Atmospheric	19.00	570.00
Mixing box		
-with angled filters	46.00	565.81
-with front/back Traq and top Traq dampers	n/a	n/a
- reduced length mixing box with side/top/back/bottom airfoil damper	n/a	n/a
Multizone	n/a	n/a
Silencer		
-3 feet	38.00	1013.00
-5 feet	62.00	1558.00
Trane Catalytic Air Cleaning System (TCACS)	36.00	946.00
UV light	n/a	n/a

Table 96. Filter data for unit size 41

Filter Type	Area ft ²	Qty-Size (in.)
Flat (2-in., 4-in., and 2-in/4-in high efficiency) pleated, permanent, throwaway media	40.83	8 - 20x20
		2 - 20x25
		4 - 16x20
		1 - 16x25
Angled (2-in. or 4-in.) Pleated, permanent, throwaway media	70.00	6 - 16x25
		24 - 16x20
Side load bag or cartridge	36.00	8 - 24x24 2 - 24x12
Front load bag or cartridge	40.00	4 - 12x24
		8 - 24x24
Front load HEPA	37.00	3 - 24x30
		1 - 24x12
		4 - 30x24

Note: 2-inch filters available in permanent, throwaway, or pleated media; 4-inch filters available in pleated media, 65%, 85%, or 95% efficiency; Bag or cartridge filters available in 65%, 85%, or 95% efficiency.

Table 97. Coil availability - size 41

Section Type	1/2-in Unit Coils	5/8-in Unit Coils, 1/2-in and 5/8-in Modified Coils
Small	2 rows	1-2 rows
Medium	2-6 rows (4 row cooling)	1-4 rows without IDP
Extended-medium	2-8 rows	1-8 rows without IDP
Medium-large	2-8 rows	1-10 rows
-with access	2-8 rows	1-6 rows
Large horizontal	2-8 rows	1-10 rows
-with access	2-8 rows	1-10 rows
Large vertical	n/a	n/a
-with access	n/a	n/a



General Data

Table 98. Coil data for unit size 41

Coil Type	Rows	Fin Type	Area ft ²	Qty-Size (in.)
1/2-inch unit coils				
-UA, UW, UF, UU (stacked)	2, 4, 6, 8	Aluminum	40.94	2-45 x 65.50
5/8-inch unit coils				
-W, WD, 5A, 5W, D1, D2 (stacked)	1, 2, 3, 4, 6, 8, 10	Aluminum or Copper	41.25	2-45 x 66
-W, 5D (stacked)	6, 8, 10	Aluminum	41.25	2-45 x 66
1-inch unit coil				
-NS (stacked)	1	Aluminum or Copper	38.50	2-30 x 66 1-24 x 66
1/2-inch modified coils				
-WL, LL, FD (stacked)	2, 4, 6, 8	Aluminum	33.23	2-36.25 x 66
5/8-inch modified coils				
-W, WD, 5A, 5W, D1, D2	1, 2, 3, 4, 6, 8	Aluminum or Copper	33.00	2-36 x 66
-W, WD, D1, D2	10	Aluminum	33.00	2-36 x 66
1-inch modified coil				
-NS (stacked)	1	Aluminum or Copper	23.38	2-18 x 66 1-33 x 66
Multizone coils			n/a	n/a

Table 99. Fan data for unit size 41

Size/Type Fan name	Housed Fans - Low Pressure					
	28-in. FC 28FA	25-in. FC 25FA	22-in. FC 22FA	28-in. AF 28AA	25-in. AF 25AA	22-in. AF 22AA
Max rpm	750	850	950	1500	1650	1900
ODP NEMA Premium motor hp range	7.5-25	7.5-20	7.5-20	7.5-20	7.5-20	7.5-15
Outlet area (ft ²)	8.81	6.95	5.54	8.81	6.95	5.54
Bearing/Shaft size (in.)	1.94	1.69	1.50	1.94	1.69	1.50
Size/Type Fan name	Housed Fans - High Pressure					
	28-in. FC 28FB	25-in. FC 25FB	22-in. FC 22FB	28-in. AF 28AB	25-in. AF 25AB	22-in. AF 22AB
Max rpm	860	1025	1200	2050	2200	2500
ODP NEMA Premium motor hp range	7.5-40	7.5-40	7.5-30	7.5-50	7.5-50	7.5-50
Outlet area (ft ²)	8.81	6.95	5.54	8.81	6.95	5.54
Bearing/Shaft size (in.)	2.44	2.44	2.00	2.19	2.00	2.00
Size/Type Fan name	Belt-drive Plenum Fans				Direct-Drive Plenum Fans	
	Low Pressure		High Pressure		High Pressure	
	n/a	n/a	n/a	n/a	2-24-in AF Nominal Width	2-24.5-in AF Extended Width
Max rpm					2365	2365
ODP NEMA Premium motor hp range					5-25	5-25
Outlet area (ft ²)					n/a	n/a
Bearing/Shaft size (in.)					n/a	n/a

Unit Size 50

Table 100. Section dimensions (inches) and weights (pounds) - unit size 50

Nominal airflow	25,000	
Airflow at 625 fpm	34,375	
Height - indoor unit (in.)	75.75	
Width (in.)	125.50	
Height - outdoor unit (in.) includes base drip lip	84.38	
Weight add for outdoor unit (lbs./in. of unit length)	3.73	
Section type	Length (in.)	Weight (lb.)
Access or blank		
-Small horizontal	10.00	254.69
-Medium horizontal	14.00	290.28
-Extended-medium horizontal	19.00	334.76
-Medium-large horizontal	24.50	410.37
-Large horizontal or turning	48.00	639.24
-Extra-large horizontal or turning	68.50	809.42
-Ducted inlet or ducted outlet section	10.00	254.70
Blender	48.00	675.51
Cool Dry Quiet (CDQ) Desiccant Dehumidification Section	59.00	4224.00
Coils		
-Small horizontal (with 4-row UW)	10.00	934.27
-Medium horizontal (with 8-row UW)	14.00	1561.92
-Extended-medium horizontal (with 8-row UW)	19.00	1613.56
-Medium-large horizontal (with 10-row W)	24.50	2754.49
-Large horizontal or vertical (with 10-row W)	48.00	2985.19
-Electric Heat Coil	68.50	2267.00
-Integral-face-and-bypass (IFB) coil		
--Less than 4 rows	29.50	1793.80
--4 rows	n/a	n/a
Controls section (includes largest available VFD)	28.50	745.00
Diffuser	24.50	381.33
Discharge plenum		
-Horizontal	48.00	772.27
-Vertical	68.50	1136.53
Energy Wheel	65.00	3111.00
Face-and-Bypass Dampers		
-Face-and-bypass	19.00	630.10
-External face-and-bypass	22.00	740.29
-Internal face-and-bypass or face damper only	19.00	678.20
Fan		
-Belt-drive plenum (BDP) fan with motor	57.50	3263.68
-Housed fan FC with motor	68.50	3151.89
-Housed AF/BC fans with motor	68.50	3221.42
-Direct-drive plenum fan with motor	68.50	3469.95
Filters		
-Side load 2-in. angled	27.50	770.02
-Side load 4-in. angled	27.50	768.20
-Side load cartridge 12-in. or short bag 18-in.	27.50	878.57

General Data
Table 100. Section dimensions (inches) and weights (pounds) - unit size 50

Filters	Length (in.)	Weight (lb.)
-Side load 2-in. flat	14.00	408.69
-Side load 4-in. flat	14.00	451.33
-Side load 2-in. and 4-in. combination flat	19.00	600.40
-Long bag 30-in.	37.25	827.00
-Front-load HEPA	40.00	1397.00
-Front-load cartridge	40.00	1093.00
-Front-load short bag	45.00	917.00
Gas heat		
- 200 MBH	n/a	n/a
- 300 MBH	n/a	n/a
- 360 MBH	n/a	n/a
- 560 MBH	64.00	1853.50
- 700 MBH	74.00	2190.50
- 860 MBH	74.00	2280.50
- 1000 MBH	77.00	2325.60
- 1250-1750 MBH	106.00	3264.80
- 2000 MBH	114.00	3758.70
Humidifier		
-Building Steam	14.00	782.00
-Atmospheric	19.00	724.00
Mixing box		
-with angled filters	48.00	653.36
-with front/back Traq and top Traq dampers	68.50	1261.78
-reduced length mixing box with side/top/back/bottom airfoil damper	41.50	947.60
Multizone		
- 3-deck vertical discharge	96.00	5739.00
- 2-deck vertical discharge	96.00	3986.00
- 3-deck horizontal discharge	78.00	5276.00
- 2-deck horizontal discharge	78.00	3633.00
Silencer		
-3 feet	38.00	1226.00
-5 feet	62.00	1795.00
Trane Catalytic Air Cleaning System (TCACS)	36.00	1044.00
UV light	14.00	394.34
SECTIONS BELOW ARE FOR OUTDOOR UNITS ONLY		
Diagonal economizer		
-with airfoil dampers	72.00	1120.00
-with airfoil damper and one side Traq damper	72.00	1169.00
Exhaust damper section	24.50	565.60
Hoods		
- Back inlet hood - airfoil and Traq	125.38	230.00
- Side inlet hood - airfoil and Traq	44.75	161.00
- Exhaust hood - airfoil	39.63	93.00
- Economizer inlet hood	72.00	358.00

Table 100. Section dimensions (inches) and weights (pounds) - unit size 50

Pipe Cabinets	Length (in.)	Weight (lb.)
15 in. long - 24-in. depth	15.00	142.00
15 in. long - 36-in. depth	15.00	191.00
15 in. long - 48-in. depth	15.00	239.00
24 in. long - 24-in. depth	24.00	164.00
24 in. long - 36-in. depth	24.00	216.00
24 in. long - 48-in. depth	24.00	268.00
48 in. long - 24-in. depth	48.00	224.00
48 in. long - 36-in. depth	48.00	284.00
48 in. long - 48-in. depth	48.00	345.00
96 in. long - 24-in. depth	96.00	344.00
96 in. long - 36-in. depth	96.00	421.00
96 in. long - 48-in. depth	96.00	498.00

Table 101. Filter data for unit size 50

Filter Type	Area (ft ²)	Qty-Size (in.)
Flat (2-in., 4-in., and 2-in/4-in high efficiency) pleated, permanent, throwaway media	55.00	12 - 25x20
		4 - 16x25
		1 - 16x20
Angled (2-in. or 4-in.) Pleated, permanent, throwaway media	100.00	36 - 20x20
Side load bag or cartridge	50.00	10 - 24x24
		5 - 12x24
Front load bag or cartridge	50.00	5 - 12x24
		10 - 24x24
		3 - 24x30
		1 - 24x24
Front load HEPA	46.00	3 - 24x30
		1 - 24x24
		4 - 12x24

Note: 2-inch filters available in permanent, throwaway, or pleated media; 4-inch filters available in pleated media, 65%, 85%, or 95% efficiency; Bag or cartridge filters available in 65%, 85%, or 95% efficiency.

Table 102. Coil availability - size 50

Section Type	5/8-in Unit Coils,	
	1/2-in Unit Coils	1/2-in and 5/8-in Modified Coils
Small	2 rows	1-2 rows
Medium	2-4 rows	1-3 rows
Extended-medium	2-8 rows	1-6 rows
Medium-large	2-8 rows	1-8 rows
-with access	2-4 rows	n/a
Large horizontal	2-8 rows	1-8 rows
-with access	2-8 rows	1-10 rows
Large vertical	2-8 rows	1-6 rows
-with access	2-8 rows	1-6 rows



General Data

Table 103. Coil data for unit size 50

Coil Type	Rows	Fin Type	Area ft ²	Qty-Size (in.)
1/2-inch unit coils				
-UA, UW, UF, UU (stacked)	2, 4, 6, 8	Aluminum	49.05	2-31.25 x 113
5/8-inch unit coils				
-W, WD, D1, D2 (stacked)	4, 6, 8, 10	Aluminum	48.26	1-27 x 113 1-34.50 x 113
-W, WD, D1, D2 (stacked)	4, 6, 8	Copper	48.26	1-27 x 113 1-34.50 x 113
-W, 5A, 5W, D1 (stacked)	1, 2, 3	Aluminum or Copper	47.08	1-27 x 113 1-33 x 113
1-inch unit coil				
-NS (stacked)	1	Aluminum or Copper	47.08	2-30 x 113
1/2-inch modified coils				
-WL, LL, FD	2, 4, 6, 8	Aluminum	33.35	1-42.50 x 113
5/8-inch modified coils				
-W, WD, 5A, 5W, D1, D2	1, 2, 3, 4, 6, 8, 10	Aluminum or Copper	35.31	1-45 x 113
1-inch modified coil				
-NS (stacked)	1	Aluminum or Copper	32.96	1-24 x 113 1-18 x 113
Multizone coils				
-5A, 5W, NS	1, 2	Aluminium or Copper	25.90	1-33 x 113
-WL	2	Aluminum	25.90	1-33 x 113

Table 104. Fan data for unit size 50

Size/Type Fan name	Housed Fans - Low Pressure					
	32-in. FC 32FA	28-in. FC 28FA	25-in. FC 25FA	32-in. AF 32AA	28-in. AF 28AA	25-in. AF 25AA
Max rpm	675	750	850	1300	1500	1650
ODP NEMA Premium motor hp range	7.5-30	7.5-25	7.5-20	7.5-30	7.5-20	7.5-20
Outlet area (ft ²)	11.11	8.81	6.95	11.11	8.81	6.95
Bearing/Shaft size (in.)	2.19	1.94	1.69	2.19	1.94	1.69
Size/Type Fan name	Housed Fans - High Pressure					
	32-in. FC 32FB	28-in. FC 28FB	25-in. FC 25FB	32-in. AF 32AB	28-in. AF 28AB	25-in. AF 25AB
Max rpm	760	860	1025	1700	2050	2200
ODP NEMA Premium motor hp range	7.5-50	7.5-40	7.5-40	7.5-60	7.5-60	7.5-50
Outlet area (ft ²)	11.11	8.81	6.95	11.11	8.81	6.95
Bearing/Shaft size (in.)	2.19	2.44	2.44	2.19	2.19	2.00
Size/Type Fan name	Belt-drive Plenum Fans				Direct-Drive Plenum Fans	
	Low Pressure		High Pressure		High Pressure 2-30-inAF Reduced Width	High Pressure 2-30-inAF Nominal Width
	40-in. AF 40PA	36-in. AF 36PA	40-in. AF 40PB	36-in. AF 36PB	30NR	30NF
Max rpm	1150	1350	1400	1600	1851	1851
ODP NEMA Premium motor hp range	7.5-30	7.5-30	7.5-75	7.5-60	10-30	10-30
Outlet area (ft ²)	n/a	n/a	n/a	n/a	n/a	n/a
Bearing/Shaft size (in.)	2.44	2.44	2.19	2.19	n/a	n/a

Unit Size 51

Table 105. Section dimensions (inches) and weights (pounds) - unit size 51

Nominal airflow	25,500	
Airflow at 625 fpm	34,306	
Height - indoor unit (in.)	104.00	
Width (in.)	93.50	
Height - outdoor unit (in.) includes base drip lip	Available for indoor use only	
Weight add for outdoor unit (lbs./in. of unit length)	n/a	n/a
Section type	Length (in.)	Weight (lb.)
Access or blank		
-Small horizontal	10.00	242.54
-Medium horizontal	14.00	277.55
-Extended-medium horizontal	19.00	321.32
-Medium-large horizontal	29.50	369.46
-Large horizontal or turning	46.00	615.72
-Extra-large horizontal or turning	n/a	n/a
-Ducted inlet or ducted outlet section	10.00	242.50
Blender	48.00	656.33
Cool Dry Quiet (CDQ) Desiccant Dehumidification Section	n/a	n/a
Coils		
-Small horizontal (with 4-row UW)	10.00	922.65
-Medium horizontal (with 8-row UW)	14.00	1523.08
-Extended-medium horizontal (with 8-row UW)	19.00	1572.75
-Medium-large horizontal (with 10-row W)	29.50	2791.28
-Large horizontal or vertical (with 10-row W)	46.00	2955.21
-Electric Heat Coil	n/a	n/a
-Integral-face-and-bypass (IFB) coil		
--Less than 4 rows	29.50	1640.15
--4 rows	n/a	n/a
Controls section (includes largest available VFD)	28.50	747.00
Diffuser	24.50	367.11
Discharge plenum		
-Horizontal	46.00	745.34
-Vertical	n/a	n/a
Energy Wheel	n/a	n/a
Face-and-Bypass Dampers		
-Face-and-bypass	19.00	318.97
-External face-and-bypass	27.75	395.56
-Internal face-and-bypass or face damper only	19.00	318.97
Fan		
-Belt-drive plenum (BDP) fan with motor	n/a	n/a
-Housed fan FC with motor	88.00	3312.75
-Housed AF/BC fans with motor	88.00	3382.28
-Direct-drive plenum fan with motor	88.00	4268.88
Filters		
-Side load 2-in. angled	24.50	688.86
-Side load 4-in. angled	24.50	747.25
-Side load cartridge 12-in. or short bag 18-in.	24.50	874.81



General Data

Table 105. Section dimensions (inches) and weights (pounds) - unit size 51

Filters	Length (in.)	Weight (lb.)
-Side load 2-in. flat	14.00	392.33
-Side load 4-in. flat	14.00	461.82
-Side load 2-in. and 4-in. combination flat	19.00	646.20
-Long bag 30-in.	37.25	883.00
-Front-load HEPA	40.00	1450.00
-Front-load cartridge	40.00	1062.00
-Front-load short bag	45.00	969.00
Gas heat	n/a	n/a
Humidifier		
-Building Steam	14.00	773.00
-Atmospheric	19.00	683.00
Mixing box		
-with angled filters	46.00	629.45
-with front/back Traq and top Traq dampers	n/a	n/a
- reduced length mixing box with side/top/back/bottom airfoil damper	n/a	n/a
Multizone	n/a	n/a
Silencer		
-3 feet	38.00	1142.00
-5 feet	62.00	1759.00
Trane Catalytic Air Cleaning System (TCACS)	36.00	1044.00
UV light	n/a	n/a

Table 106. Filter data for unit size 51

Filter Type	Area ft ²	Qty-Size (in.)
Flat (2-in., 4-in., and 2-in/4-in high efficiency) pleated, permanent, throwaway media	55.00	12 - 25x20
		4 - 16x25
		1 - 16x20
Angled (2-in. or 4-in.) Pleated, permanent, throwaway media	100.00	36 - 20x20
Side load bag or cartridge	50.00	10 - 24x24
		5 - 12x24
Front load bag or cartridge	50.00	5 - 12x24
		10 - 24x24
		3 - 24x30
Front load HEPA	46.00	1 - 24x24
		3 - 24x30
		1 - 24x24
		4 - 12x24

Note: 2-inch filters available in permanent, throwaway, or pleated media; 4-inch filters available in pleated media, 65%, 85%, or 95% efficiency; Bag or cartridge filters available in 65%, 85%, or 95% efficiency.

Table 107. Coil availability - size 51

Section Type	5/8-in Unit Coils,	
	1/2-in Unit Coils	1/2-in and 5/8-in Modified Coils
Small	2 rows	1-2 rows
Medium	2-6 rows (4 row cooling)	1-4 rows without IDP
Extended-medium	2-8 rows	1-8 rows without IDP
Medium-large	2-8 rows	1-10 rows
-with access	2-8 rows	1-6 rows
Large horizontal	2-8 rows	1-10 rows
-with access	2-8 rows	1-10 rows
Large vertical	n/a	n/a

Table 108. Coils data for unit size 51

Coil Type	Rows	Fin Type	Area ft ²	Qty-Size (in.)
1/2-inch unit coils				
-UA, UW, UF, UU (stacked)	2, 4, 6, 8	Aluminum	50.00	2-45 x 80
5/8-inch unit coils				
-W, WD, 5A, 5W, D1, D2 (stacked)	1, 2, 3, 4, 6, 8, 10	Aluminum or Copper	50.00	2-45 x 80
-W, WD, 5D, D1, D2 (stacked)	6, 8, 10	Aluminum	50.00	2-45 x 80
1-inch unit coil				
-NS (stacked)	1	Aluminum or Copper	46.67	2-30 x 80 1-24 x 80
1/2-inch modified coils				
-WL, LL, FD (stacked)	2, 4, 6, 8	Aluminum	40.28	2-36.25 x 80
5/8-inch modified coils				
-W, WD, 5A, 5W, D1, D2 (stacked)	1, 2, 3, 4, 6, 8	Aluminum or Copper	40.00	2-36 x 80
-W, WD, D1, D2 (stacked)	10	Aluminum	40.00	2-36 x 80
1-inch modified coil				
-NS (stacked)	1	Aluminum or Copper	38.33	2-18 x 80 1-33 x 80
Multizone coils			n/a	n/a

Table 109. Fan data for unit size 51

Size/Type Fan name	Housed Fans - Low Pressure					
	32-in. FC 32FA	28-in. FC 28FA	25-in. FC 25FA	32-in. AF 32AA	28-in. AF 28AA	25-in. AF 25AA
Max rpm	675	750	850	1300	1500	1650
ODP NEMA Premium motor hp range	7.5-30	7.5-25	7.5-20	7.5-30	7.5-20	7.5-20
Outlet area (ft ²)	11.11	8.81	6.95	11.11	8.81	6.95
Bearing/Shaft size (in.)	2.19	1.94	1.69	2.19	1.94	1.69
Size/Type Fan name	Housed Fans - High Pressure					
	32-in. FC 32FB	28-in. FC 28FB	25-in. FC 25FB	32-in. AF 32AB	28-in. AF 28AB	25-in. AF 25AB
Max rpm	760	860	1025	1700	2050	2200
ODP NEMA Premium motor hp range	7.5-50	7.5-40	7.5-40	7.5-60	7.5-60	7.5-50
Outlet area (ft ²)	11.11	8.81	6.95	11.11	8.81	6.95
Bearing/Shaft size (in.)	2.19	2.44	2.44	2.19	2.19	2.00
Size/Type Fan name	Belt-drive Plenum Fans			Direct-Drive Plenum Fans		
	Low Pressure		High Pressure	High Pressure		
	n/a	n/a	n/a	n/a	4-22-inAF Reduced Width	4-22-inAF Nominal Width
					22SR	22SF
Max rpm					2675	2675
ODP NEMA Premium motor hp range					3-20	3-20
Outlet area (ft ²)					n/a	n/a
Bearing/Shaft size (in.)					n/a	n/a



General Data

Unit Size 57

Table 110. Section dimensions (inches) and weights (pounds) - unit size 57

Nominal airflow	28,500	
Airflow at 625 fpm	39,581	
Height - indoor unit (in.)	85.50	
Width (in.)	125.50	
Height - outdoor unit (in.) includes base drip lip	94.13	
Weight add for outdoor unit (lbs./in. of unit length)	6.12	
Section type	Length (in.)	Weight (lb.)
Access or blank		
-Small horizontal	10.00	265.35
-Medium horizontal	14.00	302.41
-Extended-medium horizontal	19.00	348.74
-Medium-large horizontal	24.50	427.50
-Large horizontal or turning	48.00	682.26
-Extra-large horizontal or turning	n/a	n/a
-Ducted inlet or ducted outlet section	10.00	265.30
Blender	48.00	731.75
Cool Dry Quiet (CDQ) Desiccant Dehumidification Section	n/a	n/a
Coils		
-Small horizontal (with 4-row UW)	10.00	1044.33
-Medium horizontal (with 8-row UW)	14.00	1759.58
-Extended-medium horizontal (with 8-row UW)	19.00	1813.06
-Medium-large horizontal (with 10-row W)	24.50	3215.01
-Large horizontal or vertical (with 10-row W)	48.00	3454.40
-Electric Heat Coil	48.00	2297.00
-Integral-face-and-bypass (IFB) coil		
--Less than 4 rows	29.50	1956.80
--4 rows	n/a	n/a
Controls section (includes largest available VFD)	28.50	787.00
Diffuser	24.50	397.35
Discharge plenum		
-Horizontal	48.00	821.10
-Vertical	n/a	n/a
Energy Wheel	n/a	n/a
Face-and-Bypass Dampers		
-Face-and-bypass	19.00	714.61
-External face-and-bypass	22.00	831.66
-Internal face-and-bypass or face damper only	19.00	714.61
Fan		
-Belt-drive plenum (BDP) fan with motor	59.50	3599.82
-Housed fan FC with motor	68.50	3235.63
-Housed AF/BC fans with motor	68.50	3305.16
-Direct-drive plenum fan with motor	68.50	3545.86
Filters		
-Side load 2-in. angled	27.50	797.89
-Side load 4-in. angled	27.50	805.97
-Side load cartridge 12-in. or short bag 18-in.	27.50	934.14

Table 110. Section dimensions (inches) and weights (pounds) - unit size 57

Filters	Length (in.)	Weight (lb.)
-Side load 2-in. flat	14.00	438.52
-Side load 4-in. flat	14.00	498.71
-Side load 2-in. and 4-in. combination flat	19.00	671.64
-Long bag 30-in.	37.25	907.00
-Front-load HEPA	40.00	1520.00
-Front-load cartridge	40.00	1174.00
-Front-load short bag	45.00	980.00
Gas heat		
- 200 MBH	n/a	n/a
- 300 MBH	n/a	n/a
- 360 MBH	n/a	n/a
- 560 MBH	64.00	1900.50
- 700 MBH	74.00	2241.90
- 860 MBH	74.00	2331.90
- 1000 MBH	77.00	2082.90
- 1250-1750 MBH	106.00	2942.80
- 2000 MBH	114.00	3430.30
Humidifier		
-Building Steam	14.00	897.00
-Atmospheric	19.00	803.00
Mixing box		
-with angled filters	48.00	653.36
-with front/back Traq and top Traq dampers	68.50	1365.59
- reduced length mixing box with side/top/back/bottom airfoil damper	41.50	1022.70
Multizone		
	n/a	n/a
Silencer		
-3 feet	38.00	1332.00
-5 feet	62.00	1945.00
Trane Catalytic Air Cleaning System (TCACS)		
	36.00	1148.00
UV light		
	14.00	419.43
SECTIONS BELOW ARE FOR OUTDOOR UNITS ONLY		
Diagonal economizer		
-with airfoil dampers	76.00	1223.00
-with airfoil damper and one side Traq damper	76.00	1266.00
Exhaust damper section		
	22.40	586.60
Hoods		
- Back inlet hood - airfoil and Traq	125.38	270.00
- Side inlet hood - airfoil and Traq	37.25	174.00
- Exhaust hood - airfoil	37.25	114.00
- Economizer inlet hood	75.50	345.00
Pipe Cabinets		
15 in. long - 24-in. depth	15.00	155.00
15 in. long - 36-in. depth	15.00	209.00
15 in. long - 48-in. depth	15.00	262.00
24 in. long - 24-in. depth	24.00	179.00
24 in. long - 36-in. depth	24.00	236.00
24 in. long - 48-in. depth	24.00	292.00



General Data

Table 110. Section dimensions (inches) and weights (pounds) - unit size 57

Pipe Cabinets	Length (in.)	Weight (lb.)
48 in. long - 24-in. depth	48.00	244.00
48 in. long - 36-in. depth	48.00	309.00
48 in. long - 48-in. depth	48.00	373.00
96 in. long - 24-in. depth	96.00	373.00
96 in. long - 36-in. depth	96.00	454.00
96 in. long - 48-in. depth	96.00	536.00

Table 111. Filter data for unit size 57

Filter Type	Area ft ²	Qty-Size (in.)
Flat (2-in., 4-in., and 2-in/4-in high efficiency) pleated, permanent, throwaway media	63.33	12 - 20x25
		3 - 20x20
		4 - 16x25
		1 - 16x20
Angled (2-in. or 4-in.) Pleated, permanent, throwaway media	100.00	36 - 20x20
Side load bag or cartridge	60.00	15 - 24x24
Front load bag or cartridge	60.00	15 - 24x24
Front load HEPA	57.00	3 - 24x30
		1 - 24x24
		3 - 24x30
		1 - 24x24
		3 - 24x30

Note: 2-inch filters available in permanent, throwaway, or pleated media; 4-inch filters available in pleated media, 65%, 85%, or 95% efficiency; Bag or cartridge filters available in 65%, 85%, or 95% efficiency.

Table 112. Coil availability - size 57

Section Type	5/8-in Unit Coils,	
	1/2-in Unit Coils	1/2-in and 5/8-in Modified Coils
Small	2 rows	1-2 rows
Medium	2-4 rows	1-3 rows
Extended-medium	2-8 rows	1-6 rows
Medium-large	2-8 rows	1-8 rows
-with access	2-4 rows	n/a
Large horizontal	2-8 rows	1-8 rows
-with access	2-8 rows	1-10 rows

Table 113. Coil data for unit size 57

Coil Type	Rows	Fin Type	Area ft ²	Qty-Size (in.)
1/2-inch unit coils				
-UA, UW, UF, UU (stacked)	2, 4, 6, 8	Aluminum	56.89	2-36.25 x 113
5/8-inch unit coils				
-W, WD, 5A, 5W, D1, D2 (stacked)	1, 2, 3, 4, 6, 8	Aluminum or Copper	56.50	2-36 x 113
-W, WD, D1, D2 (stacked)	10	Aluminum	56.50	2-36 x 113
1-inch unit coil				
-NS (stacked)	1	Aluminum or Copper	51.79	1-30 x 113 2-18 x 113
1/2-inch modified coils				
-WL, LL	2, 4, 6, 8	Aluminum	43.16	1-55 x 113
-FD (stacked)	4 to 6	Aluminum	44.14	1-31.25 x 113 1-25 x 113
5/8-inch modified coils				
-W, WD, 5A, 5W, D1, D2	1, 2, 3, 4, 6, 8	Aluminum or Copper	42.38	1-54 x 113
-W, WD, D1, D2	10	Aluminum	42.38	1-54 x 113
1-inch modified coil				
-NS (stacked)	1	Aluminum or Copper	42.38	1-30 x 113 1-24 x 113
Multizone coils			n/a	n/a

Table 114. Fan data for unit size 57

Size/Type Fan name	Housed Fans -Low Pressure					
	32-in. FC 32FA	28-in. FC 28FA	25-in. FC 25FA	32-in. AF 32AA	28-in. AF 28AA	25-in. AF 25AA
Max rpm	675	750	850	1300	1500	1650
ODP NEMA Premium motor hp range	7.5-30	7.5-25	7.5-20	7.5-30	7.5-20	7.5-20
Outlet area (ft ²)	11.11	8.81	6.95	11.11	8.81	6.95
Bearing/Shaft size (in.)	2.19	1.94	1.69	2.19	1.94	1.69
Size/Type Fan name	Housed Fans - High Pressure					
	32-in. FC 32FB	28-in. FC 28FB	25-in. FC 25FB	32-in. AF 32AB	28-in. AF 28AB	25-in. AF 25AB
Max rpm	760	860	1025	1700	2050	2200
ODP NEMA Premium motor hp range	7.5-60	7.5-40	7.5-40	7.5-60	7.5-60	7.5-50
Outlet area (ft ²)	11.11	8.81	6.95	11.11	8.81	6.95
Bearing/Shaft size (in.)	2.19	2.44	2.44	2.19	2.19	2.00
Size/Type Fan name	Belt-drive Plenum Fans				Direct-Drive Plenum Fans	
	Low Pressure		High Pressure		High Pressure	
	44-in. AF 44PA	40-in. AF 40PA	44-in. AF 44PB	40-in. AF 40PB	2-30-in AF Reduced Width 30NR	2-30-in AF Nominal Width 30NF
	Max rpm	1100	1150	1200	1400	1851
ODP NEMA Premium motor hp range	7.5-60	7.5-30	7.5-75	7.5-75	10-30	10-30
Outlet area (ft ²)	n/a	n/a	n/a	n/a	n/a	n/a
Bearing/Shaft size (in.)	2.19	2.44	2.44	2.19	n/a	n/a



General Data

Unit Size 58

Table 115. Section dimensions (inches) and weights (pounds) - unit size 58

Nominal airflow	29,000	
Airflow at 625 fpm	38,194	
Height - indoor unit (in.)	116.25	
Width (in.)	93.50	
Height - outdoor unit (in.) includes base drip lip	Available for indoor use only	
Weight add for outdoor unit (lbs./in. of unit length)	n/a	n/a
Section type	Length (in.)	Weight (lb.)
Access or blank		
-Small horizontal	10.00	255.92
-Medium horizontal	14.00	292.80
-Extended-medium horizontal	19.00	338.89
-Medium-large horizontal	29.50	389.59
-Large horizontal or turning	46.00	661.42
-Extra-large horizontal or turning	n/a	n/a
-Ducted inlet or ducted outlet section	10.00	255.90
Blender	48.00	718.81
Cool Dry Quiet (CDQ) Desiccant Dehumidification Section	n/a	n/a
Coils		
-Small horizontal (with 4-row UW)	10.00	1014.74
-Medium horizontal (with 8-row UW)	14.00	1686.19
-Extended-medium horizontal (with 8-row UW)	19.00	1738.19
-Medium-large horizontal (with 10-row W)	29.50	3116.00
-Large horizontal or vertical (with 10-row W)	46.00	3287.59
-Electric Heat Coil	n/a	n/a
-Integral-face-and-bypass (IFB) coil		
--Less than 4 rows	29.50	1817.25
--4 rows	n/a	n/a
Controls section (includes largest available VFD)	28.50	790.00
Diffuser	24.50	387.24
Discharge plenum		
-Horizontal	46.00	798.32
-Vertical	n/a	n/a
Energy Wheel	n/a	n/a
Face-and-Bypass Dampers		
-Face-and-bypass	19.00	336.54
-External face-and-bypass	27.75	417.20
-Internal face-and-bypass or face damper only	19.00	336.54
Fan		
-Belt-drive plenum (BDP) fan with motor	n/a	n/a
-Housed fan FC with motor	88.00	3414.05
-Housed AF/BC fans with motor	88.00	3483.58
-Direct-drive plenum fan with motor	88.00	4349.06
Filters		
-Side load 2-in. angled	24.50	777.14
-Side load 4-in. angled	24.50	778.73
-Side load cartridge 12-in. or short bag 18-in.	24.50	980.36

Table 115. Section dimensions (inches) and weights (pounds) - unit size 58

Filters	Length (in.)	Weight (lb.)
-Side load 2-in. flat	14.00	426.12
-Side load 4-in. flat	14.00	476.21
-Side load 2-in. and 4-in. combination flat	19.00	667.97
-Long bag 30-in.	37.25	945.00
-Front-load HEPA	40.00	1561.00
-Front-load cartridge	40.00	1169.00
-Front-load short bag	45.00	1049.00
Gas heat	n/a	n/a
Humidifier		
-Building Steam	14.00	807.00
-Atmospheric	19.00	742.00
Mixing box		
-with angled filters	46.00	675.14
-with front/back Traq and top Traq dampers	n/a	n/a
- reduced length mixing box with side/top/back/bottom airfoil damper	n/a	n/a
Multizone	n/a	n/a
Silencer		
-3 feet	38.00	1312.00
-5 feet	62.00	2030.00
Trane Catalytic Air Cleaning System (TCACS)	36.00	1132.00
UV light	n/a	n/a

Table 116. Filter data for unit size 58

Filter Type	Area ft ²	Qty-Size (in.)
Flat (2-in., 4-in., and 2-in/4-in high efficiency) pleated, permanent, throwaway media	63.33	12 - 20x25
		3 - 20x20
		4 - 16x25
		1 - 16x20
Angled (2-in. or 4-in.) Pleated, permanent, throwaway media	100.00	36 - 20x20
Side load bag or cartridge	60.00	15 - 24x24
Front load bag or cartridge	60.00	15 - 24x24
Front load HEPA	57.00	3 - 24x30
		1 - 24x24
		3 - 24x30
		1 - 24x24
		1 - 24x24

Note: 2-inch filters available in permanent, throwaway, or pleated media; 4-inch filters available in pleated media, 65%, 85%, or 95% efficiency; Bag or cartridge filters available in 65%, 85%, or 95% efficiency.

Table 117. Coil availability - size 58

Section Type	1/2-in Unit Coils	5/8-in Unit Coils, 1/2-in and 5/8-in Modified Coils
Small	2 rows	1-2 rows
Medium	2-6 rows (4 row cooling)	1-4 rows without IDP
		1-3 rows with IDP
Extended-medium	2-8 rows	1-8 rows without IDP
		1-6 rows with IDP
Medium-large	2-8 rows	1-10 rows
-with access	2-8 rows	1-6 rows
Large horizontal	2-8 rows	1-10 rows
-with access	2-8 rows	1-10 rows
Large vertical	n/a	n/a



General Data

Table 118. Coil data for unit size 58

Coil Type	Rows	Fin Type	Area ft ²	Qty-Size (in.)
1/2-inch unit coils				
-UA, UW, UF, UU (stacked)	2, 4, 6, 8	Aluminum	56.89	1-57.50 x 80 1-43.75 x 80
5/8-inch unit coils				
-W, WD, 5A, 5W, D1, D2 (stacked)	1, 2, 3, 4, 6, 8, 10	Aluminum or Copper	56.67	2-51 x 80
-W, WD, 5D	6, 8, 10	Aluminum	56.67	2-51 x 80
1-inch unit coil				
-NS (stacked)	1	Aluminum or Copper	53.33	2-33 x 80 1-30 x 80
1/2-inch modified coils				
-WL, LL, FD (stacked)	2, 4, 6, 8	Aluminum	43.75	1-42.50 x 80 1-36.25 x 80
5/8-inch modified coils				
W, WD, 5A, 5W, D1, D2 (stacked)	1, 2, 3, 4, 6, 8	Aluminum or Copper	42.33	1-42 x 80 1-36 x 80
-W, WD, D1, D2 (stacked)	10	Aluminum	43.33	1-42 x 80 1-36 x 80
1-inch modified coil				
-NS (stacked)	1	Aluminum or Copper	43.33	1-30 x 80 2-24 x 80
Multizone coils			n/a	n/a

Table 119. Fan data for unit size 58

Size/Type Fan name	Housed Fans - Low Pressure					
	32-in. FC 32FA	28-in. FC 28FA	25-in. FC 25FA	32-in. AF 32AA	28-in. AF 28AA	25-in. AF 25AA
Max rpm	675	750	850	1300	1500	1650
ODP NEMA Premium motor hp range	7.5-30	7.5-25	7.5-20	7.5-30	7.5-20	7.5-20
Outlet area (ft ²)	11.11	8.81	6.95	11.11	8.81	6.95
Bearing/Shaft size (in.)	2.19	1.94	1.69	2.19	1.94	1.69
Size/Type Fan name	Housed Fans - High Pressure					
	32-in. FC 32FB	28-in. FC 28FB	25-in. FC 25FB	32-in. AF 32AB	28-in. AF 28AB	25-in. AF 25AB
Max rpm	760	860	1025	1700	2050	2200
ODP NEMA Premium motor hp range	7.5-60	7.5-40	7.5-40	7.5-60	7.5-60	7.5-50
Outlet area (ft ²)	11.11	8.81	6.95	11.11	8.81	6.95
Bearing/Shaft size (in.)	2.19	2.44	2.44	2.19	2.19	2.00
Size/Type Fan name	Belt-drive Plenum Fans				Direct-Drive Plenum Fans	
	Low Pressure		High Pressure		High Pressure	
	n/a	n/a	n/a	n/a	4-22-in AF Reduced Width 22SR	4-22-in AF Nominal Width 22SF
Max rpm					2675	2675
ODP NEMA Premium motor hp range					3-20	3-20
Outlet area (ft ²)					n/a	n/a
Bearing/Shaft size (in.)					n/a	n/a

Unit Size 66

Table 120. Section dimensions (inches) and weights (pounds) - unit size 66

Nominal airflow	33,000	
Airflow at 625 fpm	47,225	
Height - indoor unit (in.)	92.50	
Width (in.)	140.50	
Height - outdoor unit (in.) includes base drip lip	97.63	
Weight add for outdoor unit (lbs./in. of unit length)	2.57	
Section type	Length (in.)	Weight (lb.)
Access or blank		
-Small horizontal	10.00	289.35
-Medium horizontal	15.00	430.36
-Extended-medium horizontal	19.00	476.36
-Medium-large horizontal	24.50	574.11
-Large horizontal or turning	49.00	907.93
-Extra-large horizontal or turning	n/a	n/a
-Ducted inlet or ducted outlet section	10.00	372.90
Blender	49.00	970.30
Cool Dry Quiet (CDQ) Desiccant Dehumidification Section	n/a	n/a
Coils		
-Small horizontal (with 4-row UW)	n/a	n/a
-Medium horizontal (with 8-row UW)	15.00	2220.94
-Extended-medium horizontal (with 8-row UW)	19.00	2275.46
-Medium-large horizontal (with 10-row W)	24.50	3876.05
-Large horizontal or vertical (with 10-row W)	n/a	n/a
-Electric Heat Coil	49.00	2857.00
-Integral-face-and-bypass (IFB) coil		
--Less than 4 rows	29.50	2322.61
--4 rows	n/a	n/a
Controls section (includes largest available VFD)	28.50	964.00
Diffuser	27.50	571.76
Discharge plenum		
-Horizontal	49.00	1058.35
-Vertical	n/a	n/a
Energy Wheel		
	n/a	n/a
Face-and-Bypass Dampers		
-Face-and-bypass	19.00	888.33
-External face-and-bypass	39.00	1256.07
-Internal face-and-bypass or face damper only	19.00	888.33
Fan		
-Belt-drive plenum (BDP) fan with motor	61.00	4062.62
-Housed fan FC with motor	84.00	4201.67
-Housed AF/BC fans with motor	84.00	4311.38
-Direct-drive plenum fan with motor	84.00	4903.24
Filters		
-Side load 2-in. angled	27.50	989.00
-Side load 4-in. angled	27.50	999.89
-Side load cartridge 12-in. or short bag 18-in.	27.50	1239.99

General Data
Table 120. Section dimensions (inches) and weights (pounds) - unit size 66

Filters	Length (in.)	Weight (lb.)
-Side load 2-in. flat	15.00	598.12
-Side load 4-in. flat	15.00	657.87
-Side load 2-in. and 4-in. combination flat	19.00	853.08
-Long bag 30-in.	37.25	1095.00
-Front-load HEPA	40.00	1846.00
-Front-load cartridge	40.00	1449.00
-Front-load short bag	45.00	1231.000
Gas heat		
- 200 MBH	n/a	n/a
- 300 MBH	n/a	n/a
- 360 MBH	n/a	n/a
- 560 MBH	n/a	n/a
- 700 MBH	74.00	2490.60
- 860 MBH	74.00	2580.60
- 1000 MBH	74.00	2300.60
- 1250-1750 MBH	109.00	3309.40
- 2000 MBH	112.00	3688.30
- 2400 MBH	118.00	3890.30
Humidifier		
-Building Steam	15.00	1123.00
-Atmospheric	19.00	977.00
Mixing box		
-with angled filters	49.00	946.02
-with front/back Traq and top Traq dampers	84.00	1907.28
- reduced length mixing box with side/top/back/bottom airfoil damper	41.50	1328.50
Multizone	n/a	n/a
Silencer		
-3 feet	38.00	1573.00
-5 feet	62.00	2313.00
Trane Catalytic Air Cleaning System (TCACS)	36.00	1362.00
UV light	15.00	574.52
SECTIONS BELOW ARE FOR OUTDOOR UNITS ONLY		
Diagonal economizer		
-with airfoil dampers	83.00	1680.00
-with airfoil damper and one side Traq damper	83.00	1722.00
Exhaust damper section	22.40	755.30
Hoods		
- Back inlet hood - airfoil and Traq	126.00	317.00
- Side inlet hood - airfoil and Traq	37.25	189.00
- Exhaust hood - airfoil	37.25	129.00
- Economizer inlet hood	83.00	418.00
Pipe Cabinets		
15 in. long - 24-in. depth	15.00	160.00
15 in. long - 36-in. depth	15.00	215.00
15 in. long - 48-in. depth	15.00	270.00

Table 120. Section dimensions (inches) and weights (pounds) - unit size 66

Pipe Cabinets	Length (in.)	Weight (lb.)
24 in. long - 24-in. depth	24.00	185.00
24 in. long - 36-in. depth	24.00	243.00
24 in. long - 48-in. depth	24.00	301.00
48 in. long - 24-in. depth	48.00	251.00
48 in. long - 36-in. depth	48.00	317.00
48 in. long - 48-in. depth	48.00	384.00
96 in. long - 24-in. depth	96.00	383.00
96 in. long - 36-in. depth	96.00	466.00
96 in. long - 48-in. depth	96.00	549.00

Table 121. Filter data for unit size 66

Filter Type	Area ft²	Qty-Size (in.)
Flat (2-in., 4-in., and 2-in/4-in high efficiency) pleated, permanent, throwaway media	75.56	20 - 20x24
		4 - 20x16
Angled (2-in. or 4-in.) Pleated, permanent, throwaway media	113.33	36 - 20x20
		6 - 16x20
Side load bag or cartridge	66.67	20 - 20x24
Front load bag or cartridge	66.00	3 - 12x24
		15 - 24x24
		4 - 24x30
Front load HEPA	66.00	1 - 24x12
		4 - 24x30
		1 - 24x12
		4 - 24x30
		1 - 24x12

Note: 2-inch filters available in permanent, throwaway, or pleated media; 4-inch filters available in pleated media, 65%, 85%, or 95% efficiency; Bag or cartridge filters available in 65%, 85%, or 95% efficiency.

Table 122. Coil availability - size 66

Section Type	5/8-in Unit Coils	
	1/2-in Unit Coils	1/2-in and 5/8-in Modified Coils
Small	n/a	n/a
Medium	2-4 rows	1-3 rows
Extended-medium	2-8 rows	1-6 rows
Medium-large	2-8 rows	1-10 rows
-with access	n/a	n/a
Large horizontal	n/a	n/a
-with access	n/a	n/a
Large vertical	n/a	n/a
-with access	n/a	n/a



General Data

Table 123. Coils data for unit size 66

Coil Type	Rows	Fin Type	Area ft ²	Qty-Size (in.)
1/2-inch unit coils				
-UA, UW, UF, UU (stacked)	2, 4, 6, 8	Aluminum	65.63	2-37.50 x 126
5/8-inch unit coils				
-W, WD, D1, D (stacked)	4, 6, 8	Aluminum or Copper	65.63	2-37.50 x 126
-W, WD, D1, D2 (stacked)	10	Aluminum	65.63	2-37.50 x 126
-W, 5A, 5W, D1 (stacked)	1, 2, 3	Aluminum or Copper	65.63	1-42 x 126 1-33 x 126
1-inch unit coil				
-NS (stacked)	1	Aluminum or Copper	60.38	1-33 x 126 2-18 x 126
1/2-inch modified coils				
-WL, LL, FD (stacked)	2, 4, 6, 8	Aluminum	51.41	1-33.75 x 126 1-25 x 126
5/8-inch modified coils				
-W, WD, 5A, 5W, D1, D2 (stacked)	1, 2, 3, 4, 6, 8	Aluminum or Copper	49.88	1-33 x 126 1-24 x 126
W, WD, D1, D2 (stacked)	10	Aluminum	49.88	1-33 x 126 1-24 x 126
1-inch modified coil				
-NS (stacked)	1	Aluminum or Copper	49.88	1-33 x 126 1-24 x 126
Multizone coils			n/a	n/a

Table 124. Fan data for unit size 66

Size/Type Fan name	Housed Fans - Low Pressure					
	36-in. FC 36FA	32-in. FC 32FA	28-in. FC 28FA	36-in. AF 36AA	32-in. AF 32AA	28-in. AF 28AA
Max rpm	600	675	750	1250	1300	1500
ODP NEMA Premium motor hp range	10-40	10-30	10-25	10-30	10-30	10-20
Outlet area (ft ²)	13.91	11.11	8.81	13.91	11.11	8.81
Bearing/Shaft size (in.)	2.44	2.19	1.94	2.44	2.19	1.94
Size/Type Fan name	Housed Fans - High Pressure					
	36-in. FC 36FB	32-in. FC 32FB	28-in. FC 28FB	36-in. AF 36AB	32-in. AF 32AB	28-in. AF 28AB
Max rpm	665	760	860	1550	1700	2050
ODP NEMA Premium motor hp range	10-60	10-60	10-40	10-75	10-60	10-60
Outlet area (ft ²)	13.91	11.11	8.81	13.91	11.11	8.81
Bearing/Shaft size (in.)	2.44	2.19	2.44	2.44	2.19	2.19
Size/Type Fan name	Belt-drive Plenum Fans				Direct-Drive Plenum Fans	
	Low Pressure		High Pressure		High Pressure	
	44-in. AF 44PA	40-in. AF 40PA	44-in. AF 44PB	40-in. AF 40PB	4-22-in AF Nominal Width 22SF	4-22-in AF Extended Width 22SW
Max rpm	1100	1150	1200	1400	2613	2613
ODP NEMA Premium motor hp range	10-60	10-30	10-75	10-75	5-25	7.5-25
Outlet area (ft ²)	n/a	n/a	n/a	n/a	n/a	n/a
Bearing/Shaft size (in.)	2.19	2.44	2.44	2.19	n/a	n/a

Unit Size 80

Table 125. Section dimensions (inches) and weights (pounds) - unit size 80

Nominal airflow	40,000	
Airflow at 625 fpm	53,475	
Height - indoor unit (in.)	107.50	
Width (in.)	140.50	
Height - outdoor unit (in.) includes base drip lip	112.63	
Weight add for outdoor unit (lbs./in. of unit length)	2.57	
Section type	Length (in.)	Weight (lb.)
Access or blank		
-Small horizontal	10.00	305.74
-Medium horizontal	15.00	449.60
-Extended-medium horizontal	19.00	497.88
-Medium-large horizontal	24.50	600.46
-Large horizontal or turning	54.00	1036.33
-Extra-large horizontal or turning	n/a	n/a
-Ducted inlet or ducted outlet section	10.00	389.30
Blender	54.00	1112.23
Cool Dry Quiet (CDQ) Desiccant Dehumidification Section	n/a	n/a
Coils		
-Small horizontal (with 4-row UW)	n/a	n/a
-Medium horizontal (with 8-row UW)	15.00	2558.94
-Extended-medium horizontal (with 8-row UW)	19.00	2615.73
-Medium-large horizontal (with 10-row W)	24.50	4488.82
-Large horizontal or vertical (with 10-row W)	n/a	n/a
-Electric Heat Coil	n/a	n/a
-Integral-face-and-bypass (IFB) coil		
--Less than 4 rows	29.50	2378.60
--4 rows	n/a	n/a
Controls section (includes largest available VFD)	28.50	1031.00
Diffuser	37.25	715.78
Discharge plenum		
-Horizontal	54.00	1198.64
-Vertical	n/a	n/a
Energy Wheel	n/a	n/a
Face-and-Bypass Dampers		
-Face-and-bypass	19.00	973.60
-External face-and-bypass	39.00	1348.84
-Internal face-and-bypass or face damper only	19.00	954.26
Fan		
-Belt-drive plenum (BDP) fan with motor	63.00	4745.62
-Housed fan FC with motor	92.00	4922.58
-Housed AF/BC fans with motor	92.00	5101.29
-Direct-drive plenum fan with motor	92.00	5456.86
Filters		
-Side load 2-in. angled	27.50	1088.02
-Side load 4-in. angled	27.50	1105.14
-Side load cartridge 12-in. or short bag 18-in.	27.50	1364.91

Table 125. Section dimensions (inches) and weights (pounds) - unit size 80

Filters	Length (in.)	Weight (lb.)
-Side load 2-in. flat	15.00	637.02
-Side load 4-in. flat	15.00	729.15
-Side load 2-in. and 4-in. combination flat	19.00	981.02
-Long bag 30-in.	37.25	1271.00
-Front-load HEPA	40.00	2141.00
-Front-load cartridge	40.00	1671.00
-Front-load short bag	45.00	1365.00
Gas heat	n/a	n/a
Humidifier		
-Building Steam	15.00	1215.00
-Atmospheric	19.00	1078.00
Mixing box		
-with angled filters	54.00	1077.83
-with front/back Traq and top Traq dampers	92.00	2151.42
- reduced length mixing box with side/top/back/bottom airfoil damper	41.50	1453.60
Multizone	n/a	n/a
Silencer		
-3 feet	38.00	1741.00
-5 feet	62.00	2555.00
Trane Catalytic Air Cleaning System (TCACS)	36.00	1451.00
UV light	15.00	604.11
SECTIONS BELOW ARE FOR OUTDOOR UNITS ONLY		
Diagonal economizer		
-with airfoil dampers	86.00	1851.00
-with airfoil damper and one side Traq damper	86.00	1920.00
Exhaust damper section	22.40	820.10
Hoods		
- Back inlet hood - airfoil and Traq	140.00	344.00
- Side inlet hood - airfoil and Traq	37.25	258.00
- Exhaust hood - airfoil	37.25	174.00
- Economizer inlet hood	86.00	522.00
Pipe Cabinets		
15 in. long - 24-in. depth	15.00	181.00
15 in. long - 36-in. depth	15.00	243.00
15 in. long - 48-in. depth	15.00	304.00
24 in. long - 24-in. depth	24.00	208.00
24 in. long - 36-in. depth	24.00	273.00
24 in. long - 48-in. depth	24.00	338.00
48 in. long - 24-in. depth	48.00	281.00
48 in. long - 36-in. depth	48.00	354.00
48 in. long - 48-in. depth	48.00	427.00
96 in. long - 24-in. depth	96.00	427.00
96 in. long - 36-in. depth	96.00	517.00
96 in. long - 48-in. depth	96.00	606.00

Table 126. Filter data for unit size 80

Filter Type	Area ft ²	Qty–Size (in.)
Flat (2-in., 4-in., and 2-in/4-in high efficiency) pleated, permanent, throwaway media	85.56	20 - 20x24 4 - 20x16 5 - 12x24
Angled (2-in. or 4-in.) Pleated, permanent, throwaway media	151.11	48 - 20x20 8 - 16x20
Side load bag or cartridge	88.00	20 - 24x24 4 - 24x12
Front load bag or cartridge	86.00	1 - 12x24 19 - 24x24 4 - 24x12
Front load HEPA	76.00	4 - 24x30 1 - 24x12 4 - 24x30 1 - 24x12 4 - 24x30 1 - 24x12 5 - 12x24

Note: 2-inch filters available in permanent, throwaway, or pleated media; 4-inch filters available in pleated media, 65%, 85%, or 95% efficiency; Bag or cartridge filters available in 65%, 85%, or 95% efficiency.

Table 127. Coil availability - size 80

Section Type	5/8-in Unit Coils,	
	1/2-in Unit Coils	1/2-in and 5/8-in Modified Coils
Small	n/a	n/a
Medium	2–4 rows	1–3 rows
Extended-medium	2–8 rows	1-6 rows
Medium-large	2-8 rows	1-10 rows
-with access	n/a	n/a
Large horizontal	n/a	n/a
-with access	n/a	n/a
Large vertical	n/a	n/a
-with access	n/a	n/a

Table 128. Coil data for unit size 80

Coil Type	Rows	Fin Type	Area ft ²	Qty–Size (in.)
1/2-inch unit coils				
-UA, UW, UF, UU (stacked)	2, 4, 6, 8	Aluminum	78.75	2-45 x 126
5/8-inch unit coils				
-W, WD, 5D, 5A, 5W, D1, D2 (stacked)	1, 2, 3, 4, 6, 8	Aluminum or Copper	78.75	2-45 x 126
-W, WD, 5D, D1, D2 (stacked)	10	Aluminum	78.75	2-45 x 126
1-inch unit coil				
-NS (stacked)	1	Aluminum or Copper	73.50	2-30 x 126 1-24 x 126
1/2-inch modified coils				
-WL, LL, FD (stacked)	2, 4, 6, 8	Aluminum	63.44	2-36.25 x 126
5/8-inch modified coils				
-W, WD, 5A 5W, D1, D2	1, 2, 3, 4, 6, 8	Aluminum or Copper	63.00	2-36 x 126
-W, WD, D1, D2	10	Aluminum	63.00	2-36 x 126
1-inch modified coil				
-NS (stacked)	1	Aluminum or Copper	60.38	2-18 x 126 1-33 x 126
Multizone coils			n/a	n/a



General Data

Table 129.Fan data for unit size 80

Size/Type Fan name	Housed Fans - Low Pressure					
	36-in. FC 36FA	32-in. FC 32FA	28-in. FC 28FA	36-in. AF 36AA	32-in. AF 32AA	28-in. AF 28AA
Max rpm	600	675	750	1250	1300	1500
ODP NEMA Premium motor hp range	10-40	10-30	10-25	10-30	10-30	10-20
Outlet area (ft ²)	13.91	11.11	8.81	13.91	11.11	8.81
Bearing/Shaft size (in.)	2.4375	2.1875	1.9375	2.4375	2.1875	1.9375
Size/Type Fan name	Housed Fans - High Pressure					
	36-in. FC 36FB	32-in. FC 32FB	28-in. FC 28FB	36-in. AF 36AB	32-in. AF 32AB	28-in. AF 28AB
Max rpm	665	760	860	1550	1700	2050
ODP NEMA Premium motor hp range	10-60	10-60	10-40	10-75	10-60	10-60
Outlet area (ft ²)	13.91	11.11	8.81	13.91	11.11	8.81
Bearing/Shaft size (in.)	2.4375	2.1875	2.4375	2.4375	2.1875	2.1875
Size/Type Fan name	Belt-drive Plenum Fans				Direct-Drive Plenum Fans	
	Low Pressure		High Pressure		High Pressure	
	44-in. AF 44PA	40-in. AF 40PA	44-in. AF 44PB	40-in. AF 40PB	(4) 22-in. AF Nominal Width 22SF	(4) 22-in. AF Extended Width 22SW
Max rpm	1100	1150	1200	1400	2613	2613
ODP NEMA Premium motor hp range	10-60	10-30	10-75	10-75	5-25	7.5-25
Outlet area (ft ²)	n/a	n/a	n/a	n/a	n/a	n/a
Bearing/Shaft size (in.)	2.1875	2.4375	2.4375	2.1875	n/a	n/a

Unit Size 100

Table 130. Section dimensions (inches) and weights (pounds) - unit size 100

Nominal airflow	50,000	
Airflow at 625 fpm	65,106	
Height - indoor unit (in.)	119.75	
Width (in.)	154.50	
Height - outdoor unit (in.) includes base drip lip	124.88	
Weight add for outdoor unit (lbs./in. of unit length)	2.80	
Section type	Length (in.)	Weight (lb.)
Access or blank		
-Small horizontal	10.00	337.96
-Medium horizontal	15.00	493.59
-Extended-medium horizontal	19.00	545.85
-Medium-large horizontal	24.50	656.89
-Large horizontal or turning	60.00	1242.40
-Extra-large horizontal or turning	n/a	n/a
-Ducted inlet or ducted outlet section	10.00	428.30
Blender	60.00	1345.03
Cool Dry Quiet (CDQ) Desiccant Dehumidification Section	n/a	n/a
Coils		
-Small horizontal (with 4-row UW)	n/a	n/a
-Medium horizontal (with 8-row UW)	15.00	3094.04
-Extended-medium horizontal (with 8-row UW)	19.00	3163.21
-Medium-large horizontal (with 10-row W)	24.50	5499.42
-Large horizontal or vertical (with 10-row W)	n/a	n/a
-Electric Heat Coil	n/a	n/a
-Integral-face-and-bypass (IFB) coil		
--Less than 4 rows	29.50	2865.77
--4 rows	n/a	n/a
Controls section (includes largest available VFD)	28.50	1146.00
Diffuser	37.25	781.92
Discharge plenum		
-Horizontal	60.00	1423.88
-Vertical	n/a	n/a
Energy Wheel	n/a	n/a
Face-and-Bypass Dampers		
-Face-and-bypass	19.00	1093.88
-External face-and-bypass	39.00	1498.11
-Internal face-and-bypass or face damper only	19.00	1082.84
Fan		
-Belt-drive plenum (BDP) fan with motor	73.75	6223.51
-Housed fan FC with motor	96.00	5297.62
-Housed AF/BC fans with motor	96.00	6025.44
-Direct-drive plenum fan with motor	96.00	7176.65
Filters		
-Side load 2-in. angled	27.50	1157.16
-Side load 4-in. angled	27.50	1201.91
-Side load cartridge 12-in. or short bag 18-in.	27.50	1746.31



General Data

Table 130. Section dimensions (inches) and weights (pounds) - unit size 100

Filters	Length (in.)	Weight (lb.)
-Side load 2-in. flat	15.00	716.56
-Side load 4-in. flat	15.00	803.46
-Side load 2-in. and 4-in. combination flat	19.00	1078.09
-Long bag 30-in.	37.25	1393.00
-Front-load HEPA	40.00	2554.00
-Front-load cartridge	40.00	1923.00
-Front-load short bag	45.00	1539.00
Gas heat		
- 860 MBH	n/a	n/a
- 1000 MBH	84.00	3156.00
- 1250-1750 MBH	92.00	3878.50
- 2000 MBH	109.00	4503.50
- 2400 MBH	121.00	4715.90
Humidifier		
-Building Steam	15.00	1363.00
-Atmospheric	19.00	1265.00
Mixing box		
-with angled filters	60.00	1287.99
-with front/back Traq and top Traq dampers	96.00	2473.12
- reduced length mixing box with side/top/back/bottom airfoil damper	47.00	1731.30
Multizone	n/a	n/a
Silencer		
-3 feet	38.00	2196.00
-5 feet	62.00	3230.00
Trane Catalytic Air Cleaning System (TCACS)	36.00	1707.00
UV light	15.00	667.60
SECTIONS BELOW ARE FOR OUTDOOR UNITS ONLY		
Diagonal economizer		
-with airfoil dampers	93.00	2173.00
-with airfoil damper and one side Traq damper	93.00	2290.00
Exhaust damper section		
	22.40	935.50
Hoods		
- Back inlet hood - airfoil and Traq	140.00	491.00
- Side inlet hood - airfoil and Traq	43.00	412.00
- Exhaust hood - airfoil	43.00	206.00
- Economizer inlet hood	93.00	629.00
Pipe Cabinets		
15 in. long - 24-in. depth	15.00	198.00
15 in. long - 36-in. depth	15.00	265.00
15 in. long - 48-in. depth	15.00	333.00
24 in. long - 24-in. depth	24.00	227.00
24 in. long - 36-in. depth	24.00	298.00
24 in. long - 48-in. depth	24.00	368.00
48 in. long - 24-in. depth	48.00	306.00
48 in. long - 36-in. depth	48.00	385.00
48 in. long - 48-in. depth	48.00	463.00

Table 130. Section dimensions (inches) and weights (pounds) - unit size 100

Pipe Cabinets	Length (in.)	Weight (lb.)
96 in. long - 24-in. depth	96.00	462.00
96 in. long - 36-in. depth	96.00	558.00
96 in. long - 48-in. depth	96.00	653.00

Table 131. Filter data for unit size 100

Filter Type	Area ft ²	Qty–Size (in.)
Flat (2-in., 4-in., and 2-in/4-in high efficiency) pleated, permanent, throwaway media	104.17	30 - 20x25
Angled (2-in. or 4-in.) Pleated, permanent, throwaway media	166.67	48 - 20x25
Side load bag or cartridge	113.33	28 - 24x20
		4 - 24x12
Front load bag or cartridge	108.00	6 - 12x24
		24 - 24x24
Front load HEPA	102.00	6 - 30x24
		6 - 30x24
		6 - 12x24

Note: 2-inch filters available in permanent, throwaway, or pleated media; 4-inch filters available in pleated media, 65%, 85%, or 95% efficiency; Bag or cartridge filters available in 65%, 85%, or 95% efficiency.

Table 132. Coil availability - size 100

Section Type	5/8-in Unit Coils,	
	1/2-in Unit Coils	1/2-in and 5/8-in Modified Coils
Small	n/a	n/a
Medium	2–4 rows	1–3 rows
Extended-medium	2–8 rows	1-6 rows
Medium-large	2-8 rows	1-10 rows
-with access	n/a	n/a
Large horizontal	n/a	n/a
-with access	n/a	n/a
Large vertical	n/a	n/a
-with access	n/a	n/a

Table 133. Coil data for unit size 100

Coil Type	Rows	Fin Type	Area ft ²	Qty–Size (in.)
1/2-inch unit coils				
-UA, UW, UF, UU (stacked)	2, 4, 6, 8	Aluminum	99.14	1-57.50 x 141 1-43.75 x 141
5/8-inch unit coils				
-W, WD, 5D, 5A 5W, D1, D2 (stacked)	1, 2, 3, 4, 6, 8	Aluminum or Copper	99.88	2-51 x 141
W, WD, 5D, D1, D2 (stacked)	10	Aluminum	99.88	2-51 x 141
1-inch unit coil				
-NS (stacked)	1	Aluminum or Copper	94.00	2-33 x 141 1-30 x 141
1/2-inch modified coils				
-WL, LL, FD (stacked)	2, 4, 6, 8	Aluminum	77.11	1-42.50 x 141 1-36.25 x 141



General Data

Table 133. Coil data for unit size 100

Coil Type	Rows	Fin Type	Area ft ²	Qty-Size (in.)
5/8-inch modified coils				
-W, WD, 5A 5W, D1, D2 (stacked)	1, 2, 3, 4, 6, 8	Aluminum or Copper	76.38	1-42 x 141 1-36 x 141
W, WD, D1, D2 (stacked)	10	Aluminum	76.38	1-42 x 141 1-36 x 141
1-inch modified coil				
-NS	1	Aluminum or Copper	76.38	1-30 x 141 2-24 x 141
Multizone coils			n/a	n/a

Table 134. Fan data for unit size 100

Size/Type Fan name	Housed Fans - Low Pressure						
	40-in. FC 40FA	36-in. FC 36FA	32-in. FC 32FA	44-in. AF 44AA	40-in. AF 40AA	36-in. AF 36AA	32-in. AF 32AA
Max rpm	550	600	675	850	1200	1250	1300
ODP NEMA Premium motor hp range	15-40	15-40	15-30	15-40	15-60	15-30	15-30
Outlet area (ft ²)	17.45	13.91	11.11	21.88	17.45	13.91	11.11
Bearing/Shaft size (in.)	2.44	2.44	2.19	2.94	2.19	2.44	2.19
Size/Type Fan name	Housed Fans - High Pressure						
	40-in. FC 40FB	36-in. FC 36FB	32-in. FC 32FB	44-in. AF 44AB	40-in. AF 40AB	36-in. AF 36AB	32-in. AF 32AB
Max rpm	600	665	760	1150	1350	1550	1700
ODP NEMA Premium motor hp range	15-75	15-75	15-60	15-100	15-100	15-75	15-60
Outlet area (ft ²)	17.45	13.91	11.11	21.88	17.45	13.91	11.11
Bearing/Shaft size (in.)	2.44	2.44	2.19	2.94	2.44	2.44	2.19
Size/Type Fan name	Belt-drive Plenum Fans				Direct-Drive Plenum Fans		
	Low Pressure		High Pressure		High Pressure		
	55-in. AF 55PA	49-in. AF 49PA	55-in. AF 55PB	49-in. AF 49PB	6-24.5-in AF Nominal Width 24SF	6-24.5-in AF Extended Width 24SW	
Max rpm	850	950	975	1100	2344	2344	
ODP NEMA Premium motor hp range	15-75	15-60	15-125	15-100	5-20	5-20	
Outlet area (ft ²)	n/a	n/a	n/a	n/a	n/a	n/a	
Bearing/Shaft size (in.)	2.44	2.19	2.94	2.44	n/a	n/a	

Unit Size 120

Table 135. Section dimensions (inches) and weights (pounds) - unit size 120

Nominal airflow	60,000	
Airflow at 625 fpm	76,388	
Height - indoor unit (in.)	119.75	
Width (in.)	182.00	
Height - outdoor unit (in.) includes base drip lip	124.88	
Weight add for outdoor unit (lbs./in. of unit length)	3.24	
Section type	Length (in.)	Weight (lb.)
Access or blank		
-Small horizontal	10.00	374.94
-Medium horizontal	15.00	549.13
-Extended-medium horizontal	19.00	605.56
-Medium-large horizontal	24.50	725.47
-Large horizontal or turning	60.00	1387.96
-Extra-large horizontal or turning	n/a	n/a
-Ducted inlet or ducted outlet section	10.00	478.60
Blender	60.00	1567.62
Cool Dry Quiet (CDQ) Desiccant Dehumidification Section	n/a	n/a
Coils		
-Small horizontal (with 4-row UW)	n/a	n/a
-Medium horizontal (with 8-row UW)	15.00	3638.44
-Extended-medium horizontal (with 8-row UW)	19.00	3712.02
-Medium-large horizontal (with 10-row W)	24.50	6713.50
-Large horizontal or vertical (with 10-row W)	n/a	n/a
-Electric Heat Coil	n/a	n/a
-Integral-face-and-bypass (IFB) coil		
-Less than 4 rows	29.50	2936.42
--4 rows	n/a	n/a
Controls section (includes largest available VFD)	28.50	1266.00
Diffuser	37.25	860.66
Discharge plenum		
-Horizontal	60.00	1585.80
-Vertical	n/a	n/a
Energy Wheel	n/a	n/a
Face-and-Bypass Dampers		
-Face-and-bypass	19.00	1205.53
-External face-and-bypass	39.00	1643.69
-Internal face-and-bypass or face damper only	19.00	1194.50
Fan		
-Belt-drive plenum (BDP) fan with motor	82.25	7341.11
-Housed fan FC with motor	96.00	5600.08
-Housed AF/BC fans with motor	96.00	6891.90
-Direct-drive plenum fan with motor	96.00	7382.51
Filters		
-Side load 2-in. angled	27.50	1282.20
-Side load 4-in. angled	27.50	1338.65
-Side load cartridge 12-in. or short bag 18-in.	27.50	1903.54

General Data
Table 135. Section dimensions (inches) and weights (pounds) - unit size 120

Filters	Length (in.)	Weight (lb.)
-Side load 2-in. flat	15.00	817.63
-Side load 4-in. flat	15.00	913.90
-Side load 2-in. and 4-in. combination flat	19.00	1165.92
-Long bag 30-in.	37.25	1550.00
-Front-load HEPA	40.00	2925.00
-Front-load cartridge	40.00	2156.00
-Front-load short bag	45.00	1696.00
Gas heat		
- 860 MBH	n/a	n/a
- 1000 MBH	92.00	3125.30
- 1250-1750 MBH	102.00	3886.60
- 2000 MBH	109.00	4391.20
- 2400 MBH	119.00	4668.50
Humidifier		
-Building Steam	15.00	1551.00
-Atmospheric	19.00	1492.00
Mixing box		
-with angled filters	60.00	1433.55
-with front/back Traq and top Traq dampers	96.00	2790.48
- reduced length mixing box with side/top/back/bottom airfoil damper	53.00	2025.40
Multizone	n/a	n/a
Silencer		
-3 feet	38.00	2555.00
-5 feet	62.00	3786.00
Trane Catalytic Air Cleaning System (TCACS)	36.00	1881.00
UV light	15.00	758.72
SECTIONS BELOW ARE FOR OUTDOOR UNITS ONLY		
Diagonal economizer		
-with airfoil dampers	93.00	2396.00
-with airfoil damper and one side Traq damper	93.00	2494.00
Exhaust damper section		
	22.40	1058.30
Hoods		
- Back inlet hood - airfoil and Traq	167.25	566.00
- Side inlet hood - airfoil and Traq	48.75	415.00
- Exhaust hood - airfoil	48.75	221.00
- Economizer inlet hood	93.00	778.00
Pipe Cabinets		
15 in. long - 24-in. depth	15.00	198.00
15 in. long - 36-in. depth	15.00	265.00
15 in. long - 48-in. depth	15.00	333.00
24 in. long - 24-in. depth	24.00	227.00
24 in. long - 36-in. depth	24.00	298.00
24 in. long - 48-in. depth	24.00	368.00
48 in. long - 24-in. depth	48.00	306.00
48 in. long - 36-in. depth	48.00	385.00
48 in. long - 48-in. depth	48.00	463.00

Table 135. Section dimensions (inches) and weights (pounds) - unit size 120

Pipe Cabinets	Length (in.)	Weight (lb.)
96 in. long - 24-in. depth	96.00	462.00
96 in. long - 36-in. depth	96.00	558.00
96 in. long - 48-in. depth	96.00	653.00

Table 136. Filter data for unit size 120

Filter Type	Area ft ²	Qty-Size (in.)
Flat (2-in., 4-in., and 2-in/4-in high efficiency) pleated, permanent, throwaway media	122.22	32 - 25x20 4 - 25x16
Angled (2-in. or 4-in.) Pleated, permanent, throwaway media	194.44	56 - 25x20 28 - 24x24
Side load bag or cartridge	134.00	4 - 24x12 7 - 12x24
Front load bag or cartridge	126.00	7 - 12x24 28 - 24x24 7 - 30x24
Front load HEPA	119.00	7 - 30x24 7 - 30x24 7 - 12x24

Note: 2-inch filters available in permanent, throwaway, or pleated media; 4-inch filters available in pleated media, 65%, 85%, or 95% efficiency; Bag or cartridge filters available in 65%, 85%, or 95% efficiency.

Table 137. Coil availability - size 120

Section Type	1/2-in Unit Coils	5/8-in Unit Coils, 1/2-in and 5/8-in Modified Coils
Small	n/a	n/a
Medium	2-4 rows	1-3 rows
Extended-medium	2-8 rows	1-6 rows
Medium-large	2-8 rows	1-10 rows
-with access	n/a	n/a
Large horizontal	n/a	n/a
-with access	n/a	n/a
Large vertical	n/a	n/a
-with access	n/a	n/a

Table 138. Coil data for unit size 120

Coil Type	Rows	Fin Type	Area ft ²	Qty-Size (in.)
1/2-inch unit coils				
-UA, UW, UF, UU (stacked)	2, 4, 6, 8	Aluminum	118.13	1-57.50 x 168 1-43.75 x 168
5/8-inch unit coils				
-W, WD, 5D, 5A, 5W, D1, D2 (stacked)	1, 2, 3, 4, 6, 8	Aluminum or Copper	119.00	2-51 x 168
-W, WD, D1, D2 (stacked)	10	Aluminum	115.50	3-33 x 168
1-inch unit coil				
-NS (stacked)	1	Aluminum or Copper	96.00	2-33 x 144 1-30 x 144
1/2-inch modified coils				
-WL, LL, FD (stacked)	2, 4, 6, 8	Aluminum	91.88	1-42.50 x 168 1-36.25 x 168



General Data

Table 138.Coil data for unit size 120

Coil Type	Rows	Fin Type	Area ft ²	Qty-Size (in.)
5/8-inch modified coils				
-W, WD, 5A, 5W, D1, D2 (stacked)	1, 2, 3, 4, 6, 8	Aluminum or Copper	91.00	1-42 x 168 1-36 x 168
-W, WD, D1, D2 (stacked)	10	Aluminum	91.00	1-30 x 168 2-24 x 168
1-inch modified coil				
-NS (stacked)	1	Aluminum or Copper	78.00	1-30 x 144 2-24 x 144
Multizone coils			n/a	n/a

Table 139.Fan data for unit size 120

Size/Type Fan name	Housed Fans - Low Pressure						
	40-in. FC 40FA	36-in. FC 36FA	32-in. FC 32FA	49-in. AF 49AA	44-in. AF 44AA	40-in. AF 40AA	36-in. AF 36AA
Max rpm	550	600	675	800	850	1200	1250
ODP NEMA Premium motor hp range	30-40	30-40	30	30-100	30-40	30-60	30
Outlet area (ft ²)	17.45	13.91	11.11	27.45	21.88	17.45	13.91
Bearing/Shaft size (in.)	2.44	2.44	2.19	2.75	2.94	2.19	2.44
Size/Type Fan name	Housed Fans - High Pressure						
	40-in. FC 40FB	36-in. FC 36FB	32-in. FC 32FB	49-in. AF 49AB	44-in. AF 44AB	40-in. AF 40AB	36-in. AF 36AB
Max rpm	600	665	760	1100	1150	1350	1550
ODP NEMA Premium motor hp range	30-75	30-75	30-60	30-125	30-125	30-100	30-75
Outlet area (ft ²)	17.45	13.91	11.11	27.45	21.88	17.45	13.91
Bearing/Shaft size (in.)	2.44	2.44	2.19	2.94	2.94	2.44	2.44
Size/Type Fan name	Belt-drive Plenum Fans				Direct-Drive Plenum Fans		
	Low Pressure		High Pressure		High Pressure		
	63-in. AF 63PA	55-in. AF 55PA	63-in. AF 63PB	55-in. AF 55PB	6-24.5-inAF Nominal Width 24SF	6-24.5-inAF Extended Width 24SW	
Max rpm	750	850	850	975	2344	2344	
ODP NEMA Premium motor hp range	30-100	30-75	30-125	30-125	5-20	5-20	
Outlet area (ft ²)	n/a	n/a	n/a	n/a	n/a	n/a	
Bearing/Shaft size (in.)	2.94	2.44	3.19	2.94	n/a	n/a	



Coils

Drain Pans

Table 140. Coils depth by rows (inches)

Tube Diameter	Unit Size	Coil Rows							
		1	2	3	4	6	8	10	
1/2 inch (unit height)	3-40, 22	n/a	6.55	n/a	6.55	8.72	10.88	n/a	
1/2 inch (unit height)	50-120, 26, 31, 36, 41, 51, 58	n/a	5.72	n/a	7.88	10.05	12.21	n/a	
1/2 inch (modified height) ¹	All sizes	n/a	6.50	n/a	9/50	12.50	15.50	n/a	
5/8 inch	All sizes	4.00	6.50	8.00	9.50	12.50	15.50	18.50	
1 inch	All sizes	5.25	n/a	n/a	n/a	n/a	n/a	n/a	

Note: ¹Modified coils include WL, LL, FD. ²Unit coils include UF, UW, UU. Example: Size 30 with a 4-row UW coil in an extended-medium coil section, there would be 10.82 inches of drain pan exposed beyond the coil casing for cleaning access.

Coil Connections

Hydronic and Steam Coil Connections

Table 141. Water coils with 1/2-inch tubes connection diameter

Coil Type	Rows	Unit Sizes	Quantity	Connection Diameter (inches)		
				Supply	Return	Drain/Vent
UW	2, 4, 6, 8	3-6	1	1.50	1.50	0.38
		8-14, 50-66	1	2.00	2.00	0.38
		17-40, 80-120	1	2.50	2.50	0.38
UA	2	3-14, 50-57	1	1.50	1.50	0.38
		17-40, 66-120	1	2.00	2.00	0.38
UU	4, 8	12-120	1	2.50	2.50	0.38
LL	4, 6, 8	8-120	1	2.50	2.50	0.38
WL	2, 4, 6, 8	3-10	1	1.50	1.50	0.38
		12-21, 66	1	2.00	2.00	0.38
		25-57, 80-120	1	2.50	2.50	0.38

Note: All connections have external threads.

Table 142. Water coils with 5/8-inch tubes connection diameter

Coil Type	Rows	Header Height (in.)	Connection Diameter (inches)		
			Supply	Return	Drain/Vent
5A	2	12-27	2.00	2.00	0.38
		30-54	2.50	2.50	0.38
5D	6, 8, 10	45-55	2.50	2.50	0.38
5W	1	12-18	1.25	1.25	0.38
		24-54	1.50	1.50	0.38
	2	12-27	2.00	2.00	0.38
		30-54	2.50	2.50	0.38
D1	3, 4, 6, 8, 10	12-27	2.00	2.00	0.38
		30-55	2.50	2.50	0.38
D2	6, 8, 10	18-55	2.50	2.50	0.38
P2	2, 6	12-30	0.75	0.75	0.50
	4	12-30	1.00	1.00	0.50
P4	2, 4, 6, 8	12-30	1.00	1.00	0.50



Coils

Table 142. Water coils with 5/8-inch tubes connection diameter

Coil Type	Rows	Header Height (in.)	Connection Diameter (inches)		
			Supply	Return	Drain/Vent
P8	4, 8	18-30	1.25	1.25	0.50
TT	1, 2	12-33	0.75	0.75	n/a
W	3, 4, 6, 8, 10	12-27	2.00	2.00	0.38
		24, 30-51	2.50	2.50	0.38
WD	6, 8, 10	18-55	2.50	2.50	0.38

Note: 5A, 5W, W (4–10 row), D1, D2, WD, and 5D connections have external threads; P2, P4, P8, and TT connections have internal threads.

Table 143. Steam coils with 1-inch tubes connection diameter

Coil Type	Rows	Header Height (in.)	Connection Diameter (inches)		
			Supply	Return	Drain/Vent
NS	1	12	1.50	1.00	1.00
		18	2.00	1.00	1.00
		24	2.50	1.25	1.25
		30–33	3.00	1.25	1.25

Note: All connections have internal threads.

Refrigerant Coil Connections

Table 144. Type UF refrigerant coil connection sizes for unit sizes 3 to 30

Unit Size	Header Height (inches)	Rows	Distributor Tube	Number of Circuits	Circuiting	Connection Diameter (inches)					
						1 Distributor		2 Distributor		4 Distributor	
						Liquid	Suction	Liquid	Suction	Liquid	Suction
3, 4	20	4, 6, 8	0.25	15	Full	n/a	n/a	1.13	Note ¹	n/a	n/a
			0.19	15	Full	n/a	n/a	Note ²	Note ¹	n/a	n/a
		4, 6	0.25	7	Half	1.13	1.38	0.88	1.38	n/a	n/a
			0.19	7	Half	0.88	1.38	0.63	1.38	n/a	n/a
		4	0.25	3	Quarter	0.88	1.38	n/a	n/a	n/a	n/a
			0.19	3	Quarter	0.63	1.38	n/a	n/a	n/a	n/a
6	26	4, 6, 8	0.25	20	Full	n/a	n/a	1.13	1.63	n/a	n/a
			0.19	20	Full	n/a	n/a	1.13	1.63	n/a	n/a
		4, 6	0.25	10	Half	1.13	1.63	0.88	1.38	n/a	n/a
			0.19	10	Half	1.13	1.63	0.88	1.38	n/a	n/a
		4	0.25	5	Quarter	0.88	1.38	0.88	1.38	n/a	n/a
			0.19	5	Quarter	0.88	1.38	0.63	1.38	n/a	n/a
8, 10	28	4, 6, 8	0.25	22	Full	n/a	n/a	1.38	1.63	n/a	n/a
			0.19	22	Full	n/a	n/a	1.13	1.63	n/a	n/a
		4, 6	0.25	11	Half	1.38	1.63	0.88	1.38	n/a	n/a
			0.19	11	Half	1.13	1.63	0.88	1.38	n/a	n/a
		4	0.25	4	Quarter	0.88	1.38	0.88	1.38	n/a	n/a
			0.19	4	Quarter	0.63	1.38	0.63	1.38	n/a	n/a
12, 14	32	4, 6, 8	0.25	25	Full	n/a	n/a	1.38	1.63	n/a	n/a
			0.19	25	Full	n/a	n/a	1.13	1.63	n/a	n/a
		4, 6	0.25	12	Half	1.38	1.63	1.13	1.38	n/a	n/a
			0.19	12	Half	1.13	1.63	0.88	1.38	n/a	n/a
		4	0.25	6	Quarter	1.13	1.38	0.88	1.38	n/a	n/a
			0.19	6	Quarter	0.88	1.38	0.63	1.38	n/a	n/a

Table 144. Type UF refrigerant coil connection sizes for unit sizes 3 to 30

Unit Size	Header Height (inches)	Distributor Rows	Distributor Tube	Number of Circuits	Circuiting	Connection Diameter (inches)					
						1 Distributor		2 Distributor		4 Distributor	
						Liquid	Suction	Liquid	Suction	Liquid	Suction
17	40	4, 6, 8	0.25	31	Full	n/a	n/a	n/a	n/a	1.13	Note ⁵
			0.19	31	Full	n/a	n/a	n/a	n/a	Note ⁴	Note ⁵
		4, 6	0.25	15	Half	n/a	n/a	1.13	Note ⁷	0.88	1.38
			0.19	15	Half	n/a	n/a	Note ⁶	Note ⁷	0.63	1.38
21	43	4, 6, 8	0.25	34	Full	n/a	n/a	n/a	n/a	1.13	1.63
			0.19	34	Full	n/a	n/a	n/a	n/a	1.13	1.63
		4, 6	0.25	17	Half	n/a	n/a	1.13	1.63	0.88	1.38
			0.19	17	Half	n/a	n/a	1.13	1.63	Note ⁸	1.38
25, 30	52	4, 6, 8	0.25	41	Full	n/a	n/a	n/a	n/a	1.38	1.63
			0.19	41	Full	n/a	n/a	n/a	n/a	1.13	1.63
		4, 6	0.25	20	Half	n/a	n/a	1.13	1.63	0.88	1.38
			0.19	20	Half	n/a	n/a	1.13	1.63	0.88	1.38

Notes: ¹Bottom suction connection is 1.63 inches and top suction connection is 1.38 inch. ²Bottom liquid connection is 1.13 inches and top liquid connection is 0.88 inch. ³Connections are 1.13 for intertwined and 1.38 inches for horizontal split. ⁴Three connections are 1.13 inches and one is 0.88 inch. ⁵Three connections are 1.63 inches and one is 1.38 inches. ⁶One connection is 0.88 inch and one is 1.13 inches. ⁷One connection is 1.38 inches and one is 1.63 inches. ⁸Three connection are 0.63 inch and one is 0.88 inch. ⁹Liquid connections are 0.88 inch for intertwined and 1.13 inches for horizontal split. ¹⁰Suction connections are 1.38 inches for intertwined and 1.63 inches for horizontal split. ¹¹Three suction connections are 1.38 inches and one is 1.63 inches. ¹²Three liquid connections are 0.88 inches and one is 1.13 inches. ¹³Three connections are 0.63 inches and one connection is 0.88 inches.

Table 145. Type UF refrigerant coil connection sizes for unit sizes 35 to 120

Unit Size	Header Height (inches)	Distributor Rows	Distributor Tube	Number of Circuits	Circuiting	Connection Diameter (inches)					
						1 Distributor		2 Distributor		4 Distributor	
						Liquid	Suction	Liquid	Suction	Liquid	Suction
35, 40	57	4, 6, 8	0.25	45	Full	n/a	n/a	n/a	n/a	1.38	1.63
			0.19	45	Full	n/a	n/a	n/a	n/a	1.13	1.63
		4, 6	0.25	22	Half	n/a	n/a	1.38	1.63	1.38	1.63
			0.19	22	Half	n/a	n/a	1.13	1.63	Note ⁹	Note ¹⁰
50	31	4, 6, 8	0.25	24	Full	n/a	n/a	1.38	1.63	n/a	n/a
			0.19	24	Full	n/a	n/a	1.13	1.63	n/a	n/a
		4, 6	0.25	12	Half	1.38	1.63	1.13	1.38	n/a	n/a
			0.19	12	Half	1.13	1.63	0.88	1.38	n/a	n/a
		4	0.25	6	Quarter	1.13	1.38	0.88	1.38	n/a	n/a
			0.19	6	Quarter	0.88	1.38	0.63	1.38	n/a	n/a
57	36	4, 6, 8	0.25	28	Full	n/a	n/a	n/a	n/a	1.13	1.38
			0.19	28	Full	n/a	n/a	n/a	n/a	0.88	1.38
		4, 6	0.25	14	Half	n/a	n/a	1.13	1.38	n/a	n/a
			0.19	14	Half	n/a	n/a	0.88	1.38	n/a	n/a
66	37	4, 6, 8	0.25	29	Full	n/a	n/a	n/a	n/a	1.13	Note ¹¹
			0.19	29	Full	n/a	n/a	n/a	n/a	Note ¹²	Note ¹¹
		4, 6	0.25	14	Half	n/a	n/a	1.13	1.38	n/a	n/a
			0.19	14	Half	n/a	n/a	0.88	1.38	n/a	n/a
80	45	4, 6, 8	0.25	35	Full	n/a	n/a	n/a	n/a	1.13	1.63
			0.19	35	Full	n/a	n/a	n/a	n/a	1.13	1.63
		4, 6	0.25	17	Half	n/a	n/a	1.13	1.63	0.88	1.38
			0.19	17	Half	n/a	n/a	1.13	1.63	Note ¹³	1.38



Coils

Table 145. Type UF refrigerant coil connection sizes for unit sizes 35 to 120

Unit Size	Header Height (inches)	Distributor Rows	Distributor Tube	Number of Circuits	Circuiting	Connection Diameter (inches)					
						1 Distributor		2 Distributor		4 Distributor	
						Liquid	Suction	Liquid	Suction	Liquid	Suction
100, 120	51	4, 6, 8	0.25	40	Full	n/a	n/a	n/a	n/a	1.13	1.63
			0.19	40	Full	n/a	n/a	n/a	n/a	1.13	1.63
		4, 6	0.25	20	Half	n/a	n/a	1.13	1.63	0.88	1.38
			0.19	20	Half	n/a	n/a	1.13	1.63	0.88	1.38

Notes: ¹Bottom suction connection is 1.63 inches and top suction connection is 1.38 inch. ²Bottom liquid connection is 1.13 inches and top liquid connection is 0.88 inch. ³Connections are 1.13 for intertwined and 1.38 inches for horizontal split. ⁴Three connections are 1.13 inches and one is 0.88 inch. ⁵Three connections are 1.63 inches and one is 1.38 inches. ⁶One connection is 0.88 inch and one is 1.13 inches. ⁷One connection is 1.38 inches and one is 1.63 inches. ⁸Three connection are 0.63 inch and one is 0.88 inch. ⁹Liquid connections are 0.88 inch for intertwined and 1.13 inches for horizontal split. ¹⁰Suction connections are 1.38 inches for intertwined and 1.63 inches for horizontal split. ¹¹Three suction connections are 1.38 inches and one is 1.63 inches. ¹²Three liquid connections are 0.88 inches and one is 1.13 inches. ¹³Three connections are 0.63 inches and one connection is 0.88 inches.

Table 146. Type FD refrigerant coil connection sizes for unit sizes 3 to 40

Unit Size	Header Height (inches)	Distributor Rows	Distributor or Tube	Number of Circuits	Circuiting	Connection Diameter (inches)					
						1 Distributor		2 Distributor		4 Distributor	
						Liquid	Suction	Liquid	Suction	Liquid	Suction
8, 10	18	4, 6	0.25	14	Full	n/a	n/a	1.13	1.38	n/a	n/a
			0.19	14	Full	n/a	n/a	0.88	1.38	n/a	n/a
		4, 6	0.25	7	Half	1.13	1.38	0.88	1.38	n/a	n/a
			0.19	7	Half	0.88	1.38	0.63	1.38	n/a	n/a
		4	0.25	4	Quarter	0.88	1.38	0.88	1.38	n/a	n/a
			0.19	4	Quarter	0.63	1.38	0.63	1.38	n/a	n/a
12, 14	24	4, 6	0.25	19	Full	n/a	n/a	1.13	1.63	n/a	n/a
			0.19	19	Full	n/a	n/a	1.13	1.63	n/a	n/a
		4, 6	0.25	9	Half	1.13	1.63	0.88	1.63	n/a	n/a
			0.19	9	Half	1.13	1.63	Note ¹	1.63	n/a	n/a
		4	0.25	4	Quarter	0.88	1.38	0.88	1.38	n/a	n/a
			0.19	4	Quarter	0.63	1.38	0.63	1.38	n/a	n/a
17	30	4, 6	0.25	24	Full	n/a	n/a	1.38	1.63	n/a	n/a
			0.19	24	Full	n/a	n/a	1.13	1.63	n/a	n/a
		4, 6	0.25	12	Half	1.38	1.63	1.13	1.63	n/a	n/a
			0.19	12	Half	1.13	1.63	0.88	1.63	n/a	n/a
		4	0.25	6	Quarter	1.13	1.63	0.88	1.63	n/a	n/a
			0.19	6	Quarter	0.88	1.63	0.63	1.63	n/a	n/a
21	33	4, 6	0.25	26	Full	n/a	n/a	1.38	1.63	n/a	n/a
			0.19	26	Full	n/a	n/a	1.13	1.63	n/a	n/a
		4, 6	0.25	13	Half	1.38	1.63	1.13	1.63	n/a	n/a
			0.19	13	Half	1.13	1.63	0.88	1.63	n/a	n/a
		4	0.25	6	Quarter	1.13	1.63	0.88	1.63	n/a	n/a
			0.19	6	Quarter	0.88	1.63	0.63	1.63	n/a	n/a
25, 30, 35, 40	36	4, 6	0.25	28	Full	n/a	n/a	n/a	n/a	1.13	1.38
			0.19	28	Full	n/a	n/a	n/a	n/a	0.88	1.38

Notes: ¹On a 4 row intertwined the liquid connection is 0.88 inch downstream and 0.63 inch upstream. On a 6 row intertwined the liquid connection is 0.64 inch downstream and 0.88 upstream. ²For 4-row intertwined, the upstream liquid connection is 0.63 inches and the downstream liquid connection is 0.88 inches. For 6-row intertwined, the upstream liquid connection is 0.88 inches and the downstream liquid connection is 0.63 inches.

Table 147. Type FD refrigerant coil connection sizes for unit sizes 50-120

Unit Size	Header Height (inches)	Rows	Distribut or Tube	Number of Circuits	Circuiting	Connection Diameter (inches)					
						1 Distributor		2 Distributor		4 Distributor	
						Liquid	Suction	Liquid	Suction	Liquid	Suction
50	42	4, 6	0.25	33	Full	n/a	n/a	n/a	n/a	1.13	1.63
			0.19	33	Full	n/a	n/a	n/a	n/a	1.13	1.63
57	24	4, 6	0.25	19	Full	n/a	n/a	1.13	1.63	n/a	n/a
			0.19	19	Full	n/a	n/a	1.13	1.63	n/a	n/a
	24	4, 6	0.25	9	Half	1.13	1.63	0.88	1.63	n/a	n/a
			0.19	9	Half	1.13	1.63	Note ²	1.63	n/a	n/a
	24	4	0.25	4	Quarter	0.88	1.38	0.88	1.38	n/a	n/a
			0.19	4	Quarter	0.63	1.38	0.63	1.38	n/a	n/a
	30	4, 6	0.25	24	Full	n/a	n/a	1.38	1.63	n/a	n/a
			0.19	24	Full	n/a	n/a	1.13	1.63	n/a	n/a
	30	4, 6	0.25	12	Half	1.38	1.63	1.13	1.63	n/a	n/a
			0.19	12	Half	1.13	1.63	0.88	1.63	n/a	n/a
30	4	0.25	6	Quarter	1.13	1.63	0.88	1.63	n/a	n/a	
		0.19	6	Quarter	0.88	1.63	0.63	1.63	n/a	n/a	
66	24	4, 6	0.25	19	Full	n/a	n/a	1.13	1.63	n/a	n/a
			0.19	19	Full	n/a	n/a	1.13	1.63	n/a	n/a
	4, 6	0.25	9	Half	1.13	1.63	0.88	1.63	n/a	n/a	
		0.19	9	Half	1.13	1.63	Note ²	1.63	n/a	n/a	
	4	0.25	4	Quarter	0.88	1.38	0.88	1.38	n/a	n/a	
		0.19	4	Quarter	0.63	1.38	0.63	1.38	n/a	n/a	
66	33	4, 6	0.25	26	Full	n/a	n/a	1.38	1.63	n/a	n/a
			0.19	26	Full	n/a	n/a	1.13	1.63	n/a	n/a
	4, 6	0.25	13	Half	1.38	1.63	1.13	1.63	n/a	n/a	
		0.19	13	Half	1.13	1.63	0.88	1.63	n/a	n/a	
	4	0.25	6	Quarter	1.13	1.63	0.88	1.63	n/a	n/a	
		0.19	6	Quarter	0.88	1.63	0.63	1.63	n/a	n/a	
80	36	4, 6	0.25	28	Full	n/a	n/a	n/a	n/a	1.13	1.38
			0.19	28	Full	n/a	n/a	n/a	n/a	0.88	1.38
100	36	4, 6	0.25	28	Full	n/a	n/a	n/a	n/a	1.13	1.38
			0.19	28	Full	n/a	n/a	n/a	n/a	0.88	1.38
	42	4, 6	0.25	33	Full	n/a	n/a	n/a	n/a	1.13	1.63
			0.19	33	Full	n/a	n/a	n/a	n/a	1.13	1.63
120	36	4, 6	0.25	28	Full	n/a	n/a	n/a	n/a	1.13	1.38
			0.19	28	Full	n/a	n/a	n/a	n/a	0.88	1.38
	42	4, 6	0.25	33	Full	n/a	n/a	n/a	n/a	1.13	1.63
			0.19	33	Full	n/a	n/a	n/a	n/a	1.13	1.63

Notes: ¹On a 4 row intertwined the liquid connection is 0.88 inch downstream and 0.63 inch upstream. On a 6 row intertwined the liquid connection is 0.64 inch downstream and 0.88 upstream. ²For 4-row intertwined, the upstream liquid connection is 0.63 inches and the downstream liquid connection is 0.88 inches. For 6-row intertwined, the upstream liquid connection is 0.88 inches and the downstream liquid connection is 0.63 inches.



Coils

Coil Circuiting

Refrigerant coil circuiting is first defined by how the distributors are arranged on the coil and then by the number of tubes on the coil being fed refrigerant.

Distributor Arrangement

The term *standard circuiting* means the number of distributors used on a coil is the minimum required to meet capacity. If more than one distributor is required, then the coil is horizontally split so sections of the coil can be de-energized to unload the coil.

The term *horizontally split circuiting* means that at a minimum, each coil (or each coil in a bank) will have two or more distributors per coil. As each coil is horizontally split, sections of the coil can be de-energized to unload the coil.

The term *intertwined circuiting* means that at a minimum each coil (or each coil in a bank) will have two or more distributors per coil. Since each distributor is circuited from the top to the bottom of the coil, the full face of the coil remains energized even if a circuit is de-energized to unload the coil. If four distributors are used on a coil, then the coil is first horizontally split, with the top half of the coil intertwined using two distributors, and the bottom half of the coil intertwined using the other two distributors.

Distributor Circuiting

The terms *full*, *half*, and *quarter* refer to the number of coil tubes being fed refrigerant by each distributor of that coil. For example, full means that each tube in one row of the coil is being fed refrigerant from the distributor(s), while half means every other tube in a row is being fed.

Circuiting Example. Table 148 lists standard distributor arrangements (minimum number or distributors) for UF coils. On a size 12 unit, 6-row coil with half circuiting (every other tube in a row being fed), there is one distributor, with 12 tubes in one row of the coil being fed refrigerant. Circuiting data is show by unit size and coil rows.

Table 148.Type UF coil standard circuiting

Unit size	Header height (inches)	Coil rows	Full		Half		Quarter	
			Dist qty	Circuits per dist	Dist qty	Circuits per dist	Dist qty	Circuits per dist
3,4	20	4	2	7,8	1	7	1	3
		6	2	7,8	1	7	n/a	n/a
		8	2	7,8	n/a	n/a	n/a	n/a
6	26	4	2	10,10	1	10	1	5
		6	2	10,10	1	10	n/a	n/a
		8	2	10,10	n/a	n/a	n/a	n/a
8,10	28	4	2	11,11	1	11	1	4
		6	2	11,11	1	11	n/a	n/a
		8	2	11,11	n/a	n/a	n/a	n/a
12,14	32	4	2	12,13	1	12	1	6
		6	2	12,13	1	12	n/a	n/a
17	40	4	4	7,8,8,8	2	7,8	n/a	n/a
		6	4	7,8,8,8	2	7,8	n/a	n/a
		8	4	7,8,8,8	n/a	n/a	n/a	n/a

Table 148.Type UF coil standard circuiting

Unit size	Header height (inches)	Coil rows	Full		Half		Quarter	
			Dist qty	Circuits per dist	Dist qty	Circuits per dist	Dist qty	Circuits per dist
21	43	4	4	8,8,9,9	2	8,9	n/a	n/a
		6	4	8,8,9,9	2	8,9	n/a	n/a
		8	4	8,8,9,9	n/a	n/a	n/a	n/a
25,30	52	4	4	10,10,10,11	2	10,10	n/a	n/a
		6	4	10,10,10,11	2	10,10	n/a	n/a
		8	4	10,10,10,11	n/a	n/a	n/a	n/a
35,40	57	4	4	11,11,11,12	2	11,11	n/a	n/a
		6	4	11,11,11,12	2	11,11	n/a	n/a
		8	4	11,11,11,12	n/a	n/a	n/a	n/a
50 (Stacked)	31	4	2	12,12	1	12	1	6
		6	2	12,12	1	12	n/a	n/a
		8	2	12,12	n/a	n/a	n/a	n/a
	31	4	2	12,12	1	12	1	6
		6	2	12,12	1	12	n/a	n/a
		8	2	12,12	n/a	n/a	n/a	n/a
57 (Stacked)	36	4	4	7,7,7,7	2	7,7	n/a	n/a
		6	4	7,7,7,7	2	7,7	n/a	n/a
		8	4	7,7,7,7	n/a	n/a	n/a	n/a
	36	4	4	7,7,7,7	2	7,7	n/a	n/a
		6	4	7,7,7,7	2	7,7	n/a	n/a
		8	4	7,7,7,7	n/a	n/a	n/a	n/a
66 (Stacked)	37	4	4	7,7,7,8	2	7,7	n/a	n/a
		6	4	7,7,7,8	2	7,7	n/a	n/a
		8	4	7,7,7,8	n/a	n/a	n/a	n/a
	37	4	4	7,7,7,8	2	7,7	n/a	n/a
		6	4	7,7,7,8	2	7,7	n/a	n/a
		8	4	7,7,7,8	n/a	n/a	n/a	n/a
80 (Stacked)	45	4	4	8,9,9,9	2	8,9	n/a	n/a
		6	4	8,9,9,9	2	8,9	n/a	n/a
		8	4	8,9,9,9	n/a	n/a	n/a	n/a
	45	4	4	8,9,9,9	2	8,9	n/a	n/a
		6	4	8,9,9,9	2	8,9	n/a	n/a
		8	4	8,9,9,9	n/a	n/a	n/a	n/a
100, 120 (Stacked)	51	4	4	10,10,10,10	2	10,10	n/a	n/a
		6	4	10,10,10,10	2	10,10	n/a	n/a
		8	4	10,10,10,10	n/a	n/a	n/a	n/a
	51	4	4	10,10,10,10	2	10,10	n/a	n/a
		6	4	10,10,10,10	2	10,10	n/a	n/a
		8	4	10,10,10,10	n/a	n/a	n/a	n/a



Coils

Table 149.Type UF coil intertwined circuiting

Unit Size	Header Height (inches)	Coil Rows	Full		Half		Quarter	
			Dist Qty	Circuits per Dist	Dist Qty	Circuits per Dist	Dist Qty	Circuits per Dist
3, 4	20	4, 6	2	7, 8	2	3, 4	n/a	n/a
		8	2	7, 8	n/a	n/a	n/a	n/a
6	26	4	2	10, 10	2	5, 5	2	2, 3
		6	2	10, 10	2	5, 5	n/a	n/a
		8	2	10, 10	n/a	n/a	n/a	n/a
8, 10	28	4	2	11, 11	2	5, 6	2	2, 2
		6	2	11, 11	2	5, 6	n/a	n/a
		8	2	11, 11	n/a	n/a	n/a	n/a
12, 14	32	4	2	12, 13	2	6, 6	2	3, 3
		6	2	12, 13	2	6, 6	n/a	n/a
		8	2	12, 13	n/a	n/a	n/a	n/a
17	40	4, 6	4	8, 7, 8, 8	4	4, 3, 4, 4	n/a	n/a
		8	4	8, 7, 8, 8	n/a	n/a	n/a	n/a
21	43	4, 6	4	8, 8, 9, 9	4	4, 4, 4, 5	n/a	n/a
		8	4	8, 8, 9, 9	n/a	n/a	n/a	n/a
25, 30	52	4, 6	4	10, 10, 10, 11	4	5, 5, 5, 5	n/a	n/a
		8	4	10, 10, 10, 11	n/a	n/a	n/a	n/a
35, 40	57	4, 6	4	11, 11, 11, 12	4	5, 6, 5, 6	n/a	n/a
		8	4	11, 11, 11, 12	n/a	n/a	n/a	n/a
50 (Stacked)	31	4	2	12,12	2	6,6	2	3,3
		6	2	12,12	2	6,6	n/a	n/a
		8	2	12,12	n/a	n/a	n/a	n/a
57 (Stacked)	36	4	4	7,7,7,7	2	7,7	n/a	n/a
		6	4	7,7,7,7	2	7,7	n/a	n/a
		8	4	7,7,7,7	n/a	n/a	n/a	n/a
66 (Stacked)	37	4	4	7,7,7,8	2	7,7	n/a	n/a
		6	4	7,7,7,8	2	7,7	n/a	n/a
		8	4	7,7,7,8	n/a	n/a	n/a	n/a
66 (Stacked)	37	4	4	7,7,7,8	2	7,7	n/a	n/a
		6	4	7,7,7,8	2	7,7	n/a	n/a
		8	4	7,7,7,8	n/a	n/a	n/a	n/a

Table 149. Type UF coil intertwined circuiting

Unit Size	Header Height (inches)	Coil Rows	Full		Half		Quarter	
			Dist Qty	Circuits per Dist	Dist Qty	Circuits per Dist	Dist Qty	Circuits per Dist
80 (Stacked)	45	4	4	8,9,9,9	4	4,4,4,5	n/a	n/a
		6	4	8,9,9,9	4	4,4,4,5	n/a	n/a
		8	4	8,9,9,9	n/a	n/a	n/a	n/a
	45	4	4	8,9,9,9	4	4,4,4,5	n/a	n/a
		6	4	8,9,9,9	4	4,4,4,5	n/a	n/a
		8	4	8,9,9,9	n/a	n/a	n/a	n/a
100, 120 (Stacked)	51	4	4	10,10,10,10	4	5,5,5,5	n/a	n/a
		6	4	10,10,10,10	4	5,5,5,5	n/a	n/a
		8	4	10,10,10,10	n/a	n/a	n/a	n/a
	51	4	4	10,10,10,10	4	5,5,5,5	n/a	n/a
		6	4	10,10,10,10	4	5,5,5,5	n/a	n/a
		8	4	10,10,10,10	n/a	n/a	n/a	n/a

Table 150. Type FD coil standard circuiting

Unit Size	Header height (inches)	Coil rows	Full		Half		Quarter	
			Dist qty	Circuits per dist	Dist qty	Circuits per dist	Dist qty	Circuits per dist
8,10	18	4	2	7,7	1	7	1	4
		6	2	7,7	1	7	n/a	n/a
12,14	24	4	2	9,10	1	9	1	4
		6	2	9,10	1	9	n/a	n/a
17	30	4	2	12,12	1	12	1	6
		6	2	12,12	1	12	n/a	n/a
21	33	4	2	13,13	1	13	1	6
		6	2	13,13	1	13	n/a	n/a
25, 30, 35, 40	36	4	4	7,7,7,7	n/a	n/a	n/a	n/a
		6	4	7,7,7,7	n/a	n/a	n/a	n/a
50	42	4	4	8,8,8,9	n/a	n/a	n/a	n/a
		6	4	8,8,8,9	n/a	n/a	n/a	n/a
57 (Stacked)	24	4	2	9,10	1	9	1	4
		6	2	9,10	1	9	n/a	n/a
	30	4	2	12,12	1	12	1	6
		6	2	12,12	1	12	n/a	n/a
66 (Stacked)	24	4	2	9,10	1	9	1	4
		6	2	9,10	1	9	n/a	n/a
	33	4	2	13,13	1	13	1	6
		6	2	13,13	1	13	n/a	n/a



Coils

Table 150. Type FD coil standard circuiting

Unit Size	Header height (inches)	Coil rows	Full		Half		Quarter	
			Dist qty	Circuits per dist	Dist qty	Circuits per dist	Dist qty	Circuits per dist
80 (Stacked)	36	4	4	7,7,7,7	n/a	n/a	n/a	n/a
		6	4	7,7,7,7	n/a	n/a	n/a	n/a
	36	4	4	7,7,7,7	n/a	n/a	n/a	n/a
		6	4	7,7,7,7	n/a	n/a	n/a	n/a
100, 120 (Stacked)	36	4	4	7,7,7,7	n/a	n/a	n/a	n/a
		6	4	7,7,7,7	n/a	n/a	n/a	n/a
	42	4	4	8,8,8,9	n/a	n/a	n/a	n/a
		6	4	8,8,8,9	n/a	n/a	n/a	n/a

Table 151. Type FD coil intertwined circuiting

Unit Size	Header Height (inches)	Coil Rows	Full		Half		Quarter	
			Dist Qty	Circuits per Dist	Dist Qty	Circuits per Dist	Dist Qty	Circuits per Dist
8, 10	18	4	2	7, 7	2	3, 4	2	2, 2
		6	2	7, 7	2	3, 4	n/a	n/a
12, 14	24	4	2	10, 9	2	4, 5	2	2, 2
		6	2	10, 9	2	4, 5	n/a	n/a
17	30	4	2	12, 12	2	6, 6	2	3, 3
		6	2	12, 12	2	6, 6	n/a	n/a
21	33	4	2	13, 13	2	6, 7	2	3, 3
		6	2	13, 13	2	6, 7	n/a	n/a
25, 30, 35, 40	36	4	4	7, 7, 7, 7	n/a	n/a	n/a	n/a
		6	4	7, 7, 7, 7	n/a	n/a	n/a	n/a
50	42	4	4	8, 9, 8, 8	n/a	n/a	n/a	n/a
		6	4	8, 9, 8, 8	n/a	n/a	n/a	n/a
57 (Stacked)	24	4	2	10, 9	2	4, 5	2	2, 2
		6	2	10, 9	2	4, 5	n/a	n/a
	30	4	2	12, 12	2	6, 6	2	3, 3
		6	2	12, 12	2	6, 6	n/a	n/a
66 (Stacked)	24	4	2	10, 9	2	4, 5	2	2, 2
		6	2	10, 9	2	4, 5	n/a	n/a
	33	4	2	13, 13	2	6, 7	2	3, 3
		6	2	13, 13	2	6, 7	n/a	n/a
80 (Stacked)	36	4	4	7, 7, 7, 7	n/a	n/a	n/a	n/a
		6	4	7, 7, 7, 7	n/a	n/a	n/a	n/a
	36	4	4	7, 7, 7, 7	n/a	n/a	n/a	n/a
		6	4	7, 7, 7, 7	n/a	n/a	n/a	n/a
100, 120 (Stacked)	36	4	4	7, 7, 7, 7	n/a	n/a	n/a	n/a
		6	4	7, 7, 7, 7	n/a	n/a	n/a	n/a
	42	4	4	8, 9, 8, 8	n/a	n/a	n/a	n/a
		6	4	8, 9, 8, 8	n/a	n/a	n/a	n/a

Face-Velocity Limits for Moisture Carryover

Cooling coils are available with a wide variety of fin types and materials, including the following, to help optimize their performance:

- 1/2-inch: Delta-Flo™ E and Delta-Flo H aluminum fins
- 5/8-inch: Prima-Flo™ E and Prima-Flo H aluminum fins, and Prima-Flo™ copper fins

All of these fins are available with variable fin spacing (that is, the spacing can increment by as little as one fin per foot). Also, Delta-Flo H and Prima-Flo H fins are specifically designed to help maximize heat transfer while minimizing moisture carryover.

Figure 65 through Figure 72 detail the moisture carryover limits for each of these fin types. Refer to TOPSS selection program for availability.

Figure 65. Face-velocity limits for moisture carryover with uncoated coils in unit sizes 3 to 10

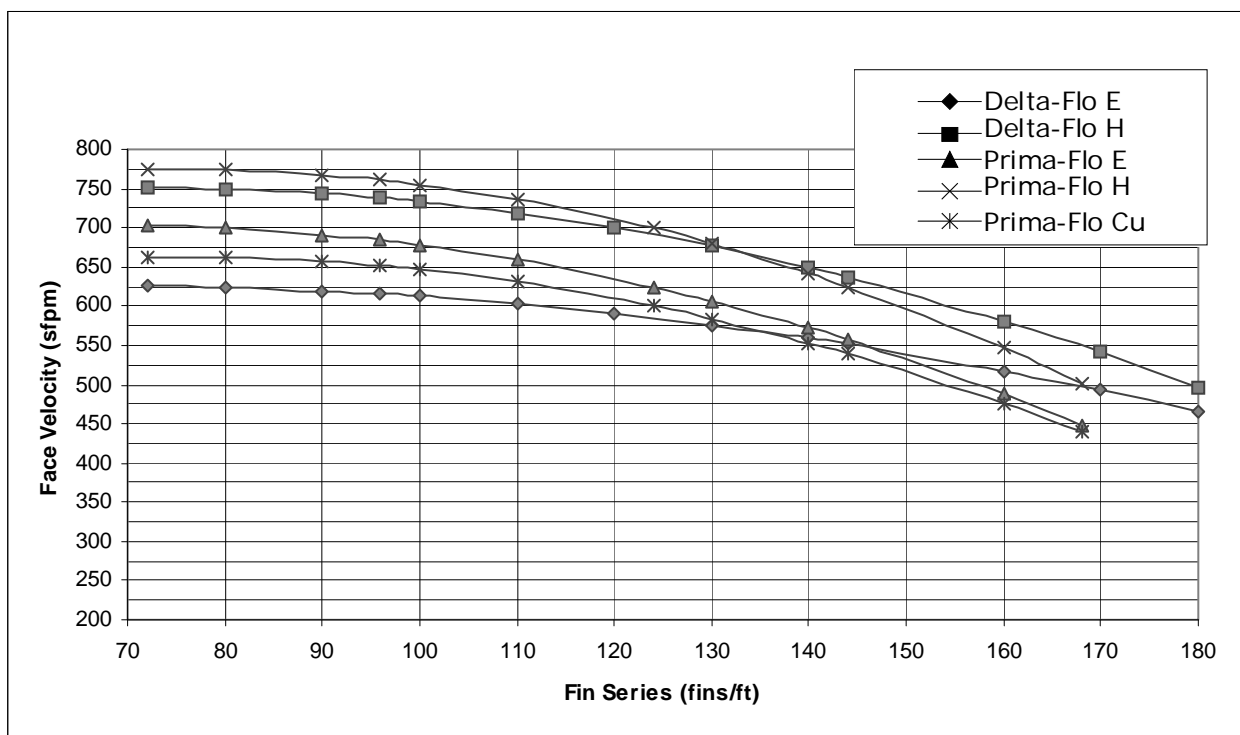


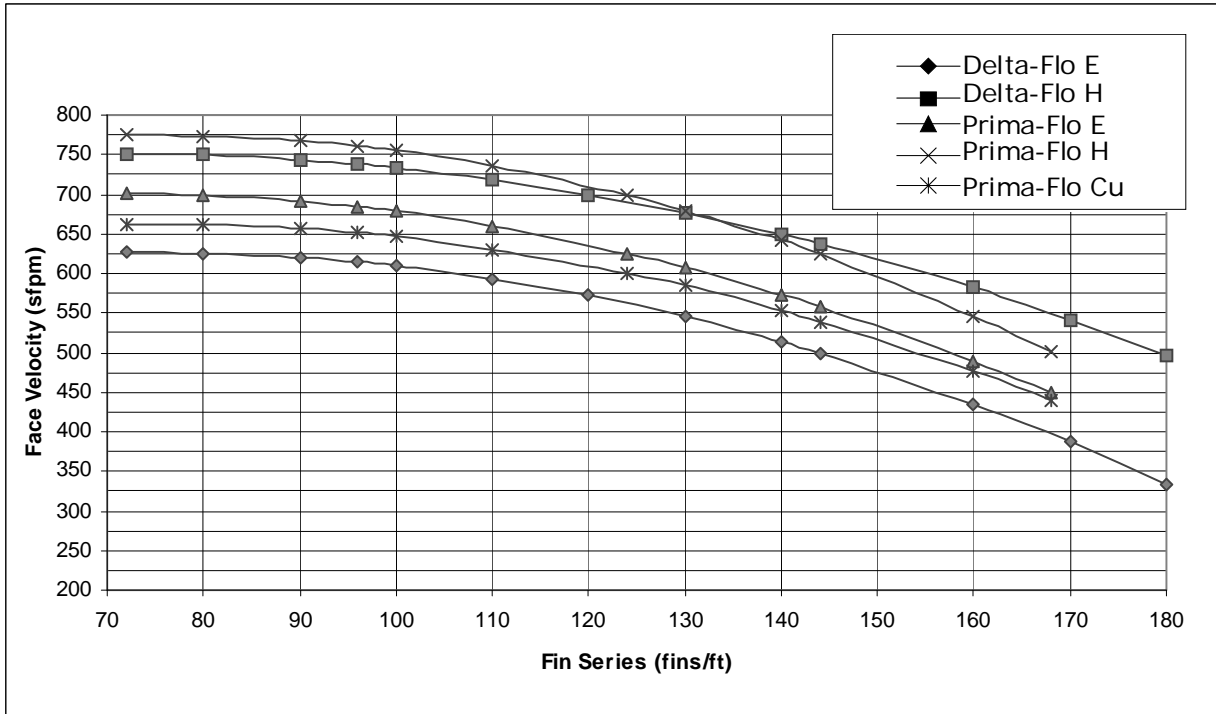
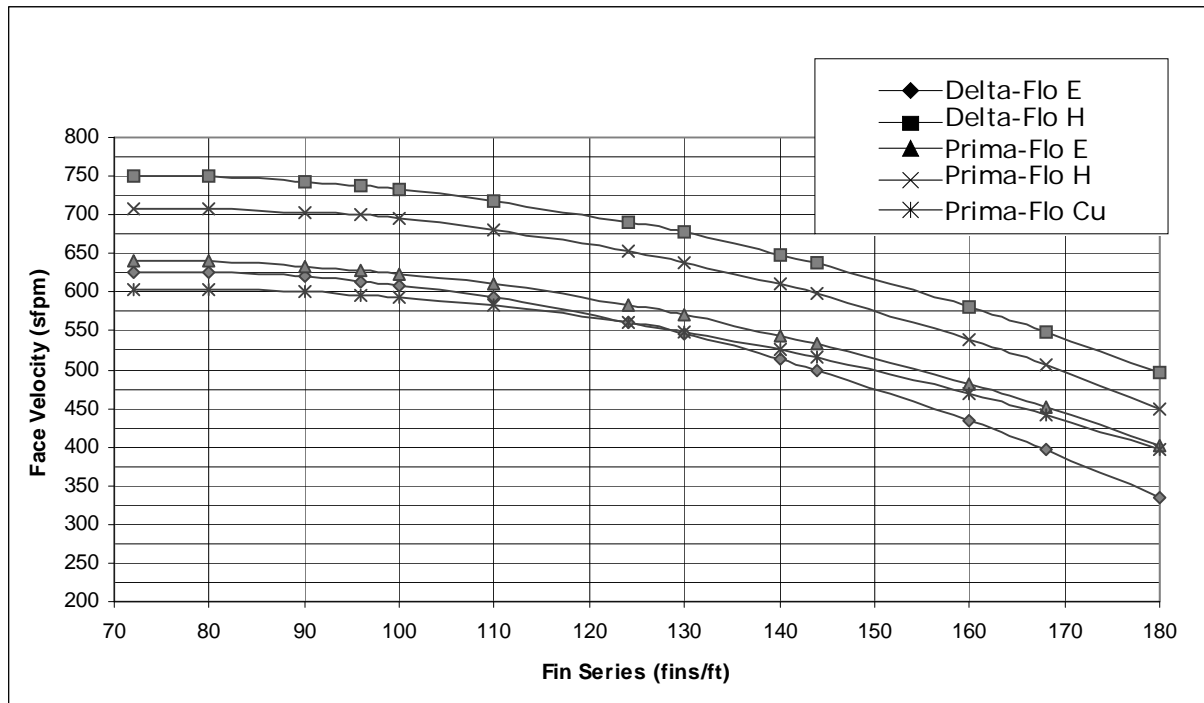
Figure 66. Face-velocity limits for moisture carryover with uncoated coils in unit size 12

Figure 67. Face velocity limits for moisture carryover with uncoated coils in unit sizes 14 to 17


Figure 68. Face velocity limits for moisture carryover with uncoated coils in unit sizes 21 to 30

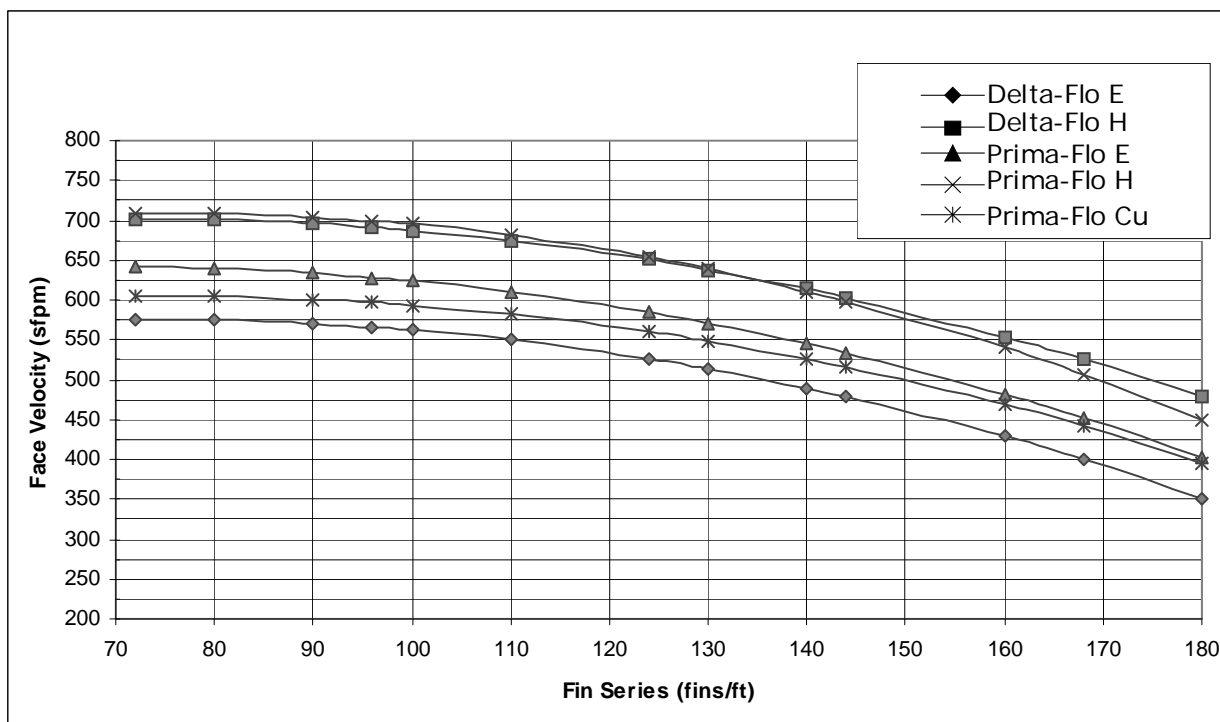
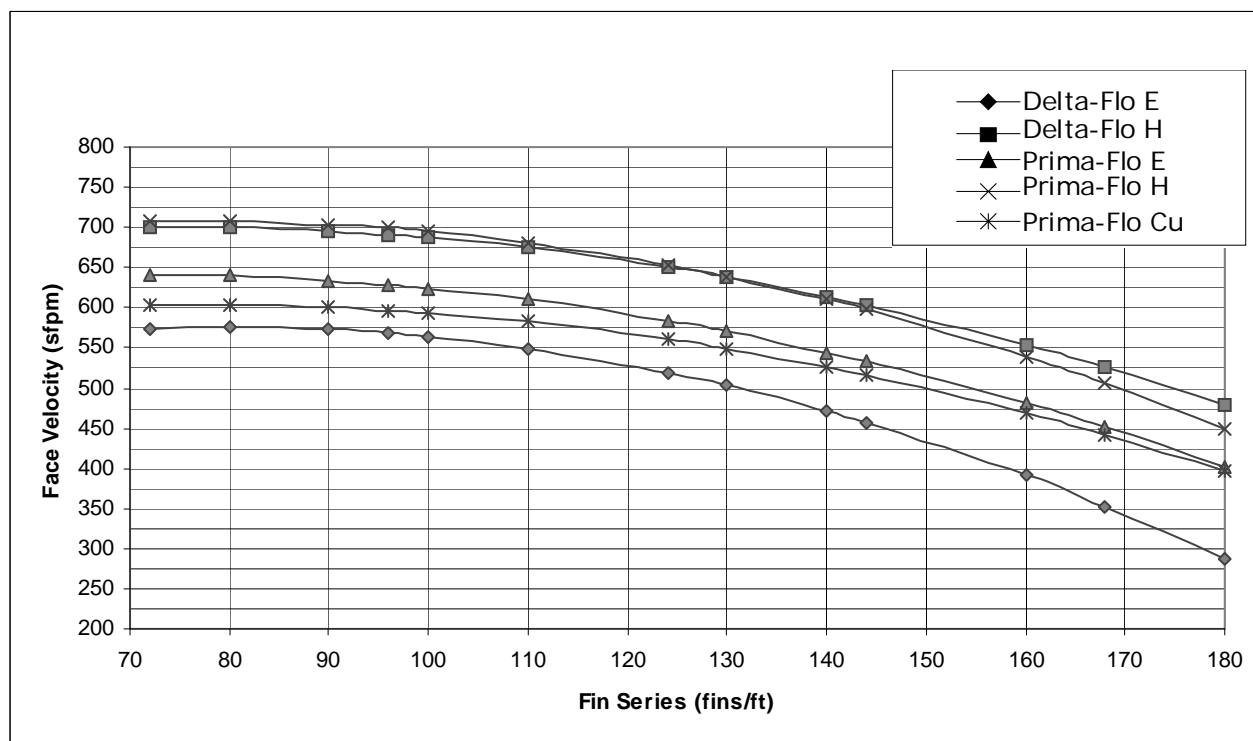


Figure 69. Face velocity limits for moisture carryover with uncoated coils in unit sizes 35 and 40



Coils

Figure 70. Face velocity limits for moisture carryover with uncoated coils in unit sizes 50 to 57

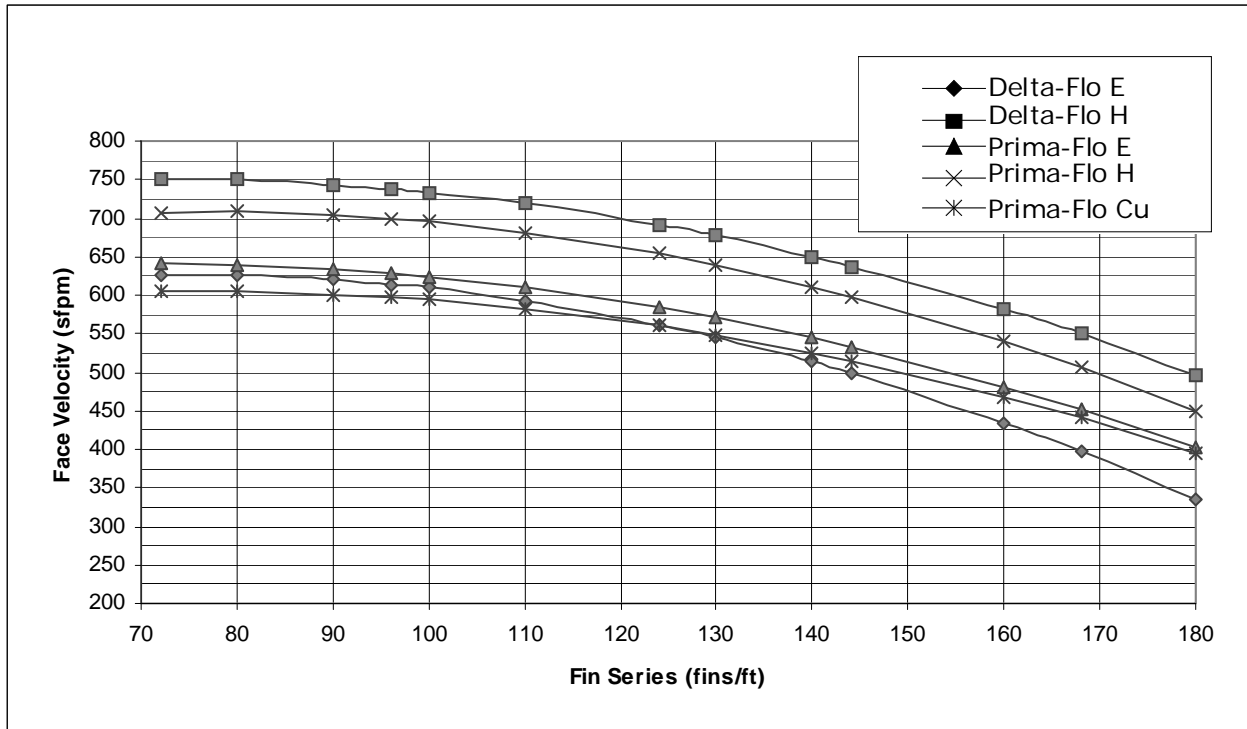


Figure 71. Face velocity limits for moisture carryover with uncoated coils in unit size 66

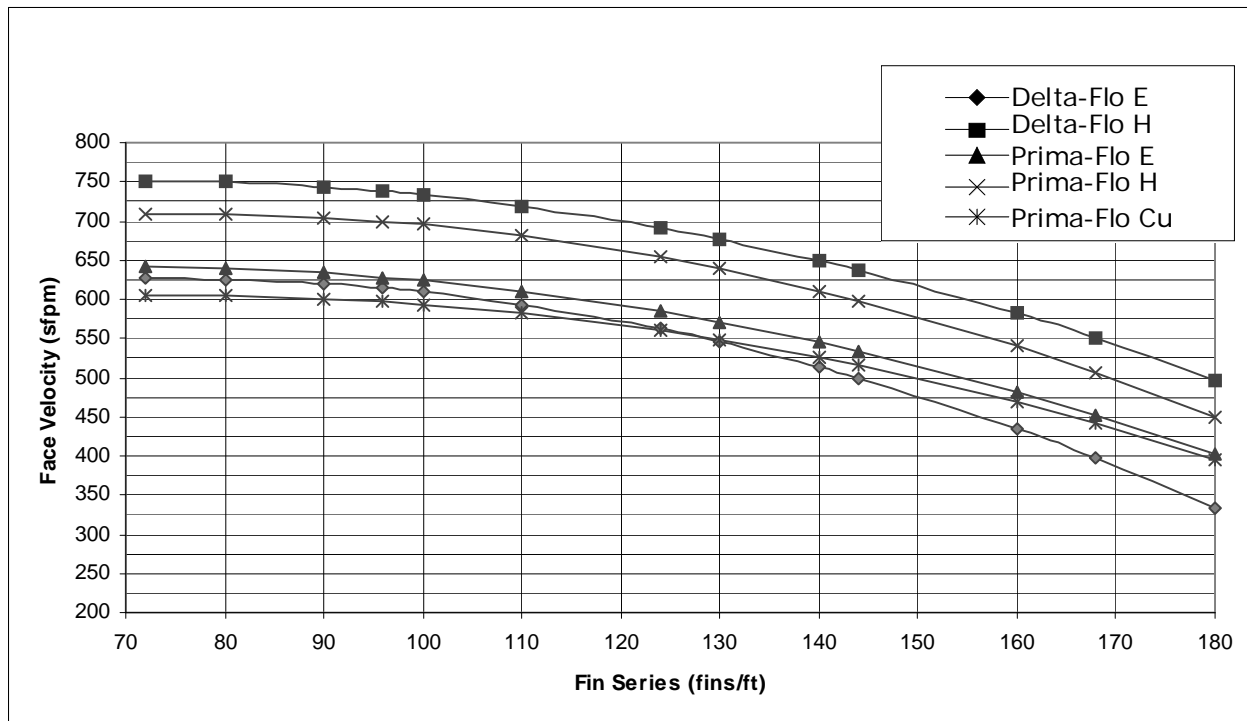
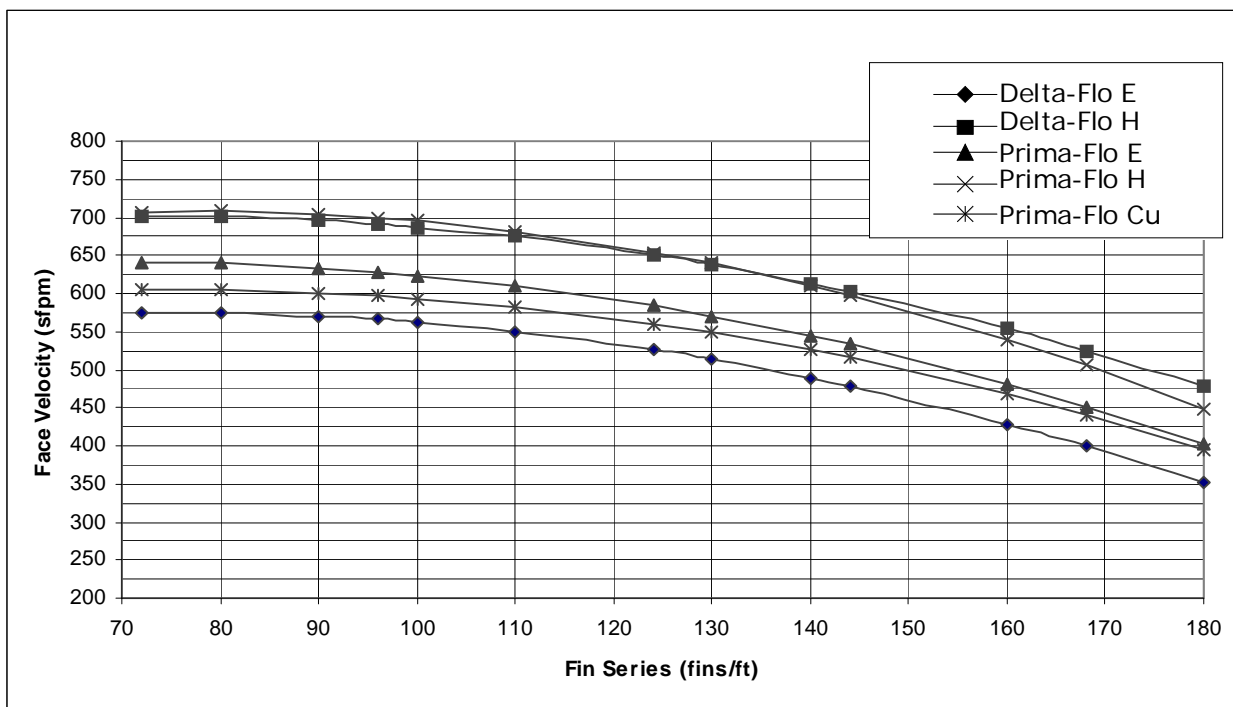


Figure 72. Face velocity limits for moisture carryover with uncoated coils in unit sizes 80 to 120





Performance Data

Air-to-Air Plate Heat Exchangers

Table 152. Air-to-air plate heat exchanger performance data

Unit size	Nominal airflow* cfm	Plate spacing	Bypass exchanger		High efficiency exchanger		Low efficiency exchanger	
			% sensible effectiveness	Pressure drop (in w.g.)	% sensible effectiveness	Pressure drop (in w.g.)	% sensible effectiveness	Pressure drop (in w.g.)
3	1500	Wide	50	0.35	56	0.24	n/a	n/a
		Medium	58	0.59	60	0.32	n/a	n/a
		Close	65	1.21	66	0.67	n/a	n/a
4	2000	Wide	52	0.26	57	0.18	n/a	n/a
		Medium	59	0.40	60	0.25	n/a	n/a
		Close	66	0.83	66	0.54	n/a	n/a
6	3000	Wide	53	0.42	55	0.23	n/a	n/a
		Medium	60	0.58	65	0.43	n/a	n/a
		Close	64	0.76	69	0.89	n/a	n/a
8	4000	Wide	53	0.48	54	0.29	n/a	n/a
		Medium	60	0.66	64	0.54	n/a	n/a
		Close	63	0.87	69	1.10	n/a	n/a
10	5000	Wide	58	0.37	59	0.22	49	0.39
		Medium	61	0.52	62	0.33	54	0.52
		Close	66	0.87	67	0.56	58	0.66
12	6000	Wide	57	0.44	59	0.27	54	0.35
		Medium	61	0.62	62	0.39	61	0.49
		Close	66	1.01	67	0.66	64	0.64
14	7000	Wide	57	0.49	58	0.31	54	0.39
		Medium	60	0.69	62	0.44	60	0.55
		Close	66	1.12	67	0.74	64	0.72
17	8500	Wide	63	0.65	64	0.42	57	0.45
		Medium	67	0.87	68	0.56	61	0.63
		Close	69	1.13	70	0.75	66	1.03
21	10500	Wide	63	0.73	64	0.50	61	0.43
		Medium	64	0.86	68	0.66	64	0.53
		Close	67	0.97	70	0.88	68	0.73
25	12500	Wide	59	0.78	60	0.50	63	0.68
		Medium	66	0.84	67	0.54	65	0.81
		Close	69	0.99	70	0.63	67	0.91
30	15000	Wide	59	0.78	60	0.51	63	0.70
		Medium	66	0.84	67	0.55	65	0.82
		Close	69	0.98	70	0.65	67	0.93
35	17500	Wide	59	0.87	60	0.59	n/a	n/a
		Medium	66	0.94	67	0.64	n/a	n/a
		Close	69	1.09	69	0.75	n/a	n/a
40	20000	Wide	59	0.87	60	0.60	n/a	n/a
		Medium	66	0.94	67	0.65	n/a	n/a
		Close	69	1.10	69	0.76	n/a	n/a
50	25000	Wide	n/a	n/a	n/a	n/a	59	0.72
		Medium	n/a	n/a	n/a	n/a	66	0.78
		Close	n/a	n/a	n/a	n/a	69	0.92

Note: *Stated performance is based on a dry exchanger with the exhaust and ventilation airflow rate equal to the nominal airflow. Performance will vary based on airflow conditions, utilize TOPSS for application specific performance.

Table 153. Air-to-air plate heat exchanger bypass damper performance data

Unit size	Face Area (ft ²)	Static Pressure Drop (inches w.g.) by face velocity (fpm)									
		800	1000	1200	1400	1600	1800	2000	2200	2400	2600
3	1.17	0.23	0.36	0.52	0.71	0.93	1.18				
4	1.34	0.23	0.36	0.52	0.71	0.93	1.18				
6	2.07	0.17	0.26	0.38	0.52	0.67	0.85	1.05	1.27		
8	2.07	0.17	0.26	0.38	0.52	0.67	0.85	1.05	1.27		
10	2.96	0.15	0.23	0.33	0.45	0.59	0.75	0.92	1.12	1.33	
12	3.21	0.14	0.22	0.32	0.44	0.57	0.72	0.89	1.08	1.28	
14	3.45	0.14	0.22	0.31	0.42	0.55	0.70	0.86	1.05	1.25	
17	4.43	0.13	0.21	0.30	0.41	0.53	0.67	0.83	1.00	1.19	
21	4.43	0.13	0.21	0.30	0.41	0.53	0.67	0.83	1.00	1.19	
25	6.34	0.12	0.19	0.28	0.38	0.49	0.62	0.77	0.93	1.11	1.30
30	7.14	0.12	0.19	0.27	0.36	0.47	0.60	0.74	0.90	1.07	1.25
35	7.14	0.12	0.19	0.27	0.36	0.47	0.60	0.74	0.90	1.07	1.25
40	7.93	0.12	0.18	0.26	0.35	0.46	0.58	0.72	0.87	1.04	1.22

Blenders

Table 154. Blender performance data

Unit size	Area (ft ²)	Static Pressure Drop (inches w.g.) by Plenum Face Velocity (fpm)								
		200	250	300	350	400	450	500	550	600
3	1.90	0.03	0.04	0.06	0.08	0.10	0.13	0.16	0.20	0.24
4	2.30	0.04	0.07	0.10	0.13	0.17	0.21	0.27	0.32	0.38
6	3.30	0.03	0.05	0.07	0.10	0.13	0.16	0.20	0.24	0.28
8	3.90	0.04	0.06	0.08	0.11	0.15	0.19	0.23	0.28	0.34
10	4.50	0.04	0.07	0.10	0.14	0.18	0.23	0.28	0.34	0.40
12	5.90	0.04	0.06	0.08	0.11	0.15	0.19	0.23	0.28	0.33
14	5.80	0.05	0.08	0.11	0.15	0.19	0.24	0.30	0.36	0.43
17	9.00	0.03	0.04	0.06	0.08	0.10	0.13	0.16	0.19	0.23
21	10.40	0.03	0.05	0.06	0.09	0.12	0.15	0.18	0.22	0.26
22	9.20	0.04	0.06	0.09	0.12	0.16	0.20	0.24	0.30	0.35
25	11.80	0.03	0.05	0.07	0.10	0.13	0.17	0.20	0.25	0.29
26	11.10	0.05	0.07	0.11	0.15	0.19	0.24	0.30	0.36	0.43
30	15.00	0.03	0.04	0.06	0.08	0.11	0.14	0.17	0.20	0.24
31	13.25	0.05	0.07	0.10	0.14	0.19	0.24	0.29	0.35	0.42
35	15.00	0.04	0.07	0.09	0.13	0.17	0.21	0.26	0.32	0.38
36	15.60	0.05	0.07	0.10	0.14	0.18	0.23	0.28	0.34	0.41
40	17.70	0.04	0.06	0.08	0.11	0.15	0.19	0.23	0.28	0.33
41	18.00	0.05	0.08	0.11	0.15	0.19	0.25	0.30	0.37	0.44
50	22.50	0.04	0.06	0.08	0.12	0.15	0.19	0.24	0.28	0.34
51	25.10	0.03	0.05	0.07	0.10	0.12	0.16	0.19	0.23	0.28
57	24.90	0.04	0.06	0.09	0.12	0.16	0.21	0.25	0.31	0.37



Performance Data

Table 154. Blender performance data

Unit size	Area (ft ²)	Static Pressure Drop (inches w.g.) by Plenum Face Velocity (fpm)								
		200	250	300	350	400	450	500	550	600
58	25.10	0.04	0.07	0.10	0.13	0.17	0.21	0.27	0.32	0.38
66	27.60	0.05	0.07	0.11	0.15	0.19	0.24	0.30	0.36	0.43
80	30.30	0.06	0.09	0.13	0.18	0.23	0.29	0.36	0.43	0.52
100	39.90	0.05	0.08	0.11	0.15	0.20	0.25	0.31	0.37	0.44
120	54.00	0.03	0.05	0.08	0.11	0.14	0.17	0.22	0.26	0.31

Dampers

Energy Wheel Dampers

Table 155. Energy wheel recirculation damper performance data

Unit size	Area (ft ²)	Unducted Pressure Drop															
		400	500	600	700	800	900	1000	1100	1200	1400	1600	1800	2000	2200	2400	2600
3	2.21	0.04	0.06	0.09	0.12	0.16	0.20	0.25	0.30	0.36	0.48	0.63	0.80	0.99	1.20	1.42	1.67
4	2.76	0.04	0.06	0.08	0.12	0.15	0.19	0.24	0.29	0.34	0.46	0.60	0.76	0.94	1.14	1.36	1.59
6	2.76	0.04	0.06	0.08	0.12	0.15	0.19	0.24	0.29	0.34	0.46	0.60	0.76	0.94	1.14	1.36	1.59
8	3.40	0.04	0.06	0.08	0.11	0.15	0.18	0.23	0.28	0.33	0.45	0.58	0.74	0.91	1.10	1.31	1.54
10	4.46	0.04	0.06	0.08	0.11	0.14	0.18	0.22	0.27	0.32	0.43	0.56	0.71	0.88	1.07	1.27	1.49
12	4.95	0.03	0.05	0.08	0.11	0.14	0.18	0.22	0.26	0.31	0.43	0.56	0.71	0.87	1.06	1.26	1.47
14	5.48	0.03	0.05	0.08	0.11	0.14	0.17	0.22	0.26	0.31	0.42	0.55	0.70	0.86	1.05	1.24	1.46
17	5.48	0.03	0.05	0.08	0.11	0.14	0.17	0.22	0.26	0.31	0.42	0.55	0.70	0.86	1.05	1.24	1.46
21	6.26	0.04	0.06	0.09	0.12	0.16	0.20	0.25	0.30	0.35	0.48	0.63	0.79	0.98	1.19	1.41	1.66
25	6.26	0.04	0.06	0.09	0.12	0.16	0.20	0.25	0.30	0.35	0.48	0.63	0.79	0.98	1.19	1.41	1.66
30	7.57	0.04	0.06	0.08	0.12	0.15	0.19	0.24	0.29	0.34	0.46	0.60	0.76	0.94	1.14	1.36	1.59
35	8.20	0.04	0.06	0.08	0.11	0.15	0.19	0.23	0.28	0.34	0.46	0.60	0.75	0.93	1.13	1.34	1.57
40	9.41	0.04	0.06	0.08	0.11	0.15	0.18	0.23	0.28	0.33	0.45	0.58	0.74	0.91	1.10	1.31	1.54
50	10.67	0.04	0.06	0.08	0.11	0.14	0.18	0.22	0.27	0.32	0.44	0.57	0.73	0.90	1.08	1.29	1.51

Table 156. Energy wheel bypass damper performance data

Unit size	Wheel nominal cfm	Area (ft ²)	Unducted Pressure Drop															
			400	500	600	700	800	900	1000	1100	1200	1400	1600	1800	2000	2200	2400	2600
4	900	1.03	0.04	0.07	0.09	0.13	0.17	0.21	0.26	0.32	0.38	0.51	0.67	0.85	1.05	1.27	1.51	1.77
4	1500	1.03	0.04	0.07	0.09	0.13	0.17	0.21	0.26	0.32	0.38	0.51	0.67	0.85	1.05	1.27	1.51	1.77
4	2200	1.03	0.04	0.07	0.09	0.13	0.17	0.21	0.26	0.32	0.38	0.51	0.67	0.85	1.05	1.27	1.51	1.77
6	900	1.03	0.04	0.07	0.09	0.13	0.17	0.21	0.26	0.32	0.38	0.51	0.67	0.85	1.05	1.27	1.51	1.77
6	1500	1.03	0.04	0.07	0.09	0.13	0.17	0.21	0.26	0.32	0.38	0.51	0.67	0.85	1.05	1.27	1.51	1.77
6	2200	1.03	0.04	0.07	0.09	0.13	0.17	0.21	0.26	0.32	0.38	0.51	0.67	0.85	1.05	1.27	1.51	1.77
8	1500	1.83	0.04	0.06	0.08	0.11	0.15	0.19	0.23	0.28	0.33	0.45	0.59	0.75	0.92	1.12	1.33	1.56
8	2200	1.03	0.04	0.07	0.09	0.13	0.17	0.21	0.26	0.32	0.38	0.51	0.67	0.85	1.05	1.27	1.51	1.77
8	3000	1.83	0.04	0.06	0.08	0.11	0.15	0.19	0.23	0.28	0.33	0.45	0.59	0.75	0.92	1.12	1.33	1.56

Table 156. Energy wheel bypass damper performance data

Unit size	Wheel nominal cfm	Area (ft ²)	Unducted Pressure Drop															
			400	500	600	700	800	900	1000	1100	1200	1400	1600	1800	2000	2200	2400	2600
10	2200	1.83	0.04	0.06	0.08	0.11	0.15	0.19	0.23	0.28	0.33	0.45	0.59	0.75	0.92	1.12	1.33	1.56
10	3000	1.83	0.04	0.06	0.08	0.11	0.15	0.19	0.23	0.28	0.33	0.45	0.59	0.75	0.92	1.12	1.33	1.56
10	4000	2.38	0.04	0.06	0.08	0.11	0.14	0.18	0.22	0.27	0.32	0.44	0.57	0.72	0.89	1.08	1.28	1.50
10	5000	2.38	0.04	0.06	0.08	0.11	0.14	0.18	0.22	0.27	0.32	0.44	0.57	0.72	0.89	1.08	1.28	1.50
12	2200	1.83	0.04	0.06	0.08	0.11	0.15	0.19	0.23	0.28	0.33	0.45	0.59	0.75	0.92	1.12	1.33	1.56
12	3000	1.83	0.04	0.06	0.08	0.11	0.15	0.19	0.23	0.28	0.33	0.45	0.59	0.75	0.92	1.12	1.33	1.56
12	4000	2.38	0.04	0.06	0.08	0.11	0.14	0.18	0.22	0.27	0.32	0.44	0.57	0.72	0.89	1.08	1.28	1.50
12	5000	3.05	0.03	0.05	0.08	0.11	0.14	0.18	0.22	0.26	0.31	0.42	0.55	0.70	0.87	1.05	1.25	1.46
12	6000	3.05	0.03	0.05	0.08	0.11	0.14	0.18	0.22	0.26	0.31	0.42	0.55	0.70	0.87	1.05	1.25	1.46
14	2200	2.38	0.04	0.06	0.08	0.11	0.14	0.18	0.22	0.27	0.32	0.44	0.57	0.72	0.89	1.08	1.28	1.50
14	3000	1.83	0.04	0.06	0.08	0.11	0.15	0.19	0.23	0.28	0.33	0.45	0.59	0.75	0.92	1.12	1.33	1.56
14	4000	2.38	0.04	0.06	0.08	0.11	0.14	0.18	0.22	0.27	0.32	0.44	0.57	0.72	0.89	1.08	1.28	1.50
14	5000	3.05	0.03	0.05	0.08	0.11	0.14	0.18	0.22	0.26	0.31	0.42	0.55	0.70	0.87	1.05	1.25	1.46
14	6000	3.05	0.03	0.05	0.08	0.11	0.14	0.18	0.22	0.26	0.31	0.42	0.55	0.70	0.87	1.05	1.25	1.46
14	7000	3.05	0.03	0.05	0.08	0.11	0.14	0.18	0.22	0.26	0.31	0.42	0.55	0.70	0.87	1.05	1.25	1.46
17	3000	3.05	0.03	0.05	0.08	0.11	0.14	0.18	0.22	0.26	0.31	0.42	0.55	0.70	0.87	1.05	1.25	1.46
17	4000	2.38	0.04	0.06	0.08	0.11	0.14	0.18	0.22	0.27	0.32	0.44	0.57	0.72	0.89	1.08	1.28	1.50
17	5000	3.05	0.03	0.05	0.08	0.11	0.14	0.18	0.22	0.26	0.31	0.42	0.55	0.70	0.87	1.05	1.25	1.46
17	6000	3.51	0.03	0.05	0.08	0.10	0.14	0.17	0.21	0.26	0.31	0.42	0.55	0.69	0.86	1.04	1.23	1.45
17	7000	3.51	0.03	0.05	0.08	0.10	0.14	0.17	0.21	0.26	0.31	0.42	0.55	0.69	0.86	1.04	1.23	1.45
21	3000	3.05	0.03	0.05	0.08	0.11	0.14	0.18	0.22	0.26	0.31	0.42	0.55	0.70	0.87	1.05	1.25	1.46
21	4000	5.09	0.02	0.04	0.05	0.07	0.10	0.12	0.15	0.18	0.22	0.29	0.38	0.48	0.60	0.72	0.86	1.01
21	5000	3.05	0.03	0.05	0.08	0.11	0.14	0.18	0.22	0.26	0.31	0.42	0.55	0.70	0.87	1.05	1.25	1.46
21	6000	3.51	0.03	0.05	0.08	0.10	0.14	0.17	0.21	0.26	0.31	0.42	0.55	0.69	0.86	1.04	1.23	1.45
21	7000	3.77	0.03	0.05	0.08	0.10	0.14	0.17	0.21	0.26	0.31	0.42	0.54	0.69	0.85	1.03	1.23	1.44
21	8500	4.00	0.04	0.06	0.09	0.12	0.15	0.19	0.24	0.29	0.35	0.47	0.62	0.78	0.96	1.16	1.38	1.62
25	4000	5.09	0.02	0.04	0.05	0.07	0.10	0.12	0.15	0.18	0.22	0.29	0.38	0.48	0.60	0.72	0.86	1.01
25	5000	5.09	0.02	0.04	0.05	0.07	0.10	0.12	0.15	0.18	0.22	0.29	0.38	0.48	0.60	0.72	0.86	1.01
25	6000	5.09	0.02	0.04	0.05	0.07	0.10	0.12	0.15	0.18	0.22	0.29	0.38	0.48	0.60	0.72	0.86	1.01
25	7000	3.77	0.03	0.05	0.08	0.10	0.14	0.17	0.21	0.26	0.31	0.42	0.54	0.69	0.85	1.03	1.23	1.44
25	8500	6.31	0.03	0.04	0.06	0.08	0.11	0.14	0.17	0.20	0.24	0.33	0.43	0.55	0.67	0.81	0.97	1.14
30	4000	5.09	0.02	0.04	0.05	0.07	0.10	0.12	0.15	0.18	0.22	0.29	0.38	0.48	0.60	0.72	0.86	1.01
30	5000	5.09	0.02	0.04	0.05	0.07	0.10	0.12	0.15	0.18	0.22	0.29	0.38	0.48	0.60	0.72	0.86	1.01
30	6000	5.09	0.02	0.04	0.05	0.07	0.10	0.12	0.15	0.18	0.22	0.29	0.38	0.48	0.60	0.72	0.86	1.01
30	7000	3.77	0.03	0.05	0.08	0.10	0.14	0.17	0.21	0.26	0.31	0.42	0.54	0.69	0.85	1.03	1.23	1.44
30	8500	6.31	0.03	0.04	0.06	0.08	0.11	0.14	0.17	0.20	0.24	0.33	0.43	0.55	0.67	0.81	0.97	1.14
30	10500	5.09	0.02	0.04	0.05	0.07	0.10	0.12	0.15	0.18	0.22	0.29	0.38	0.48	0.60	0.72	0.86	1.01
30	12500	6.31	0.03	0.04	0.06	0.08	0.11	0.14	0.17	0.20	0.24	0.33	0.43	0.55	0.67	0.81	0.97	1.14



Performance Data

Table 156. Energy wheel bypass damper performance data

Unit size	Wheel nominal cfm	Area (ft ²)	Unducted Pressure Drop																
			400	500	600	700	800	900	1000	1100	1200	1400	1600	1800	2000	2200	2400	2600	
35	5000	5.09	0.02	0.04	0.05	0.07	0.10	0.12	0.15	0.18	0.22	0.29	0.38	0.48	0.60	0.72	0.86	1.01	
35	6000	5.09	0.02	0.04	0.05	0.07	0.10	0.12	0.15	0.18	0.22	0.29	0.38	0.48	0.60	0.72	0.86	1.01	
35	7000	5.09	0.02	0.04	0.05	0.07	0.10	0.12	0.15	0.18	0.22	0.29	0.38	0.48	0.60	0.72	0.86	1.01	
35	8500	6.31	0.03	0.04	0.06	0.08	0.11	0.14	0.17	0.20	0.24	0.33	0.43	0.55	0.67	0.81	0.97	1.14	
35	10500	5.09	0.02	0.04	0.05	0.07	0.10	0.12	0.15	0.18	0.22	0.29	0.38	0.48	0.60	0.72	0.86	1.01	
35	12500	6.31	0.03	0.04	0.06	0.08	0.11	0.14	0.17	0.20	0.24	0.33	0.43	0.55	0.67	0.81	0.97	1.14	
35	15000	7.28	0.03	0.04	0.06	0.08	0.10	0.13	0.16	0.20	0.24	0.32	0.42	0.53	0.65	0.79	0.94	1.10	
35	17500	8.20	0.03	0.04	0.06	0.08	0.10	0.13	0.16	0.19	0.23	0.31	0.41	0.52	0.64	0.77	0.92	1.08	
40	5000	5.09	0.02	0.04	0.05	0.07	0.10	0.12	0.15	0.18	0.22	0.29	0.38	0.48	0.60	0.72	0.86	1.01	
40	6000	5.09	0.02	0.04	0.05	0.07	0.10	0.12	0.15	0.18	0.22	0.29	0.38	0.48	0.60	0.72	0.86	1.01	
40	7000	5.09	0.02	0.04	0.05	0.07	0.10	0.12	0.15	0.18	0.22	0.29	0.38	0.48	0.60	0.72	0.86	1.01	
40	8500	6.31	0.03	0.04	0.06	0.08	0.11	0.14	0.17	0.20	0.24	0.33	0.43	0.55	0.67	0.81	0.97	1.14	
40	10500	5.09	0.02	0.04	0.05	0.07	0.10	0.12	0.15	0.18	0.22	0.29	0.38	0.48	0.60	0.72	0.86	1.01	
40	12500	6.31	0.03	0.04	0.06	0.08	0.11	0.14	0.17	0.20	0.24	0.33	0.43	0.55	0.67	0.81	0.97	1.14	
40	15000	7.28	0.03	0.04	0.06	0.08	0.10	0.13	0.16	0.20	0.24	0.32	0.42	0.53	0.65	0.79	0.94	1.10	
40	17500	8.20	0.03	0.04	0.06	0.08	0.10	0.13	0.16	0.19	0.23	0.31	0.41	0.52	0.64	0.77	0.92	1.08	
40	20000	9.90	0.02	0.04	0.06	0.08	0.10	0.13	0.16	0.19	0.22	0.30	0.40	0.50	0.62	0.75	0.90	1.05	
50	7000	6.31	0.03	0.04	0.06	0.08	0.11	0.14	0.17	0.20	0.24	0.33	0.43	0.55	0.67	0.81	0.97	1.14	
50	8500	6.31	0.03	0.04	0.06	0.08	0.11	0.14	0.17	0.20	0.24	0.33	0.43	0.55	0.67	0.81	0.97	1.14	
50	10500	5.09	0.02	0.04	0.05	0.07	0.10	0.12	0.15	0.18	0.22	0.29	0.38	0.48	0.60	0.72	0.86	1.01	
50	12500	6.31	0.03	0.04	0.06	0.08	0.11	0.14	0.17	0.20	0.24	0.33	0.43	0.55	0.67	0.81	0.97	1.14	
50	15000	7.28	0.03	0.04	0.06	0.08	0.10	0.13	0.16	0.20	0.24	0.32	0.42	0.53	0.65	0.79	0.94	1.10	
50	17500	8.20	0.03	0.04	0.06	0.08	0.10	0.13	0.16	0.19	0.23	0.31	0.41	0.52	0.64	0.77	0.92	1.08	
50	20000	9.90	0.02	0.04	0.06	0.08	0.10	0.13	0.16	0.19	0.22	0.30	0.40	0.50	0.62	0.75	0.90	1.05	
50	25000	10.96	0.02	0.04	0.06	0.08	0.10	0.12	0.15	0.19	0.22	0.30	0.39	0.50	0.61	0.74	0.88	1.04	

Mixing Box Dampers

Mixing box with airfoil blade dampers

Table 157. Mixing box with front, back, top, and bottom airfoil blade dampers (unducted)

Unit Size	Area (ft ²)	Static Pressure Drop (inches wg) by Damper Face Velocity															
		400	500	600	700	800	900	1000	1100	1200	1400	1600	1800	2000	2200	2400	2600
3	1.29	0.05	0.07	0.11	0.14	0.19	0.24	0.29	0.36	0.42	0.58	0.75	0.95	1.17	1.42	1.69	1.99
4	1.87	0.04	0.06	0.09	0.13	0.16	0.21	0.26	0.31	0.37	0.50	0.66	0.83	1.03	1.25	1.48	1.74
6	2.45	0.04	0.06	0.09	0.12	0.15	0.20	0.24	0.29	0.35	0.47	0.62	0.78	0.96	1.17	1.39	1.63
8	3.33	0.04	0.06	0.08	0.11	0.15	0.19	0.23	0.28	0.33	0.45	0.58	0.74	0.91	1.11	1.32	1.54
10	4.16	0.04	0.06	0.08	0.11	0.14	0.18	0.22	0.27	0.32	0.43	0.57	0.72	0.89	1.07	1.28	1.50
12	5.10	0.03	0.05	0.08	0.11	0.14	0.18	0.22	0.26	0.31	0.43	0.56	0.70	0.87	1.05	1.25	1.47
14	5.66	0.03	0.05	0.07	0.10	0.12	0.16	0.19	0.24	0.28	0.38	0.50	0.63	0.78	0.94	1.12	1.31
17	6.99	0.03	0.05	0.07	0.09	0.12	0.15	0.19	0.23	0.27	0.37	0.49	0.62	0.76	0.92	1.09	1.28

Table 157. Mixing box with front, back, top, and bottom airfoil blade dampers (unducted)

Unit Size	Area (ft ²)	Static Pressure Drop (inches wg) by Damper Face Velocity															
		400	500	600	700	800	900	1000	1100	1200	1400	1600	1800	2000	2200	2400	2600
21	8.64	0.03	0.05	0.07	0.09	0.12	0.15	0.19	0.23	0.27	0.37	0.48	0.60	0.75	0.90	1.07	1.26
22	7.26	0.03	0.05	0.07	0.09	0.12	0.15	0.18	0.22	0.26	0.36	0.46	0.59	0.73	0.88	1.04	1.23
25	10.36	0.03	0.04	0.06	0.09	0.11	0.14	0.17	0.21	0.25	0.34	0.45	0.57	0.70	0.85	1.01	1.18
26	10.53	0.03	0.04	0.06	0.08	0.11	0.14	0.17	0.20	0.24	0.33	0.43	0.55	0.67	0.82	0.97	1.14
30	12.04	0.03	0.04	0.06	0.08	0.11	0.14	0.17	0.21	0.25	0.34	0.44	0.56	0.69	0.84	0.99	1.17
31	11.07	0.03	0.04	0.06	0.08	0.11	0.14	0.17	0.20	0.24	0.33	0.43	0.55	0.68	0.82	0.98	1.15
35	14.32	0.03	0.04	0.06	0.09	0.11	0.14	0.18	0.22	0.26	0.35	0.46	0.58	0.72	0.87	1.03	1.21
36	10.01	0.03	0.04	0.06	0.09	0.11	0.14	0.18	0.21	0.25	0.34	0.45	0.57	0.70	0.85	1.01	1.18
40	16.29	0.03	0.04	0.06	0.09	0.11	0.14	0.18	0.22	0.26	0.35	0.46	0.58	0.72	0.87	1.03	1.21
41	12.32	0.03	0.05	0.07	0.09	0.12	0.15	0.18	0.22	0.26	0.36	0.47	0.59	0.73	0.89	1.06	1.24
50	18.59	0.03	0.04	0.06	0.09	0.11	0.14	0.18	0.21	0.25	0.35	0.45	0.57	0.71	0.85	1.02	1.19
51	17.47	0.03	0.04	0.06	0.08	0.10	0.13	0.16	0.19	0.23	0.31	0.41	0.52	0.64	0.78	0.92	1.09
57	22.79	0.03	0.04	0.06	0.08	0.11	0.14	0.17	0.20	0.24	0.33	0.43	0.55	0.68	0.82	0.97	1.14
58	19.45	0.03	0.04	0.06	0.08	0.10	0.13	0.16	0.19	0.23	0.31	0.40	0.51	0.63	0.76	0.91	1.07
66	26.04	0.03	0.04	0.06	0.08	0.11	0.14	0.17	0.20	0.24	0.33	0.43	0.54	0.67	0.81	0.96	1.13
80	30.83	0.03	0.04	0.06	0.08	0.10	0.13	0.16	0.20	0.23	0.32	0.42	0.53	0.65	0.78	0.93	1.10
100	39.78	0.03	0.04	0.06	0.08	0.10	0.13	0.16	0.19	0.23	0.31	0.40	0.51	0.63	0.76	0.91	1.06
120	47.87	0.03	0.04	0.06	0.08	0.10	0.13	0.16	0.19	0.23	0.31	0.41	0.52	0.64	0.78	0.92	1.08

Table 158. Mixing box with front, back, top, and bottom airfoil blade dampers (ducted)

Unit Size	Area (ft ²)	Static Pressure Drop (inches w.g.) by Damper Face Velocity															
		400	500	600	700	800	900	1000	1100	1200	1400	1600	1800	2000	2200	2400	2600
3	1.29	0.07	0.10	0.15	0.20	0.26	0.33	0.41	0.49	0.59	0.80	1.04	1.32	1.63	1.98	2.35	2.76
4	1.87	0.05	0.07	0.11	0.15	0.19	0.24	0.30	0.36	0.43	0.59	0.77	0.97	1.20	1.45	1.72	2.02
6	2.45	0.04	0.06	0.09	0.12	0.16	0.20	0.25	0.30	0.36	0.49	0.64	0.81	1.00	1.21	1.44	1.69
8	3.33	0.03	0.05	0.08	0.10	0.14	0.17	0.21	0.26	0.31	0.42	0.55	0.69	0.86	1.04	1.23	1.45
10	4.16	0.03	0.05	0.07	0.10	0.12	0.16	0.19	0.24	0.28	0.38	0.50	0.63	0.78	0.94	1.12	1.32
12	5.10	0.03	0.05	0.07	0.09	0.12	0.15	0.18	0.22	0.26	0.36	0.46	0.59	0.73	0.88	1.04	1.23
14	5.66	0.02	0.03	0.05	0.06	0.08	0.10	0.13	0.16	0.19	0.25	0.33	0.42	0.52	0.62	0.74	0.87
17	6.99	0.02	0.03	0.04	0.06	0.08	0.10	0.12	0.14	0.17	0.23	0.30	0.38	0.47	0.57	0.68	0.79
21	8.64	0.02	0.03	0.04	0.05	0.07	0.09	0.11	0.13	0.16	0.21	0.28	0.35	0.43	0.53	0.63	0.73
22	7.26	0.02	0.02	0.04	0.05	0.06	0.08	0.10	0.12	0.14	0.19	0.25	0.32	0.40	0.48	0.57	0.67
25	10.36	0.01	0.02	0.03	0.04	0.05	0.07	0.08	0.10	0.12	0.16	0.21	0.27	0.33	0.40	0.48	0.56
26	10.53	0.01	0.02	0.03	0.04	0.05	0.06	0.07	0.09	0.10	0.14	0.18	0.23	0.29	0.35	0.41	0.48
30	12.04	0.01	0.02	0.03	0.04	0.05	0.06	0.08	0.10	0.11	0.15	0.20	0.26	0.32	0.38	0.45	0.53
31	11.07	0.01	0.02	0.03	0.04	0.05	0.06	0.07	0.09	0.11	0.14	0.19	0.24	0.29	0.35	0.42	0.49
35	14.32	0.01	0.02	0.03	0.04	0.05	0.07	0.08	0.10	0.12	0.16	0.21	0.26	0.33	0.39	0.47	0.55
36	10.01	0.01	0.02	0.03	0.04	0.05	0.07	0.08	0.10	0.12	0.17	0.22	0.27	0.34	0.41	0.49	0.57
40	16.29	0.01	0.02	0.03	0.04	0.05	0.07	0.08	0.10	0.12	0.16	0.21	0.27	0.33	0.40	0.48	0.56
41	12.32	0.01	0.02	0.03	0.04	0.06	0.07	0.09	0.11	0.13	0.18	0.23	0.29	0.36	0.43	0.52	0.61
50	18.59	0.01	0.02	0.03	0.04	0.05	0.06	0.08	0.10	0.11	0.16	0.20	0.26	0.32	0.38	0.46	0.54
51	17.47	0.01	0.01	0.02	0.03	0.04	0.04	0.05	0.07	0.08	0.11	0.14	0.18	0.22	0.27	0.32	0.37
57	22.79	0.01	0.02	0.02	0.03	0.04	0.05	0.06	0.08	0.09	0.13	0.16	0.21	0.26	0.31	0.37	0.43
58	19.45	0.01	0.01	0.02	0.02	0.03	0.04	0.05	0.06	0.07	0.10	0.13	0.16	0.20	0.24	0.28	0.33



Performance Data

Table 158. Mixing box with front, back, top, and bottom airfoil blade dampers (ducted)

Unit Size	Area (ft ²)	Static Pressure Drop (inches w.g.) by Damper Face Velocity															
		400	500	600	700	800	900	1000	1100	1200	1400	1600	1800	2000	2200	2400	2600
66	26.04	0.01	0.02	0.02	0.03	0.04	0.05	0.06	0.07	0.09	0.12	0.16	0.20	0.24	0.29	0.35	0.41
80	30.83	0.01	0.01	0.02	0.03	0.03	0.04	0.05	0.06	0.07	0.10	0.13	0.17	0.21	0.25	0.30	0.35
100	39.78	0.01	0.01	0.02	0.02	0.03	0.04	0.04	0.05	0.06	0.09	0.11	0.14	0.17	0.21	0.25	0.30
120	47.87	0.01	0.01	0.02	0.02	0.03	0.04	0.05	0.06	0.07	0.09	0.12	0.15	0.18	0.22	0.26	0.31

Mixing box with Traq dampers

Table 159. Mixing box with front/back/top standard and low-flow Traq dampers

Unit Size	Damper Size (in)	Damper Quantity	Area (sq ft)	Traq Damper Velocity (fpm) vs. Delta P (w.g.)								
				800	900	1000	1100	1200	1300	1400	1500	1600
3	13	1	0.92	0.06	0.07	0.09	0.11	0.13	0.15	0.17	0.20	0.23
4	13	2	1.84	0.06	0.07	0.09	0.11	0.13	0.15	0.17	0.20	0.23
6	13	2	1.84	0.06	0.07	0.09	0.11	0.13	0.15	0.17	0.20	0.23
8	13	3	2.77	0.06	0.07	0.09	0.11	0.13	0.15	0.17	0.20	0.23
10	13	3	2.77	0.06	0.07	0.09	0.11	0.13	0.15	0.17	0.20	0.23
12	16	3	4.19	0.06	0.07	0.09	0.11	0.13	0.15	0.17	0.20	0.23
14	16	3	4.19	0.06	0.07	0.09	0.11	0.13	0.15	0.17	0.20	0.23
17	16	3	4.19	0.06	0.07	0.09	0.11	0.13	0.15	0.17	0.20	0.23
21	20	3	6.54	0.06	0.07	0.09	0.10	0.12	0.14	0.17	0.19	0.21
22	16	4	5.59	0.06	0.07	0.09	0.11	0.13	0.15	0.17	0.20	0.23
25	20	3	6.54	0.06	0.07	0.09	0.10	0.12	0.14	0.17	0.19	0.21
26	16	4	5.59	0.06	0.07	0.09	0.11	0.13	0.15	0.17	0.20	0.23
30	24	3	9.42	0.06	0.07	0.09	0.10	0.12	0.14	0.17	0.19	0.21
31	20	4	8.73	0.06	0.07	0.09	0.10	0.12	0.14	0.17	0.19	0.21
35	24	3	9.42	0.06	0.07	0.09	0.10	0.12	0.14	0.17	0.19	0.21
36	24	3	9.42	0.06	0.07	0.09	0.10	0.12	0.14	0.17	0.19	0.21
40	24	3	9.42	0.06	0.07	0.09	0.10	0.12	0.14	0.17	0.19	0.21
41	24	3	9.42	0.06	0.07	0.09	0.10	0.12	0.14	0.17	0.19	0.21
50	28	3	12.83	0.06	0.07	0.09	0.10	0.12	0.14	0.17	0.19	0.21
51	28	3	12.83	0.06	0.07	0.09	0.10	0.12	0.14	0.17	0.19	0.21
57	28	3	12.83	0.06	0.07	0.09	0.10	0.12	0.14	0.17	0.19	0.21
58	28	3	12.83	0.06	0.07	0.09	0.10	0.12	0.14	0.17	0.19	0.21
66	28	4	17.10	0.06	0.07	0.09	0.10	0.12	0.14	0.17	0.19	0.21
80	28	5	21.38	0.06	0.07	0.09	0.10	0.12	0.14	0.17	0.19	0.21
100	28	6	25.66	0.06	0.07	0.09	0.10	0.12	0.14	0.17	0.19	0.21
120	28	6	25.66	0.06	0.07	0.09	0.10	0.12	0.14	0.17	0.19	0.21

Notes: 1. Data a standard air density. 2. Traq damper airflow measurement station (AMS) ratings are based on AMCA Standard 610 Test Setup Figure 4 using differential pressure measurement with voltage signals from a Trane ventilation control module (VCM). 3. Performance of Traq dampers will be +/- 5 percent of data shown for AMCA 610 Test Setup Figure 4. 4. Sizes and shapes tested include 16-inch and 28-inch diameter circular. Rated sizes are from 13 inches to 24 inches diameter circular. 5. Low-flow Traq option includes one damper for minimum outside air and remaining dampers are for economizing.

Table 160. Mixing box with front/back/top standard and low-flow Traq dampers

Unit Size	Traq Damper Size (in)	Traq Damper Quantity	Damper Area (sq ft)	Traq Damper Velocity (fpm) vs. Delta P (w.g.)								
				1700	1800	1900	2000	2100	2200	2300	2400	2500
3	13	1	0.92	0.26	0.29	0.32	0.35	0.39	0.43	0.47	0.51	0.56
4	13	2	1.84	0.26	0.29	0.32	0.35	0.39	0.43	0.47	0.51	0.56
6	13	2	1.84	0.26	0.29	0.32	0.35	0.39	0.43	0.47	0.51	0.56
8	13	3	2.77	0.26	0.29	0.32	0.35	0.39	0.43	0.47	0.51	0.56
10	13	3	2.77	0.26	0.29	0.32	0.35	0.39	0.43	0.47	0.51	0.56
12	16	3	4.19	0.26	0.29	0.32	0.35	0.39	0.43	0.47	0.51	0.56
14	16	3	4.19	0.26	0.29	0.32	0.35	0.39	0.43	0.47	0.51	0.56
17	16	3	4.19	0.26	0.29	0.32	0.35	0.39	0.43	0.47	0.51	0.56
21	20	3	6.54	0.24	0.27	0.30	0.33	0.37	0.40	0.44	0.48	0.52
22	16	4	5.59	0.26	0.29	0.32	0.35	0.39	0.43	0.47	0.51	0.56
25	20	3	6.54	0.24	0.27	0.30	0.33	0.37	0.40	0.44	0.48	0.52
26	16	4	5.59	0.26	0.29	0.32	0.35	0.39	0.43	0.47	0.51	0.56
30	24	3	9.42	0.24	0.27	0.30	0.33	0.37	0.40	0.44	0.48	0.52
31	20	4	8.73	0.24	0.27	0.30	0.33	0.37	0.40	0.44	0.48	0.52
35	24	3	9.42	0.24	0.27	0.30	0.33	0.37	0.40	0.44	0.48	0.52
36	24	3	9.42	0.24	0.27	0.30	0.33	0.37	0.40	0.44	0.48	0.52
40	24	3	9.42	0.24	0.27	0.30	0.33	0.37	0.40	0.44	0.48	0.52
41	24	3	9.42	0.24	0.27	0.30	0.33	0.37	0.40	0.44	0.48	0.52
50	28	3	12.83	0.24	0.27	0.30	0.33	0.37	0.40	0.44	0.48	0.52
51	28	3	12.83	0.24	0.27	0.30	0.33	0.37	0.40	0.44	0.48	0.52
57	28	3	12.83	0.24	0.27	0.30	0.33	0.37	0.40	0.44	0.48	0.52
58	28	3	12.83	0.24	0.27	0.30	0.33	0.37	0.40	0.44	0.48	0.52
66	28	4	17.10	0.24	0.27	0.30	0.33	0.37	0.40	0.44	0.48	0.52
80	28	5	21.38	0.24	0.27	0.30	0.33	0.37	0.40	0.44	0.48	0.52
100	28	6	25.66	0.24	0.27	0.30	0.33	0.37	0.40	0.44	0.48	0.52
120	28	6	25.66	0.24	0.27	0.30	0.33	0.37	0.40	0.44	0.48	0.52

Notes: 1. Data a standard air density. 2. Traq damper airflow measurement station (AMS) ratings are based on AMCA Standard 610 Test Setup Figure 4 using differential pressure measurement with voltage signals from a Trane ventilation control module (VCM). 3. Performance of Traq dampers will be +/- 5 percent of data shown for AMCA 610 Test Setup Figure 4. 4. Sizes and shapes tested include 16-inch and 28-inch diameter circular. Rated sizes are from 13 inches to 24 inches diameter circular. 5. Low-flow Traq option includes one damper for minimum outside air and remaining dampers are for economizing.



Trane certifies that the Traq damper shown herein is licensed to bear the AMCA seal - Airflow Measurement Station Performance. The rating shown is based on tests and procedures performed in accordance with AMCA Publication 611 and complies with the requirements of the AMCA Certified Ratings Program.



Performance Data

AMCA 610 Test Performance for Traq Damper

Table 161. Air Performance

Test Run	Reference Volume (cfm)	Indicated Volume (cfm)	Difference (percent)
Traq 16-inch damper AMS			
1	3470	3351	-3.41
2	2882	2773	-3.80
3	2264	2211	-2.35
4	1703	1676	-1.62
5	1032	1019	-1.25
6	506	505	-0.18
Traq 28-inch damper AMS			
1	10714	10548	-1.55
2	8817	8644	-1.96
3	6997	6851	-2.09
4	5063	4961	-2.00
5	3126	3071	-1.76
6	1363	1362	-0.06

Table 162. Airflow Resistance

Test Run	Pressure Drop (in. w.g.)	Volume (cfm)	Velocity (fpm)
Traq 16-inch damper AMS			
1	0.561	3469.70	2485.40
2	0.389	2895.70	2074.30
3	0.239	2276.30	1630.60
4	0.135	1710.20	1225.10
5	0.052	1035.00	741.40
6	0.010	507.00	363.20
Traq 28-inch damper AMS			
1	0.515	10738.60	2511.40
2	0.352	8856.50	2071.20
3	0.228	7029.20	1643.90
4	0.114	5085.50	1189.30
5	0.041	3134.60	733.10
6	0.010	1364.40	319.10

Corresponding conversion formulas:

Traq 16-inch AMS: Airflow = ((Volts-2)/8)*2475*Total Area (applicable for unit sizes 3-17).

Traq 28-inch AMS: Airflow = ((Volts-2)/8)*2600*Total Area (applicable for units sizes 21-30).

Refer to the Performance Climate Changer air handler installation operation manual (CLCH-SVX07A-EN) for Traq damper installation details.

Multizone Dampers

Table 163. Multizone damper - 2-deck with single actuator

Unit size	Area ft ²	Static Pressure Drop (inches w.g.) by Damper Face Velocity (fpm)															
		400	500	600	700	800	900	1000	1100	1200	1400	1600	1800	2000	2200	2400	2600
6	2.89	0.05	0.07	0.10	0.14	0.18	0.23	0.29	0.35	0.41	0.56	0.73	0.93	1.15	1.39	1.65	1.94
8	3.48	0.05	0.07	0.10	0.14	0.18	0.23	0.29	0.35	0.41	0.56	0.74	0.93	1.15	1.39	1.66	1.95
10	5.50	0.05	0.08	0.12	0.16	0.21	0.26	0.32	0.39	0.46	0.63	0.82	1.04	1.29	1.56	1.86	2.18
12	6.06	0.05	0.07	0.11	0.15	0.19	0.24	0.30	0.36	0.43	0.59	0.77	0.97	1.20	1.45	1.72	2.02
14	6.67	0.05	0.07	0.10	0.14	0.18	0.23	0.29	0.35	0.41	0.56	0.73	0.93	1.15	1.39	1.65	1.94
17	6.67	0.05	0.07	0.10	0.14	0.18	0.23	0.29	0.35	0.41	0.56	0.73	0.93	1.15	1.39	1.65	1.94
21	8.97	0.04	0.06	0.08	0.11	0.15	0.19	0.23	0.28	0.34	0.46	0.60	0.76	0.93	1.13	1.34	1.58
25	8.97	0.04	0.06	0.08	0.11	0.15	0.19	0.23	0.28	0.34	0.46	0.60	0.76	0.93	1.13	1.34	1.58
30	10.75	0.04	0.06	0.09	0.12	0.15	0.19	0.24	0.29	0.35	0.47	0.61	0.78	0.96	1.16	1.38	1.62
35	14.06	0.04	0.06	0.08	0.11	0.15	0.19	0.23	0.28	0.33	0.45	0.59	0.74	0.92	1.11	1.32	1.55
40	16.05	0.04	0.06	0.08	0.11	0.15	0.19	0.23	0.28	0.33	0.45	0.59	0.74	0.92	1.11	1.32	1.55
50	18.13	0.04	0.06	0.08	0.11	0.15	0.19	0.23	0.28	0.33	0.45	0.59	0.75	0.92	1.12	1.33	1.56

Table 164. Multizone damper - 3-deck with single actuator

Unit size	Area ft ²	Static Pressure Drop (inches w.g.) by Damper Face Velocity (fpm)															
		400	500	600	700	800	900	1000	1100	1200	1400	1600	1800	2000	2200	2400	2600
6	2.72	0.05	0.08	0.11	0.16	0.20	0.26	0.32	0.38	0.46	0.62	0.81	1.03	1.27	1.53	1.82	2.14
8	3.28	0.04	0.07	0.09	0.13	0.17	0.21	0.26	0.32	0.38	0.51	0.67	0.85	1.05	1.27	1.51	1.78
10	5.24	0.04	0.06	0.09	0.13	0.16	0.21	0.26	0.31	0.37	0.50	0.66	0.83	1.03	1.24	1.48	1.73
12	5.77	0.04	0.06	0.09	0.13	0.17	0.21	0.26	0.31	0.37	0.51	0.66	0.84	1.03	1.25	1.49	1.74
14	6.35	0.04	0.06	0.08	0.11	0.14	0.18	0.23	0.27	0.32	0.44	0.58	0.73	0.90	1.09	1.30	1.52
17	6.35	0.04	0.06	0.08	0.11	0.14	0.18	0.23	0.27	0.32	0.44	0.58	0.73	0.90	1.09	1.30	1.52
21	8.62	0.03	0.05	0.07	0.10	0.13	0.17	0.21	0.25	0.30	0.40	0.53	0.67	0.82	1.00	1.19	1.39
25	8.62	0.03	0.05	0.07	0.10	0.13	0.17	0.21	0.25	0.30	0.40	0.53	0.67	0.82	1.00	1.19	1.39
30	10.33	0.03	0.05	0.07	0.10	0.13	0.17	0.21	0.25	0.30	0.40	0.53	0.67	0.83	1.00	1.19	1.40
35	13.75	0.03	0.05	0.07	0.10	0.13	0.17	0.20	0.25	0.29	0.40	0.52	0.66	0.82	0.99	1.18	1.38
40	15.70	0.03	0.05	0.07	0.10	0.13	0.16	0.20	0.24	0.29	0.39	0.51	0.65	0.80	0.97	1.15	1.35
50	17.73	0.03	0.05	0.07	0.10	0.13	0.16	0.20	0.24	0.28	0.39	0.51	0.64	0.79	0.96	1.14	1.34

Table 165. Multizone damper - 3-deck with dual actuator

Unit size	Area ft ²	Static Pressure Drop (inches w.g.) by Damper Face Velocity (fpm)															
		400	500	600	700	800	900	1000	1100	1200	1400	1600	1800	2000	2200	2400	2600
6	2.72	0.03	0.05	0.07	0.10	0.13	0.16	0.20	0.25	0.29	0.40	0.52	0.66	0.81	0.99	1.17	1.38
8	3.28	0.03	0.05	0.07	0.10	0.13	0.17	0.20	0.25	0.29	0.40	0.52	0.66	0.82	0.99	1.18	1.38
10	5.24	0.03	0.05	0.07	0.09	0.12	0.15	0.19	0.23	0.27	0.37	0.48	0.61	0.75	0.91	1.08	1.27
12	5.77	0.03	0.05	0.06	0.09	0.12	0.15	0.18	0.22	0.26	0.35	0.46	0.58	0.72	0.87	1.04	1.22
14	6.35	0.03	0.04	0.06	0.09	0.11	0.14	0.18	0.21	0.25	0.35	0.45	0.57	0.71	0.86	1.02	1.20
17	6.35	0.03	0.04	0.06	0.09	0.11	0.14	0.18	0.21	0.25	0.35	0.45	0.57	0.71	0.86	1.02	1.20
21	8.62	0.03	0.05	0.07	0.09	0.12	0.15	0.19	0.23	0.27	0.36	0.48	0.60	0.74	0.90	1.07	1.26
25	8.62	0.03	0.05	0.07	0.09	0.12	0.15	0.19	0.23	0.27	0.36	0.48	0.60	0.74	0.90	1.07	1.26
30	10.33	0.03	0.05	0.07	0.09	0.12	0.16	0.19	0.23	0.28	0.38	0.49	0.62	0.77	0.93	1.10	1.29
35	13.75	0.03	0.05	0.07	0.09	0.12	0.15	0.19	0.23	0.27	0.37	0.49	0.62	0.76	0.92	1.10	1.29
40	15.70	0.03	0.05	0.07	0.09	0.12	0.15	0.19	0.23	0.27	0.37	0.49	0.62	0.76	0.92	1.10	1.29
50	17.73	0.03	0.05	0.07	0.09	0.12	0.16	0.19	0.23	0.28	0.38	0.49	0.62	0.77	0.93	1.11	1.30

Diffuser

Table 166. Diffuser pressure drop

Unit Size	Static Pressure Drop (inches wg) by Face Velocity (fpm)									
	500	700	900	1100	1300	1500	1700	1900	2100	
3-120	0.01	0.02	0.04	0.06	0.08	0.10	0.13	0.17	0.20	

Table 167. Diffuser face area

Unit Size	3	4	6	8	10	12	14	17	21	22	25	26	30
Area (ft ²)	1.53	1.53	3.36	3.74	3.74	4.32	4.32	7.94	8.78	11.71	10.72	15.77	10.72
Unit Size	31	35	36	40	41	50	51	57	58	66	80	100	120
Area (ft ²)	15.77	23.42	33.09	23.42	39.76	27.21	39.76	31.53	45.20	33.09	39.76	45.20	45.20

Discharge Plenums

Horizontal or Vertical Discharge Plenum with Factory Openings

Figure 73. Horizontal plenum

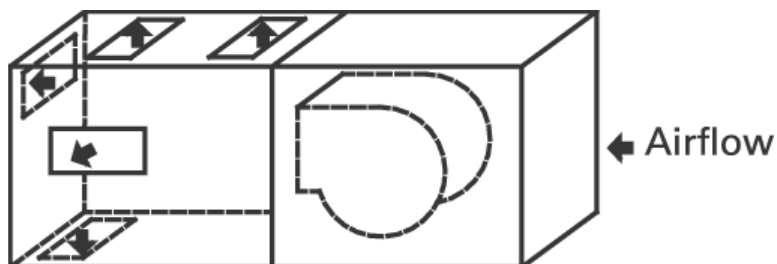


Figure 74. Vertical plenum

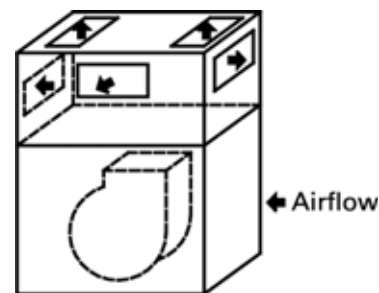


Table 168. Discharge plenums - default factory outlet areas (ft²)

Unit Size	Horizontal Plenum								Vertical Plenum					
	Rectangular Openings				Round Openings				Rectangular Openings			Round Openings		
	Front	Top	Bottom	Side	Front	Top	Bottom	Side	Front/Back	Top	Side	Front/Back	Top	Side
3	1.07	1.07	1.07	1.07	0.92	0.92	0.92	0.92	1.07	1.07	1.07	0.92	0.92	0.92
4	1.53	1.53	1.53	1.25	1.40	1.40	1.40	1.40	1.53	1.53	1.25	1.40	1.40	1.40
6	2.19	2.19	2.19	2.13	2.18	2.18	2.18	2.18	2.19	2.19	2.13	2.18	2.18	2.18
8	2.67	2.67	2.67	2.51	2.64	2.64	2.64	2.64	2.67	2.67	2.51	2.64	2.64	2.64
10	3.33	3.33	3.33	3.36	3.14	3.14	3.14	3.14	3.33	3.33	3.36	3.14	3.14	3.14
12	4.00	4.00	4.00	3.99	3.69	3.69	3.69	4.28	4.00	4.00	3.99	4.28	4.28	4.28
14	4.88	4.88	4.88	4.69	3.69	3.69	3.69	4.28	4.88	4.88	4.69	4.91	4.91	4.91
17	5.91	5.91	5.91	5.56	3.69	3.69	3.69	4.28	5.91	5.91	5.56	5.59	5.59	5.59
21	7.12	7.12	7.12	7.04	3.14	3.14	3.14	3.69	7.12	7.12	7.04	6.31	6.31	6.31
22	6.88	7.17	7.12	7.26	6.31	5.77	5.77	5.71	n/a	n/a	n/a	n/a	n/a	n/a
25	8.54	8.54	8.54	8.13	7.07	7.07	7.07	7.88	8.54	8.54	8.13	7.88	7.88	7.88
26	11.39	8.54	8.54	8.13	7.88	7.47	6.49	11.17	n/a	n/a	n/a	n/a	n/a	n/a
30	10.21	10.21	10.21	10.15	7.07	7.07	7.07	7.88	10.21	10.21	10.15	9.62	9.62	9.62
31	13.10	10.21	10.21	10.07	9.62	8.55	8.71	11.17	n/a	n/a	n/a	n/a	n/a	n/a
35	13.56	13.09	11.67	11.25	11.54	11.17	11.17	5.52	13.56	13.09	11.25	11.54	11.17	11.54
36	14.93	11.25	11.67	11.25	15.9066	11.17	11.35	12.43	n/a	n/a	n/a	n/a	n/a	n/a
40	14.89	14.70	13.42	12.67	12.57	12.61	12.61	5.52	14.89	14.70	12.67	12.57	12.61	12.57
41	17.36	13.75	11.67	13.33	15.90	11.17	11.35	14.53	n/a	n/a	n/a	n/a	n/a	n/a
50	19.27	18.30	16.67	15.04	15.75	14.53	14.53	7.95	19.27	18.30	15.04	15.75	14.53	12.57
51	20.19	17.24	16.67	15.93	25.22	14.93	12.98	14.53	n/a	n/a	n/a	n/a	n/a	n/a
57	21.88	20.63	18.89	17.94	18.34	16.76	16.76	11.17	n/a	n/a	n/a	n/a	n/a	n/a
58	23.36	17.24	16.67	18.08	25.22	14.93	12.98	14.53	n/a	n/a	n/a	n/a	n/a	n/a
66	25.36	23.61	20.40	19.23	21.12	18.92	18.92	12.43	n/a	n/a	n/a	n/a	n/a	n/a
80	29.97	28.71	23.49	25.06	25.13	21.21	21.21	18.56	n/a	n/a	n/a	n/a	n/a	n/a
100	37.28	34.53	30.04	32.29	31.50	26.84	26.84	24.35	n/a	n/a	n/a	n/a	n/a	n/a
120	43.43	41.25	35.58	34.03	38.48	33.13	33.13	24.35	n/a	n/a	n/a	n/a	n/a	n/a

Note: 1. Openings can be varied in number, size, and location within the TOPSS Selection Software. 2. Sizes 35-120 have default multiple round openings as standard. 3. Bell mouth openings are available within the TOPSS Selection Software.

Formulas

For all plenum openings, use:

$$SP = K_t \bullet \left(\frac{OV_F}{4005} \right)^2 + 0.5 \bullet \left(\frac{OV_P}{4005} \right)^2$$

Where:

SP = static pressure drop

 K_t = value from [Table 169](#)

$$OV_F = FM/OA_F$$

$$OV_P = CFM/OA_P$$

 OV_F = fan outlet velocity

 OA_F = fan outlet area (see ["General Data," p. 59](#))

 OV_P = plenum opening outlet velocity

 OA_P = plenum opening area (see [Table 168](#))

Table 169. Discharge Plenums - K_t values for factory openings for plenum fans

Unit size	Discharge Location	Discharge
3-120	Rectangular Radial	2.00
	Rectangular Axial Discharge	2.50
	Round Radial	2.00
	Round Axial Discharge	2.50
	Bell mouth Radial	1.60
	Bell mouth Axial Discharge	1.80
Discharge Plenum Loss		
	Rectangular Discharge	0.50
	Round Discharge	0.50
Housed Exhaust Fans	Exhaust Damper Section Discharge	0.45

Table 170. Discharge Plenums - K_t values for factory openings for housed fans

Size	Discharge Location	Plenum location and Fan Discharge					
		Top Mounted		Horizontally Mounted		Horizontally Mounted	
		Fan Top-front	Fan Top-back	Fan Front-top	Fan Back-top	Fan Front-bottom	Fan Back-bottom
3-8 FC	Front-top	1.67	0.98	0.98	n/a	0.98	n/a
	Back-top	0.98	1.67	n/a	0.98	n/a	0.98
	Top-front/back	0.98	0.98	1.67	1.67	0.98	0.98
	Side-top	1.5	1.5	1.5	1.5	1.5	1.5
	Bottom-front/back	n/a	n/a	0.98	0.98	1.67	1.67
3-8 BC or AF	Front-top	1.14	0.68	0.68	n/a	0.68	n/a
	Back-top	0.68	1.14	n/a	0.68	n/a	0.68
	Top-front/back	0.68	0.68	1.33	1.33	0.78	0.78
	Side-top	1.29	1.29	1.34	1.34	1.34	1.34
	Bottom-front/back	n/a	n/a	0.78	0.78	1.33	1.33
10-17 FC	Front-top	2.59	1.68	1.68	n/a	1.68	n/a
	Back-top	1.68	2.59	n/a	1.68	n/a	1.68
	Top-front/back	1.68	1.68	2.59	2.59	1.68	1.68
	Side-top	2.37	2.37	2.37	2.37	2.37	2.37
	Bottom-front/back	n/a	n/a	1.68	1.68	2.59	2.59
10-17 AF	Front-top	1.67	1.15	1.15	n/a	1.15	n/a
	Back-top	1.15	1.67	n/a	1.15	n/a	1.15
	Top-front/back	1.15	1.15	1.83	1.83	1.23	1.23
	Side-top	1.85	1.85	1.85	1.85	1.85	1.85
	Bottom-front/back	n/a	n/a	1.23	1.23	1.83	1.83



Performance Data

Table 170. Discharge Plenums - K_t values for factory openings for housed fans

Size	Discharge Location	Plenum location and Fan Discharge					
		Top Mounted		Horizontally Mounted		Horizontally Mounted	
		Fan Top-front	Fan Top-back	Fan Front-top	Fan Back-top	Fan Front-bottom	Fan Back-bottom
21-31FC	Front-top	1.68	0.96	0.96	n/a	0.96	n/a
	Back-top	0.96	1.68	n/a	0.96	n/a	0.96
	Top-front/back	0.96	0.96	1.68	1.68	0.96	0.96
	Side-top	1.5	1.5	1.5	1.5	1.5	1.5
	Bottom-front/back	n/a	n/a	0.96	0.96	1.68	1.68
21-58 AF	Front-top	1.45	0.93	0.93	n/a	0.93	n/a
	Back-top	0.93	1.45	n/a	0.93	n/a	0.93
	Top-front/back	0.93	0.93	1.81	1.81	1.13	1.13
	Side-top	1.68	1.68	1.68	1.68	1.68	1.68
	Bottom-front/back	n/a	n/a	1.13	1.13	1.81	1.81
35-120 FC	Front-top	1.44	0.83	0.83	n/a	0.83	n/a
	Back-top	0.83	1.44	n/a	0.83	n/a	0.83
	Top-front/back	0.83	0.83	1.44	1.44	0.83	0.83
	Side-top	1.25	1.25	1.25	1.25	1.25	1.25
	Bottom-front/back	n/a	n/a	0.83	0.83	1.44	1.44
	Full bottom	n/a	n/a	0.73	0.73	0.73	0.73
66 -120 AF	Front-top	n/a	n/a	1.34	n/a	1.34	n/a
	Back-top	n/a	n/a	n/a	1.34	n/a	1.34
	Top-front/back	n/a	n/a	2.14	2.14	1.34	1.34
	Side-top	n/a	n/a	2.11	2.11	2.11	2.11
	Bottom-front/back	n/a	n/a	1.34	1.34	2.14	2.14

Economizer for Outdoor Units

Table 171. Economizer - exhaust damper performance data

Unit size	Area (ft ²)	Static Pressure Drop (inches w.g.) by Damper Face Velocity (fpm)															
		400	500	600	700	800	900	1000	1100	1200	1400	1600	1800	2000	2200	2400	2600
3	1.09	0.05	0.08	0.11	0.16	0.20	0.26	0.32	0.38	0.46	0.62	0.81	1.03	1.27	1.54	1.83	2.15
4	1.09	0.05	0.08	0.11	0.16	0.20	0.26	0.32	0.38	0.46	0.62	0.81	1.03	1.27	1.54	1.83	2.15
6	1.53	0.04	0.07	0.10	0.13	0.18	0.22	0.27	0.33	0.40	0.54	0.70	0.89	1.10	1.33	1.58	1.85
8	1.97	0.04	0.06	0.09	0.12	0.16	0.21	0.25	0.31	0.37	0.50	0.65	0.82	1.02	1.23	1.46	1.72
10	2.29	0.04	0.06	0.09	0.13	0.16	0.21	0.26	0.31	0.37	0.50	0.65	0.83	1.02	1.24	1.47	1.72
12	3.05	0.04	0.06	0.09	0.12	0.15	0.19	0.24	0.29	0.34	0.47	0.61	0.77	0.96	1.16	1.38	1.62
14	3.19	0.03	0.05	0.08	0.10	0.14	0.17	0.21	0.26	0.31	0.42	0.55	0.69	0.86	1.04	1.23	1.45
17	4.18	0.03	0.05	0.07	0.10	0.13	0.16	0.20	0.25	0.29	0.40	0.52	0.66	0.81	0.98	1.17	1.37
21	5.04	0.03	0.05	0.07	0.10	0.13	0.16	0.20	0.24	0.28	0.39	0.51	0.64	0.79	0.96	1.14	1.33
25	6.27	0.03	0.05	0.07	0.09	0.12	0.16	0.19	0.23	0.28	0.38	0.49	0.62	0.77	0.93	1.11	1.30
30	6.65	0.03	0.05	0.07	0.09	0.12	0.15	0.19	0.23	0.27	0.37	0.49	0.62	0.76	0.92	1.10	1.29
35	8.06	0.03	0.04	0.06	0.09	0.11	0.15	0.18	0.22	0.26	0.35	0.46	0.58	0.72	0.87	1.03	1.21
40	9.42	0.03	0.04	0.06	0.09	0.11	0.15	0.18	0.22	0.26	0.35	0.46	0.58	0.72	0.87	1.03	1.21
50	12.32	0.03	0.05	0.07	0.09	0.12	0.15	0.18	0.22	0.26	0.36	0.47	0.59	0.73	0.89	1.06	1.24
57	14.27	0.03	0.04	0.06	0.09	0.11	0.14	0.18	0.22	0.26	0.35	0.46	0.58	0.72	0.87	1.03	1.21

Table 171. Economizer - exhaust damper performance data

Unit size	Area (ft ²)	Static Pressure Drop (inches w.g.) by Damper Face Velocity (fpm)															
		400	500	600	700	800	900	1000	1100	1200	1400	1600	1800	2000	2200	2400	2600
66	15.30	0.03	0.04	0.06	0.09	0.11	0.14	0.18	0.21	0.25	0.35	0.45	0.57	0.71	0.86	1.02	1.20
80	18.45	0.03	0.04	0.06	0.08	0.11	0.14	0.17	0.21	0.25	0.34	0.44	0.56	0.69	0.84	1.00	1.17
100	24.41	0.03	0.04	0.06	0.08	0.11	0.13	0.17	0.20	0.24	0.32	0.42	0.54	0.66	0.80	0.95	1.12
120	28.50	0.03	0.04	0.06	0.08	0.10	0.13	0.16	0.20	0.23	0.32	0.41	0.52	0.65	0.78	0.93	1.10

Table 172. Economizer - outside air/return damper

Unit size	Area (ft ²)	Static Pressure Drop (inches w.g.) by Damper Face Velocity (fpm)															
		400	500	600	700	800	900	1000	1100	1200	1400	1600	1800	2000	2200	2400	2600
3	1.22	0.05	0.08	0.11	0.15	0.19	0.24	0.30	0.36	0.43	0.59	0.77	0.98	1.21	1.46	1.74	2.04
4	1.89	0.04	0.06	0.09	0.12	0.16	0.20	0.25	0.31	0.36	0.49	0.65	0.82	1.01	1.22	1.45	1.71
6	2.57	0.04	0.06	0.08	0.11	0.14	0.18	0.23	0.27	0.33	0.44	0.58	0.73	0.91	1.10	1.30	1.53
8	3.33	0.03	0.05	0.08	0.10	0.14	0.17	0.21	0.26	0.31	0.42	0.54	0.69	0.85	1.03	1.22	1.43
10	4.16	0.03	0.05	0.07	0.10	0.13	0.16	0.20	0.24	0.29	0.39	0.51	0.64	0.80	0.96	1.15	1.35
12	5.14	0.03	0.05	0.07	0.09	0.12	0.15	0.19	0.23	0.27	0.37	0.49	0.62	0.76	0.92	1.10	1.29
14	5.64	0.03	0.04	0.06	0.09	0.11	0.14	0.18	0.21	0.25	0.35	0.45	0.57	0.71	0.86	1.02	1.20
17	6.94	0.03	0.04	0.06	0.08	0.11	0.14	0.17	0.21	0.25	0.33	0.44	0.55	0.68	0.82	0.98	1.15
21	8.68	0.03	0.04	0.06	0.09	0.11	0.14	0.17	0.21	0.25	0.34	0.45	0.56	0.70	0.84	1.00	1.18
25	10.42	0.03	0.04	0.06	0.08	0.11	0.14	0.17	0.21	0.25	0.33	0.44	0.55	0.68	0.83	0.98	1.15
30	12.08	0.03	0.04	0.06	0.08	0.11	0.13	0.17	0.20	0.24	0.33	0.42	0.54	0.66	0.80	0.96	1.12
35	14.25	0.03	0.04	0.06	0.08	0.10	0.13	0.16	0.20	0.23	0.32	0.41	0.52	0.65	0.78	0.93	1.10
40	16.17	0.03	0.04	0.06	0.08	0.10	0.13	0.16	0.19	0.23	0.31	0.41	0.52	0.64	0.77	0.92	1.08
50	19.45	0.03	0.04	0.06	0.08	0.11	0.14	0.17	0.21	0.25	0.34	0.44	0.55	0.68	0.83	0.99	1.16
57	22.73	0.03	0.04	0.06	0.08	0.11	0.14	0.17	0.20	0.24	0.33	0.43	0.54	0.67	0.81	0.96	1.13
66	27.27	0.03	0.05	0.07	0.09	0.12	0.15	0.19	0.23	0.27	0.37	0.48	0.61	0.75	0.90	1.08	1.26
80	32.57	0.03	0.05	0.07	0.09	0.12	0.15	0.18	0.22	0.26	0.36	0.47	0.59	0.73	0.88	1.05	1.23
100	41.34	0.03	0.04	0.06	0.08	0.11	0.14	0.17	0.21	0.25	0.33	0.44	0.55	0.68	0.83	0.98	1.15
120	48.82	0.03	0.04	0.06	0.08	0.11	0.13	0.17	0.20	0.24	0.32	0.42	0.54	0.66	0.80	0.95	1.12

Electric Heat

Table 173. Electric heat pressure drop

Static Pressure Drop (inches w.g.) by Face Velocity (fpm)								
Face Velocity	350	400	450	500	550	600	650	700
Pressure Drop	0.06	0.08	0.1	0.12	0.15	0.17	0.2	0.24

Table 174. Electric heat face area

Unit size	3	4	6	8	10	12	14	17	21	22	25	26
Area (ft ²)	2.18	3.79	4.73	6.43	8.52	10.54	11.70	14.58	17.57	17.48	21.13	21.60
Unit size	30	31	35	36	40	41	50	51	57	58	66	
Area (ft ²)		25.52	26.72	30.97	32.29	34.98	37.81	45.17	45.56	52.25	51.73	62.65



Performance Data

Filters

Table 175. Maximum CFM for filters

Unit Size	Pleated Media		Permanent		Throwaway		High Efficiency		
	2-in. and 4-in. Flat	2-in. or 4-in. Angled	2-in. and 4-in. Flat	2-in. or 4-in. Angled	2-in. and 4-in. Flat	2-in. or 4-in. Angled	Long Cartridge/Bag	HEPA	4-in. High Efficiency
	625	625	800	800	500	500	625	600	625
3	2169	3475	2776	4448	1735	2780	2081	1200	2169
4	3475	5556	4448	7112	2780	4445	3475	1200	3475
6	4338	5556	5552	7112	3470	4445	4169	3600	4338
8	4581	6944	5864	8888	3665	5555	5000	4200	4581
10	6075	8681	7776	11,112	4860	6945	5419	5400	6075
12	8331	10,419	10,664	13,336	6665	8335	7706	6000	8331
14	9025	11,288	11,552	14,448	7220	9030	8400	6000	9025
17	11,806	18,056	15,112	23,112	9445	14,445	11,806	8400	11,806
21	13,456	20,831	17,224	26,664	10,765	16,665	13,750	12,600	13,456
22	13,194	20,831	16,888	26,664	10,555	16,665	10,831	11,400	13,194
25	16,944	31,250	21,688	40,000	13,555	25,000	16,250	14,400	16,944
26	18,231	27,775	23,336	35,552	14,585	22,220	16,250	16,200	18,231
30	19,025	35,419	24,352	45,336	15,220	28,335	17,638	16,800	19,025
31	22,138	36,113	28,336	46,224	17,710	28,890	21,250	18,000	22,138
35	23,263	39,581	29,776	50,664	18,610	31,665	21,669	18,000	23,263
36	25,000	39,063	32,000	50,000	20,000	31,250	22,500	21,600	25,000
40	25,519	43,750	32,664	56,000	20,415	35,000	22,500	22,200	25,519
41	30,138	41,669	38,576	53,336	24,110	33,335	30,000	27,000	30,138
50	34,375	62,500	44,000	80,000	27,500	50,000	31,250	27,600	34,375
51	34,306	59,025	43,912	75,552	27,445	47,220	35,000	28,800	34,306
57	39,581	62,500	50,664	80,000	31,665	50,000	37,500	34,200	39,581
58	38,194	61,806	48,888	79,112	30,555	49,445	38,750	33,600	38,194
66	47,225	70,831	60,448	90,664	37,780	56,665	41,669	39,600	47,225
80	53,475	94,444	68,448	120,888	42,780	75,555	55,000	45,600	53,475
100	65,106	104,169	83,336	133,336	52,085	83,335	70,831	61,200	65,106
120	76,388	121,525	97,776	155,552	61,110	97,220	83,750	71,400	76,388

Table 176. Filter area (ft.²)

Unit Size	Side-load 2-in. and 4-in. Flat	Side-load 2-in. and 4-in. Angled	Side-load Bag/Cartridge	Front-Load Bag/Cartridge Filter	Front-load HEPA
3	3.47	5.56	3.33	2.00	2.00
4	5.56	8.89	5.56	2.00	2.00
6	6.94	8.89	6.67	6.00	6.00
8	7.33	11.11	8.00	6.00	7.00
10	9.72	13.89	8.67	8.00	9.00
12	13.33	16.67	12.33	10.00	10.00
14	14.44	18.06	13.44	10.00	10.00
17	18.89	28.89	18.89	14.00	14.00
21	21.53	33.33	22.00	18.00	21.00
22	21.11	33.33	17.33	18.00	19.00
25	27.11	50.00	26.00	24.00	24.00

Table 176. Filter area (ft.²)

Unit Size	Side-load 2-in. and 4-in. Flat	Side-load 2-in. and 4-in. Angled	Side-load Bag/Cartridge	Front-Load Bag/ Cartridge Filter	Front-load HEPA
26	29.17	44.44	26.00	24.00	27.00
30	30.44	56.67	28.22	28.00	28.00
31	35.42	57.78	34.00	30.00	30.00
35	37.22	63.33	34.67	34.00	30.00
36	40.00	32.50	36.00	36.00	36.00
40	40.83	70.00	36.00	38.00	37.00
41	48.22	66.67	48.00	46.00	45.00
50	55.00	100.00	50.00	50.00	46.00
51	54.89	94.44	56.00	54.00	48.00
57	63.33	100.00	60.00	60.00	57.00
58	61.11	98.89	62.00	62.00	56.00
66	75.56	113.33	66.67	66.00	66.00
80	85.56	151.11	88.00	86.00	76.00
100	104.17	166.67	113.33	106.00	102.00
120	122.22	194.44	134.00	124.00	119.00

Table 177. Filters (clean) performance data

Filter Type	Static Pressure Drop (inches wg) by Filter Face Velocity (fpm)								
	200	250	300	350	400	450	500	550	600
2-inch permanent – MERV 2	0.01	0.02	0.03	0.04	0.05	0.06	0.07	0.09	0.11
2-inch disposable (TA) – MERV 5	0.04	0.06	0.08	0.10	0.13	0.15	0.18	n/a	n/a
2-inch pleated media – MERV 8	0.08	0.11	0.14	0.18	0.22	0.26	0.30	0.34	0.39
2-inch pleated media – coated – MERV 7	0.08	0.11	0.14	0.18	0.21	0.26	0.30	0.35	0.40
4-inch pleated media – MERV 8	0.04	0.06	0.08	0.11	0.13	0.16	0.19	0.22	0.25
4-inch pleated media – coated – MERV 7	0.04	0.06	0.09	0.12	0.16	0.20	0.25	0.30	0.36
4-inch high efficient – 65% efficient – MERV 11	0.07	0.10	0.12	0.15	0.18	0.21	0.24	0.27	0.30
4-inch high efficient – 95% efficient – MERV 14	0.16	0.20	0.25	0.29	0.34	0.39	0.44	0.49	0.54
12-inch cartridge – 65% efficient – MERV 11	0.06	0.09	0.12	0.15	0.19	0.23	0.27	0.31	0.36
12-inch cartridge – 95% efficient – MERV 14	0.11	0.14	0.18	0.22	0.26	0.30	0.35	0.39	0.44
18-inch bag – 65% efficient – MERV 12	0.18	0.22	0.27	0.31	0.35	0.39	0.44	0.48	0.52
18-inch bag – 85% efficient – MERV 13	0.20	0.25	0.30	0.35	0.41	0.46	0.51	0.56	0.61
18-inch bag – 95% efficient – MERV 14	0.23	0.28	0.34	0.39	0.45	0.50	0.56	0.61	0.66
30-inch bag – 65% efficient – MERV 12	0.07	0.10	0.13	0.17	0.21	0.26	0.31	0.36	0.42
30-inch bag – 85% efficient – MERV 13	0.09	0.11	0.15	0.18	0.22	0.26	0.31	0.35	0.40
30-inch bag – 95% efficient – MERV 14	0.17	0.22	0.27	0.32	0.37	0.42	0.47	0.52	0.58
HEPA - 99.97% efficient - DOP	0.47	0.60	0.74	0.89	1.04	1.20	1.37	1.54	1.72



Performance Data

Table 178. Filters (mid-life) performance data

Filter Type	Static Pressure Drop (inches wg) by Filter Face Velocity (fpm)								
	200	250	300	350	400	450	500	550	600
2-inch permanent – MERV 2	0.51	0.51	0.52	0.52	0.53	0.53	0.54	0.55	0.55
2-inch disposable (TA) – MERV 5	0.52	0.53	0.54	0.55	0.57	0.58	0.59	n/a	n/a
2-inch pleated media – MERV 8	0.54	0.56	0.57	0.59	0.61	0.63	0.65	0.67	0.69
2-inch pleated media – coated – MERV 7	0.54	0.56	0.57	0.59	0.61	0.63	0.65	0.67	0.70
4-inch pleated media – MERV 8	0.52	0.53	0.54	0.56	0.57	0.58	0.59	0.61	0.62
4-inch pleated media – coated – MERV 7	0.52	0.53	0.55	0.57	0.59	0.61	0.63	0.65	0.67
4-inch high efficient – 65% efficient – MERV 11	0.64	0.65	0.66	0.68	0.69	0.70	0.72	0.73	0.75
4-inch high efficient – 95% efficient – MERV 14	0.68	0.70	0.72	0.75	0.77	0.79	0.82	0.84	0.87
12-inch cartridge – 65% efficient – MERV 11	0.63	0.65	0.66	0.68	0.70	0.72	0.74	0.76	0.78
12-inch cartridge – 95% efficient – MERV 14	0.65	0.67	0.69	0.71	0.73	0.75	0.77	0.80	0.82
18-inch bag – 65% efficient – MERV 12	0.69	0.71	0.73	0.75	0.77	0.80	0.82	0.84	0.86
18-inch bag – 85% efficient – MERV 13	0.70	0.73	0.75	0.78	0.80	0.83	0.85	0.88	0.90
18-inch bag – 95% efficient – MERV 14	0.71	0.74	0.77	0.80	0.82	0.85	0.88	0.90	0.93
30-inch bag – 65% efficient – MERV 12	0.63	0.65	0.67	0.69	0.71	0.73	0.76	0.78	0.80
30-inch bag – 85% efficient – MERV 13	0.64	0.66	0.68	0.70	0.71	0.73	0.76	0.78	0.80
30-inch bag – 95% efficient – MERV 14	0.69	0.71	0.73	0.76	0.78	0.81	0.83	0.86	0.89
HEPA - 99.97% efficient - DOP	1.23	1.30	1.37	1.44	1.52	1.60	1.68	1.77	1.86

Table 179. Filters (dirty) performance data

Filter Type	Static Pressure Drop (inches wg) by Filter Face Velocity (fpm)								
	200	250	300	350	400	450	500	550	600
2-inch permanent – MERV 2	1.00	1.00	1.00	1.00	1.00	1.00	1.00	1.00	1.00
2-inch disposable (TA) – MERV 5	1.00	1.00	1.00	1.00	1.00	1.00	1.00	n/a	n/a
2-inch pleated media – MERV 8	1.00	1.00	1.00	1.00	1.00	1.00	1.00	1.00	1.00
2-inch pleated media – coated – MERV 7	1.00	1.00	1.00	1.00	1.00	1.00	1.00	1.00	1.00
4-inch pleated media – MERV 8	1.00	1.00	1.00	1.00	1.00	1.00	1.00	1.00	1.00
4-inch pleated media – coated – MERV 7	1.00	1.00	1.00	1.00	1.00	1.00	1.00	1.00	1.00
4-inch high efficient – 65% efficient – MERV 11	1.20	1.20	1.20	1.20	1.20	1.20	1.20	1.20	1.20
4-inch high efficient – 95% efficient – MERV 14	1.20	1.20	1.20	1.20	1.20	1.20	1.20	1.20	1.20
12-inch cartridge – 65% efficient – MERV 11	1.20	1.20	1.20	1.20	1.20	1.20	1.20	1.20	1.20
12-inch cartridge – 95% efficient – MERV 14	1.20	1.20	1.20	1.20	1.20	1.20	1.20	1.20	1.20
18-inch bag – 65% efficient – MERV 12	1.20	1.20	1.20	1.20	1.20	1.20	1.20	1.20	1.20
18-inch bag – 85% efficient – MERV 13	1.20	1.20	1.20	1.20	1.20	1.20	1.20	1.20	1.20
18-inch bag – 95% efficient – MERV 14	1.20	1.20	1.20	1.20	1.20	1.20	1.20	1.20	1.20
30-inch bag – 65% efficient – MERV 12	1.20	1.20	1.20	1.20	1.20	1.20	1.20	1.20	1.20
30-inch bag – 85% efficient – MERV 13	1.20	1.20	1.20	1.20	1.20	1.20	1.20	1.20	1.20
30-inch bag – 95% efficient – MERV 14	1.20	1.20	1.20	1.20	1.20	1.20	1.20	1.20	1.20
HEPA - 99.97% efficient - DOP	2.00	2.00	2.00	2.00	2.00	2.00	2.00	2.00	2.00

Gas Heat

Table 180. Gas heat pressure drop

Unit Size	Static Pressure Drop (inches w.g.) by Face Velocity (range = 750 - 2000)		
	Full Face Discharge	Horizontal Discharge	Vertical Discharge
6	0.32	0.42	0.65
8	0.38	0.48	0.78
10	0.42	0.52	0.85
12	0.46	0.56	0.88
14	0.49	0.59	0.89
17	0.51	0.61	0.90
21	0.53	0.63	0.94
25	0.55	0.65	1.00
30	0.60	0.70	0.99
35	0.42	0.52	0.84
40	0.47	0.57	0.91
50	0.49	0.59	0.91
57	0.58	0.68	1.02
66	0.52	0.62	0.91
80	0.54	0.64	0.99
100	0.62	0.72	1.10
120	0.54	0.64	1.00

Hoods

Table 181. Exhaust hood performance data

Face Velocity (FPM)	Static Pressure Drop (inches wg) by Face Velocity (fpm)									
	700	800	900	1000	1100	1200	1300	1400	1500	1600
Pressure drop	0.03	0.04	0.05	0.06	0.07	0.09	0.10	0.12	0.13	0.15

Table 182. Exhaust hood face area

Unit Size	3	4	6	8	10	12	14	17	21	25	30	35	40	50	57
Area (ft ²)	1.25	1.25	1.49	1.78	2.00	2.52	3.21	3.17	4.07	4.36	5.28	7.69	7.94	8.67	9.23

Table 183. Inlet hood performance data

Face Velocity (FPM)	Static Pressure Drop (inches wg) by Face Velocity (fpm)								
	300	400	500	600	700	800	900	950	
Pressure drop	0.04	0.06	0.10	0.15	0.20	0.26	0.33	0.37	



Performance Data

Each air handler has a rated nominal airflow (for example, 1500 cfm for a size 3). This nominal airflow is a quick guide to figure unit size requirements. Although this is the nominal airflow of a given unit, each unit is capable of producing more, until something limits the ability of the unit to meet this higher airflow requirement such as coil face velocity, filter face velocity, or the outside air inlet hood eliminator velocity.

The eliminator in the inlet hood is rated to a maximum of 800 feet per minute. Above this limit, there is a high probability of bringing rain, water or snow into the unit, which could migrate to the conditioned space below. When selecting units for your application, remember not to undersize a unit to the point that the inlet hood eliminators can not handle the outside air cfm requirements.

Table 184 shows the maximum airflow for inlet hoods.

Table 184. Inlet hood airflow limitations (cfm)

Unit size	Back hood area (ft ²)	Back inlet hood	Mixing Section				Economizer Section	
			1 Side hood area (ft ²)	1 side inlet hood	2 side hood area (ft ²)	2 side inlet hoods	Inlet hood area (ft ²)	Single inlet hood
3	2.82	2257	2.23	1781	4.46	3563	1.88	1504
4	6.96	5567	2.23	1781	4.46	3563	3.65	2917
6	7.52	6016	2.72	2179	5.44	4358	4.53	3625
8	11.06	8847	3.29	2634	6.58	5268	5.79	4628
10	8.81	7050	3.81	3050	7.62	6100	6.57	5257
12	11.74	9393	4.80	3841	9.60	7681	7.74	6190
14	12.73	10,185	6.98	5582	13.96	11,163	10.31	8248
17	14.74	11,789	6.09	4870	12.18	9741	12.45	9960
21	18.39	14,716	8.15	6524	16.30	13,047	14.91	11,928
25	21.32	17,054	8.65	6917	17.30	13,834	17.48	13,984
30	28.37	22,694	9.68	7742	19.36	15,483	19.69	15,752
35	30.39	24,316	15.25	12,199	30.50	24,397	22.78	18,222
40	34.29	27,434	15.80	12,640	31.60	25,280	27.86	22,288
50	40.87	32,700	19.76	15,808	39.52	31,617	32.46	25,968
57	47.10	37,677	18.67	14,933	37.34	29,865	33.89	27,112
66	64.99	51,988	18.80	15,039	37.60	30,077	42.51	34,008
80	69.42	55,539	22.43	17,943	44.86	35,887	51.03	40,824
80 Traq	n/a	n/a	24.54	19,633	49.08	39,265	n/a	n/a
100	81.29	65,029	29.05	23,239	58.10	46,477	63.15	50,520
100 Traq	n/a	n/a	51.83	41,463	103.66	82,926	n/a	n/a
120	97.40	77,916	33.50	26,797	67.00	53,595	72.80	58,240
120 Traq	n/a	n/a	50.29	40,231	100.58	80,462	n/a	n/a

Humidifiers

Table 185. Humidifier pressure drop

Face Velocity	Static Pressure Drop (inches w.g.) by Face Velocity (fpm)										
	400	450	500	550	600	650	700	750	800	850	900
Pressure drop	0.02	0.02	0.03	0.03	0.04	0.05	0.05	0.06	0.07	0.08	0.09

Table 186. Face area for building steam and atmospheric steam sources

Building Steam Source		Atmospheric Steam Source	
Unit Size	Area (ft. ²)	Unit Size	Area (ft. ²)
3	1.22	3	1.42
4	2.43	4	2.29
6	3.47	6	3.72
8	4.59	8	5.14
10	6.20	10	6.58
12	7.59	12	8.67
14	8.47	14	9.53
17	11.04	17	12.71
21	12.71	21	16.17
22	12.99	22	16.92
25	16.52	25	20.36
26	18.59	26	23.32
30	20.18	30	21.40
31	23.19	31	28.17
35	24.96	35	26.73
36	27.96	36	33.54
40	28.57	40	30.45
41	30.50	41	34.50
50	39.20	50	41.05
51	37.25	51	41.38
57	46.59	57	48.56
58	37.25	58	41.38
66	55.69	66	58.19
80	60.75	80	63.00
100	67.75	100	70.00
120	72.00	120	74.00



Performance Data

Multizone

Table 187. Baffle assembly pressure drop (inches w.g.)

Unit size	Air flow (cfm)	Baffle Assembly Pressure Drop (inches w.g.)							
		70	60	6070	6060	40	4070	4060	4040
6	3000	0.10	0.19	0.29	0.38	0.67	0.77	0.86	1.33
8	4000	0.12	0.23	0.36	0.47	0.81	0.93	1.04	1.62
10	5000	0.07	0.14	0.21	0.27	0.47	0.54	0.61	0.94
12	6000	0.09	0.16	0.25	0.32	0.56	0.64	0.72	1.12
14	7000	0.10	0.18	0.28	0.36	0.62	0.72	0.80	1.25
17	8500	0.14	0.27	0.41	0.53	0.92	1.06	1.19	1.84
21	10,500	0.11	0.22	0.33	0.43	0.74	0.86	0.96	1.49
25	12,500	0.16	0.30	0.47	0.61	1.06	1.22	1.36	2.11
30	15,000	0.16	0.30	0.46	0.61	1.05	1.21	1.36	2.10
35	17,500	0.12	0.23	0.35	0.46	0.79	0.91	1.02	1.58
40	20,000	0.12	0.23	0.35	0.46	0.79	0.91	1.02	1.58
50	25,000	0.15	0.28	0.43	0.56	0.97	1.11	1.24	1.93

Silencers

Table 188. Silencer performance data

Length	Model	Unit Sizes	Pressure Drop (in. H ₂ O) by Face Velocity (fpm)						
			250	500	750	1000	1250	1500	1750
3 ft.	RD-ULV-F2	10	0.03	0.11	0.26	0.45	0.70	1.01	1.37
	RD-ULV-F3	3, 21, 22, 25, 26, 40, 66, 80	0.03	0.11	0.25	0.45	0.70	1.00	1.36
	RD-ULV-F4	41, 50, 57, 100, 120	0.03	0.11	0.25	0.44	0.68	0.98	1.32
	RD-ULV-F5	8, 14, 17, 30, 35, 51, 58	0.03	0.12	0.27	0.47	0.73	1.05	1.43
	RD-ULV-F6	4, 6, 12, 31	0.03	0.12	0.28	0.50	0.78	1.13	1.54
	RD-ULV-F7	36	0.03	0.13	0.29	0.53	0.83	1.20	1.65
5 ft.	RD-ULV-F2	10	0.04	0.15	0.34	0.61	0.94	1.36	1.84
	RD-ULV-F3	3, 21, 22, 25, 26, 40, 66, 80	0.04	0.15	0.34	0.59	0.92	1.31	1.78
	RD-ULV-F4	41, 50, 57, 100, 120	0.04	0.15	0.33	0.57	0.89	1.27	1.71
	RD-ULV-F5	8, 14, 17, 30, 35, 51, 58	0.04	0.15	0.34	0.61	0.94	1.35	1.83
	RD-ULV-F6	4, 6, 12, 31	0.04	0.16	0.36	0.64	0.99	1.43	1.94
	RD-ULV-F7	36	0.04	0.17	0.38	0.67	1.05	1.52	2.07

Table 189. Silencer face area

Unit Size	3	4	6	8	10	12	14	17	21	22	25	26	30
Area (ft²)	4.30	6.25	7.99	10.09	12.48	15.19	16.53	20.07	24.41	24.26	29.03	31.55	34.18
Unit Size	31	35	36	40	41	50	51	57	58	66	80	100	120
Area (ft²)	37.31	40.50	43.54	45.77	51.46	58.43	60.60	66.66	68.21	78.20	92.42	114.70	135.66

Trane Catalytic Air Cleaning Systems (TCACS)

Table 190. TCACS pressure drop

Static Pressure Drop (inches w.g.) by Face Velocity (fpm)									
Face Velocity	200	250	300	350	400	450	500	550	600
Pressure drop	0.010	0.014	0.017	0.022	0.026	0.030	0.035	0.040	0.045

Table 191. TCACS face area

Unit Size	3	4	6	8	10	12	14	17	21	22	25	26	30
Area (ft ²)	2.92	5.14	6.17	7.97	10.31	13.33	13.78	17.22	21.08	20.61	24.92	27.97	29.97
Unit Size	31	35	36	40	41	50	51	57	58	66	80	100	120
Area (ft ²)	32.72	35.00	38.89	39.67	39.61	51.11	53.03	60.69	62.25	68.89	79.22	107.25	126.00

Electrical Data

Table 192. Current requirements - full load amps

HP	VFD				Starter			
	200	230	460	575	200	230	460	575
1	6.30	6.30	2.50	2.30	4.80	4.20	2.10	1.70
1.5	6.30	6.30	2.50	2.30	6.90	6.00	3.00	2.40
2	7.30	7.30	3.40	2.60	7.80	6.80	3.40	2.70
3	10.40	10.40	4.80	3.80	11.00	9.60	4.80	3.90
5	16.80	16.80	8.30	5.90	17.50	15.20	7.60	6.10
7.5	23.80	23.80	10.60	9.20	25.30	22.00	11.00	9.00
10	32.20	32.20	14.20	11.10	32.20	28.00	14.00	11.00
15	48.30	48.30	21.00	16.60	48.30	42.00	21.00	17.00
20	61.90	61.90	27.60	21.40	62.10	54.00	27.00	22.00
25	78.20	78.20	34.00	26.30	78.20	68.00	34.00	27.00
30	92.00	92.00	41.00	31.20	92.00	80.00	40.00	32.00
40	117.00	101.30	53.00	39.90	120.00	104.00	52.00	41.00
50	n/a	126.60	64.00	50.60	n/a	130.00	65.00	52.00
60	n/a	n/a	77.00	60.40	n/a	n/a	77.00	62.00
75	n/a	n/a	104.00	75.00	n/a	n/a	96.00	77.00
100	n/a	n/a	128.00	92.40	n/a	n/a	124.00	99.00
125	n/a	n/a	157.00	n/a	n/a	n/a	156.00	n/a



Mechanical Specifications

Performance Climate Changer™ air handlers must be rigged, lifted, and installed in strict accordance with the Installation, Operation, and Maintenance manual (CLCH-SVX07A-EN) for Performance air handlers. The units are also to be installed in strict accordance with the specifications.

All units will be shipped with an integral base frame designed with the necessary number of lift points for safe installation. The lift points will be designed to accept standard rigging devices and be removable after installation. Units shipped in sections will have a minimum of four points of lift. Sizes 3-30 will also be shipped with a shipping skid designed for forklift transport.

Units will be shipped with a shipping skid designed for forklift transport and the integral base will be designed with the necessary number of lift points for safe installation. The lift points will be designed to accept standard rigging devices and removable after installation. Units shipped in sections will have a minimum of four points of lift.

Per ASHRAE 62.1 recommendation, units will be shipped stretch-wrapped to protect unit from in-transit rain and debris. Installing contractor is responsible for long-term storage in accordance with the Installation, Operation, and Maintenance manual (CLCH-SVX07A-EN).

Unit shall be UL and C-UL Listed.

Air-handling performance data shall be certified in accordance with AHRI Standard 430. Unit sound performance data shall be provided using AHRI Standard 260 test methods and reported as sound power. Coil performance shall be certified in accordance with AHRI Standard 410.

Seismic Certification

Trane has qualified listed air-handling unit sizes 3-30 as certified for seismic applications in accordance with the following International Building Code (IBC) releases: IBC 2000, 2003, 2006, 2009.

Seismic Qualification Testing and structural analysis shall be conducted in accordance with and strict adherence to the standards set forth within ASCE 7 by an independent approval agency with a complete list of certified models, options, and installation methods provided in an approved detailed report. The above referenced equipment shall be approved for seismic applications when properly installed and used as intended.

The basis of the certification shall be obtained through a combination of testing of the active and energized components per AC156, and analysis of the main force resisting members of the unit. Additional calculations shall be conducted to ensure components, accessories, and options remained intact and attached to the unit under seismic load conditions.

The certification shall be based on a maximum Design Structural Response Acceleration at Short Period (Sds) value of 1.85 g's for IBC 2006 and 2009, and 1.93 for IBC 2000 and 2003. This is obtained from the Maximum Considered Earthquake Short Period Spectral Response Acceleration, Ss, of 2.78 g's or 2.90 g's as determined by the ASCE 7 seismic maps for Soil Site Class B with 5 percent damping. When the site soil properties or final equipment installation location are not known, the soil site coefficient, Fa, defaults to the Soil Site Class D coefficient. Occupancy Category IV and Seismic Design Category C shall be covered under this certification, limited by the Sds value stated above. A seismic importance factor, Ip, of 1.5 shall apply to the certification to include essential facility requirements and life safety applications for post event functionality.

IBC 2000, 2003 FP/WP = $0.4 \times 2/3(Ss=2.90) \times (FA=1) \times (IP=1.5) \times (aP/RP=0.40) \times (1+2(z/h=1.0)) = 1.39 \text{ g's}$

IBC 2006, 2009 FP/WP = $0.4 \times 2/3(Ss=2.78) \times (FA=1) \times (IP=1.5) \times (aP/RP=0.42) \times (1+2(z/h=1.0)) = 1.39 \text{ g's}$

Structural floors, housekeeping pads, supporting curbs, and supporting steel must be seismically designed and approved by the project or building Structural Engineer of Record to withstand the seismic anchor loads. Installation details such as special inspection, attachment to a curb, or attachment to a non-building structure must be outlined and approved by the Engineer of Record for the project or building. The installing contractor shall be responsible for the proper installation

of the equipment and must observe the seismic installation requirements set forth by the Engineer of Record.

Unit Construction

Casing Construction

All unit panels shall be 2-inch solid, double-wall construction to facilitate cleaning of unit interior. Unit panels shall be provided with a mid-span, no through metal, internal thermal break. Casing thermal performance shall be such that under 55°F supply air temperature and design conditions on the exterior of the unit of 81°F dry bulb and 73°F wet bulb, condensation shall not form on the casing exterior.

All exterior and interior AHU panels will be made of galvanized steel. Optionally, all interior AHU casing panels will be made of stainless steel.

The casing shall be able to withstand up to 8 inches w.g. positive or negative static pressure. The casing shall not exceed 0.0042 inch deflection per inch of panel span at 1.5 times design static pressure up to a maximum of +8 inches w.g. in all positive pressure sections and -8 inches w.g. in all negative pressure sections.

Unit Flooring

The unit floor shall be of sufficient strength to support a 300-lb. load during maintenance activities and shall deflect no more than 0.0042 inch per inch of panel span.

Casing Leakage

The casing air leakage shall not exceed leak class 9 ($C_L = 9$) per ASHRAE 111 at 1.25 times maximum casing static pressure (P in inches w.g.), up to a maximum of +8 inches w.g. in all positive pressure sections and -8 inches w.g. in all negative pressure sections, where maximum casing leakage (cfm/100 ft² of casing surface area) = $C_L \times P^{0.65}$.

Optionally, the casing air leakage shall not exceed leak class 6 ($C_L = 6$) per ASHRAE 111 at 1.25 times maximum casing static pressure (P in inches w.g.), up to a maximum of +8 inches w.g. in all positive pressure sections and -8 inches w.g. in all negative pressure sections, where maximum casing leakage (cfm/100 ft² of casing surface area) = $C_L \times P^{0.65}$.

Insulation

Panel insulation shall provide a minimum thermal resistance (R) value of 13 ft²·h·°F/Btu throughout the entire unit. Insulation shall completely fill the panel cavities in all directions so that no voids exist and settling of insulation is prevented. Panel insulation shall comply with NFPA 90A.

Drain Pans

All cooling coil sections shall be provided with an insulated, double-wall, galvanized or stainless steel drain pan. To address indoor air quality (IAQ), the drain pan shall be designed in accordance with ASHRAE 62.1 being of sufficient size to collect all condensation produced from the coil and sloped in two planes promoting positive drainage to eliminate stagnant water conditions. The outlet shall be located at the lowest point of the pan and shall be sufficient diameter to preclude drain pan overflow under any normally expected operating condition. All drain pan threaded connections shall be visible external to the unit. Drain connections shall be of the same material as the primary drain pan and shall extend a minimum of 2 1/2 inches beyond the base to ensure adequate room for field piping of condensate drain traps. Coil support members inside the drain pan shall be of the same material as the drain pan and coil casing. Heating coil, access, and mixing sections may be provided with an optional IAQ drain pan.

Access Doors

Access doors shall be 2-inch double-wall construction. Interior and exterior door panels shall be of the same construction as the interior and exterior wall panels, respectively. All doors downstream of cooling coils shall be provided with a thermal break construction of door panel and door frame. Gasketing shall be provided around the full perimeter of the doors to prevent air leakage.

Surface-mounted handles shall be provided to allow quick access to the interior of the functional section and to prevent through-cabinet penetrations that could likely weaken the casing leakage and thermal performance. Handle hardware shall be designed to prevent unintended closure. Access doors shall be hinged and removable for quick, easy access. Hinges shall be interchangeable with the door handle hardware to allow for alternating door swing in the field to minimize access interference due to unforeseen job site obstructions. Door handle hardware shall be adjustable and visually indicate locking position of door latch external to the section.

All doors shall be a minimum of 60 inches high when sufficient height is available, or the maximum height allowed by the unit height.

Door handles will be provided for each latching point of the door necessary to maintain the specified air leakage integrity of the unit. Optionally, a single-handle door shall be provided for all outward swinging doors linked to multiple latching points necessary to maintain the specified air leakage integrity of the unit.

View Windows

An optional shatterproof window for viewing, capable of withstanding unit operating pressures, shall be provided in the door.

Marine Lights

A factory-mounted, weather-resistant (enclosed and gasketed to prevent water and dust intrusion), light emitting diode (LED) fixture shall be provided in sections of the unit as specified for maintenance and service visibility. Fixture shall be complete with aluminum die cast housing, polycarbonate lens designed for maximum light output, and LEDs wired to a single switch within a factory-provided service module. LED lighting shall provide instant-on white light and have a minimum 50,000 hour life. Fixtures shall be designed for flexible positioning during maintenance and service activities for optimal location.

All lights within the unit shall be wired to a single switch within the factory provided service module. The service module shall include a GFCI receptacle separate from the load side of the equipment. Electrical contractor shall be required to provide a 120V supply to the factory-mounted service module for the marine light circuit (unless single-point power is provided) and always for the GFCI receptacle circuit per NEC.

The service module shall be provided on the fan section, unless a controls section is provided. In which case, the service module will be provided on the controls section.

Fans

The fan type shall be provided as required for stable operation and optimum energy efficiency. The fan shall be statically and dynamically balanced at the factory as a complete fan assembly (fan wheel, motor, drive, and belts). The fan shaft shall not exceed 75 percent of its first critical speed at any cataloged speed. Fan wheels shall be keyed to the fan shaft to prevent slipping. The fan shafts shall be solid steel. The fan section shall be provided with an access door on the drive side of the fan.

FC Fan

The fan shall be a double-width, double-inlet, multi-blade-type, forward-curved (FC) fan. The fan shall be equipped with self-aligning, antifriction bearings with an L-50 life of 200,000 hours as calculated per ANSI/AFBMA Standard 9. Fan performance shall be certified as complying with AHRI Standard 430.

BC Fan

The fan shall be a double-width, double-inlet, multi-blade-type backward-curved (BC) fan. The fan shall be equipped with self-aligning, antifriction bearings with an L-50 life of 200,000 hours as calculated per ANSI/AFBMA Standard 9. Fan performance shall be certified as complying with AHRI Standard 430.

AF Fan

The fan shall be a double-width, double-inlet, multi-blade-type, airfoil (AF) fan. The fan shall be equipped with self-aligning, antifriction bearings with an L-50 life of 200,000 hours, as calculated per ANSI/AFBMA Standard 9. Fan performance shall be certified as complying with AHRI Standard 430.

Belt-Drive Plenum Fan

The fan shall be a single-width, single-inlet, multi-blade-type, plenum fan. The fan blades shall be backward-inclined airfoil. Belt-drive plenum fans shall be equipped with self-aligning, antifriction, pillow-block bearings with an L-50 life of 200,000 hours as calculated per ANSI/AFBMA Standard 9.

Direct-Drive Plenum Fan

The fan shall be a single-width, single-inlet, 9-blade or 12-blade plenum fan. The fan blades shall be aluminum backward-inclined airfoil. Plenum fan shall be direct-driven.

Fan sections containing multiple fans shall be controlled using a common control signal, such as the duct static control signal, to modulate the fan speed.

Fan Isolation

All fans, including direct-drive plenum fans, shall be mounted on isolation bases and isolated from the unit casing by a flexible connection.

1-Inch, Seismic Spring Isolators

The fan and motor assembly (on sizes 3 to 8) shall be internally isolated from the unit casing with 1-inch (25.3-mm) deflection spring isolators, furnished and installed by the unit manufacturer. The isolation system shall be designed to resist loads produced by external forces, such as earthquakes, and conform to the current IBC seismic requirements.

2-Inch, Seismic Spring Isolators

The fan and motor assembly (on sizes 10 to 120) shall be internally isolated from the unit casing with 2-inch (50.8-mm) deflection spring isolators, furnished and installed by the unit manufacturer. The isolation system shall be designed to resist loads produced by external forces, such as earthquakes, and conform to the current IBC seismic requirements.

Fan Drives

- *Variable Pitch.* The drives shall be variable pitch, suitable for adjustment within five percent of the specified speed.
- *Fixed Pitch.* The drives shall be constant speed with fixed-pitch sheaves.



Mechanical Specifications

- *1.2 Service Factor.* The drives shall be selected at a minimum 20 percent larger than the motor horsepower.
- *1.5 Service Factor.* The drives shall be selected at a minimum 50 percent larger than the motor horsepower.

Fan Motors

The motor shall be integrally mounted to an isolated fan assembly furnished by the unit manufacturer. The motor shall be mounted inside the unit casing on an adjustable base to permit adjustment of drive-belt tension. The motor shall meet or exceed all NEMA Standards Publication MG1 requirements and comply with NEMA premium efficiency levels when applicable. The motor shall have T-frame, squirrel cage with size, type, and electrical characteristics as shown on the equipment schedule.

- *Open Drip-Proof.* The motor shall be open and drip-proof.
- *Totally Enclosed Fan-Cooled (TEFC).* The motor shall be totally enclosed and fan-cooled.

Motor Options

- 200 volt, 3-phase, 60 Hz
- 230 volt, 3-phase, 60 Hz
- 460 volt, 3-phase, 60 Hz
- 575 volt, 3-phase, 60 Hz
- 115 volt, single-phase, 60 Hz
- 230 volt, single-phase, 60 Hz

Grease Lines

Bearings are selectable with life-time lubrication or with relubrication required. For any bearing requiring relubrication, the grease line shall be extended to the fan-support bracket on the drive side of the fan.

Fan Section Options

Multiple Belt Drive

The fan section with a belt-driven fan shall be provided with a multiple belt drive.

External Motor Junction Box

The fan section shall have motor leads extended to a factory-installed NEMA 4 external junction box to facilitate motor wiring and to maintain air leakage integrity of the casing.

Motor wiring conduit

The fan motor wiring shall be factory-wired to the unit-mounted starter/disconnect, variable frequency drive (VFD), or external motor junction box within flexible metal conduit of adequate length so that the fan vibration isolation will not be restricted.

Flow Meter

The fan shall have an airflow measurement system to measure fan airflow directly or to measure differential pressure that can be used to calculate fan airflow. The system shall predict airflow within +/-5 percent total accuracy (device and transmitter) when operating within the stable operating region of the fan curve. The submitted fan airflow performance and noise levels shall not be affected by the installation of the device. Any device that provides an obstruction to the fan inlet will not be accepted.

Belt Guard

Fan sections with centrifugal housed fans shall be provided with a corrosion-proof, wire mesh belt guard to deter incidental contact with rotating sheaves and belts.

Door Guard

Fans sections with plenum fans shall be provided with an expanded-metal guard screen for the access door, mounted on the door opening, to deter unauthorized entry and incidental contact with rotating components.

Fan Modulation

Variable-Frequency Drives (VFDs)

For variable-air-volume applications, airflow shall be modulated by a VFD that controls fan speed.

Inverter Test

Inverter test shall be performed to check vibration at unloaded conditions. Fan vibration levels shall be checked from 100 percent to 30 percent of required operating rpm.

Coils

Coils shall be manufactured by the supplier of the air handling unit and installed such that headers and return bends are enclosed by unit casing. Coils shall be removable by unbolting the wall panels in the coil section. Coil connections shall be clearly labeled on unit exterior. Fin surfaces shall be cleaned prior to installation in the unit to remove any oil or dirt that may have accumulated on the fin surfaces during manufacturing of the coil.

Horizontal and Vertical Coil Sections

The coil section shall be provided complete with coil and coil holding frame. Coil section side panels shall be easily removable to allow for removal and replacement of coils without impacting the structural integrity of the unit. The coils shall be installed such that headers and return bends are enclosed by unit casings. If two or more cooling coils are stacked in the unit, an intermediate drain pan shall be installed between each coil. Like the primary drain pan, the intermediate drain pan shall be designed being of sufficient size to collect all condensation produced from the coil and sloped to promote positive drainage to eliminate stagnant water conditions. The intermediate pan shall begin at the leading face of the water-producing device and be of sufficient length extending downstream to prevent condensate from passing through the air stream of the lower coil. Intermediate drain pan shall include downspouts to direct condensate to the primary drain pan. The outlet shall be located at the lowest point of the pan and shall be sufficient diameter to preclude drain pan overflow under any normally expected operating condition.

Inspection Section

The coil section shall include an inspection section complete with a double-wall, removable door downstream of the coil for inspection, cleaning, and maintenance. Interior and exterior door panels shall be of the same construction as the interior and exterior wall panels, respectively. All doors downstream of cooling coils shall be provided with a thermal break construction of door panel and door frame.

Water Coils (UW, UU, W, 5W, 5A, WD, 5D, D1, D2, P, or TT)

The coils shall have aluminum fins and seamless copper tubes. Copper fins may be applied to coils with 5/8-inch tubes. Fins shall have collars drawn, belled, and firmly bonded to tubes by mechanical expansion of the tubes. The coil casing may be galvanized or stainless steel. The coils shall be proof-tested to 300 psig and leak-tested under water to 200 psig. Coil performance data and coils



Mechanical Specifications

containing water or ethylene glycol shall be certified in accordance with AHRI Standard 410. Propylene glycol and calcium chloride, or mixtures thereof, are outside the scope of AHRI Standard 410 and, therefore, do not require AHRI 410 rating or certification.

Headers are to be constructed of round copper pipe or cast iron.

- Tubes shall be 1/2-inch OD, 0.016-inch copper.
- Tubes shall be 1/2-inch OD, 0.025-inch copper.
- Tubes shall be 5/8-inch OD, 0.020-inch copper.
- Tubes shall be 5/8-inch OD, 0.024-inch copper.
- Tubes shall be 5/8-inch OD, 0.035-inch copper.

Hydronic coils may be supplied with factory installed drain and vent piping to unit casing exterior.

Refrigerant Cooling Coils (UF, FD)

The coils shall have aluminum fins and seamless copper tubes. The fins shall have collars drawn, belled, and firmly bonded to tubes by mechanical expansion of the tubes. The coil casing may be galvanized or stainless steel. Suction and liquid line connections shall extend to the unit exterior.

The coils shall be proof-tested to 450 psig and leak-tested to 300 psig air pressure under water. After testing, the inside of the coils shall be dried, all connections shall be sealed, and the coil shall be shipped with a charge of dry nitrogen.

Suction headers shall be constructed of copper tubing with connections penetrating unit casings to permit sweat connections to refrigerant lines. The coils shall have equalizing vertical distributors sized according to the capacities of the coils. Coil performance data shall be certified in accordance with AHRI Standard 410.

- Tubes shall be 1/2-inch OD, 0.016-inch copper.
- Tubes shall be 1/2-inch OD, 0.025-inch copper.

Steam Heating Coil (NS)

The coils shall have aluminum fins and seamless copper tubes. Copper fins may be applied to coils with 1-inch tubes. The fins shall have collars drawn, belled, and firmly bonded to tubes by mechanical expansion of the tubes. The coil casing may be galvanized or stainless steel. Non-freeze, steam-distributing-type coils shall be provided. Steam coils shall be pitched in the unit for proper drainage of steam condensate from coils. The coils shall be proof-tested to 300 psig and leak-tested to 200 psig air pressure under water. Headers are to be constructed of cast iron. Inner tubes shall have orifices that ensure even steam distribution throughout the full length of the outer tube. Orifices shall be directed toward the return connections to ensure that the steam condensate is adequately removed from the coil. Coil performance data shall be certified in accordance with AHRI Standard 410.

- Tube construction shall be a 11/16-inch OD, 0.031-inch copper inner tube with a 1-inch OD, 0.031 copper outer tube.
- Tube construction shall be a 11/16-inch OD, 0.031-inch copper inner tube with a 1-inch OD, 0.049-inch red brass outer tube.

Coil Coating

The coil shall have a flexible epoxy polymer e-coat uniformly applied to all coil surface areas without material bridging between fins. Coating process shall ensure complete coil encapsulation and a uniform dry film thickness from 0.8 - 1.2 mil on all surface areas including fin edges. Superior hardness characteristics of 2H per ASTM D3363-92A and a cross-hatch adhesion of 4B-5B per ASTM B3359-93. Impact resistance shall be up to 160 in/lb. per ASTM D2794-93. Humidity and water immersion resistance shall be up to a minimum 1000 and 260 hours respectively (ASTM D2247-92 and ASTM D870-02). Corrosion durability shall be confirmed through testing to no less than 5,000 hours salt spray per ASTM B117-90 using scribed aluminum test coupons.

Electric Heat Coil Section

A UL-recognized electric heater shall be factory-installed in the air handler. The heater shall be an open-coil configuration with Type A wire (80% nickel and 20% chromium) derated to a maximum watt density of 45 watts per square inch. Safeties shall include three-pole, disconnecting-type contactors, airflow switches, automatic-reset functional limits, automatic-reset high-temperature limits, and manual-reset high-temperature limits. The contactors for energizing the electric heater shall be magnetic contactors. Electric heaters above 48 amps shall be fused into circuits not to exceed 48 amps as required by UL and NEC. Kilowatt output shall be selected to the nearest 0.1 kW of scheduled kilowatt.

Power options:

- 208 V, 3 ph
- 240 V, 3 ph
- 480 V, 3 ph
- 600 V, 3 ph

Control options:

- Basic External Relay Control
 - The electric heater shall use standard contactors with one side of the holding coil that may be connected to the thermostat or controller for staging purposes.
- Step Controller (0-10 VDC)
 - The electric heater shall be factory-wired to an electronic step controller relay bank. This type of control may be connected to a 0-10VDC or 4-20mA signal from a standalone thermostat or building automation system, which is converted to stages of heat.
- SSR-Full Modulating Control (0-10 VDC)
 - The electric heater shall be factory-wired to accommodate SSR-Full Modulating control. The SSR control can receive a 0-10VDC or 4-20mA signal from a standalone thermostat or building automation system providing full modulating control of the heater.
- SSR-Vernier Proportional Control (0-10 VDC)
 - The electric heater shall be factory-wired to accommodate SSR-Vernier control. The SSR control can receive a 0-10VDC or 4-20mA signal from a standalone thermostat or building automation system providing full modulating control of the first increment of heat, which is rated at 200% of all other chosen heat increments. There are a minimum of 3 and a maximum of 6 increments of heat stages. These stage increments are turned on and off by a step controller. As each stage is required to fulfill the demand for heat, the SSR increment is used as fully modulating between stages.

Integral Face-and-Bypass Coils

A section consisting of a horizontal or vertical-tube, integral face-and-bypass coil shall be provided. The coils shall be installed such that the headers and return bends are enclosed by the unit casings. The coils shall be sized as required to meet the scheduled capacity using steam or hot water, as specified. The integral face-and-bypass coils shall consist of a built-in series of finned heating elements and bypasses with interlocked dampers. Coil performance shall be certified in accordance with ARI Standard 410. Integral face-and-bypass coils shall be provided with a factory-mounted damper actuator when specified.



Mechanical Specifications

Dampers

Barometric Relief Dampers

The frame shall be 20 gage roll formed galvanized steel. Blades shall be 28 gage roll formed galvanized steel. Blade seals shall be extruded vinyl, mechanically attached to the blade edge.

Damper sections up to 24 inches wide shall be galvanized steel single tie bar linkage. Damper sections larger than 24 inches wide shall be stainless steel double tie bar linkage. Damper sections up to 42 inches wide shall be Zytel[®] synthetic axle assembly mechanically locked onto the blade edge. Damper sections larger than 42 inches wide shall be stainless steel axle and blade bracket assembly.

Damper Performance and Operating Conditions

The operating temperature range is -40F to 200F. Manufacturer must be able to demonstrate structural capacity of damper to withstand maximum system air velocity of 3,000 fpm when fully open. Manufacturer must be able to demonstrate structural capacity of damper to withstand maximum system back pressure of 6 inches w.g. in the closed position. Pressure drop shall be maximum 0.1 inch w.g. at 1,000 fpm across a fully open 24 inch x 24 inch damper. Damper pressure drop ratings shall be in accordance with Air Movement and Control Association (AMCA) 500.

Dimensions and Tolerances - In addition to the dimensions and tolerances shown on the applicable drawing, the following dimension tolerance criteria must be met:

- Mounting flange slot tolerance: -0/+0.031
- All sheet metal brake angles: +/- 3 degrees
- Overall frame size: +0/-0.125
- Mounting flange flatness:
- Overall dimension 48 inches and under: 0.062:/ft
- Over 48 inches: within 0.25 inch overall
- Frame squareness*: +/- 0.125 inch diagonal corner to corner

*Squareness is defined as the difference between two diagonal measurements.

Packing and Shipping - Dampers shall be prepared for shipment in accordance with commercial practice to assure carrier acceptance and safe transportation to the point of delivery. Packaging shall conform to carrier rules and regulations applicable to the mode of transportation.

Energy Recovery Wheel Section

The air-handling unit shall have a total energy recovery wheel sized per the ventilation requirement of the unit. Mixed air units with economizing shall be constructed with internal bypass dampers such that the pressure drop across the wheel does not increase during economizing.

Performance and Certification

The energy recovery wheel shall be ARI 1060-certified. The air-handling unit nameplate shall bear the ARI 1060 certification label. The energy recovery cassette shall be an Underwriters Laboratories (UL) Recognized Component certified for mechanical, electrical, and fire safety in accordance with UL Standard 1812. The calculated total net effectiveness of the recovery device shall be not less than 70 percent when the specified ventilation flow rate equals the exhaust flow rate.

Wheel Construction

The energy recovery wheel cassette shall incorporate a rotary wheel with all necessary seals, drive motor, and drive belts. The total energy recovery wheel shall incorporate a desiccant without the use of binders or adhesives. Coated segments shall be washable using standard detergent or alkaline-based coil cleaners. The desiccant shall not dissolve in the presence of water or high

humidity. The rim shall be of continuous rolled stainless steel and forms an even concentric circle, preventing leakage around the rim and minimizing the wear of components. All diameter and perimeter seals shall be provided as part of the cassette assembly. Perimeter seals shall be self-adjusting; diameter seals are adjustable. Seals shall be factory set. Wheel bearings shall be permanently sealed and lubricated and have a minimum L-10 life of 400,000 hours.

Wheel Motor

The wheel drive motor shall be mounted in the cassette frame. The wheel drive motor shall be thermally protected and UL Component Recognized. Drive belts shall not require belt tensioners.

Maintenance and Access

Energy recovery wheel shall be provided in the form of removable segments. The segments shall be removable without the use of tools to facilitate maintenance and cleaning as required. The cassette shall be removable through the energy recovery section side panel. Access doors shall be provided immediately upstream and downstream of the energy recovery wheel cassette. Adequate space shall be provided for cleaning, service, and maintenance of the wheel, motor, bearing, and belt.

Wheel Control

The energy recovery wheel section shall incorporate a variable effectiveness damper to control the energy wheel recovery capacity. The variable effectiveness control shall have the ability to modulate the total energy recovery effectiveness to 40 percent of the initial total recovery capacity. Variable frequency speed control is not an acceptable method for controlling capacity.

Frost Control

Frost control prevention shall be achieved by either outside air bypass, or return air preheat. Frost setpoint temperatures based on scheduled design air conditions shall be provided by the air handling manufacturer. Winter design supply and exhaust air conditions leaving the energy wheel provided by the unit manufacturer shall include any derate in performance due to frost protection measures.

Wheel Warranty

In conjunction with the air handler manufacturer 's standard unit warranty, the energy recovery wheel shall be warranted for a period of five years. Warranty applies to all parts and components of the energy recovery cassette with the exception of the motor.

Cool Dry Quiet (CDQ™) Desiccant Wheel

The air handling unit shall be provided with a CDQ desiccant wheel to control space humidity based on specified requirements. The wheel media shall meet the flammability requirements governing this class of products and shall be a UL-recognized component in accordance with UL 1812 and UL1995.

Wheel Construction

The CDQ desiccant wheel shall be constructed of a synthetic matrix with a type III desiccant. The wheel shall be structurally reinforced with a spoke system to minimize wheel deflection. All diameter and perimeter seals shall be provided as part of the cassette assembly. The drive system shall consist of a heavy-duty fractional horsepower A/C gear motor mounted in the cassette.

CDQ Wheel Drive System

The motor shall have permanently lubricated bearings. The bearings, which support rotation of the wheel around a center shaft, shall be provided with grease fittings for periodic lubrication.



Mechanical Specifications

Maintenance and Access Doors

The wheel matrix shall be cleanable. The desiccant shall not dissolve in the presence of water or high humidity. Access doors shall be provided immediately upstream and downstream of the CDQ wheel cassette. Adequate space shall be provided for cleaning, service, and maintenance of the wheel, motor, bearing, and belt.

Humidifiers

Direct Steam

Humidifier section shall be provided with a humidifier panel designed for building steam. Humidifier panel shall include stainless steel construction of all wetted parts including the header/separator and multiple tube dispersion assembly. Tube-to-header joints shall consist of welded stainless steel. Humidifier shall provide a uniform steam discharge. Humidifiers shall be provided with a steam separator, control valve, inverted bucket steam trap, wye strainer, and two float and thermostatic steam traps shipped loose for field installation. All pipe connections shall be made from one side of the air handler.

Atmospheric steam

Humidifier section shall be provided with a humidifier panel designed for atmospheric steam. Humidifier panel shall include stainless steel construction of all wetted parts including the header/separator and multiple tube dispersion assembly. Tube-to-header joints shall consist of welded stainless steel. Humidifier shall provide a uniform steam discharge. All pipe connections shall be made from one side of the air handler.

Filters and Air Cleaners

Filter sections shall have filter racks, at least one access door for filter removal, and filter block-offs to prevent air bypass around filters. The filter sections shall be supplied with 2-inch or 4-inch flat, or 2-inch or 4-inch angled, bag, or cartridge filters.

Permanent Filters

The filters shall be 2-inch, all-metal, viscous-imprisonment type, capable of operating up to 625-fpm face velocity without loss of filter efficiency and holding capacity. The filter media shall be layers of cleanable wire mesh. The filter frame shall be constructed of galvanized steel. The filters shall have a MERV 2 rating when tested in accordance with the ANSI/ASHRAE Standard 52.2.

Throwaway Filters

The filters shall be throwaway-type and shall have 2-inch fiberglass media contained in a rigid frame. Filters shall be capable of operating up to 500-fpm face velocity without loss of filter efficiency and holding capacity. Filters shall have a rigid supporting mesh across the leaving face of the media. The filters shall have a MERV 5 rating when tested in accordance with the ANSI/ASHRAE Standard 52.2.

Pleated Media Filters

The filters shall be 2-inch or 4 inch, made with 100 percent synthetic fibers that are continuously laminated to a supported steel-wire grid with water repellent adhesive. Filters shall be capable of operating up to 625-fpm face velocity without loss of filter efficiency and holding capacity. The filters shall have a MERV 8 rating when tested in accordance with the ANSI/ASHRAE Standard 52.2.

Bag Filters

The filters shall be fine-fiber, all-glass media with spun backing to keep glass fibers from eroding downstream. The stitching method shall permit the bag to retain its pleated shape without the use

of a wire-basket support. The filters shall be capable of operating up to 625-fpm face velocity without loss of filter efficiency and holding capacity.

The filters shall be sealed into a metal header. A gasket material shall be installed on the metal header of the filter to prevent filter bypass where the metal headers meet the side-access racks. All bag filters shall be furnished with a 2-inch pleated media MERV 8 prefilter to extend bag filter life.

The manufacturer shall supply a side-access filter rack capable of holding bag filters and prefilters.

The filters shall have a MERV 12 to 14 rating when tested in accordance with the ANSI/ASHRAE Standard 52.2.

Cartridge Filters

The filters shall be constructed with a continuous sheet of fine-fiber media made into closely spaced pleats. The filters shall be capable of operating up to 625-fpm face velocity for 12-inch deep filters without loss of filter efficiency and holding capacity.

The filters shall be sealed into a metal frame assembled in a rigid manner. A gasket material shall be installed on the metal header of the filter to prevent filter bypass where the metal headers meet on the side-access racks.

All cartridge filters shall be furnished with a 2-inch pleated media MERV 8 prefilter to provide extended cartridge life. The manufacturer shall supply a side-access filter rack capable of holding cartridge filters and prefilters. Cartridge filters shall have a MERV 11 to 15 rating when tested in accordance with the ANSI/ASHRAE Standard 52.2.

4-Inch High-Efficiency Filters

The filters shall be constructed with a fine fiber media made into closely spaced pleats. The filters shall be capable of operating up to 625-fpm face velocity without loss of filter efficiency and holding capacity. The filter media shall be sealed into a frame assembled in a rigid manner. All 4-inch high-efficiency filters shall be furnished with a 2-inch prefilter to provide extended filter life. The manufacturer shall supply a side-access filter rack capable of holding 4-inch high-efficiency filters and prefilters. The filters shall have a MERV 11 to 14 rating when tested in accordance with the ANSI/ASHRAE Standard 52.2.

HEPA Filters

The HEPA filter cells shall be enclosed in a galvanized steel frame with neoprene rubber applied to the leaving-air side of the filter cell to reduce air leakage. Continuously welded, front-load filter frames with filter holding clips shall be mounted inside the section casing and shall be gasketed to prevent leakage or air bypass. Filter clips shall require tooling in order to tighten and hold filter cells to frame. Filter media shall be produced from glass waterproof microfiber with a continuous pleat and aluminum separates between pleat folds. Filters shall be capable of operating up to 500-fpm face velocity without loss of filter efficiency and holding capacity. HEPA filter efficiency shall be not less than 99.97 percent when tested in accordance with ASHRAE 52.1 atmospheric dust spot method. Although not covered by MERV ratings, HEPA filters shall be not less than an equivalent 17 when tested in accordance with ASHRAE 52.2.

Ultraviolet (UVc) Lights

UV-C light fixtures and lamps shall be provided by the air handler manufacturer. The UV-C fixtures shall be factory-assembled and tested in the air handler. Lamp life shall be 9,000 hours minimum with no more than a 20% loss of output after two years of continuous use. The UV-C fixtures and lamps shall be coupled end-to-end and mounted on a slide-out rack to enable complete replacement and/or maintenance of the bulbs from the unit exterior. Fixtures shall meet the UL drip-proof design criteria. Fixtures shall be constructed of stainless steel to resist corrosion. Fixtures shall have been tested and recognized by UL/C-UL under Category Code ABQK (Accessories, Air Duct Mounted), UL Standards 153, 1598 & 1995.



Mechanical Specifications

All polymeric materials that come into direct or indirect (reflected) contact with UV-C light shall be UV-C resistant or shielded from the UV-C light using a certified UV-C tolerant material such as metal.

Access doors shall be provided at the location of each UV-C light as indicated on the plans and schedule. A view port with cover shall be provided to allow viewing of the UV-C light array to confirm operation. The view port and other AHU windows shall be treated to assure the UV-C energy emitted through it is below the threshold limits specified by NIOSH and ACGIH.

All sections of the handler with access doors where the UV-C lights may pose a risk for direct exposure shall have a mechanical interlock switch that disconnects power to the lights when the door is opened. Each UV section shall also be equipped with an externally mounted on-off/disconnect/shut off switch that disconnects power to the UV-C lights. The switch shall be equipped with a lock-out/tag-out to prevent unwanted operation of the UV-C lights.

Air Cleaning Systems

The Trane Catalytic Air Cleaner System (TCACS) shall be factory-engineered and factory-installed as a three-part integral assembly for treatment of air by:

1. High Efficiency Particle Filtration
2. Ultraviolet Germicidal Irradiation (UVGI) using UV-C lamps and fixtures
3. Photocatalytic Oxidation (PCO) catalyst media using titanium dioxide (TiO₂)

High efficiency particle filters shall be rated MERV 13 or higher. Filters are positioned upstream of the PCO media. UV-C lamps and ballasts designed specifically to provide type-C ultraviolet light with a wavelength at or near 253.7 Angstroms and shall not produce any ozone. Lamps shall be imbedded in the center of the catalyst media bank, spaced no further than six inches apart, and shall achieve a minimum coverage of five milliwatts per square inch of UVC light across all exposed surfaces of the PCO media. The catalyst media shall consist of six-inch deep (direction of airflow) grid with face area to match casing opening, one pleat per inch (nominal), and coated with 40-200 nanometer TiO₂. The complete PCO media bank assembly shall be housed in a galvanized or stainless steel casing and placed in the air handler perpendicular to the airflow. All UV lamps and PCO media shall be removable from outside the AHU casing through a side access door for maintenance purposes. An air flow switch shall be wired into the control circuit to disable the UV lights when the AHU fan is not running.

Power options:

- 120V/1 phase/60 hz
- 200-208V/3ph/60hz
- 230V/3ph/60hz
- 460V/3ph/60hz
- 575V/3ph/60hz

All 120V/1ph./60hz systems shall have an independent single point external power connection. Three phase systems shall be either independent single point power or integral with the AHU main power as shown on the drawings. All necessary main fusing shall be included.

Electrical fixtures shall meet the UL drip proof design criteria. Component enclosures shall be constructed of galvanized steel or stainless steel to resist corrosion. Fixtures shall have been tested and recognized by UL/C-UL under Category Code ABQK (Accessories, Air Duct Mounted), UL Standards 1995. For Line Voltage options, the TCACS shall be provided with a UL 508 listed panel for power distribution and over-current protection.

TCACS assemble shall be capable of withstanding 750 fpm face velocity with no structural damage

All polymeric materials that come into direct or indirect (reflected) contact with UV-C light shall be tested and certified as UV-C tolerant. Any non-conforming construction materials or components within the exposure zone shall be completely shielded from the UV-C light using a certified UV-C

tolerant material. UV-C tolerance is defined as being capable of performing its intended duty for a minimum of 20 years.

Access doors or panels shall be provided at the location of each Trane Catalytic Air Cleaner System as indicated on the plans and schedule. All access doors/panels shall have a mechanical safety interlock switch that disconnects the TCACS power upon opening. Each TCACS shall be equipped with an externally mounted electrical disconnect switch, with lock-out capability to prevent unwanted operation for maintenance purposes. A window shall be provided on each air handler to allow visual inspection of the Trane Catalytic Air Cleaner System during operation. The viewing window shall be guaranteed to block UV-C light emissions below the threshold limits specified by NIOSH and/or ACGIH. Units shall have a safety warning label applied to the exterior of each section containing UV-C lights. Complete safety, maintenance and servicing instructions for the Trane Catalytic Air Cleaner System shall be incorporated into the air handler manufacturer's standard installation, operating and maintenance manuals.

Filter Section Options

Differential Pressure Gage

A factory-installed dial type differential pressure gage shall be piped to both sides of the filter to indicate status. Gage shall maintain a +/- 5 percent accuracy within operating temperature limits of -20°F to 120°F. Gage shall be flush mounted with casing outer wall. Filter sections consisting of pre- and post-filters shall have a gage for each.

Mixing Section

Mixing Section, Filter Mixing Section, Airflow Measurement Station (Traq™ Dampers), and Economizer Sections

A functional section shall be provided to support the damper assembly for outdoor, return, and/or exhaust air.

Dampers

Dampers shall modulate the volume of outdoor, return, or exhaust air. The dampers shall be of double-skin airfoil design with metal, compressible jamb seals and extruded-vinyl blade-edge seals on all blades. The blades shall rotate on stainless-steel sleeve bearings. The dampers shall be rated for a maximum leakage rate of 3 cfm/ft² at 1 in. w.g. complying with ASHRAE 90.1 maximum damper leakage. All leakage testing and pressure ratings shall be based on AMCA Standard 500-D. Dampers may be arranged in a parallel or opposed-blade configuration.

Airflow Measurement Station (Traq Dampers)

A factory-mounted airflow measurement station tested in accordance with AMCA Standard 611 and bearing the AMCA Ratings Seal for Airflow Measurement Performance shall be provided in the outdoor and/or return air opening to measure airflow. The damper blades shall be galvanized steel, housed in a galvanized steel frame and mechanically fastened to a rotating axle rod. The dampers shall be rated for a maximum leakage rate of 4 cfm/ft² at 1 in. w.g. complying with ASHRAE 90.1 maximum damper leakage. The standard Traq airflow measurement station shall be capable of measuring from 15 percent to 100 percent of unit nominal airflow. Optionally, a low-flow Traq airflow measurement station shall be capable of measuring from 7.5 percent to 100 percent (sizes 6-30) of unit nominal airflow. The airflow measurement station shall adjust for temperature variations and provide a 2 to 10 Vdc signal that corresponds to actual airflow for controlling and documenting airflow. The accuracy of the airflow measurement station shall be ±5 percent.



Mechanical Specifications

Internal and External Face-and-Bypass Damper Section

Dampers shall be provided as scheduled to divert airflow around the coil. Dampers shall be of double-skin airfoil design with metal, compressible jamb seals and extruded-vinyl blade-edge seals on all blades. The blades shall rotate on stainless-steel sleeve bearings. Dampers are arranged in an opposed-blade configuration and mechanically linked with jackshafts. The dampers shall be rated for a maximum leakage rate of 5 cfm/ft² at 1 in. w.g. All leakage testing and pressure ratings shall be based on AMCA Standard 500-D.

Internal Face Damper Section

Dampers shall be provided as scheduled within the air handler. Dampers shall be of double-skin airfoil design with metal, compressible jamb seals and extruded-vinyl blade-edge seals on all blades. The blades shall rotate on stainless-steel sleeve bearings. Dampers are arranged in an opposed-blade configuration and mechanically linked with jackshafts. The dampers shall be rated for a maximum leakage rate of 5 cfm/ft² at 1 in. w.g. All leakage testing and pressure ratings shall be based on AMCA Standard 500-D.

Gas Heat Section

Indirect-fired gas heaters shall be completely factory assembled, piped, and operationally fire tested at the factory prior to shipment. The heat exchanger primary drum and secondary tubes shall be constructed from 14-gauge, 409 stainless steel. The industrial/commercial burner shall be UL listed, forced draft, and fully modulating. The control panel shall be equipped with Honeywell® RM7800 flame management controls and appropriate safeties. The gas heat section construction shall match the rest of the air handling unit and be an integral part of the unit. All burner and control components shall be housed in a burner vestibule with a large access door. The entire section shall bear a UL or CUL label for Commercial-Industrial Gas Heating Equipment (ANSI / UL Standard 795) and Industrial Gas-Fired Package Furnaces (CGA Standard 3.2-1976).

Air-to-Air Plate Frame Heat Exchanger

Construction

Air-to-air, fixed-plate heat exchangers shall be provided as indicated on the schedule and drawings. Exchangers shall be a cross flow, plate-type with no moving parts or secondary heat transfer surfaces. Plates shall be a minimum 99.5% aluminum and formed with a plate profile for maximum efficiency and cleanability, and minimizes pressure loss. The connecting plate edges shall be double-folded and internally sealed with a silicone free elastic resin to minimize leakage. The corners of assembled exchanger packages shall also be sealed to minimize leakage. The connecting plate edges shall be double-folded and internally sealed with a silicone free elastic resin to minimize leakage. The corners of assembled exchanger packages shall also be sealed to minimize leakage. Heat exchanger assemblies shall be able to withstand temperatures of 212F. Access to all four faces of exchangers shall be provided for cleaning and inspection. Drain pans shall be provided under each the supply and exhaust sides of the exchanger, with drain connections extending to the exterior of the unit base. Drain pans shall be either galvanized or stainless steel of the same construction as provided in other unit sections.

Performance

The heat exchanger shall be certified to ANSI/AHRI Standard 1060 and bear the AHRI 1060 label. Performance characteristics of the heat exchanger shall be provided as defined by AHRI 1060 definitions. The heat exchangers EATR shall be less than 1% as shown by AHRI certification. Heat exchanger face velocity shall not exceed 500fpm and not exceed specified pressure drop. Performance shall match or exceed specified effectiveness. Condensate volume at design conditions shall be predicted by the air handling unit manufacturer.

Corrosion Coating (Optional)

To provide protection for installations in mildly corrosive environments the air-to-air plate exchanger plates shall have an Epoxy-phenol lacquer applied coating. The extrusions, end plates and all sheet metal surfaces of the plate exchanger are to be epoxy coated.

Frost Damper (Optional)

Heat exchangers shall meet the leaving air temperature (LAT) as shown on the schedule while operating at the specified conditions and while operating in frost prevention mode. Frost prevention systems shall provide continuous output temperatures. Defrost systems with temperature swings due to defrost cycles will not be acceptable. Frost systems shall incorporate a partial face damper factory installed on the outside air side of the exchanger.

Bypass Dampers (Optional)

Opposed blade face and bypass dampers shall be provided as indicated on the schedule and drawings to modulate the plate exchanger effectiveness. Dampers shall have the same construction as the double-skin airfoil design specified in mixing sections. Bypass shall be through the center of the exchanger and shall be capable of 100% bypass. Static pressure drop through the bypass shall be calculated at the maximum economizing airflow and shall not exceed the schedule values.

Multizone Sections

Two-Deck Multizone

Multizone section shall be provided with a cooling coil in the lower deck and a heating coil in the upper deck. Pressure drop equalization baffles shall be provided, as required, to balance air pressure drop through each deck. Multizone dampers for controlling airflow through the upper and lower decks shall be double-skin airfoil design with metal compressible jamb seals and extruded vinyl blade edge seals on all blades. Blades shall rotate on stainless steel sleeve bearings. The dampers are rated for a maximum leakage rate of 11 (cfm)/(foot squared) at 1 inch wg.

Three-Deck Multizone

Multizone section shall be provided with a cooling coil in the lower deck, a heating coil in the upper deck, and a bypass (neutral) center deck. Pressure drop equalization baffles shall be provided, as required, to balance air pressure drop through each deck. Multizone dampers for controlling airflow through the three decks shall be double-skin airfoil design with metal compressible jamb seals and extruded vinyl blade edge seals on all blades. Blades shall rotate on stainless steel sleeve bearings. The dampers are rated for a maximum leakage rate of 11 (cfm)/(foot squared) at 1 inch wg.

Double-Duct Section

Double duct section shall be provided with a cooling coil in the lower deck and a heating coil in the upper deck. Pressure drop equalization baffles shall be provided, as required, to balance air pressure drop through each deck.

Triple-Duct Section

Triple duct section shall be provided with a cooling coil in the lower deck, a heating coil in the upper deck, and a bypass (neutral) center deck. Pressure drop equalization baffles shall be provided, as required, to balance air pressure drop through each deck.



Mechanical Specifications

Paint Options

Outdoor Unit Paint

External surface of unit casing shall be prepared and coated with a minimum 1.5 mil enamel finish or equal. Units supplied with casing exterior factory-painted shall be able to withstand a salt spray test in accordance with ASTM B117 for a minimum of 500 consecutive hours. Unit casing exterior will be provided with manufacturer's standard color, or alternative color when required.

Optional Indoor Unit Paint

In indoor units all exterior AHU panels will be made of galvanized steel. As an option, the external surface of the unit casing can be painted upon request. Units supplied with factory-painted exterior casing shall be able to withstand a salt spray test in accordance with ASTM B117 for a minimum of 500 consecutive hours. Unit casing exterior will be provided with manufacturer's standard color, or alternative color when required.

Pipe Cabinet

For outdoor units, piping cabinet shall be supplied by the manufacturer (factory-assembled) and shall be of the same construction as the main unit casing. Piping cabinet shall be mounted external to the unit and shipped separate to be field-installed.

Outdoor Unit Roof

Trane engineered inner roofs incorporate mid-span, internal thermal breaks to eliminate thermal conduction paths from the interior of the air handler to the exterior (2-inch R13 foam-insulated). Inner/ Indoor/ roof will be installed in such a manner as to prevent air bypass between internal components. A single layer Outer/Outdoor roof is utilized above the inner roof and will be sloped at a minimum 0.125inches per foot either from one side of unit to other, or from center to sides of the unit. Roof assembly will overhang all walls of units by a 1.5-inch minimum.

Silencers

A rectangular silencer shall be provided to reduce airborne sound transmitted through the air handler. The silencer ratings for dynamic insertion loss and pressure drop shall be in accordance with ASTM E-477 for forward flow (air and noise in the same direction) or reverse flow (air and noise in the opposite direction) per the project's requirements. Acoustical performance within the air handler unit assembly shall be in accordance with AHRI 260.

Other Sections and Options

Access/Inspection Sections

A section shall be provided to allow additional access/inspection of unit components and space for field-installed components as needed. The section length shall be variable to accommodate specific access, spacing, or dimensional requirements. An access door shall be provided for easy access. All access sections shall be complete with a double-wall, removable door downstream for inspection, cleaning, and maintenance. Interior and exterior door panels shall be of the same construction as the interior and exterior wall panels, respectively. All doors downstream of cooling coils shall be provided with a thermal break construction of door panel and door frame.

Blender Section

An air blender section shall be provided to mix outside and return air, minimize stratification, and reduce the risk of frozen coils. The blender size, space upstream, and space downstream shall be factory engineered for proper performance.

Diffuser Section

A diffuser section shall be provided immediately downstream of the fan section. The diffuser shall provide equal air distribution to blow-thru components immediately downstream of the diffuser.

Turning and Discharge Plenum Sections

Plenums shall be provided to efficiently turn air and provide sound attenuation. Discharge plenum opening types and sizes shall be scaled to meet engineering requirements. The vertical discharge plenum height may be scaled to accommodate the appropriate discharge duct height. The horizontal discharge plenum length may be scaled to accommodate necessary dimensional constraints.

Plenum Attenuation Panels

Discharge plenum panels shall include an acoustical liner. The liner shall be fabricated from stainless steel perforated material to prevent corrosion and designed to completely encapsulate fiberglass insulation. The perforation spacing and hole size shall be such as to prevent insulation breakaway, flake off, or delamination when tested at 9,000 fpm, in accordance with UL Specification 181.

Controls

Combination Starter–Disconnects

An IEC combination starter/disconnect shall be provided for each fan motor. Each starter / disconnect shall be properly sized, factory mounted in a full metal enclosure, and wired to the fan motor to facilitate temporary heating, cooling, ventilation, and/or timely completion of the project. Starter / disconnects shall include a circuit breaker disconnect with a through-the-door interlocking handle (external-mounted starters - sizes 3-120) or a beside-the-door interlocking handle (internal-mounted starters - sizes 3-120) spring loaded and designed to rest only in the full ON or OFF state and shall be lockable in these states. A concealed defeater mechanism shall allow entry into the enclosure when the handle is in the ON position. The starter package shall also include:

- Hand-Off-Auto (H-O-A) selector switch
- Two N.O. auxiliary contacts
- Overload heaters
- Manual reset overloads
- 120V control transformer with fusing and secondary grounding

Units with factory-mounted controls shall also include power wiring from the starter control transformer to the secondary control system transformers, and start-stop wiring from the direct digital controller start-stop relay to the starter H-O-A switch.

Combination VFD and Disconnects

A combination VFD/disconnect shall be provided for each fan motor. Each VFD/disconnect shall be properly sized, factory mounted in a full metal enclosure, wired to the fan motor, and commissioned to facilitate temporary heating, cooling, ventilation, and/or timely completion of the project. VFD/disconnects shall include a circuit breaker disconnect with a through-the-door interlocking handle (external-mounted starters - sizes 3-120) or a beside-the-door interlocking handle (internal-mounted starters - sizes 3-120) spring loaded and designed to rest only in the full ON or OFF state and shall be lockable in these states. A concealed defeater mechanism shall allow entry into the enclosure when the handle is in the ON position. The VFD package shall also include:

- Electronic manual speed control
- Hand-Off-Auto (H-O-A) selector switch
- Inlet fuses to provide maximum protection against inlet short circuit

Mechanical Specifications

- Current limited stall prevention
- Auto restart after momentary power loss
- Speed search for starting into rotating motor
- Anti-windmill with DC injection before start
- Phase-to-phase short circuit protection
- Ground fault protection

Units with factory-mounted controls shall include a control transformer with sufficient capacity to support both the VFD and controls requirements, binary output on/off wiring, analog output-speed-signal wiring, and all interfacing wiring between the VFD and the direct digital controller.

The VFD shall be UL508C listed and CSA certified and conform to applicable NEMA, ICS, NFPA, and IEC standards.

Optional Bypass

Bypass relays and bypass circuitry with a VFD/OFF/Bypass selector switch shall be provided.

Starter/Disconnect or VFD Enclosure Options

Starter or VFD shall be mounted externally on the fan section in a NEMA Type 1 enclosure (unit sizes 3-120) or internally in a NEMA Type 4 equivalent unit casing (unit sizes 3-120) within a dedicated controls section or housed fan section. The internal enclosure shall be an integral part of the unit casing to allow for thermal venting to casing interior, but shall be accessible from unit exterior through access door. Internally mounted starters/VFDs shall have doors with the same construction as other doors on unit. An external disconnect shall be mounted beside the access door to the starter or VFD to disconnect full power from starter/VFD, lights, or control power.

Factory-Mounted DDC System

Factory-mounted direct-digital control (DDC) system shall be engineered, mounted, wired, and tested by the air handler manufacturer to reduce installed costs, improve reliability, and save time at unit startup. Each control system shall be fully functional in a stand-alone mode or may be tied to a building automation system with a single pair of twisted wires. All factory-mounted controls shall be covered by the air handler manufacturer's standard warranty.

Direct Digital Controller

Field-Programmable Controller

A dedicated, programmable, direct digital-controller with the appropriate point capabilities shall be unit-mounted on each air-handling unit. A portable screen and keypad shall be provided to facilitate local monitoring, troubleshooting, and changing of setpoints. The touch pad shall be able to quickly plug into other factory-configured controllers by the same manufacturer.

Factory-Mounted Control Options—Electronic End Devices

All factory-mounted control devices shall be provided to accommodate integration into existing building systems. Devices provided shall be wired to standard point locations of a unit-mounted direct digital controller or terminal block for a remote controller.

Mixing Section Damper Actuators

Spring return actuators shall be mounted with the outdoor air damper linked as normally closed and the return-air damper linked as normally open.

Airflow Measuring Stations (Traq Dampers)

Airflow monitoring stations shall provide a 2 to 10 Vdc signal, which corresponds to cfm, for controlling and documenting airflow.

Temperature Sensors

Unit-mounted temperature sensor material shall be selected for ease of integration into existing BAS control systems. Temperature sensor material types include:

- 1k ohm RTD, Platinum 385
- 1k ohm RTD, Nickel
- 10k ohm, Type II Thermistor
- 10k ohm, Type III Thermistor
- 20k ohm, Type IV Thermistor
- 100k ohm, Type II Thermistor

Fan Discharge Temperature Sensors

A button or probe temperature sensor shall be mounted in the fan discharge. The sensor material shall be selected for ease of BAS integration.

Averaging Temperature Sensors

An averaging temperature sensor shall be serpentine across the functional section. Bends of the capillaries shall be curved and fastened with capillary clips to prevent crimping and minimize wear. The sensor material shall be selected for ease of BAS integration.

Low-Limit Switches

A double-pole low limit switch shall be wired to a momentary push-button reset circuit. Capillaries are serpentine across the entering side of the coil. The bends of the capillaries shall be curved and fastened with capillary clips to prevent crimping and minimize wear. A separate low limit shall be provided for each coil in a coil stack.

Airflow Switches

A differential pressure switch piped to the discharge and suction sides of the fan shall indicate fan status.

Dirty Filter Switches

A differential pressure switch piped to both sides of the filter shall indicate filter status.

Condensate Overflow Switches

A float switch conforming to UL 508 shall be factory-installed in the drain pan that will detect a high condensate water level and be used to shut off the air handler in the event that the primary drain is blocked to comply with IMC 2006. The float switch shall be located at a point higher than the primary drain line connection and below the overflow rim of the drain pan.

Customer Interface Relays

Five-amp double-pole, double-throw relays shall be provided as required for each binary output of the controller for customer interface to:

- Motor starters of supply, return, and exhaust fans
- Relief dampers
- Pumps
- Condensing units



Mechanical Specifications

Field-Mounted Control Options

Control Valves

Control valves shall be provided by the air-handling unit (AHU) manufacturer and field-piped by the piping contractor. Power and signal wiring shall be extended to a factory-installed external junction box to facilitate field-wiring and to maintain air leakage integrity of the casing.

Space Temperature Sensors

Thermistor-type sensors shall be provided by the air-handling unit (AHU) manufacturer as required for field wiring.

Outdoor Air Sensors

Thermistor-type sensors shall be provided by the air-handling unit (AHU) manufacturer as required for field wiring.

NOTES



NOTES



Trane optimizes the performance of homes and buildings around the world. A business of Ingersoll Rand, the leader in creating and sustaining safe, comfortable and energy efficient environments, Trane offers a broad portfolio of advanced controls and HVAC systems, comprehensive building services, and parts. For more information, visit www.Trane.com.

Trane has a policy of continuous product and product data improvement and reserves the right to change design and specifications without notice.

© 2013 Trane All rights reserved
CLCH-PRC022A-EN 10 Sep 2013
Supersedes CLCH-PRC015-EN (12 Dec 2012)

We are committed to using environmentally
conscious print practices that reduce waste.

