

# MPRX-FH Reader

## User Guide

16-0142-001 Rev A 1/2020

TransCore's Multiprotocol Reader Extreme Frequency Hopper (MPRX-FH) is a radio frequency identification (RFID) reader designed for harsh environment applications. This guide provides site planning, testing, and operating instructions for this system.



This guide is intended for use by authorized TransCore dealers, professional installers, and service personnel. The MPRX-FH must be installed by a professional installer. Once installed, configured, and verified by testing, the end user cannot change the configuration (transmit power, etc) of the MPRX-FH. If changes are required, the end user must contact their authorized TransCore dealer, professional installer, and/or service personnel for additional service.

Information in this document is subject to change and does not represent a commitment on the part of TransCore, LP.

© 2020 TransCore, LP. All rights reserved. TRANSCORE, AMTECH, EGO, and ENCOMPASS are registered trademarks and are used under license. All other trademarks are the property of their respective owners. Contents are subject to change. Printed in the U.S.A.

For further information, contact:

**TransCore**

8600 Jefferson Street NE  
Albuquerque, New Mexico 87113 USA

**TransCore Technical Support**

Phone: (505) 856-8007  
Web: [www.transcore.com](http://www.transcore.com)

[TransCore Sales Support](#)

[Phone: \(800\) 923-4824](tel:(800)923-4824)

**Lantronix® Technical Support (Ethernet Support)**

Phone: (949) 453-7198  
Web: [www.lantronix.com/support/](http://www.lantronix.com/support/)

# Approved Antenna List

## TRANSMITTERS FOR DETACHABLE ANTENNAS

This radio transmitter, ISED ID: 1584A-MPRXV1, has been approved by Innovation, Science, and Economic Development Canada to operate with the antenna types listed below, with the maximum permissible gain indicated. Antenna types not included in this list that have a gain greater than the maximum gain indicated for any type listed are strictly prohibited for use with this device.

### FCC COMPLIANCE NOTICE

The MPRX-FH complies with FCC Part 15.247 and IC RSS-247 rules and has been designed to operate with the listed antennas presented in [Table 1](#). The effective maximum gain of each antenna is listed as well as the required attenuation to ensure that effective gain of greater than the allowed 6dB cannot occur. The required attenuation presented in [Table 1](#) also includes any cable loss that is included with the system.

To reduce potential interference to other systems, antenna gain and type should be selected in a way that the EIRP (equivalent isotropically radiated power) is no more than the allowed 36dBm, preferably as low as possible that is needed for proper operation of the system.

**Table 1 Approved Antenna List**

Manufacture	Part Number	Polarization	Gain (dBi)	Min Inline Loss Required (dB)
Huber Suhner	1309.17.0111/85018546	Circular	5.50	0.00
Kathrein	52010087	Circular	11.00	5.00
Kathrein	52010249	Linear	11.00	5.00
Kathrein	52010092	Circular	-30.00	0.00
Laird	S9028P	Linear	8.00	2.00
Laird	S9025PR	Circular	5.50	0.00
MARS Antennas & RF Systems LTD.	MA-IS91-T2	Linear	10.50	4.50
Mobile Mark	PN6-915RCP-1C-WHT-6	RH Circular	6.00	0.00
Mobile Mark	PN6-915LCP-1C-WHT-6	LH Circular	6.00	0.00
Mobile Mark	PL8-915RCP-1Y-WHT-12	RH Circular	8.00	2.00
Mobile Mark	HD7-915RCP-BLK	RH Circular	7.00	1.00
MTI Wireless Edge LTD.	MT-263007/TRH/A/K	Circular	11.50	5.50
TransCore	AA3152 UTA	Linear	14.00	8.00
TransCore	AA3237	Linear	6.00	0.00
TransCore	AA3110	Linear	12.50	6.50
TransCore	AA3153	Linear	10.50	4.50

[Table 1](#) has the antenna polarization, peak linear dBi (decibels over isotropic) gain figures, and the required loss required between the MPRX-FH and the antenna. This loss can include the cable loss for the length of the cable required to set up system.

*Example:*

*To set up an MPRX-FH reader for use with the AA3152 antenna using a cable length of LMR-400 with an average attenuation of 3.94dBi and a length of 115ft, the cable loss would be 4.53dBi. With a gain of 14dBi*

from the AA3152, and another external attenuator with a value of at least 3.47dBi or greater, this setup would meet the FCC rule of the maximum EIRP of 36dBm.

## Liste des antennes approuvées

### ÉMETTEURS RADIO POUR ANTENNES DÉMONTABLES

Cet émetteur radio, n° ISDE 1584A-MPRXV1, a obtenu l'homologation d'Innovation, Sciences et Développement économique Canada pour fonctionner avec les types d'antennes qui figurent dans la liste ci-dessous, sous réserve du gain maximal admissible indiqué. Il est strictement interdit d'utiliser tout type d'antenne qui ne figure pas sur cette liste et dont le gain est supérieur au gain maximal indiqué sur la liste, tous types confondus, avec cet appareil.

### AVIS DE CONFORMITÉ À LA FCC

Le MPRX-FH est conforme à la section 15.247 des règles de la FCC et aux règles du CNR-247, et est conçu pour fonctionner avec les antennes énumérées dans la liste du [tableau 1](#). La liste prescrit le gain maximal apparent de chaque antenne, ainsi que l'atténuation requise pour faire en sorte qu'un gain apparent supérieur aux 6 dB admis ne peut se produire. L'atténuation requise indiquée au Tableau 1 comprend en outre toute atténuation de câble qui est comprise dans le système.

Pour limiter les interférences potentielles sur d'autres systèmes, le gain et le type d'antenne doivent être choisis de sorte que la puissance isotrope rayonnée équivalente (p.i.r.e.) ne dépasse pas les 36 dBm admissibles et, de préférence, soit la plus faible possible compte tenu des exigences de fonctionnement du système.

**Tableau 1 – Liste des antennes approuvées**

Fabricant	Numéro de pièce	Polarisation	Gain (dBi)	Atténuation de câble minimale requise (dB)
Huber Suhner	1309.17.0111/85018546	Circulaire	5,50	0,00
Kathrein	52010087	Circulaire	11,00	5,00
Kathrein	52010249	Linéaire	11,00	5,00
Kathrein	52010092	Circulaire	-30,00	0,00
Laird	S9028P	Linéaire	8,00	2,00
Laird	S9025PR	Circulaire	5,50	0,00
MARS Antennas & RF Systems LTD	MA-IS91-T2	Linéaire	10,50	4,50
Mobile Mark	PN6-915RCP-1C-WHT-6	Circulaire sens horaire	6,00	0,00
Mobile Mark	PN6-915LCP-1C-WHT-6	Circulaire sens antihoraire	6,00	0,00
Mobile Mark	PL8-915RCP-1Y-WHT-12	Circulaire sens horaire	8,00	2,00
Mobile Mark	HD7-915RCP-BLK	Circulaire sens horaire	7,00	1,00
MTI Wireless Edge LTD	MT-263007/TRH/A/K	Circulaire	11,50	5,50

TransCore	AA3152 UTA	Linéaire	14,00	8,00
TransCore	AA3237	Linéaire	6,00	0,00
TransCore	AA3110	Linéaire	12,50	6,50
TransCore	AA3153	Linéaire	10,50	4,50

Le tableau 1 indique la polarisation de chaque antenne, le gain linéaire maximal en dBi (décibels par rapport à l'antenne isotrope) et l'atténuation requise entre le MPRX-FH et l'antenne. Cette atténuation peut comprendre l'atténuation de câble sur toute la longueur de câble requise pour installer le système.

*Par exemple :*

*Pour installer un lecteur MPRX-FH à utiliser avec l'antenne AA3152 au moyen d'un câble LMR-400 à atténuation moyenne de 3,94 dBi, d'une longueur de 115 pi, l'atténuation de câble serait de 4,53 dBi. Le gain de l'antenne AA3152 étant 14 dBi, en utilisant un autre atténuateur externe d'une valeur de 3,47 dBi ou plus, cette installation respecte la p.i.r.e maximale de 36 dBm imposée par la FCC.*

**TO USERS IN THE UNITED STATES  
FEDERAL COMMUNICATIONS COMISSION (FCC)  
RADIO FREQUENCY INTERFERENCE STATEMENT  
47 CFR §15.105(A)**

**NOTE:** This equipment has been tested and found to comply with the limits for a Class A digital device pursuant to Part 15 of the FCC rules. These limits are designed to provide reasonable protection against harmful interference when the equipment is operated in a commercial environment. This equipment generates, uses, and can radiate RF energy and may cause harmful interference to radio communications if not installed and used in accordance with the instruction manual. Operating this equipment in a residential area is likely to cause harmful interference, in which case, depending on the laws in effect, the user may be required to correct the interference at their own expense.

**NO UNAUTHORIZED MODIFICATIONS  
47 CFR §15.21**



**CAUTION:**

*This equipment may not be modified, altered, or changed in any way without permission. Unauthorized modification may void the equipment authorization from the FCC and will void the warranty.*

**USE OF SHIELDED CABLES AND GROUNDING  
47 CFR §15.27(A)**

**NOTE:** Shielded cables and earth grounding the unit is recommended for this equipment to comply with FCC regulations.

**TRANSCORE, LP  
USA**

**AVERTISSEMENT À L'ATTENTION DES  
UTILISATEURS AUX ÉTATS-UNIS**

**DÉCLARATION 47 CFR §15.105(A) DE LA FCC SUR  
LES INTERFÉRENCES DES FRÉQUENCES RADIO**

**REMARQUE :** Cet appareil a été testé et déclaré conforme à la catégorie d'un appareil numérique de classe A en accord avec la partie 15 des directives de la FCC. Ces normes visent à assurer une protection raisonnable contre les interférences nuisibles lorsque l'appareil est utilisé dans un environnement commercial. Cet appareil génère, utilise et peut émettre de l'énergie RF et peut être à l'origine d'interférences nuisibles aux communications radio s'il n'est pas installé et utilisé en suivant les directives du manuel d'instructions. Si cet appareil est utilisé dans une zone résidentielle, il est probable qu'il cause des interférences nuisibles. Dans ce cas, l'utilisateur pourrait être amené à remédier aux interférences à ses propres frais, selon les lois du pays en vigueur.

**AUCUNE MODIFICATION NON AUTORISÉE  
47 CFR §15.21**



**MISE EN GARDE :** IL EST INTERDIT DE MODIFIER, D'ALTÉRER OU D'APPORTER DES CHANGEMENTS À CET APPAREIL DE QUELQUE MANIÈRE QUE CE SOIT SANS AUTORISATION. TOUTE MODIFICATION NON AUTORISÉE PEUT ANNULER L'AUTORISATION D'UTILISATION ACCORDÉE PAR LA FCC ET ANNULERA LA GARANTIE.

**UTILISATION DE CÂBLES BLINDÉS ET MISE À LA TERRE  
47 CFR §15.27(A)**

**REMARQUE :** Il est recommandé d'utiliser des câbles blindés et une mise à la terre avec cet appareil afin de répondre aux réglementations de la FCC

**TRANSCORE, LP  
ÉTATS-UNIS**

### **WARNING TO USERS IN CANADA**

This device contains licence-exempt transmitter(s)/receiver(s) that comply with Innovation, Science and Economic Development Canada's licence-exempt RSS(s). Operation is subject to the following two conditions:

1. This device may not cause interference.
2. This device must accept any interference, including interference that may cause undesired operation of the device.

### **AVERTISSEMENT AUX UTILISATEURS AU CANADA**

Cet appareil contient des émetteurs(s)/récepteurs exemptés de licence qui sont conformes à l'EXEMPTION de RSS(s) d'Innovation, Science et Développement économique Canada). L'opération est soumise aux deux conditions suivantes:

- 1) l'appareil ne doit pas produire de brouillage.
- 2) l'utilisateur de l'appareil doit accepter tout brouillage radioélectrique subi, même si le brouillage est susceptible d'en compromettre le fonctionnement.



**RADIO FREQUENCY HEALTH LIMITS FOR MPRX-FH READER  
USING AN EXTERNAL ANTENNA IN  
FREQUENCY BAND OF 902 TO 928 MHZ**

Several agencies (OSHA, FCC, IC) have environmental guidelines regulating maximum permissible exposure (MPE) or “safe” exposure levels that this product falls under. To ensure that proper safety guideline for the end users of this product, i.e. Occupational (Controlled) and General Population/Public (Uncontrolled), the recommended levels for each of the agencies are presented in the next sections with TransCore’s recommendations for safety in the last section.

***OSHA (Occupational Safety and Health Administration)***

OSHA (an agency of The United States of America) legislates in the Code of Federal Regulations (CFR) Title 29 Part 1910 Subpart G 1910.97 titled “Nonionizing radiation”, a maximum safe exposure limit of 10 milliwatts per square centimeter (mW/cm<sup>2</sup>) during any 0.1-hour period (i.e. 6 minutes). Using the frequency (in the middle of the band of operation of this equipment) of 915 MHz and the highest antenna gain that this equipment is certified for use in a final installation, the minimum safe distance was calculated to be 8in (20cm).

***FCC (Federal Communication Commission)***

FCC (an agency of The United States of America) legislates in the Code of Federal Regulations (CFR) Title 47 Chapter I Subchapter A Part 1 Subpart I Section 1.1310 titled “Radiofrequency radiation exposure limits” that the maximum permissible exposure (MPE) is the following:

***Occupational/Controlled Exposure***

*Power density = frequency(in MHz)/300 mW/cm<sup>2</sup> with an Averaging time of 6 Min*

***General Population/Uncontrolled Exposure***

*Power density = frequency(in MHz)/1500 mW/cm<sup>2</sup> with an Averaging time of 30 Min*

Using the frequency (in the middle of the band of operation of this equipment) of 915MHz and the highest antenna gain that this equipment is certified for use in a final installation, the minimum safe distance was calculated. The MPE minimum distances are 14in (36cm) for the Occupational/Controlled environment, and 31.5in (80.5cm) for the General Population/Uncontrolled environment.

***Industry Canada (Innovation, Science and Economic Development Canada)***

Industry Canada (a Department of the Government of Canada) sets out the requirements in Radio Standards Specification RSS-102, Issue 5 guidelines, recommending a maximum safe power density in W/m<sup>2</sup>. Thus, the maximum permissible exposure for general population/uncontrolled exposure at 915MHz is 2.77 W/m<sup>2</sup>. The average time is 6 minutes. The maximum permissible exposure (MPE) is the following:

***Controlled Environment***

*Power density = 0.6455\*frequency(in MHz)<sup>0.5</sup> W/m<sup>2</sup> with a Reference Period time of 6 Min*

**General Public/Uncontrolled Environment**

Power density =  $0.02619 * \text{frequency}(\text{in MHz})^{0.6834} \text{ W/m}^2$  with a Reference Period time of 6 Min

Using the frequency (in the middle of the band of operation of this equipment) of 915MHz and the highest antenna gain that this equipment is certified for use in a final installation, the minimum safe distance was calculated. The MPE minimum distances are 13in (32cm) for the Controlled environment and 33in (84cm) for the General Public/Uncontrolled environment.

**TransCore Recommendation on MPE (Maximum Permissible Exposure)**

The calculated power densities and MPE distance for each of the agencies respective to the environment is shown below.

Occupational/Controlled Environment				
Agency	Power Density (mW/cm <sup>2</sup> )	MPE minimum distance		Time (min)
		in	cm	
OSHA	10	5.5	14	6
FCC	3.05	10.2	26	6
IC	1.95	12.6	32	6

General Population/Public/Uncontrolled Environment				
Agency	Power Density (mW/cm <sup>2</sup> )	MPE minimum distance		Time (min)
		In	cm	
OSHA	10	5.5	14	6
FCC	0.61	22.0	56	30
IC	0.28	33.0	84	6

With the equipment installed and running at the maximum transmit power of 1.0W (30dBm), 0 dB transmit attenuation, using a 6dBi gain antenna that the equipment is certified for, the recommendation for each of the operation environments is as follows:

- 1) The antenna should be installed at least 33in (84cm) from the General Population/Public i.e. Uncontrolled Environment.
- 2) Maintenance personnel (i.e. Occupational/Controlled Environment) must remain at least 13in (32cm) from the antenna and limit their time in the environment to 6 minutes when the system is operating.

**LIMITES D'EXPOSITION AUX RADIOFRÉQUENCES POUR LE LECTEUR MPRX-FH  
UTILISANT UNE ANTENNE EXTERNE SUR LA BANDE  
DE FRÉQUENCES DE 902.25 À 903.75 ET DE 910.00 À 921.50 MHZ**

Plusieurs organismes (OSHA, FCC, IC) publient des directives environnementales qui recommandent des limites d'exposition maximale autorisée (normes MPE) ou des niveaux d'exposition « sûrs » auxquels cet appareil se conforme. Pour faire en sorte que chaque utilisateur final ait connaissance des directives de sécurité qui le concerne, que ce soit dans son travail (accès contrôlé) ou pour la population générale/le grand public (accès non contrôlé), TransCore présente les niveaux recommandés par chaque organisme dans ses recommandations sécuritaires détaillées dans la dernière section.

***OSHA (Occupational Safety and Health Administration)***

Dans le Code des réglementations fédérales (CFR), Titre 29, Partie 1910, Sous-partie G 1910.97, intitulée « Nonionizing radiation » (Rayonnements non ionisants), l'OSHA (organisme américain) recommande un plafond d'exposition maximale de 10 milliwatts par centimètre carré (mW/cm<sup>2</sup>) pendant une période de 0,1 heure (soit 6 minutes). En utilisant la fréquence de 915 MHz (milieu de la bande de fréquences de cet appareil) et le gain d'antenne maximal pour lequel cet appareil a reçu une certification d'utilisation dans une installation finale, la distance minimale sécuritaire est de 20 cm (8 po).

***FCC (Federal Communication Commission)***

Dans le Code des réglementations fédérales (CFR), Titre 47, Chapitre I, Sous-chapitre A, Partie 1, Sous-partie I, Section 1.1310 intitulée « Radiofrequency radiation exposure limits » (Limites d'exposition aux rayonnements de radiofréquence), la FCC (organisme américain) établit les limites d'exposition maximale autorisée (normes MPE) comme suit :

***Exposition professionnelle/contrôlée***

*Densité de puissance = fréquence (en MHz)/300 mW/cm<sup>2</sup> avec une durée moyenne de 6 min.*

***Exposition de la population générale/non contrôlée***

*Densité de puissance = fréquence (en MHz)/1500 mW/cm<sup>2</sup> avec une durée moyenne de 30 min.*

En utilisant la fréquence de 915 MHz (milieu de la bande de fréquences de cet appareil) et le gain d'antenne maximal pour lequel cet appareil a reçu une certification d'utilisation dans une installation finale, la distance minimale sécuritaire est la suivante : les distances MPE minimales sont de 36 cm (14 po) pour l'environnement professionnel/contrôlé et de 80,5 cm (31,5 po) pour la population générale/environnement non contrôlé.

**Industrie Canada (Innovation, Sciences et Développement économique Canada)**

Le Cahier des charges sur les normes radioélectriques 102, 5<sup>e</sup> édition, d'Industrie Canada (un ministère du Gouvernement du Canada) établit des recommandations pour une densité de puissance maximale sécuritaire en W/m<sup>2</sup>. Ainsi, l'exposition maximale admissible pour la population générale/non contrôlée à 915 MHz est calculée à 2,77 W/m<sup>2</sup>. La durée moyenne est de 6 minutes. Les limites d'exposition maximale autorisée (normes MPE) sont les suivantes :

**Environnement contrôlé**

*Densité de puissance = 0,6455\*fréquence (en MHz)<sup>0,5</sup> W/m<sup>2</sup> avec une durée de référence de 6 min.*

**Grand public/environnement non contrôlé**

*Densité de puissance = 0,02619\*fréquence (en MHz)<sup>0,6834</sup> W/m<sup>2</sup> avec une durée de référence de 6 min.*

En utilisant la fréquence de 915 MHz (milieu de la bande de fréquences de cet appareil) et le gain d'antenne maximal pour lequel cet appareil a reçu une certification d'utilisation dans une installation finale, la distance minimale sécuritaire est la suivante : les distances MPE minimales sont de 32 cm (13 po) pour l'environnement professionnel/contrôlé et de 84 cm (33 po) pour le grand public/environnement non contrôlé.

**Recommandations de TransCore sur les limites d'exposition maximale autorisée (normes MPE)**

Les densités de puissance et la distance MPE calculées par chaque organisme pour un environnement donné sont présentées ci dessous.

Exposition professionnelle/environnement contrôlé				
Organisme	Densité de puissance (mW/cm <sup>2</sup> )	Distance MPE minimale		Durée (en min.)
		po	cm	
OSHA	10	5,5	14	6
FCC	3,05	10,2	26	6
IC	1,95	12,6	32	6

Population générale/environnement non contrôlé				
Organisme	Densité de puissance (mW/cm <sup>2</sup> )	Distance MPE minimale		Durée (en min.)
		po	cm	
OSHA	10	5,5	14	6
FCC	0,61	22,0	56	30
IC	0,28	33,0	84	6

Avec l'équipement installé et fonctionnant à la puissance de transmission maximale de 1,0 W (30dBm), 0 dB transmettent l'atténuation, à l'aide d'une antenne à gain 6dBi pour

laquelle l'équipement est certifié, la recommandation pour chacun des environnements de fonctionnement est la suivante:

- 1) L'antenne devrait être installée à au moins 84 cm (33 po) de la population générale/du grand public, c'est-à-dire d'un environnement non contrôlé.
- 2) Le personnel d'entretien (c'est-à-dire dans un environnement professionnel/contrôlé) doit rester à au moins 32 cm (13 po) de l'antenne et limiter son temps d'exposition à 6 minutes lorsque l'appareil est en fonctionnement.

## Licensing Requirements

---

The MPRX-FH is an end-user license exempt device certified under FCC Part 15.247 and IC RS-247. As such, the end-user of this product is not required to file for a site license from the FCC (US) or IC (Canada). For other countries, refer to the local laws and frequency control agencies.

Once installed by a professional installer, the end user cannot make changes to the configuration (transmit power, etc.) of the unit.

# Table of Contents

---

Approved Antenna List . . . . .	iii
Licensing Requirements . . . . .	xi
<b>Chapter 1 System Overview . . . . .</b>	<b>1-17</b>
System Description . . . . .	1-17
Reader . . . . .	1-17
Compatible Tag Types . . . . .	1-22
<b>Chapter 2 Test Procedures . . . . .</b>	<b>2-23</b>
Required Tools and Equipment . . . . .	2-23
Pre-installation Testing of the MPRX-FH . . . . .	2-25
Testing the MPRX-FH Circuit . . . . .	2-25
Connecting the Antenna(s) . . . . .	2-26
Connecting the Power Supply . . . . .	2-29
Connecting Communications . . . . .	2-32
Connecting Sense Input and Sense Output Circuits . . . . .	2-32
<b>Chapter 3 General Software Information . . . . .</b>	<b>3-37</b>
Command Entry Conventions . . . . .	3-37
Command Response Conventions . . . . .	3-37
Operating Parameters . . . . .	3-38
Power Fail . . . . .	3-38
Program Download . . . . .	3-38
Startup . . . . .	3-39
Tag/Message Buffer . . . . .	3-40
<b>Chapter 4 Communications Protocols . . . . .</b>	<b>4-41</b>
Introduction . . . . .	4-41
Basic Protocol . . . . .	4-42
Error Correcting Protocol . . . . .	4-42
Data Inquiry Protocol . . . . .	4-43
Basic Protocol and ECP Format . . . . .	4-43
ECP Reliability . . . . .	4-50
Manually Disabling ECP for Maintenance . . . . .	4-53

<b>Chapter 5 Commands</b> .....	<b>5-55</b>
Default Settings .....	5-55
Operating Modes .....	5-55
Command List .....	5-56
<b>Chapter 6 Configuration</b> .....	<b>6-82</b>
Configuring the Reader .....	6-82
Terminal Emulation Software .....	6-83
Configuring MPRX-FH Parameters .....	6-86
<b>Chapter 7 Troubleshooting and Maintenance</b> .....	<b>7-94</b>
Error Messages .....	7-94
MPRX-FH Repair .....	7-97
Technical Support .....	7-97
<b>Chapter 8 AT5720 Check Tag-to-MPRX-FH</b> .....	<b>8-98</b>
Required Supplies .....	8-98
To assemble the kit for two check tags .....	8-98
<b>Appendix A Glossary</b> .....	<b>A-100</b>
<b>Appendix B Technical Specifications</b> .....	<b>B-105</b>
Reader Specifications .....	B-105
<b>Appendix C Wiring Information</b> .....	<b>C-108</b>
Communications Interfaces .....	C-108
<b>Appendix D Command Quick Reference</b> .....	<b>D-110</b>
Command Syntax .....	D-110
Factory Default Settings .....	D-110
Numerical Command List .....	D-111
Alphabetical Command List .....	D-116
<b>Appendix E Compatible Tag Information</b> .....	<b>E-122</b>
Tag Configurations .....	E-122
Tag Data Formats .....	E-123

# List of Figures

---

Figure 1 MPRX End Views . . . . .	1-17
Figure 2 Location of Host Port on MPRX. . . . .	1-19
Figure 3 Pin Assignments for Host Connector . . . . .	1-19
Figure 4 Location of Sense Port on MPRX . . . . .	1-20
Figure 5 Socket Assignments for Sense Connector . . . . .	1-20
Figure 6 Socket Assignments for Ethernet Connector . . . . .	1-21
Figure 7 Wiring for Audible Circuit Tester for MPRX-FH. . . . .	2-25
Figure 8 Connect RF N-type Load or Attenuator to Reader Cable End . . . . .	2-26
Figure 9 Short Load to Earth Ground . . . . .	2-27
Figure 10 MPRX-FH Showing Antenna Ports. . . . .	2-28
Figure 11 Location of MPRX-FH Ground Stud. . . . .	2-29
Figure 12 Location of Host/Sense Ports on MPRX-FH. . . . .	2-30
Figure 13 Stand-alone DeviceInstaller Link. . . . .	2-33
Figure 14 DeviceInstaller Start Menu . . . . .	2-33
Figure 15 Connecting Directly to Computer Ethernet Port . . . . .	2-34
Figure 16 Multiple NIC Cards . . . . .	2-34
Figure 17 Adapter Options . . . . .	2-34
Figure 18 Check for Updates Screen . . . . .	2-35
Figure 19 Disable Firewall . . . . .	2-35
Figure 20 LanTronix DeviceInstaller Screen . . . . .	2-36
Figure 21 Xport Direct+ Device Screen. . . . .	2-36
Figure 22 Tag and Antenna Orientation (horizontal polarization) . . . . .	6-85
Figure 23 MPRX-FH RF Control Options . . . . .	6-89
Figure 24 Sense CTAG Pinouts . . . . .	8-98
Figure 25 MPRX Exterior Case Dimensions . . . . .	B-106
Figure 26 MPRX End Panel Dimensions with Antenna Ports. . . . .	B-107
Figure 27 MPRX End Panel Dimensions with Communication Connectors . . . . .	B-107



# List of Tables

---

Table 1 Approved Antenna List . . . . .	iii
Table 2 Connector Cabling Accessory Kits . . . . .	1–18
Table 3 Power Supply Current Requirements . . . . .	1–18
Table 4 Recommended Cables . . . . .	1–22
Table 5 Pretest Accessory Options . . . . .	2–24
Table 6 Pretest Accessory Options Available From Third Party . . . . .	2–24
Table 7 Pin Assignments for Host Connector . . . . .	2–30
Table 8 Socket Assignments for Sense Connector . . . . .	2–31
Table 9 Inrush and Steady State Currents for MPRX-FH . . . . .	2–31
Table 10 Four-Character Command Structure . . . . .	3–37
Table 11 Sample Command Sequence . . . . .	3–38
Table 12 Select Baud Rate Commands . . . . .	5–57
Table 13 Select Stop Bits Commands . . . . .	5–58
Table 14 Select Parity Commands . . . . .	5–58
Table 15 Append Time and Date Commands . . . . .	5–60
Table 16 Append Auxiliary Information Commands . . . . .	5–60
Table 17 Unique ID Code Criteria . . . . .	5–62
Table 18 Select Valid Code Commands and Frames . . . . .	5–62
Table 19 Software Flow Control Commands . . . . .	5–73
Table 20 RF Control Commands . . . . .	5–74
Table 21 RF Attenuation Command Variables . . . . .	5–74
Table 22 Presence Without Tag Report Commands . . . . .	5–75
Table 23 RF Control Algorithm Commands . . . . .	5–76
Table 24 Timeout Period Values . . . . .	5–76

Table 25 Input Inversion Options . . . . . 5-77

Table 26 MPRX-FH Default Configuration Settings . . . . . 6-82

Table 27 Command Sequence to Verify Communications . . . . . 6-84

Table 28 Error Messages . . . . . 7-94

Table 29 Symptoms and Remedies . . . . . 7-95

Table 30 Check Tag 0 Wire Assignments . . . . . 8-98

Table 31 Check Tag 1 Wire Assignments . . . . . 8-99

Table 32 MPRX Host Communications Cable Pin Designations . . . . . C-108

Table 33 Communications Interfaces and Conductor Requirements . . . . . C-108

Table 34 MPRX SENSE Communications Cable Pin Designations. . . . . C-109

Table 35 Ethernet Pin Designations . . . . . C-109

Table 36 MPRX-FH Default Configuration Settings . . . . . D-110

Table 37 MPRX-FH Commands Listed Numerically . . . . . D-111

Table 38 MPRX-FH Commands Listed Alphabetically. . . . . D-116

Table 39 SeGo Protocol Tags . . . . . E-122

# Chapter 1 System Overview

## System Description

The MPRX-FH is a reader that supports transponders formatted for ISO/IEC 18000-63 (Tag Data Standard Protocol) and TransCore's Super eGo® (SeGo) radio frequency identification (RFID) technology.

### Operational Modes

The MPRX-FH reader can operate in several modes, depending on the application. All modes are read-only.

**ISO/IEC 18000-63:** This mode has applications mainly in the toll and access control environment.

**SeGo:** This mode has applications mainly in the toll and access control environment.

The operational mode of the reader is limited by the firmware load, and also by enabling or disabling the modes using the appropriate #4NN commands, as defined in “[Chapter 5 Commands](#)” on page 5–57.

## Reader

The MPRX-FH consists of an input/output (I/O) module, a power supply, a reader logic board (also called a tag decoder), and a radio frequency (RF) transmitter/ receiver (called the RF module) in a compact enclosure. These components are contained in a highly reliable, compact, and easy-to-install package. [Figure 1](#) shows the four port version of the MPRX-FH. The host connector, sense connector, Ethernet connector, and interface selection switch are on the opposite end of the MPRX-FH from the four antenna port locations.

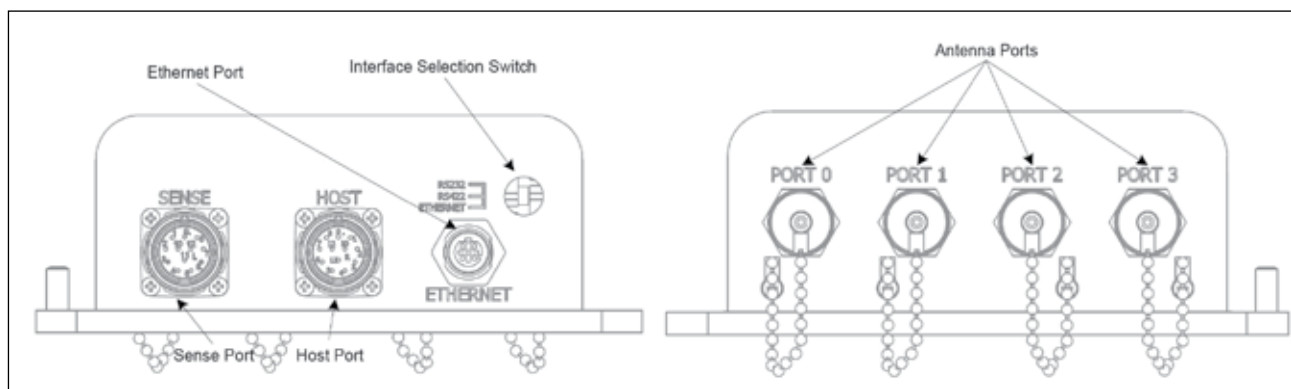

Figure 1 MPRX End Views

### Power and Communications Cables

Cable length for power and communications depends on the physical characteristics of the MPRX-FH installation site. [Table 2](#) lists accessory kits available for cabling options based on your site's requirements.

**Table 2 Connector Cabling Accessory Kits**

Part Number	Description
58-7200-001	MPRX-FH host connector leads 0.15m (6in)
58-7200-002	MPRX-FH host cable assembly 3m (120in)
58-7200-003	MPRX-FH host cable assembly 5m (200in)
58-7200-004	MPRX-FH host cable assembly 10m (400in)
58-7201-001	MPRX-FH sense connector leads 0.15m (6in)
58-7201-002	MPRX-FH sense cable assembly 3m (120in)
58-7201-003	MPRX-FH sense cable assembly 5m (200in)
58-7201-004	MPRX-FH sense cable assembly 10m (400in)

## Electrical Power

The MPRX-FH accepts 16-20VAC or 16-28VDC. Consult your local and national electrical codes for installation and safety requirements.

It is the installer's responsibility to supply conversion equipment and wiring. [Table 3](#) contains power supply current requirements.

Power circuits are protected internally against powersurges ( $\pm 30\%$ ).

**Table 3 Power Supply Current Requirements**

Supply	(RF On) <sup>a</sup> Maximum Power at 68°F (20°C)	(RF Off) <sup>a</sup> Standby Operating Power at 68°F (20°C)
16 to 20V AC	20W (Watts)	14W
16 to 28 V DC	20W	14W

a 1700 milliamp (mA) initial rush-in current at startup

## Host Communications

The MPRX-FH communicates through an asynchronous RS–232, RS–422, or Ethernet interface. [Figure 2](#) shows the MPRX-FH communications ports and [Figure 3](#) shows the host connector pin designations.

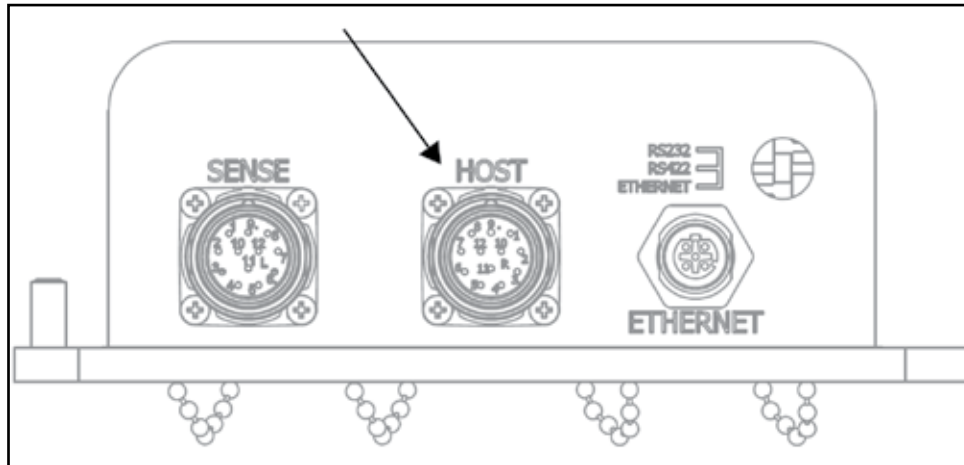

**Figure 2** Location of Host Port on MPRX



Pin Number	Operation
1	RS232_TX
2	RS232_RX
3	LOCK
4	LOCK_RTN
5	RS422_TX+
6	RS422_TX–
7	RS422_RX+
8	RS422_RX–
9	COM_GND (RS232 GND)
10	COM_GND (RS422 GND)
11	+V In
12	+V Return

**Figure 3** Pin Assignments for Host Connector

The standard RS–232/RS–422/Ethernet connection maximum distance depends on the baud rate, cable type, and the receiving device at the other end.

## Sense Connections

Figure 4 shows the location of the MPRX-FH sense port, and Figure 5 shows the sense connector socket designations.

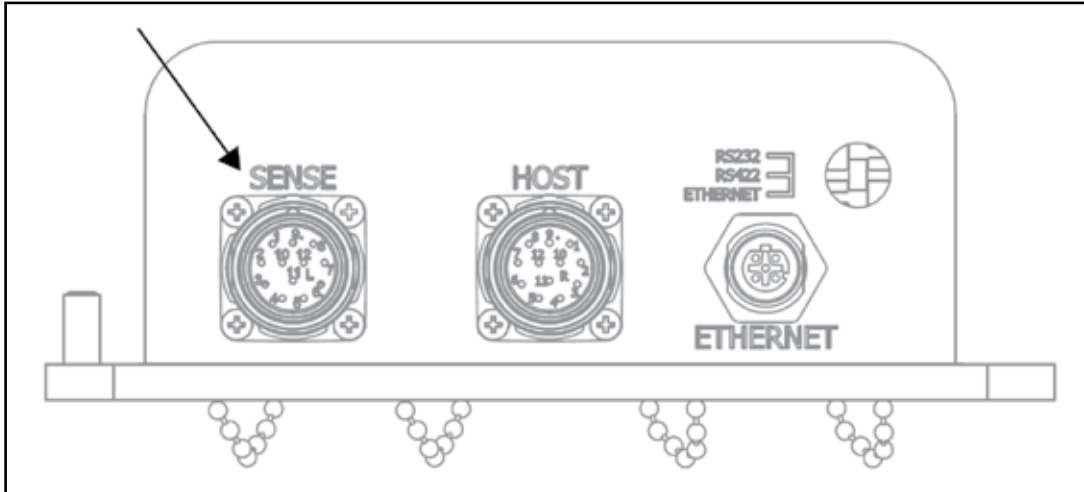
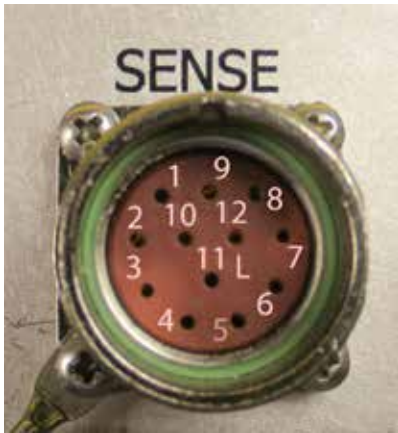

Figure 4 Location of Sense Port on MPRX



Socket Number	Operation
1	+12VDC OUT
2	OUT1
3	I/O GROUND
4	I/O GROUND
5	PULSE OUT
6	OUT0
7	CTAG 0
8	CTAG 1
9	I/O GROUND
10	I/O GROUND
11	SENSE 1
12	SENSE 0

Figure 5 Socket Assignments for Sense Connector

The MPRX-FH's two RF sense input circuits are TTL (Logic Level, 0V/5V), designed to be shorted to I/O Ground (0V) to provide sense presence detect for antenna ports 0 and 1 (Sense 0) and antenna ports 2 and 3 (Sense 1).

The MPRX-FH's tag lock output circuit is a single-pole, double-throw relay providing a dry contact closure. These contacts are rated at 42.2V AC peak ( $30V_{rms}$ ) or 60V DC, at 1A maximum with non-inductive load.

The output circuit is not intended for the direct control of electro-mechanical devices such as motorized barrier arms. For such applications, the MPRX-FH output circuit should be used to drive a secondary appropriately-rated high-power relay.

## Ethernet Interface

The Ethernet interface is a standard M12 socket. [Figure 6](#) shows the connector socket designation.

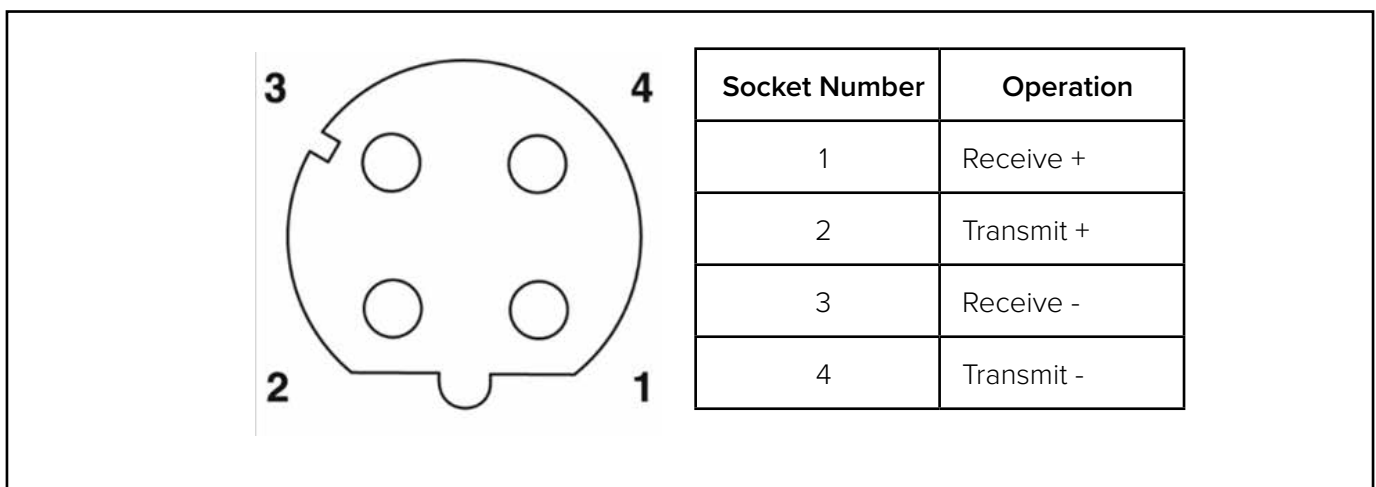

**Figure 6 Socket Assignments for Ethernet Connector**

## Antenna Interface

The site must include interface cable(s) between the MPRX-FH and the compatible antenna(s) chosen for the site. The antenna interface is a reverse polarity TNC connector.

Table 4 Recommended Cables

Cable Type <sup>a</sup>	Overall Diameter (in.)	Cable Loss per 100 ft
RG-223	0.216	12.8dB
RG-214	0.425	7.5dB
FSJ1-50	0.25	5.68dB
LDF2-50	0.375	11.01dB
FSJ4-50B	0.50	11.25dB
LDF4-50A	0.50	6.94dB

<sup>a</sup> Suffixes 50, 50A, and 50B indicate 50-ohm cables available from the Andrew Corporation.

## Compatible Tag Types

---

The MPRX-FH provides the capability to read ISO/IEC 18000-63 formatted tags and TransCore Super eGo (SeGo) protocol tags. Refer to [“Compatible Tag Information” on page E-124](#) for information on compatible tag models.



# Chapter 2 Test Procedures

## Required Tools and Equipment

---

Ensure that you have received all parts before beginning your pre-installation MPRX-FH tests.

Your MPRX-FH is packaged with the following materials:

- One MPRX-FH
- One MPRX-FH Quick Start Guide
- Any accessories ordered as options (refer to [Table 5.](#))

Other required accessories are:

- Power/communications cable harness
- 16-20VAC or 16-28VDC
- At least one MPRX-FH-compatible antenna (refer to “[Table 1 Approved Antenna List](#)” on page iii)
- Antenna RF cable

These may be ordered as accessories from TransCore or obtained from other sources.

### Additional Materials Needed for Testing

You will need these additional materials to perform the pretests on the MPRX-FH:

- Test tags, supplied by the TransCore dealer or distributor (formatted for ISO/IEC 18000-63 or SeGo)
- Suitable power wiring for the MPRX-FH (refer to “[Table 1 Approved Antenna List](#)” on page iii)
- Audible circuit tester and 9V DC battery for circuit tester power
- Wire stripper
- At least one MPRX-FH compatible antenna
- Suitable RF interface coaxial cable

## Pretest Accessory Options Available From TransCore

Table 5 lists optional TransCore MPRX-FH installation accessory items.

**Table 5 Pretest Accessory Options**

Part No.	Description
58-7200-001	MPRX-FH Host Connector with Leads 0.15m (6in)
58-7200-002	MPRX-FH Host Cable 3m (120in)
58-7200-003	MPRX-FH Host Cable 5m (200in)
58-7200-004	MPRX-FH Host Cable 10m (400in)
58-7201-001	MPRX-FH Sense Connector with Leads 0.15m (6in)
58-7201-002	MPRX-FH Sense Cable 3m (120in)
58-7201-003	MPRX-FH Sense Cable 5m (200in)
58-7201-004	MPRX-FH Sense Cable 10m (400in)
20-7001-001	MPRX-FH check tag accessory kit
13-5118-903	Test Rail Tag with metal back plane – Rail-car Format – SeGo
13-5118-904	Test Rail Tag with metal back plane – Locomotive Format – SeGo

Table 6 lists pretest accessory options available from a third party.

**Table 6 Pretest Accessory Options Available From Third Party**

Mfg Part No.	Mfr.	Description
HG908P-NM	LCOM	915 Mhz Bench Antenna – LCOM – 4 ft type N male connector
4N5W-03	AERO FLEX	Type N attenuator 5 W – 3 db
4N5W-10	AERO FLEX	Type N attenuator 5 W – 10 db
4N5W-15	AERO FLEX	Type N attenuator 5 W – 15 db
3018-5W	AERO FLEX	Type N 50 ohm load – 5 W

## Pre-installation Testing of the MPRX-FH

Pretest involves the following steps:

- Testing the MPRX-FH circuit
- Connecting the antenna(s)
- Connecting the power supply
- Connecting communications
- Connecting sense input and sense output circuits
- Power and tag read capability testing prior to final installation of the MPRX-FH

## Testing the MPRX-FH Circuit

Before installing the MPRX-FH permanently at the site, you should test the circuit to confirm that the MPRX-FH has power and can read a tag that is in the tag read zone.

A voltage meter or audible circuit tester (buzzer) is necessary in order to test the circuit. An example test setup diagram is shown in [Figure 7](#). The buzzer is powered by a 9VDC battery and is equipped with two alligator-clip leads. When you touch the leads together, the box will produce an audible sound.

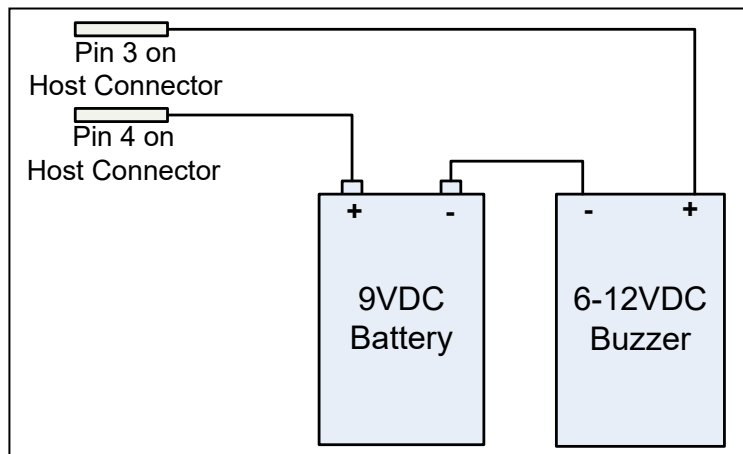

Figure 7 Wiring for Audible Circuit Tester for MPRX-FH

## Connecting the Antenna(s)

To test the MPRX-FH, connect the antenna and power supply as described in this section.

### Discharge Voltage from the Antenna



#### Caution

***During shipping and installation, an antenna can build up a very high voltage charge. The voltage needs to be discharged before connecting the antenna to the reader. TransCore strongly advises that you use adequate Earth Ground for this voltage discharge procedure in accordance with the National Electric Code for the locale where you are installing the MPRX-FH.***

Use these instructions to discharge high voltage from the antenna before proceeding with further pre-installation testing of the reader.

### Required Equipment

This procedure requires the following equipment.

- MPRX-FH
  - External antenna
  - Grounding RF cable (long enough to reach Earth Ground source)
  - N-type load (e.g., 50  $\Omega$ ) or RF attenuator (e.g., 20 dB)
1. Terminate the reader end of the grounding RF cable with any N-type load or RF attenuator ([Figure 8](#)).

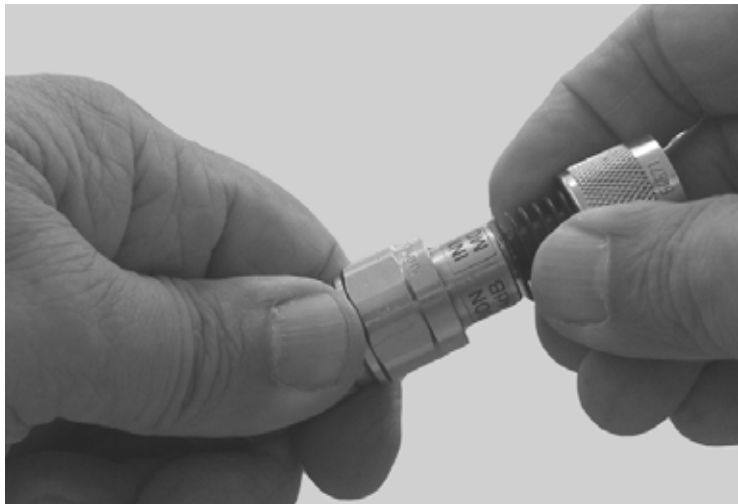
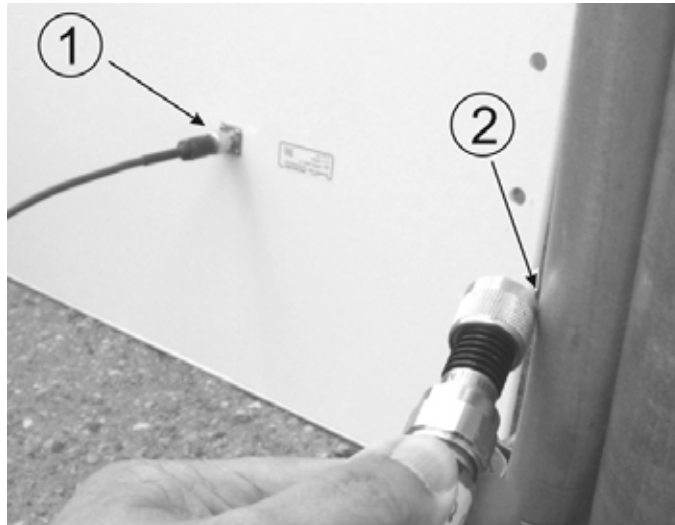

**Figure 8 Connect RF N-type Load or Attenuator to Reader Cable End**

2. Connect the grounding RF cable to the antenna (Item 1 in [Figure 9](#)).
3. Short the outer metal case of the load or attenuator to Earth Ground for approximately 10 seconds (Item 2 in [Figure 9](#)). In this example, the operator is using the mounting pole that has been properly connected to Earth Ground.

**CAUTION**

*TransCore does not recommend using a screwdriver or other tool to short the RF cable center conductor to the outer ground of the cable. This grounding method can damage the center pin or the threads of the connector.*



**Figure 9 Short Load to Earth Ground**

4. Disconnect the grounding RF cable from the antenna and connect the permanent RF cable to reader.  
Once the antenna is discharged and properly connected to the reader, the reader circuitry provides a DC path to keep any further charge from building up in the antenna.

## Connecting the Reader and Antenna

1. Ensure the reader is turned off and power is disconnected.
2. Connect one end of the RF interface cable to the antenna.
3. Connect the other end of the RF interface cable to the appropriate antenna port on the end of the MPRX-FH. Refer to [Figure 10](#).
4. The ports can be turned on in consecutive order. If all four ports will not be used, start with Port 0 and turn on connected ports. Unused ports should be set to **OFF**. Refer to “[Numerical Command List](#)” on page D–113 for a list of commands.

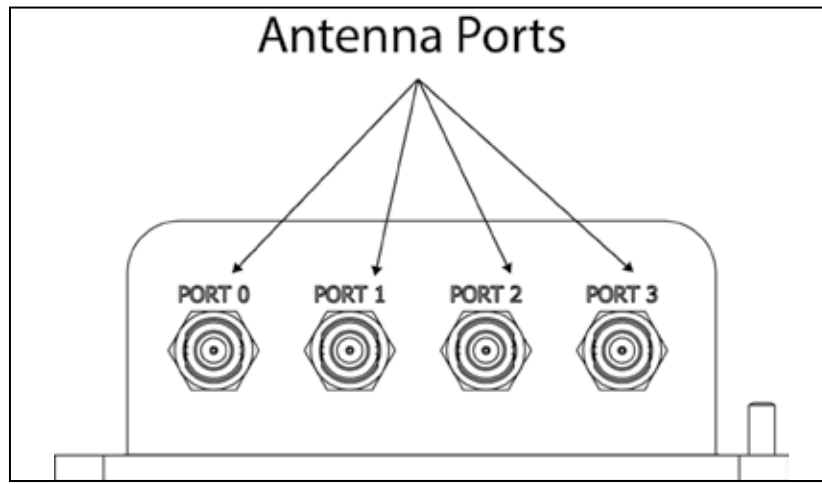

Figure 10 MPRX-FH Showing Antenna Ports

## Connecting the Power Supply



### Caution

To avoid damage to the MPRX-FH, first connect the reader to Earth Ground using a ground cable and stake before powering up the reader or connecting to an antenna. TransCore recommends following the National Electric Code or equivalent code for surge protection for the locale where the MPRX-FH is installed. A minimum of 18 AWG wire to earth ground is required for protective earthing.

Connect any antenna(s) or terminate the antenna ports before applying power to the reader.

### Connect the MPRX-FH to a Power Supply

1. Connect the MPRX-FH to Earth Ground. Figure 11 shows the location of the MPRX-FH ground stud.

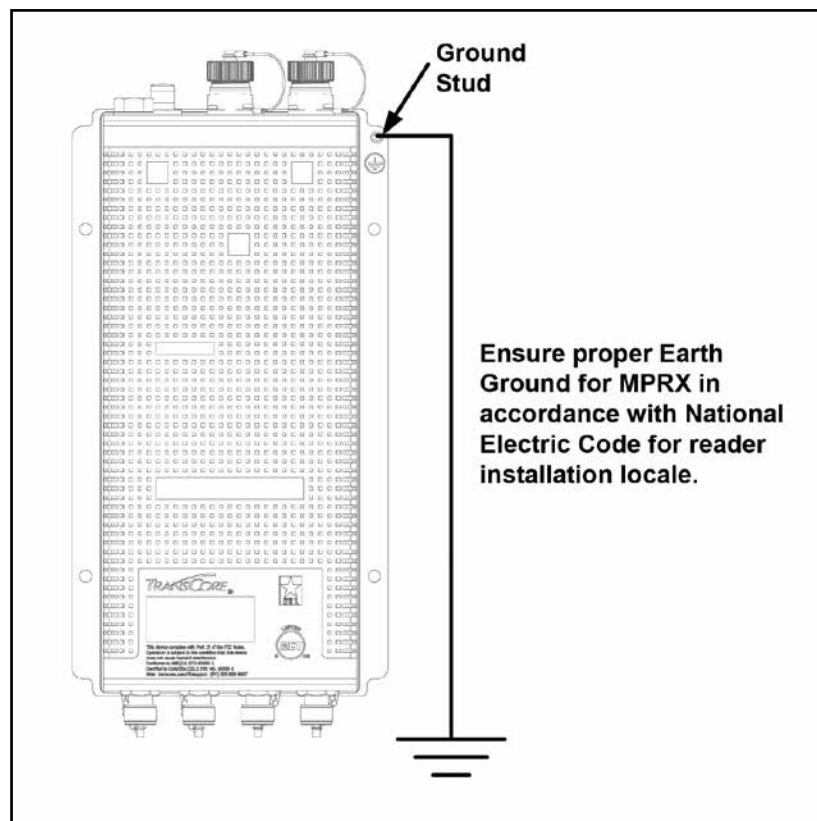

Figure 11 Location of MPRX-FH Ground Stud

2. Connect the MPRX-FH to a power supply using the host interface cable.

The Sense and Host ports on the MPRX-FH are M23 connectors (Figure 12). Table 7 lists the pin assignments for the Host connector and Table 8 lists the socket assignments for the Sense connector.

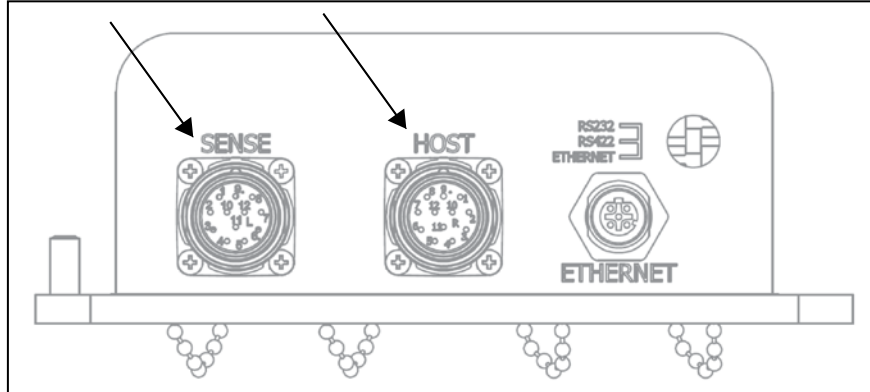

Figure 12 Location of Host/Sense Ports on MPRX-FH

Table 7 Pin Assignments for Host Connector

Pin Number	Operation
1	RS232_TX
2	RS232_RX
3	LOCK
4	LOCK_RTN
5	RS422_TX+
6	RS422_TX-
7	RS422_RX+
8	RS422_RX-
9	COM_GND (RS232 GND)
10	COM_GND (RS422 GND)
11	+V In
12	+V Return



Table 8 Socket Assignments for Sense Connector

Socket Number	Operation
1	+12VDC OUT
2	OUT1
3	I/O GROUND
4	I/O GROUND
5	PULSE OUT
6	OUT0
7	CTAG 0
8	CTAG 1
9	I/O GROUND
10	I/O GROUND
11	SENSE 1
12	SENSE 0

### Connect the Power Supply

After mounting the MPRX-FH, connect the reader to a dedicated 16–28VDC or 16–20VDC power supply.

The MPRX-FH should be connected to power with an external fuse to protect both the MPRX-FH and power source. Inrush and Steady State currents for the MPRX-FH are listed in Table 9. Choice of fuse type and rating shall comply with regulatory requirements of the installation.

Table 9 Inrush and Steady State Currents for MPRX-FH

MPRX-FH Current			
Voltage (VDC)	Inrush Current (A)	Inrush Time (ms)	Steady State Current (A)
12	4.89	1.38	1.68
24	9.4	2.46	0.87



#### Caution

***To avoid damage to the MPRX-FH, connect the MPRX-FH to ground before powering up the reader or connecting the antenna(s).***

***Connect the antenna(s) before applying power to the reader.***

## Interface Selection Switch

The MPRX-FH incorporates a communications interface selection switch, which allows on-the-fly changes to the communications mode. This switch allows selecting the reader's receive communications interface. All communications interfaces are configured for simultaneous transmit, but only the interface selected by the switch is active for commands transmitted into the reader.

## Connecting Communications

The MPRX-FH communicates through RS-232, RS-422, or Ethernet protocols.

### Required Materials

You need the following materials to connect the communications cable to the host device:

- Host device
- Any terminal emulation program operating on a PC

### Connecting the MPRX-FH to the Host Port

MPRX-FH communications and customer interface signals are supplied from the MPRX-FH to the host through a multi-wire cable. The connector for this cable is located on the end of the MPRX-FH (Figure 12 on page 2–32).

Insert one end of the MPRX-FH communications/power interface connector into the M23 Host connector at the MPRX-FH and the other end into the customer-supplied host device connector. Refer to Table 7 and Table 8 for pin assignments and numbers.

## Connecting Sense Input and Sense Output Circuits

The MPRX-FH has two sense input circuits and a tag lock output circuit available. SENSE 0 is used to enable RF on antenna ports 0 and 1 if enabled, and SENSE 1 is used to enable RF on antenna ports 2 and 3. The sense input circuits are used to notify the MPRX-FH of train presence and are designed to be connected to a free-of-voltage dry contact. The tag lock output circuit is a single-pole, double-throw relay that provides a normally closed and normally open dry contact. The relay contact is rated at 42.2VAC peak (30 Vrms) or 60VDC at 1 A maximum.



### CAUTION

*If controlling an external gate or device requiring high current, an isolation transformer is required.*

### Sense Input Circuits

The MPRX-FH supports two sense inputs – SENSE 0 and SENSE 1 – which require two sense input lines (SENSE x and GND) for each loop sense or a total of four sense input connections. SENSE 0 is used to control RF power for the track that has antennas connected to RF ports 0 and 1. The sense inputs are wired through the reader M23 sense connector. The MPRX-FH expects the SENSE 0 circuit to close when a rail car is present (on the track with antennas connected to MPRX-FH ports 0 and 1).

SENSE 1 must be closed when a rail car is present on the track connected to MPRX-FH antenna ports 2 and 3. The reader RF switches on to the appropriate RF ports immediately upon detecting SENSE x.

## Sense Output Circuit

The sense output is dedicated for testing and reader setup. It is defined as the TAG\_LOCK signal, which indicates a valid tag is in the read field.

This sense output is a dry contact that provides a normally open and normally closed sense output. The relay contacts are rated at 42.2VAC peak (30 Vrms) or 60VDC at 1A maximum. If controlling an external gate or device requiring high current, an isolation transformer is required.

## Interface through Ethernet Port

To interface through the Ethernet port of the MPRX-FH, connect via the M12 Ethernet port (Use an M12 to RJ45 adapter if required). A static IP address will need to be assigned to the local host if directly connected, or the reader may be attached to the network.

## Setting up Local Host

1. From the following link, install the stand-alone DeviceInstaller. (Refer to [Figure 13](#).) This is needed to know the IP address of the Ethernet to serial converter.

[http://ltxfaq.custhelp.com/app/answers/detail/a\\_id/644?\\_ga=1.59440430.2035039615.1475511776](http://ltxfaq.custhelp.com/app/answers/detail/a_id/644?_ga=1.59440430.2035039615.1475511776)

Product	Comment
<a href="#">Stand-alone DeviceInstaller Setup application for Windows (91 MB) - ZIP Archive</a>	No internet access required to install

**Figure 13 Stand-alone DeviceInstaller Link**

2. Once installed, launch DeviceInstaller from the START menu ([Figure 14](#)).

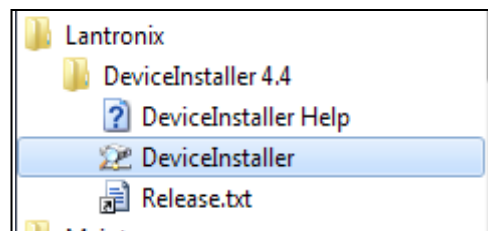

**Figure 14 DeviceInstaller Start Menu**

3. Select whether to direct-connect to the computer Ethernet port or whether to connect to the corporate network.

## Connecting Directly to Computer Ethernet Port

1. Go to the computer's network setting and change the IP address and Subnet mask of the network interface controller (NIC) card you are connecting to as shown in [Figure 15](#).



**Figure 15 Connecting Directly to Computer Ethernet Port**

2. If the computer has multiple NIC cards, a prompt may appear as shown in [Figure 16](#). Select YES.



**Figure 16 Multiple NIC Cards**

3. At the next prompt, choose the desired adapter ([Figure 17](#)). If necessary, the selection can be changed at a later time through the OPTIONS menu.

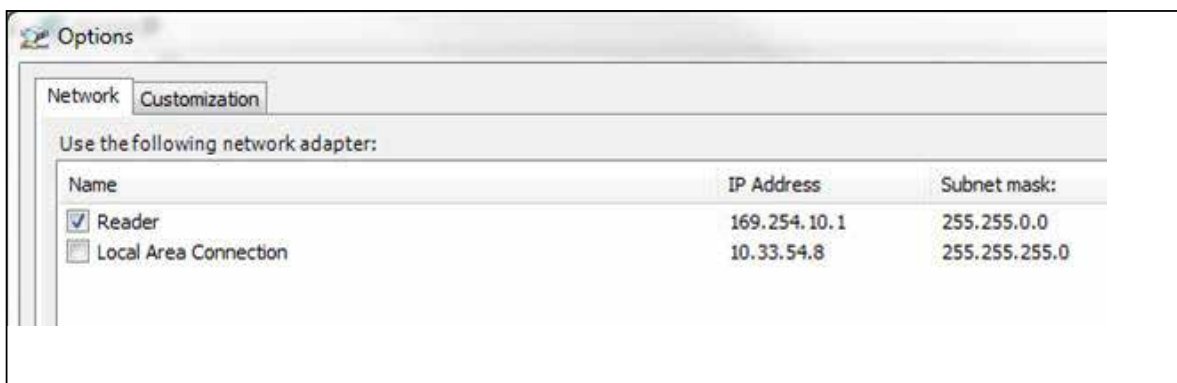

**Figure 17 Adapter Options**

For the direct-connect to the computer's Ethernet port option, choose the network adapter with the 169.254.10.1 address.

To connect to the corporate network, choose the Local Area Connection.

4. The next screen prompts for an update (Figure 18). Select **NO**.

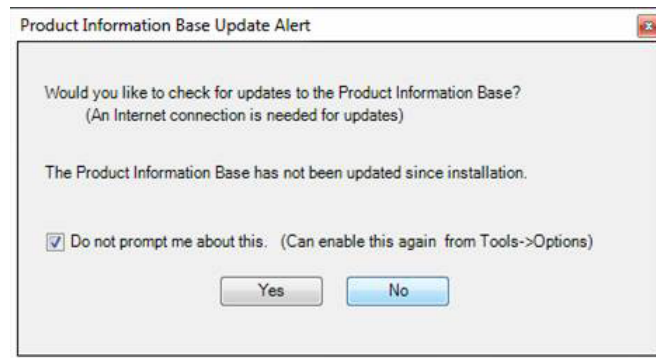

Figure 18 Check for Updates Screen

## Finding the IP Address of the Reader

**Note:** If a firewall is present it will need to be disabled to allow access (Figure 19).



Figure 19 Disable Firewall

1. From the Lantronix DeviceInstaller, right-click on the appropriate connection and select refresh (Figure 20).

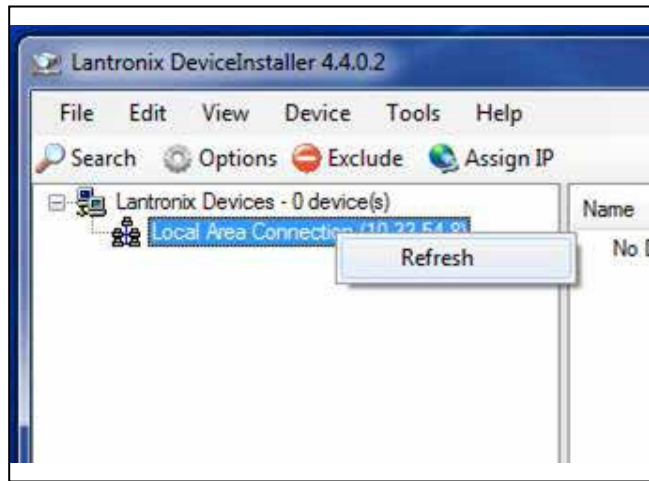

Figure 20 LanTronix DeviceInstaller Screen

2. The Xport Direct+ device will populate on the right side of the window (Figure 21). Use the IP address to configure your terminal emulator connection. Use Telnet and Port 10001.
3. The opened connection works just like a serial connection.

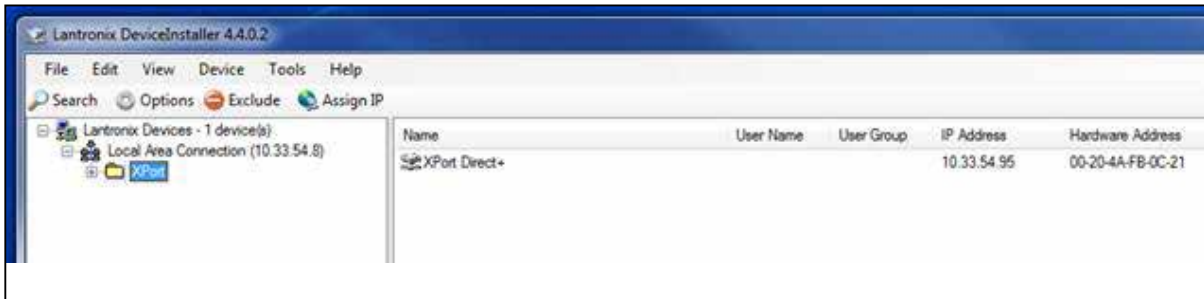

Figure 21 Xport Direct+ Device Screen

# Chapter 3 General Software Information

## Command Entry Conventions

All MPRX-FH commands are preceded by the start-of-message character (#). The end-of-message sequence expected from the host is a carriage return (CR). The MPRX-FH terminates messages with a return and a line-feed (CR/LF). For example, the command **#01** Switch To Command Mode is typed as follows:

```
#01<ENTER>
```

where

<ENTER> is the Enter or Return key.

Some command characters may be represented by the letter N. This letter indicates you are to supply a value. Maximum valid entries are the numbers 0 through 9 and the uppercase letters A through F. These letters allow for as many as 16 available user responses and are based on the hexadecimal numbering system.

Commands have at least two characters following the # character. [Table 10](#) shows the basic structure of a four-character command.

**Table 10 Four-Character Command Structure**

#1005 Set Baud Rate To 9600 Baud	
#	All commands are preceded by the # character.
1	Indicates the command group. This command is in Group 1 – Communications Port Control.
0	Indicates the command subgroup. In this example, all commands with a second digit of 0 apply to the main port.
0	The command digit. In this example, the 0 indicates that this command affects the baud rate.
5	Indicates the setting. Normally this is a variable and is usually a hexadecimal value from 0 through F. In this example, 5 sets the baud rate to 9600, the factory setting. In some commands, this digit may be a four-place hexadecimal string or a character string.

## Command Response Conventions

Like the MPRX-FH commands, responses are preceded by the # character. Many MPRX-FH commands respond with **#Done** or **#Error** indicating the command was or was not recognized and completed. Other commands respond with a four-character identifier followed by one or more values.

**Table 11** shows an example of a command/reply sequence. This example assumes that an MPRX-FH with serial number SN97001P running version X.XX software is connected to a PC running a terminal emulation software package. The command sequence verifies that communications are working correctly.

**Table 11 Sample Command Sequence**

Entry	MPRX-FH Response	Notes
#01 <CR>	#Done <CR/LF>	Switches MPRX-FH to command mode
#505 <CR>	#Model E4 Series Ver X.XX SN97001P <CR/LF>	Reports the software version and serial number
#00 <CR>	#Done <CR/LF>	Returns MPRX-FH to data mode

In command discussions, MPRX-FH response characters may be shown in brackets <>. The use of brackets indicates that the response is a value in the range of characters. The brackets are not part of the response. For example, the response to command **#520 Display Power Fail Bit** is either a 0 or a 1. In the command discussion, the response is shown as:

#PWRB <0-1>

with actual MPRX-FH response being one of the following:

#PWRB 0

#PWRB 1

In this example, PWRB is the four-character identifier for *power fail bit*, and the 0 or 1 is the *value*. All spaces shown in the response are actual spaces sent from the MPRX-FH. In this example, one space is between the letter B and the number.

## Operating Parameters

The MPRX-FH maintains its operating parameters in nonvolatile memory (NVRAM) so that the parameters are preserved after a power-down sequence.

## Power Fail

The system maintains a power fail flag. The host transmits command **#520 Display Power Fail Bit** to determine if a power down has occurred. This flag is cleared by both command **#63 Reset Reader** and command **#65 Reset Power Fail Bit**.

## Program Download

Program Download stores the MPRX-FH application software into the reader's flash memory. It is used to install program upgrades, add features, and to recover from corrupted program data.

**Note:** *Program Download is a custom TransCore utility host process.*



## Download Considerations

You should consider the following factors when performing Program Download:

- The MPRX-FH does not process tags while in download mode.
- The MPRX-FH does not accept any program data unless a successful erase of flash memory has been performed before transmitting the data. Erasing the flash memory typically takes two seconds.
- Cycling reader power after exiting from download mode re-executes startup. If the new software has been loaded without errors, the MPRX-FH comes up in data mode. If a flash checksum error is detected, the MPRX-FH reenters download mode and transmits a sign-on message with a boot version of 0.00x and without a serial number.

**Note:** The MPRX-FH uses default boot communications parameters when operating in download mode – 38400 baud, 8 data bits, 1 stop bit, no parity, basic protocol – and does not echo commands.

## Download Procedures

If TransCore releases a new version of the MPRX-FH software or if the MPRX-FH does not appear to be working properly, you may need to download the software to the MPRX-FH. Contact technical support or your TransCore sales representative.

## Startup

---

Upon startup, MPRX-FH transmits a sign-on message or a boot ROM failure message.

### Sign-On Message

If startup is successful, the sign-on message appears as follows:

```
Model E4 Series [software version] SNSSSSSS
[Copyright notice]
```

where

**SSSSSS** is the serial number assigned to the MPRX-FH unit being used.

Serial number **000000** is the default setting and is not a valid number. If this number appears in the sign-on message, the serial number has never been stored into reader memory. The serial number must be assigned by factory-authorized personnel using command **#695S...S Set Serial Number**. Because only six digits are allowed in the software, when setting the serial number skip the fourth (middle) digit of the seven-digit number shown on the reader label.

If the flash memory checksum does not indicate verification, the sign-on message appears as follows at a baud rate fixed at 38,400 bps:

```
Model [E4] Ver 0.00x
[Copyright notice]
```

## Boot Failure Message

Upon powering up, the software performs a checksum verification on itself. The function returns a specific value for the particular version of software. If the value returned is not correct, the boot code assumes that the application code has been corrupted and a failure condition exists. If the failure message does not transmit, a communications error has occurred or the boot has failed to the extent that it cannot transmit the failure message.

If the failure message version number equals 0.00 and no serial number exists, the flash memory checksum has failed, and the MPRX-FH is operating out of boot ROM. In this case, the MPRX-FH automatically enters download mode and waits for a new program to be loaded into the flash memory. Contact TransCore Technical Support for assistance.

## Tag/Message Buffer

---

The MPRX-FH maintains a tag buffer in battery backed RAM to save tag IDs acquired when data inquiry protocol is used. This buffer holds up to 500 time-stamped messages.

**Note:** *When the buffer fills, subsequent tag IDs will be lost.*

# Chapter 4 Communications Protocols

## Introduction

---

The MPRX-FH supports the following communications protocols:

- Basic
- Error correcting
- Data inquiry

The following protocol information provides reference information relevant to developing host software.

Communications are performed using the 7-bit ASCII code with optional parity, providing easy setup, testing, and diagnostics with standard ASCII terminals and serial printers.

Each message is framed within the start-of-message **<som>** and end-of-message **<eom>** characters so that the host device can detect the beginning and end of each message. This convention is most important under marginal communications conditions during which the host may receive extraneous noise-induced characters between reader transmissions. In such instances, the host is capable of ignoring any messages that do not conform to the **<som>...<eom>** frame sequence.

Both data mode and command mode require a two-way message interchange when using error correcting protocol (ECP). This interchange is completed by the message recipient returning a message acknowledgment to the message sender.

With ECP, all transmissions require a message. If a message is not received, the sender will time out with the same effect as if it had received a negative acknowledgment (from the host) or an **#Error** message from the MPRX-FH.

Software (XON/XOFF) flow control is optionally supported. Be careful in the use of XON/XOFF since noise-induced characters may be interpreted by the MPRX-FH as the XOFF character, which would suspend reader output without information reaching the host device. For more information, refer to [“Reader Transmissions” on page 4–45](#).

**Note:** *TransCore recommends that XON/XOFF flow control be disabled while using ECP.*

## Basic Protocol

---

With basic protocol, messages sent to and from the MPRX-FH and the host are transmitted without error checking. For each host transmission, the MPRX-FH returns a **#Done** or **#Error** message to the host.

When the host device is physically close to the MPRX-FH and no sources of interference exist, the basic protocol provides reliable communications.

The host must be ready to receive reader-transmitted messages because in basic protocol the MPRX-FH does not wait for the host to acknowledge a message before transmitting the next message. If necessary, the host may halt reader transmissions by using software flow control. Refer to “[Chapter 6 Configuration](#)” on [page 6–84](#) for software flow control information.

## Error Correcting Protocol

---

When the quality of data communications is imperative or may be suspect, you can utilize ECP to ensure the integrity of data transmitted between the MPRX-FH and the host.

**Note:** *TransCore recommends that basic protocol (not ECP) be used when commands are entered manually at the keyboard.*

Error correction is accomplished with the use of a cyclic redundancy check (CRC) value that is based on the message data. The originator (reader or host) calculates the CRC value of a message and includes it in the transmitted message.

The recipient (reader or host) also calculates a CRC value for the received message. If the transmitted message data is correct, the CRC value calculated by the recipient will agree with the CRC value calculated by the originator. If the CRC values do not agree, the recipient rejects the message.

Message sequence numbers are also included when using ECP. These sequence numbers are checked to determine if the message received has the correct sequence number; if not, the recipient rejects the message.

Because the seven-bit ASCII code is used and there are eight data bits per character, the eighth bit can optionally be used to support parity. Where parity is selected, the CRC value calculation includes the parity of each character in the calculation of the CRC value.

Parity is required to achieve the most reliable communications. If parity is enabled, both the MPRX-FH and the host must issue a message if any received character has a parity error. However, the message must not be transmitted before receipt of the **<eom>** character. If the message is transmitted prematurely, the MPRX-FH will issue an **#Error** message, and the host device will issue a negative acknowledgment message.

## Data Inquiry Protocol

---

Data inquiry protocol is a basic protocol option that allows the host to control transmission of reader tag data. The selection of data inquiry protocol affects data mode operation. As MPRX-FH acquires tags, it buffers them but does not transmit them. Instead, the host must poll MPRX-FH for each tag by sending a CTRL-E character (hex 5 digit). MPRX-FH transmits one message (tag ID or report data) for each CTRL-E it receives until the buffer is empty.

Each tag request message sent by the host consists only of the CTRL-E character; no **<som>** or **<eom>** characters are sent. MPRX-FH data transmission (tag ID and report data) format is the same as for basic protocol.

Selection of data inquiry protocol does not affect command mode operation.

## Basic Protocol and ECP Format

---

**Note:** In the following text, the symbols **<and>** are used to represent required variable message data, and the symbols **[and]** are used to represent optional data. These symbols are not part of the message syntax.

### Reader Transmissions

The basic protocol format and the data inquiry protocol format are as follows:

**<som><data><eom>**

The ECP format is as follows:

**<som><seq><data><crc><eom>**

where

- |                     |  |
|---------------------|--|
| <b>&lt;som&gt;</b>  | Start-of-message (ASCII # character)   |
| <b>&lt;seq&gt;</b>  | Sequence number (ASCII hex) that represents an even number in the range 0–9, A–F (0, 2, 4, 6, 8, A, C, E). The MPRX-FH maintains the number. The host must acknowledge reader transmissions by sending an <b>ACK</b> message with the same sequence number received from the MPRX-FH. The MPRX-FH updates its sequence number upon receipt of a valid host <b>ACK</b> . If an <b>ACK</b> is not received, the MPRX-FH retransmits the message. A reader transmission sequence is not considered complete until the MPRX-FH receives an <b>ACK</b> and updates its sequence number. |
| <b>&lt;data&gt;</b> | ASCII string up to 72 characters long. This string may contain tag data; a presence without tag report; an input status change report; an <b>#Error06</b> , <b>#Error07</b> , <b>#Error08</b> , or <b>#Error11</b> message; or a sign-on message. Auxiliary data may also be included.   |
| <b>&lt;crc&gt;</b>  | Field containing four ASCII digits that represent the 16-bit CRC value calculated on the message. The CRC value is calculated on bytes between the <b>&lt;som&gt;</b> character and the first <b>&lt;crc&gt;</b> byte.   |

When the host receives a properly framed message, it can calculate a 16-bit CRC value. The calculation is applied to the character string that immediately follows the **<som>** and that ends with the character immediately preceding the first **<crc>** character.

Transmitted CRC value can then be compared with the binary equivalent of the received **<crc>** characters. If the transmitted and received CRC values do not match, the recipient assumes the message was received in error, and transmits a **NAK** message response.

**<eom>**

End-of-message characters (ASCII CR and LF). The system includes both a carriage return (CR) and line feed (LF) to facilitate the use of terminals and printers.

If the host receives a **<som>** character in the middle of a data message, the message in progress is aborted. The assumption is that an **<eom>** was lost and the MPRX-FH is in the process of retransmitting the previous message.

## ECP Host ACK/NAK Response

With ECP, the host device responds to all data message transmissions from the MPRX-FH using the following acknowledgment or negative acknowledgment response format.

**<som><seq><ack/nak><crc><eom>**

where

**<som>**

Start-of-message (ASCII # character)

**<seq>**

Echo of the sequence number received from the MPRX-FH. The sequence number should correspond to the data message that is being positively or negatively acknowledged by the host. If the MPRX-FH receives an **ACK** message with the incorrect sequence number, the data message is retransmitted.

The host device resets the anticipated data message sequence number to that of the MPRX-FH before communications can resume without error.

**<ack/nak>**

ASCII @ character for **ACK** response; ASCII ? character for **NAK** response

**<crc>**

CRC value for the message

**<eom>**

End-of-message character (ASCII CR)

The MPRX-FH sets a user-programmable timeout delay at the time each message is transmitted based on command **#612NN** Set Error Correcting Protocol Timeout, where NN = timeout delay. To disable the timeout delay for diagnostic purposes, issue the command **#612FF** Disable Error Correcting Protocol Timeout.

If the timeout delay expires before the MPRX-FH receives an **ACK** or **NAK** message from the host, a logical **NAK** condition will be declared. If the MPRX-FH receives a **NAK** or timeout, the reader retransmits the data message.

When the MPRX-FH receives an **ACK** message, the system software treats the message as having been properly received by the host. The software increments the sequence number, and advances pointers to the next message in the MPRX-FH's message queue to prepare for sending the next message.

## Switch to Command Mode Request

The host device may issue command **#01 Switch to Command Mode** while in data mode.

The basic protocol format is as follows:

```
<som><cmd><eom>
```

The ECP format is as follows:

```
<som><seq><cmd><crc><eom>
```

where

<b>&lt;som&gt;</b>	Start-of-message (ASCII # character)
<b>&lt;seq&gt;</b>	Sequence number generated by the host device separately from that appearing in data messages transmitted by the MPRX-FH
<b>&lt;cmd&gt;</b>	Switch to command mode (ASCII characters 01)
<b>&lt;crc&gt;</b>	CRC value for the message
<b>&lt;eom&gt;</b>	End-of-message character (ASCII CR)

## Host Transmission

The host device initiates synchronous communications between the MPRX-FH and the host. The host begins a sequence by issuing a command; the MPRX-FH responds accordingly.

The data inquiry protocol format is as follows:

```
<CTRL-E>
```

The basic protocol format is as follows:

```
<som><cmd>[<data>]<eom>
```

The ECP format is as follows:

```
<som><seq><cmd>[<data>]<crc><eom>
```

where

<b>&lt;CTRL-E&gt;</b>	ASCII Control E (hex 5 digit). When in data inquiry mode, each transmission of a <b>&lt;CTRL-E&gt;</b> by the host causes the MPRX-FH to transmit one tag ID.
<b>&lt;som&gt;</b>	Start-of-message (ASCII # character)
<b>&lt;seq&gt;</b>	Sequence number (ASCII hex digit) that represents an odd number in the range 0–9, A–F (1, 3, 5, 7, 9, B, D, F). The host should use odd sequence numbers in its command since the MPRX-FH uses even sequence numbers in its transmissions. This method eliminates the possibility of a synchronous host command and an asynchronous reader transmission having the same sequence number.

Upon receiving a host command in ECP, the MPRX-FH replies using the command's sequence number in its response. Therefore, the host device updates its sequence number upon receipt of a valid reader response. If the sequence number is not updated before transmission of the next command, the MPRX-FH will not service the new command; it will retransmit its previous message. A command/message sequence is not complete until the host updates its sequence number.

<b>&lt;cmd&gt;</b>	Command code, a string that contains from two to four ASCII hex characters
<b>[ &lt;data&gt; ]</b>	Optional data field, an ASCII string of as many as 20 characters in length. For example, the store hardware configuration string command is <b>#696S...S</b> or command <b>#696</b> Store Hardware Configuration String followed by the data string <b>S...S</b> .
<b>&lt;crc&gt;</b>	CRC value for the message
<b>&lt;eom&gt;</b>	End-of-message character (ASCII CR)

## Reader Command Response

The basic protocol format is

```
<som><resp><eom>
```

The ECP format is

```
<som><seq><resp><crc><eom>
```

where

<b>&lt;som&gt;</b>	Start-of-message (ASCII # character)
<b>&lt;seq&gt;</b>	Echo of sequence number received in host command message
<b>&lt;resp&gt;</b>	Response string. The MPRX-FH returns <b>#Done</b> , <b>#Error</b> , or another ASCII string depending on the host transmission. This string can be up to 72 characters long.
<b>&lt;crc&gt;</b>	CRC value for the message
<b>&lt;eom&gt;</b>	End-of-message character (ASCII CR and LF)

## Sample Messages

This section contains examples of typical messages transmitted between the MPRX-FH and the host device.

### Reader Transmissions

Basic protocol reader transmission

```
#KING 1302<eom>
```

Host response

```
No host response for non-ECP
```

ECP reader transmission

```
#4KING 1302 <crc><eom>
```



where

<b>#</b>	Start-of-message character
<b>4</b>	Message sequence number
<b>KING 1302</b>	Message data: Tag ID is shown.
	Other sample message data could be as follows:
	<b>IOST C0 02 IO D24</b> (display I/O status) <b>#Error06</b> (frequency not set)
<b>&lt;crc&gt;</b>	CRC value for the message
<b>&lt;eom&gt;</b>	End-of-message character

Host response

**#4@<crc><eom>**

where

<b>#</b>	Start-of-message character
<b>4</b>	Message sequence number
<b>@</b>	<b>ACK</b> (acknowledgment character)
<b>?</b>	<b>NAK</b> (negative acknowledgment character)
<b>&lt;crc&gt;</b>	CRC value for the message
<b>&lt;eom&gt;</b>	End-of-message character

## Host Command Transmissions

ECP host transmission

**#7NNNXXX<crc><eom>**

where

<b>#</b>	Start-of-message character
<b>7</b>	Message sequence number
<b>NNNXXX</b>	Select RF Operating Frequency command where <b>NNN</b> is the command and <b>XXX</b> is a hexadecimal value from 000 to 118.
<b>&lt;crc&gt;</b>	CRC value for the message
<b>&lt;eom&gt;</b>	End-of-message character
<b>#Done</b>	Command has been invoked by the MPRX-FH

Reader response

**#7Done<crc><eom> or #7Error<eom>**

For some commands, the MPRX-FH responds with data that relates to the command, such as **T0F 0**, to indicate the mode enabled for a **#570** Display Operating Mode Status command.

**#7Error<eom>** will be returned if host transmission is not a legal command with legal data.

## Timing and Synchronization

The ECP is largely independent of baud rate. The timeout delays previously described are a function of baud rate.

The MPRX-FH supports an ECP timeout, which applies equally to both transmit and receive.

The receiver's minimum timeout delay equals the time to transmit/receive the longest anticipated message at the current baud rate setting. Additional margin should be included for idle periods between characters; for example, processing overhead, if any. The timeout delay period can be expressed as follows:

$$T_{pec} \text{ (ms)} = L \times [T_{char} + T_{idle}]$$

where

$T_{char}$ (ms)	$1000 \times [B_c / R_b]$
$B_c$	Bits per character, typically 10
$R_b$	Baud rate, 1200–38.4 K
$L$	Length of message in characters
$T_{idle}$	Maximum idle period between characters (ms)

**Note:** The MPRX-FH supports baud rates between 1200 and 38.4 K.

Likewise, the sender must set a timeout delay equal to the delay of nine characters at the current baud rate setting. For example, the time required to shift out the **<eom>** character plus the time to shift in the **ACK** or **NAK** message to be received plus a processing allowance for the receiver to process the message and check for error conditions.

Thus, the sending timeout delay can be expressed as follows:

$$T_{send} \text{ (ms)} = 9 * T_{char} + T_{errchk}$$

where

$T_{errchk}$ (ms) Processing period to perform error checking by receiver

The host device can remotely set the MPRX-FH's communications parameters while in the command mode, but TransCore does not recommend this action if communications conditions are marginal.

After the MPRX-FH receives new communications parameters, the MPRX-FH issues the **#Done** message and switches to the new configuration immediately. The host device switches its communications parameters immediately after the transaction is complete.

As noted, the message initiator, such as the MPRX-FH in data mode and the host device in command mode, starts a timeout counter at the time a message is transmitted. If the timeout expires before receiving an acknowledgment message, a logical **NAK** condition is declared, and the initiator assumes the message was received in error. In this instance, the message is retransmitted until an acknowledgment message is received.

The message recipient, such as the host device in data mode and the MPRX-FH in command mode, starts a timeout counter when a **<som>** character is received. If the timeout expires without the receipt of an **<eom>**, the message acquisition is aborted (reset), and the receiver waits for the next **<som>** character.

If the message recipient receives a second **<som>** character before an **<eom>** character, the message acquisition is aborted (reset), and retransmission of the previous message is assumed to be underway. These strategies allow for recovery during periods when communications are marginal or lost completely.

## Reader-Addressed Failure Conditions

The MPRX-FH addresses the following failure conditions.

### Illegal Sequence Number (Not in the Range 0–9, A–F)

If the MPRX-FH detects an illegal sequence number in a host command message, it discards the received message and sends no response. If it receives an illegal sequence number in an **ACK** message, it responds as if a **NAK** had been received and retransmits the data.

### Wrong Sequence Number

If the MPRX-FH receives the wrong sequence number in an **ACK** message, it responds as if a **NAK** had been received, and it retransmits the data.

### Incorrect CRC

If the MPRX-FH detects an incorrect CRC value in a host command message, it discards the received message. No response is sent. If it receives an incorrect CRC value in an **ACK** message, it responds as if a **NAK** had been received, and it retransmits the data.

### Illegal Command

If the MPRX-FH receives an illegal command, it returns its standard **#Error** message.

### Transmission Timeout

If the MPRX-FH transmits an asynchronous message and the host does not send an **ACK** before the ECP timeout occurs, the MPRX-FH retransmits the message.

### Receive Timeout

If the MPRX-FH receives a **<som>** but does not receive a matching **<eom>** before the ECP timeout occurs, it discards the incomplete message and resets its receiver.

### Asynchronous Message/Command Message Collision

If the MPRX-FH transmits asynchronous data at the same time that the host sends a command, the MPRX-FH gives priority to receiving the command. It processes the command and sends a message before it retransmits the asynchronous data.

## Host-Addressed Failure Conditions

The host device addresses the following failure conditions.

### Illegal or Wrong Sequence Number

If the host detects an illegal or wrong sequence number in a reader response, it retransmits the command with the same sequence number. If the host detects an illegal sequence number in an asynchronous reader transmission, it sends a **NAK** message.

## Incorrect CRC

If the host detects an incorrect CRC value in a reader message, it retransmits the command with the same sequence number. If the host detects an incorrect CRC value in an asynchronous reader transmission, it transmits a **NAK** message.

## Transmission Timeout

If the MPRX-FH does not respond to a host command within a specified interval, the host software retransmits the command with the same sequence number.

## Receive Timeout

If the host receives a **<som>** but does not receive a matching **<eom>** within a specified timeout interval, it discards the incomplete message and resets its receiver.

## Asynchronous Message/Command Message Collision

If the host receives an asynchronous reader transmission at the same time it transmits a command, it ignores the asynchronous message and waits for the MPRX-FH's response. The MPRX-FH retransmits asynchronous data after it transmits the command message.

# ECP Reliability

---

An undetected error is defined as a message having incorrect data or status but no parity or CRC errors. An error transaction is defined as a message having either a parity or CRC error. Laboratory testing indicates an undetected error rate of less than one undetected error per 1,000,000 error transactions with parity enabled.

To ensure this error rate is not exceeded, the host must enable parity and adhere closely to the timing specifications discussed previously in [“Timing and Synchronization” on page 4–50](#).

## CRC Calculation

The CRC used by the ECP is based on a 16-bit algorithm. The algorithm, as implemented, operates on eight-bit characters, for example, a seven-bit ASCII character plus one optional parity bit. The 16-bit result is converted to four ASCII hex characters and is appended to messages transmitted by the MPRX-FH.

The MPRX-FH accepts four ASCII **< \ >** characters (60 hex) as a wild card CRC value in lieu of a valid four-character CRC value to facilitate testing and diagnostic checkout.

The MPRX-FH implements the algorithm with a 512-byte lookup table to reduce the processing overhead requirements.

To simplify the implementation of the CRC algorithm by host software developers, several examples of the calculation are provided in C source code on the following pages. The calculation may be performed with or without a lookup table, depending on the trade-off between code memory and processing overhead.

Example 1 presents an example of a function (CALCCRC) that calculates the CRC value through a call to a separate function (UPDCRC).

```
unsigned short calccrc(char *message)
{
    unsigned short crc = 0;
    for ( ; *message != (char)0; message++) crc =
        updcrc(*message & 0xff, crc);
    return (crc)
}
```

Example 2 shows an example of UPDCRC that does not require a lookup table.

```
#define BITS_PER_CHAR    8
unsigned short updcrc (unsigned short ch, unsigned short crc)
{
    register short counter = BITS_PER_CHAR;
    register short temp    = crc;
    while (--counter >= 0) if
        (temp & 0x8000)    {
            temp <<= 1;
            temp += (((ch <<= 1) & 0x0100) != 0);
            temp ^= 0x1021;
        }
        else { temp
            <<= 1;
            temp += (((ch <<= 1) & 0x0100) != 0);
        }
    return(temp);
}
```

Example 3 contains an example of UPDCRC that does require a lookup table.

```
#define updcrc(cp, crc)( crctab[((crc >> 8) & 255)]^ (crc << 8) ^ cp static
unsigned short crctab [256] = {
0x0000,    0x1021,    0x2042,    0x3063,    0x4048,    0x50a5,    0x60c6,    0x70e7,
0x8108,    0x9129,    0xa14a,    0xb16b,    0xc18c,    0xd1ad,    0xe1ce,    0xf1ef,
0x1231,    0x0210,    0x3273,    0x2252,    0x52b5,    0x4294,    0x72f7,    0x62d6,
0x9339,    0x8318,    0xb37b,    0xa35a,    0xd3bd,    0xc39c,    0xf3ff,    0xe3de,
0x2462,    0x3443,    0x0420,    0x1401,    0x64e6,    0x74c7,    0x44a4,    0x5485,
0xa56a,    0xb54b,    0x8528,    0x9509,    0xe5ee,    0xf5cf,    0xc5ac,    0xd58d,
0x3653,    0x2672,    0x1611,    0x0630,    0x76d7,    0x66f6,    0x5695,    0x46b4,
0xb75b,    0xa77a,    0x9719,    0x8738,    0xf7df,    0xe7fe,    0xd79d,    0xc7bc,
0x48c4,    0x58e5,    0x6886,    0x78a7,    0x0840,    0x1861,    0x2802,    0x3823,
0xc9cc,    0xd9ed,    0xe98e,    0xf9af,    0x8948,    0x9969,    0xa90a,    0xb92b,
0x5af5,    0x4ad4,    0x7ab7,    0x6a96,    0x1a71,    0x0a50,    0x3a33,    0x2a12,
0xdbfd,    0xcdbc,    0xfbbf,    0xeb9e,    0x9b79,    0x8b58,    0xbb3b,    0xab1a,
0x6ca6,    0x7c87,    0x4ce4,    0x5cc5,    0x2c22,    0x3c03,    0x0c60,    0x1c41,
0xedaе,    0xfd8f,    0xcdec,    0xddcd,    0xad2a,    0xbd0b,    0x8d68,    0x9d49,
0x7e97,    0x6eb6,    0x5ed5,    0x4ef4,    0x3e13,    0x2e32,    0x1e51,    0x0e70,
0xff9f,    0xefbe,    0xdfdd,    0xcffc,    0xbf1b,    0xaf3a,    0x9f59,    0x8f78,
0x9188,    0x81a9,    0xb1ca,    0xa1eb,    0xd10c,    0xc12d,    0xf14e,    0xe16f,
0x1080,    0x00a1,    0x30c2,    0x20e3,    0x5004,    0x4025,    0x7046,    0x6067,
0x83b9,    0x9398,    0xa3fb,    0xb3da,    0xc33d,    0xd31c,    0xe37f,    0xf35e,

0x02b1,    0x1290,    0x22f3,    0x32d2,    0x4235,    0x5214,    0x6277,    0x7256,
0xb5ea,    0xa5cb,    0x95a8,    0x8589,    0xf56e,    0xe54f,    0xd52c,    0xc50d,
0x34e2,    0x24c3,    0x14a0,    0x0481,    0x7466,    0x6447,    0x5424,    0x4405,
0xa7db,    0xb7fa,    0x8799,    0x97b8,    0xe75f,    0xf77e,    0xc71d,    0xd73c,
0x26d3,    0x36f2,    0x0691,    0x16b0,    0x6657,    0x7676,    0x4615,    0x5634,
0xd94c,    0xc96d,    0xf90e,    0xe92f,    0x99c8,    0x89e9,    0xb98a,    0xa9ab,
0x5844,    0x4865,    0x7806,    0x6827,    0x18c0,    0x08e1,    0x3882,    0x28a3,
0xcb7d,    0xdb5c,    0xeb3f,    0xfb1e,    0x8bf9,    0x9bd8,    0xabbb,    0xbb9a,
0x4a75,    0x5a54,    0x6a37,    0x7a16,    0x0af1,    0x1ad0,    0x2ab3,    0x3a92,
0xfd2e,    0xed0f,    0xdd6c,    0xcd4d,    0xbdaa,    0xad8b,    0x9de8,    0x8dc9,
0x7c26,    0x6c07,    0x5c64,    0x4c45,    0x3ca2,    0x2c83,    0x1ce0,    0x0cc1,
0xef1f,    0xff3e,    0xcf5d,    0xdf7c,    0xaf9b,    0xbfba,    0x8fd9,    0x9ff8,
0x6e17,    0x7e36,    0x4e55,    0x5e74,    0x2e93,    0x3eb2,    0x0ed1,    0x1ef0,
};
```

Example 4 shows an example of a function that creates the lookup table.

```
#include <stdio.h>

#define MAX_CHAR          256
#define BITS_CHAR        8
#define SIGN_BIT         0x8000
#define POLY             0x1021
unsigned short crctab [MAX_CHAR]; main
()
    {
        unsigned short ch; unsigned
        short workval; unsigned
        short bit; unsigned short
        carry;
        for (ch = 0; ch != MAX_CHAR; ch++) {
            workval = ch << BITS_CHAR;
            for (bit = BITS_CHAR; bit != 0; bit--) {
                carry = (workval & SIGN_BIT);
                workval <<= 1; if
                (carry) workval ^=
                POLY;
            }
            crctab[ch] = workval;
        }
        for (ch = 0; ch != MAX_CHAR; ch++)
            printf("0x%04x\n", crctab[ch]);
    }
```

## Manually Disabling ECP for Maintenance

---

Under certain conditions, communications between the host and MPRX-FH may be lost temporarily and maintenance may be required. The reader or host is sending out a message and waiting for an acknowledgment. When the acknowledgment is not received, the message is sent again. Additional messages are also buffered. Often the first indication that the MPRX-FH software is in an ECP “loop” is when the user/technician sees a recurring display of the same message repeated on the monitor. The procedure described in the following paragraphs enables the maintenance technician to change configuration or test tag reading manually.

Assuming that the ECP timeout is at the factory default of 12.7 seconds (or other value that allows enough time for the commands to be manually entered) the following command sequence may be used to break out of an ECP loop. This command sequence uses four ASCII <`> characters (60 hex) as wild card CRC values.

**Note:** The ASCII <`> character (60 hex) is commonly located on the ~ key.

You must acknowledge existing messages by issuing commands with the generic format:

```
#x@' ' ' ' <eom>
```

where

#	Start-of-message character
x	Message sequence number. This must be the same as the sequence number of the message being acknowledged
@	<b>ACK</b> (acknowledgment character)
<' ' ' ' >	Wild card CRC value for the message
<eom>	End-of-message character

The following is a typical sequence after power-on limiting buffered messages.

**Note:** *Ensure that no tags are in the field when you are performing this troubleshooting procedure.*



### Caution

**To avoid damage to the MPRX-FH, ensure that you have connected the antenna or a dummy load to the reader before applying power to the reader.**

Reader transmission on power-up:

```
#0 Model ... SN <crc><eom>
```

Manually enter: #0@` `` ` ` <eom>

Reader response: #2 Copyright 2008 TransCore <crc><eom>

Manually enter: #2@` `` ` ` <eom>

Manually enter: #101' ' ' ' <eom> This puts reader into command mode

Reader response: #1Done<crc><eom>

Manually enter: #3610' ' ' ' <eom> This puts reader into basic protocol, disabling ECP

Reader response: #Done

Enter any other desired diagnostic or directive commands in basic protocol. After maintenance is complete enter the commands:

```
#00 return the reader to data mode
```

```
#611 return to error correcting protocol
```

```
#100` `` ` ` <eom> return reader to data mode
```



# Chapter 5 Commands

## Default Settings

---

The MPRX-FH is delivered from the factory with specified default settings that determine how the reader operates. Commands transmitted by the host device can change the default settings and control additional features. The commands can be transmitted by manually entering the commands at the host keyboard if the host is in terminal emulation mode. The MPRX-FH can also communicate with ASCII terminals.

## Operating Modes

---

The MPRX-FH has three modes of operation: Data, Command, and Download. The software for the MPRX-FH contains two separate programs — Boot and Application. The Boot program has control of the MPRX-FH on startup and when operating in download mode. The Application program has control of the MPRX-FH during data mode and command mode operation and holds the application code. Together, they control the MPRX-FH in the three modes of operation.

### Data Mode

The MPRX-FH is in the data mode upon power-up. While in the data mode, the MPRX-FH sends all communications, such as tag IDs and reports, as data messages to the host device. Reports provide information on input status changes (input 0 and input 1), a presence without tag report, and buffer overflow information. When MPRX-FH mode has been enabled (**#837**) and while the MPRX-FH is in data mode, the host device can send the following commands to the MPRX-FH:

- #01**                      changes the MPRX-FH from the data mode to the command mode.
- #440**                    provides a one-time reset of all tag uniqueness timers at which point the previously set timeout interval resumes.

**Note:** *The MPRX-FH transmits ID codes to the host device when the MPRX-FH is in data mode.*

### Command Mode

While the MPRX-FH is in the command mode, the host device sends commands to the MPRX-FH that can be used to control the reader operation and configuration. After the MPRX-FH receives a command, it transmits a command response message. Typically, the command message contains **#Error**, **#Done**, or data relating specifically to the command request. These messages may be of variable length since some commands require information as part of the message; for example, **#570 Display Operating Mode Status**.

Communication can be lost if the host device attempts to send certain commands under marginal communication conditions. For example, if the host device transmits the command request to change the baud rate and the MPRX-FH properly receives the request and transmits the **#Done** message, one of the two following conditions may occur:

1. If the host device receives the **#Done** message, then both the host and the MPRX-FH switch to the new baud rate, and communications are maintained.

**Note:** *In many applications, the host must be set to the new baud rate as it does not change automatically. The MPRX-FH changes the baud rate immediately after issuing the message.*

2. If the host does not receive the **#Done** message transmitted by the MPRX-FH, the host assumes that the command was not properly sent and does not switch to the new baud rate, causing a loss of communications.



### Caution

***The host device should only change communications parameters or protocols during test or set up conditions.***

## Download Mode

In download mode, the host can download new software to the MPRX-FH.

While in download mode, the MPRX-FH turns RF off, does not process tags, and does not echo host commands.

Typically, TransCore trained personnel download new application code using a custom firmware loader program. Contact TransCore Technical Support for information about firmware updates and procedures.

## Command List

---

Reader commands are divided into groups based on a primary function. The following sections provide information about each command in command number order. Refer to [“Command Quick Reference” on page D–112](#) for listings of commands in numerical and alphabetical order.

In the following text, the symbols **<and>** represent variable message data. These symbols are not part of the message syntax.

Hex digits (0–9, A–F) in either uppercase or lowercase characters may be used in data strings and for hex digits A–F.

## Reader Mode Control — Command Group 0

Group 0 commands control reader mode. The mode determines whether the reader is transmitting data to or receiving data from a host device or terminal.

### 00 Switch to Data Mode (Factory Default)

**#00** switches the reader to data mode, which allows the reader to transmit tag data (ID codes) to the host. In addition to switching the reader to data mode, Command **#00** automatically saves to non-volatile memory (NVRAM) any user parameters that had been changed during the command mode session. The reader enters data mode on power up.

**Caution**

**To save user parameter changes to non-volatile memory (NVRAM), you must send Command #00 before powering down the reader.**

When MPRX-FH mode has been enabled (#837) and while the MPRX-FH is in data mode, the host device can send the following commands to the MPRX-FH:

#01                    Switch to Command Mode

Reader response: #Done

#440                  Reset Uniqueness

Reader response: #Done

**Note:** The MPRX-FH transmits ID codes to the host device when the MPRX-FH is in data mode.

## 01 Switch to Command Mode

#01                    switches the reader to command mode, which allows the reader to accept commands from a host or terminal. While in command mode, the reader turns RF off and does not acquire tags.

Reader response: #Done

## Communications port Control — Command Group 1

Group 1 commands configure the parameters used by the MPRX-FH to communicate with a host device or terminal. These commands set baud rate, stop bits, parity, and end-of-line delay.

### 100N Select Baud Rate

#100N                selects the reader baud rate. The factory-default setting is 9600 baud. The N variable specifies the baud rate shown in [Table 12](#).

**Table 12 Select Baud Rate Commands**

Command	Baud Rate Selected
1002	1200
1003	2400
1004	4800
<b>1005</b>	<b>9600 (factory default)</b>
1006	19.2 K
1007	38.4 K

Reader response: #Done

**Caution**

**If ECP is enabled, ensure that the ECP timeout is sufficient for the new baud rate.**

## 101N Select Stop Bits

**#101N** selects the number of stop bits for reader character transmission. The factory default setting is 1 stop bit. The N variable specifies the number of stop bits as indicated in [Table 13](#).

**Table 13 Select Stop Bits Commands**

Command	Stop Bits Selected
<b>1010</b>	<b>1 (factory default)</b>
1011	2

Reader response: **#Done**

## 102N Select Parity

**#102N** selects the reader parity setting. The factory-default setting is parity disabled. The N variable specifies parity as shown in [Table 14](#).

**Table 14 Select Parity Commands**

Command	Data Bits	Parity Selected
<b>1020</b>	<b>8</b>	<b>Disable parity (factory default)</b>
1021	7	Select even parity
1022	7	Select odd parity

Reader response: **#Done**

## Command Group 2

Group 2 commands control the real-time clock which maintains the MPRX-FH internal time and date. This time and date can be appended to IDs, error messages, and sensor input reports. An internal battery supports the clock, so time and date are preserved if main power is lost.

### 20 Set Time

**#20** sets the time. Enter the time in the proper format: two-digit decimal entries with no spaces between characters and using colons as delimiters.

The entry format is as follows:

**20HH:MM:SS or 20HH:MM:SS:hh**

where

**HH** represents hours (00 to 23).  
**MM** represents minutes (00 to 59).  
**SS** represents seconds (00 to 59).  
**hh** represents hundredths of a second (00 to 99).  
**:** is the time delimiter.

If hundredths of a second is not specified, the reader sets the hundredths register to 00.

Reader response: **#Done**

## 21 Set Date

**#21** sets the date. Enter the date in the proper format: two-digit decimal entries with no spaces between characters and using forward slashes “/” as delimiters. The entry format is as follows:

**21MM/DD/YY**

where

**MM** represents the month (01 to 12).

**DD** represents the day (01 to 31).

**YY** represents the last two digits of the year (00 to 99).

/ is the date delimiter.

Reader response: **#Done**

## 22 Display Time and Date

**#22** displays the reader’s current time and date. One space separates the time and the date output.

Reader response: **HH:MM:SS.hh MM/DD/YY**

where

**HH** represents hours

**MM** represents minutes

**SS** represents seconds

**hh** represents hundredths of seconds

:

**MM** represents the month

**DD** represents the day

**YY** represents the last two digits of the year

/ is the date delimiter

## Append Information — Command Group 3

Group 3 commands append useful information to reader transmissions, such as IDs, error messages, and sensor input reports. Auxiliary information such as reader number, antenna number (or manual entry code), number of times the previous tag was read, and sensor input status can be appended to the ID using the Group 3 commands.

### 30N Append Time and Date Selection

**#30N** selects the option of appending the time and date to transmitted IDs, error messages, presence without tag reports, and input status change reports. The factory default setting is time and date appended (Command **#302**).

The reader returns an #Error message if its tag buffer contains data. The reset reader Command #63 may be transmitted to clear the buffer; however, tag ID data will not be reported. If this is unacceptable, allow the buffer to empty before reissuing append time and date Command #30N Append Time and Date commands are shown in [Table 15](#).

**Table 15 Append Time and Date Commands**

Command	Append Option
300	No time and date appended
<b>302</b>	<b>Time and date appended (factory default)</b>

The reader transmits messages with time and date appended as follows. One space separates the time from the date.

`<string>&<HH:MM:SS.hh MM/DD/YY>`

where

**string** is a tag ID, error message, or report.

**&** separates `<string>` from the time and date.

**HH:MM:SS** is the time delimiter.

**MM/DD/YY** is the date delimiter.

Reader response: #Done

### 31N Append Auxiliary Information Selection

**#31N** selects the option of appending auxiliary information to transmitted IDs, presence-without-tag reports, and input status change reports. Auxiliary information is not appended to error messages. The factory-default setting is no auxiliary information appended. The N variable specifies whether or not auxiliary information is to be appended. Append Auxiliary Information commands are shown in [Table 16](#).

**Table 16 Append Auxiliary Information Commands**

Command	Append Option
<b>310</b>	<b>No auxiliary information appended (factory default)</b>
311	Auxiliary information appended

The reader transmits messages with auxiliary information appended as:

`<message data>%<xx-y-zz-q-sss>`

where

**%** separates the auxiliary information and signals the host computer that auxiliary information is appended.

**xx** reader ID. Value can be set with Command #60NN.

**-** auxiliary information delimiter

**y** antenna number.

**zz** number of reads (00 to FF hexadecimal) of the previous tag on this antenna  
**q** current status of input0 and input1 (0 to 3)  
**sss** relative to tag read strength

Reader response: **#Done**

### 322 Disable TID data append

**#322** Append\_EPC\_TID

If ISO/IEC 18000-63 is enabled, this command will append TID to the end of the response. Refer to [“839 Enable ISO/IEC 18000-63 Protocol”](#) on page 5–81

Reader Response: 0/1

### 323 Disable TID data append

**#323** Append\_EPC\_TID

If ISO/IEC 18000-63 is enabled, this command will append TID to the end of the response. Refer to [“839 Enable ISO/IEC 18000-63 Protocol”](#) on page 5–81.

Reader Response: 0/1

## ID Filtering — Command Group 4

Group 4 commands set criteria for filtering (buffering or discarding) ID codes. These commands are useful for eliminating duplicate ID codes and selecting the type of tags read by the MPRX-FH.

### 40 Transmit All ID Codes

**#40** instructs the reader to transmit all IDs without regard for uniqueness. This command can be useful when tuning the read zone and mapping the footprint or performing diagnostics.

After diagnostics are complete, you may want to reinstate the uniqueness check using Command **#410N Select Unique ID Code Criteria**.

Reader response: **#Done**

### 410N Select Unique ID Code Criteria (Anti-passback Feature)

**#410N** instructs the reader to buffer and transmit ID codes according to the following test: an ID is read if previously decoded IDs have changed value at least **N+1** times since the new ID was last received. IDs that do not pass the test are not reported. The factory-default setting is Command **#4100**, which selects a separation of one ID. Variable **N** specifies ID separation as shown in [Table 17](#).

Table 17 Unique ID Code Criteria

Command	Uniqueness Criteria
<b>4100</b>	<b>Separation of 1 ID (factory default)</b>
4101	Separation of 2 IDs
4102	Separation of 3 IDs
4103	Separation of 4 IDs

Each time the reader receives a tag ID, it compares the ID with the contents of a comparison register. This register contains the following two items:

- Item 1 Most recently acquired ID
- Item 2 Second-most recently acquired ID
- Item 3 Third-most recently acquired ID
- Item 4 Fourth-most recently acquired ID

When the uniqueness filter is set to separation of one ID, the newly acquired ID is transmitted only if it is different from the first item. Separation of two IDs allows transmission if the new ID is different from Items 1 and 2 in the comparison register. Separation of three and four IDs transmit the new ID only if it is different from the first three and the first four items, respectively.

**Note:** A new ID can fail the filter test and not be transmitted; however, it remains stored in the comparison register.

The uniqueness test has a time limit as set by Command **#44N**. If an ID is buffered, it will not be accepted again unless it arrives at the reader more than the timeout value from the previous arrival or until the receipt of one or more other IDs reset the uniqueness.

Reader response: **#Done**

## 420N Select Valid ID Code Criteria

**#420N** directs the reader to validate an ID received only after it has been obtained a specified number of times in sequence. Values for N are 1 through 4 (Table 18). The factory setting is one acquisition (N = 0).

Table 18 Select Valid Code Commands and Frames

Command	Valid Code Frames
<b>4200</b>	<b>1 (factory default)</b>
4201	2
4202	3
4203	4

The validation procedure is executed before the unique ID test (Select Unique ID Code Criteria [**#410N**] Commands). IDs that do not pass the validation test are not reported.



For example, Command **#4203** specifies that the same ID must be obtained from the antenna/RF module 4 times in succession before it is considered for the uniqueness test. This feature is useful in installations where RF reflections may cause a single tag to be read multiple times or where an occasional ID might be read from fringe areas.

## 440 Reset Uniqueness

**#440** causes the ID filtering process set by Select Unique ID Code Criteria (**#410N**) to restart. It is used in conjunction with the Set Uniqueness Timeout (**#44N**) Commands. This command provides a one-time reset at which point the previously set timeout interval resumes. This command can be sent in data or command mode.

## 44N Set Uniqueness Timeout

Places a time limit on the uniqueness criterion set by Select Unique ID Code Criteria (**#410N**). The parameter **N** sets the number of minutes on the timeout clock. The factory setting is two minutes (**N = 1**).

Command	Timeout Clock
<b>#441</b>	<b>2 minutes (factory setting)</b>
<b>#442</b>	15 seconds
<b>#443</b>	30 seconds

Entering these commands effectively expires the timeout clock, which erases all current IDs in the comparison register. In effect, the first ID that is acquired after the clock expires always appears to be new and is stored. Newly acquired IDs are only tested against IDs that are registered after the clock resets.

The timeout clock is continually reset (does not expire) as long as the reader receives the same tag ID. For example, assume that the timeout clock is set for two minutes and there is a railcar parked on a siding in front of the reader. Without this reset feature, the railcar's ID would be reported every two minutes (each time the timeout clock expired).

## 454 Disable Multi-tag Sort (Factory Default)

**#454** Disables the multi-tag sort function.

Reader response: **#Done**

## 455 Enable Multi-tag Sort

**#455** enables the multi-tag sort function that allows the reader to identify unique tags within a group.

Reader response: **#Done**

**Note:** *Enabling the multi-tag sort function adversely affects the vehicle speed at which tags may be read. If there is only one tag expected in the vehicles of the target population, multi-tag sort should be disabled.*

## 456 Enable SeGo Protocol Tag Initialization During Multi-tag Sort (Factory Default)

**#456** enables the reader to send the Super eGo<sup>®</sup> (SeGo) protocol tag initialize command as part of the multi-tag sort function. When the reader sends the SeGo protocol tag

initialize command, all tags in the RF field reenter the sort process.

Reader response: **#Done**

### 457 Disable SeGo Protocol Tag Initialization During Multi-tag Sort

**#457** disables the reader from sending the SeGo protocol tag initialize command as part of the multi-tag sort function. Any SeGo protocol tags already identified by the reader during the sort process will not be re-identified as long as they remain powered in the RF field. The reader will only identify new tags that come into the RF field or tags that do not remain powered in the RF field.

Reader response: **#Done**

### 484 Disable SeGo

**#484** disables the reader from reading SeGo protocol data from tags.

### 485 Enable SeGo

**#485** enables the reader to read SeGo protocol data from tags if the reader is programmed to read this tag protocol.

## Reader Status — Command Group 5

Group 5 commands provide status reports on the parameters and operation of the reader.

### 505 Display Software Version

**#505** displays the reader model number, software version information, and assigned serial number.

Reader response: **Model E4 Series Ver X.XX SNSSSSSS**

where

**X.XX** Version number

**SSSSSS** Serial number of the unit, skipping the fourth character printed on the reader product label

### 506 Display Hardware Configuration Information

**#506** displays hardware configuration information stored in the reader memory by the user. Hardware configuration information is empty by default until you set the information to any 20 character ASCII string desired using Command #696S...S.

Reader response: An ASCII string from 1 to 20 characters in length

### 520 Display Power Fail Bit

**#520** displays the value of the reader power fail bit. The power fail bit changes from 0 to 1 when power to the reader is interrupted. To reset the bit, use Command #63 Reset Reader or Command #65 Reset Power Fail Bit. On initial power-up, the host should transmit one of these two commands to clear the power fail bit.

Reader response: **PWRB P<0 to 1> R0**

where

- P0** No power failure detected
- P1** Power failure detected
- R0** Not applicable to the MPRX-FH

## 521 Display Reader ID Number

**#521** displays the reader ID that is sent in the auxiliary data field.

Reader response:

**RDID xx**

where

**xx** = 01 to FF (hexadecimal)

## 522 Display Communications portParameters

Command **#522** displays the selected communications port parameters, including the baud rate (**#100N**), the number of stop bits (**#101N**), the parity scheme (**#102N**), and the end-of-line delay.

Reader response:

**MAIN B<2 to 7> S<0 to 1> P<0 to 2> D0**

where

- B2** 1200 baud
- B3** 2400 baud
- B4** 4800 baud
- B5** **9600 baud (factory default)**
- B6** 19.2 kbps
- B7** 38.4 kbps
- S0** **one stop bit (factory default)**
- S1** two stop bits
- P0** **no parity (factory default)**
- P1** even parity
- P2** odd parity
- D0** 00 ms end-of-line delay (fixed)

One space is required between each value. For example, if factory default settings are assigned, the reader message is

**MAIN B5 S0 P0 D0**

indicating 9600 baud, one stop bit, no parity, and 0-ms end-of-line delay.

**Note:** *The information transmitted in response to Command #522 applies to data and command mode operation only. While operating in download mode, default communications parameters are always used.*

## 524 Display Appended Information Status

**#524** displays the information being appended to the reader transmissions. Command **#31N** appends information.

Reader response: **IDAP T<0 to 1> D<0 to 1> X<0 to 1>**

where

**T0** Time not appended

**T1** Time appended

**D0** Date not appended

**D1** Date appended

**X0** **Auxiliary information not appended (factory default)**

**X1** Auxiliary information appended

One space is required between each value. For example, if factory-default settings are assigned, the reader response is

**IDAP T1 D1 X0**

indicating time and date appended, and auxiliary information not appended.

## 525 Display Communications Protocol Status

**#525** displays the status of Command **#610** Select Basic Communications Protocol, Command **#611** Select Error Correcting Protocol, or **#613** Enable Data Inquiry Protocol, Command **#614N** Selected Mode of Software Flow Control, and Command **#612NN** Error Correcting Protocol Timeout.

Reader response: **ECPS P<0 to 2> T<01 to FF> X<0 to 2> S0**

where

**P0** **Basic protocol selected (factory default)**

**P1** ECP enabled

**P2** data inquiry protocol enabled

**Txx** ECP timeout where **xx** = 01 to FE (hexadecimal) |

Timeout (ms) = 50 \* xx

If xx = FF timeout disabled

**X0** Software Flow Control disabled

**X1** **Software flow control enabled (factory default)**

**S0** start of message character is #

For example, if factory default settings are assigned, the reader message is:

**ECPS P0 TFE X1 S0**

which means basic protocol selected, an ECP timeout of 254 (12,700 ms or 12.7 sec), software flow control enabled, and start of message character is #.

## 527 Display RF Status

**#527** displays the current status of the RF module. The reader response indicates whether RF is controlled externally by the host, set by Command **#640N** RF Control, or internally by input set by Command **#641** (not applicable to the MPRX-FH). RF always is controlled by Sense 0 and Sense 1 when reader is in MPRX-FH mode. Sense 0 enables RF on antenna ports 0 and 1, and Sense 1 enables RF on antenna ports 2 and 3. Refer to “MUX Operational Modes” on page 5–83. Command **#527** also displays the current RF status and the uniqueness timeout.

Reader response: **RFST C<0 to 1> O<0 to 1> T<1 to 3> Fxxx Rxx Gxx Axx Ixx**

where

<b>C0</b>	RF controlled by host
<b>C1</b>	<b>RF controlled by presence sensor on input 0, the red/green pair (factory default)</b>
<b>O0</b>	RF off
<b>O1</b>	RF on
<b>T1</b>	Uniqueness timeout of two minutes
<b>T2</b>	Uniqueness timeout of 15 seconds
<b>T3</b>	Uniqueness timeout of 30 seconds
<b>Fxxx</b>	Not used
<b>Rxx</b>	Not used
<b>Gxx</b>	Tag decoder range (distance) for SeGo protocol tags, xx = 00 to 1F hexadecimal range value
<b>Axx</b>	RF power attenuation, where 00 is maximum output power and 0A is minimum output power (10dB less than maximum power).
<b>I04</b>	Fixed

For example, if factory default settings are assigned, the reader message is

**RFST C1 O0 T1 R1F G1F A00 I04**

which means that RF is enabled by presence sensor on input 0, RF signal off, uniqueness timeout of two minutes, RF output frequency has not been set, maximum RF output range for eGo and eGo Plus tags, full RF power, and IAG power set at 4 dB attenuation.

## 529 Display Presence Input Status

**#529** displays the parameters associated with presence detection and RF control. The reader’s message indicates if presence without tag reports are enabled/ disabled (**#690N** Select Presence without Tag Report Option), if input inversion is enabled/ disabled (**#694N** Select Input Inversion Option), and the minimum presence true period (always true). The reader’s message also reports the selected RF timeout (**#693N** Select RF Timeout Period) and the selected means of RF-off control (**#692N** Select RF Control Algorithm). If presence without tag reports is enabled (**#6901** Enable Presence without Tag Report Option), the reader transmits a report if a presence is detected without the subsequent acquisition of a valid tag.

**Note:** RF timeout values vary depending on the operative tag read mode and the type of tag in the read field. All times are approximate.

Reader response: **PRST P<0 to 1> D0 A<0 to 2> T<0 to F> I<0 to 1>**

where

<b>P0</b>	<b>Presence without tag reports disabled (factory default)</b>
P1	Presence without tag reports enabled
D0	Minimum presence true period of 0 ms (fixed)
A0	RF off on timeout only
A1	RF off on timeout or tag
<b>A2</b>	<b>RF off on timeout or presence condition false (factory default)</b>
T0	RF timeout of 0 ms (always expired)
T1	4 ms
T2	8 ms
T3	12 ms
T4	20 ms
T5	24 ms
T6	32 ms
T7	48 ms
T8	60 ms
T9	92 ms
TA	152 ms
TB	300 ms
TC	452 ms
TD	600 ms
TE	752 ms
<b>TF</b>	<b>RF timeout infinite, never expires (factory default)</b>
<b>I0</b>	<b>input inversion disabled (factory default)</b>
I1	input inversion enabled

For example, if factory default settings are assigned, the reader message is

**PRST P0 D0 A2 TF I0**

which means that presence without tag reports is disabled, minimum presence true period is 0, RF off control on timeout or presence false, infinite RF timeout, and input inversion disabled.

## 530 Display RF0 Filter Status

**#530** displays the parameter set for the RF input, including the selected unique ID code criteria (**#410N** Select Unique ID Code Criteria) and the valid ID code criteria, which are fixed at one acquisition.

Reader response: **RF0S U<0 to 4> V<0 to 3>**

where

<b>U0</b>	<b>One ID separation (factory default)</b>
<b>U1</b>	Two ID separations
<b>U2</b>	Three ID separations
<b>U3</b>	Four ID separations
<b>U4</b>	Transmit all IDs
<b>V0</b>	<b>Valid ID code criteria of one acquisition (factory default)</b>
<b>V1</b>	Valid ID code criteria of two acquisitions
<b>V2</b>	Valid ID code criteria of three acquisitions
<b>V3</b>	Valid ID code criteria of four acquisitions

For example, if factory default settings are assigned, the reader message is

**RF0S U0 V0**

which means separation of one ID for uniqueness filtering and a valid ID code criteria of one acquisition.

## 537 Display Echo Status

**#537** displays echo mode status. In basic protocol (**#610** Select Basic Communication Protocol) and data inquiry protocol (**#613** Enable Data Inquiry Protocol), the reader may be configured to enable (**#6171** Enable Echo Mode) or disable (**#6170** Disable Echo Mode) the echo of received commands. Refer to sections [6170 Disable Echo Mode](#) and [“6171 Enable Echo Mode \(Factory Default\)” on page 5–75](#) for more information.

Reader response: **ECHO <0 to 1>**

where

<b>0</b>	<b>Echo status disabled (factory default)</b>
<b>1</b>	Echo status enabled

## 540 Display Flash Checksum

**#540** displays the flash memory checksum.

Reader response: **PCKS I0000 Exxxx**

where

<b>0000</b>	Not applicable to the MPRX-FH
<b>xxxx</b>	Represents the four-byte ASCII representation of the flash memory checksum

## 543 Display Boot Checksum

#543 displays the boot ROM checksum.

Reader response: **BCKS xxxx**

where

**xxxx** represents the four-byte ASCII representation of the boot ROM checksum.

## 549 Get User-Programmable Group Select Equals (GSE) Filter Data

#549 queries the reader for the user-programmable GSE filter data programmed in the reader using Command #697. The response data is formatted similar to the data in the configuration command.

For example, if the command string shown in Command #697 (refer to “697 Set User-Programmable Group Select Equals (GSE) Filter” on page 5–80) was sent to a given reader, the response to the #549 query command would be:

**#A4 0A 0005014202024133**

The reader response contains all the data fields repeated in the same sequence as displayed in the User-Programmable GSE configuration command.

## 552 Display Antenna Multiplexing Mode

#552 displays the antenna multiplexing mode When the MPRX-FH mode is enabled

Reader response: **MUX x<0 to 3> <MPRX-FH>**

where

**x=0** antenna multiplexing disabled, RF on port 0 only

**x=1** antenna multiplexing between RF ports 0 and 1 when sense 0 active

**x=2** antenna multiplexing between RF ports 0 and 1 when sense 0 active and RF port 2 when sense 1 active

**x=3** antenna multiplexing between RF ports 0 and 1 when sense 0 active and RF ports 2 and 3 when sense 1 active

**MPRX-FH =** MPRX-FH mode selected

## 560 Request Sensor Status Change

#560 displays the sensor status change reporting. Not applicable to the MPRX-FH

Reader response: **SSTC E<0 to 1> M<0 to 3>**

where

**E0** Input status change reports disabled (factory default)

**E1** Input status change reports enabled

**M0** Reporting disabled (factory default)

**M1** Changes on input 0 reported

**M2** Changes on input 1 reported

**M3** Changes on either input reported



For example, if factory default settings are assigned, the reader message is

**SSTC E0 M0**

which means that input status change reports are disabled on both input 0 and input 1.

## 570 Display Operating Mode Status

**#570** displays the currently selected tag read mode.

Reader response: **D> eGo:<I, D> SeGo:<I, D> IAG:<E, D> Sort:<E, D> TMM0**

where

<b>I</b>	ID (64 bits)
<b>E</b>	Enabled
<b>F</b>	Not used
<b>D</b>	Disabled
<b>TMM0</b>	Fixed

## 577 Report Buffered Handshakes

**#577** reports the buffered handshakes. When in MPRX-FH mode and/or if antenna multiplexing is enabled, the response is

Reader response: **HDSH C0 <ww> C1 <xx> C2 <yy> C3 <zz>**

where

<b>ww</b>	count from port 0
<b>xx</b>	count from port 1
<b>yy</b>	count from port 2
<b>zz</b>	count from port 3

## Reader Control Functions — Command Group 6

Group 6 commands set reader control functions such as reader ID, communication protocol, output pulse, and RF control.

### 60NN Set Reader ID Number

**#60NN** sets the reader ID that will be sent in the auxiliary data field (Command **#311**). Uppercase or lowercase characters are allowed for **NN**; for example, hex digits A through F or a through f

where

**NN = 00 to FF** (hex for 0 to 255, **factory default = 00**).

Reader response **#Done**

### 610 Select Basic Communication Protocol (Factory Default)

**#610** enables the basic communications protocol.

Reader response: **#Done**

## 611 Select Error Correcting Protocol

#611 enables the error correcting protocol.

Reader response: #Done



### Caution

**Do not switch to ECP (Command #611 Select Error Correcting Protocol) unless the host is prepared to acknowledge each reader transmission.**

## 612NN Select Error Correcting Protocol Timeout

#612NN selects the timeout interval for ECP. This timeout applies to the transmission of tag, report, and error messages and to the receipt of host commands. The transmit timeout is initiated immediately after the end-of-message sequence CR/ LF is transmitted. If the host does not acknowledge the message within the specified interval, the reader times out and retransmits the message.

The receive timeout is initiated upon receipt of the start-of-message character (#). If the end-of-message character (CR) is not received within the specified interval, the reader discards the partially received message and resets its receiver.

Uppercase or lowercase characters are allowed for NN; for example, hex digits A through F or a through f.

The value for NN specifies the timeout interval as follows:

`ms 50 * NN for NN = 01 to FE (1-254)`

where

**FE** Factory default (12,700 ms or 12.7seconds)

**FF** Disables the ECP timeout

Reader response: #Done



### Caution

**Ensure that the ECP timeout is sufficient for a given baud rate. Refer to “00 Switch to Data Mode (Factory Default)” on page 5–58.**

## 613 Enable Data Inquiry Protocol

#613 Enable Data Inquiry Protocol. Refer to “Data Inquiry Protocol” on page 4–45” for more information.

Reader response:

#Done

## 614N Select Software Flow Control Option

#614N selects the Software Flow Control option for reader-to-host communications. The factory default setting is software flow control (XON/XOFF) enabled. During data mode and command mode operation, the following Software Flow Control options are available. The N variable specifies Software Flow Control as shown in Table 19.

Table 19 Software Flow Control Commands

Command	Software Flow Control Option
6140	Disable software flow control
6141	Enable software flow control (factory default)

If the reader is configured for software flow control (XON/XOFF), it stops transmitting if it receives an XOFF character (host software Command 13H). It does not resume transmitting until it receives an XON character (host software Command 11H).

**Note:** *TransCore recommends that XON/XOFF Software Flow Control be disabled while using the ECP.*

## 6170 Disable Echo Mode

**#6170** disables the reader's echo of received host commands. If operating in basic protocol or data inquiry protocol, the reader echoes by default. As the reader receives a host command, it echoes each character of the command. Once the entire command has been received and processed, the reader transmits its response. If echoing is disabled with Command **#6170**, the reader does not echo the command, but only transmits its response. The reader never echoes while in ECP or download mode operation.

Reader response: **#Done**

## 6171 Enable Echo Mode (Factory Default)

**#6171** enables the reader to echo received host commands

**#6170** disables echo mode

Reader response: **#Done**

## 63 Reset Reader

**#63** resets the power fail bit, clears all buffers, resets tag uniqueness, turns off both output lines, transmits the sign-on message, and returns to the data mode.

**Note:** *This command does not reset any other configuration parameters.*

Reader response: **Model E4 Series Ver X.XX SNSSSSSS**

**Copyright 2008 TransCore**

where

**X.XXD** Version number

**SSSSSS** Serial number of the unit, skipping the fourth character printed on the reader product label.

## 640N RF Control

**#640N** directly controls the RF module. The N value controls the RF power as shown in [Table 20](#).

**Table 20 RF Control Commands**

Command	RF Power
6400	Turns off RF
6401	Turns on RF

**Note:** *These commands only have an effect when the reader is not in MPRX-FH mode. Refer to Commands #836 and #837.*

#6400 disables RF-by-input control command

**#641 Select RF-by-Input Control (default)**

Reader response: #Done

**641 Select RF-by-Input Control (Factory Default)**

#641 configures the reader for RF-by-input control. The reader automatically turns on RF when it detects a presence through sense 0. The reader turns off RF according to the selected RF control algorithm (#692N Select RF Control Algorithm).

**Note:** *This command only has an effect when the reader is not in MPRX-FH mode.*

Reader response: #Done

**644NN Set RF Attenuation**

#644NN sets the attenuation control for the output RF power where NN is a hexadecimal value from 00 to 0A. Settings for attenuation are 1.0 dB increments over a range of 10 dB of attenuation from the maximum power setting of 2 watts at 0dB attenuation to a minimum power level of 200 milliwatts at 10-dB attenuation.

The Set RF Attenuation Command NN variables and corresponding attenuation settings are shown in [Table 21](#).

**Table 21 RF Attenuation Command Variables**

Variable (NN)	Attenuation Setting (dB)
<b>00</b>	<b>0 (factory default)</b>
01	1
02	2
03	3
04	4
05	5
06	6
07	7
08	8
09	9
0A	10

Reader response: #Done

## 645NN Set SeGo/ISO/IEC 18000-63 Protocol Operating Range (Distance)

**#645NN** sets the read range for SeGo/ISO/IEC 18000-63 protocol tags where NN is a hexadecimal value from 00 to 1F; the range increases with increasing NN value. The range can be adjusted for 32 discrete values where 00 is the shortest range and 1F is the longest range. **Default range value is 1F.**

Reader response: **#Done**

## 65 Reset Power Fail Bit

**#65** resets the power fail bit to 0. The bit changes from 0 to 1 when power is restored to the reader. Upon reader power-up, the host transmits either Command **#65** or **#63** Reset Reader to properly initialize this bit. The current state of the power fail bit may be displayed. Refer to “[520 Display Power Fail Bit](#)” on page 5–66 for more information.

Reader response: **#Done**

## 66F Load Default Operating Parameters

**#66F** loads all the factory default operating parameters except RF operating frequency. Refer to “[Factory Default Settings](#)” on page D–112 for a listing of the defaults.

Reader response:

**#Done** All parameters loaded OK

**#Error** A parameter load failed

## 690N Select Presence Without Tag Report Option

**#690N** enables or disables the presence without tag report option. If the presence without tag reporting option is enabled using Command **#6901**, input reports are transmitted when a tag presence is detected without the subsequent acquisition of a valid tag. The value for **N** specifies the reports as shown in [Table 22](#).

**Table 22 Presence Without Tag Report Commands**

Command	Report Option
<b>6900</b>	<b>Disable presence without tag reports (factory default)</b>
<b>6901</b>	Enable presence without tag reports

**Note:** *These commands only have an effect when the reader is not in MPRX-FH mode.*

Reader response: **#Done**

Refer to “[Basic Protocol and ECP Format](#)” on page 4–45 for message format information.

## 692N Select RF Control Algorithm

**#692N** selects the algorithm for turning off RF power when RF-by-input control is enabled using Command **#641** Select RF-by-Input Control.

The values for **N** specify the RF control algorithms as shown in [Table 23](#).

Table 23 RF Control Algorithm Commands

Command	RF Power Off
6920	On timeout only
6921	Timeout or tag ID acquired
<b>6922</b>	<b>Timeout or presence false (factory default)</b>

- #6920** turns off RF power based on the timeout established by Command **#693N** Select RF Timeout Period.
- #6921** allows RF power to be turned off either after the timeout period or upon acquisition of a valid tag ID, whichever occurs first.
- #6922** turns off RF power either after the timeout period or upon the presence false condition, whichever occurs first.

Reader response: **#Done**

### 693N Select RF Timeout Period

- #693N** selects the RF timeout period used by Command **#692N** Select RF Control Algorithm. Values for N range from 0 through F.
- #693F** disables the RF timeout. The reader turns off the RF immediately following the acquisition of a valid tag, whether or not it is unique (default).

Uppercase or lowercase characters are allowed for N; for example, hex digits A through F or a through f. The commands and corresponding timeouts are shown in [Table 24](#).

Table 24 Timeout Period Values

Command	Timeout (ms)
6930	0 (always expired)
6931	4
6932	8
6933	12
6934	20
6935	24
6936	32
6937	48
6938	60
6939	92
693A	152
693B	300

Table 24 Timeout Period Values

Command	Timeout (ms)
693C	452
693D	600
693E	752
<b>693F</b>	<b>Infinite (never expires, factory default)</b>

Reader response: **#Done** or **#Error**.

The reader returns an Error message if a valid hexadecimal digit is not substituted for N in Command **#693N**.

**Note:** *This command only has an effect when the reader is not in MPRX-FH mode.*

## 694N Select Input Inversion Option

**#694N** enables or disables input inversion. When inversion is enabled, an open circuit input is interpreted as a closed circuit, and a closed circuit input is interpreted as an open circuit. This feature allows greater flexibility in the attachment of external equipment to the reader inputs. For example, some proximity sensors indicate presence with an open circuit. In this instance, Command **#6941** can enable input inversion so that an open circuit input indicates a presence. The values for N represent the two inversion options as shown in Table 25.

Reader response: **#Done**

Table 25 Input Inversion Options

Command	Option
<b>6940</b>	<b>Disable input inversion (factory default)</b>
6941	Enable input inversion

## 695S...S Set Serial Number (Factory Default)

**#695** assigns the reader serial number according to the format:

**695SSSSSS**

where **SSSSSS** is the serial number.

The serial number may contain as many as six uppercase or lowercase ASCII alphanumeric characters.

**Note:** *The factory-assigned serial number of the reader contains seven characters. However, to maintain backward compatibility, the reader software allows only six characters to be entered. When setting the serial number, skip the fourth (middle) character of the seven-character number shown on the reader product label. Once assigned, the serial number is preserved during power-down and the loading of default parameters.*

Reader response: **Done**

## 696S...S Store Hardware Configuration String (Factory Default)

**#696S...S** stores hardware configuration information into reader memory. The hardware configuration string is assigned according to the following format:

**696S...S**

where

**S...S** is the hardware configuration string that may contain as many as 20 uppercase or lowercase ASCII alphanumeric characters.

**Note:** Once assigned, configuration information is preserved during power-down and the loading of default parameters.

Reader response: **#Done**

## 697 Set User-Programmable Group Select Equals (GSE) Filter

**#697** sets the user-programmable GSE filter. The command string is assigned according to the following format:

**697 MM AA DDDDDDDDDDDDDDDDD**

where

**MM =** The tag uses this mask to determine which of the eight Comparison Data bytes are to be compared for the Group Select filter.

**AA =** This field is used by the tag to determine the start address in the tag memory for the comparison data.

**DD...DD =** Comparison Data: an 8-byte field (16 characters) used by the tag as the comparison data for the Group Select filter. The tag compares the data in this field to data in tag memory beginning at the Start Address to determine if the tag will respond to a reader Group Select request. Only the bytes having the corresponding bit set in the GSE Mask is used for this comparison.

As an example, to configure a reader to have only tags with data in byte locations 10, 12, and 15 (decimal) with hexadecimal values “00,” “01,” and “02,” the following command is used:

**#697 A4 0A 0005014202024133**

To understand how the data is interpreted, it is necessary to break down the GSE Mask field, A4, into binary:

**A4 = 1010 0100**

This mask equates to the tag comparing the first, third, and sixth bytes of the Comparison Data to data in the tag beginning at address location 0A (10 decimal).

The Comparison Data field is broken down in bytes with the bytes corresponding to the mask underlined in bold (for clarification):

**Address: 0A 0B 0C 0D 0E 0F 10 11**

**Data: 00 05 01 42 02 02 41 33**

where

**0A** (10 decimal) must be equal to “00” hexadecimal, the first byte in the Comparison Data



	field
<b>0C</b>	(12 decimal) must be equal to “01” hexadecimal, the third byte in the Comparison Data field
<b>0F</b>	(15 decimal) must be equal to “02” hexadecimal, the sixth byte in the Comparison Data field

Reader response: **#Done**

## 698XX Set ISO/IEC 18000-63 Tag Range

#698XX Variable will be EPCRFRange

## Auxiliary Reader Control — Command Group 8

Group 8 commands provide control of reader functions, such as the sense inputlines.

### 830 Disable Automatic Periodic RF Status Report (Factory Default)

**#830** default set in the factory to disable the automatic periodic RF status report.

Reader response: **#Done**

### 831 Enable Automatic Periodic RF Status Report

**#831** enables the automatic periodic RF status report. This function sends out a periodic RF status report if no other message (a tag read) is sent from the reader for a period of time. This message is the same message that would be sent in response to the **#527** Display RF Status command. Enabling this function is helpful in some sites where there may not be much tag activity, and the user wants an automatic way to ensure the communication channel with the reader is still intact. With this function enabled, the host system will get a message from the reader at least every three minutes.

Reader response: **#Done**

### 836 Disable MPRX-FH Mode

**#836** disables the MPRX-FH mode.

Reader response: **#Done**

### 837 Enable MPRX-FH Mode

**#837** enables the MPRX-FH mode.

Reader response: **#Done**

### 838 Disable ISO/IEC 18000-63 Protocol

**#838** Variable is EPC\_tag\_en

Reader response: **False/True**

### 839 Enable ISO/IEC 18000-63 Protocol

**#839** Variable is EPC\_tag\_en

Reader response: **False/True**

### 840 Disable ISO/IEC 18000-63 Tag Sort

#840 Variable is EPC\_tag\_sort

Reader response: **False/True**

### 841 Enable ISO/IEC 18000-63 Tag Sort

#840 Variable is EPC\_tag\_sort

Reader response: **False/True**

### 842 Disable AI1200 Emulation Mode

#842 disables the AI1200 Emulation mode.

Reader response: **#Done**

### 843 Enables the AI1200 Emulation Mode

#843 enables the AI1200 Emulation mode.

Reader response: **#Done**

### 850 MUX RF Port 0 (Factory Default)

#850 enables RF port 0, which disables antenna multiplexing.

Reader response: **#Done**

### 851 MUX Between RF Ports 0 and 1

#851 multiplexes between RF ports 0 and 1.

Reader response: **#Done**

### 852 MUX Between RF Ports 0, 1, and 2

#852 multiplexes between RF ports 0, 1, and 2.

Reader response: **#Done**

### 853 MUX Between RF Ports 0, 1, 2, and 3

#853 multiplexes between RF ports 0, 1, 2, and 3.

Reader response: **#Done**

### 891 MUX Test Mode RF Port 1 Only

#891 turns on RF port 1 only for antenna mux testing.

Reader response: **#Done**

**Note:** Refer to “MUX Test Modes” on page 5–83 for test operation.

### 892 MUX Test Mode RF Port 2 Only

#892 turns on RF port 2 only for antenna mux testing.

Reader response: **#Done**

**Note:** Refer to “MUX Test Modes” on page 5–83 for test operation.

## 893 MUX Test Mode RF Port 3 Only

**#893** turns on RF port 3 only for antenna mux testing.

Reader response: **#Done**

**Note:** Refer to “MUX Test Modes” on page 5–83 for test operation.

## MUX Operational Modes

**To enable antenna multiplexing (muxing) operational modes, issue the following commands:**

**#836 / #837** Disable/enable MPRX-FH mode

**#850** **RF port 0 only (factory default)**

**#851** mux between RF ports 0 and 1

**#852** mux between RF ports 0, 1, and 2

**#853** mux between RF ports 0, 1, 2, and 3

**#552** Display mux setting. This display message will include “MPRX-FH” if MPRX-FH mode is enabled (**#837**).

When MPRX-FH mode is disabled, the reader will continuously step through each port that has been enabled with **#85X**, stepping through whichever tag protocols are enabled on each port, in order. The reader turning RF on will be qualified “RF on by sense” setting. Command **#6401** is used to turn RF on continuously and bypass the RF on by sense. Sense 0 is used for all antennas that are enabled, if RF is turned on by sense, **#641**.

When MPRX-FH mode is enabled, you must use Sense 0 and Sense 1 to turn on RF and read tags. Sense 0, when shorted to reader signal ground, will enable tag reads on RF ports 0 and 1 (if enabled with **#851**) and Sense 1 will enable tag reads on ports 2 and 3 (if enabled with **#853**). For example, if Commands **#837** and **#853** have been entered, Sense 0 is open, Sense 1 shorted, and the reader is in data mode, the reader will attempt tag reads toggling between RF ports 2 and 3 only.

## MUX Test Modes

**To enable antenna muxing test modes, issue the following commands:**

**#891** RF port 1 only

**#892** RF port 2 only

**#893** RF port 3 only

To use these test modes, MPRX-FH mode must be disabled (**#836**) and muxing must be disabled (**#850**). These command modes are not saved to NVM, and will be cleared by a power cycle of the reader, or by enabling either MPRX-FH mode or muxing. When these modes are enabled, the reader will continually run through whichever tag protocols have been enabled, but only on the selected RF port. These test mode commands are qualified by the RF on by sense settings. Use **#6401** to disable RF on by sense, if desired.

# Chapter 6 Configuration

## Configuring the Reader

After installing the MPRX-FH, you need to configure its operating parameters. Terminal settings should be initially set at 9600 baud, 8 data bits, no parity, 1 stop bit, and no software flow control.

### Default Operating Parameter Settings

Table 26 contains the factory default configuration settings for the MPRX-FH operating parameters. The default configuration settings may not be the correct operating configuration settings for a specific site.

Review the default configurations shown in Table 26 to determine which parameters, in addition to operating frequency and operating range, need to be adjusted. Refer to “Commands” on page 5–57 for a complete list of parameters and the corresponding commands.

**Note:** The dual-protocol MPRX-FH internal timing varies depending on the operative tag read mode and the type of tag in the read field.

**Table 26 MPRX-FH Default Configuration Settings**

Parameter	Setting	Command
Operating mode	Data	00
Baud rate	9600	1005
Stop bits	1	1010
Parity	None	1020
Time and date appended	Enabled	302
Auxiliary information appended	Disabled	310
Unique ID code criteria	Separation of 1 ID	4100
SeGo protocol tag initialization during multi-tag sort	Enabled	456
Reader ID number	00	6000
Communications protocol	Basic	610
Error correcting protocol (ECP) timeout	12.7 sec	612FE
Software flow control	Software (XON/XOFF)	6141
Echo mode	Enabled	6171

Table 26 MPRX-FH Default Configuration Settings

Parameter	Setting	Command
RF attenuation	Full power	64400
SeGo protocol tag operating range	Maximum	6451F
Presence without tag reports	Disabled	6900
RF-off control	Timeout or no presence	6922
RF timeout	Never true	693F
Input inversion	Disabled	6940
Serial number	SSSSSS	695
Store hardware configuration	Hardware configuration not known	696
Automatic periodic RF status report	Disabled	830

## Terminal Emulation Software

To configure the MPRX-FH using a PC and terminal emulation software to manually enter MPRX-FH host commands, follow the instructions in the section [“Connecting the MPRX-FH to the Host Port” on page 2–34](#). Then, enter the appropriate configuration commands through the terminal emulation software on the host.

Refer to [“Commands” on page 5–57](#) for a detailed description of all available configuration commands.

### Starting the Terminal Emulation Software

You can use a PC and any terminal emulation software to enter the host commands to download flash software, configure reader operating parameters, perform diagnostics, and retrieve tag data.

#### To start the terminal emulation software

At the command prompt, type your terminal emulation start command and press **ENTER**. The application should display a connection description dialog box.

3. Enter a name for the session and click OK. The application should display a phone number dialog box.
4. Choose the Com 1 option or whichever com port on the PC to which the RS–232 cable is attached.
5. Use the following values:
  - Bits per second: 9600 baud
  - Data bits: 8
  - Parity: None
  - Stop bits: 1
  - Software flow control: None

## Verifying Communications

You must verify that the MPRX-FH and the PC or laptop are communicating.

### To verify communications

1. Start the terminal emulation application as described in [“Starting the Terminal Emulation Software” on page 6–85](#).

**Note:** When testing the MPRX-FH using a laptop computer, TransCore recommends that you configure laptop communication parameters to match those of the host device to which the MPRX-FH will be connected after testing and configuration are completed.

2. Cycle the power on the MPRX-FH. Upon startup, the MPRX-FH transmits a sign-on message displayed on the terminal emulation screen, or a boot ROM failure message.

The sign-on message appears as follows at a baud rate of 9600 bps:

```
Model [software version] SNSSSSSS [Copyright notice]
```

where **SSSSSS** is the serial number assigned to the MPRX-FH skipping the fourth character printed on the reader product label.

Serial number **000000** is the default setting and is not a valid number. If this number appears in the sign-on message, the serial number has not been stored into reader memory. Contact TransCore Technical Support.

If the flash memory checksum is not verifiable, the sign-on message appears as follows:

```
Model [E4 BOOT] Ver 0.00 A
```

```
[Copyright notice]
```

If the failure message version number equals **0.00 E** and no serial number exists, the flash memory checksum has failed, and the MPRX-FH is operating out of boot ROM. In this case, the MPRX-FH automatically enters download mode and waits for a new program to be loaded into the flash memory. Follow the instructions in [“Download Considerations” on page 3–41](#).

Communications can also be verified by using the command sequence in [Table 27](#).

3. If a successful sign-on message is not returned, check connections and communications factors and correct any errors.

**Table 27 Command Sequence to Verify Communications**

Entry	MPRX-FH Response	Notes
#01 <CR>	#Done <CR/LF>	Switches the MPRX-FH to command mode
#505 <CR>	#Model E4 Series Ver X.XX SN97001P <CR/LF>	Reports the software version and serial number
#00 <CR>	#Done <CR/LF>	Returns the MPRX-FH to data mode

### To check connections and communications factors

1. Confirm that the MPRX-FH has power.
2. Verify the connections between the PC and the MPRX-FH.
3. Verify the receive (Rx) and transmit (Tx) connections.
4. If using handshaking, verify the request to send (RTS) and clear to send (CTS) connections.
5. Verify the COM port settings for the MPRX-FH following the instructions in [“Serial Port Communications”](#) on page 6–92.

Repeat the procedures in [“Verifying Communications”](#) on page 6–86.

If you still cannot verify the MPRX-FH and PC communications, contact TransCore Technical Support.

## Verifying Tag Read Capability

After verifying communications between the MPRX-FH and the PC, verify the capability to read tags. The test tag should match the tag type and protocol of the tags that your system will be reading.

The polarization of the test tag must be aligned in the same direction as the antenna. [Figure 22](#) shows horizontally polarized antenna and tag. The test tag must be mounted flush against a metal backplane.

**Note:** *Matching the tag and antenna polarization is critical to obtaining optimal system performance*



**Figure 22** Tag and Antenna Orientation (horizontal polarization)

**Note:** *The default tag read mode of the reader is the protocol(s) programmed into the reader. Use only those test tags programmed with the correct protocol(s) for the reader.*



#### Caution

**To avoid damage to the MPRX-FH, you must connect the antenna before applying power to the reader.**

### To verify tag read capability

1. Once communications are verified, enter the following sequence of commands to turn on continuous RF:
  - #01
  - #6401
  - #40
  - #00
2. Pass one test tag in front of the active MPRX-FH antenna. If the MPRX-FH reads the tag, the terminal emulation application displays the tag information on the screen.
3. If the tag ID is not displayed, perform the following actions:
  - Verify that the MPRX-FH is in data mode (Command #00 Switch to Data Mode).
  - Ensure that the tag you are using is compatible with the MPRX-FH. The MPRX-FH can read tag types that are compatible with the reader model.
  - An MPRX-FH displays the tag read for any tag that is compatible with the reader programming.
  - Using the audible circuit tester as described in [“Testing the MPRX-FH Circuit” on page 2–27](#), verify that the reader is capable of reading the tag in the read zone. If it is, the problem is probably in the communications between the MPRX-FH and the host.
4. Pass a different reader-compatible test tag in front of the MPRX-FH antenna.
5. When the MPRX-FH reads the second tag successfully, the terminal emulation application displays that tag’s information in the main screen below the information for the first tag.
6. If the read is unsuccessful, perform the following actions:
  - Ensure the tag you are using is compatible with the MPRX-FH.
  - Using the audible circuit tester as described in [“Testing the MPRX-FH Circuit” on page 2–27](#), verify that the reader is capable of reading the tag in the read zone. If it is, the problem is probably in the communications between the MPRX-FH and the host device.

## Configuring MPRX-FH Parameters

---

Follow the procedures in this section to configure MPRX-FH parameters using a PC, laptop, or terminal emulator. The PC or laptop must be connected to and communicating with the MPRX-FH and the terminal emulation application must be configured correctly, as described in the section [“Verifying Communications” on page 6–86](#).

### To configure parameters

1. Switch to command mode by typing #01 at the prompt on the terminal emulation screen, and pressing ENTER.

**Note:** All MPRX-FH commands are preceded by the start-of-message character (#).

2. To meet requirements of your site, make changes to default operating parameters as described in the following sections.



The following sections contain procedures to set some of the parameters that are commonly changed to meet the requirements of a specific site. Procedures are listed in alphabetical order by parameter.

## Appended Tag Data

Use this procedure to set appended tag data parameters using the terminal emulation application. Refer to [“31N Append Auxiliary Information Selection” on page 5–62](#) for more information.

### To set appended tag data parameters

1. Ensure that the host device is in command mode.
2. Enter Command **#311** to append auxiliary information or Command **#310** to have no auxiliary information appended (factory default). Press ENTER.

## ID Separation

The host can select a unique ID separation of one ID or two IDs. The reader default operation is for a unique ID separation of one ID and a uniqueness timeout of two minutes. You can disable the uniqueness check using Command **#40 Transmit All ID Codes**. In this case, every tag ID received is transmitted without regard to uniqueness. You can reinstate uniqueness checking with commands **#4100** or **#4101** Select ID Separation.

**Note:** *The MPRX-FH internal timing varies depending on the operative tag read mode and the type of tag in the read field.*

Refer to section [“40 Transmit All ID Codes” on page 5–63](#) and section [“529 Display Presence Input Status” on page 5–69](#).

### To set ID separation parameters

1. Ensure that the host device is in command mode.
2. Enter Command **#4100** to select a separation of one ID; enter Command **#4101** to select a separation of two IDs. Press ENTER.

## Reports

The MPRX-FH can be configured to transmit presence without tag reports and input status change reports. A presence without tag report is transmitted in data mode only, and only if the system has a presence detector. This report is sent if a presence is detected without the detection of a valid tag ID. Refer to sections [“529 Display Presence Input Status” on page 108](#) and [“690N Select Presence Without Tag Report Option” on page 5–77](#).

### To set presence reporting

1. Ensure that the host device is in command mode.
2. Enter Command **#529** to display presence input status and press ENTER. P0 indicates presence without tag reports disabled (factory default), and P1 indicates presence without tag reports enabled.
3. Enter Command **#6901** to enable presence without tag reports, or enter Command **#6900** to disable presence without tag reports (factory default). Press ENTER.

### To set input status change reporting

1. Ensure that the host device is in command mode.
2. Enter Command **#560** to display input status change report options and press **ENTER**.

<b>E0</b>	input status change reports disabled (factory default)
<b>E1</b>	input status change reports enabled
<b>M0</b>	reporting disabled (factory default)
<b>M1</b>	changes on input 0 reported
<b>M2</b>	changes on input 1 reported
<b>M3</b>	changes on either input reported

## Reset Reader

Command **#63** Reset Reader resets uniqueness, clears the power fail bit, and transmits the sign-on message. The reader returns to data mode following the completion of this command.

**Note:** This command does **not** reset any of the configuration parameters.

Refer to [“63 Reset Reader” on page 5–75](#).

### To reset the reader

1. Ensure that the host device is in command mode.
2. Enter Command **#63**. Press **ENTER**.

## Radio Frequency

The MPRX-FH operates in the 902 to 928MHz band as a frequency hopper. Each frequency is used equally on average by the transmitter.

## RF Transmission

The RF transmission can be controlled by connecting a presence detector to the SENSE0 circuit. As a factory default, the MPRX-FH is configured to control the RF power with a presence detector. [Figure 23](#) illustrates the methods of controlling RF sense output.

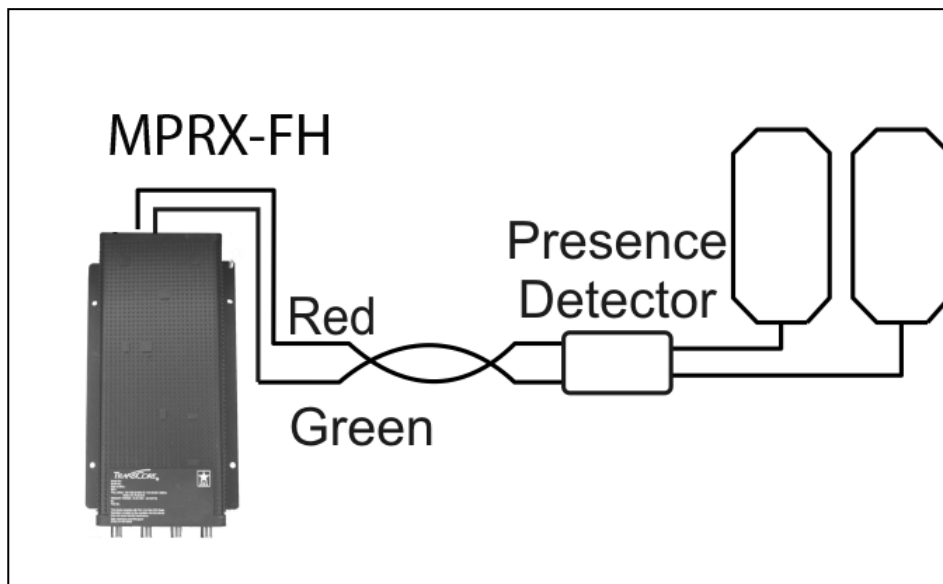

Figure 23 MPRX-FH RF Control Options

### Presence Detector Controlling RF Transmission

The presence detector can be a loop detector, a track circuit, an infrared sensor, an ultrasonic sensor, or another presence detection device that is connected to sense input0 to turn on the MPRX-FH RF transmitter. In [Figure 23](#), Option A shows a presence detector controlling the RF transmitter. This operation ensures that the RF is “on” only when a train is in the MPRX-FH read zone. **Command #641** Select RF-by-Input Control (factory default) must be enabled.

To set the option of the presence detector controlling the MPRX-FH

- Ensure that the host device is in command mode.
- Enter Command **#641**. Press ENTER.
- Leave the setting on RF-by-input control for normal operation.

## Sense Inputs

The RS-232 configuration used by the MPRX-FH has two sense inputs — SENSE 0 and SENSE 1. SENSE 0 is used to enable RF on antenna ports 0 and 1 if enabled, and SENSE 1 is used to enable RF on antenna ports 2 and 3. The sense input circuits are used to notify the MPRX-FH of train presence and are designed to be connected to a free-of-voltage dry contact. The MPRX-FH sense inputs are designed to connect to a dry contact closure.

You can configure the MPRX-FH to generate input status change reports, which are transmitted like tag IDs. The host can then respond based on the true/false (closed/open) status of the sense inputs. Refer to the section [“Reports” on page 6–89](#).

The following procedures describe how to set sense inputs using the terminal emulation software. Refer to command [“694N Select Input Inversion Option” on page 5–79](#) for more information.

### To set sense inputs

1. Ensure that the host device is in command mode.
2. Enter Command **#6940** to disable input inversion (factory default) or Command **#6941** to enable input inversion, and press **ENTER**.

## Sense Output Device

The sense output is dedicated for testing and set up of the reader. It is defined as the TAG\_LOCK signal and indicates that a valid tag is in the read field.

This sense output is a dry contact that provides a normally open and normally closed sense output. The relay contacts are rated at 42.2V AC peak (30 Vrms) or 60V DC at 1 A maximum. If controlling an external gate or device requiring high current, an isolation transformer is required.

## Serial Port Communications

The MPRX-FH supports one RS–232 communications port. For the RS–232 communications specification, the MPRX-FH maintains the following three sets of parameters that affect serial port communications:

- Port configuration parameters (baud rate, data bits, stop bits, parity)
- Communications protocols (basic, error correcting)
- Flow control scheme (none, software)

The default serial port configuration for each of these three parameters is as follows:

- 9600 baud, 8 data bits, 1 stop bit, no parity
- Basic communications protocol
- Software flow control (XON/XOFF)

You can change these parameters in data mode and command mode operation by issuing commands with the host device. Use the following procedures to set serial port communications parameters using the terminal emulation program.

## Port Configuration Parameters

Use this procedure to set port configuration parameters using the terminal emulation program. Refer to sections [“100N Select Baud Rate” on page 5–59](#) through [“102N Select Parity” on page 5–60](#).

### To set baud rate

1. Ensure that the host device is in command mode.
2. Enter Command **#100N** and press **ENTER**.

### To set stop bits

1. Ensure that the host device is in command mode.
2. Enter Command **#101N** and press **ENTER**.

**To set parity**

1. Ensure that the host device is in command mode.
2. Enter Command **#102N** and press **ENTER**.

## Communications Protocol

Use the following procedures to set communications protocol. Refer to sections “[610 Select Basic Communication Protocol \(Factory Default\)](#)” on page 5–73 through “[614N Select Software Flow Control Option](#)” on page 5–74 for more information.

**Caution**

***Do not switch to ECP (Command #611) unless the host is prepared to acknowledge each reader transmission.***

**To select a communications protocol**

1. Ensure that the host device is in command mode.
2. Enter Command **#610** to select basic protocol (factory default) or Command **#611** to select ECP and press ENTER.

## Software Flow Control

The host can enable or disable software flow control with Command **#614N** Select Flow Control Option.

The host can use software control characters (XON/XOFF) to interrupt reader transmissions. When the reader is configured for software flow control, it stops transmitting if it receives the XOFF character from the host (host software command 13H). It resumes transmitting only when it receives the XON character (host software command 11H) from the host. If software flow control is not needed, the reader should be configured for no flow control (**#6140 Disable Flow Control**).

**Note:** *TransCore recommends that XON/XOFF software flow control be disabled while using the ECP.*

Use the following procedure to set software flow control parameters using the terminal emulation program. Refer to section “[614N Select Software Flow Control Option](#)” on page 5–74 .

**To select software flow control**

1. Ensure that the host device is in command mode.
2. Enter Command **#6140** to disable flow control, Command **#6141** to enable software flow control (factory default) and press ENTER.

## Fine-Tuning and Verifying the Read Zone

If the read zone is too wide or too deep for your application, it can be fine-tuned by physically adjusting the external antenna mounting orientation, reprogramming the actual RF power output (**#644NN** Set RF Attenuation), and/or reprogramming the RF sensitivity range and **#645NN** Set SeGo Protocol Tag Operating Range). The combination of these adjustments allows you to confine the read zone to the area where tagged vehicles pass.

Refer to sections “645NN Set SeGo/ISO/IEC 18000-63 Protocol Operating Range (Distance)” on page 5–77, and “644NN Set RF Attenuation” on page 5–76 for more information.

**Note:** As described in “Marking the Read Zone” on page 4–14, marking the read pattern using test tags that are hand-carried by a tester gives a general idea of the read pattern but the pattern may vary somewhat when actual rail assets are read.

## Physically Orienting the MPRX-FH Antenna(s)

You can manually adjust the location of the read zone by loosening the antenna(s) mounting hardware and pointing the antenna in the desired direction. The unit should be aligned to point directly at the tag as it enters the desired read zone.

## Fine-Tuning the Read Zone by Lowering Output Power

You can make the read zone smaller by adjusting the MPRX-FH RF power output from a maximum of 2 watts to a minimum of 200 milliwatts using Command **#644NN** Set RF Attenuation.

### To adjust the read zone by lowering output power

1. Ensure that your PC is communicating with the MPRX-FH using a terminal emulation program as described in section “Verifying Communications” on page 6–86.



#### Caution

**Test tags should be compatible with your MPRX-FH. Test tags should be ISO/IEC 18000-63 or SeGo.**

Enter Command **#01** to switch to command mode. You are prompted with **#DONE** from the reader and can now enter reader commands.

2. Enter in Command **#64401** to lower the RF power by 1 dB below 2 watts (default). Press **ENTER**.

**Note:** In the Command **#644NN**, NN can be any hexadecimal value from 00 to 0A. Settings for attenuation are 1.0 dB increments over a range of 10 dB of attenuation from the maximum power setting of 2 watts at 0 dB attenuation to a minimum power level of 200 milliwatts at 10 dB attenuation. Increasing the attenuation lowers the output RF power.

3. Switch to data mode by entering Command **#00** and pressing **ENTER**.
4. Verify that the read zone has decreased by moving the tag through the desired read area. If the read zone is still too large, switch to command mode and enter the Command **#64402** to lower the output RF power another 1 dB. Continue increasing the NN value until the read zone matches the desired read zone.

When the desired read zone is established, test the read zone with simulated and real traffic by performing the following procedures:

### To test the read zone

1. Ensure that the MPRX-FH is in data mode.
2. With the MPRX-FH running, place one tag behind your back while you hold another tag in the new read zone. If a valid read, the data from the tag held in the read zone displays on the PC screen.

3. Switch tags, placing the other tag behind your back and holding the first tag in the read zone. If a valid read, the data from this tag held in the read zone displays on the PC screen. If both tags are read, you have successfully adjusted the read range.
4. If one or both tags did not read, follow the suggestions in [“Verifying Tag Read Capability” on page 6–87](#).

## Fine-tuning the Read Zone by Adjusting Sensitivity Range

The MPRX-FH read zone can be fine-tuned by using **#645NN** for SeGo protocol tag read mode to reprogram the RF sensitivity range. Sensitivity range adjustments have less impact on the read pattern than RF power adjustment, thus RF power adjustment should be used as the main read pattern adjustment tool. Sensitivity range control may be helpful in stopping some tag reads on the very edges of the read pattern. To produce a noticeable change in the read pattern, you must decrease the range sensitivity by more than one increment.

### To adjust the read zone by adjusting sensitivity range

1. Ensure that your PC is communicating with the MPRX-FH using a terminal emulation program as described in [“Verifying Communications” on page 6–86](#).
2. Mark the current read zone.
3. Enter Command **#01** to switch to command mode. You are prompted with **#DONE** from the reader and can now enter reader commands.
4. Enter Command **#64318** or **#64518** to decrease the range sensitivity seven increments below the maximum (default). Press ENTER.

**Note:** *In the Command **#645NN**, NN can be any hexadecimal value from 00 to 1F. The reader’s receiver becomes less sensitive to tag signals as the value of NN is lowered from the maximum sensitivity of 1F to the minimum sensitivity of 00.*

5. Verify that the read zone has decreased by moving the tag through the desired read area. If the read zone is still too large, switch to command mode and enter the Command **#64517** to decrease the range another increment. Continue increasing the NN value until the read zone matches the desired read zone.

When the desired read zone is established, test the read zone with simulated and real traffic by performing the following procedures.

### To test the read zone

1. Ensure that the MPRX-FH is in data mode.
2. With the MPRX-FH operating, place one tag behind your back while you hold another tag in the new read zone. If a valid read, the data from the tag held in the read zone displays on the host device screen.
3. Switch tags, placing the other tag behind your back and holding the first tag in the read zone. If a valid read, the data from this tag held in the read zone displays on the host device screen.
4. If both tags are read, you have successfully adjusted the read range. If one or both tags did not read, follow the suggestions in [“Verifying Tag Read Capability” on page 6–87](#).

# Chapter 7 Troubleshooting and Maintenance

## Error Messages

The MPRX-FH transmits an error message if a command received from the host is not a recognized command or if information supplied with the command is incorrect. The reader sends this message to diagnostic commands if the reader fails the specified test.

Table 28 contains a list of error messages.

**Table 28 Error Messages**

Error Message	Description	Corrective Action
Error06	NVRAM parameters have been lost. The MPRX-FH will not function properly because the RF section is shut off until the frequency is reset.	Reset the reader
Error07	The RF phase locked loop (PLL) has lost lock and is unable to operate at its intended frequency. RF output is disabled while the MPRX-FH attempts to reset the PLL.	Reset the RF frequency. Refer to “ <a href="#">Radio Frequency</a> ” on page 6–90 for instructions.
Error08	The RF PLL has successfully regained lock and has been reset to its proper operating frequency. The RF section is returned to its state prior to losing lock (enabled/ disabled). <b>#Error08</b> will only be issued after <b>#Error07</b> has been issued.	No action necessary; the previous error has been corrected.
ErrorRF1	Warning message that the RF board did not return an update acknowledge signal	If the reader indicates a single <b>#ErrorRF1</b> event and recovers from the error, no corrective action is required. You may want to track this error message if it should occur again. If the reader indicates repeated <b>#ErrorRF1</b> warning messages then return the reader to the factory.
ErrorRF2	Warning message that the RF module did not return an INIT DONE signal	If the reader indicates a single <b>#ErrorRF2</b> event and recovers from the error, no corrective action is required. You may want to track this error message if it should occur again. If the reader indicates repeated <b>#ErrorRF2</b> warning messages then return the reader to the factory.



Table 28 Error Messages

Error Message	Description	Corrective Action
ErrorRF3	Warning message of unexpected status read, including status byte, from RF module	If the reader indicates a single <b>#ErrorRF3</b> event and recovers from the error, no corrective action is required. You may want to track this error message if it should occur again. If the reader indicates repeated <b>#ErrorRF3</b> warning messages then return the reader to the factory.

## Troubleshooting

If you contact TransCore Technical Support, use the symptom number in [Table 29](#) to reference the problem that you are having with the MPRX-FH. Should problems continue, contact TransCore for return and replacement procedures.

Table 29 Symptoms and Remedies

Symptom Number <sup>a</sup>	Symptom	Remedy
1	When performing a quick test of the MPRX-FH, the buzz box does not buzz.	<p>Check all wiring connections and antenna connections and ensure that the buzz box is functioning.</p> <p>The wires from the MPRX-FH are grouped in pairs. You may find more than one red wire, more than one black wire, and so on. Be sure to connect the correct red and white wire pair to the leads from the battery.</p> <p>Verify that RF is on. Using a terminal emulation program, you may switch to command mode and issue command <b>#527</b> to determine RF status. <b>“527 Display RF Status”</b> on page 5–69 for more information.</p>
2	The baud rate is selected correctly but nothing happens.	The MPRX-FH is not communicating with your host device. Check the power supply to your host device, and check the connections between the host device and the MPRX-FH. Try reversing the receive and transmit connections. Also, check the position of the Interface Selection Switch.

Table 29 Symptoms and Remedies

Symptom Number <sup>a</sup>	Symptom	Remedy
3	When testing the MPRX-FH, all the wires are connected correctly but the unit does not respond.	<p>The MPRX-FH may not have the software loaded inside the unit. Contact Technical Support.</p> <p>If you are using a terminal emulation program, check that the terminal emulation setting on the MPRX-FH is VT100.</p> <p>Check that the MPRX-FH communication cable is connected to the correct COM port.</p> <p>Verify that the external antenna is connected correctly.</p> <p>Also, check the position of the Interface Selection Switch.</p>
4	Strange signal responses come from the MPRX-FH when tested with the PC.	<p>Ensure that the reader is in the correct interface mode for the test tag.</p> <p>Check the system defaults using a terminal emulation program. Both PC and reader should be set to 9600 baud, 8 bits, 1 stop bit, and no parity.</p>
5	Nothing happens when the test tag is passed in front of the MPRX-FH RF antenna.	<p>Ensure that the MPRX-FH is powered on</p> <p>Verify that the reader is set to RF ON (#6401). Verify that the antenna is connected correctly.</p>
6	The MPRX-FH came from another site and does not work the way the factory defaults indicate that it should.	<p>Different commands may have been used to support the other site's specific configuration. You can restore the factory defaults by using a terminal emulation program to switch to command mode and issuing command <b>#66F</b> Load Default Operating Parameters. All factory defaults except RF frequency will be restored.</p>
7	<p>When connected to a PC that is running terminal communications software, a just-powered up MPRX-FH displays one of the following messages:</p> <p><b>#Model E4 Series</b>  <b>X.XX SNSSSSSS</b>  <b>#[Copyright notice]</b></p>	<p>The MPRX-FH works. The software is now loaded. <b>SSSSSS</b> is the TransCore-assigned serial number for this MPRX-FH. However, if <b>SSSSSS = 000000</b>, a serial number has never been assigned. If a serial number has not been assigned to your MPRX-FH, contact TransCore Technical Support.</p>

Table 29 Symptoms and Remedies

Symptom Number <sup>a</sup>	Symptom	Remedy
8	The read zone is too small, even before the RF power and range control have been adjusted.	<p>If another MPRX-FH is in the same area, ensure that it is operating on another frequency that is at least 2 MHz different.</p> <p>Check for possible interference from another nearby RF source: fluorescent lights, neon signs, high voltage power lines, nearby cellular telephone, or radio stations. Lights will need to be removed or shielded. Point the external antenna in a different direction to see if interference comes from only one direction. You may require a different MPRX-FH that uses another frequency.</p> <p>Verify that the RF power is set to an appropriate value. Verify that the range adjustment is set to the maximum. Verify that the reader is getting the correct supply voltages. Refer to <a href="#">“527 Display RF Status” on page 5–69</a>.</p>
9	The perimeter of the read zone has been defined, but there is a “hollow” spot in the center of the zone that does not read tags.	<p>The angle of the external antenna may need adjustment. Slightly tilt the external antenna to a different angle to change either the length or width of the read zone.</p> <p>Check the range control adjustment. Refer to <a href="#">“Radio Frequency” on page 6–90</a>.</p>
10	The MPRX-FH is reading tags out of the desired read zone.	<p>Some interference from other RF or electrical sources may be occurring.</p> <p>Verify that the read zone has been properly set up. Refer to <a href="#">“Fine-Tuning and Verifying the Read Zone” on page 6–93</a>.</p>

<sup>a</sup> Use this number to reference the problem you are having with the MPRX-FH-FH if you contact Transcore for Technical Support.

## MPRX-FH Repair

The MPRX is designed for whole-unit replacement and is manufactured with surface-mounted components. It requires sophisticated testing and repair equipment. All testing and repairs are performed at TransCore’s factory. Please contact TransCore to obtain a Return Materials Authorization (RMA) for returning the reader.

## Technical Support

Authorized dealers and distributors are responsible for the direct support of all customers. Authorized dealers and distributors needing support can contact TransCore Technical Support. Please be prepared to answer a series of questions that are designed to direct you to the best TransCore support resource available. These questions will relate to symptoms, configuration, model, and tags used.

**Note:** *End users and facility operators contacting Technical Support will be referred to the dealer responsible for the system sale.*

# Chapter 8 AT5720 Check Tag-to-MPRX-FH

## Required Supplies

### Check Tag Kit (TransCore P/N 19114-00)

Before assembling the check tag antenna kit, make sure you have the necessary supplies and tools for this task.

You need the following additional materials and/or tools to complete the installation.

- AT5720 Check Tag(s)
- Wire stripper
- Multiprotocol Reader Extreme

Figure 24 shows the check tag pinouts.

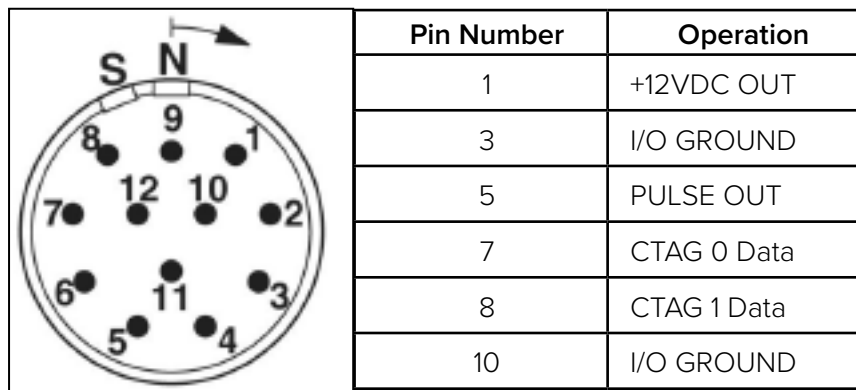

Figure 24 Sense CTAG Pinouts

## To assemble the kit for two check tags

1. Strip the cable insulation to expose the three check tag wires. Strip wire insulation approximately 1/4 inches to expose bare wire.

For Check Tag 0, connect wires as listed in Table 30.

Table 30 Check Tag 0 Wire Assignments

Wire	Color	Pin No.
Ground	Blue	3
Power	Brown	1
Data	Gray	7

2. If connecting two check tags, connect wires as listed in Table 31.

**Table 31 Check Tag 1 Wire Assignments**

<b>Pin Number</b>	<b>Operation</b>
1	+12VDC OUT
3	I/O GROUND
5	PULSE OUT
7	CTAG 0 Data
8	CTAG 1 Data
10	I/O GROUND

# Appendix A Glossary

<b>AC</b>	Alternating current
<b>ACK</b>	Acknowledge (data valid)
<b>ANSI</b>	American National Standards Institute
<b>antenna</b>	Passive device that converts RF energy into magnetic energy (RF signal)
<b>ASCII</b>	American Standard Code for Information Interchange
<b>ASIC</b>	Application-specific integrated circuit
<b>aux</b>	Auxiliary
<b>AWG</b>	AWG (American Wire Gauge) is a U.S. standard set of non-ferrous wire conductor sizes
<b>backscatter</b>	Portion of an RF signal that is modulated by a tag and radiated back to the reader
<b>baud</b>	Measure of number of bits per second of a digital signal; for example, 9600 baud = 9600 bits per second
<b>BCKS</b>	Boot checksum
<b>BCM</b>	Buffer control mode
<b>bps</b>	Bits per second
<b>byte</b>	A binary character; for example, one 8-bit ASCII character
<b>check tag</b>	Tag mounted inside a reader assembly, inside or in close proximity to an external antenna that is used to check operation of the reader
<b>cmd</b>	Command
<b>comm</b>	Communications
<b>command</b>	Data set that is recognized by the receiving device as intending to elicit a specific response

<b>conduit</b>	Flexible steel pipe use for electrical wiring
<b>cps</b>	Characters per second
<b>CR</b>	Carriage return
<b>CRC</b>	Cyclic redundancy check
<b>CTRL</b>	Control
<b>CTS</b>	Clear to send
<b>data</b>	Information that is processed by a computing device
<b>DC</b>	Direct current
<b>DIAG</b>	Diagnostic
<b>ECP</b>	Error correcting protocol
<b>ECPS</b>	Error correcting protocol status
<b>eGo®</b>	Proprietary name for ANSI NCITS 256-2001 and ISO 18000-6B compliant TransCore products. A registered trademark of TC License, Ltd.
<b>eol</b>	End of line
<b>eom</b>	End of message
<b>EPROM</b>	Erasable programmable read-only memory
<b>field</b>	Physical area/space in which a tag can be read by the reader; also, an element of a data record/frame. For example, division within a tag's data frame.
<b>frames</b>	Consecutive bits of data in memory that are read and written as a group
<b>frequency bands</b>	A range of RF frequencies assigned for transmission by an RF device
<b>hex</b>	Hexadecimal
<b>hexadecimal</b>	Base 16 numbering system that uses the characters 0 though 9 and A through F to resent the digits 0 through 16

<b>host</b>	Device, generally a computer, that is connected to the Multiprotocol Reader Extreme through the communications port
<b>I/O or IO circuits</b>	Input/output circuits
<b>ID</b>	Identification; encoded information unique to a particular tag
<b>NCITS</b>	American National Standards Institute International Committee for Information Technology standards
<b>interface</b>	Connection point for communication with another device
<b>IOST</b>	I/O status
<b>ISO</b>	International Standardization Organization
<b>ISO/IEC 18000-63</b>	Information technology. Radio frequency identification for item management Part 63: Parameters for air interface communications at 860 MHz to 960 MHz Type C
<b>LF</b>	Line feed
<b>m</b>	Meter
<b>MHz</b>	Megahertz
<b>mode</b>	Method of operation
<b>MPRX-FH</b>	Multiprotocol Reader Extreme-Frequency Hopper
<b>ms</b>	Millisecond(s)
<b>NAK</b>	Negative acknowledgment (data not valid)
<b>passback</b>	Used to refer to a tag ID that is not passed on to the tag buffer
<b>PC</b>	Personal computer
<b>PCKS</b>	EPROM flash checksum
<b>protocol</b>	Specified convention for the format of data messages communicated between devices
<b>PRST</b>	Presence status



<b>PWRB</b>	Power fail bit
<b>RAM</b>	Random access memory
<b>RDID</b>	Reader ID
<b>read</b>	Process of acquiring data from a device; for example, from a tag or from computer memory
<b>reader</b>	Controlled interrogating device capable of acquiring data from a device; for example, acquiring and interrupting data from a tag
<b>read zone</b>	The physical area in which a tag can be read by the reader
<b>RF</b>	Radio frequency
<b>RFID</b>	Radio frequency identification
<b>RFST</b>	RF status
<b>ROM</b>	Read-only memory
<b>RTC</b>	Real-time clock
<b>RTS</b>	Request-to-send
<b>SCTS</b>	Status of check tag status
<b>SeGo</b>	Super eGo (SeGo) is a superset of the eGo protocol
<b>SN</b>	Serial number
<b>som</b>	Start of message
<b>SSTC</b>	Input status change reporting options
<b>tag</b>	Small self-contained device acting as an identifying transponder
<b>TT</b>	Tag translation
<b>V</b>	Volts

**Ver** Version (software)

**write** Process of recording data; for example, writing to computer memory or to a tag's memory. Writing writes over (erases) previous data stored at the specified memory locations.

**XON/XOFF** Protocol for controlling the flow of data between computers and other devices on an asynchronous serial connection. X/ON and X/OFF are signals to turn a transmitter on or off. The actual signal for X/ON is the same bit configuration as the ASCII Ctrl-Q keyboard combination (11 hexadecimal). The X/OFF signal is the Ctrl-S character (13 hexadecimal).

# Appendix B Technical Specifications

## Reader Specifications

---

### Communications

<b>Frequency Selection</b>	902 to 928 MHz <sup>a</sup>
<b>Reading Range</b>	Read performance varies depending on tag, reader, and external antenna configuration and environment. Typical read range should be 12 to 17 ft (3.7 to 5.2 m). <sup>b</sup>

- a. This device complies with FCC Part 15.247 and with RSS-247 which limits the frequency usage to 902-928MHz.
- b. Reading range depends on reader or external antenna configuration, tag type, tag read mode, and operating environment.

### Hardware Features

<b>Integrated system with connectors for external antennas</b>	RF module, tag decoder, power supply, I/O ports, and serial communications interface all housed in a single package.
<b>Case</b>	Aluminum (Allodyne)

### Power Requirements

<b>Input Voltage</b>	20VAC and 28VDC
----------------------	-----------------

### Physical Attributes

<b>Size</b>	13 x 5 x 2.49 in. (33 x 7.62 x 6.32 cm)
<b>Weight</b>	5.9 lb (2.6 kg)

## Environmental Parameters

<b>Operating Temperature</b>	-40°F to +158°F (-40°C to +70°C)
<b>Humidity</b>	99% condensing
<b>Ingress Protection</b>	IP65/IP67 Rated, with appropriate connectors.
<b>Vibration Tolerance</b>	The MPRX complies with vibration tolerance limits specified in AREMA C&S Manual, Part 11.5.1, Class C
<b>Operation Shock Tolerance</b>	The MPRX complies with shock tolerance limits specified in AREMA C&S Manual, Part 11.5.1, Class C

## Reader Dimensions

Figure 25 illustrates the exterior dimensions of the MPRX case.

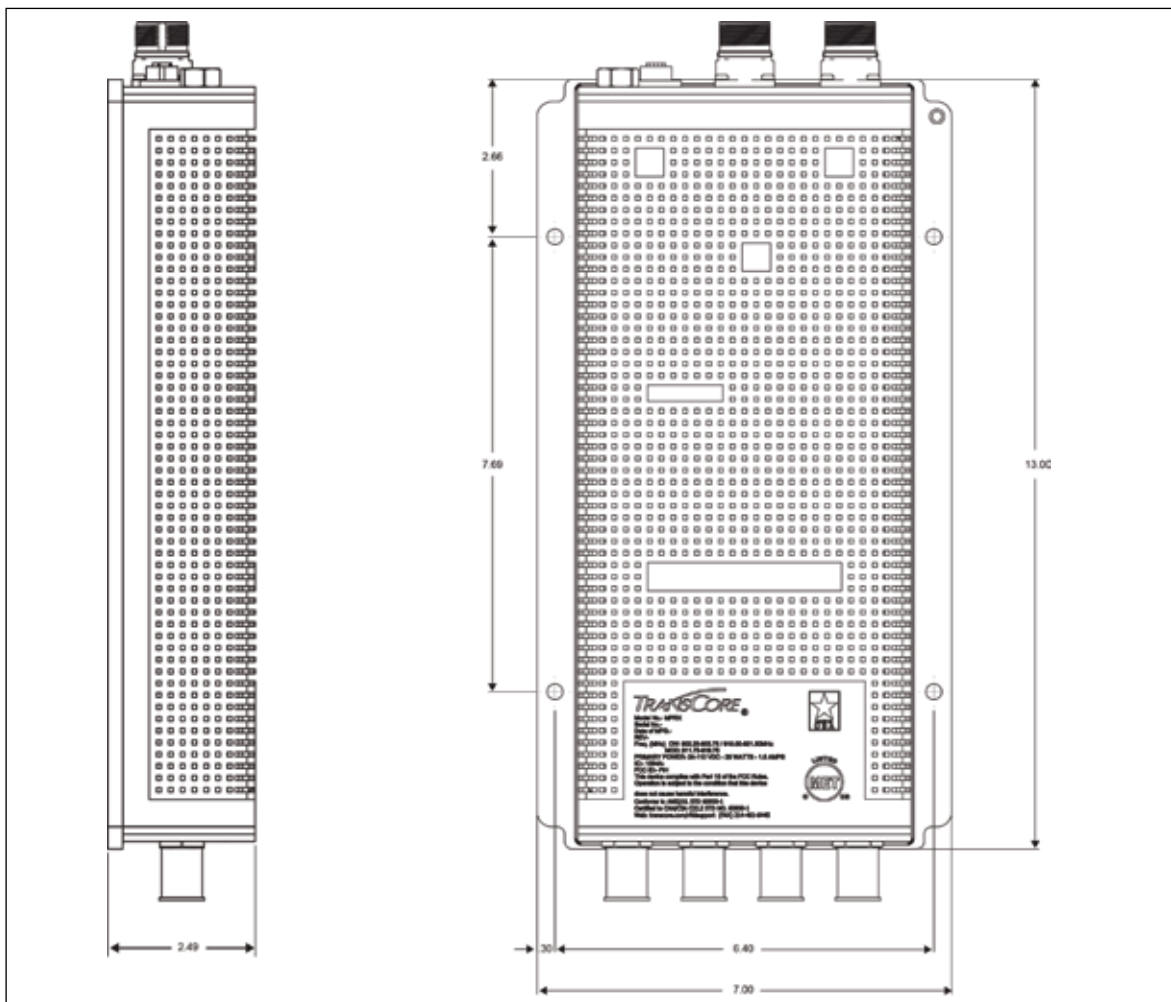

Figure 25 MPRX Exterior Case Dimensions

Figure 26 illustrates the end panel dimensions of the MPRX with antenna ports.

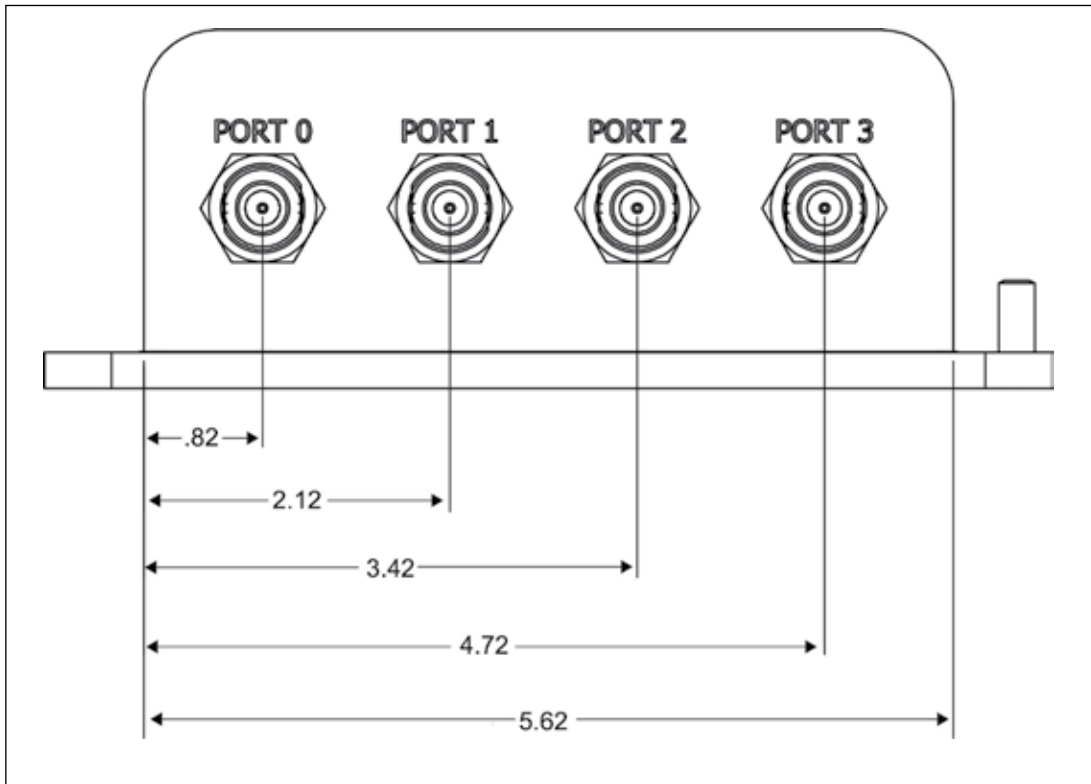

Figure 26 MPRX End Panel Dimensions with Antenna Ports

Figure 27 illustrates the end panel dimensions of the MPRX with communication connectors.

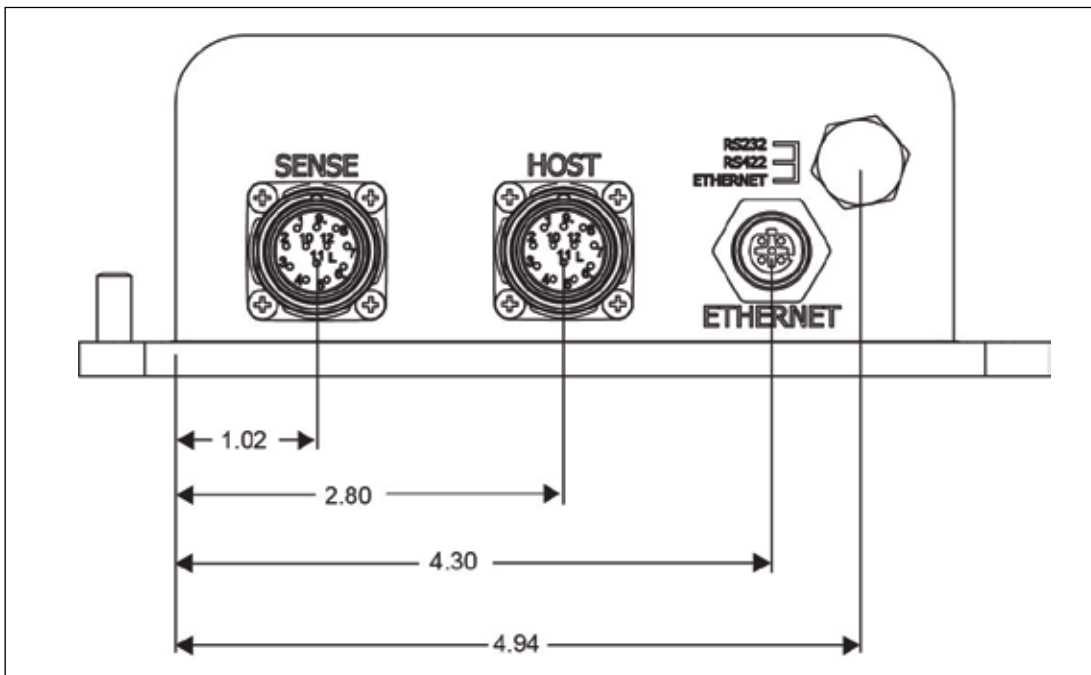

Figure 27 MPRX End Panel Dimensions with Communication Connectors

# Appendix C Wiring Information

## Communications Interfaces

Table 32 lists the MPRX Host Communications Cable Pin Designations. For TransCore part numbers, refer to “Pretest Accessory Options” on page 2–26.

Table 33 lists the interfaces available with the MPRX.

**Table 32 MPRX Host Communications Cable Pin Designations**

HOST CABLE			
PAIR	COLOR	PIN NUMBER	NAME
1	black or gray	12	VIN RTN
	red	11	VIN
2	black or gray	9	COM GND (RS232)
	white	1	RS232 TX
3	black or gray	10	COM GND (RS422)
	green	2	RS232 RX
4	black or gray	3	LOCK
	blue	4	LOCK RTN
5	black or gray	6	RS422 TX -
	brown	5	RS422 TX +
6	black or gray	8	RS422 RX -
	yellow	7	RS422 RX +

**Table 33 Communications Interfaces and Conductor Requirements**

Interface	Number of Conductors
RS-232	3
RS-422	5
Ethernet	4

Table 34 lists the MPRX Sense Communications Cable Pin Designations. For TransCore part numbers, refer to “Pretest Accessory Options” on page 2–26.

**Table 34 MPRX SENSE Communications Cable Pin Designations**

SENSE CABLE			
PAIR	COLOR	PIN NUMBER	NAME
1	black or gray	3	I/O GND
	red	1	12VDC OUT (CTG)
2	black or gray	6	OUT 0
	white	2	OUT 1
3	black or gray	7	CTAG 0
	green	8	CTAG 1
4	black or gray	4	I/O GND
	blue	5	PULSE OUT
5	black or gray	10	I/O GND
	brown	12	SENSE 0
6	black or gray	9	I/O GND
	yellow	11	SENSE 1

Table 35 lists the MPRX Ethernet wiring pin designations.

**Table 35 Ethernet Pin Designations**

Pin Number	Operation
1	Receive +
2	Transmit +
3	Receive -
4	Transmit -

# Appendix D Command Quick Reference

## Command Syntax

The command numbers consist of from 2 to 4 hex digits. The letters N or S may follow a command number. The letter N indicates that part of the command number is variable. The letter S indicates the requirement for an alphanumeric data string that is to be included immediately following the command number. Hex digits (0–9, A–F) in either uppercase or lowercase characters may be used in data strings and for hex digits A–F. For more information refer to “[General Software Information](#)” on page 3–39.

[Table 36](#) lists factory default settings. [Table 37](#) lists, in numerical order, all of the commands available to users. [Table 38](#) lists the same commands by command name.

## Factory Default Settings

[Table 36](#) lists the factory default settings for the MPRX-FH.

**Table 36 MPRX-FH Default Configuration Settings**

Parameter	Setting	Command
Operating mode	Data	00
Baud rate	9600	1005
Stop bits	1	1010
Parity	None	1020
Time and data appended	Enabled	302
Auxiliary information appended	Disabled	310
Unique ID code criteria	Separation of 1 ID	4100
Valid ID code criteria	Acquisition of 1 ID	4200
Uniqueness time-out	2 minutes	441
Multi-tag sort	Disabled	454
SeGo protocol tag initialization during multi-tag sort	Enabled	456
Reader ID number	00	6000
Communications protocol	Basic	610
Error correcting protocol (ECP) timeout	12.7 sec	612FE
Software Flow control	Software (XON/XOFF)	6141
Echo mode	Enabled	6171
RF-by-input control	Enabled	641



Table 36 MPRX-FH Default Configuration Settings

Parameter	Setting	Command
RF attenuation	Full power	64400
SeGo protocol operating range (distance)	Maximum	6451F
Presence without tag reports	Disabled	6900
RF-off control	Timeout or no presence	6922
RF timeout	Never true	693F
Input inversion	Disabled	6940
Serial number	SSSSSS	695
Store hardware configuration	Hardware configuration not known	696
Automatic periodic RF status report	Disabled	830

## Numerical Command List

The following conventions are used in [Table 37](#).

Items in **bold** identify factory default settings.

Only the command-related data portion of the reader message is shown.

Refer to “[Chapter 5 Commands](#)” on page 5–57 for the complete syntax of commands and messages.

Table 37 MPRX-FH Commands Listed Numerically

Number	Command Name	Reader Message
<b>00</b>	<b>Switch to data mode (default)</b>	<b>#Done</b>
01	Switch to command mode	#Done
100N	Select Baud Rate	#Done
1002	Set baud rate = 1200 baud	#Done
1003	Set baud rate = 2400 baud	#Done
1004	Set baud rate = 4800 baud	#Done
<b>1005</b>	<b>Set baud rate = 9600 baud (default)</b>	<b>#Done</b>
1006	Set baud rate = 19.2 K baud	#Done
1007	Set baud rate = 38.4 K baud	#Done
<b>1010</b>	<b>Use one stop bit (default)</b>	<b>#Done</b>

Table 37 MPRX-FH Commands Listed Numerically

Number	Command Name	Reader Message
1011	Use two stop bits	#Done
<b>1020</b>	<b>Disable parity (default)</b>	<b>#Done</b>
1021	Select even parity	#Done
1022	Select odd parity	#Done
20	Set time	#Done
21	Set date	#Done
22	Display time and date	Time and date
300	No time and date appended	#Done
<b>302</b>	<b>Time and date appended (default)</b>	<b>#Done</b>
<b>310</b>	<b>Disable aux info append (default)</b>	<b>#Done</b>
311	Enable aux info append	#Done
322	Disable TID data append	0 / 1
323	Enable TID data append	0 / 1
40	Transmit all IDs	#Done
<b>4100</b>	<b>Select one ID separation (default)</b>	<b>#Done</b>
4101	Select two ID separation	#Done
4102	Select three ID separation	#Done
4103	Select four ID separation	#Done
<b>4200</b>	<b>Select 1 valid ID code (default)</b>	<b>#Done</b>
4201	Select 2 valid ID codes	#Done
4202	Select 3 valid ID codes	#Done
4203	Select 4 valid ID codes	#Done
440	Reset uniqueness	#Done
<b>441</b>	<b>Set uniqueness time-out to 2 minutes (default)</b>	<b>#Done</b>
442	Set uniqueness time-out to 15 seconds	#Done
443	Set uniqueness time-out to 30 seconds	#Done

Table 37 MPRX-FH Commands Listed Numerically

Number	Command Name	Reader Message
<b>454</b>	<b>Disable multi-tag sort</b>	<b>#Done</b>
455	Enable multi-tag sort	<b>#Done</b>
<b>456</b>	<b>Enable SeGo protocol tag initialization during multi-tag sort (default)</b>	<b>#Done</b>
457	Disable SeGo protocol tag initialization during multi-tag sort	<b>#Done</b>
484	Disable SeGo	<b>#Done</b> if MPRX-FH model supports this tag protocol. <b>#Error</b> if tag protocol is unsupported.
485	Enable SeGo	<b>#Done</b> if MPRX-FH model supports this tag protocol. <b>#Error</b> if tag protocol is unsupported.
505	Display version	<b>Model [model] Ver [version no.] SN [serial no.]</b>
506	Display hardware configuration information	1-20 character ASCII string
520	Display power fail bit	<b>PWRB P&lt;0 to 1&gt; R0</b>
521	Display reader ID number	<b>RDID xx</b>
522	Display comm port parameters	<b>MAIN B&lt;2 to 7&gt; S&lt;0 to 1&gt; P&lt;0 to 2&gt; D0</b>
524	Display appended info status	<b>IDAP T&lt;0 to 1&gt; D&lt;0 to 1&gt; X&lt;0 to 1&gt;</b>
525	Display comm protocol	<b>ECPS P&lt;0 to 2&gt; T&lt;01 to FF&gt; X&lt;0 to 2&gt; S0</b>
527	Display RF status	<b>RFST C&lt;0 to 1&gt; O&lt;0 to 1&gt; T&lt;1 to 3&gt; Fxxx Rxx Gxx Axx Ixx</b>
529	Display presence input status	<b>PRST P&lt;0 to 1&gt; D0 A&lt;0 to 2&gt; T&lt;0 to F&gt; I&lt;0 to 1&gt;</b>
530	Display RF0 filter status	<b>RF0S U&lt;0 to 4&gt; V&lt;0 to 3&gt;</b>
537	Display echo status	<b>ECHO &lt;0 to 1&gt;</b>
540	Display flash checksum	<b>PCKS I0000 Exxxx</b>
543	Display boot checksum	<b>BCKS xxxx</b>
549	Get user-programmable group select equals (GSE) filter data	The response data is formatted similar to the data in the configuration command.

Table 37 MPRX-FH Commands Listed Numerically

Number	Command Name	Reader Message
552	Display Antenna Multiplexing Mode	MUX x<0 to 3> <MPRX-FH>
560	Request Sensor Status Change	SSTC E<0 to 1> M<0 to 3>
570	Display operating mode status	eGo:<I,D> SeGo:<I,D> IAG:<E,D> Sort:<E,D>
577	Report buffered handshakes	HDSH C0 <ww> C1 <xx> C2 <yy> C3 <zz>
60NN	Set reader ID number NN = 00–FF ( <b>00 = factory default</b> )	#Done
<b>610</b>	<b>Select basic protocol (default)</b>	<b>#Done</b>
611	Select ECP protocol	#Done
612NN	Set ECP timeout	#Done
<b>612FE</b>	<b>Set ECP timeout = 12.7 sec</b>	<b>#Done</b>
612FF	Disables ECP timeout	#Done
613	Enable data inquiry protocol	#Done
6140	Disable flow control	#Done
<b>6141</b>	<b>Enable software flow control (default)</b>	<b>#Done</b>
6170	Disable echo mode	#Done
<b>6171</b>	<b>Enable echo mode (default)</b>	<b>#Done</b>
63	Reset reader	Model [model] Ver [version no.] SN [serial no.] Copyright [date] TransCore
6400	Turn off RF	#Done
6401	Turn on RF	#Done
<b>641</b>	<b>Select RF-by-input control (default)</b>	<b>#Done</b>
644NN	Set RF attenuation NN = 00 to 0A	#Done
645NN	Set SeGo/ECP protocol operating range (distance), NN = 00 (shortest) to 1F (longest)	#Done
65	Reset power fail bit	#Done
66F	Load default operating parameters (except RF operating frequency)	#Done if parameters loaded correctly #Error if load failed.

Table 37 MPRX-FH Commands Listed Numerically

Number	Command Name	Reader Message
<b>6900</b>	<b>Disable presence without tag reports (default)</b>	<b>#Done</b>
6901	Enable presence without tag reports	#Done
6920	Turn RF off on timeout	#Done
6921	Turn RF off on timeout/tag	#Done
<b>6922</b>	<b>Turn RF off on timeout/no presence (default)</b>	<b>#Done</b>
693N	Set RF timeout	#Done
693F	Set RF timeout = infinite	#Done
<b>6940</b>	<b>Disable input inversion (default)</b>	<b>#Done</b>
6941	Enable input inversion	#Done
<b>695S...S</b>	<b>Set serial number S...S (max 6 characters) (default)</b>	<b>#Done</b>
696S...S	Store hardware configuration string S...S = ASCII string (maximum length of 20 characters)	#Done
697	Set user-programmable group select equals (GSE) filter	#Done
698xx	Set ISO/IEC 18000-63 Tag range	#Done
<b>830</b>	<b>Disable automatic periodic RF status report (default)</b>	<b>#Done</b>
831	Enable automatic periodic RF status report	#Done
836	Disable MPRX-FH mode	#Done
837	Enable MPRX-FH mode	#Done
838	Disable ISO/IEC 18000-63 protocol	False/True
839	Enable ISO/IEC 18000-63 protocol	False/True
840	Disable ISO/IEC 18000-63 tag sort	False/True
841	Enable ISO/IEC 18000-63 tag sort	False/True
842	Disable AI1200 Emulation Mode	#Done
843	Enables the AI1200 Emulation Mode	#Done

Table 37 MPRX-FH Commands Listed Numerically

Number	Command Name	Reader Message
850	MUX RF port 0	#Done
851	MUX between RF ports 0 and 1	#Done
852	MUX between RF ports 0, 1, and 2	#Done
853	MUX between RF ports 0, 1, 2, and 3	#Done
891	MUX test mode RF port 1 only	#Done
892	MUX test mode RF port 2 only	#Done
893	MUX test mode RF port 3 only	#Done

## Alphabetical Command List

---

The following conventions are used in Table 38:

Items in **bold** identify factory default settings.

Only the command-related data portion of the reader message is shown.

Refer to “Commands” on page 5–57 for the complete syntax of commands and messages.

Table 38 MPRX-FH Commands Listed Alphabetically

Command Name	Number	Reader Message
Disable AI1200 Emulation Mode	842	#Done
<b>Disable automatic periodic RF status report (default)</b>	<b>830</b>	<b>#Done</b>
<b>Disable aux info append (default)</b>	<b>310</b>	<b>#Done</b>
Disable echo mode	6170	#Done
Disable ISO/IEC 18000-63 protocol	838	False/True
Disable ISO/IEC 18000-63 tag sort	840	False/True
Disable flow control	6140	#Done
<b>Disable input inversion (default)</b>	<b>6940</b>	<b>#Done</b>
Disable MPRX-FH mode	836	#Done
<b>Disable multi-tag sort (default)</b>	<b>454</b>	<b>#Done</b>
<b>Disable parity (default)</b>	<b>1020</b>	<b>#Done</b>

Table 38 MPRX-FH Commands Listed Alphabetically

Command Name	Number	Reader Message
<b>Disable presence without tag reports (default)</b>	<b>6900</b>	<b>#Done</b>
Disable SeGo	484	#Done if MPRX-FH model supports this tag protocol. #Error if tag protocol is unsupported.
Disable SeGo protocol tag initialization during multi-tag sort	457	#Done
Disable TID data append	322	0/1
Disables ECP timeout	612FF	#Done
Display Antenna Multiplexing Mode	552	MUX x<0 to 3> <MPRX-FH>
Display appended info status	524	IDAP T<0 to 1> D<0 to 1> X<0 to 1>
Display boot checksum	543	BCKS xxxx
Display comm port parameters	522	MAIN B<2 to 7> S<0 to 1> P<0 to 2> D0
Display comm protocol	525	ECPS P<0 to 2> T<01 to FF> X<0 to 2> S0
Display echo status	537	ECHO <0 to 1>
Display flash checksum	540	PCKS I0000 Exxxx
Display hardware configuration information	506	1-20 character ASCII string
Display operating mode status	570	eGo:<I,D> SeGo:<I,D> IAG:<E,D> Sort:<E,D>
Display power fail bit	520	PWRB P<0 to 1> R0
Display presence input status	529	PRST P<0 to 1> D0 A<0 to 2> T<0 to F> I<0 to 1>
Display reader ID number	521	RDID xx
Display RF status	527	RFST C<0 to 1> O<0 to 1> T<1 to 3> Fxxx Rxx Gxx Axx Ixx
Display RFO filter status	530	RF0S U<0 to 4> V<0 to 3>
Display time and date	22	Time and date

Table 38 MPRX-FH Commands Listed Alphabetically

Command Name	Number	Reader Message
Display version	505	Model [model] Ver [version no.] SN [serial no.]
Enable automatic periodic RF status report	831	#Done
Enable aux info append	311	#Done
Enable data inquiry protocol	613	#Done
<b>Enable echo mode (default)</b>	<b>6171</b>	<b>#Done</b>
Enable ISO/IEC 18000-63 protocol	839	False/True
Enable ISO/IEC 18000-63 tag sort	841	False/True
Enable input inversion	6941	#Done
Enable MPRX-FH mode	837	#Done
Enable multi-tag sort	455	#Done
Enable presence without tag reports	6901	#Done
Enable SeGo	485	#Done if MPRX-FH model supports this tag protocol. #Error if tag protocol is unsupported.
<b>Enable SeGo protocol tag initialization during multi-tag sort (default)</b>	<b>456</b>	<b>#Done</b>
<b>Enable software flow control (default)</b>	<b>6141</b>	<b>#Done</b>
Enable TID data append	323	0/1
Enables the AI1200 Emulation Mode	843	#Done
Get user-programmable group select equals (GSE) filter data	549	The response data is formatted similar to the data in the configuration command.
Load default operating parameters (except RF operating frequency)	66F	#Done if parameters loaded correctly #Error if load failed.
MUX between RF ports 0 and 1	851	#Done
MUX between RF ports 0, 1, 2, and 3	853	#Done
MUX between RF ports 0, 1, and 2	852	#Done



Table 38 MPRX-FH Commands Listed Alphabetically

Command Name	Number	Reader Message
MUX RF port 0	850	#Done
MUX test mode RF port 1 only	891	#Done
MUX test mode RF port 2 only	892	#Done
MUX test mode RF port 3 only	893	#Done
No time and date appended	300	#Done
Report buffered handshakes	577	HDSH C0 <ww> C1 <xx> C2 <yy> C3 <zz>
Request Sensor Status Change	560	SSTC E<0 to 1> M<0 to 3>
Reset power fail bit	65	#Done
Reset reader	63	Model [model] Ver [version no.] SN [serial no.] Copyright [date] TransCore
Reset uniqueness	440	#Done
<b>Select 1 valid ID code (default)</b>	<b>4200</b>	<b>#Done</b>
Select 2 valid ID codes	4201	#Done
Select 3 valid ID codes	4202	#Done
Select 4 valid ID codes	4203	#Done
<b>Select basic protocol</b>	<b>610</b>	<b>#Done</b>
Select Baud Rate	100N	#Done
Select ECP protocol	611	#Done
Select even parity	1021	#Done
Select four ID separation	4103	#Done
Select odd parity	1022	#Done
<b>Select one ID separation (default)</b>	<b>4100</b>	<b>#Done</b>
<b>Select RF-by-input control (default)</b>	<b>641</b>	<b>#Done</b>
Select three ID separation	4102	#Done

Table 38 MPRX-FH Commands Listed Alphabetically

Command Name	Number	Reader Message
Select two ID separation	4101	#Done
Set baud rate = 1200 baud	1002	#Done
Set baud rate = 19.2 K baud	1006	#Done
Set baud rate = 2400 baud	1003	#Done
Set baud rate = 38.4 K baud	1007	#Done
Set baud rate = 4800 baud	1004	#Done
<b>Set baud rate = 9600 baud (default)</b>	<b>1005</b>	<b>#Done</b>
Set date	21	#Done
Set ECP timeout	612NN	#Done
<b>Set ECP timeout = 12.7 sec</b>	<b>612FE</b>	<b>#Done</b>
Set ISO/IEC 18000-63 Tag range	698xx	#Done
Set reader ID number NN = 00–FF ( <b>00 = factory default</b> )	60NN	#Done
Set RF attenuation NN = 00 to 0A	644NN	#Done
Set RF timeout = infinite	693F	#Done
Set RF timeout N = 0–F	693N	#Done
Set SeGo/ECP protocol operating range (distance), NN = 00 (shortest) to 1F (longest)	645NN	#Done
<b>Set serial number S...S = (max 6 characters) (default)</b>	<b>695S...S</b>	<b>#Done</b>
Set time	20	#Done
Set uniqueness time-out to 15 seconds	442	#Done
<b>Set uniqueness time-out to 2 minutes (default)</b>	<b>441</b>	<b>#Done</b>
Set uniqueness time-out to 30 seconds	443	#Done
Set user-programmable group select equals (GSE) filter	697	#Done
Store hardware configuration string S...S = ASCII string (maximum length of 20 characters)	696S...S	#Done

Table 38 MPRX-FH Commands Listed Alphabetically

Command Name	Number	Reader Message
Switch to command mode	1	#Done
<b>Switch to data mode (default)</b>	<b>0</b>	<b>#Done</b>
<b>Time and date appended (default)</b>	<b>302</b>	<b>#Done</b>
Transmit all IDs	40	#Done
Turn off RF	6400	#Done
Turn on RF	6401	#Done
Turn RF off on timeout	6920	#Done
<b>Turn RF off on timeout/no presence (default)</b>	<b>6922</b>	<b>#Done</b>
Turn RF off on timeout/tag	6921	#Done
<b>Use one stop bit (default)</b>	<b>1010</b>	<b>#Done</b>
Use two stop bits	1011	#Done

# Appendix E Compatible Tag Information

## Tag Configurations

Table 39 lists the TransCore Super eGo<sup>®</sup> (SeGo) protocol tags that are compatible with the MPRX-FH/

**Table 39 SeGo Protocol Tags**

Tag Model Number	Tag Type	Power Source	Number of 6-bit ASCII Characters <sup>a</sup>	Number of 128-Bit Frames <sup>a</sup>	Special Features
AT5120	Rail	Beam	20	1	860 to 880 MHz frequency, chemical resistant case, metal external install
AT5118	Rail	Beam	20	1	915 MHz frequency, high-temperature chemical-resistant case, metal external install
AT5133	Transportation	Beam	20	1	915 MHz frequency, high-temperature chemical-resistant case, metal external install
AT5412	Transportation	Beam	10	1/2	915 MHz frequency, high-temperature chemical-resistant case, metal external install
AT5413	Rail	Beam	20	1	915 MHz frequency, high-temperature chemical-resistant case, metal external install
AT5414	Transportation	8-year battery	10	1/2	Multifrequency, high-temperature chemical-resistant case, metal external install
AT5415	Transportation	Beam	10	1/2	915 MHz frequency, high-temperature chemical-resistant case, metal external install
AT5549	Rail	10-year battery	20	1	915 MHz frequency; water-resistant, metal external install
AT5910	Transportation	8-year battery	20	1	Multifrequency, high-temperature chemical-resistant case, metal external install

<sup>a</sup> These fields apply to eATA-programmed tags only. Contact TransCore for information regarding tags programmed with these features.

## Tag Data Formats

---

Tags are programmed at the TransCore factory with the tag model number, date of manufacture, and data format. Contact TransCore for special order entry procedures for the format that applies to your system. The following tag data formats can be used:

- 10-character alphanumeric ASCII — Four alphanumeric characters are fixed and can be used to identify either the dealer or the user. The remaining six positions are numeric and should be unique for each tag issued. For example, the entry ACME000001 might be specified as the first tag on the order entry form from ACME Rail Lines.
- 20-character alphanumeric ASCII — Four alphanumeric characters are typically fixed and the remaining 16 positions are numbered sequentially.



*For more information:*

**Sales Support**  
800.923.4824

**Technical Support**  
505.856.8007

*transcore.com*



**TRANSCORE**<sup>®</sup>  
*Trusted Transportation Solutions*

© 2020 TransCore L.P. All rights reserved. TRANSCORE is a registered trademark and is used under license. All other trademarks listed are the property of their respective owners. Contents subject to change. Printed in the U.S.A.

