

Blackboard

transaction *System*

Vending Reader VR4100

Installation Guide



Blackboard

This Class B digital apparatus complies with
Canadian ICES-003

Cet appareil numérique de la classes B est conform
à la norme NMB-003 du Canada

This device complies with Part 15 of the FCC Rules. Operation is subject to the following two conditions: (1) This device may not cause harmful interference, and (2) this device must accept any interference received, including interference that may cause undesired operation.

Part 15.21: Changes or modifications not expressly approved by the party responsible for compliance could void the user's authority to operate the equipment.

NOTE: The manufacturer is not responsible for any radio or TV interference caused by unauthorized modifications to this equipment. Such modifications could void the user's authority to operate the equipment.

This equipment complies with the FCC radiation exposure limits set forth for an uncontrolled environment. End users must follow the specific operating instructions for satisfying RF exposure compliance. The antenna(s) used for this transmitter must be installed to provide a separation distance of at least 20 cm from all persons and must not be co-located or operating in conjunction with any other antenna or transmitter.

CONTENTS

1 VENDING READER VR4100 INSTALLATION GUIDE

1 Overview

4 Reader Installation

7 Reader Configuration

7 Front Panel (Touch Screen & Service Card) Configuration

8 RS-232 Configuration

9 Web Service Configuration

10 Setup

12 Monitor

14 Audit

15 Admin

17 Reader Test

18 Reader Audit

20 Reader Factory Default Settings

21 Reader Specifications

FIGURES

Figure 1:	What's included	1
Figure 2:	Setup Overview	3
Figure 3:	Vending Reader Face and Mounting Dimensions	5
Figure 4:	Multi-Drop Bus (MDB) Connections	6
Figure 5:	Configuration Screen.....	7
Figure 6:	Web Service Login Window	9
Figure 7:	Web Service Main Menu Options	9
Figure 8:	Setup Menu Options Window	10
Figure 9:	Setup Network Options Window.....	10
Figure 10:	Setup Reader Options Window	11
Figure 11:	Monitor Menu Options	12
Figure 12:	Log Detail	12
Figure 13:	Network Status	13
Figure 14:	System Status	13
Figure 15:	Status (reader status)	14
Figure 16:	Reader Audit Window.....	14
Figure 17:	Admin Options Window	15
Figure 18:	VR4100 Configuration Flowchart	16
Figure 19:	Audit Totals Main Screen.....	18
Figure 20:	Cumulative Totals Screen.....	18
Figure 21:	Interval Totals Screen.....	19

VENDING READER VR4100 INSTALLATION GUIDE

OVERVIEW

The Blackboard VR4100 Vending Reader supports both swipe and contactless card technology. The vending reader allows MDB vending machines to be used with Blackboard Transaction System (BbTS), and uses an ethernet connection to communicate to the host server. Communication of host downloads and reader transactions use a maintained Transport Layer Security (TLS) Secure Communication Channel to meet PCI Compliance.

The VR4100 Vending Reader can be used in any vending machine that complies with the National Automated Merchandising Association Multi-Drop Bus (NAMA MDB) interface specification. Many vending machines manufactured today support this interface.

A specially encoded service card is required to configure the VR4100 reader. Service cards are ordered separately.

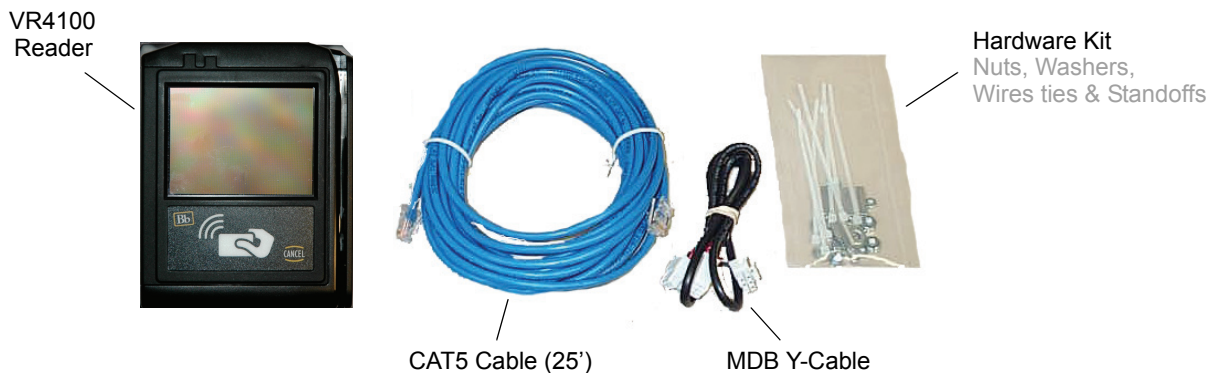

Figure 1: What's included

READER FEATURES

- The reader works with a Microsoft Windows based Transaction System
- Configuration accessible via front panel (Touch Screen), CONFIG port or Web Service
- Stores up to 2500 off-line transactions
- Allows mixed card and cash vends (if supported by machine controller software)
- Interfaces to all NAMA MDB compliant vending machines
- Mounts easily in bill acceptor or comparable sized opening
- Reduces interference problems with limited size inside machine
- Two simple connections: machine controller/coin mechanism and network
- Volume can be set to off, quiet or loud
- Front panel (Touch Screen) and Web Service access can be disabled for added security
- All IP communications encrypted and authenticated for data security
- Tracks cash sales (if supported by machine controller software)
- Displays balance, account warnings, and other messages following vend
- Wireless 802.11b/g with WPA2 security (AES-CCMP encryption, PSK authentication)

For specifications, see: [Reader Specifications](#) (Page: 21).

OBJECTIVES

After reading this guide you can:

- Install the vending reader
- Test the vending reader
- Configure the vending reader
- Reset reader factory defaults

SETUP OVERVIEW

1. Configure the reader in BbTS.

See: the *Transaction System Administration Guide*

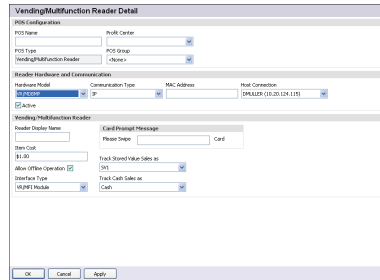

2. Reader Installation (page 1-4).

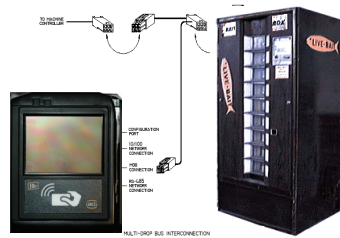

3. Reader Configuration (page 1-7).

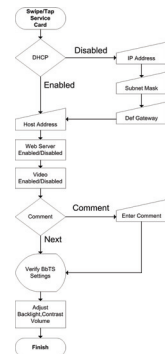

4. Reader Test (page 1-17).



Figure 2: Setup Overview

READER INSTALLATION

All wiring should be completed by a trained electronic technician.

To install the reader

- 1 Power down the vending machine.
Refer to the vending machine operation manual.
- 2 Prepare a 3.3" x 4.2" cut-out (slightly larger allows reader to fit easily), and then drill four 3/16" holes for mounting studs in the center locations of the slots.
See: the [Vending Reader Face and Mounting Dimensions](#) (page 1-5).

If replacing an existing bill acceptor, remove the bill acceptor.

If installing in a pre-cut opening, remove the filler plate.

- 3 Slide the face of the reader through the opening from the inside of the machine.
If using a mounting plate, slide it over the face of the reader from the outside of the machine.
- 4 Install four flat washers and four nuts or threaded standoffs onto the threaded studs to secure the reader.
If installing in a non-conductive panel in the vending machine (such as a plastic front panel), a customer supplied ground wire should be connected from one of the mounting studs to a grounded metal part inside the machine.

Data cables are susceptible to electrical noise that can corrupt data. Avoid routing cables near electrical equipment, including fluorescent lights, compressors, and motors.

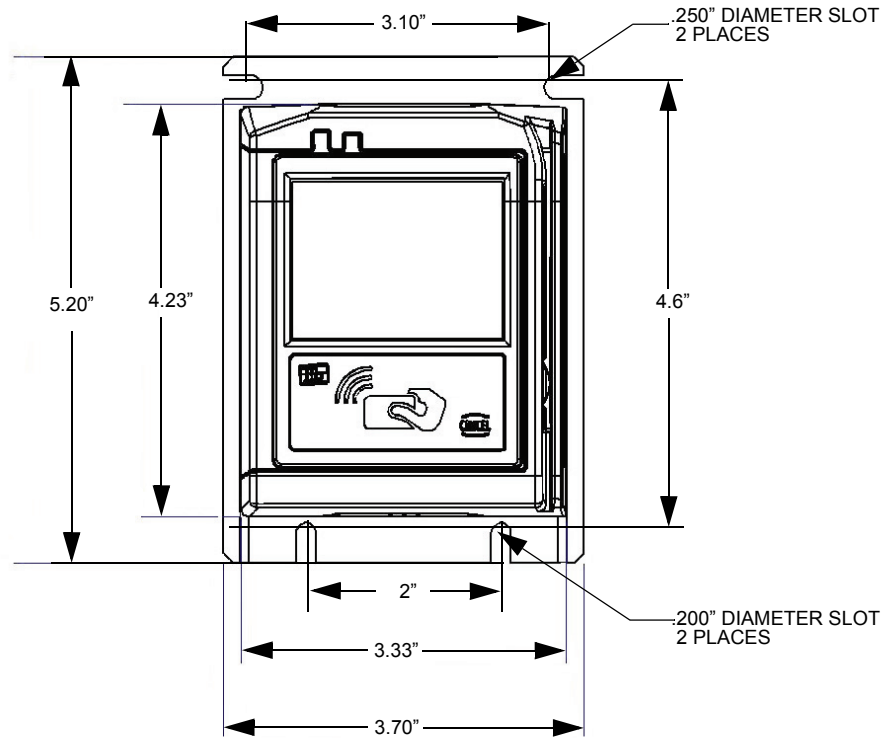

Figure 3: Vending Reader Face and Mounting Dimensions

CONNECT THE READER CABLES

- 5 Connect the single connector end of the supplied MDB 'Y' cable (p/n 055-800-132) to the MDB connector on the back of the VR4100 reader.
- 6 Disconnect the coin mechanism MDB connector from the machine controller; note the connection location.
- 7 Connect the double connector end of the supplied MDB 'Y' cable to a.) the coin mechanism MDB connector, and b.) the machine controller MDB connector.

A 16' MDB extension cable (VE/MDBDPCE16) is available from Blackboard if the supplied 30" cable is not long enough.

- 8 Connect one end of the supplied CAT5 network cable into the reader:

Ethernet connection (10/100Base-T): 'NET' port

The network cable is a CAT5 patch cable with RJ45 connectors on each end.

- 9 Route the network cable from the VR4100 out the back of the vending machine.

Typically this should be routed across the door hinge along a cable bundle that already crosses the door hinge. Use wire ties to hold all wires away from any mechanically moving parts such as hinges, the coin return lever linkage, door latch, etc.

STOP! DO NOT connect the other end of the network cable to the wall plate until reader configuration is complete.

- 10 Power up the vending machine.

This powers up the reader.

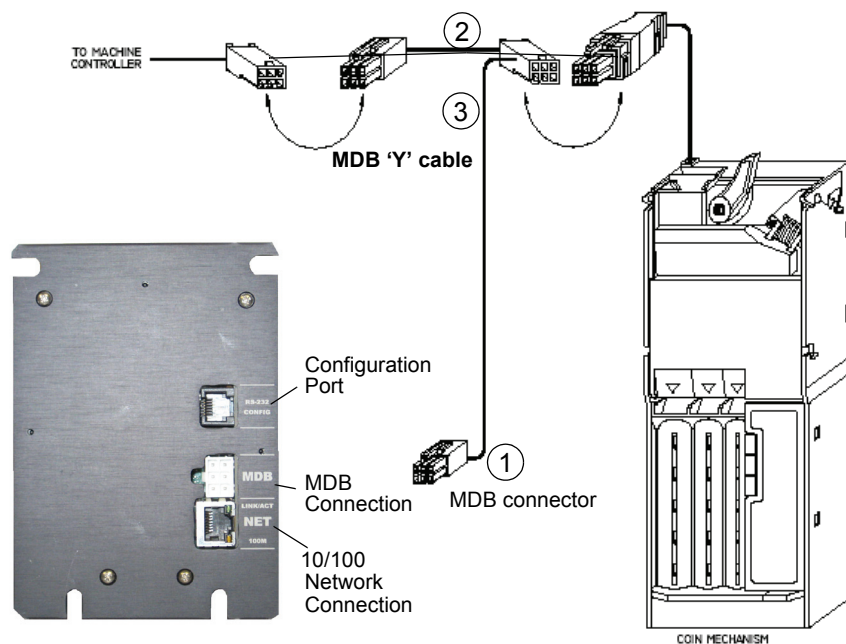

Figure 4: Multi-Drop Bus (MDB) Connections

READER CONFIGURATION

The VR4100 requires an IP address and Host IP address to communicate with BbTS. If using DHCP, the reader does not need to be configured. Configure the VR4100 reader using one of three communication modes:

- [Front Panel \(Touch Screen & Service Card\) Configuration](#) (page 1-7)
- [RS-232 Configuration](#) (page 1-8)
- [Web Service Configuration](#) (page 1-9)

Front Panel (Touch Screen & Service Card) Configuration

To configure the reader using Front Panel Configuration

- 1 Swipe or tap the specially encoded service card.

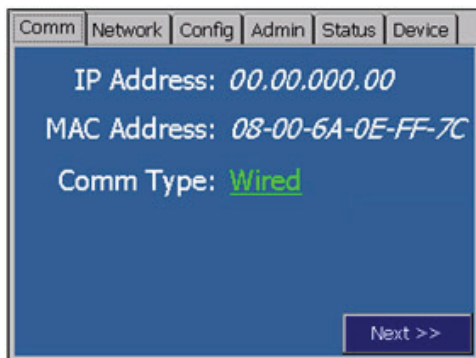

Figure 5: Configuration Screen

- 2 Set the configuration parameters using the front panel display.
See: *the* [VR4100 Configuration Flowchart](#) (page 1-16).

RS-232 Configuration

To configure the reader using RS-232

- 1 Open a **terminal program** (RS-232).
- 2 Establish the following connection settings:
115200 baud rate
1 stop
no parity
no flow control

For RS-232 config port pinouts, see: [RS-232 Config Port Pinout](#) (page 1-8).

- 3 Login using the default password: **IPdr4U**.
The password is case sensitive.
- 4 Type **config**, and then press **Enter** at the reader menu.
- 5 Set the configuration parameters.
See: the [VR4100 Configuration Flowchart](#) (page 1-16).

Table 1-1: RS-232 Config Port Pinout

VR4100 (RJ12)	PC Serial Port DB9 Connector	Signal
Pin 1	Pin 5	Ground
Pin 3	Pin 3	Receive (RX)
Pin 4	Pin 2	Transmit (TX)

Web Service Configuration

The web server is a secure server that requires Hypertext Transfer Protocol Secure (HTTPS) connections. When connecting to the web server, in the address bar, replace **HTTP://** with **HTTPS://** before entering the IP address.

To configure the reader using web service

- 1 Connect the VR4100 Reader to the network.
- 2 Open a web browser, and then enter the reader's IP address in the address bar.
*Press **Enter**.*

*The web server has a self-signed certificate that is not a trusted CA Root certificate. This causes the browser to report a certificate error, click **continue to this website**.*

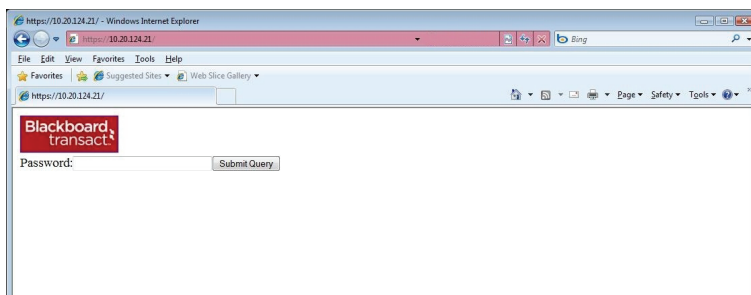

Figure 6: Web Service Login Window

- 3 Login using the default password: **IPPrdr4U**.
The password is case sensitive.

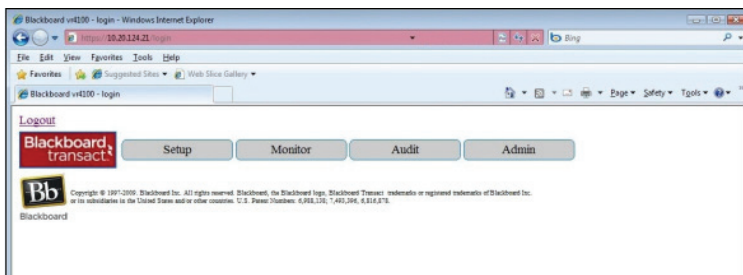

Figure 7: Web Service Main Menu Options

4 Choose one of the following menu options:

- Setup** (Page: 10)
- Monitor** (Page: 12)
- Audit** (Page: 14)
- Admin** (Page: 15)

Setup

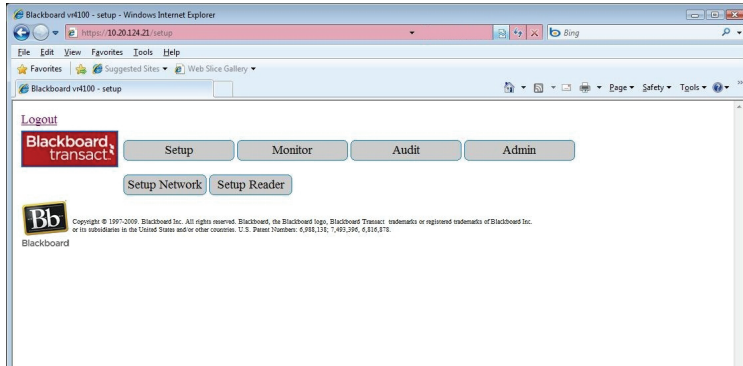

Figure 8: Setup Menu Options Window

5 Choose to:

- Setup Network** (Page: 10).
- Setup Reader** (Page: 11).

SETUP NETWORK

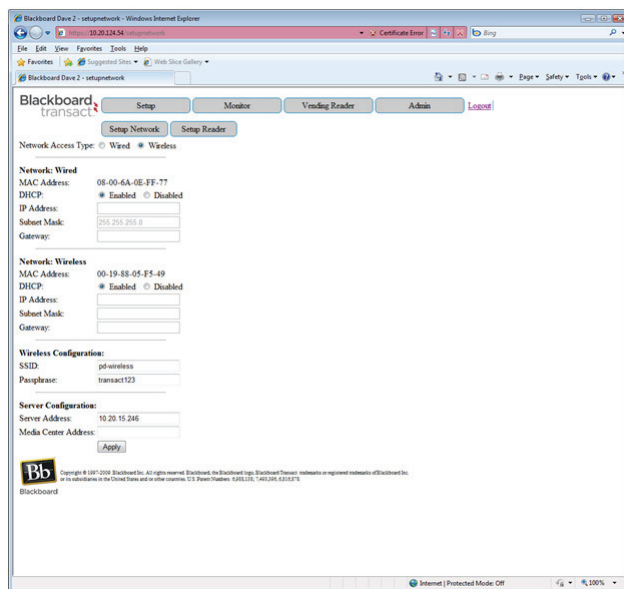

Figure 9: Setup Network Options Window

- 6 For a wired network, choose **Network Wired**.
*For a wireless network, choose **Network Wireless**.*

Before configuring the reader (wired or wireless mode), ensure that the VR4100 reader is NOT connected via a CAT5 network port such as a switch.

- 7 Enter the **Network Information**.
IP Address
Subnet Mask
Gateway
- 8 For wireless setup, enter **Wireless Configuration**.
SSID (the name of the wireless local area network)
Passphrase (must match the wireless access point Passphrase)
- 9 Enter the **Server Configuration** information.
- 10 Click **Apply**, and then reboot the reader.

SETUP READER

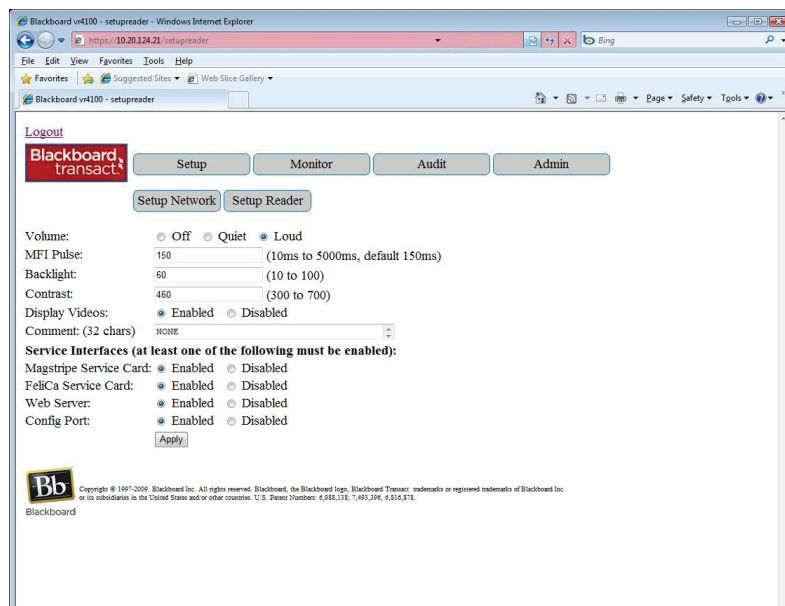

Figure 10: Setup Reader Options Window

- 11 Configure the Reader Setup Options, and then click **Apply**.

Monitor

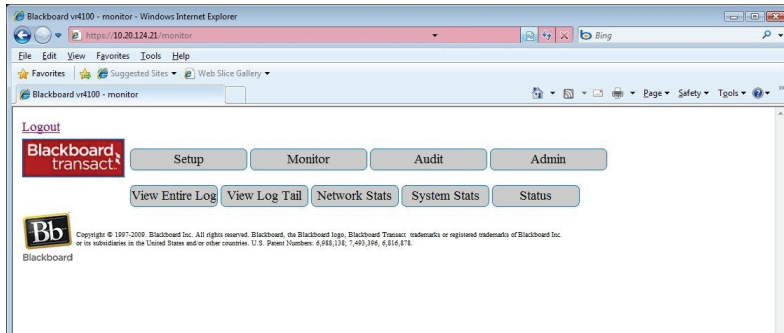

Figure 11: Monitor Menu Options

12 Choose to view:

- Log Detail** (Page: 12)
- Network Status** (Page: 13)
- System Status** (Page: 13)
- Status** (reader status) (Page: 14)

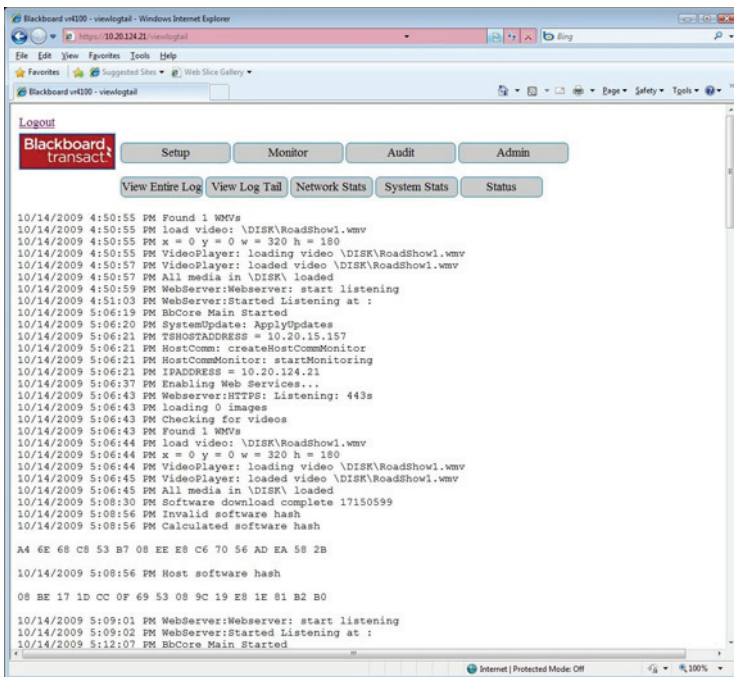

Figure 12: Log Detail

VENDING READER VR4100 INSTALLATION GUIDE

DOCUMENT 1277 REV 02

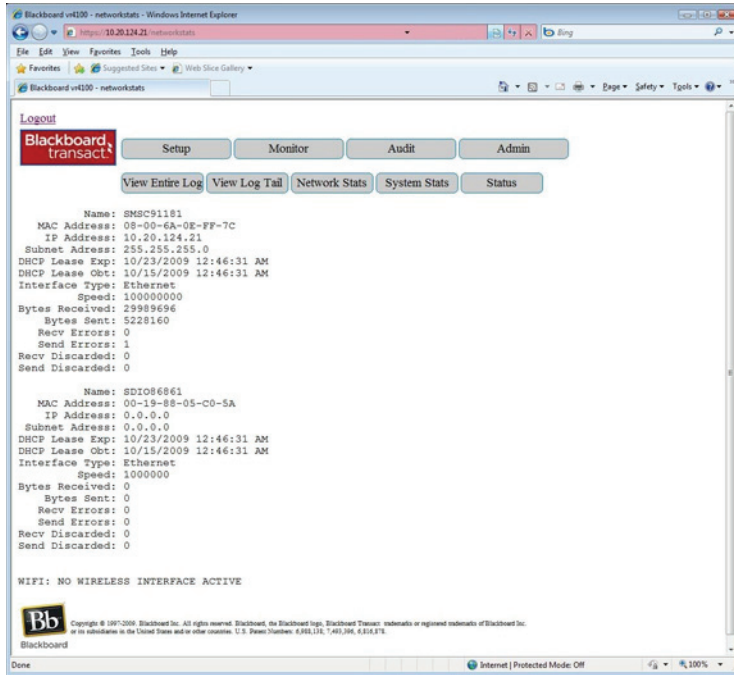

Figure 13: Network Status

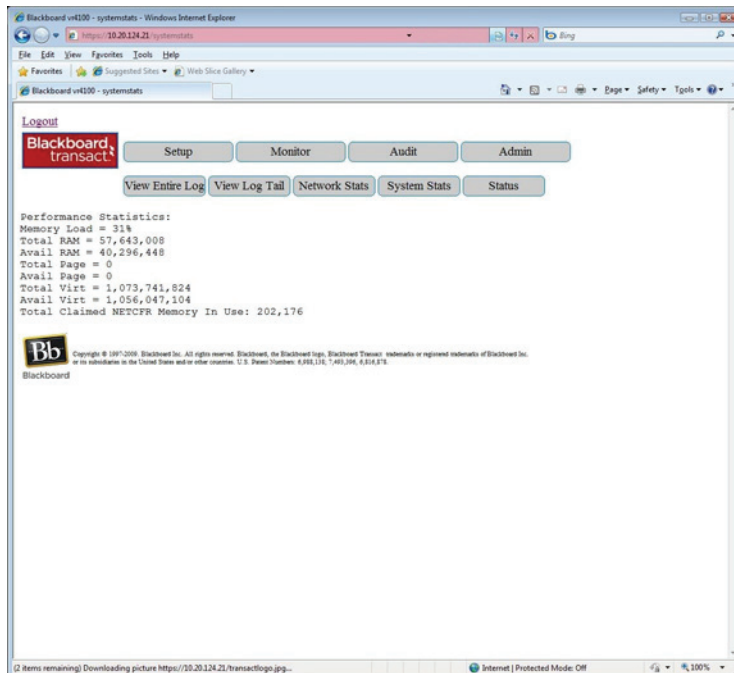

Figure 14: System Status

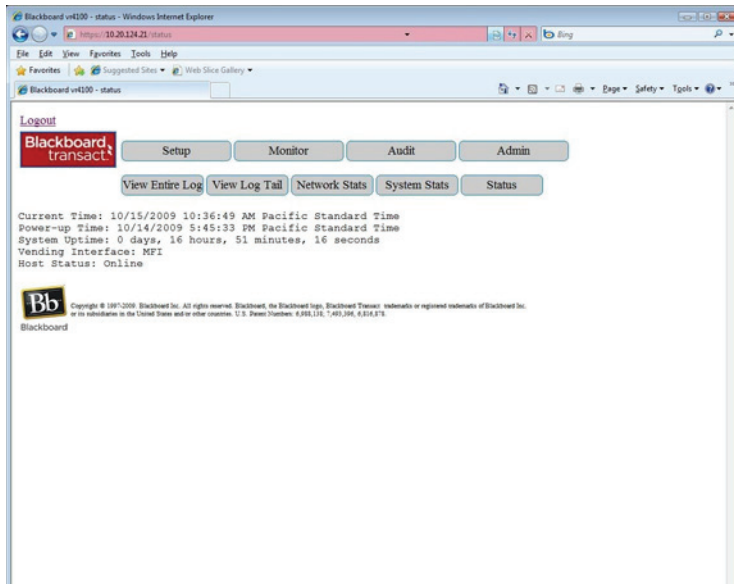

Figure 15: Status (reader status)

Audit

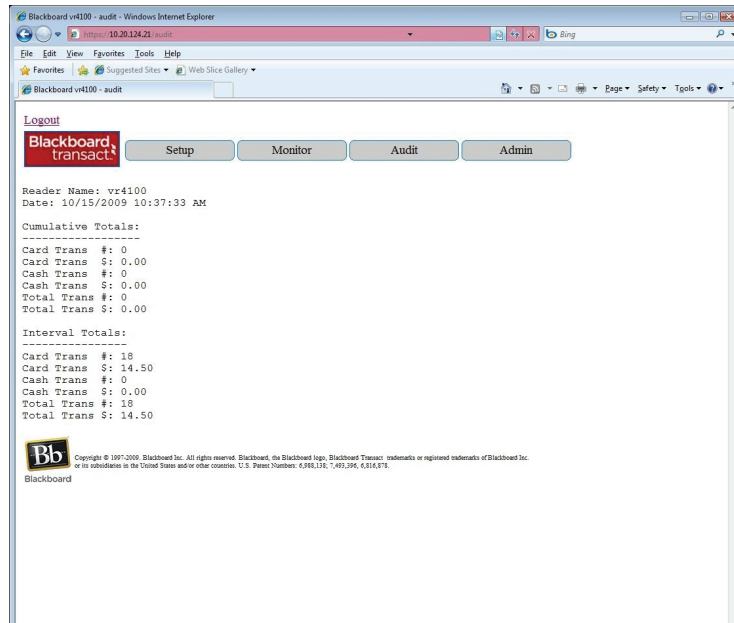

Figure 16: Reader Audit Window

Admin

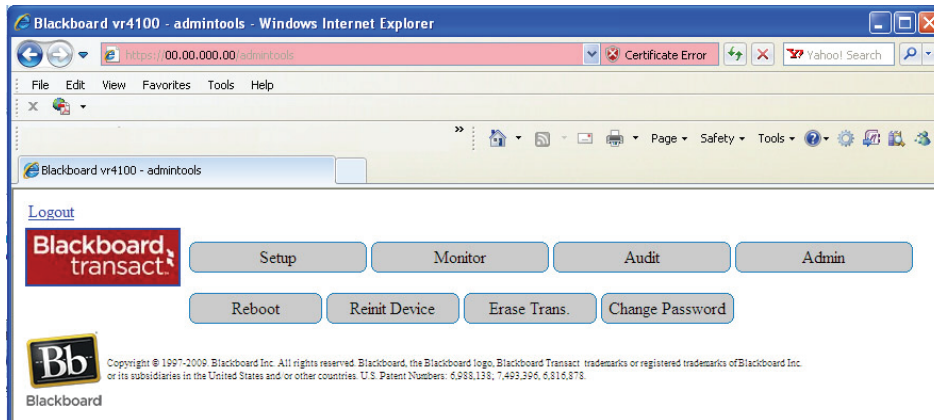

Figure 17: Admin Options Window

13 Choose to:

Reboot

Reinit Device (clears the reader's memory)

Erase Trans. (erase transactions)

Change Password

CAUTION!: After a Reinit of the VR4100 Reader with the intention of configuring as wireless after reboot, ensure that a CAT5 cable is NOT connected to the network.

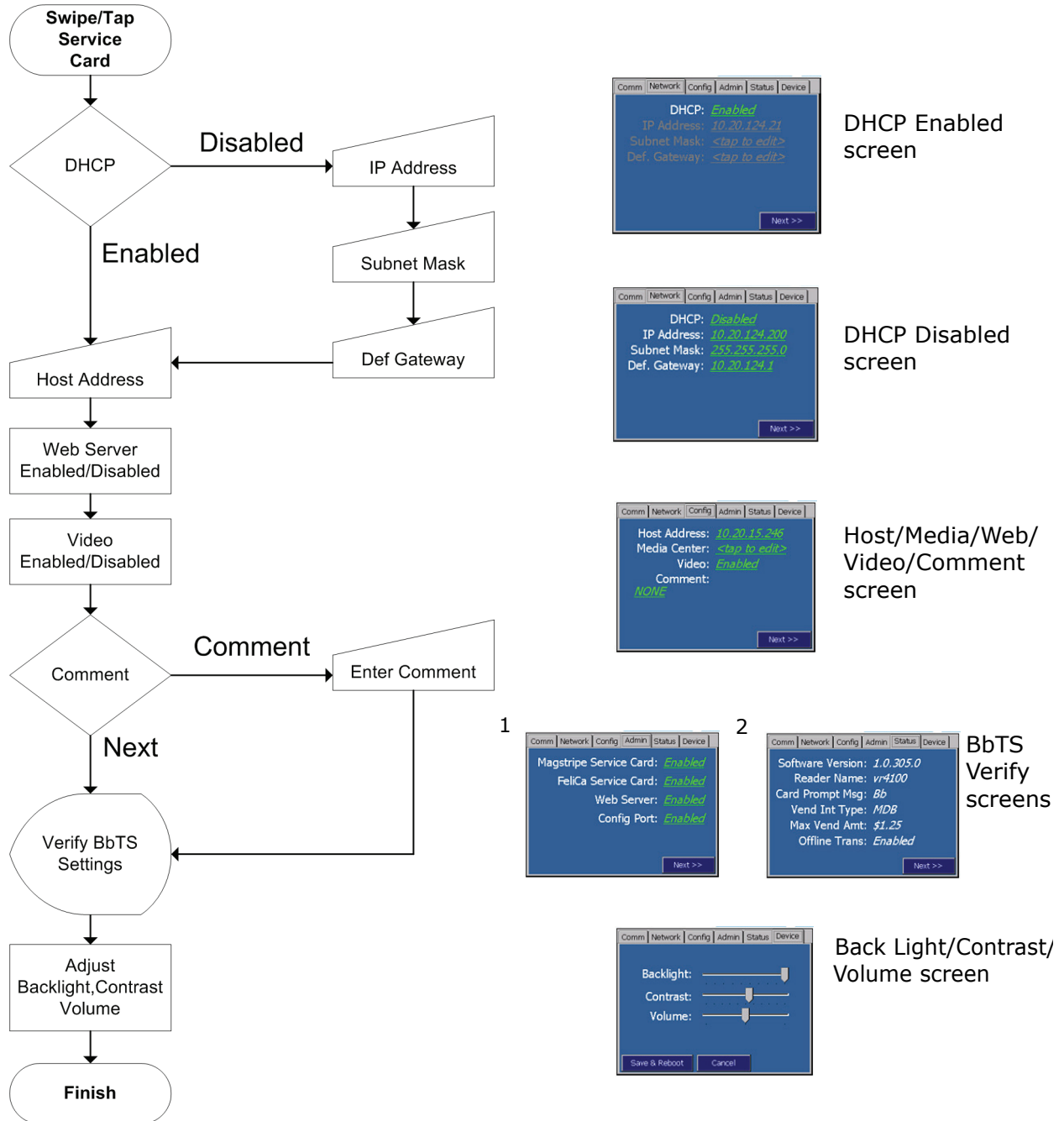

Figure 18: VR4100 Configuration Flowchart

READER TEST

To test the reader

- 1 After configuring the reader, connect the other end of the CAT5 network cable into a 10/100 Base-T network jack.

If 'Out of Service 100' displays, see the vending machine manufacturer for configuring the machine to support MDB card readers, or to configure the machine to send cash audit messages to the card reader.

- 1 Swipe or tap a card, and then press **CANCEL**.
Verify the reader returns to the idle display (Please Swipe or tap xxxxxxxx Card).
- 2 Insert coins, and then press the coin return lever on the vending machine.
Verify the reader returns to the idle display.
- 3 Insert money (coins or bills), and then select a product that costs less than the amount inserted.
Verify the reader displays the proper amount and returns to the idle display.
- 4 Insert money (coins or bills), and then select a product that costs the exact amount inserted.
Verify the reader displays the proper amount and returns to the idle display.
- 5 Swipe or tap a card, and then select a product that costs less than the maximum credit amount set in BbTS.
Verify the reader displays the proper amount and returns to the idle display.
- 6 Swipe or tap a card, and then select a product that costs exactly the maximum credit amount set in BbTS.
Verify the reader displays the proper amount and returns to the idle display.
- 7 In BbTS, verify the test transactions posted properly for each test case.

READER AUDIT

Reader Audits are implemented at cash collections for reporting collections to the Transaction System. The Audit is initiated with a Manager Card swipe or tap. The Manager Card provides management and reporting capabilities on specific remote unattended reader devices. To add a Manager Card, see: the Transaction System Administration Guide. The reader displays Audit messages at a slow rate for manually recording, about 10 seconds per message. Once the entire message cycle is complete, the reader reports the date, manager, and amount of cash transactions to Transaction System and resets interval totals to zero. Amounts are reported on the Net Sales By Location Report.

A Manager Card must be swiped to initialize audit counts.

To view audit totals

- 1 Swipe the **Manager Card**.
- 2 Click **Audit Totals**.

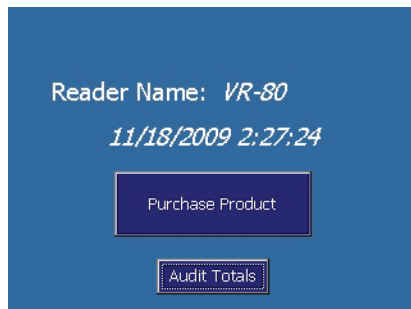

Figure 19: Audit Totals Main Screen

- 3 Click **Cancel** to exit, or **Next** to view the next screen.

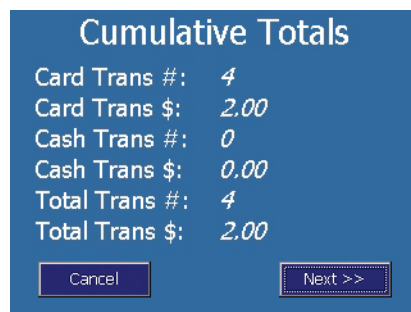

Figure 20: Cumulative Totals Screen

4 Click to **Cancel**, **Clear** or **Done** to exit.

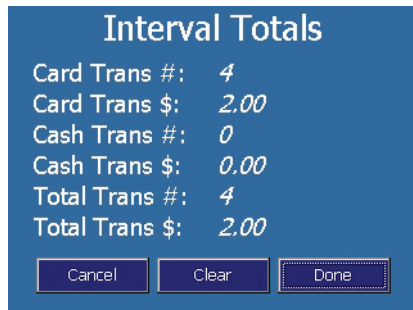

Figure 21: Interval Totals Screen

Table 1-2: VR4100 Reader Status Messages

Out of Srvc 001	Complete configuration not received by the TS host. Check reader setup and resend download.
Out of Srvc 002	Off-line transaction storage is full. Bring the reader on-line.
Out of Srvc 100	Complete configuration not received from vending machine Controller. Power cycle vending machine. Verify Controller supports MDB reader.
Out of Srvc 999	Hardware error. Return reader to Blackboard for service.
Reader Disabled	Controller disabled or the machine is out of product.
Card Use Disabled	Reader is off-line and off-line transactions are disabled.
Please Swipe or tap xxxxxxxx card	Reader is ready for use. (xxxxxxx is the configured TS card name).

READER FACTORY DEFAULT SETTINGS

Resetting the reader's default settings restores the original password. This is established by connecting to the reader's CONFIG port, or via web server.

To restore factory default settings using the reader's CONFIG port

- 1 Connect a computer to the reader's CONFIG port, and then unplug the MDB cable from the reader.

Disconnecting the MDB cable powers down the reader.

- 2 Reconnect the MDB cable, and immediately type a minimum of five ASCII x characters.
Typing 'xxxxx' within 3 seconds of the reader boot process will reset to the default settings.

Press the 'x' key multiple times, or if the Keyboard Auto-repeat is enabled, hold it down to accommodate this device's longer boot time.

To restore factory default settings via web server

- 1 Open a web browser, and then log into the reader.
See: [Web Service Configuration](#) (Page: 9).
- 2 Choose **Admin**, and then **Reinit Device**.

CAUTION! *After a Reinit of the VR4100 Reader with the intention of configuring as wireless after reboot, ensure that a CAT5 cable is NOT connected to the network.*

READER SPECIFICATIONS

Physical Size:	Dimensions: 3.7" W x 5.2" H x 2.1" D
	Weight: 0.72 lbs
Input Power:	24-34VDC 500mA max
Operating:	Temperature: 0 - 60+ degrees Celsius
	Relative Humidity: 0 - 95%, non-condensing
	Altitude: 0 - 10,000 feet
Non-Operating:	Temperature: -20 to 70+ degrees Celsius
	Relative Humidity: 0 - 95%, non-condensing
	Altitude: 0 - 35,000 feet

This device contains two integrated lithium batteries (BR2032). There is a risk of fire if the battery is replaced with an incorrect type. Proper disposal of a used battery is essential.

