

User Manual

Blood Pressure Monitor TMB-995-BS

Arm Type

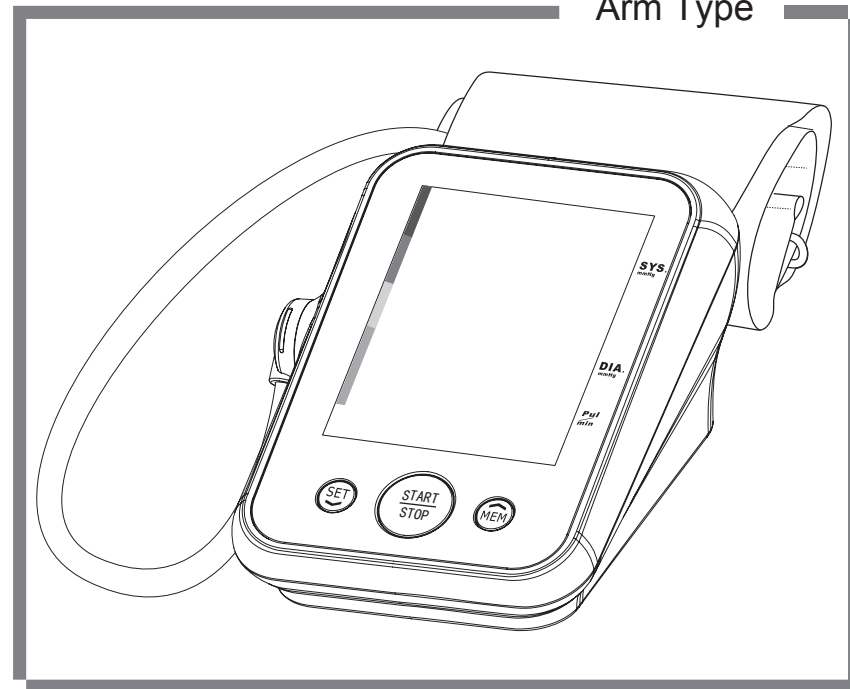

FCC ID:OU9TMB995-BS

 **Guangdong Transtek Medical Electronics Co., Ltd.**
Zone B, No.105 ,Dongli Road, Torch Development District,
Zhongshan,528437,Guangdong,China

- Thank you very much for selecting TRANSTEK Blood Pressure Monitor TMB-995-BS.
- To use the monitor correctly and safely, please read the manual thoroughly.
- Please keep well this manual in order to reference in future.

Table of Contents

INTRODUCTION.....	2
• General Description	
• Indications for Use	
• Contraindications	
• Measurement Principle	
• Safety Information	
• LCD Display Signal	
• Monitor Components	
• List	
BEFORE YOU START.....	9
• The Choice of Power Supply	
• Installing and Replacing the Batteries	
• Setting Date and Time	
• Select the User	
MEASUREMENT.....	13
• Tie the Cuff	
• Start the Measurement	
DATA MANAGEMENT.....	15
• Recall the Records	
• Delete the Records	
INFORMATION FOR USER.....	19
• Tips for measurement	
• Maintenances	
ABOUT BLOOD PRESSURE.....	21
• What are systolic pressure and diastolic pressure?	
• What is the standard blood pressure classification?	
• Irregular heartbeat detector	
• Why does my blood pressure fluctuate throughout the day?	
• Why do I get a different blood pressure at home compared to the hospital?	
• Is the result the same if measuring on the right arm?	
TROUBLESHOOTING.....	23
SPECIFICATIONS.....	24
AUTHORIZED COMPONENT	25
CONTACT INFORMATION.....	25
COMPLIED STANDARDS LIST.....	26
FCC STATEMENT.....	27
EMC GUIDANCE.....	28

♥ General Description

Thank you for selecting TRANSTEK arm type blood pressure Monitor (TMB-995-BS). The monitor features blood pressure measurement, pulse rate measurement and the result storage. The design provides you with two years of reliable service.

Readings taken by the TMB-995-BS are equivalent to those obtained by a trained observer using the cuff and stethoscope auscultation method.

This manual contains important safety and care information, and provides step by step instructions for using the product.

Read the manual thoroughly before using the product.

Features:

- 80*60mm Digital LCD display
- Maximum 60 records per each user
- Measuring during inflation technology

♥ Indications for Use

The Transtek Blood Pressure Monitor is digital monitors intended for use in measuring blood pressure and heartbeat rate with arm circumference ranging from 22 cm to 32 cm (about 8¾"-12½") or 22cm to 42cm(about 8¾"-16½"). It is intended for adult indoor use only.

♥ Contraindications













- 1.The device is not suitable for use on may be pregnant women or pregnant women.
- 2.The device is not suitable for use on patients with implanted,electrical devices, such as cardiac pacemakers, defibrillators.

♥ Measurement Principle

This product uses the Oscillometric Measuring Method to detect blood pressure. Before every measurement, the unit establishes a “zero point” equivalent to the atmospheric pressure. Then it starts inflating the cuff. Meanwhile, the unit detects pressure oscillation generated by beat-to-beat pulsatile, which is used to determine the systolic pressure and diastolic pressure as well as pulse rate.

♥ Safety Information

The signs below might be in the user manual, labeling or other components. They are the requirement of standard and using.

	Symbol for “THE OPERATION GUIDE MUST BE READ”		Symbol for “TYPE BF APPLIED PARTS”
	Symbol for “MANUFACTURER”		Symbol for “ENVIRONMENT PROTECTION - Electrical waste products should not be disposed of with household waste. Please recycle where facilities exist. Check with your local authority or retailer for recycling advice”
	Symbol for “SERIAL NUMBER”		
	Symbol for “DIRECT CURRENT”		
	For indoor use only		Symbol for “Class II Equipment”
F1	T1A/250V Φ3.6*10CCC		Symbol for “MANUFACTURE DATE”
	Caution: These notes must be observed to prevent any damage to the device.		Symbol for “Recycle”
	The Green Dot is the license symbol of a European network of industry-funded systems for recycling the packaging materials of consumer goods.		

⚠ CAUTION

- * This device is intended for adult use in homes only.
- * The device is not suitable for use on neonatal patients, pregnant women, patients with implanted, electrical devices, patients with pre-eclampsia, premature ventricular beats, atrial fibrillation, peripheral, arterial disease and patients undergoing intravascular therapy or arterio-venous shunt or people who received a mastectomy. Please consult your doctor prior to using the unit if you suffer from illnesses.
- * The device is not suitable for measuring the blood pressure of children. Ask your doctor before using it on older children.
- * The device is not intended for patient transport outside a healthcare facility.
- * The device is not intended for public use.
- * This device is intended for no-invasive measuring and monitoring of arterial blood pressure. It is not intended for use on extremities other than the arm or for functions other than obtaining a blood pressure measurement.
- * Do not confuse self-monitoring with self-diagnosis. This unit allows you to monitor your blood pressure. Do not begin or end medical treatment without asking a physician for treatment advice.
- * If you are taking medication, consult your physician to determine the most appropriate time to measure your blood pressure. Never change a prescribed medication without consulting your physician.
- * Do not take any therapeutic measures on the basis of a self measurement. Never alter the dose of a medicine prescribed by a doctor. Consult your doctor if you have any question about your blood pressure.
- * When the device was used to measure patients who have common arrhythmias such as atrial or ventricular premature beats or atrial fibrillation, the best result may occur with deviation. Please consult your physician about the result.
- * Don't kink the connection tube during use, otherwise, the cuff pressure may continuously increase which can prevent blood flow and result in harmful injury to the PATIENT.
- * When using this device, please pay attention to the following situation which may interrupt blood flow and influence blood circulation of the patient, thus cause harmful injury to the patient: connection tubing kinking too frequent and consecutive multiple measurements; the application of the cuff and its pressurization on any arm where intravascular access or therapy, or an arterio-venous (A-V) shunt, is present; inflating the cuff on the side of a mastectomy.
- * Warning: Do not apply the cuff over a wound; otherwise it can cause further injury.
- * Do not inflate the cuff on the same limb which other monitoring ME equipment is applied around simultaneously, because this could cause temporary loss of function of those simultaneously-used monitoring ME equipment.
- * On the rare occasion of a fault causing the cuff to remain fully inflated during measurement, open the cuff immediately. Prolonged high pressure (cuff pressure > 300mmHg or constant pressure > 15mmHg for more than 3 minutes) applied to the arm may lead to an echymosis.
- * Please check that operation of the device does not result in prolonged impairment of patient blood circulation.
- * When measurement, please avoid compression or restriction of the connection tubing.
- * The device cannot be used with HF surgical equipment at the same time.

⚠ CAUTION

- * The ACCOMPANYING DOCUMENT shall disclose that the SPHYGMOMANOMETER was clinically investigated according to the requirements of ISO 81060-2:2013.
- * To verify the calibration of the AUTOMATED SPHYGMOMANOMETER, please contact the manufacturer.
- * This device is contraindicated for any female who may be suspected of, or is pregnant. Besides providing inaccurate readings, the effects of this device on the fetus are unknown.
- * Too frequent and consecutive measurements could cause disturbances in blood circulation and injuries.
- * This unit is not suitable for continuous monitoring during medical emergencies or operations. Otherwise, the patient's arm and fingers will become anaesthetic, swollen and even purple due to a lack of blood.
- * When not in use, store the device with the adapter in a dry room and protect it against extreme moisture, heat, lint, dust and direct sunlight. Never place any heavy objects on the storage case.
- * This device may be used only for the purpose described in this booklet. The manufacturer cannot be held liable for damage caused by incorrect application.
- * This device comprises sensitive components and must be treated with caution. Observe the storage and operating conditions described in this booklet.
- * The maximum temperature that the applied part can be achieved is 42.8 °C while the environmental temperature is 40 °C.
- * The equipment is not AP/APG equipment and not suitable for use in the presence of a flammable anesthetic mixture with air or with oxygen or nitrous oxide.
- * Warning: No servicing/maintenance while the ME equipment is in use.
- * The patient is an intended operator.
- * The patient can measure, transmit data and charge power under normal circumstances and maintain the device and its accessories according to the user manual.
- * To avoid measurement errors, please avoid the condition of strong electromagnetic field radiated interference signal or electrical fast transient/burst signal.
- * The blood pressure monitor, its adaptor, and the cuff are suitable for use within the patient environment. If you are allergic to polyester, nylon or plastic, please don't use this device.
- * During use, the patient will be in contact with the cuff. The materials of the cuff have been tested and found to comply with requirements of ISO 10993-5:2009 and ISO 10993-10:2010. It will not cause any potential sensitization or irritation reaction.
- * Adaptor is specified as a part of ME EQUIPMENT.
- * If you experience discomfort during a measurement, such as pain in the arm or other complaints, press any button to release the air immediately from the cuff. Loosen the cuff and remove it from your arm.
- * If the cuff pressure reaches 40 kPa (300 mmHg), the unit will automatically deflate. Should the cuff not deflate when pressures reaches 40 kPa (300 mmHg), detach the cuff from the arm and press any button to stop inflation.
- * Before use, make sure the device functions safely and is in proper working condition. Check the device, do not use the device if it is damaged in any way. The continuous use of a damaged unit may cause injury, improper results, or serious danger.
- * Do not wash the cuff in a washing machine or dishwasher!

CAUTION

- * The service life of the cuff may vary by the frequency of washing, skin condition, and storage state. The typical service life is 10000 times.
- * It is recommended that the performance should be checked every 2 years and after maintenance and repair, by retesting at least the requirements in limits of the error of the cuff pressure indication and air leakage (testing at least at 50mmHg and 200mmHg).
- * Please dispose of ACCESSORIES, detachable parts, and the ME EQUIPMENT according to the local guidelines.
- * Manufacturer will make available on request circuit diagrams, component part lists, descriptions, calibration instructions, etc., to assist to service personnel in parts repair.
- * The plug/adaptor plug pins insulates the device from the main supply. Do not position the device in a position where it is difficult to disconnect from the supply mains to safely terminate operation of ME equipment.
- * The operator shall not touch output of batteries /adaptor and the patient simultaneously.
- * Cleaning :Dust environment may affect the performance of the unit. Please use the soft cloth to clean the whole unit before and after use. Don't use any abrasive or volatile cleaners.
- * The device doesn't need to be calibrated within two years of reliable service.
- * If you have any problems with this device, such as setting up, maintaining or using, please contact the SERVICE PERSONNEL of Transtek. Don't open or repair the device by yourself in the event of malfunctions. The device must only be serviced, repaired and opened by individuals at authorized sales/service centers.
- * Please report to Transtek if any unexpected operation or events occur.
- * Keep the unit out of reach of infants, young children or pets to avoid inhalation or swallowing of small parts. It is dangerous or even fatal.
- * Be careful to strangulation due to cables and hoses, particularly due to excessive length.
- * At least 30 min required for ME equipment to warm from the minimum storage temperature between uses until it is ready for intended use. At least 30 min required for ME equipment to cool from the maximum storage temperature between uses until it is ready for intended use.
- * This equipment needs to be installed and put into service in accordance with the information provided in the ACCOMPANYING DOCUMENTS;
- * Wireless communications equipment such as wireless home network devices, mobile phones, cordless telephones and their base stations, walkie-talkies can affect this equipment and should be kept at least a distance d away from the equipment. The distance d is calculated by the MANUFACTURER from the 80MHz to 5.8 GHz column of Table 4 and Table 9 of IEC 60601-1-2:2014, as appropriate.
- * Please use ACCESSORIES and detachable partes specified/ authorised by MANUFACTURE. Otherwise, it may cause damage to the unit or danger to the user/patients.
- * There is no luer lock connectors are used in the construction of tubing, there is a possibility that they might be inadvertently connected to intravascular fluid systems, allowing air to be pumped into a blood vessel.
- * Please use the device under the environment which was provided in the user manual. Otherwise, the performance and lifetime of the device will be impacted and reduced.

♥ LCD Display Signal

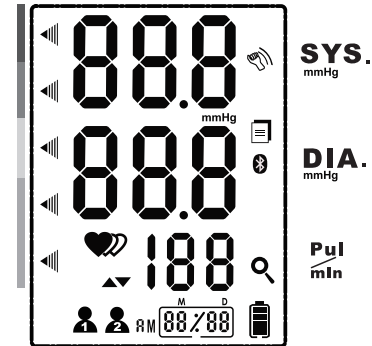

SYMBOL	DESCRIPTION	EXPLANATION
SYS.	Systolic blood pressure	High pressure result
DIA.	Diastolic blood pressure	Low pressure result
Pul min	Pulse	Pulse/minute
▼	Deflating	CUFF air is exhausting of deflating
RM ^M 88/88 ^D	Current Time	Time(year:month:day:hour:minute)
🔍	Memory	If "MEM" shows, the displayed measurement values is from the memory.
mmHg	mmHg	Measurement Unit of the blood pressure
🔋	Battery Indicator	Indicate the current battery
♥♥	Irregular heartbeat	Irregular heartbeat
📶	Grade	The grade of the blood pressure
♥	Heartbeat	Heartbeat detection during measurement
👤	User 1	Start measurement and transmit the results for User 1
👤	User 2	Start measurement and transmit the results for User 2
📄	Data pending to transmit	Measurement data stored in the equipment
👋	Shocking reminder	Shocking will result in inaccurate
📶	Bluetooth icon	The bluetooth icon blinks when the bluetooth is working

♥ Monitor Components

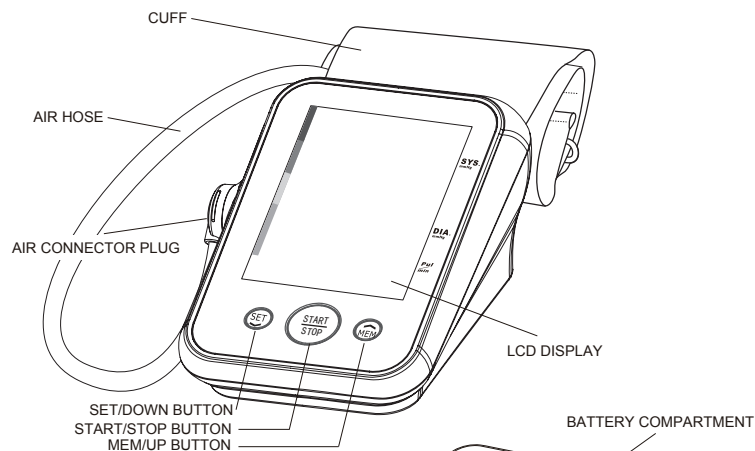

Component list of pressure measuring system:

- 1 Cuff
- 2 Air pipe
- 3 PCBA
- 4 Pump
- 5 Valve

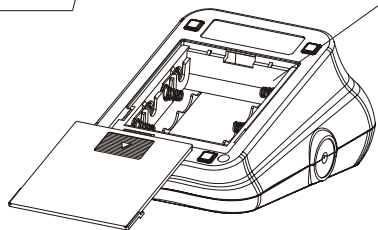

♥ List

1. Blood Pressure Monitor (TMB-995-BS)
2. Cuff (22~32cm or 22~42cm) (Type BF applied part)
3. User manual



4. 4*AA batteries

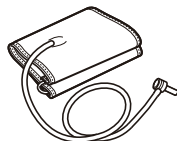

5. AC adaptor (BLJ06L060100P-U)

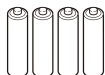

♥ The Choice of Power Supply

1. Battery powered mode:
6VDC 4*AA batteries
2. AC adaptor powered mode:
6V $\bar{\sim}$ 1A
(Please use the AC adaptor which authorized by the manufacturer!)
Right picture is the hole in for power adaptor.

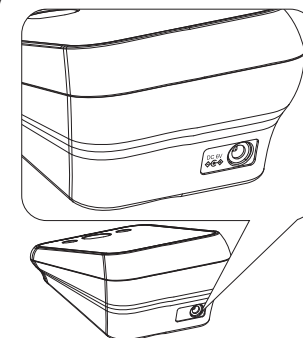

⚠ CAUTION

In order to get the best effect and protect your monitor, please use the right batteries and special power adaptor which complies with local safety standard.

♥ Installing and Replacing the Batteries

1. Slide off the battery cover.
2. Install the batteries by matching the correct polarity, as shown.
3. Replace the cover.

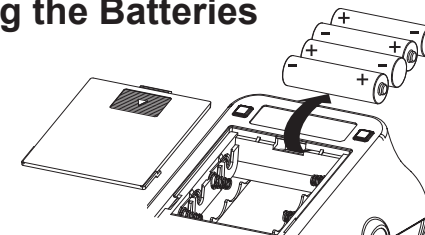

Replace the batteries whenever the below happen

- The $\text{Lo} + \square$ shows
- The display dims
- The display does not light up

⚠ CAUTION

- Do not use new and used batteries together.
- Do not use different types of batteries together.
- Do not dispose the batteries in fire. Batteries may explode or leak.
- Remove batteries if the device is not likely to be used for some time.
- Worn batteries are harmful to the environment. Do not dispose with daily garbage.
- Remove the old batteries from the device following your local recycling guidelines.

♥ Setting Date and Time

It is important to set the clock before using your blood pressure monitor, so that a time stamp can be assigned to each record that is stored in the memory. (year :2018—2058 time:12 H)

1. When the unit is off, hold pressing “SET” button for 3 seconds to enter the mode for year setting.

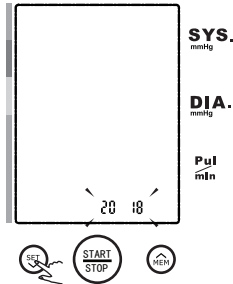

2. Press the “MEM” button to change the [YEAR].

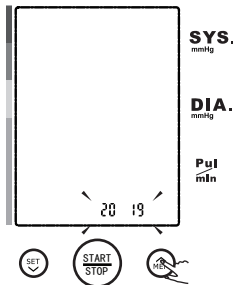

3. When you get the right year, press “SET” button to set down and turn to next step.

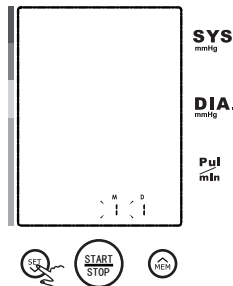

4. Repeat steps 2 and 3 to set the [MONTH] and [DAY].

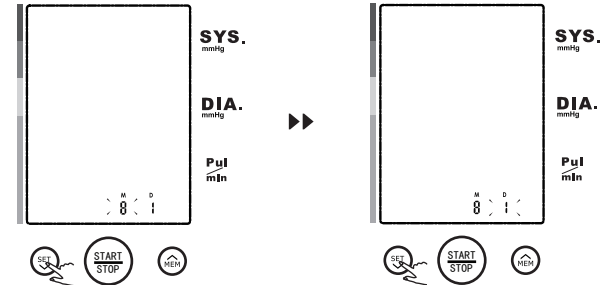

5. Repeat steps 2 and 3 to set the [HOUR] and [MINUTE].

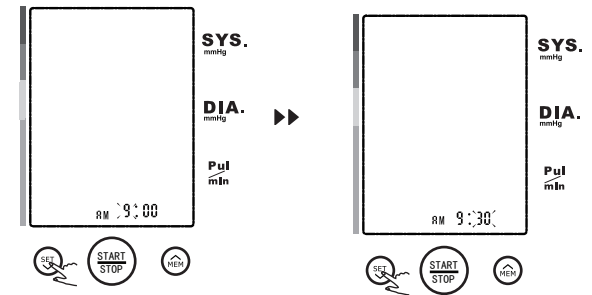

6. After the [UNIT] is set, the LCD will display “dOnE”, and then turn off.

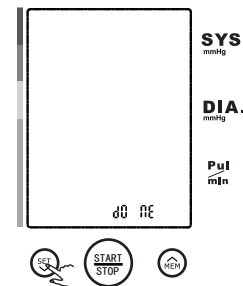

♥ Select the User

1. When the monitor is off, press the “SET” button to enter user setting mode.

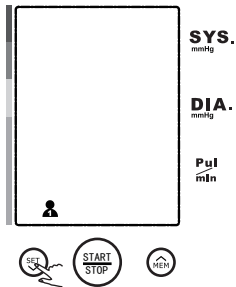

2. Then press “SET” button again, select the user ID user 1 and user 2 .

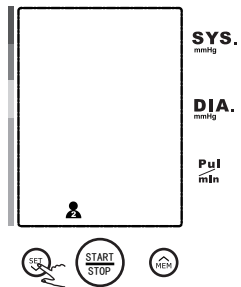

3. After selecting the suitable user ID, press “START/STOP” button to confirm. Then the LCD will turn off.

♥ Tie the Cuff

1. Remove all jewelry, such as watches and bracelets from your left arm.
Note: If your doctor has diagnosed you with poor circulation in your left arm, use your right arm.
2. Roll or push up your sleeve to expose the skin. Make sure your sleeve is not too tight.
3. Hold your arm with your palm facing up and tie the cuff on your upper arm, then position the tube off-center toward the inner side of arm in line with the little finger. Or position the artery mark Φ over the main artery (on the inside of your arm). Note: Locate the main artery by pressing with 2 fingers approximately 2 cm above the bend of your elbow on the inside of your left arm. Identify where the pulse can be felt the strongest. This is your main artery.
4. The cuff should be snug but not too tight. You should be able to insert one finger between the cuff and your arm.
5. Sit comfortably with your tested arm resting on a flat surface. Place your elbow on a table so that the cuff is at the same level as your heart. Turn your palm upwards. Sit upright in a chair, and take 5-6 deep breaths.
6. Helpful tips for Patients, especially for Patients with Hypertension:
 - Rest for 5 minutes before first measuring.
 - Wait at least 3 minutes between measurements. This allows your blood circulation to recover.
 - Take the measurement in a silent room.
 - The patient must relax as much as possible and do not move and talk during the measurement procedure.
 - The cuff should maintain at the same level as the right atrium of the heart.
 - Please sit comfortably. Do not cross your legs and keep your feet flat on the ground.
 - Keep your back against the backrest of the chair.
 - For a meaningful comparison, try to measure under similar conditions. For example, take daily measurements at approximately the same time, on the same arm, or as directed by a physician.

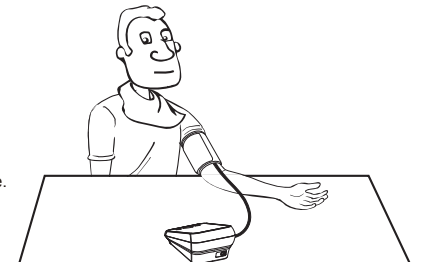
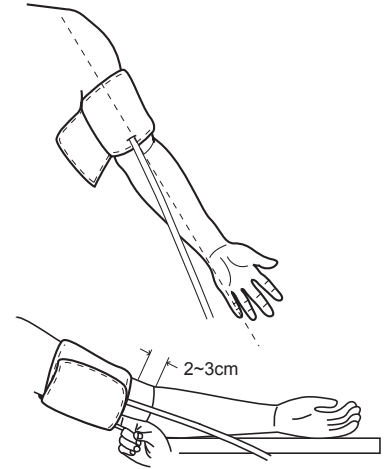

♥ Start the Measurement

- When the monitor is off, press the START/STOP button to turn on the monitor, and it will finish the whole measurement, save and transmit the measurement data for the desired user. (Take User 1 for example.)



LCD display

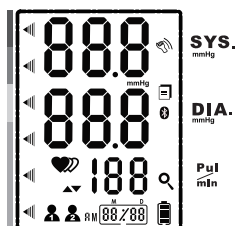

Inflating and measuring.

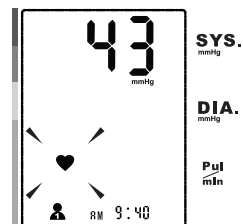

- This device will proceed to data transmission after measurement. The Bluetooth symbol blinks on the LCD indicates data is transmitting.

Adjust the zero .

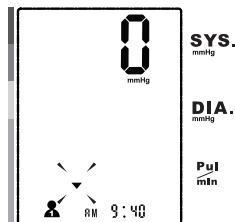

Display and save the results. The data transmission will proceed.

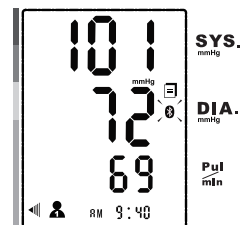
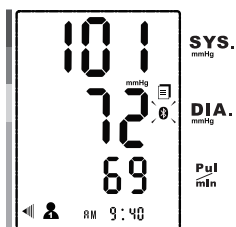

- If the data is successfully transmitted, the Bluetooth symbol doesn't blink any more, and the [] will disappear. If the data transmission fails, the [] will proceed.

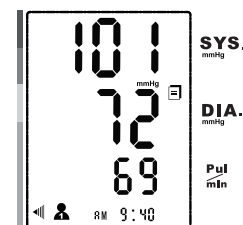
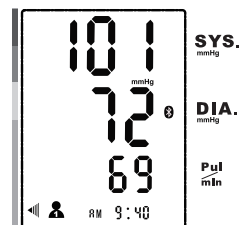

- Press "START/STOP" button to power off, otherwise it will turn off within 1 minute.



Tips:

- You can press "START/STOP" button at any time to stop measuring during the process of measurement.
- Maximum 60 records are both for USER 1 and USER 2.
- If the measurement result is out of the measurement range (SYS: 60mmHg to 230mmHg; or DIA: 40mmHg to 130mmHg; or Pulse: 40-199 pulse/minute), the LCD will display "out".

⚠ CAUTION

- Interference may occur in the vicinity of equipment marked with the following symbol (⚡). And TMB-995-BS may interfering vicinity electrical equipment.
- Sensitive people, including pregnant women pre-eclamptic and those who implanted medical electronic instruments, should avoid using the unit whenever possible.
- Keep the monitor at least 20 centimeters away from the human body (especially the head) when the data transmission is proceeding after measurement.
- To enable the data transmission function, this product should be paired to Bluetooth end at 2.4 GHz.

How to mitigate possible interference?

- The range between the device and BT end should be reasonably close, from 1 meter to 10 meters. Please ensure no obstacles between the device and BT end so as to obtain quality connection and to lower the RF output range.
- To avoid interference, other electronic devices (particularly those with wireless transmission / Transmitter) should be kept at least 1 meter away from the monitor.

♥ Recall the Records

1. When the monitor is off, please press “ MEM ” button to show the average value of the latest three records. If the records are less than 3 groups, it will display the latest record instead. Displays different colors at different levels when the monitor is under the memory enquiry mode.
(Take user 1 for example.)

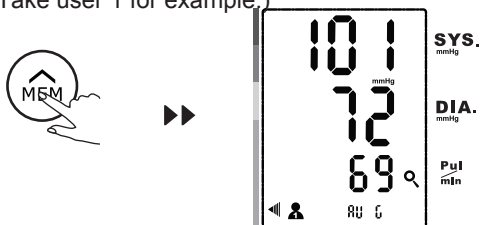

2. Press the “ MEM ” or “ SET ” button again to rotate the records. The order of the record, date and time will be displayed alternatively.

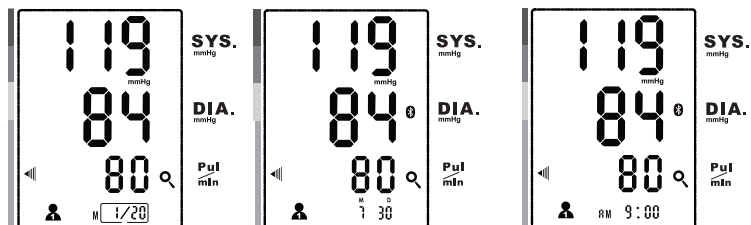

The current is the No. 1. Twenty records in total.

The corresponding date is July 30th.

The corresponding time is A.M.9:00.

⚠ CAUTION

The most recent record (1) is shown first. Each new measurement is assigned to the first (1) record. All other records are pushed back one digit (e.g., 2 becomes 3, and so on), and the last record (60) is dropped from the list.

♥ Delete the Records

If you did not get the correct measurement, you can delete all results of the selected user by following steps below .

1. Hold pressing “ MEM ” button for 3 seconds when the monitor is under the memory enquiry mode. The LCD will display the blinking “Use ID + dEL ALL”.

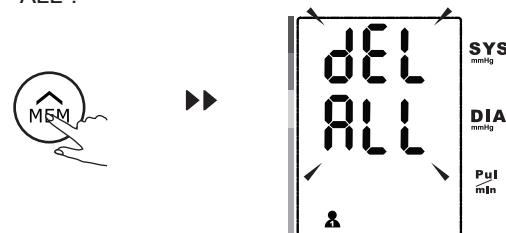

2. Press “ MEM ” button to confirm deleting all the memories , the LCD will display “Use ID + dEL dOnE” and the monitor will turn off.

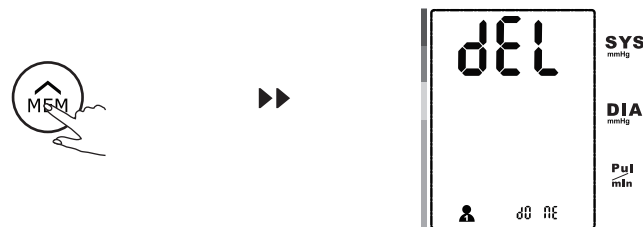

Bluetooth Module No.: LS51802

RF Frequency Range: 2.402 - 2.480 GHz

Max Output Power: -0.53dBm

Supply Voltage: 1.8V - 3.6V

Transmitting Distance: 1-10 meters

3. Hold pressing “ SET ” button for 3 seconds when the monitor is under the memory enquiry mode(excluding the LCD displays AVG). The LCD will display the blinking “ Use ID + dEL ONE”.

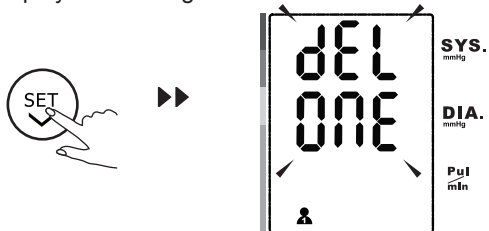

4. Press “ MEM ” button to confirm deleting the last record, the LCD will display “Use ID + dEL dOnE” and the monitor will turn off.

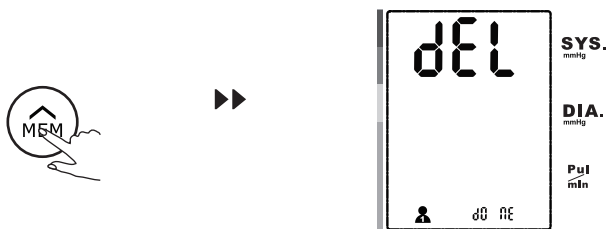

5. If you don't want to delete the records, press the “START/STOP” button, it will turn off and quit the deletion. Or when it is in the deleting memory mode, it will turn off and quit the deletion if there is no operation in one minute.

6. If there is no record, the LCD will display as the following picture:

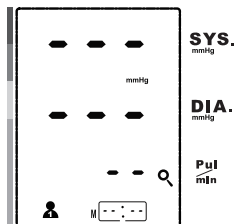

♥ Tips for Measurement

Measurements may be inaccurate if taken in the following circumstances.

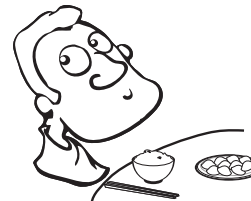

wait at least 1 hour after dinner or drinking



Immediate measurement after tea, coffee, smoking



Wait at least 20 minutes after taking a bath



When talking or moving your fingers



In a very cold environment



When you want to discharge urine

♥ Maintenance

In order to get the best performance, please follow the instructions below.

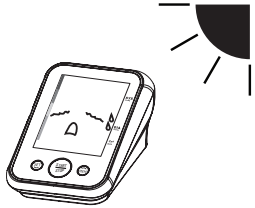

Put in a dry place and avoid the sunshine

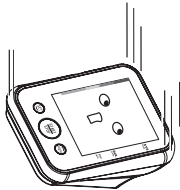

Avoid intense shaking and collisions

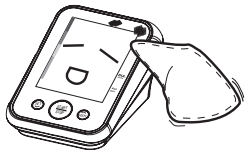

Using wet cloths to remove dirt



Avoid touching water, clean it with a dry cloth in case.



Avoid dusty and unstable temperature environment



Avoid washing the cuff

♥ What are systolic pressure and diastolic pressure?

When ventricles contract and pump blood out of the heart, the blood pressure reaches its maximum value in the cycle, which is called systolic pressure. When the ventricles relax, the blood pressure reaches its minimum value in the cycle, which is called diastolic pressure.

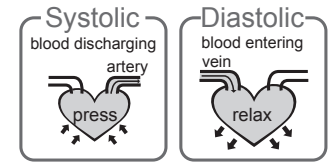

♥ What is the standard blood pressure classification?

The chart on the right is the standard blood pressure classification published by American Heart Association (AHA).

This chart reflects blood pressure categories defined by American Heart Association.

Blood Pressure Category	Systolic mmHg (upper#)		Diastolic mmHg (lower#)
Normal	less than 120	and	less than 80
Elevated	120-129	and	less than 80
High Blood Pressure (Hypertension) Stage 1	130-139	or	80-89
High Blood Pressure (Hypertension) Stage 2	140 or higher	or	90 or higher
Hypertensive Crisis (Consult your doctor immediately)	Higher than 180	and/or	Higher than 120

⚠ CAUTION

Please consult a physician if your measuring result falls outside the range. Please note that only a physician can tell whether your blood pressure value has reached a dangerous point.

♥ Irregular Heartbeat Detector

An irregular heartbeat is detected when a heartbeat rhythm varies while the unit is measuring the systolic and diastolic blood pressure. During each measurement, the monitor records all the pulse intervals and calculate the average ; if there are two or more pulse intervals ,the difference between each interval and the average is more than the average value of $\pm 25\%$, or there are four or more pulse intervals ,the difference between each interval and the average is more than the average value of $\pm 15\%$,the irregular heartbeat symbol appears on the display when the measurement results are appear.

⚠ CAUTION

The appearance of the IHB icon indicates that a pulse irregularity consistent with an irregular heartbeat was detected during measurement. Usually this is NOT a cause for concern. However, if the symbol appears often, we recommend you seek medical advice. Please note that the device does not replace a cardiac examination, but serves to detect pulse irregularities at an early stage.

♥ Why does my blood pressure fluctuate throughout the day?

1. Individual blood pressure varies multiple times everyday. It is also affected by the way you tie your cuff and your measurement position, so please take the measurement under the same conditions.

2.If the person takes medicine, the pressure will vary more.

3.Wait at least 3 minutes for another measurement.

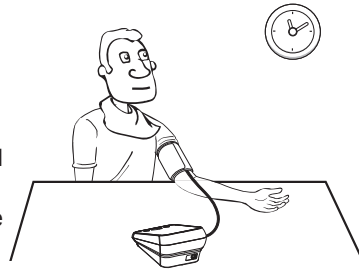

♥ Why do I get a different blood pressure at home compared to the hospital?

The blood pressure is different even throughout the day due to weather, emotion, exercise etc, Also, there is the “white coat” effect, which means blood pressure usually increases in clinical settings.

What you need to pay attention to when you measure your blood pressure at home:

- If the cuff is tied properly.
- If the cuff is too tight or too loose.
- If the cuff is tied on the upper arm.
- If you feel anxious.
- Taking 2-3 deep breaths before beginning will be better for measuring.
- Advice: Relax yourself for 4-5 minutes until you calm down.

♥ Is the result the same if measuring on the right arm?

It is ok for both arms, but there will be some different results for different people. We suggest you measure the same arm every time.



This section includes a list of error messages and frequently asked questions for problems you may encounter with your blood pressure monitor. If the products not operating as you think it should, check here before arranging for servicing.

PROBLEM	SYMPTOM	CHECK THIS	REMEDY
No power	Display will not light up.	Batteries are exhausted.	Replace with new batteries
		Batteries are inserted incorrectly. AC adaptor is inserted incorrectly.	Insert the batteries correctly Insert the AC adaptor tightly
Low batteries	Display is dim or shows +Lo	Batteries are low.	Replace with new batteries
Error message	E 1 shows	Communication error	Check if the APP is on, operate and send the data again.
	E 3 shows	The cuff is not secure.	Readjust the cuff and relax for a moment and then measure again.
	E10 or E11 shows	The monitor detected motion,talking or the pluse is too poor while measuring.	Movement can affect the measurement.Relax for a moment and then measure again.
	E20 shows	The measurement process does not detect the pulse signal.	Loosen the clothing on the arm and then measure again
	E21 shows	The treatment of the measurement failed.	Relax for a moment and then measure again.
	EExx,shows on the display.	A calibration error occurred.	Retake the measurement. If the problem persists, contact the retailer or our customer service department for further assistance.Refer to the warranty for contact information and return instructions.
Warning message	“out ” shows	Out of measurement range	Relax for a moment. Refasten the cuff and then measure again. If the problem persists, contact your physician.

Power supply	Battery powered mode: 6VDC 4×AA batteries AC adaptor powered mode: 6V \pm 1A (Please only use the recommended AC adaptor model).
Display mode	Digital LCD V.A.60mm*80mm
Measurement mode	Oscillographic testing mode
Measurement range	Rated cuff pressure: 0mmHg~299mmHg(0kPa ~ 39.9kPa) Measurement pressure: SYS: 60mmHg~230mmHg (8.0kPa~30.7kPa) DIA: 40mmHg~130mmHg (5.3kPa~17.3kPa) Pulse value: (40-199)beat/minute
Accuracy	Pressure: 5 C -40 C within \pm 3mmHg(0.4kPa) Pulse value: \pm 5%
Normal working condition	A temperature range of :+5°C to +40°C A relative humidity range of 15% to 90%, non-condensing, but not requiring a water vapour partial pressure greater than 50 hPa An atmospheric pressure range of : 700 hPa to 1060 hPa
Storage & transportation condition	Temperature:-20°C to +60°C A relative humidity range of \leq 93%, non-condensing, at a water vapour pressure up to 50hPa
Measurement perimeter of the upper arm	About 22cm~32cm or 22cm~42cm
Weight	Approx.300g(Excluding the batteries)
External dimensions	Approx.102mm*143mm*73mm
Attachment	4×AA batteries,user manual,AC adapter
Mode of operation	Continuous operation
Degree of protection	Type BF applied part
Protection against ingress of water	IP21 It means the device could protected against solid foreign objects of 12.5mm and greater, and protect against vertically falling water drops.
Device Classification	Battery Powered Mode: Internally Powered ME Equipment AC Adaptor Powered Mode: Class II ME Equipment
Software Version	Unknow

♥ Authorized Component

1. please use the TRANSTEK authorized adapter.

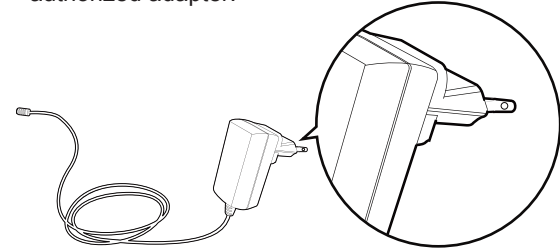

Adaptor

Type: BLJ06L060100P-U

Input: 100-240V, 50-60Hz, 0.2Amax

Output: 6V \pm 1000mA

♥ Contact Information

For more information about our products, please visit www.transtek.cn. you can get customer service, usual problems and customer download, transtek will serve you anytime.

Manufactured by: Guangdong Transtek Medical Electronics Co., Ltd.

Company: Guangdong Transtek Medical Electronics Co., Ltd.

Address: Zone B, No.105, Dongli Road, Torch Development District, Zhongshan, 528437, Guangdong, China

WARNING: No modification of this equipment is allowed.

♥ Complied Standards List

Risk management	EN ISO 14971:2012 / ISO 14971:2007 Medical devices - Application of risk management to medical devices
Labeling	EN ISO 15223-1:2016 / ISO 15223-1:2016 Medical devices. Symbols to be used with medical device labels, labelling and information to be supplied. Part 1 : General requirements
User manual	EN 1041:2008 Information supplied by the manufacturer of medical devices
General Requirements for Safety	EN 60601-1:2006/ IEC 60601-1:2005+A1:2012 Medical electrical equipment - Part 1: General requirements for basic safety and essential performance EN 60601-1-11:2015/ IEC 60601-1-11:2015 Medical electrical equipment - Part 1-11: General requirements for basic safety and essential performance - Collateral standard: Requirements for medical electrical equipment and medical electrical systems used in the home healthcare environment
Electromagnetic compatibility	EN 60601-1-2:2015/ IEC 60601-1-2:2014 Medical electrical equipment - Part 1-2: General requirements for basic safety and essential performance - Collateral standard: Electromagnetic disturbances - Requirements and tests
Performance requirements	EN ISO 81060-1:2012 Non-invasive sphygmomanometers - Part 1: Requirements and test methods for non-automated measurement type EN 1060-3:1997+A2:2009 Non-invasive sphygmomanometers - Part 3: Supplementary requirements for electro-mechanical blood pressure measuring systems IEC 80601-2-30:2013 Medical electrical equipment- Part 2-30: Particular requirements for the basic safety and essential performance of automated non-invasive sphygmomanometers
Clinical investigation	EN 1060-4:2004 Non-invasive sphygmomanometers - Part 4: Test procedures to determine the overall system accuracy of automated non-invasive sphygmomanometers ISO 81060-2:2013 Non-invasive sphygmomanometers - Part 2: Clinical validation of automated measurement type
Usability	EN 60601-1-6:2010/IEC 60601-1-6:2010+A1:2013 Medical electrical equipment - Part 1-6: General requirements for basic safety and essential performance - Collateral standard: Usability EN 62366-1:2015/ IEC 62366-1:2015 Medical devices - Part 1: Application of usability engineering to medical devices
Software life-cycle processes	EN 62304:2006/AC: 2008 / IEC 62304:2006 Medical device software - Software life-cycle processes
Bio-compatibility	ISO 10993-1:2009 Biological evaluation of medical devices- Part 1: Evaluation and testing within a risk management process ISO 10993-5:2009 Biological evaluation of medical devices - Part 5: Tests for in vitro cytotoxicity ISO 10993-10:2010 Biological evaluation of medical devices - Part 10: Tests for irritation and skin sensitization

♥ FCC Statement

FCC ID:OU9TMB995-BS

This device complies with Part 15 of the FCC Rules. Operation is subject to the following two conditions: (1) this device may not cause harmful interference, and (2) this device must accept any interference received, including interference that may cause undesired operation.

Caution: The user is cautioned that changes or modifications not expressly approved by the party responsible for compliance could void the user's authority to operate the equipment.

NOTE: This equipment has been tested and found to comply with the limits for a Class B digital device, pursuant to Part 15 of the FCC Rules. These limits are designed to provide reasonable protection against harmful interference in a residential installation. This equipment generates, uses and can radiate radio frequency energy and, if not installed and used in accordance with the instructions, may cause harmful interference to radio communications. However, there is no guarantee that interference will not occur in a particular installation.

If this equipment does cause harmful interference to radio or television reception, which can be determined by turning the equipment off and on, the user is encouraged to try to correct the interference by one or more of the following measures:

- Reorient or relocate the receiving antenna.
- Increase the separation between the equipment and receiver.
- Connect the equipment into an outlet on a circuit different from that to which the receiver is connected.
- Consult the dealer or an experienced radio/TV technician for help.

FCC Radiation Exposure Statement:

This equipment complies with FCC radiation exposure limits set forth for an uncontrolled environment.

This transmitter must not be co-located or operating in conjunction with any other antenna or transmitter.

♥ EMC Guidance

- 1) This product needs special precautions regarding EMC and needs to be installed and put into service according to the EMC information provided, and this unit can be affected by portable and mobile RF communications equipment.
- 2)* Do not use a mobile phone or other devices that emit electromagnetic fields, near the unit. This may result in incorrect operation of the unit.
- 3) Caution: This unit has been thoroughly tested and inspected to assure proper performance and operation!
- 4)* Caution: This machine should not be used adjacent to or stacked with other equipment and that if adjacent or stacked use is necessary, this machine should be observed to verify normal operation in the configuration in which it will be used.

Table 1

Guidance and manufacturer's declaration – electromagnetic emissions		
The device is intended for use in the electromagnetic environment specified below. The customer or the user of the device should assure that it is used in such an environment.		
Emissions test	Compliance	Electromagnetic environment - guidance
RF emissions CISPR 11	Group 1	The device uses RF energy only for its internal function. Therefore, its RF emissions are very low and are not likely to cause any interference in nearby electronic equipment.
RF emissions CISPR 11	Class B	The device is suitable for use in all establishments, other than domestic and those directly connected to the public low-voltage power supply network that supplies buildings used for domestic purposes.
Harmonic emissions IEC 61000-3-2	Class A	
Voltage fluctuations/ flicker emissions IEC 61000-3-3	Complies	

Table 2

Guidance and manufacturer's declaration – electromagnetic immunity			
The device is intended for use in the electromagnetic environment specified below. The customer or the user of the device should assure that it is used in such an environment.			
Immunity test	IEC 60601 test level	Compliance level	Electromagnetic environment - guidance
Electrostatic discharge (ESD) IEC 61000-4-2	±8 kV contact ±15 kV air	±8 kV contact ±15 kV air	Floors should be wood, concrete or ceramic tile. If floors are covered with synthetic material, the relative humidity should be at least 30%.
Electrical fast transient/burst IEC 61000-4-4	power supply lines: ±2 kV input/output lines: ±1 kV	power supply lines: ±2 kV	Mains power quality should be that of a typical commercial or hospital environment.
Surge IEC 61000-4-5	line(s) to line(s): ±1 kV line(s) to earth: ±2 kV 100 kHz repetition frequency	line(s) to line(s): ±1 kV 100 kHz repetition frequency	Mains power quality should be that of a typical commercial or hospital environment.
Voltage dips, short interruptions and voltage variations on power supply input lines IEC 61000-4-11	0%U _T ; 0.5 cycle At 0°, 45°, 90°, 135°, 180°, 225°, 270° and 315° 0%U _T ; 1 cycle and 70%U _T ; 25/30 cycles Single phase: at 0° 0%U _T ; 300 cycle	0%U _T ; 0.5 cycle At 0°, 45°, 90°, 135°, 180°, 225°, 270° and 315° 0%U _T ; 1 cycle and 70%U _T ; 25/30 cycles Single phase: at 0° 0%U _T ; 300 cycle	Mains power quality should be that of a typical commercial or hospital environment.
Power frequency (50Hz/60Hz) magnetic field IEC 61000-4-8	30 A/m 50Hz/60Hz	30 A/m 50Hz/60Hz	Power frequency magnetic fields should be at levels characteristic of a typical location in a typical commercial or hospital environment.
NOTE U _T is the a.c. mains voltage prior to application of the test level.			

Table 3

Guidance and manufacturer's declaration – electromagnetic immunity			
The device is intended for use in the electromagnetic environment specified below. The customer or the user of the device should assure that it is used in such an environment.			
Immunity test	IEC 60601 Test level	Compliance level	Electromagnetic environment - guidance
Conducted RF IEC 61000-4-6	150 kHz to 80 MHz: 3 Vrms 6Vrms (in ISM and amateur radio bands) 80% Am at 1kHz	150 kHz to 80 MHz: 3 Vrms 6Vrms (in ISM and amateur radio bands) 80% Am at 1kHz	Portable and mobile RF communications equipment should be used no closer to any part of the device, including cables, than the recommended separation distance calculated from the equation appropriate for the frequency of the transmitter. Recommended separation distances: $d=0.35\sqrt{P}$; $d=1.2\sqrt{P}$
Radiated RF IEC 61000-4-3	10V/m, 80% Am at 1kHz	10V/m, 80% Am at 1kHz	80 MHz to 800 MHz: $d=1.2\sqrt{P}$ 800 MHz to 2.7 GHz: $d=2.3\sqrt{P}$ where, P is the maximum output power rating of the transmitter in watts (W) according to the transmitter manufacturer, d is the recommended separation distance in meters (m). Field strengths from fixed RF transmitters, as determined by an electromagnetic site survey, should be less than the compliance level in each frequency range. Interference may occur in the vicinity of equipment marked with the following symbol: 
NOTE 1 At 80 MHz and 800 MHz, the higher frequency range applies.			
NOTE 2 These guidelines may not apply in all situations. Electromagnetic propagation is affected by absorption and reflection from structures, objects and people.			
<p>a Field strengths from fixed transmitters, such as base stations for radio (cellular / cordless) telephones and land mobile radios, amateur radio, AM and FM radio broadcast and TV broadcast cannot be predicted theoretically with accuracy. To assess the electromagnetic environment due to fixed RF transmitters, an electromagnetic site survey should be considered. If the measured field strength in the location in which the device is used exceeds the applicable RF compliance level above, the device should be observed to verify normal operation. If abnormal performance is observed, additional measures may be necessary, such as re-orienting or relocating the device.</p> <p>b Over the frequency range 150 kHz to 80 MHz, field strengths should be less than 3V/m.</p>			

Table 4

Recommended separation distances between portable and mobile RF communications equipment and the device.			
The device is intended for use in an electromagnetic environment in which radiated RF disturbances are controlled. The customer or the user of the device can help prevent electromagnetic interference by maintaining a minimum distance between portable and mobile RF communications equipment (transmitters) and the device as recommended below, according to the maximum output power of the communications equipment.			
Rated maximum output power of transmitter (W)	Separation distance according to frequency of transmitter (m)		
	150 kHz to 80 MHz $d = 3.5\sqrt{P}$	80 MHz to 800 MHz $d = 1.2\sqrt{P}$	800 MHz to 2.7 GHz $d = 2.3\sqrt{P}$
0.01	0.12	0.12	0.23
0.1	0.37	0.38	0.73
1	1.2	1.2	2.3
10	3.8	3.8	7.3
100	12	12	23
For transmitters rated at a maximum output power not listed above, the recommended separation distance d in metres (m) can be estimated using the equation applicable to the frequency of the transmitter, where P is the maximum output power rating of the transmitter in watts (W) according to the transmitter manufacturer.			
NOTE 1 At 80 MHz and 800 MHz, the separation distance for the higher frequency range applies.			
NOTE 2 These guidelines may not apply in all situations. Electromagnetic propagation is affected by absorption and reflection from structures, objects and people.			

Table 5

Guidance and manufacturer's declaration - electromagnetic immunity							
The device is intended for use in the electromagnetic environment specified below. The customer or the user of the device, should assure that it is used in such an environment.							
Radiated RF IEC61000-4-3 (Test specifications for ENCLOSURE PORT IMMUNITY to RF wireless communications equipment)	Test Frequency (MHz)	Band a)	Service a)	Modulation b)	Modulation b) (W)	Distance (m)	IMMUNITY TEST LEVEL (V/m)
	385	380-390	TETRA 400	Pulse modulation b) 18Hz	1.8	0.3	27
	450	380-390	GMRS 460, FRS 460	FM c) ± 5kHz deviation 1kHz sine	2	0.3	28
	710	704-787	LTE Band 13, 17	Pulse modulation b) 217Hz	0.2	0.3	9
	745						
	780						
	810	800-960	GSM 800/900, TETRA 800, IDEN 820, CDMA 850, LTE Band 5	Pulse modulation b) 18Hz	2	0.3	28
	870						
	930						
	1720	1700-1990	GSM 1800; CDMA 1900; GSM 1900; DECT; LTE Band 1, 3, 4,25; UMTS	Pulse modulation b) 217Hz	2	0.3	28
	1845						
	1970						
	2450	2400-2570	Bluetooth, WLAN, 802.11 b/g/n, RFID 2450, LTE Band 7	Pulse modulation b) 217 Hz	2	0.3	28
	5240	5100-5800	WLAN 802.11 a/n	Pulse modulation b) 217 Hz	0.2	0.3	9
	5240						
	5785						
NOTE If necessary to achieve the IMMUNITY TEST LEVEL, the distance between the transmitting antenna and the ME EQUIPMENT or ME SYSTEM may be reduced to 1 m. The 1 m test distance is permitted by IEC 61000-4-3.							
a) For some services, only the uplink frequencies are included.							
b) The carrier shall be modulated using a 50% duty cycle square wave signal.							
c) As an alternative to FM modulation, 50% pulse modulation at 18 Hz may be used because while it does not represent actual modulation, it would be worst case.							
The MANUFACTURER should consider reducing the minimum separation distance, based on RISK MANAGEMENT, and using higher IMMUNITY TEST LEVELS that are appropriate for the reduced minimum separation distance. Minimum separation distances for higher IMMUNITY TEST LEVELS shall be calculated using the following equation:							
$E = \frac{6}{d} \sqrt{P}$							
Where P is the maximum power in W, d is the minimum separation distance in m, and E is the IMMUNITY TEST LEVEL in V/m.							