

Digital 7" LCD Audio/Video Baby Monitor

User's Manual

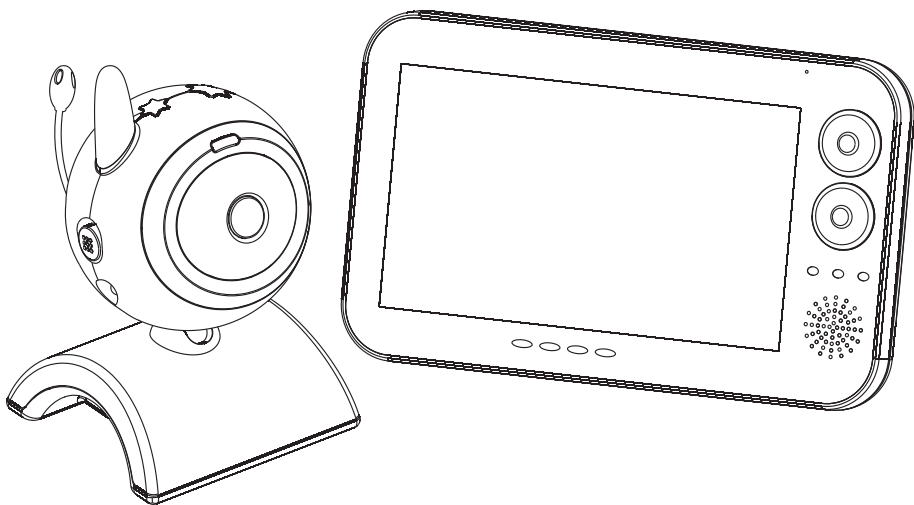

Figures and Quick Guide

Product Layout

Monitor

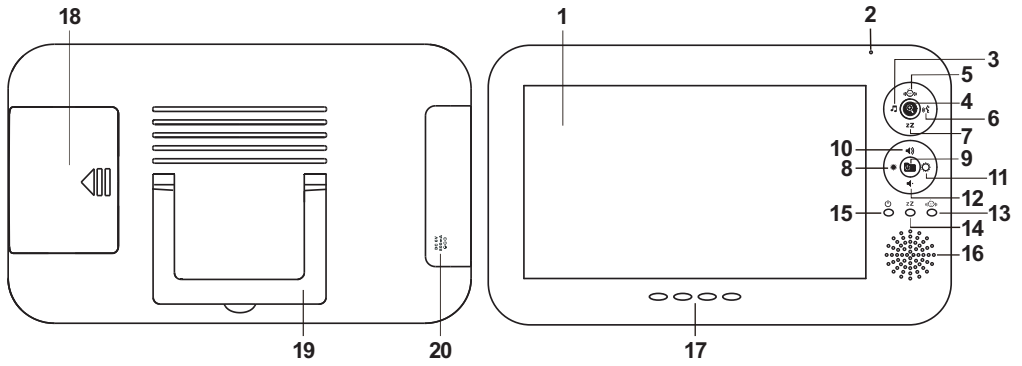

Fig. 1

Camera

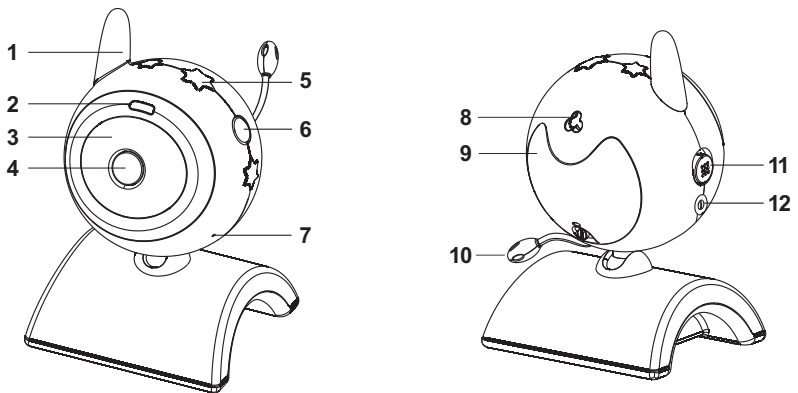

Fig. 2

Setup

1 Camera Setup

1.1 Power Supply

Loading the Batteries

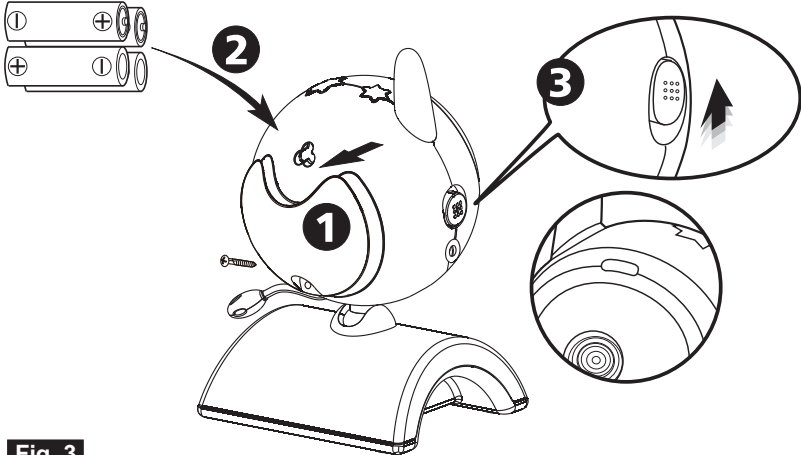

Fig. 3

Using AC Power

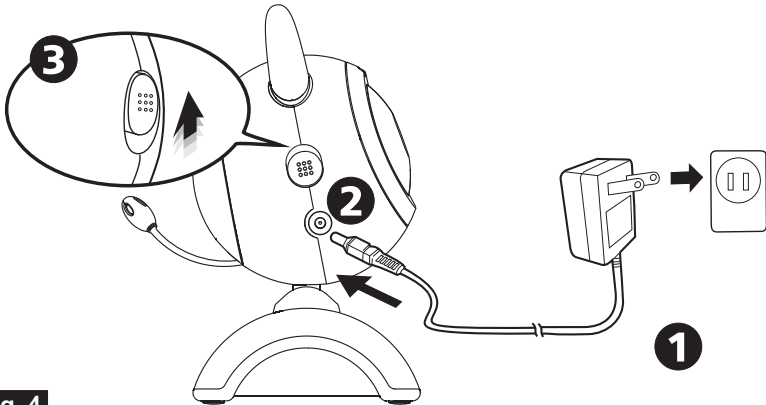

Fig. 4

1.2 Fine Tuning

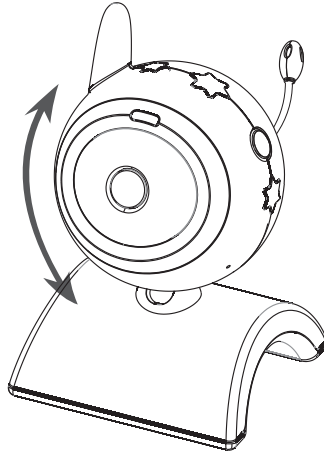

Fig. 5

1.3 Night light

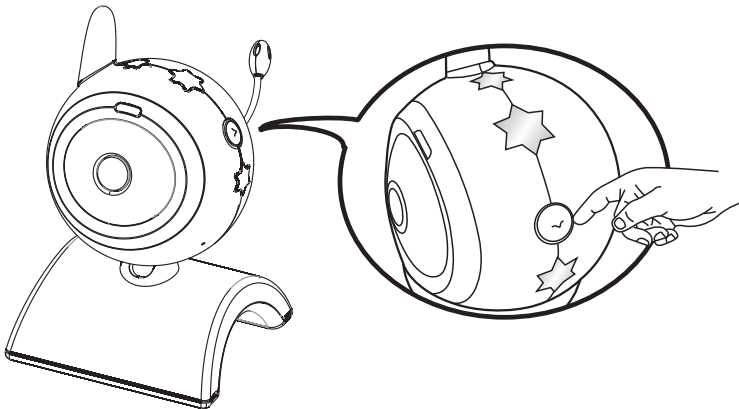
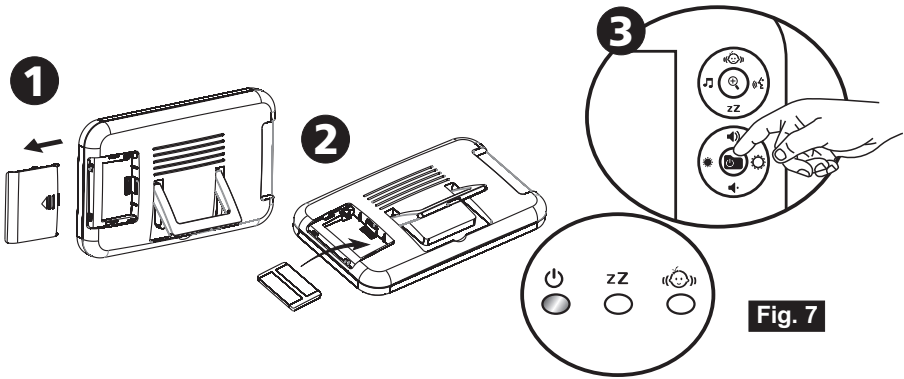

Fig. 6

2 Monitor Setup

2.1 Power Supply *Loading the Battery*



Using AC Power

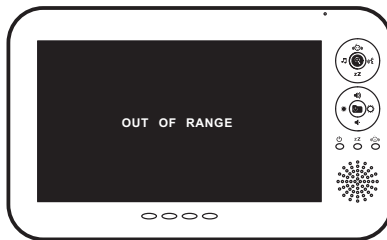
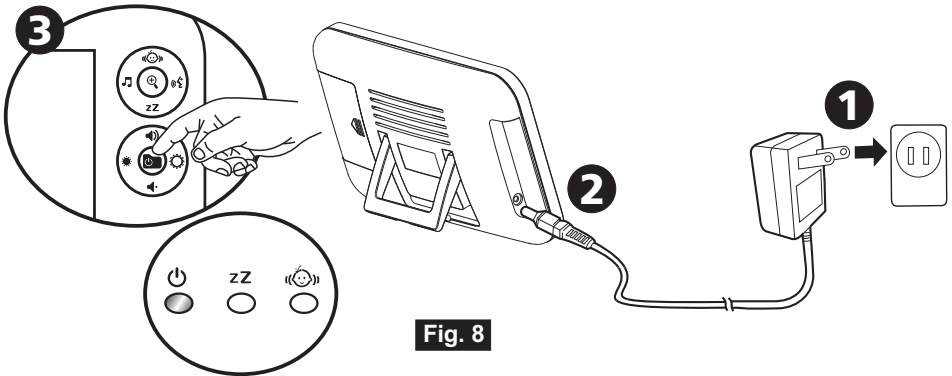

2.2 Volume Setting

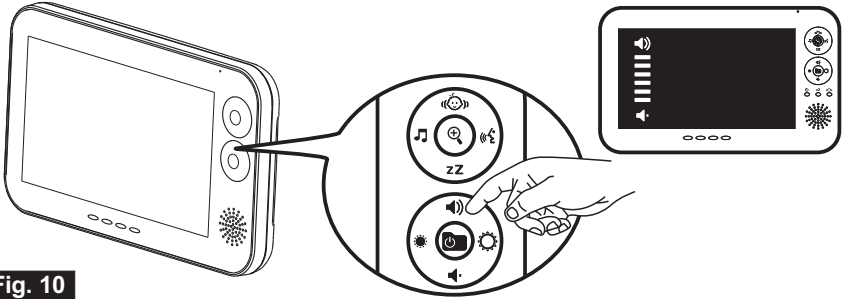

Fig. 10

2.3 Brightness Setting

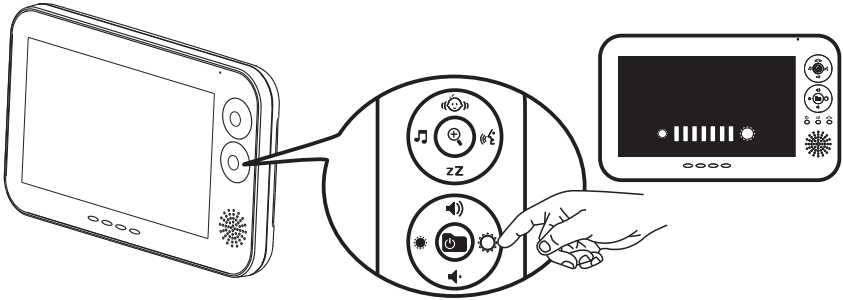

Fig. 11

2.4 VOX (voice-operated transmission) Function

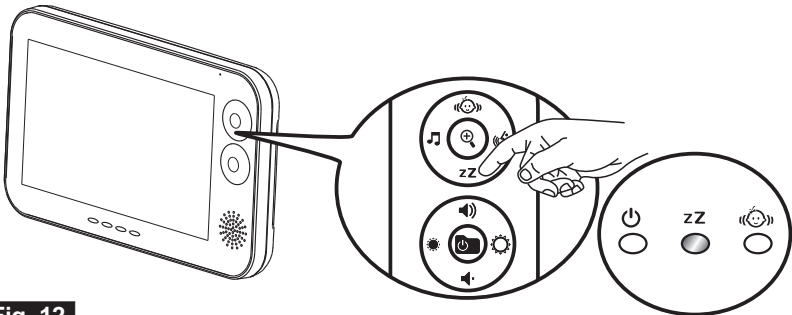

Fig. 12

2.5 Motion Detection Function

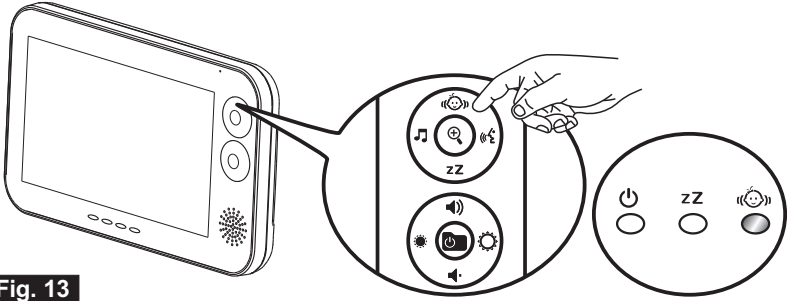

Fig. 13

2.6 Music Function

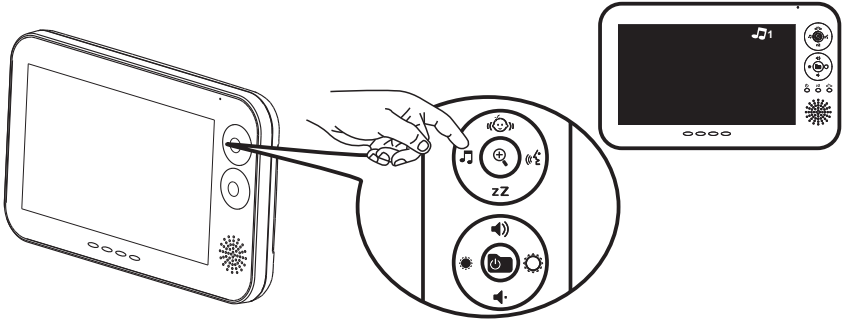
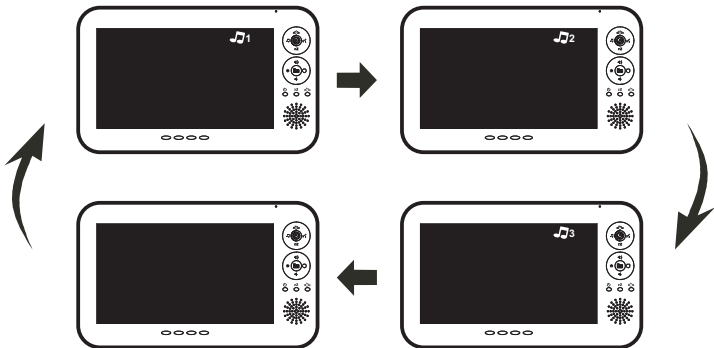

Fig. 14



2.7 Talkback Function

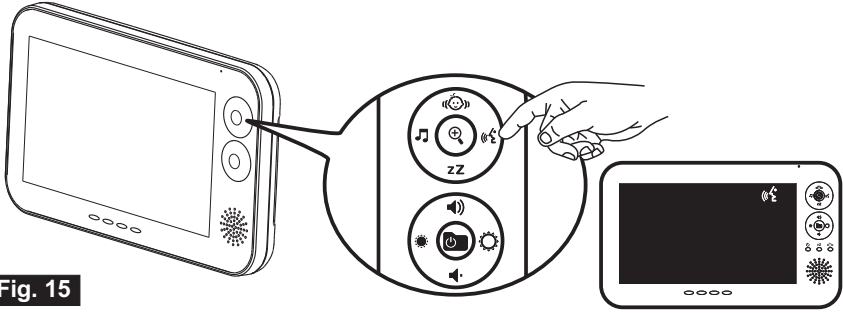

Fig. 15

2.8 Zoom In Function

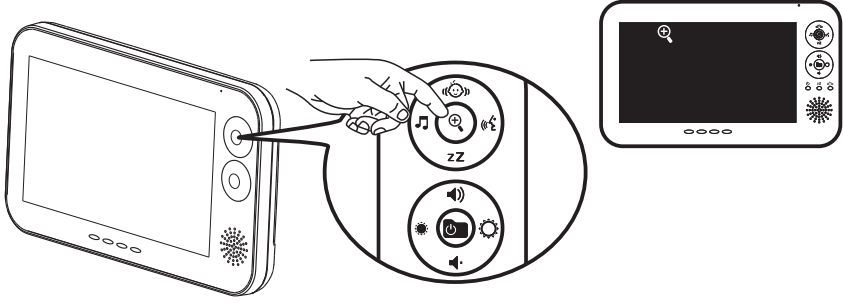

Fig. 16

3 Menu Options

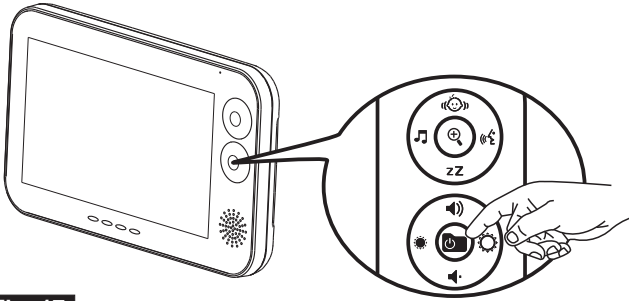

Fig. 17

3.1 Camera Selection

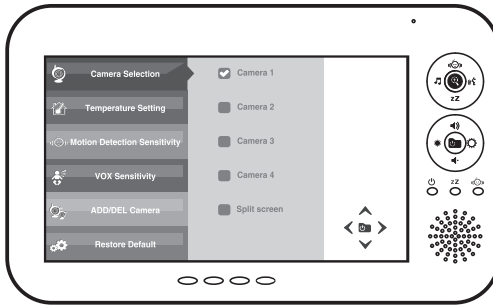

Fig. 18

3.2 Temperature Setting

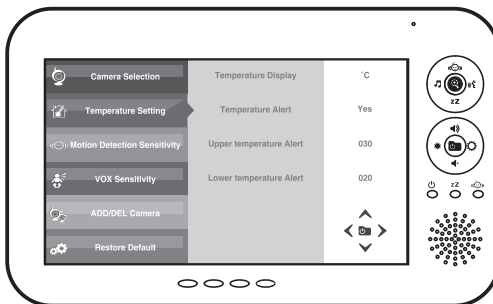

Fig. 19

3.3 Motion Detection Sensitivity

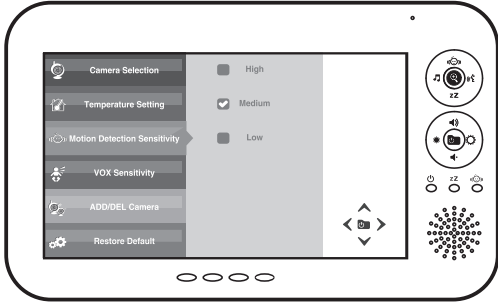

Fig. 20

3.4 VOX Sensitivity

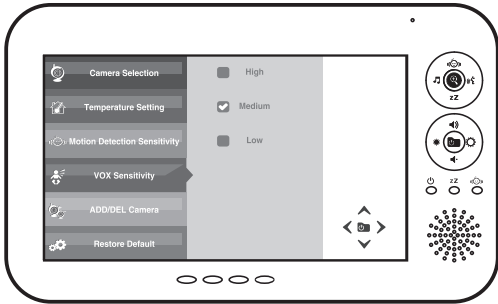

Fig. 21

3.5 ADD/DEL Camera

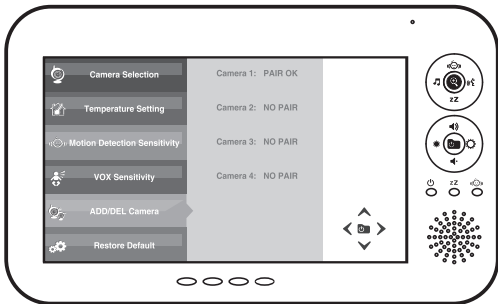

Fig. 22

3.6 Restore Default

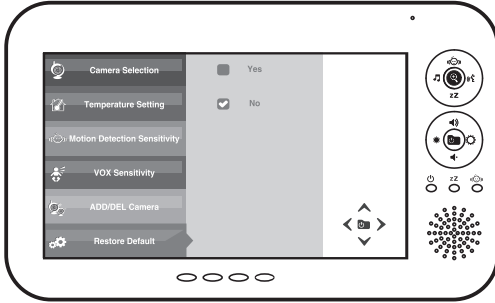

Fig. 23

4 Screen Display

4.1 Single Mode

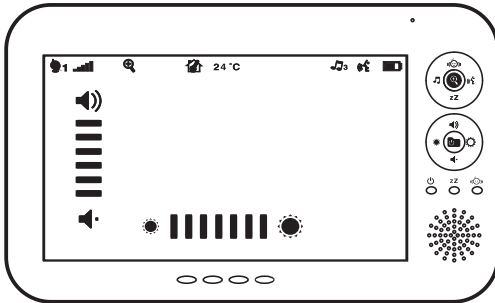

Fig. 24

4.2 Quad Mode

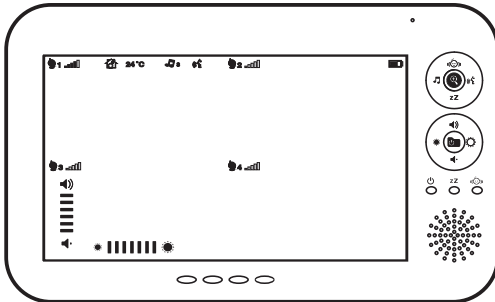

Fig. 25

Package Content

- One Camera
- One Monitor
- Two Power Adapters
- Battery for Monitor (3.7V 1050mAH Li-ion)
- This User's Manual

Product Layout

Monitor (Fig. 1)

1. LCD screen
2. Microphone
3. Music selection (Zoom in : left) button
4. Zoom (Camera selection in quad mode) button
5. Motion detection (Zoom in : up) button
6. Talkback (Zoom in : right) button
7. VOX (Zoom in : down) button
8. Brightness down (Menu : left/exit) button
9. Power (Menu) button
10. Volume up (Menu : up) button
11. Brightness up (Menu : right/ok) button
12. Volume down (Menu : down) button
13. Motion detection indicator LED
14. VOX indicator LED
15. Power indicator LED
16. Speaker
17. Volume indicator LEDs
18. Battery compartment
19. Holder
20. Power adapter plug

Camera (Fig. 2)

1. Antenna
2. Power indicator LED
3. Infrared LEDs
4. Lens
5. Night-light
6. Night-light button
7. Microphone
8. Speaker
9. Battery compartment
10. Temperature sensor
11. Power ON/OFF switch
12. Power adapter plug

Setup

1 Camera Setup

1.1 Power Supply

The camera uses either 4 AAA-Size batteries (alkaline battery recommended) or the household AC power current.

Loading the Batteries

1. Open the battery compartment cover on the rear of the camera. See Fig. 3.
2. Insert 4 AAA-size batteries (follow the plus (+) and minus (-) signs inside the battery compartment). See Fig. 3.
3. Close the battery compartment cover, and make sure it is locked securely.

Note 1: Do not mix old batteries with new ones.

Note 2: Remove the batteries from the camera if you do not plan to use it for a prolonged period of time.

4. Slide the POWER switch to the ON position. The LED on the camera will light up (green light). See Fig. 3.

Note : When the battery is low, the LED light will start blinking.

Using AC Power

1. Plug one end of the provided power adapter into a wall outlet and the other end into the bottom of the camera. See Fig. 4.

Note : Use the adapter labeled OUTPUT: 6V DC with the camera.

2. Slide the ON/OFF switch to the ON position. The LED on the camera should light up (green light). See Fig. 4.

1.2 Fine Tuning

Place the camera in a convenient location, point the lens towards the observation area and adjust the angle by rotating the lens head. See Fig. 5.

1.3 Night light

Press the night light button, the night light LEDs will remain ON. See Fig. 6.

1.4 Night vision

The camera has nine high-intensity LEDs for picking up clear images in the dark. When the built-in photo sensor detects low ambient light levels, the LEDs will automatically activate.

1.5 Room temperature measurement

Temperature sensor can measure room temperature on camera side and the room temperature indicator will be displayed on the screen of the monitor unit.

2 Monitor Setup

2.1 Power Supply

The monitor uses 3.7V 1050mAh (Li-ion) battery or the household AC power current.

Loading the Battery

1. Open the battery compartment cover on the rear of the monitor. See Fig. 7.
2. Insert the battery with the metal facing the battery compartment. See Fig 7.
3. Close the battery compartment cover, and make sure it is locked securely.
4. Press the POWER button to turn on the monitor . See Fig 7.

Note 1: When power is sufficient, the light is green ; When battery is low, the red LED light will start blinking.

Note 2: Remove the battery from the monitor if you do not plan to use it for a prolonged period of time.

Note 3: Press the POWER button and keep it around 3 seconds to turn off the monitor.

Using AC Power

1. Plug one end of the provided power adapter into a wall outlet and the other end into the bottom of the monitor. See Fig. 8.

Note : Use the adapter labeled OUTPUT: 6V DC with the monitor.

2. Press the POWER button to turn on the monitor . See Fig 8.

Note 1: When charging starts, and "Power" LED will appear blue .
If charging is finished (fully charged), the "Power" LED will turn green.

Note 2: "OUT OF RANGE" would be displayed on the LCD screen if the monitor is exceeds the range (unlink).is exceeds the range (unlink).
See Fig. 9.

Note 3: Press the POWER button and keep it around 3 seconds to turn off the monitor.

2.2 Volume Setting

Press the volume selection button  &  to adjust volume level. See Fig. 10.



2.3 Brightness Setting

Press the Brightness selection button  &  to adjust brightness. See Fig. 11.

2.4 VOX (Voice-activation transmission) function



1. Press the VOX button **zz** on the monitor unit. This will turn off the screen but the VOX LED **zz** will remain ON (green). See Fig. 12.
2. When the sound from the camera reaches the set level (See Fig. 21), the screen will turn on automatically. It will turn off again after 30 seconds.

2.5 Motion Detection Function



1. Press the motion detection button  on the monitor unit, and then the motion detection LED  will remain ON (green). See Fig. 13.
2. When the baby or object movement from the camera side reaches the setting level, a warning sound will be emitted from the monitor unit.

2.6 Music Function









You can play the music with the camera (three pieces of music) .

1. Press the music button  , the camera will play music. See Fig. 14.
2. Press the music button  again, the camera will play the next song.













2.7 Talkback Function

Press the talkback button  to speak through the camera unit, and the  icon will then be displayed on screen. See Fig. 15.

2.8 Zoom in Function

1. When the monitor is in single mode (screen display), press the zoom button  can set video at double size. See Fig. 16.
2. When the video is in double size, the  **zz**   (   ) buttons can be used to view the parts outside on the monitor unit screen.
3. Press the zoom button  again to return to normal size.

3 Menu Options

1. Press the power/menu button on the monitor unit to display the menu on the screen. See Fig. 17.
2. Use the     (   ) buttons to navigate through the menu.
3. Press the  () or () buttons to confirm a setting.
4. Press the  () button to exit the menu.
5. The main menu contains 6 submenus.

3.1 Camera Selection

In this submenu you can switch between multiple cameras. You also can select "Split screen" item to display the video of all 4 cameras simultaneously in quad mode. See Fig. 18.

3.2 Temperature Setting

1. In this submenu you can choose the temperature unit between degrees Celsius or degrees Fahrenheit. See Fig. 19.
2. You can set the temperature range of the temperature alert. If you select "Yes" to enable the temperature alert and the temperature is outside the range, a warning sound will be emitted from the monitor unit.

3.3 Motion Detection Sensitivity

This submenu lets you choose the motion detection sensitivity level. Please set an appropriate level in your environment. See Fig. 20.

3.4 VOX Sensitivity

This submenu lets you choose the VOX (voice-activation transmission) sensitivity level. With the level set to high, the microphone will detect lower sounds. See Fig. 21.

3.5 ADD/DEL Camera

The system comes with a camera unit that has already been paired with the monitor unit. The pairing function gives each baby unit a separate channel on the monitor unit. This is necessary for configuring additional camera units. See Fig. 22.

1. If you want to add a new camera, please choose which number of cameras you want to add, and then select "Yes" item on "Add camera" function. Please also press and keep the night-light button on camera side at the same time.
2. If you want to delete a paired camera, please choose which number of cameras you want to delete, and then select "Yes" item on "Delete camera" function.

3.6 Restore Default

Select "Yes" to reset the monitor unit to factory default settings. All menu settings will then be reset. See Fig. 23.

Note 1: Pairing settings will not be affected by a reset.

Note 2: When you select "Yes" to reset the monitor, the monitor will turn off automatically. Please press the POWER button to turn on the monitor again.

4 Monitor Setup

You can select single mode or quad mode in camera selection function of submenu. See Fig. 18.

4.1 Single Mode

1. Each of the indicator icons will be displayed on the position of the screen. See Fig. 24.
 - (1) Camera number indicator
 - (2) Signal strength indicator
 - (3) Zoom in indicator
 - (4) Temperature alert on/off indicator
 - (5) Room temperature indicator
 - (6) Music indicator
 - (7) Talkback indicator
 - (8) Battery indicator
 - (9) Volume indicator
 - (10) Brightness indicator
2. When the monitor is in single mode, press the zoom button can set video at double size, and then press the «☺» «zz» «♪» «⌘» (^ v < >) buttons can be used to view the parts outside on the monitor unit screen.

4.2 Quad Mode

1. Each of the indicator icons will be displayed on the position of the screen. See Fig. 25.
 - (1) Camera number indicator
 - (2) Signal strength indicator
 - (3) Temperature alert on/off indicator
 - (4) Room temperature indicator
 - (5) Music indicator
 - (6) Talkback indicator
 - (7) Battery indicator
 - (8) Volume indicator
 - (9) Brightness indicator
2. Press the zoom (camera selection in quad mode) button on the monitor unit and you can select the sound from which cameras you prefer.
3. When the sound from the camera reaches the set level of VOX sensitivity (See Fig. 21), the sound of the monitor will switch to this camera automatically in quad mode.
4. If you enable VOX, motion detection or temperature alert function and one of the cameras is triggered by the functions, the sound of the monitor will switch to this camera automatically in quad mode.

Troubleshooting

You don't getting any signal at all

- Make sure the camera and the monitor are turned on.
- Make sure the power plugs are pushed all the way in.
- If the camera/monitor is powered by batteries, replace all batteries with new ones.

If the signal is poor, or there is interference

- If there is a microwave oven in use in the path between the camera and monitor, remove the microwave oven or turn it off.
- Make sure the camera and the monitor are within range of each other (range of approximately 800 feet; 250 meters in a clear line of sight).
- If the power LED is on but only voice signal input is detected, the monitor can be in voice-activated mode. Press the VOX button to turn on the screen.

Care and Maintenance

- Keep all parts and accessories out of children's reach.
- Fingerprints or dirt on the lens surface can adversely affect camera performances. Avoid touching the lens surface with your fingers.
- Should the lens become dirty, use a blower to blow off dirt and dust, or a soft, dry cloth to wipe off the lens.
- Keep the camera dry. Precipitation, humidity, and other liquids contain minerals will corrode electronic circuits.
- Do not use or store in dusty, dirty areas.
- Do not store in hot areas. High temperatures can shorten the life of electronic devices and warp or melt certain plastics.
- Do not store in very cold areas. When the system warms up (to its normal temperature), moisture can form inside the case, which may damage electronic circuit boards.
- Do not attempt to open the case. Non-expert handling of the device may damage the system.
- Avoid dropping or strong shocks.
- Operate this product using only with the power supply included or provided as an accessory.
- Do not overload electrical outlets or extension cords this can result in fire or electric shocks.
- Do remember that you are using public airwaves when you use the system and that sound and video may be broadcast to other 2.4 GHz receiving devices. Conversations, even from rooms near the camera, may be broadcast. To protect the privacy of your home, always turn the camera off when not in use.

FCC Statement

This equipment has been tested and found to comply with the limits for a Class B digital device, pursuant to Part 15 of the FCC Rules. These limits are designed to provide reasonable protection against harmful interference in a residential installation. This equipment generates, uses and can radiate radio frequency energy and, if not installed and used in accordance with the instructions, may cause harmful interference to radio communications. However, there is no guarantee that interference will not occur in a particular installation. If this equipment does cause harmful interference to radio or television reception, which can be determined by turning the equipment off and on, the user is encouraged to try to correct the interference by one or more of the following measures:

- Reorient or relocate the receiving antenna
- Increase the separation between the equipment and receiver
- Connect the equipment into an outlet on a circuit different from that to which the receiver is connected
- Consult the dealer or an experienced radio/TV technician for help

FCC Label Compliance Statement:

This device complies with Part 15 of the FCC Rules. Operation is subject to the following two conditions: (1) this device may not cause harmful interference, and (2) this device must accept any interference received, including interference that may cause undesired operation.

Caution

- To comply with FCC RF exposure compliance requirements, a separation distance of at least 20 cm must be maintained between the antenna of this device and all persons.
- This Transmitter must not be co-located or operating in conjunction with any other antenna or transmitter.
- Warning: Changes or modifications to this unit not expressly approved by the party responsible for compliance could void the user authority to operate the equipment.

Following the safety tips

To prevent deaths and injuries associated with baby monitor cords :

- Make sure the baby unit and AC adapter cords are always out of reach of the baby at least 3 feet (1 meter) away.

Note : It's important even if your baby is not yet standing or mobile.

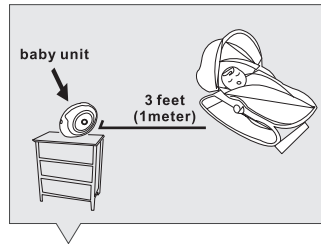
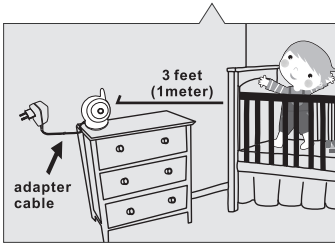

- Use a wireless baby monitor to avoid risk of strangulation.
- Never use extension cords with AC adapters. Only use the AC adapters provided.

Specifications

Camera		Monitor	
Frequency	2.4 GHz	Frequency	2.4 GHz
Antenna	Dipole antenna	Antenna	Monopole antenna
Transmission distance	250 M (Line of Sight)	Modulation	GFSK, FHSS
Modulation	GFSK, FHSS	Display	7" TFT LCD
Image Sensor	Color CMOS	Display colors	Full-color
Lens	f 3.0mm, F 2.4	Brightness Control	Volume Control 7 steps
IR LED	9 pcs	VOX	Voice activation
Dimensions	10(W) x 15.8(H) x 9(D) cm;	Dimensions	20.8(W) x 12.5(H) x 2.7(D) cm
Weight	209g	Weight	404g
Power	DC 6V, 800mA or 4 AAA alkaline batteries	Power	DC 6V, 800mA or Li battery
Operating temperature	0°C ~ 40°C (32°F ~ 104°F)	Operating temperature	0°C ~ 40°C (32°F ~ 104°F)

Specifications subject to change without notice



This device is for indoor use only

This item is in compliance with the essential requirements and other relevant provisions of Directive 1999/5/EC.

408-000706-00
TTD-4291

2013.1.17