

2.4 GHz Digital Wireless USB Camera

User's Manual

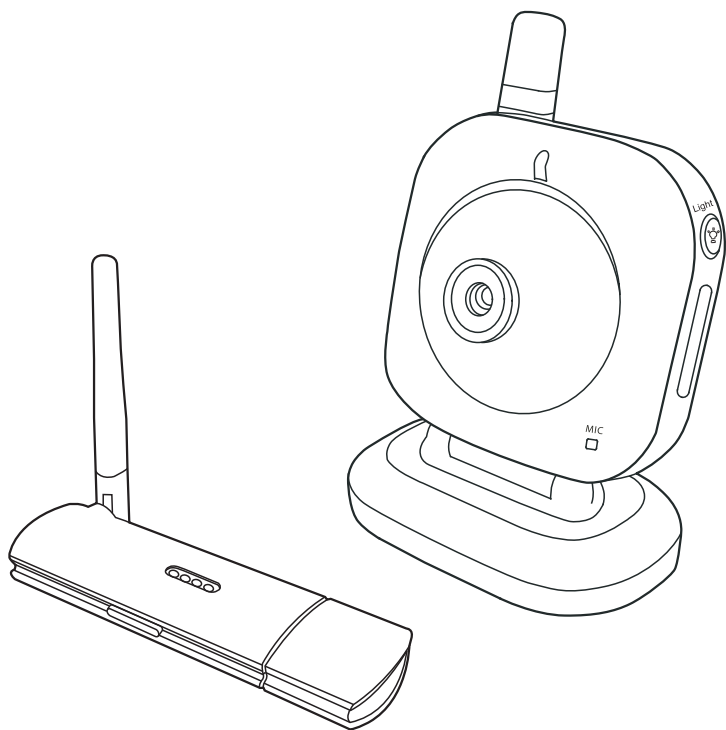

Contents

1 Package Content

2 Product Layout

USB Receiver

Camera

3 PC System Requirements

4 Camera Setup

4.1 Power Supply

4.2 Fine Tuning

4.3 Night Light / Night Vision

5 Receiver Setup

5.1 Windows Detect & Install New Device

5.2 Driver Installation

5.3 Skype Resident Program Installation

5.4 Monitoring Software

5.5 Pairing

6 Details on the Skype Resident Program Installation

7 Troubleshooting

8 Care and Maintenance

9 Specifications

1. Package Content

- One Camera
- One USB Receiver
- One Power Adapter
- CD-ROM
- This User's Manual

2. Product Layout

USB Receiver

1. Antenna
2. Camera indicator LEDs
3. Camera switch / Pairing button*
4. USB plug

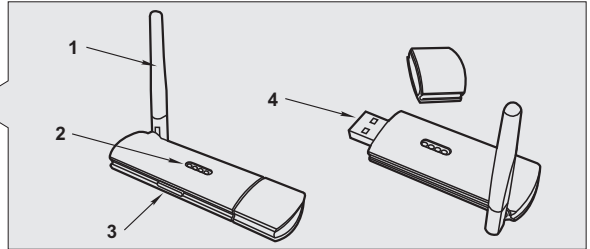

Note: For Pairing, see section 5.5

Camera

1. Antenna
2. Power indicator LED
3. Infrared LEDs
4. Lens
5. Supporting stand
6. Night-light / IR control / pairing button
7. Night-light
8. Microphone
9. Battery compartment
10. Power ON / OFF switch
11. Power adapter socket

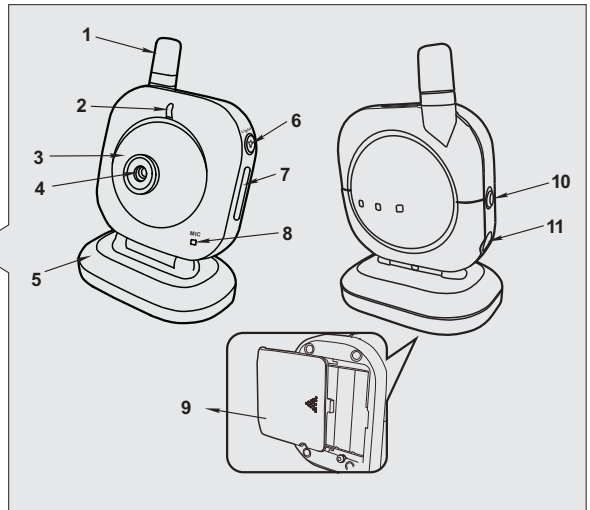

3. PC System Requirements

- Windows® XP(SP2 or higher) or Windows® Vista
- Skype® 3.0 or higher

- Pentium-IV 1.6GHz or higher (recommended)
- 256 MB RAM of system memory or higher (recommended)
- One available USB port (preferably USB2.0)
- Graphics Card (Must support DirectX 9.0c)
- Sound Card (AC97 compatible sound card)
- 1GB Free HD Space
- CD-ROM Drive (For software installation)

4. Camera Setup

4.1 Power Supply

The camera uses either 4 AAA-Size batteries (alkaline battery recommended) or the household AC power current.

Loading the Batteries

1. Loosen the screw on the bottom of the camera by using a screw driver.
2. Open the battery compartment cover.
3. Insert 4 AAA-size batteries (follow the plus (+) and minus (-) signs inside the battery compartment).
4. Close the battery compartment cover, and make sure it is locked securely.

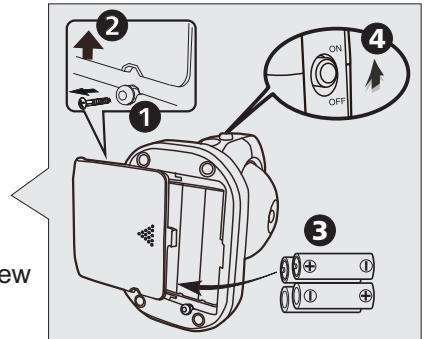

Note 1: Do not mix old batteries with new ones.

Note 2: Remove the batteries from the camera if you do not plan to use it for a prolonged period of time.

5. Slide the POWER switch to the ON position. The LED on the camera will light up (red light).

Note : When battery power is sufficient, the light is constantly red ; when the battery is low, the LED light will start blinking.

Using AC Power

1. Plug one end of the provided power adapter into a wall outlet and the other end into the bottom of the camera.

Note: Use the adapter labeled OUTPUT: 6V DC with the camera.

2. Slide the ON/OFF switch to the ON position. The LED on the camera will light up (red light).

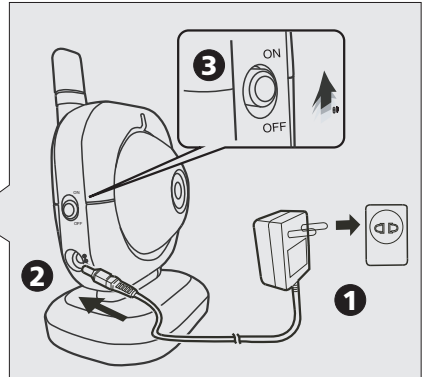

4.2 Fine Tuning

Place the camera in a convenient location, point the lens towards the observation area and adjust the angle by rotating the lens head.

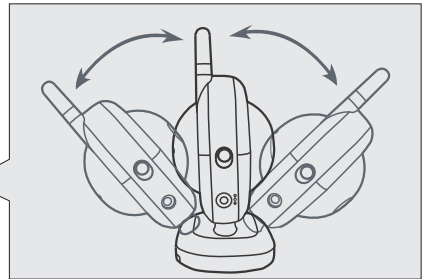

4.3 Night Light / Night Vision

Press the night light button, the night light LEDs will remain ON.

The camera has nine high-intensity infrared LEDs for picking up clear images in unlit locations.

Note: Press the night light button, the image changes automatically into the night vision mode.

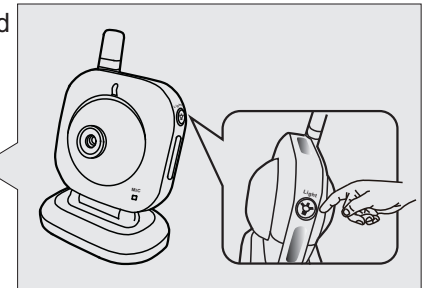

5. Receiver Setup

There are 2 CD disks in the package, **Disk 1:** USB driver software / Skype resident program software, **Disk 2:** AP monitoring software.

Please follow the steps below to setup USB receiver.

5.1 Windows detect & install new device

Make sure the OS of PC is Windows XP and the version is above (or equal) SP2. (Windows Vista is allowable).

1. Insert the USB Receiver into one USB port of PC and the "**Found New Hardware wizard**" screen will appear.

Note: If the device has been searched and the screen isn't showed, please follow **5.2-2**.

2. Choose "**Install the software automatically(Recommended)**" in this screen and click "**Next**". (The wizard will detect & install the device automatically.)
3. Click "**Finish**" to complete the device installation.

Note: In order to let the USB receiver get the best function, we propose strongly to consult the figure while you are operating.

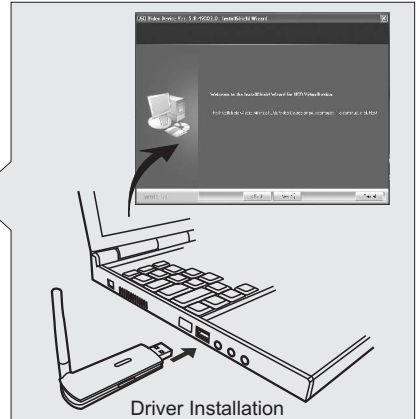

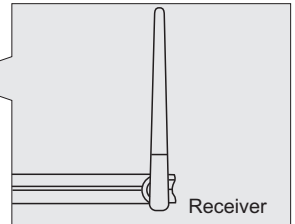

Driver Installation



5.2 Driver installation (Disk 1)

1. Insert the provided CD-ROM into your CD-ROM drive of PC and access to D:\Driver\ (Where D is the letter of your CD-ROM drive).
2. Double-click the execution file named "**RFVideoClassUSB20PCCam_v5.8.5003.X.exe**" and the "**Welcome to the InstallShield Wizard for USB Video Device**" screen will appear.
3. Follow the steps and click "**Finish**" to complete the driver installation.
4. Restart the computer, you can use the USB Receiver correctly now.

Note 1: When the USB driver is well installed and the USB Receiver plug in the computer, you can find  icon on the task tray. If the USB Receiver unplug from the computer, the icon displays with a cross mark .

5.3 Skype resident program installation (Disk 1)

You can watch senior citizen or disabled people through Skype from remote location.

1. Please download and setup Skype software from www.skype.com (free software).
2. Insert the provided CD-ROM into your CD-ROM drive of PC and access to D:\RemoteMonitor-Skype\ (Where D is the letter of your CD-ROM drive).
3. Double-click the execution file named "**rm_e_s.exe**" and the "**Welcome to the Remote Monitoring Setup Wizard**" screen will appear.
4. Follow the steps and click "**Finish**" to complete the driver installation.

Note: For further details on the "Skype resident program installation", see the following section 6 .

5.4 Monitoring Software (Disk 2)

For further details on the "Monitoring software installation", please consult the manual file in the monitoring software disk .

5.5 Pairing

If you have trouble with your USB camera, try the following section 7, or try the following steps:

1. Make sure the camera is turned on, the power LED of the camera is red.
2. Press and hold the Pairing Button on the side of the receiver for about 2 seconds, the LED light will start blinking for about 5 seconds.
3. Press the night light button on the camera during the LED light of the receiver is blinking. When the night light on the camera flash three times, please release the button.
4. The pairing is finished.

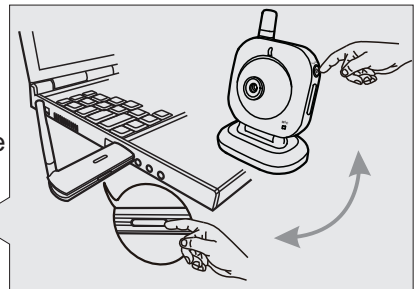

6. Details on the Skype Resident Program

Installation

6.1 Permit remote monitoring program to access Skype

At the first launch of Remote Monitoring program, Skype displays a pop-up message asking allow Remote Monitoring program to access Skype.

Please click **Allow access** button to permit Remote Monitoring program to connect to Skype.

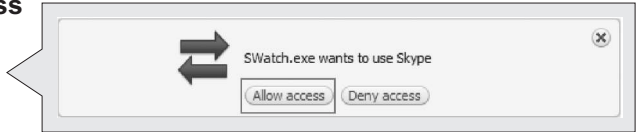

In case if you click **Deny access** button, or forgot to click **Allow access** button, you can enable Remote Monitoring program to access Skype by following steps below.

1. Select Skype's menu command **Tools Options** to open the **Options** dialog box.

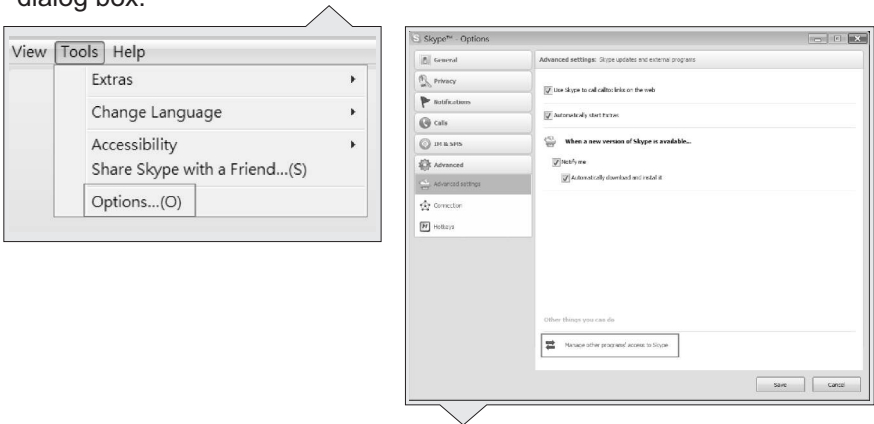

2. In the **Options** dialog box, go to the **Advanced** tab, click the link "Manage other program's access to Skype" to open the **Manage API Access Control** dialog box.

3. In the **Manage API Access Control** dialog box, find program name "**SWatch.exe**". If the program's state is "Not allowed to use Skype", click **Change** button.

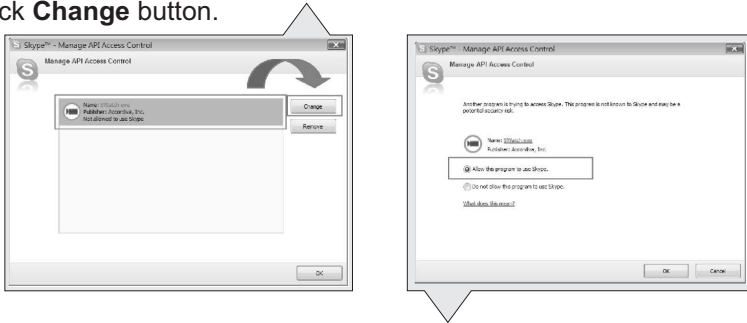



4. In the dialog box, select the option "Allow this program to use Skype ", and then click **OK** button to close the dialog box.
5. Click Save button to close the Options dialog box and confirm the setting change.

6.2 Remote monitoring program operation

Three states of program icon

When the Remote Monitoring program is well installed and launched, you can find its program icon on the task tray .

If the camera's USB dongle unplug from the computer, the program icon displays with a cross mark .

When the Remote Monitoring function is enabled, the program icon displays with a check mark .

Remote Monitoring setting

In the Remote Monitoring tab, you can enable/disable remote monitoring function, change password, set the waiting length to answer a call, and sound off speaker when auto-answer a call.

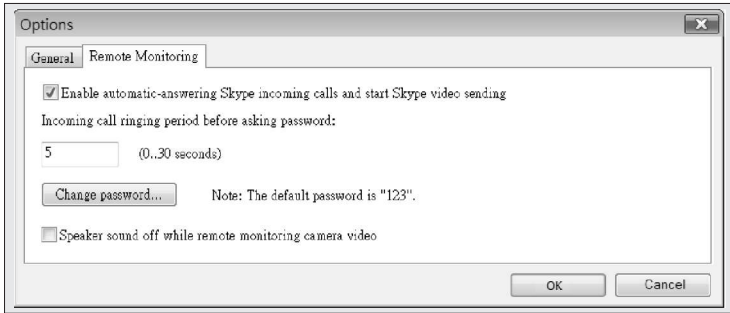

1. Enable automatic-answering Skype incoming calls and start Skype video sending

Check the option to enable the function of Remote Monitoring. Remote Monitoring program will auto-answer Skype calls and ask for a password to start sending Skype video.

2. Incoming call ringing period before asking password

Specify the time length to wait to answer an incoming call. The waiting length can be from 0 to 30 seconds.

3. Change password

The password is used for verifying the identity before sending Skype video. The default password is "123!". You can click **Change password** button to open **Password** dialog box to change the password string.



4. Speak sound off while remote monitoring camera video

Sound off speaker during sending Skype video. The function is useful if you don't want to get attention during watching camera video remotely.

6.3 Interact with Skype to watch camera remotely

You can set up camera to monitor secure area remotely.

Setup camera

1. Turn on the computer and make sure the USB receiver plugged to the computer securely. Adjust the camera view to watch the security area.

2. Run Skype program and the Remote Monitoring program.
3. Enable the remote monitoring function of Remote Monitoring program.

Watch camera video remotely

1. Make a Skype call to the name that hosts the Skype on the computer with camera monitoring the security area.
2. After several ringing, the call will be answered with a chat message asking for a password.

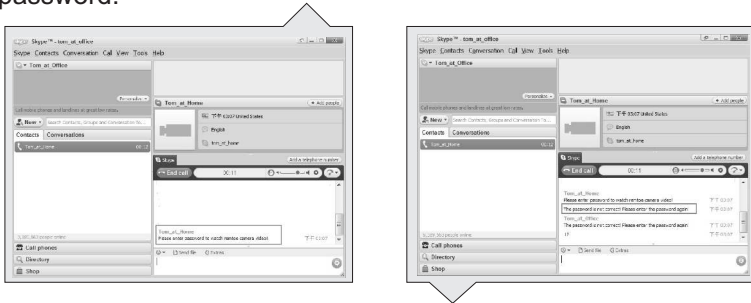

3. If the password you enter is not correct, a chat message will ask you to enter password again.
4. When the password gets passed, the remote came video will display.



5. You can enter commands in Skype chat box to switch cameras, turn on/off Infra-red lights. If the command is correct and accepted, a message "Command received!" will be returned.

The following table lists the available commands and their descriptions.

Command	Description
CAM1	Display the video of camera 1
CAM2	Display the video of camera 2
CAM3	Display the video of camera 3
CAM4	Display the video of camera 4

The following table lists the available commands are for indoor camera only.

LED ON*	Turn on the infra-red light
LED OFF*	Turn off the infra-red light
LED AUTO*	Set the infra-red light to auto-mode. The infra-red light turns on if the lighting condition is not good
LED MANUAL*	Set the infra-red light to manual mode

***Note:** The "LED" means the infrared light of the indoor camera. See the figure

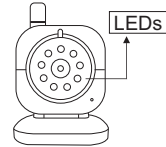

7. Troubleshooting

You don't get a signal at all

- Make sure the camera and the computer are turned on.
- Make sure the power plugs are pushed all the way in.
- If the camera is powered by batteries, replace all batteries with new ones.

If the signal is poor, or there is interference

- Make sure the camera and the USB receiver are within range of each other (range of approximately 450 feet; 150 meters in a clear line of sight).

8. Care and Maintenance

- Keep all parts and accessories out of children's reach.
- Fingerprints or dirt on the lens surface can adversely affect camera performances. Avoid touching the lens surface with your fingers.
- Should the lens become dirty, use a blower to blow off dirt and dust, or a soft, dry cloth to wipe off the lens.
- Keep the camera dry. Precipitation, humidity, and other liquids contain minerals will corrode electronic circuits.
- Do not use or store in dusty, dirty areas.
- Do not store in hot areas. High temperatures can shorten the life of electronic devices and warp or melt certain plastics.
- Do not store in very cold areas. When the system warms up (to its normal temperature), moisture can form inside the case, which may damage electronic circuit boards.
- Do not attempt to open the case. Non-expert handling of the device may damage the system.
- Avoid dropping or strong shocks.
- Operate this product using only with the power supply included or provided as an accessory.
- Do not overload electrical outlets or extension cords this can result in fire or electric shocks.

CE0413ⓘ

This device is for indoor use only

9. Specifications

Camera		Receiver	
Frequency	2.4 GHz	Frequency	2.4 GHz
Antenna	Mono-pole antenna	Antennas	Mono-pole antenna
Transmission distance	150 M (Line of Sight)	Modulation	GFSK, FHSS
Modulation	GFSK, FHSS	Dimensions	3.1(W) x 1(H) x 8.4(D) cm
Image Sensor	Color CMOS image sensor	Weight	16g
Lens	f 3.0mm, F 2.4	Power	USB port
IR LED	9 pcs	Operating temperature	0°C ~ 40°C (32°F ~ 104°F)
Dimensions	8.4(W) x 12.4(H) x 6.1(D) cm		
Weight	175g		
Power	DC 6V, 800mA or 4AAA alkaline batteries		
Operating temperature	0°C ~ 40°C (32°F ~ 104°F)		

Specifications subject to change without notice

FCC Statement

This equipment has been tested and found to comply with the limits for a Class B digital device, pursuant to Part 15 of the FCC Rules. These limits are designed to provide reasonable protection against harmful interference in a residential installation. This equipment generates, uses and can radiate radio frequency energy and, if not installed and used in accordance with the instructions, may cause harmful interference to radio communications. However, there is no guarantee that interference will not occur in a particular installation. If this equipment does cause harmful interference to radio or television reception, which can be determined by turning the equipment off and on, the user is encouraged to try to correct the interference by one or more of the following measures:

- Reorient or relocate the receiving antenna
- Increase the separation between the equipment and receiver
- Connect the equipment into an outlet on a circuit different from that to which the receiver is connected
- Consult the dealer or an experienced radio/TV technician for help

FCC Label Compliance Statement:

This device complies with Part 15 of the FCC Rules. Operation is subject to the following two conditions: (1) this device may not cause harmful interference, and (2) this device must accept any interference received, including interference that may cause undesired operation.

Note: The manufacturer is not responsible for any radio or TV interference caused by unauthorized modifications to this equipment. Such modifications could void the user's authority to operate the equipment.



CAUTION:

For Camera

1. The camera is approved for use with a minimum separation distance of 20cm from persons to comply with FCC RF exposure compliance requirements for mobile exposure conditions in 47 CFR 2.1091.
2. This Transmitter must not be co-located or operating in conjunction with any other antenna or transmitter

For Dongle

The dongle is approved for use in laptop computers to comply with FCC RF exposure compliance requirements for portable exposure conditions in 47 CFR 2.1093.

The 2.4GHz Digital Wireless USB Camera has been tested to the FCC exposure requirements (Specific Absorption Rate).

Trademarks

- Microsoft and Windows are registered trademarks of the U.S. Microsoft Corporation in the United States and other countries.
- Skype is trademark or registered trademark of Skype limited.
- In addition, system and product names used in this manual are, in general, trademarks or registered trademarks of their respective developers or manufacturers. However, the™ or® marks are not used in all cases in this manual.