

# TRICITY BENDIX

Better Products. Better Value.



OPERATING AND INSTALLATION INSTRUCTIONS

MODEL NO.  
**SB 420/SB 421/SB 430**

## TECHNICAL DETAILS

### MODEL NO. SB 420

Voltage:	230/240 Volts AC 50Hz
Wattage:	10.3/11.2kW
Height:	1290mm
Width:	550mm
Depth:	595mm
Weight:	54kg

### MODEL NO. SB 421

Voltage:	230/240 Volts AC 50Hz
Wattage:	11.3/12.3kW
Height:	1290mm
Width:	550mm
Depth:	595mm
Weight:	58kg

### MODEL NO. SB 430

Voltage:	230/240 Volts AC 50Hz
Wattage:	10.3/11.2kW
Height:	1290mm
Width:	550mm
Depth:	595mm
Weight:	56kg

These appliances carry the C.E. Mark.  
These appliances comply with European Council Directive 72/23/EEC.

# CONTENTS

Please refer to the sections in this book which are appropriate to your model.

<b>Technical Details</b> .....	2
<b>Contents</b> .....	3
<b>Preface</b> .....	5
<b>Safety</b> .....	6
Before Installation .....	6
During Operation .....	6
After Use .....	7
General .....	7
<b>Introduction</b> .....	8
Rating Plate .....	8
Installation .....	8
Reversible Main Oven Door .....	9
General Notes .....	9
Condensation and Steam .....	9
Oven Furniture .....	9
<b>Getting to know your Cooker</b> .....	10
The Control Panel (SB 420/ SB 421) .....	10
The Control Panel (SB 430) .....	10
The Timer .....	11
<b>The Radiant Hob (SB 420/ SB 430)</b> .....	14
Recommended Saucepans .....	14
Hints and Tips .....	14
<b>The Solid Hotplates (SB 421)</b> .....	15
<b>Deep Fat Frying</b> .....	16
<b>Preserving</b> .....	16
<b>The Grill</b> .....	17
Uses of the Grill .....	17
Selecting the Grill (SB 420/ SB 421) .....	17
Selecting the Grill (SB 430) .....	17
The Grill Pan and Handle .....	17
Hints and Tips .....	18
Grilling Chart .....	18
<b>The Top Oven (SB 430 Only)</b> .....	19
Uses of the Top Oven .....	19
Selecting the Top Oven .....	19
To Fit the Oven Shelf .....	19
Hints and Tips .....	19
<b>The Main Fan Oven</b> .....	21
Uses of the Fan Oven .....	21
Selecting the Fan Oven .....	21
Things to Note .....	21
To Fit the Oven Shelves .....	21
Hints and Tips .....	22
Oven Cooking Chart .....	23
Roasting Chart .....	24

# CONTENTS

<b>Defrost Feature</b> .....	25
Uses of Defrost .....	25
Selecting Defrost .....	25
Things to Note .....	25
Hints and Tips .....	25
<b>Care and Cleaning</b> .....	26
Cleaning Materials .....	26
Cleaning the Radiant Hob and Hotplate Trims (SB 420/SB 430) .....	26
Cleaning the Solid Hotplates and Hotplate Trims (SB 421 only) .....	26
Cleaning the Outside of the Cooker .....	26
Cleaning the Grill Deflector, Grill Pan, Grid and Oven Shelves .....	27
Cleaning Inside the Oven/Grill Compartments .....	27
Care of Stayclean Surfaces .....	27
Hints and Tips .....	27
Replacing the Oven Light Bulb (SB 430 only) .....	28
<b>Something not Working?</b> .....	29
<b>Service and Spare Parts</b> .....	30
<b>Customer Service Centres</b> .....	31
<b>Guarantee Conditions</b> .....	34

## PREFACE

Dear Customer,

Thank you for buying a Tricity Bendix cooker. With our 80 years experience in developing and manufacturing the very best in U.K. cookers, you can be assured that you have purchased a hard working, reliable, quality product.

Tricity Bendix cookers comply with British Standard safety and performance requirements. They are covered by a 12 month parts and labour guarantee.

To get the best from your new Tricity Bendix cooker, we ask that you PLEASE READ THESE INSTRUCTIONS CAREFULLY. Particular attention should be made to cooking times and temperatures which may differ from your previous cooker.

It is most important that this instruction book is retained with the appliance for future reference. Should the appliance be sold, or if you move house and leave the appliance, always ensure that the book remains with the appliance. This will enable the new owner to be acquainted with the functioning of the appliance and the relevant warnings.

Please read the whole instruction book before attempting to use the appliance ensuring you follow the recommendations given.

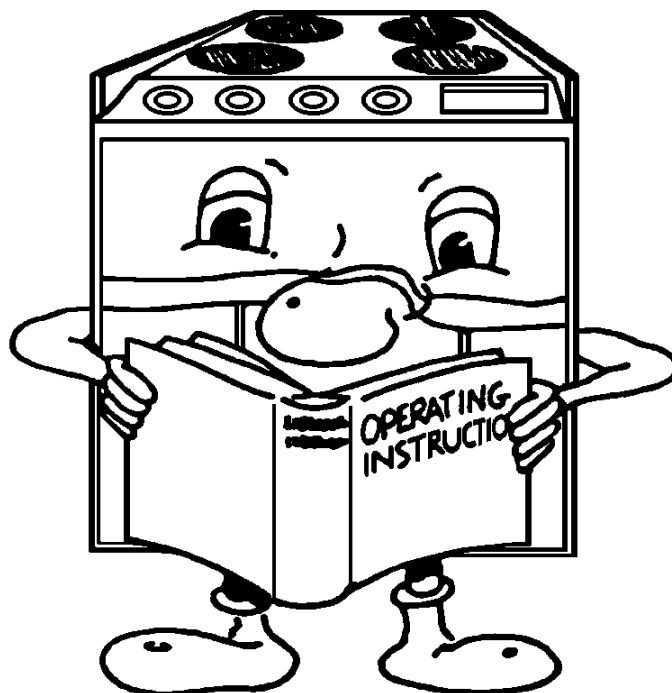

# SAFETY

THESE WARNINGS ARE PROVIDED IN THE INTERESTS OF YOUR SAFETY. ENSURE THAT YOU UNDERSTAND THEM ALL BEFORE INSTALLING OR USING THE COOKER.

PLEASE  
READ  
CAREFULLY



## BEFORE INSTALLATION



This cooker is heavy and care **must** be taken when moving it.

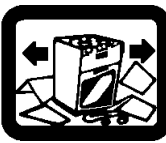

**Ensure** that all packaging, both inside and outside the appliance, has been removed before the appliance is used.



**Do not** try to move the appliance by pulling the door handles.

The electrical installation work **must** be undertaken by a qualified electrician/ competent person.



**It is dangerous** to alter or modify the specifications of the product in any way.

## DURING OPERATION



**Do not** use this cooker if it is in contact with water. **Never** operate it with wet hands.



This appliance is designed to be operated by adults and children under supervision. Young children **must not** be allowed to tamper with the cooker or play with the controls.

Accessible parts especially around the grill area may become hot when the cooker is in use. Children should be **kept away** until it has cooled.



Take **great care** when heating fats and oils as they will ignite if they become too hot.

This product has been designed for cooking edible foodstuffs only, and **must not** be used for any other purposes.



**Never** place plastic or any other material which may melt in the oven or on the hob.



**Ensure** cooking utensils are large enough to contain foods to prevent spillages and boil overs.



The handles of saucepans which are smaller than the heated area on the hob will become hot. **Ensure** your hand is protected before handling the pan.



**Take care** to follow the recommendations given for tending the food when grilling.

**Do not** leave the handle in position when grilling as it will become hot.

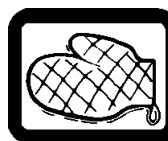

**Always** use oven gloves to remove and replace the grill pan handle when grilling. Recommendations given on page 17.

**Ensure** that all vents are left unobstructed to ensure ventilation of the oven.

**Ensure** that the anti-tilt shelves are put in place correctly. Refer to instructions on page 19 and 21.

**Never** line any part of the appliance with aluminium foil.



**Always** stand back from the appliance when opening the oven door to allow any build up of steam or heat to release.



**Do not** place sealed cans or aerosols inside the oven. They may explode if they are heated.



After installation, please dispose of the packaging with due regard to safety and the environment.

## AFTER USE



**Ensure** that all control knobs are in the OFF position when not in use.



For hygiene and safety reasons this appliance should be kept clean at all times. A build-up of fats or other foodstuffs could result in a fire, especially in the grill pan.



**Do not** leave utensils containing foodstuffs, e.g. fat or oil in or on the appliance in case it is inadvertently switched ON.

Cookers and hobs become **very hot**, and retain their heat for a long period of time after use. Children should be kept well away from the appliance until it has cooled.

## GENERAL



**Under no circumstances** should repairs be carried out by inexperienced persons as this may cause injury or serious malfunction.

This product should be serviced by an authorised Service Engineer and only genuine approved spare parts should be used. Details of servicing and repair arrangements are given on page 30 of this book.



**Do not** stand on the appliance or on the open oven door.



**Do not** hang towels, dishcloths or clothes from the appliance or its handle. They are a safety hazard.

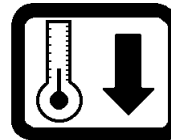

After allowing the cooker to cool always switch OFF the cooker at its power point before any maintenance or cleaning work is carried out.



Only clean this cooker in accordance with the instructions given in this book.

Your safety is of paramount importance.

Therefore, if you are unsure about any of the meanings of these WARNINGS contact the:

Consumer Care Department  
Telephone (01582) 585858

## INTRODUCTION

### WARNING: THIS APPLIANCE MUST BE EARTHED

#### RATING PLATE

Record the model and serial numbers on the back from the rating plate. This is situated on the front frame of the appliance and can be seen upon opening the oven door.

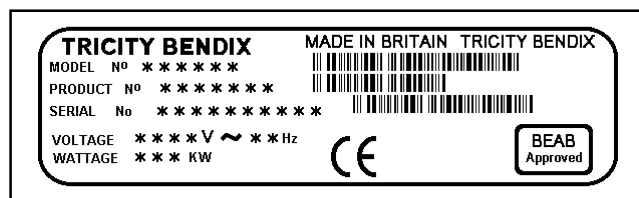

The appliance must be protected by a suitably rated fuse or circuit breaker. The rating of the appliance is given on the rating plate.

#### INSTALLATION

If your cooker has been damaged in transit, contact your supplier immediately. **DO NOT** attempt to install it.

Your cooker left the factory fully packaged to protect it from damage. If it is delivered without packaging and damage has occurred, the manufacturer cannot accept responsibility. Contact your supplier for advice.

Once the packaging has been removed the cooker should only be moved by hand. **DO NOT** use a sack barrow or any other aid to lift the cooker as damage may occur.

Connection to the electricity supply must be carried out by a qualified electrician/competent person.

The electrical connection should be made using a double pole isolating switch (cooker socket) with at least 3mm contact separation. The cable must have conductors of sufficiently high cross-sectional area to prevent overheating and deterioration. Six square millimetres (6.00mm<sup>2</sup>) is the recommended cross-section area.

#### For SB 420BTS and SB 420BTS Only

The electrical connection must be made using an all pole isolating switch, or other suitable means of disconnection, with at least 3mm contact separation. The cable must have conductors of sufficiently high cross-sectional area to prevent overheating and comply with all relevant wiring regulations. Six square millimetres (6.00mm<sup>2</sup>) is the recommended cross-section area.

The cable should be routed away from potentially hot areas marked by X in the diagram below.

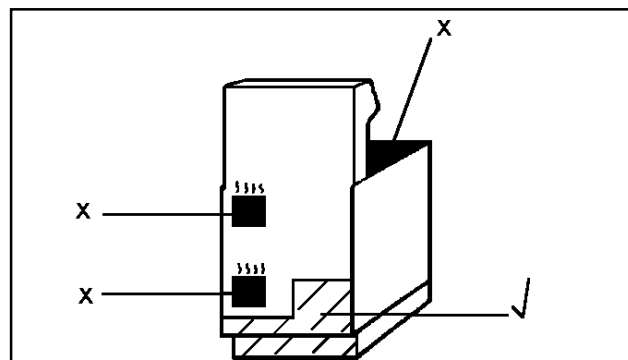

To move the cooker, open the main oven door and lift the cooker by holding the inside top of the compartment.

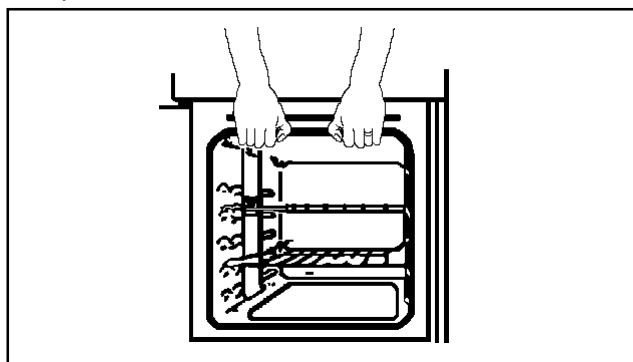

This is a type Y appliance which means it is free-standing and can be fitted with cabinets on one or both sides. It may also be fitted in a corner setting.

A nominal air gap of 2mm all around the cooker is required to enable the cooker to be moved into position.

Side walls which are above hob level should be protected by heat resistant non-combustible material and **MUST NOT** be nearer than 40mm to the hob side.

Overhanging surfaces or a cooker hood should be a minimum of 685mm above the hob.

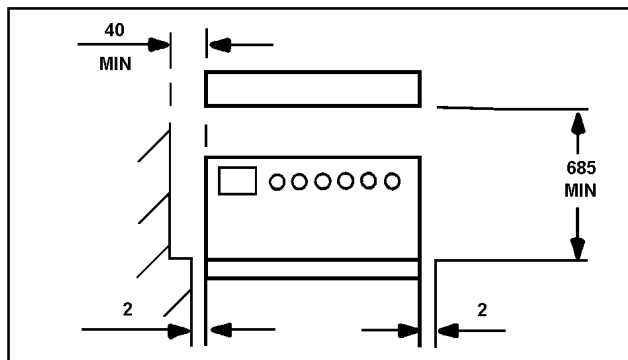

It is important to ensure that the appliance is level after installation. Levelling feet are fitted to the front of the appliance to accommodate uneven floors.



## REVERSIBLE MAIN OVEN DOOR

If you require the oven door to be hinged on the opposite side, you will need to contact a qualified Service Engineer. See page 30 for your nearest Service Centre. PLEASE NOTE that a charge will be made.

## GENERAL NOTES ON USING YOUR COOKER

We suggest that you run all the elements for a short period to burn off any residue from their surfaces.

During this period an unpleasant odour may be emitted, it is therefore advisable to open a window for ventilation.

## ABOUT CONDENSATION AND STEAM

When food is heated it produces steam similar to a boiling kettle. The ovens are vented to allow some of this steam to escape. However, always stand back from the appliance when opening the oven door to allow any build up of steam or heat to release.

If the steam comes into contact with a cool surface on the outside of the appliance, e.g. a trim, it will condense and produce water droplets. This is quite normal and is not caused by a fault on the appliance.

To prevent discolouration, regularly wipe away condensation and also soilage from surfaces.

## OVEN FURNITURE

The following items of oven furniture have been supplied with the cooker:

1 grill pan/meat tin



1 grill pan handle

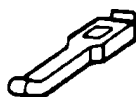

1 grill pan grid

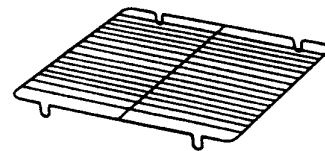

1 grill deflector



1 trivet

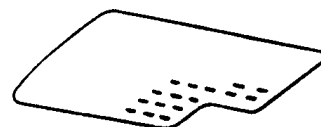

(SB 420, SB 421)

1 cranked shelf for grilling

(SB 430)

1 cranked shelf for grilling and top oven cooking only

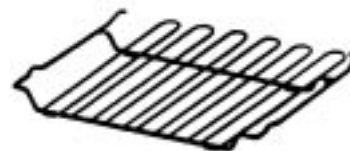

3 straight shelves for main oven cooking

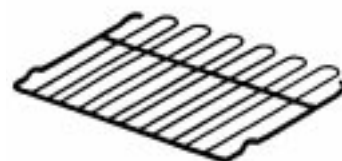

# GETTING TO KNOW YOUR COOKER

## THE CONTROL PANEL (SB 420)

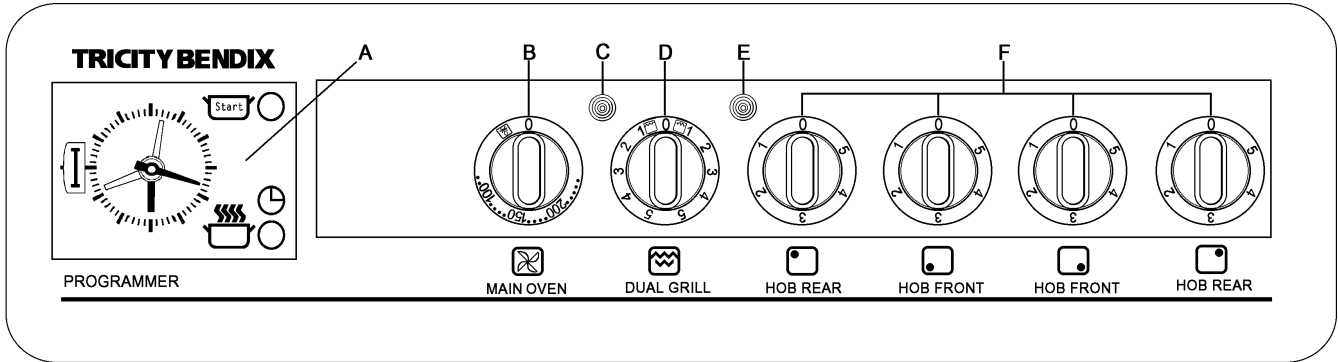

### FEATURES

- |                              |                          |
|------------------------------|--------------------------|
| A - Timer                    | D - Dual Grill Control   |
| B - Oven Temperature Control | E - Grill Indicator Neon |
| C - Oven Indicator Neon      | F - Hotplate Controls    |

## THE CONTROL PANEL (SB 421)

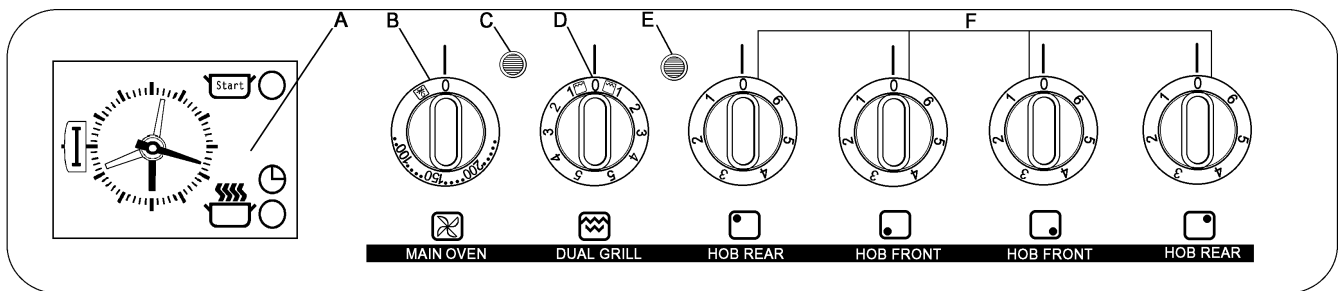

### FEATURES

- |                              |                          |
|------------------------------|--------------------------|
| A - Timer                    | E - Grill Indicator Neon |
| B - Oven Temperature Control | F - Hotplate Controls    |
| C - Oven Indicator Neon      |                          |
| D - Dual Grill Control       |                          |

## THE CONTROL PANEL (SB 430)

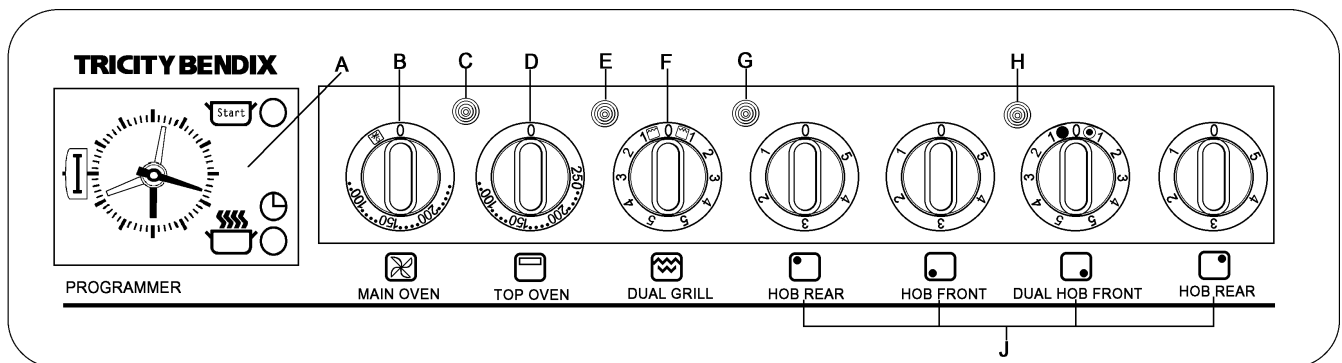

### FEATURES

- |                                   |                          |
|-----------------------------------|--------------------------|
| A - Timer                         | F - Dual Grill Control   |
| B - Main Oven Temperature Control | G - Grill Indicator Neon |
| C - Main Oven Indicator Neon      | H - Hob Indicator Neon   |
| D - Top Oven Temperature Control  | J - Hotplate Controls    |
| E - Top Oven Indicator Neon       |                          |

## THE TIMER

- A START TIME SETTING KNOB
- B SECOND HAND
- C CLOCK SYMBOL
- D CLOCK/MINUTE MINDER/LENGTH OF COOKING TIME SETTING KNOB
- E START TIME INDICATOR
- F HOUR HAND
- G DISPLAY WINDOW
- H MANUAL SYMBOL
- J MINUTE HAND

### 1. TO SET THE TIME OF DAY

The clock will operate when the cooker is switched ON at the wall.

To set, **pull out** and turn setting knob (D) clockwise until the right time of day is displayed, e.g. 9 a.m. as Fig. 1.

### 2. TO SET FOR MANUAL COOKING

Ensure the time of day has been set as above.

**Push in** and turn setting knob (A) in either direction until the start time indicator (E) lines up with the hour hand of the clock.

**Push in** and turn setting knob (D) clockwise until the manual symbol (H) can be seen in window (G) as Fig. 2.

The oven temperature controls can now be operated as required. The oven neon indicator will glow.

### 3. TO SET THE MINUTE MINDER

Turn setting knob (D) clockwise, **without pulling it out**. The selected minutes can be seen in the window (G), e.g. 80 minutes as Fig. 3.

A period of up to 3 hours can be timed using the minute minder. The minute minder cannot be used when an automatic programme has been set on the oven timer.

At the end of the set time a continuous buzzer will sound for up to 6 minutes.

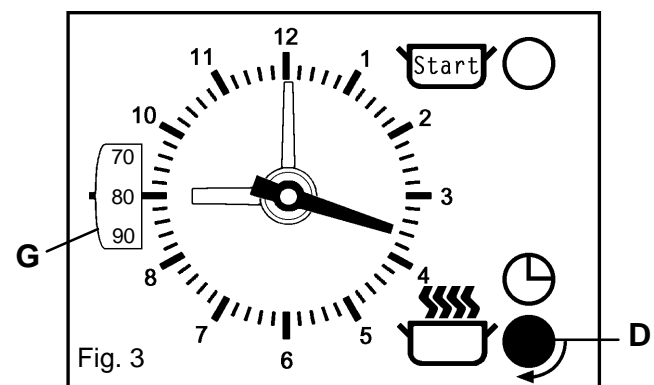
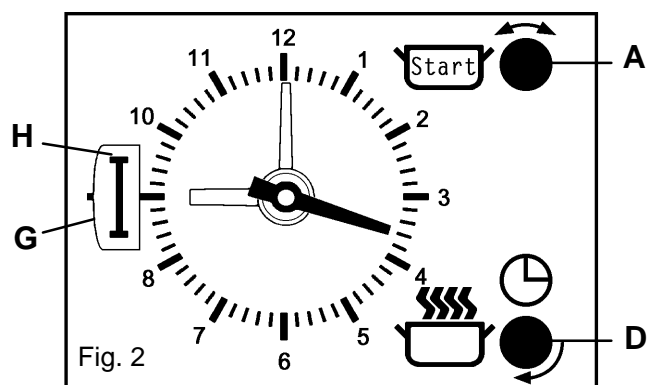
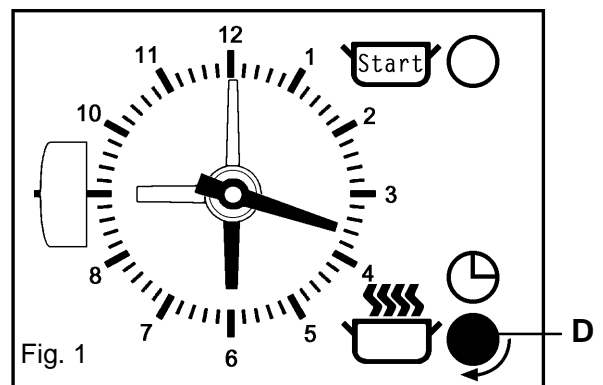
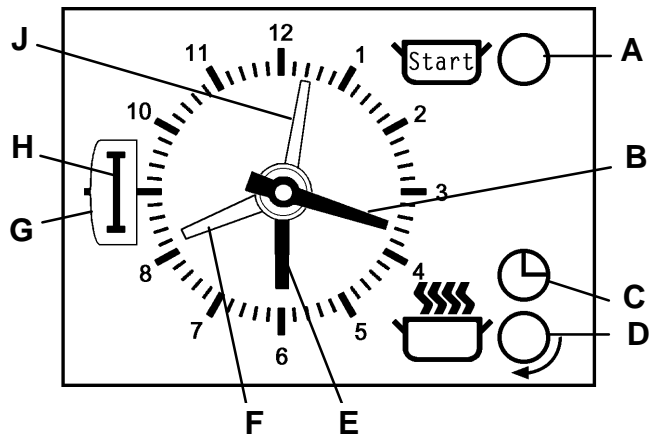

#### 4. TO CANCEL MINUTE MINDER/BUZZER

Turn setting knob (D) clockwise, **without pulling it out** until "O" or the manual symbol appears in the window (G) as Fig.4.

#### 5. HOW TO SET THE OVEN TIMER

When using the oven timer for the very first time, it is advisable to let it operate while you are at home. The timer can be checked to show that it is operating correctly and then you will then feel confident to leave a meal to cook automatically in the future.

##### A) TO SWITCH THE OVEN ON AND OFF AUTOMATICALLY

- i) Make sure the electricity supply is switched ON.
- ii) Check the clock shows the right time of day and the cooker is set in manual (see point 2). Adjust as necessary as Fig. 5.
- iii) Place food in oven.
- iv) To set the length of time you want the food to cook; turn setting knob (D) clockwise, **without pulling it out**, until the required cooking period can be seen in the window (G) e.g. 160 minutes (2 hours 40 mins) as Fig. 6.
- v) Set the start time, by **pushing in** and turning setting knob (A) in either direction until indicator (E) lines up with the time you want the food to start cooking, e.g. 1.30 p.m. as Fig. 7.
- vi) Turn the oven temperature control to the required setting. The oven indicator light should be OFF.
- vii) When automatic cooking starts the oven neon indicator will cycle ON and OFF showing that the oven temperature is being maintained.
- viii) The start time indicator (E) will move with the hour hand of the clock until the length of cooking time is complete. A buzzer will sound which can be cancelled by following point 4 as Fig. 8.
- ix) The maximum cooking time on automatic is 3 hours.

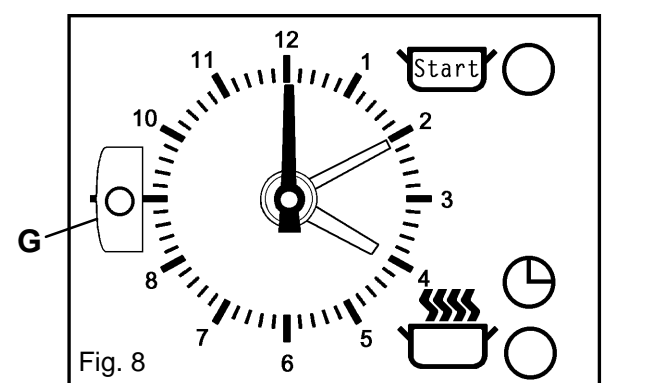
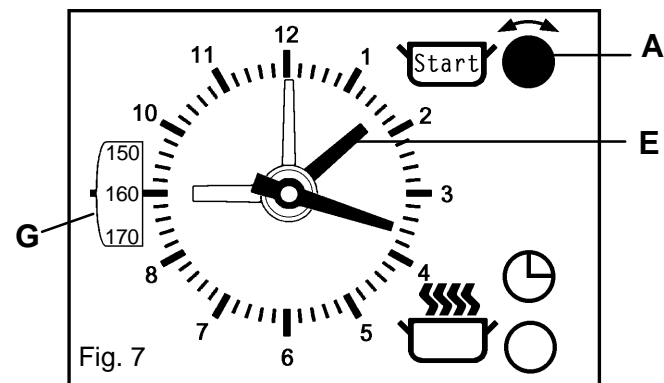
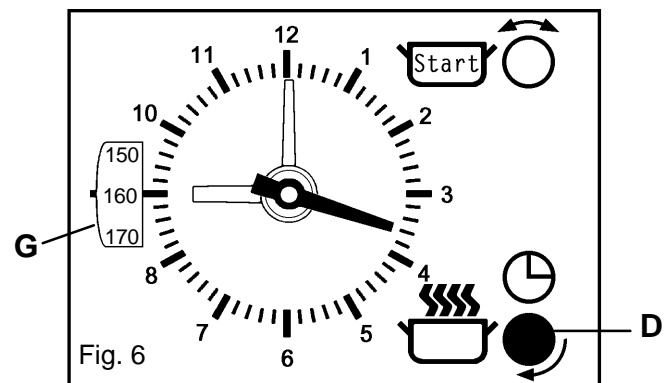
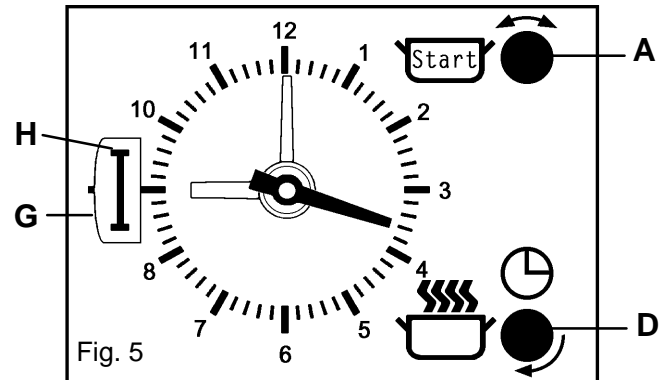
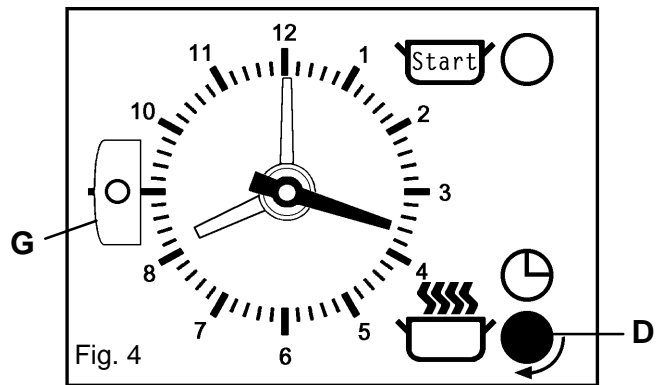

## **B) TO START COOKING NOW, THEN SWITCH OFF AUTOMATICALLY**

Follow the first 3 points under section 5. (A) above, and then;

- iv) To set the length of time you want the food to cook; turn setting knob (D) clockwise, **without pulling it out**, until the required cooking period can be seen in window (G), e.g. 120 minutes (2 hours) and Fig. 9.
- v) Turn the oven temperature control to the required setting. The oven neon indicator should glow.
- vi) The oven neon indicator will cycle ON and OFF showing that the oven temperature is being maintained.
- vii) The start time indicator (E) will move with the hour hand of the clock until the length of cooking time is complete. A buzzer will sound which can be cancelled by following point 4 as Fig. 10.

## **6. RETURNING THE COOKER TO MANUAL OR TO CANCEL AN AUTOMATIC PROGRAMME**

Turn the oven temperature control OFF. Ensure the start time indicator (E) lines up with the hour hand of the clock by **pushing in** and turning in either direction, setting knob (A). Fig. 11.

The manual symbol (H) should be displayed in window (G) by turning setting knob (D) clockwise.

Turn the oven temperature control ON to check that the oven operates manually. The oven neon indicator should light.

## **7. THINGS TO NOTE**

- \* Both ovens can be set to cook automatically provided the start and stop time is the same for each oven.
- \* When an automatic programme has been set on one oven, IT IS NOT possible to use the oven manually.
- \* If an automatic programme has been set on the main oven, the grill WILL operate manually. But the grill WILL NOT operate when the top oven is set for automatic cooking.
- \* The delay time plus the cooking time MUST NOT exceed 11 hours and 59 minutes.

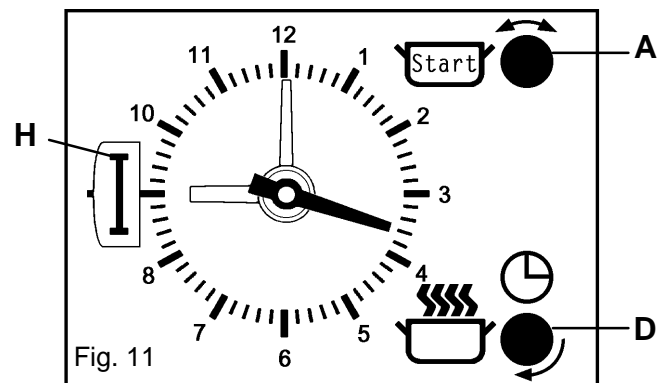
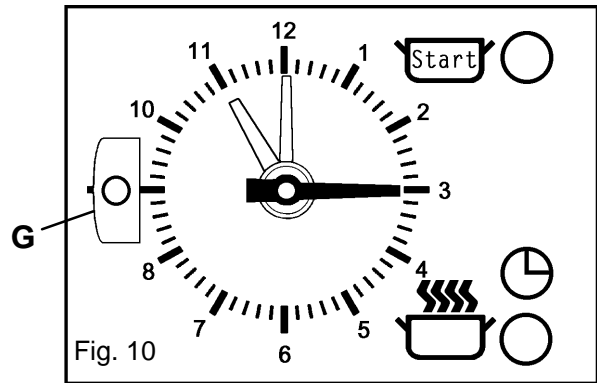
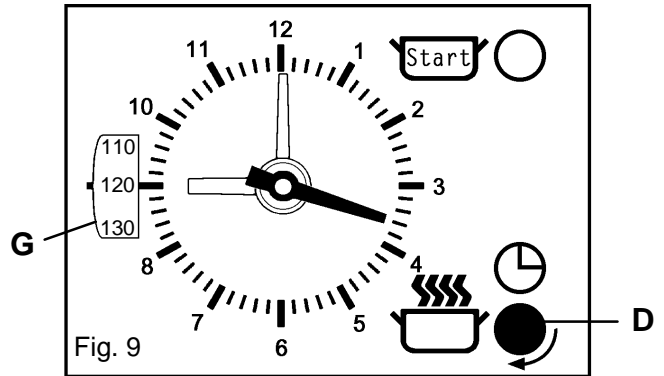

# THE RADIANT HOB (SB 420/SB 430)

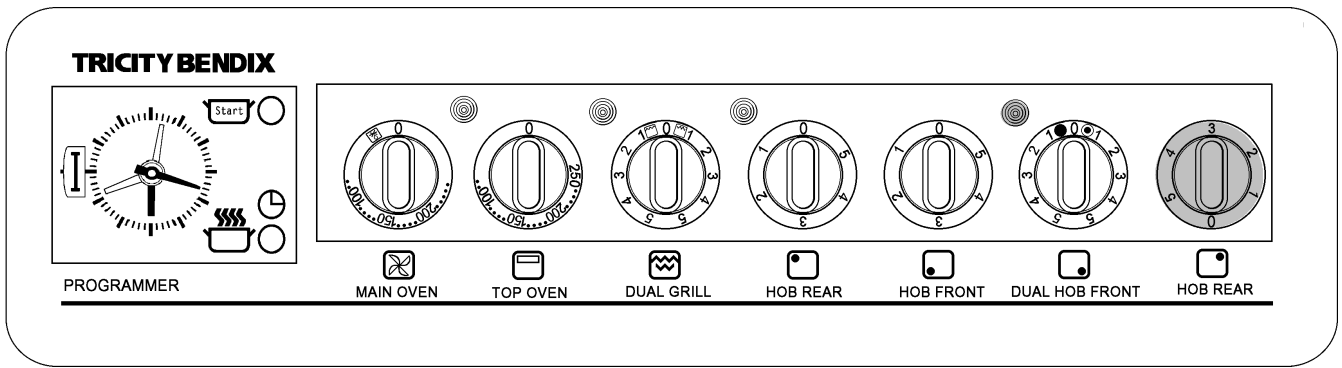

- To operate the hotplates turn the control knobs in either direction to vary the heat setting. The highest number represents the hottest setting and the lowest the coolest setting.

## SB 430 ONLY

- To operate the dual hotplate, turn the control knobs clockwise for full area or anti-clockwise for the centre section.

## RECOMMENDED SAUCEPANS

For speed and economy only good quality saucepans with flat bases and close fitting lids are recommended.

The saucepan base should cover the hotplate as much as possible. A base diameter of up to 225mm (9") may be used on a 180mm (7") hotplate.

**Pressure cookers, preserving pans, etc.**, should comply with the recommendations given above.

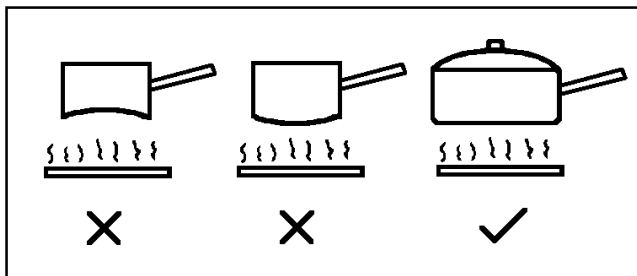

## HINTS AND TIPS

- Lift, rather than slide saucepans on and off the hob to help to reduce scratches and maintain the efficiency of the hotplates.

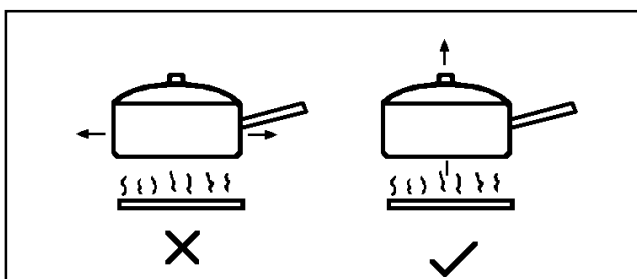

- Avoid placing fish kettles or large preserving pans across two hotplates as this may cause damage.

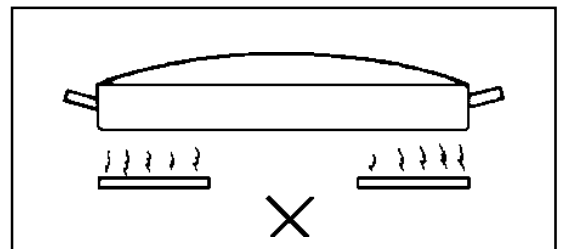

- Follow any guidelines provided by the saucepan manufacturer.
- To prolong the life of the hotplates:
  - Never use utensils with a skirt, e.g. a bucket
  - Never use an asbestos mat
  - Never line the spillage tray with aluminium foil
  - Never leave the hotplates ON when not covered with a saucepan
- For full details on deep fat frying and preserving refer to instructions on page 16.

## THE SOLID HOTPLATES (SB 421)

### BEFORE USING THE HOTPLATES FOR THE FIRST TIME

Turn the control knob to a medium/high setting and allow the hotplate to heat, uncovered by a saucepan for 3-5 minutes. This hardens the protective coating on the hotplates and makes it more resistant to normal use. A harmless smoke will be given off from the hotplates.

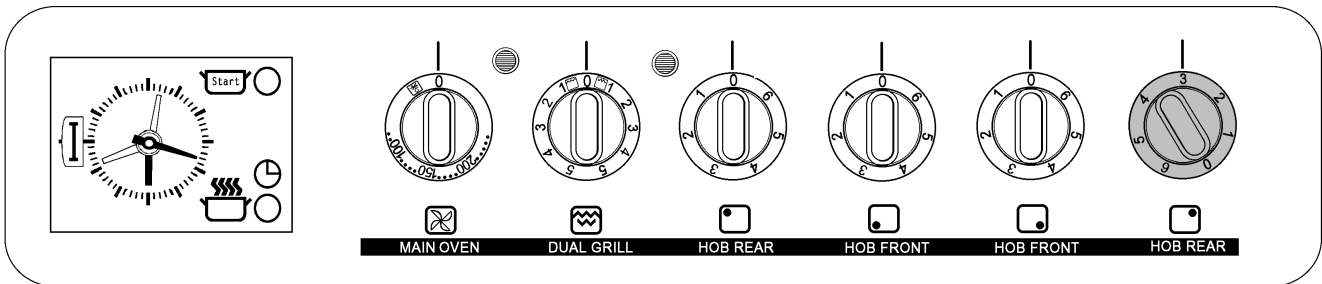

- To operate the hotplates, turn the control knobs in either direction to vary the heat setting.
- The highest number represents the hottest setting and the lowest represents the coolest setting. Choose a setting appropriate to the quantity and type of food to be cooked.

### RECOMMENDED SAUCEPANS

For speed and economy only good quality saucepans with flat bases and close fitting lids are recommended.

To check the flatness of the saucepan, place a ruler across the pan base, hold at eye level and look for light showing. There should be very little or no light visible between the ruler and the pan base.

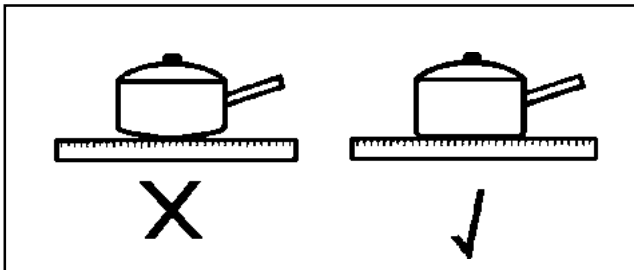

The size of the base of the saucepan should be the same or up to 3cm/1inch larger than the hotplate. If the base is too small, energy will be wasted, boilovers will also be more difficult to deal with as spillage will fall directly onto the hotplate.

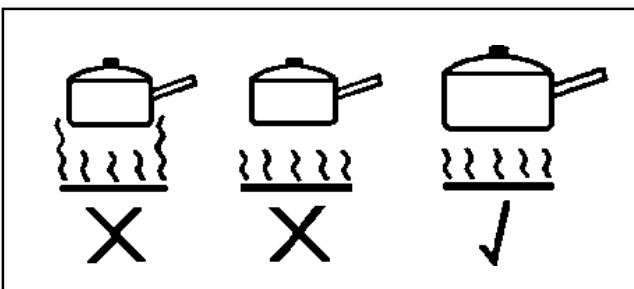

Pressure cookers, preserving pans etc., should comply with the recommendations given above.

### HINTS AND TIPS

- Avoid the use of decorative covers as they can cause condensation to form on the hotplates which may lead to deterioration.
- Follow any guidelines provided by the saucepan manufacturer, particularly those relating to recommended heat settings.
- Avoid using thin, badly dented or distorted saucepans as they can lead to sticking and burning of food.
- To prolong the life of the hotplates:
  - Never use utensils with a skirt, e.g. a bucket
  - Never use an asbestos mat
- For full details on deep fat frying and preserving refer to instructions on page 16.

## DEEP FAT FRYING

### SPECIAL FRYING NOTE:

For safety purposes when deep fat frying, fill the pan one-third full of oil, DO NOT cover the pan with a lid and DO NOT leave the pan unattended. In the unfortunate event of a fire, switch OFF at the electricity supply and cover the pan with a lid or damp cloth to assist in smothering the flames.

DO NOT use water on the fire. Leave the pan to cool for at least 30 minutes before moving it.

DO NOT leave the fat or oil in the frying pan on the hob to store it in case the hob is inadvertently switched ON.

#### 1. Preparing the food

Seal the food by coating with flour, egg and breadcrumbs or batter. **Do not** use a basket with batter coated foods as they will stick.

#### 2. Amount of oil

For safety purposes fill the pan only one-third full of oil.

#### 3. Testing the temperature of the oil

It is advisable to use a thermometer to test the temperature of the oil. Alternatively, drop a small cube of bread into the oil which should brown in just under a minute if the oil is at the correct temperature of 190°C/375°F.

#### 4. Cooking the food

Lower the food gently into the oil. **Do not** add too much food at once or the temperature of the oil will be reduced and may result in soggy, greasy food.

Turn the food if necessary; doughnuts float to the surface so will not brown on the upperside if not turned. Once cooked, drain the food on absorbent paper.

#### 5. Double frying chips

Double frying will ensure good chips. First fry the chips for a few minutes at 170°C/340°F to seal the outside. Remove the chips from the oil. Increase the temperature of the oil to 190°C/375°F to finish cooking and brown the chips.

Chips may be kept for several hours after the first frying before finishing off with the second frying.

#### 6. Frying temperatures

	Celsius Scale (°C)	Fahrenheit Scale (°F)
	150	300
First frying of potatoes	<b>170</b> 175 180	<b>340</b> 350 360
Second frying of potatoes	<b>190</b>	<b>375</b>
Frying chicken and fish	195 200	380 390

## PRESERVING

1. DO NOT use a pan that overlaps the perimeter of the hob trim.

2. To allow for a full rolling boil, the pan should be no more than one third full when all the ingredients have been added. It is better to use two pans rather than overfill one, or use half quantities.

3. Use firm fruit or vegetables and wash well before using.

4. Preserving sugar gives clear jam, however granulated sugar is cheaper and gives equally good flavour.

5. Crystallization may be caused if sugar is not completely dissolved before bringing jam to the boil. Over boiling will affect the flavour, setting properties and colour of the jam.

6. To test jam for setting:

If a jam thermometer is available, boil jam to 104°C. Marmalade should be boiled to 106°C.

If a jam thermometer is not available, remove pan from heat, place sample of jam on a cold dish and cool quickly (i.e. in a freezer or frozen food storage compartment of a refrigerator). When cold, it will crinkle and hold the mark of a finger run through it, if it is at setting point.

7. The scum should be removed as soon as possible after setting, but marmalade should be allowed to cool before potting to prevent the peel rising.



## THE GRILL

### USES OF THE GRILL

**CAUTION - ACCESSIBLE PARTS MAY BECOME HOT WHEN THE GRILL IS IN USE. CHILDREN SHOULD BE KEPT AWAY.**

The grill is a dual circuit grill which means that the full area of the grill can be used or for economy purposes, the centre section only can be used when cooking smaller quantities of food.

### SELECTING THE GRILL (SB 420/SB 421)

#### TRICITY BENDIX

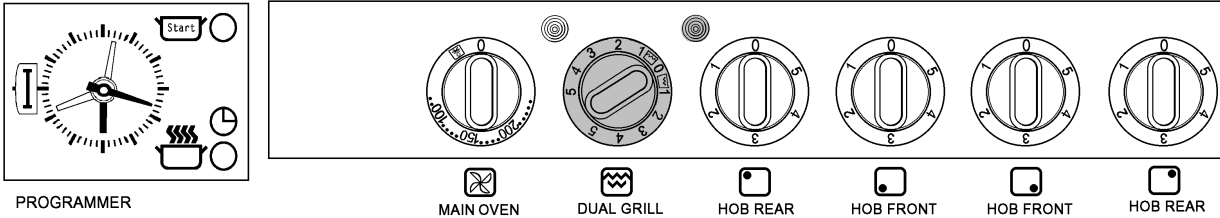

- Turn the grill control clockwise for full grill or anticlockwise for the centre section only. The highest number represents the hottest setting and the lowest the coolest setting.

- The grill neon will illuminate when the grill control is set. It will stay on until the grill is turned OFF.

### SELECTING THE GRILL (SB 430)

#### TRICITY BENDIX

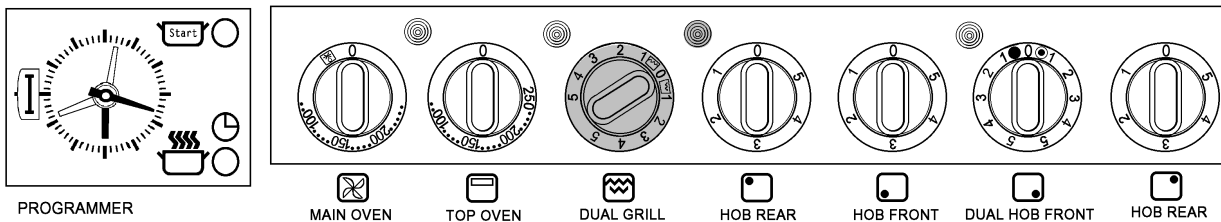

- Turn the grill control clockwise for full grill or anticlockwise for the centre section only. The highest number represents the hottest setting and the lowest the coolest setting.
- The grill neon will illuminate when the grill control is set. It will stay on until the grill is turned OFF.

#### NOTE

THE GRILL DOOR MUST BE LEFT OPEN DURING GRILLING.

The cranked shelf **MUST** only be used in the grilling compartment, but a straight shelf from the oven may be used to provide alternative positions.

The outer grill element may appear to glow slightly brighter than the inner element. This is quite normal.

### THE GRILL PAN AND HANDLE

The grill pan is supplied with a removable handle. To insert the handle, press the button on the handle with the thumb and pivot the handle slightly upwards inserting the lip into widest part of the bracket. Move the handle towards the left, lower into position and release the button.

#### Ensure the handle is positively located.

When removing the handle, press the button on the handle with the thumb and pivot the handle slightly upwards and towards the right to remove from the bracket.

**Ensure your hand is protected when removing the grill pan handle as the grill element can become very hot.**

ALWAYS REMOVE THE GRILL PAN HANDLE DURING GRILLING.

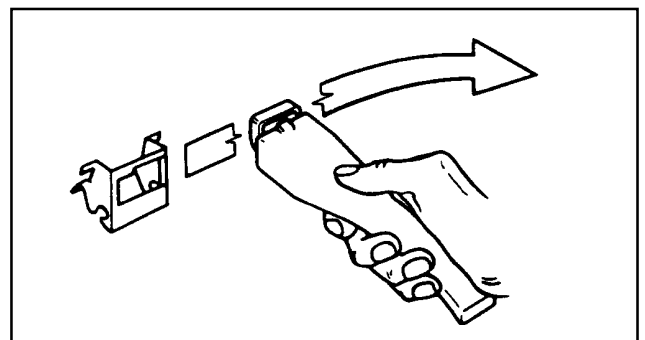

To correctly locate the grill pan on the shelf, ensure that the cut out on the underside of the handle bracket locates over the front bar of the shelf.

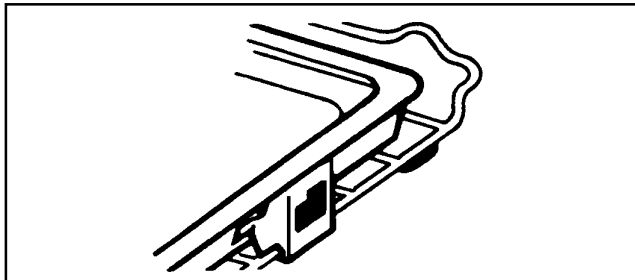

To check the progress of the food being grilled, the grill pan should be withdrawn on the shelf to tend the food during cooking, or the carrier shelf can be lifted away from the cooker and rested on a heat resistant work surface.

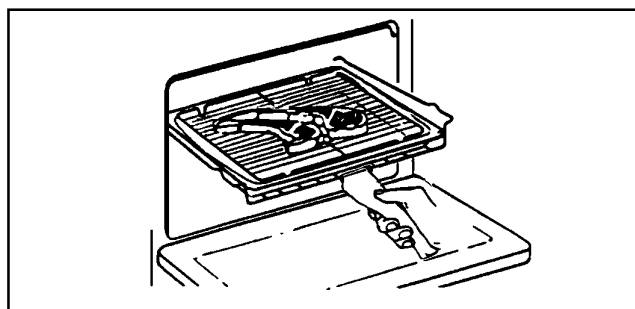

## HINTS AND TIPS

- Food should be thoroughly dried before grilling to minimise splashing. Brush lean meats and fish lightly with a little oil or melted butter to keep them moist during cooking.
- The use of the trivet beneath the grid when grilling fatty food will keep fat splashing to a minimum.
- Place food on the grill pan grid in the grill pan or on the trivet in the grill pan.

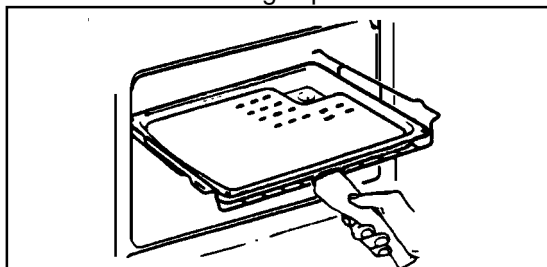

- Adjust the grid and grill pan runner position to allow for different heights of food.

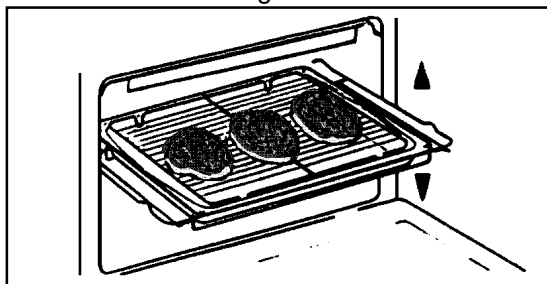

- When toasting bread use the cranked shelf in position 2. Adjust the grill pan grid to suit.

- Accompaniments such as tomatoes and mushrooms may be placed underneath the grid when grilling meats.

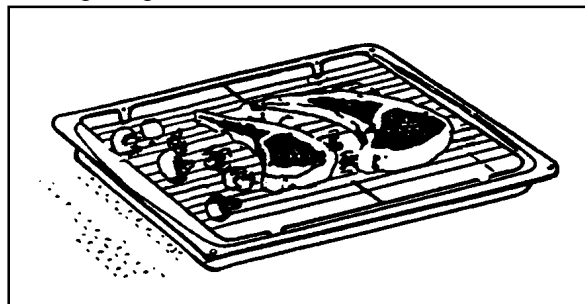

- Preheat the grill on a full setting for a few minutes before cooking. Adjust the heat setting and the shelf as necessary during cooking.
- Turn foods over during the cooking time as required.
- The outer grill element may appear to glow slightly brighter than the inner element. This is quite normal.

## GRILLING CHART

FOOD	SHELF	GRILL TIME
Bacon Rashers	2 crk.	2-3 each side
Beefburgers	2 crk.	6-10 each side
Chicken Joints	2 crk.	15-20 each side
Chops - Lamb	2 crk.	7-10 each side
Pork	2 crk.	10-15 each side
Fish - Whole		
Trout/Mackerel	2 crk.	8-12 each side
Fillets - Plaice/Cod	2 crk.	4-6 each side
Kebabs	2 crk.	10-15 each side
Kidneys - Lamb/Pig	2 crk.	4-6 each side
Liver - Lamb/Pig	2 crk.	5-10 each side
Sausages	2 crk.	10-15 each side
Steaks - Rare	2 crk.	3-6 each side
Medium	2 crk.	6-8 each side
Well Done	2 crk.	7-10 each side
Toasted Sandwiches	2 crk.	1¼-1½ each side

crk. = cranked shelf

Shelf positions are counted from the bottom upwards.

The times quoted above are given as a guide and should be adjusted to suit personal taste.

## THE TOP OVEN (SB 430 ONLY)

### USES OF THE TOP OVEN

The top oven is the smaller of the two ovens. It is heated by elements in the top and bottom of the oven. It is designed for cooking on one level and for small quantities of food. It gives especially good results if used to cook fruit cakes, sweet or savoury flans or quiche.

The top oven is also ideal for use as a warming compartment to warm dishes and keep food hot. Use a temperature setting of 80-100°C on the top oven control dial.

### SELECTING THE TOP OVEN

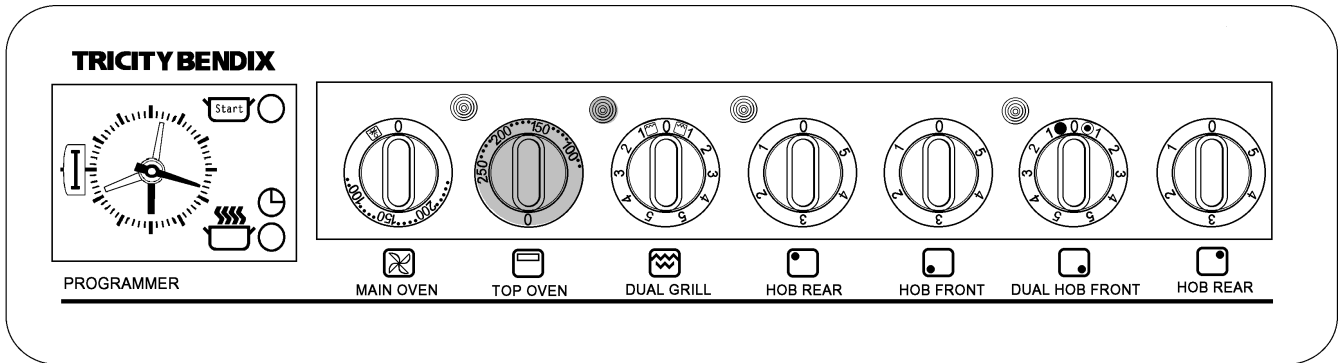

- Turn the top oven temperature control to the required setting.

#### THINGS TO NOTE

The top oven neon indicator will glow until the oven has reached the desired temperature and then go out. It will then cycle ON and OFF showing that the oven temperature is being maintained.

#### TO FIT THE TOP OVEN SHELF

The cranked shelf must only be used in the top oven compartment but a straight shelf from the main oven may be used to provide alternative positions. The shelf should be fitted with the straight rods uppermost on the frame and the forms towards the back of the oven. If not fitted correctly the anti-tilt and safety stop mechanism will be affected.

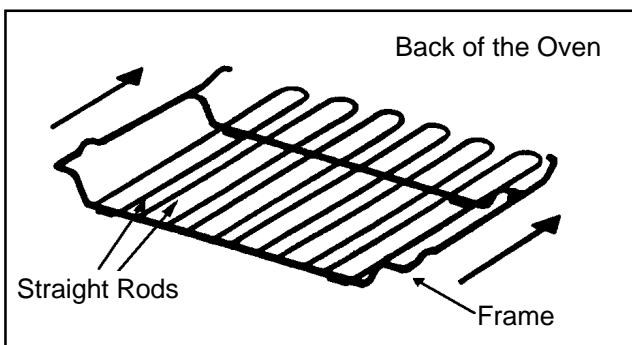

#### HINTS AND TIPS

- Most cooking should be carried out using a oven shelf positioned in one of the shelf runners.

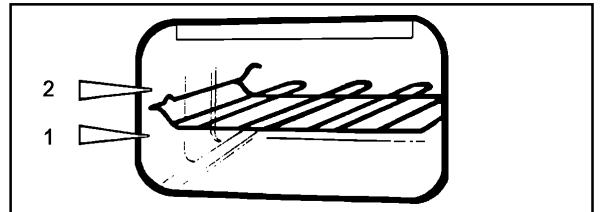

- Larger roasts and casseroles should normally be cooked in the main oven. However, they may be cooked on a flat shelf placed on the base of the top oven provided there is sufficient room for air circulation around the food.

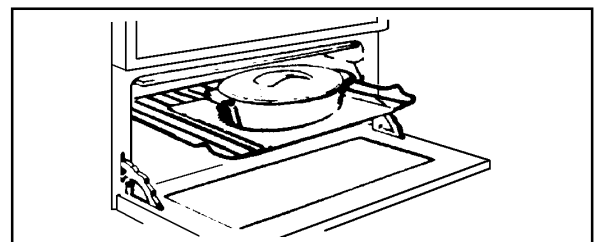

- There should always be at least 2.5 cm (1") between the top of the food and the element. This gives best cooking results and allows room for rise in yeast mixtures, Yorkshire puddings, etc.
- DO NOT place dishes directly onto the oven base as it becomes very hot and damage may occur.

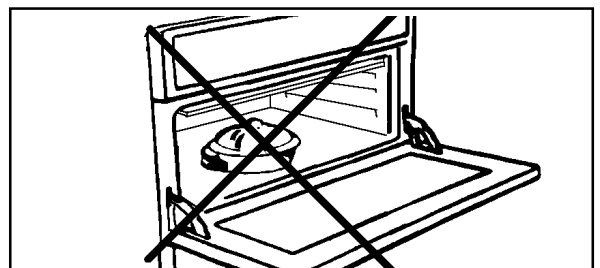

- When cooking cakes, pastry, scones, bread, etc., place the tins or baking trays centrally on the shelf directly below the element.

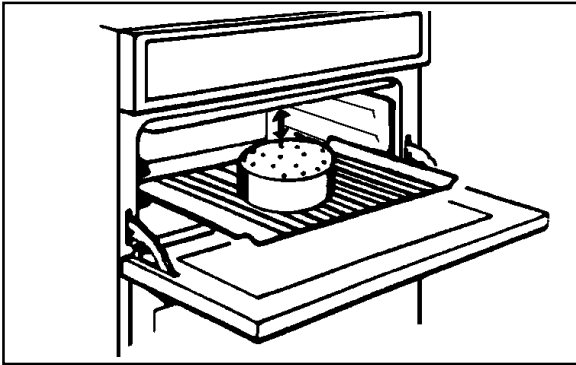

- Stand dishes on suitably sized baking trays on the shelf to prevent spillage onto the oven base and to help reduce cleaning.
- The material and finish of the baking trays and dishes will affect the degree of base browning of the food. Enamelware, dark, heavy or non-stick utensils increase base browning. Shiny aluminium or polished steel trays reflect the heat away and give less base browning.
- DO NOT use the grill pan as a baking tray as this will increase base browning of the food.
- Because of the smaller cooking space, lower temperatures and shorter cooking times are sometimes required. Be guided by the recommendations on page 23.
- For economy leave the door open for the shortest possible time, particularly when placing food into a pre-heated oven.

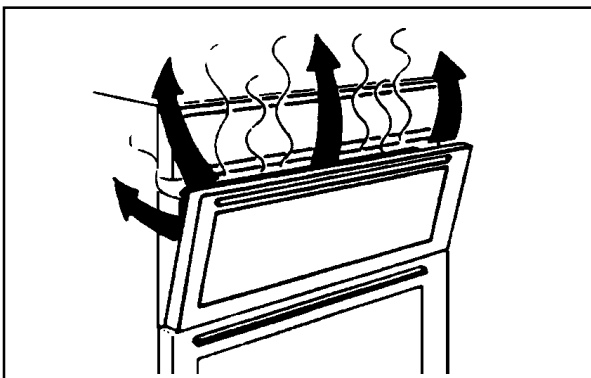

# THE MAIN FAN OVEN

## USES OF THE FAN OVEN

### PREHEATING

The fan oven quickly reaches its temperature, so it is not usually necessary to preheat the oven. Without preheating, however, you may find you need to add an extra 5 - 10 minutes on the recommended cooking times. For recipes needing high temperatures, e.g. bread, pastries, scones, soufflés, etc., best results are achieved if the oven is preheated first.

### COOKING TEMPERATURES

Fan oven cooking generally requires lower temperatures than conventional cooking. Follow the temperatures recommended in the chart on page 23. As a guide reduce temperatures by about 20°C - 25°C for your own recipes.

### BATCH BAKING

The fan oven cooks evenly on all shelf levels, especially useful when batch baking on three shelves.

## SELECTING THE FAN OVEN

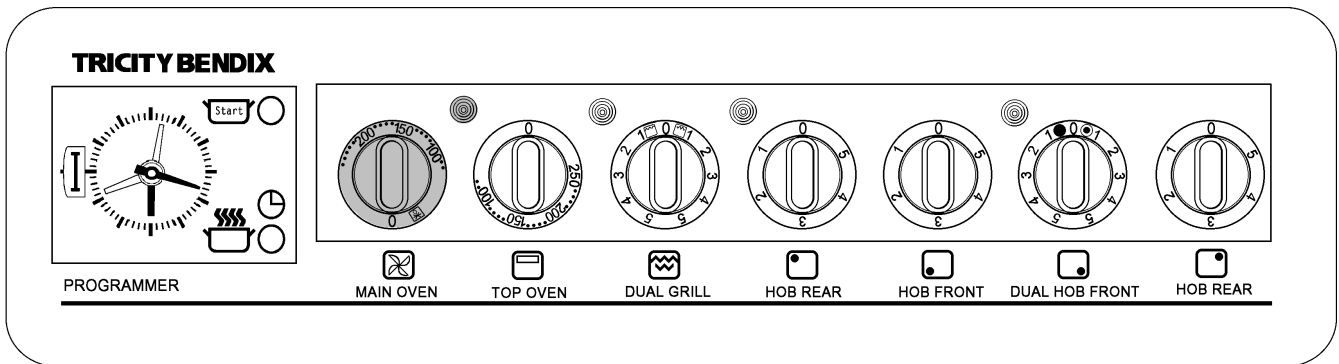

- Turn the oven temperature control to the required setting.

### THINGS TO NOTE

1. The main oven indicator neon will glow until the oven has reached the desired temperature and then go out. It will cycle ON and OFF periodically during cooking showing that the temperature is being maintained.
2. The internal oven light will come ON when the temperature is set. (SB 430 only).

### TO FIT THE MAIN OVEN SHELVES

The shelves should be fitted with the straight rods uppermost on the frame and the forms towards the back of the oven. If not fitted correctly the anti-tilt and safety stop mechanism will be affected.

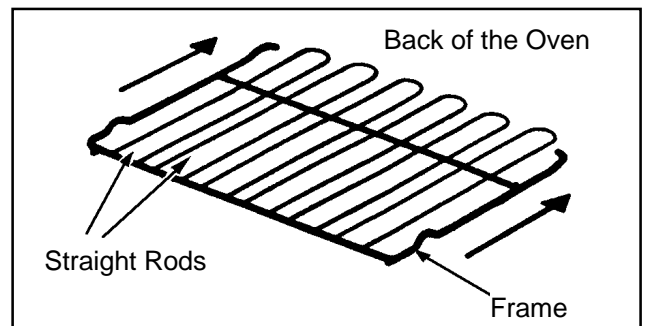

## HINTS AND TIPS

- Arrange the shelves in the required positions before switching the oven ON. Shelves are numbered from the bottom upwards.

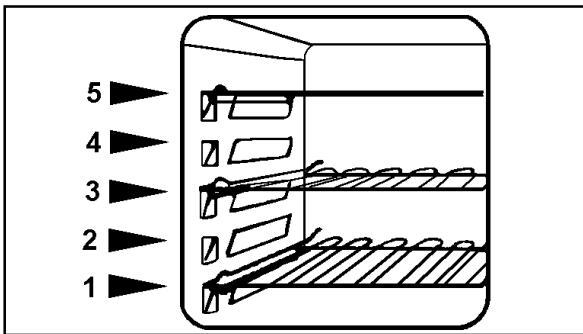

- When cooking more than one dish in the fan oven, place dishes centrally on different shelves rather than cluster several dishes on one shelf. This will allow the heat to circulate freely for the best cooking results.
- When batch baking one type of food, e.g. Victoria sandwich cakes, those of similar size will be cooked in the same time.
- It is possible to cook bulk loads on up to three shelves at any one time. DO NOT use the cranked shelf from the grill in the main oven.

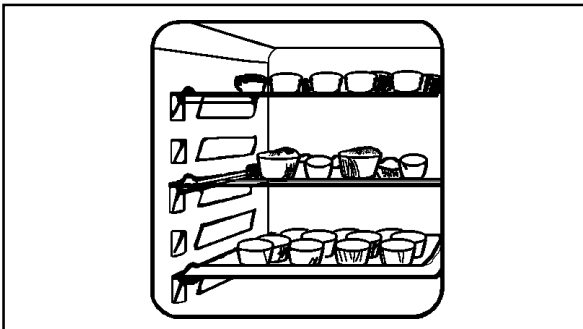

- It is recommended that when baking larger quantities, the shelf positions should be evenly spaced to suit the load being cooked. A slight increase in cooking time may be necessary.
- The use of excessively high temperatures can cause uneven browning. It may be necessary to reduce temperatures slightly. Refer to the recommendations given in the oven cooking chart on page 23.

## OVEN COOKING CHART

The oven temperatures are intended as a guide only. It may be necessary to increase or decrease the temperatures by 10° C to suit individual preferences and requirements.

FOOD	FAN OVEN		TOP OVEN		
	SHELF POSITION	COOKING TEMP °C	SHELF POSITION	COOKING TEMP °C	APPROX COOK TIME (m)
Biscuits		180-190	1 crk.	170-190	10 - 20
Bread		200-220	1 crk.*	200-220	25 - 30
Bread rolls/buns	Shelf	200-220	1 crk.	200-220	15 - 20
Cakes:					
Small & Queen		160-170	1 crk.	180-190	18 - 25
Sponges		160-170	1 crk.	160-170	18 - 20
Victoria Sandwich	positions	160-170	1 crk.	160-170	18 - 25
Madeira		140-150	1 crk.	140-150	1¼ - 1½h
Rich Fruit		130-140	1 crk.	130-140	2¼ - 2½h
Christmas	are not	130-140	1 crk.	130-140	3 - 4½h
Gingerbread		140-150	1 crk.	140-150	depends on size 1¼ - 1½h
Meringues	critical	80-100	1 crk.	90-100	2½ - 3h
Flapjack		170-180	1 crk.	170-180	25 - 30
Shortbread		130-140	1 crk.	140-150	45 - 65
Casseroles:					
Beef/lamb	but ensure	140-160	1 crk.*	140-160	2½ - 3h
Chicken		180-190	1 crk.*	180-190	1¼ - 1½h
Convenience Foods		Follow manufacturer's instructions			
Fish	that oven	170-190	1 crk.	170-190	20 - 30
Fish Pie (Potato Topped)		190-200	1 crk.*	190-200	20 - 25
Fruit Pies, Crumbles		190-200	1 crk.	190-200	40 - 50
Milk Puddings	shelves are	130-140	1 crk.	140-150	1½ - 2h
Pasta, Lasagne etc.		190-200	1 crk.	170-180	40 - 45
Pastry:					
Choux		190-200	1 crk.	180-190	30 - 35
Eclairs, Profiteroles	evenly	170-180	1 crk.	170-180	20 - 30
Flaky/Puff Pies		210-220	1 crk.*	210-220	25 - 40
Shortcrust					
Mince Pies		190-200	1 crk.	190-200	15 - 20
Meat Pies	spaced	190-210	1 crk.*	190-210	25 - 35
Quiche, Tarts, Flans		180-210	1 crk.	180-200	25 - 45
Patés and Terrines		150-160	1 crk.	150-160	1-1½h
Roasting Meat, Poultry	when more	160-180	1 crk.*	160-180	see roasting chart
Scones		210-220	1 crk.	220-230	8 - 10
Shepherd's Pie		190-200	1 crk.*	190-200	30 - 40
Soufflés	than one is	170-180	1 crk.	170-180	20 - 30
Vegetables:					
Baked Jacket Potatoes		180-190	1 crk.	180-190	1-1½h
Roast Potatoes		180-190	1 crk.	180-190	1-1½h
Stuffed Marrow	used	180-190	1 crk.	180-190	30 - 35
Stuffed Tomatoes		180-190	1 crk.	180-190	15 - 20
Yorkshire Puddings:					
Large		210-220	1 crk.	200-210	25 - 40
Individual		200-210	1 crk.	200-210	15 - 25

crk. = cranked shelf

\* or on a straight shelf on the oven base.

**Note:** Shelf positions are counted from the bottom of the oven.

**Do not** use the cranked shelf from the grill in the main oven.

## ROASTING CHART

ROASTING CHART		
INTERNAL TEMPERATURES - Rare : 50-60°C; Medium : 60-70°C; Well :70-80°C		
MEAT	SECOND/FAN OVEN	COOKING TIME
Beef	160-180°C	20-35 min per ½kg/1lb and 20-35 min over
Beef, boned	160-180°C	20-35 min per ½kg/1lb and 25-35 min over
Mutton and Lamb	160-180°C	25-35 min per ½kg/1lb and 25-35 min over
Pork and Veal	160-180°C	30-40 min per ½kg/1lb and 30-40 min over
Ham	160-180°C	30-40 min per ½kg/1lb and 30-40 min over
Chicken	160-180°C	15-20 min per ½kg/1lb and 20 min over
Turkey and Goose	160-180°C	15-20 min per ½kg/1lb up to 3½kg/7lb then 10 min per ½kg/1lb
Duck	160-180°C	25-35 min per ½kg/1lb and 25-30 min over
Pheasant	160-180°C	35-40 min per ½kg/1lb and 35-40 min over
Rabbit	160-180°C	20 min per ½kg/1lb and 20 min over
Potatoes with meat	160-180°C	according to size
Potatoes without meat	180-190°C	according to size

The roasting temperatures and times given in the chart should be adequate for most joints, but slight adjustments may be required to allow for personal requirements and the shape and texture of the meat. However, lower temperatures and longer cooking times are recommended for less tender cuts or larger joints.

Wrap joints in foil if preferred, for extra browning uncover for the last 30 - 60 min. cooking time.



## DEFROST FEATURE

### USES OF DEFROST FEATURE

This fan oven function defrosts most foods faster than more conventional methods. It is particularly suitable for delicate frozen foods which are to be served cold e.g. cream filled gateaux, cakes covered with icings or frostings, cheesecakes, biscuits, scones etc.

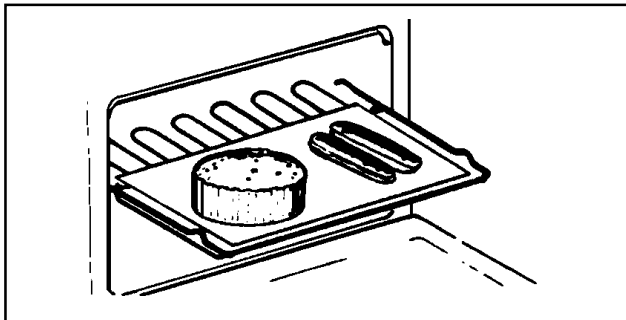

It is preferable to thaw fish, meat and poultry slowly in the fridge. However, this process can be accelerated by using the defrost function.

Small or thin fish fillets, frozen peeled prawns, cubed or minced meat, liver, thin chops, steaks etc., can be thawed in 1 - 2 hours.

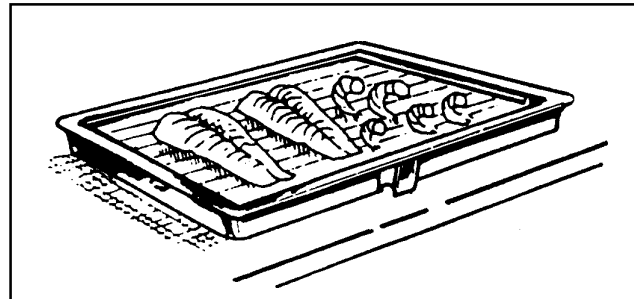

A 1kg/2¼lb oven ready chicken will be thawed in approximately 5 hours. Remove the giblets as soon as possible during the thawing process.

Joints of meat up to 2kg/4½lb in weight can be thawed using the defrost function.

**ALL JOINTS OF MEAT AND POULTRY MUST BE THAWED THOROUGHLY BEFORE COOKING.**

**ALWAYS COOK THOROUGHLY IMMEDIATELY AFTER THAWING.**

### SELECTING DEFROST

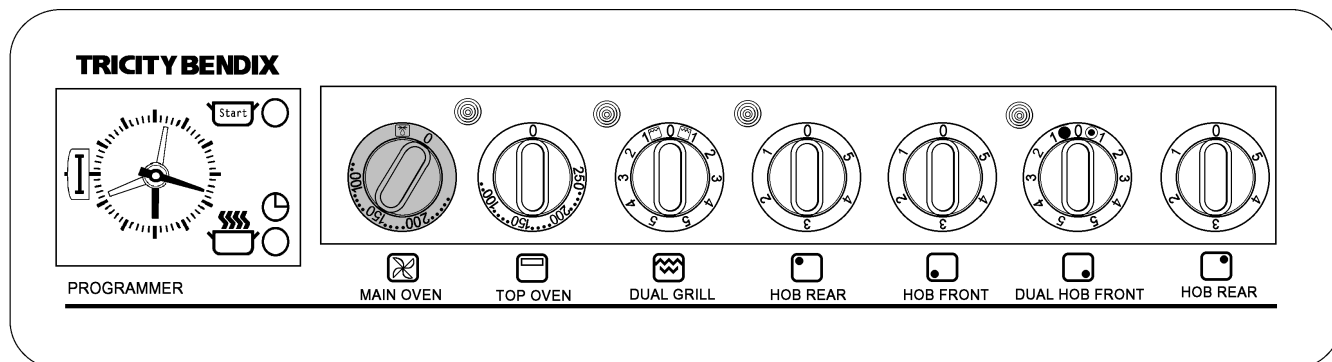

- Turn the oven temperature control to the defrost setting.
- When defrost is selected, the oven indicator neon may come ON. It will stay ON until the oven reaches room temperature and then go OFF.
- It may cycle ON and OFF periodically during defrosting to maintain a steady room temperature, inside the oven.

### THINGS TO NOTE

Care must always be taken when handling foods in the home. Always follow the basic rules of food hygiene to prevent bacterial and microbial growth and cross contamination when defrosting, preparing, cooking, cooling and freezing foods.

### HINTS AND TIPS

- Place the frozen food in a single layer where possible and turn it over half way through the defrosting process.

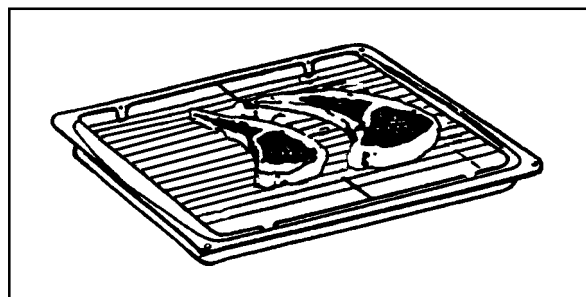

- The actual speed of defrosting is influenced by room temperature. On warm days defrosting will be faster than on cooler days.
- **DO NOT** leave food at room temperature once it is defrosted. Cook raw food immediately or store cooked food in the fridge.

## CARE AND CLEANING

**ALWAYS SWITCH OFF THE ELECTRICITY SUPPLY AND ALLOW THE COOKER TO COOL BEFORE CLEANING**

### CLEANING MATERIALS

Before using any cleaning materials on your cooker, check that they are suitable and that their use is recommended by the manufacturer.

Cleaners that contain bleach should NOT be used as they may dull the surface finishes. Harsh abrasives should also be avoided.

### CLEANING THE RADIANT HOB AND HOTPLATE TRIMS (SB 420/ SB 430)

Clean the hob surface with liquid detergent or mildly abrasive cream cleaner, e.g. Flash.

The hotplate trims are removable for cleaning, and can be washed in the dishwasher.

The spillage tray below the hotplates can be cleaned using a soap impregnated steel wool pad.

For convenience, the hob is hinged and can be supported using the hob stay rod during cleaning.

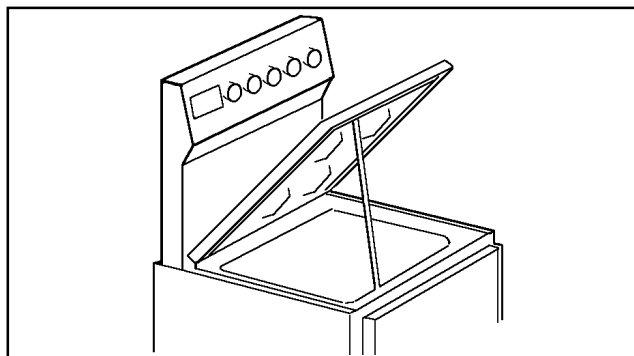

### CLEANING THE SOLID HOTPLATES AND HOTPLATE TRIMS (SB 421 ONLY)

In order to maintain the appearance of your cooker's solid hotplates and trims you are advised to use the recommended cleaning agents daily. If you do not allow spillages to burn on they will be much easier to clean off.

### THINGS TO NOTE

The red spot in the centre of the hotplates may be removed with some abrasive cleaning agents. This is not a fault and does not affect the performance of the hotplate.

### FOR NORMAL SOILAGE

Wipe over the hotplates and trims using a clean damp cloth then switch to a low or medium setting for a few minutes to thoroughly dry.

### FOR HEAVY SOILAGE

Use a clean damp cloth or scourer with a cream cleaner e.g. 'Jif' or 'Flash' or a powder cleaner e.g. 'Ajax' on the hotplate and trims. Follow the circular grooved pattern on the hotplate when cleaning. Rinse off cleaning agents thoroughly. Dry as for normal soilage.

For more stubborn marks warm the hotplate on a low setting for 30 seconds. Clean the solid plate with 'Ajax' powder cleaner, 'Jif' or Flash cream cleaner or a Brillo pad. You may have to rub hard for several minutes.

Rinse off cleaning agents thoroughly with a damp cloth. Switch to a low or medium setting for a few minutes until the hotplate is thoroughly dry.

### CLEANING THE HOTPLATE TRIMS

The stainless steel trims may become straw coloured during use. Using a proprietary stainless steel cleaner, e.g. 'Shiny Sinks' will help maintain a bright appearance. Alternatively a powder cleaner such as 'Bar Keepers Friend' may be used regularly.

### CLEANING THE VITREOUS ENAMEL

Use a clean damp cloth or scourer made for non-stick saucepans with 'Jif' or 'Flash' cream cleaner.

### AFTER CLEANING

To maintain the appearance of the hotplates occasionally apply a little salt free vegetable oil or commercial restorative agent e.g. '4 Hob' or use a 'Minky' Hotplate Cleaning Cloth.

To apply vegetable oil, first heat the hotplate on a medium setting for 30 seconds then turn OFF. Pour a very small amount of oil onto kitchen paper, apply the paper to the hotplate and wipe off any excess oil. Heat the hotplate on a medium setting for 1 minute.

To apply restorative agent, apply a thin coating of '4 Hob' or use a Minky cloth following the manufacturers instructions.

### CLEANING THE OUTSIDE OF THE COOKER

DO NOT use abrasive cleaning materials, or scourers on the outside of the cooker as some of the finishes are painted and damage may occur. Regularly wipe over the control panel, splashback, oven doors and cooker sides using a soft cloth and liquid detergent.

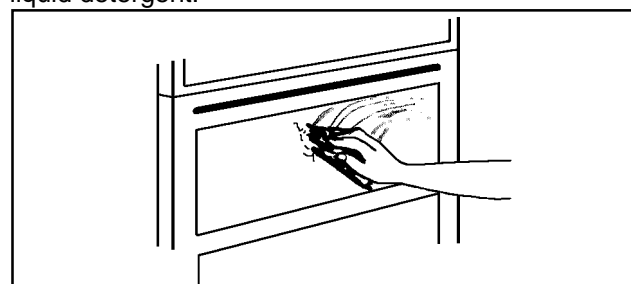

**DO NOT ATTEMPT TO REMOVE ANY OF THE CONTROL KNOBS FROM THE PANEL AS THIS MAY CAUSE DAMAGE AND IS A SAFETY HAZARD**

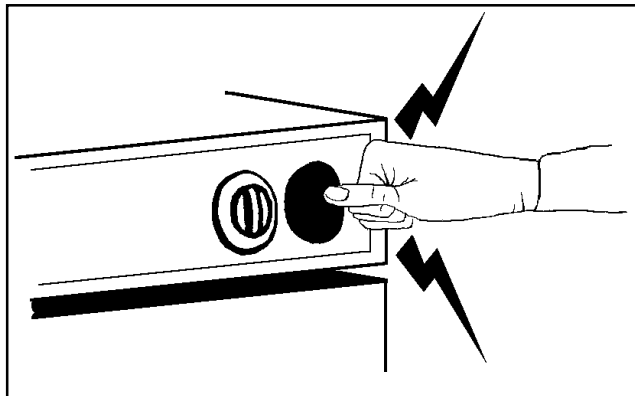

### **CLEANING THE GRILL DEFLECTOR, GRILL PAN, GRILL PAN GRID AND OVEN SHELVES**

All removable parts, except the grill pan handle, can be washed in the dishwasher. The chrome hotplate supports should NOT be removed.

The grill pan and grill deflector can be cleaned using a soap impregnated steel wool pad. The grill pan grid and oven shelves should be cleaned using hot soapy water. Soaking first in soapy water will make cleaning easier.

### **CLEANING INSIDE THE OVEN/GRILL COMPARTMENTS**

The Stayclean surfaces inside the ovens should not be cleaned manually. See "Care of Stayclean Surfaces".

The vitreous enamel oven base can be cleaned using normal oven cleaners or aerosol oven cleaners with care. Ensure that the manufacturers instructions are followed and that all parts are well rinsed afterwards.

**Aerosol cleaners must not be used on Stayclean surfaces and must not come into contact with elements as this may cause damage.**

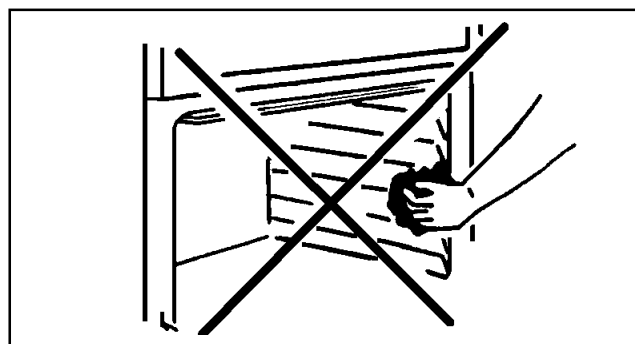

## **CARE OF STAYCLEAN SURFACES**

Stayclean surfaces destroy splashes of food and fats when the oven temperature is raised to around 220°C.

It is a good idea to run the oven for an hour or two per week to ensure continued good performance from the Stayclean finish.

Do use the trivet in the roasting tin. During roasting, the fat from the joint will be contained beneath the trivet and therefore prevent it from splashing onto the stayclean finish.

### **HINTS AND TIPS**

- Manual cleaning of Stayclean IS NOT recommended. Damage will occur if oven sprays or abrasives of any kind are used.
- Slight discolouration and polishing of the Stayclean surface may occur in time. This does not affect the Stayclean properties in any way.
- A good time to allow the oven to run on is after the weekly roast. After removing the roast, turn the oven up to 220°C and allow to run for an hour or so. It is important NOT to allow a build-up of soilage as this can prevent the Stayclean from working.
- Follow the recommendations below to keep oven soilage to a minimum.
- Cook at the recommended temperatures. Higher temperatures during roasting will increase soilage. Try cooking at lower temperatures for an increased length of time, you will save energy and often the joint is more tender.
- Use minimal, if any, extra oil or fat when roasting meat, potatoes only require brushing with fat before cooking. Extra fat in the oven during roasting will increase splashing and soilage.
- It is NOT necessary to add water to the meat tin when roasting. The water and the fat juices from the joint create excessive splattering during cooking - even at normal temperatures, as well as causing condensation.
- Covering joints during cooking will also prevent splashing onto the interior surfaces. Removing the covering for the last 20-30 minutes will allow extra browning if required. Some large joints and turkeys especially benefit by this method of cooking, allowing the joint to cook through before the outside is over-browned.

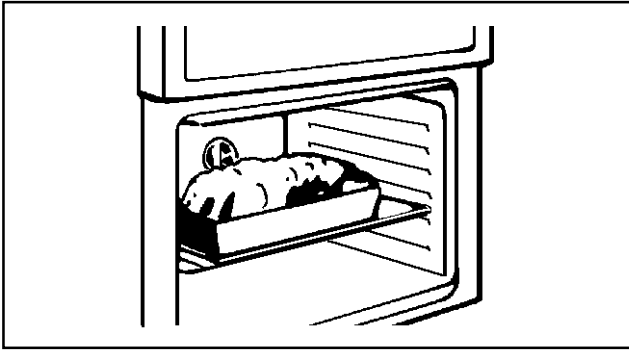

## REPLACING THE OVEN LIGHT BULB (SB 430 ONLY)

The type of bulb required is a 300C 25 watt small Edison Screw. Part number 572 491 5431-00/1 (Available through the Tricity Bendix service centres).

**CAUTION:** Disconnect the appliance from the electricity supply before replacing the bulb.

Open the door and remove the shelves to enable easy access to the oven light assembly. Insert a flat blade screwdriver between the oven side and the glass which covers the bulb.

Support the glass with your hand and prise out sufficiently to release the glass cover. Unscrew the bulb in a anticlockwise direction until it is possible to remove the bulb with ease.

Fit the new bulb by turning in a clockwise direction until it is secure. Ensuring the indent to the flange is pointing to the rear of the oven, replace the glass by pushing it firmly into the hole to cover the bulb assembly.

Replace the shelves. Restore the electricity supply and adjust the time of day and clock, as necessary.

## SOMETHING NOT WORKING?

We strongly recommend that you carry out the following checks on your appliance before calling a Service Engineer. It may be that the problem is a simple one, which you can solve yourself without the expense of a service call.

If our Service Engineer finds that the problem is listed below you will be charged for the call whether or not the appliance is under guarantee.

### **The cooker does not work at all:**

- \* Check that the appliance has been wired in and is switched on at the wall.
- \* Check that the main cooker fuse is working.
- \* Check that the timer is set to manual (see page 13).

### **The grill and hotplates work but the oven does not:**

- \* Check that the timer is set to manual operation (see page 11).

### **The oven temperature is too high or low:**

- \* Check that the recommended temperatures are being used (see page 23). Be prepared to adjust up or down by 10°C to achieve the results you want.

### **The hotplates and oven work but the grill does not:**

- \* Check that you have carefully followed the instructions for operation of the grill.

### **The oven is not cooking evenly or the side opening door will not stay open:**

- \* Check that the cooker is level.

### **The oven fan is noisy:**

- \* Check that bakeware is not vibrating in contact with the back panel.
- \* Check that the oven is level.

## SERVICE AND SPARE PARTS

### HELP US TO HELP YOU

Please determine your type of enquiry before writing or telephoning.

### SERVICE

It is a recommendation by the manufacturer that annual servicing of the product is done by the manufacturers approved service organisation.

In the event of your appliance requiring service Tricity Bendix Limited have an arrangement with Electrolux Group Service.

Before calling out an Engineer, please ensure you have read the details under the heading "Something Not Working?" and have the model number and purchase date to hand. The telephone number and address for service is detailed on the list headed "Customer Service Centres".

PLEASE NOTE that all enquiries concerning service should be addressed to your local Customer Service Centre.

### CONSUMER CARE DEPARTMENT

**FOR GENERAL ENQUIRIES** concerning your Tricity Bendix cooker or further information on Cooking, Cooling or Washing products, you are invited to contact our Consumer Care Department by letter or telephone as follows:

Consumer Care Department  
Tricity Bendix Limited  
99 Oakley Road  
Luton  
Bedfordshire LU4 9QQ  
Tel: (01582) 585858

## CUSTOMER SERVICE CENTRES

The Regional Electricity Companies are responsible for the servicing of cookers sold by their own outlets. The telephone numbers can be found in the telephone directory.

Service for cookers bought from other outlets can be obtained by calling the nearest Customer Service Centre on the numbers given below. The areas are defined by postcode for easy reference.

CENTRE	POSTAL DISTRICTS	SERVICE APPOINTMENTS	ADDRESS
ABERDEEN	AB	01224-696569	Electrolux After Sales Service Northeast Appliance Service 8 Cornhill Arcade Cornhill Drive Aberdeen AB2 5UT
ARGYLL	PA 24-61	01369-703161	Electrolux After Sales Service T.D.C. Refrigeration Briar Hill 7 Hill Street Dunoon Argyll PA23 7AL
BARNSTAPLE	EX18-23, 31-39	01271-328826	Electrolux After Sales Service McBain Refrigeration Unit 4 Upcott Avenue Pottington Industrial Estate Barnstaple N.Devon EX31 1HN
BORDERS	TD	01573-224411	Electrolux After Sales Service James Stewart & Son 2-8 Wood Market Kelso Borders TD5 7AX
BRISTOL	BA BS TA SP	0117-9211876	Electrolux After Sales Service Unit BE46 PO Box 372 Bristol BS99 1UD
CANVEY	E EC EN N NW W WC AL CB HA HP LU MK SG UB WD CM CO IG RM SS IP NR PE14-19,30-38	0181-443-3464 0181-965-9699 0181-965-9699 01268-694144 01603-667017	Electrolux After Sales Service 2-4 Sandhurst Kings Road Canvey Island SS8 0QY
CARDIFF	CF NP1-4, 6, 9-44,SA1-18 SA21-32	01222-460131	Electrolux After Sales Service Guardian Industrial Estate Clydesmuir Road Tremorfa Cardiff CF2 2QS
CUMBRIA	CA	01228-594747	Electrolux After Sales Service E.T.B. Services Carlisle Enterprise Centre James Street Carlisle CA2 5AP
DUMFRIES & GALLOWAY	DG1-14	01387-265166	Electrolux After Sales Service Allan Crossan (Service) 93 Irish Street Dumfries Scotland
DUNDEE	Parkinson Cowan Gas Only	01382-642828	Electrolux After Sales Service Tayside Refrigeration 3-7 Blackness Street Dundee DD1 5LR
DUNDEE	DD1-14 PH8-18	01250-876285	Electrolux After Sales Service 1 Brogan Domestic 41 Leslie Street Blairgowrie Perthshire PH10 6AT

GLASGOW	EH FK G KA KY1-16 ML PA1-23, PH1-7	0141-647-4381	Electrolux After Sales Service 20 Cunningham Road Clyde Estate Rutherglen Glasgow G73 1PP
GUERNSEY	All Codes	01481-46931	Guernsey Electricity PO Box 4 Vale Guernsey Channel Islands
HAVERFORDWEST	SA33-39 SA41-44 SA61-73	01437-710914	Electrolux After Sales Service C Butherway 1 Church Road. Roch Haverfordwest Dyfed Wales SA62 6AG
HEREFORD	HR1-9 LD1-8 SY7 ,18 NP5 NP7-8	01432-340334	Electrolux After Sales Service Domestic Repair Centre Unit 3 Bank Buildings Cattle Market Hereford HR4 9HX
HULL	YO4 YO11-18 YO25 HU1-19 DN14	01482-585678	Electrolux After Sales Service John Sizer Unit 1 Boulevard Unit Factory Estate Hull HU3 4AY
INVERNESS	IV1-28, 30-36, 52-56, PH19-26, 42-44 KW1-14	01463-792952	Electrolux After Sales Service Highland Appliances Unit 3B3 Smithton Industrial Est Smithton Inverness
INVERNESS	PH30-41 IV40-51	01855-821315	Electrolux After Sales Service George Ross Electrical Forrestry Workshop Inchree Onich Inverness-shire PH33 6SE
ISLE OF WIGHT	PO30-41	01983-872552	Electrolux After Sales Service Wyatts Electrical Service 4 Forelands Road Bembridge Isle of Wight PO35 5XW
ISLE OF ARRAN	KA27	01770-302909	Electrolux After Sales Service Arran Domestic Unit 4 The Douglas Centre Brodick Isle of Arran KA27 8AJ
ISLE OF MAN	IM	01624-663455	Electrolux After Sales Service Manx Electricity Service Workshop North Quay Douglas Isle of Man
ISLE OF MULL	PA62-75	01688-302262	Electrolux After Sales Service B Hogg Braeside Raeric Road Tobermory Isle of Mull PA75 6PU
JERSEY	ALL CODES	01534-505050	Jersey Electricity Company PO Box 45 Queens Road St Helier Jersey, Channel Islands JE4 8NY
LAMPETER	SA19,20 SA40 SA45-48 SY23-25	01570-423020	Electrolux After Sales Service Lampeter Domestic Appl. Services Unit 16 Lampeter Ind. Est. Lampeter SA48 7DY



LANCASTER	LA1-23	01772-316175	Electrolux After Sales Service NL Services Unit 333 Ranglet Road Walton Summit Bamber Bridge Preston, Lancashire PR5 8AR
LEEDS	BD DN1-7, 10-12, HD HG HX LS S WF YO1-3, 5-8 DE NG1-22 & 25	0113-2608511	Electrolux After Sales Service 64-66 Cross Gates Road Leeds LS15 7NN
LINCOLN	DN21 sub codes 1 2 & 5 only, LN1, 2, 4,5,6 LN3 sub codes 4 & 5 only LN8-10 NG 23,24 31-34 PE1-13, 20-25	01522-514603	Electrolux After Sales Service Brian Hudson Unit 8 Stonefield Park Clifton Street Lincoln LN5 8AA
LIVERPOOL	FY PR L WN CH CW WA (Not WA 14/15)	0151-2541724	Electrolux After Sales Service Unit 1 Honeys Green Precinct Honeys Green Lane West Derby Liverpool L12 9JH
MANCHESTER	BB BL OL M SK WA14 & 15 only	0161-4777758	Electrolux After Sales Service Unit 30 Oakhill Trading Estate Devonshire Road Worsley Manchester M28 3PT
NEWTON ABBOTT	EX1-17 TQ PL1-9, 16, 19-21	01626-65909	Electrolux After Sales Service South West Domestic Service Unit 2 Zealley Industrial Est Kingsteignton Newton Abbott South Devon TQ12 3SJ
NORTH WALES	LL	01745-591616	Electrolux After Sales Service GMS (Cymru) Unit 2 Coed- Parc Abergele Road Rhuddlan Clwyd, Wales LL18 5UG
NORTHERN	DL TS DH YO21, 22 DH NE SR	01325-301400 0191-493-2025	Electrolux After Sales Service PO Box 40 Preston Road Aycliffe Industrial Estate Newton Aycliffe, Co Durham DL5 6XA
NORTHERN IRELAND EAST	BT1-30, 36-57, 63-67	01232-746591	Electrolux After Sales Service Unit C3 Edenderry Industrial Estate 326 Crumlin Road Belfast BT14 7EE
NORTHERN IRELAND WEST	BT31-35, 60-62, 68-82, 92-94	01861-510400	Electrolux After Sales Service G & O (Armagh) Service Owenmore House Kilwee Business Park Upper Dunmurray Lane Belfast BT17 0HD
NUNEATON	B DY ST TF WR WS WV GL NN OX SN CV LE	0121-358-7076 0121-358-5051 01993-704411 01203-350420	Electrolux After Sales Service Unit 23-24 Alliance Business Pk Townsend Drive Nuneaton Warwickshire CV11 6RX
ORKNEY	KW15-17	01856-875457	Electrolux After Sales Service Refrigeration Sales and Services Hatson Ind. Estate Kirkwall Orkney
REDDITCH	TBA	TBA	Electrolux After Sales Service Heming Road Washford Redditch Worcestershire B98 ODH

REDRUTH	TR1-20, 26, 27 PL10-15, 17, 18, 22-35	01209-314407	Electrolux After Sales Service Cornwall Domestic Service Unit 7D Pool Industrial Estate Wilson Way Redruth Cornwall TR15 3QW
ROTHSAY	PA20	01700-504777	Electrolux After Sales Service D McGlashan Walker Walker Engineering Glenmhor Upper Serpentine Rothesay PA20
SHETLAND	Own Sales	01595-692225	Electrolux After Sales Service Tait Electronic Systems Ltd. Holmsgarth Road Lerwick Shetland ZE1 OPW
SHETLAND	Own Sales	01595-692855	Electrolux After Sales Service Bolts Shetland Ltd. 26 North Road Lerwick Shetland ZE1 OPE
SHETLAND	ZE2	01806-566546	Electrolux After Sales Service Leask Electrical Harsdale Symbister Shetland ZE2 9AA
SHREWSBURY	SY1-6 SY8-17 SY19-22	01743-450279	Electrolux After Sales Service BLI Service 6 Harlescott Barn Harlescott Lane Shrewsbury SY1 3SY
SOUTH COAST	BN16-18. GU27-35 PO1-22. BH DT SO TR21-25	01705-667411 01705-667411 0117-9211876	Electrolux After Sales Service Limerline Road Hilsea Portsmouth Hampshire PO3 5JJ
SOUTH HUMBERSIDE	DN 8, 9, DN15-20 DN21 sub codes 3,4 only DN31-40 LN (3 sub code 6 only), 7 LN11-13	01472-267978	Electrolux After Sales Service John Robinson (Electrical) Unit 74 New Enterprise Centre King Edward Street Great Grimsby DN31 3JP
TONBRIDGE	SL GU1-26. RG CT DA ME TN BN1-15, 20-27, RH TW BR CR SE SW SM KT	01252-24505 01732-357722 01273-694341 0181-658-9069	Electrolux After Sales Service Unit 30 Deacon Trading Estate Morley Road Tonbridge Kent TN9 1RA

**We, Tricity Bendix, undertake that if within 12 months of the date of the purchase this Tricity Bendix appliance or any part thereof is proved to be defective by reason only of faulty workmanship or materials, we will, at our option repair or replace the same FREE OF ANY CHARGE for labour, materials or carriage on condition that:**

- The appliance has been correctly installed and used only on the electricity supply stated on the rating plate.
- The appliance has been used for normal domestic purposes only and in accordance with the manufacturers operating and maintenance instructions.
- The appliance has not been serviced, maintained, repaired, taken apart or tampered with by any person not authorised by us. Any servicing or repairs carried out by any unapproved third party will invalidate the approvals status of this product.
- All service work under this guarantee must be undertaken by a Tricity Bendix service representative or authorised agent.
- Any appliance or defective part replaced shall become the Company's property.
- This guarantee is in addition to your statutory and other legal rights.

### EXCLUSIONS

**This guarantee does not cover:**

- Damage or calls resulting from transportation, improper use or neglect, the replacement of any light bulbs or removable parts of glass or plastic.
- Cost incurred for calls to put right an appliance which is improperly installed or calls to appliances outside the United Kingdom.
- Appliances found to be in use within a commercial environment, plus those which are subject to rental agreements.
- Products of Tricity Bendix manufacture which are not marketed by Tricity Bendix.
- EEC Countries. The standard guarantee is applicable but subject to the owners responsibility and cost to ensure the appliance meets the standards set by the Country of which the product is taken. Electrolux Aftersales Service in the Country concerned, with whom Tricity Bendix have an arrangement, will be pleased to advise further.

## RATING PLATE REFERENCE

MAKE AND MODEL NO.	SERIAL NO.	DATE OF PURCHASE

### IMPORTANT NOTICE

In line with our continuing policy of research and development, we reserve the right to alter models and specifications without prior notice.

This handbook is accurate at the date of printing, but will be superseded and should be disregarded if specifications or appearance are changed.

# TRICITY BENDIX



Better Products. Better Value.

TRICITY BENDIX, 99 OAKLEY ROAD, LUTON, BEDFORDSHIRE, LU4 9QQ

A Division of Emaco Limited . Registered in England No. 176547 . Registered Office. 101 Oakley Road, Luton LU4 9RJ.

MODEL NO.  
**SB 420/SB 421/SB 430**



PART NO.  
**311125611**