



Rugged Tablet Computer **User's Manual**

© 2012 Trimble Navigation Limited. All rights reserved.

TRADEMARKS

Trimble and the Globe & Triangle logo are trademarks of Trimble Navigation Limited, registered in the United States Patent and Trademark Office and in other countries. Yuma is a trademark of Trimble Navigation.

Microsoft, Windows, and the Windows logo are either registered trademarks or trademarks of Microsoft Corporation in the United States and/or other countries. Microsoft products are licensed to OEMs by Microsoft Licensing, Inc., a wholly owned subsidiary of Microsoft Corporation.

The Bluetooth® word mark and logos are registered trademarks owned by Bluetooth SIG, Inc.

All other brand and product names are trademarks or registered trademarks of their respective owners.

NOTE

Display images shown may vary slightly from actual display. Information in this manual is subject to change without notice.

Table of Contents

Chapter 1: Getting Started	1-1
Unpacking	1-2
Device Overview	1-3
Front View.....	1-3
Rear View	1-5
Bottom View.....	1-6
Installing the Stylus	1-7
Removing the Stylus.....	1-7
Installing the SIM Card	1-8
Installing the Battery Packs	1-9
Connecting to AC Power	1-10
Turning the Tablet Computer On and Off	1-11
Turning On.....	1-11
Turning Off.....	1-12
Chapter 2: Operating Your Tablet Computer	2-1
Using the Touch Screen	2-2
Calibrating the Screen	2-3
Using the Input Panel	2-4
Opening the Input Panel.....	2-5
Managing the Input Panel.....	2-5
Using the Control Panel	2-6
Using the Function Keys.....	2-6

Adjusting Volume	2-7
Adjusting Screen Brightness.....	2-7
Using Wireless LAN	2-8
Turning the Wireless Antenna On and Off	2-8
Connecting to a Wireless Network.....	2-9
Using Bluetooth	2-10
Turning the Bluetooth Adapter On and Off.....	2-10
Pairing with Bluetooth Devices	2-10
Configuring Bluetooth Settings	2-13
Appendix A: Regulatory Information	A-1
FCC Regulations	A-2
RF Exposure Information (SAR)	A-3
IC Regulations.....	A-3
Important Note	A-4

Preface

This manual contains information that will help you operate this rugged tablet computer. It is divided into five chapters and two appendix.

- **Chapter 1: Getting Started**, takes you through the process of setting up your tablet computer and identifying its external components.
- **Chapter 2: Operating Your Tablet Computer**, tells you how to use the tablet computer's components and features.
- **Chapter 3: Expanding Your Tablet Computer**, provides information on installing and using peripheral devices.
- **Chapter 4: Managing Power**, provides information on power management.
- **Chapter 5: Using BIOS Setup and System Recovery**, describes the BIOS Setup utility that configures the tablet computer's BIOS settings and system recovery utility that reinstalls Windows to the tablet computer.
- **Appendix A**, provides information on caring for your tablet computer, and gives solutions to common problems you may encounter when using the tablet computer.
- **Appendix B**, provides regulatory information and safety notices on your tablet computer.

Notational Conventions

Throughout this manual, the following conventions are used to distinguish elements of text.

| **NOTE:** Identifies additional information that requires special attention.

| **CAUTION:** Identifies important information that, if not followed, may result in loss of data or damage to the tablet computer..

Hardware and keyboard keys are shown in a bold typeset. For example:

Press the **F1** key to complete.

A title, command, setup item, value, option, or button that you can see on the screen is shown in boldface. For example:

Select **When I press the power button**, set it to **Shut down**, and then tap the **Save changes** button.

Getting Started

Congratulations on purchasing this rugged tablet computer. The rugged design allows you to use it in harsh outdoor environments. You can use it under blazing heat, subzero cold, driving rain or dusty surroundings – places you could not take a consumer-grade tablet computer.

This chapter tells you step by step how to get the tablet computer up and running. You will find instructions for the following procedures:

- Unpacking
- Device Overview (An Explanation of External Components and their Functions)
- Installing the Stylus
- Installing the SIM Card
- Installing Battery Packs and Connecting to AC Power
- Turning the Tablet Computer On and Off

Unpacking

After unpacking the shipping carton, you should find these standard items. Inspect all items. If any item is damaged or missing, notify your dealer immediately.

- √ Tablet Computer



- √ Battery Pack x 2

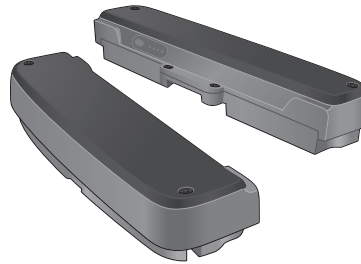

- √ Power Adapter



- √ Power Cord and Plugs



- √ Stylus



- √ Tether for Stylus



- √ Cleaning Cloth

- √ Screen Protector Film

- √ Windows 7 Certificate of Authenticity Label (COA)

- √ Quick Start Guide



Keep the shipping carton and packaging materials in case you need to ship or store the tablet computer in the future.

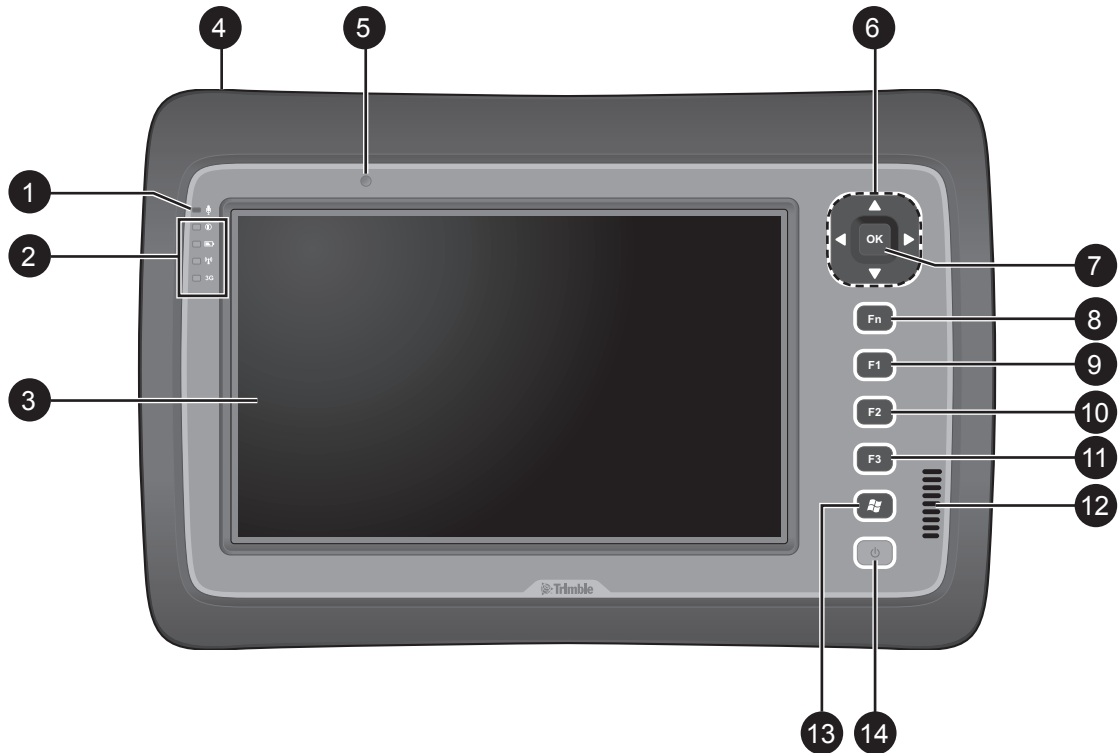

NOTE: Actual items may slightly differ depending on the model you purchased.

Device Overview

Front View



No.	Item	Description
1	Microphone	Use for chatting and other interactive applications.
2	LED Indicators	Shows the current status of the tablet computer.
	 Power	<ul style="list-style-type: none"> Solid green: Tablet computer is turned on Blinking green: Tablet computer is in sleep mode. Off: Tablet computer is turned off.
	 Battery	<ul style="list-style-type: none"> Solid amber: Battery is charging Solid green: Battery is fully charged. Blinking red: Battery power is low.
	 Wireless	Solid green: Wireless antenna is enabled. Off: Wireless antenna is disabled.
	3G 3G	Solid green: 3G data connection is active. Off: 3G data connection is inactive.

No.	Item	Description
3	Touch Screen	Displays and receives information for the tablet computer.
4	Kensington Lock	Provides lock mechanism security.
5	Web Camera	Use for video chatting and other interactive applications.
6	Directional Buttons	Serves as the up / down / left / right arrow keys.
7	OK Button	Serves as the Enter key.
8	Fn (Function) Button	<ul style="list-style-type: none"> • Press to display the button functions and toggle between Button Setting A, B, and C. • Press Fn + F1 / F2 / F3 to open the corresponding application. For example: <ul style="list-style-type: none"> • Fn + F1: Virtual keyboard • Fn + F2: Internet Explorer • Fn + F3: Media Player • Fn + : Ctrl + Alt + Del
9	F1 Button	Press to launch Windows Help .
10	F2 Button	Press to launch Internet Explorer .
11	F3 Button	Press to launch Media Player .
12	Speaker	Sends out sound and voice from your tablet computer.
13	Windows Button 	Press to launch the Start menu.
14	Power Button 	<ul style="list-style-type: none"> • Short press to enable sleep mode. • Long press to turn the tablet computer off.

Rear View

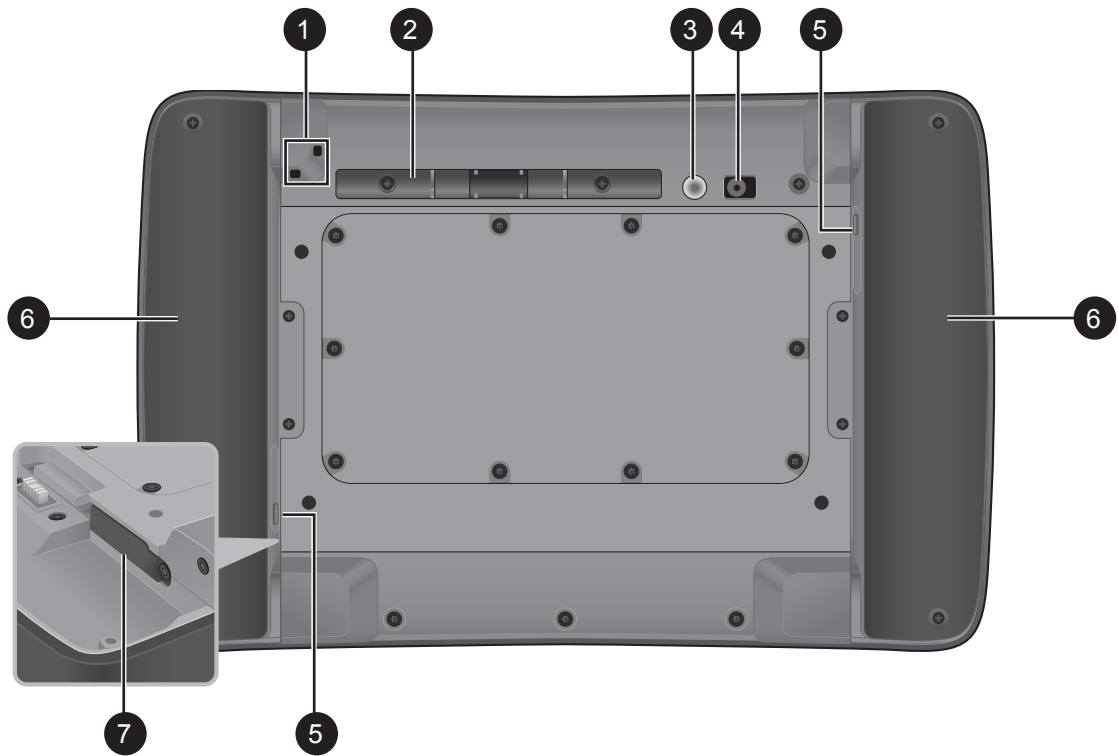

No.	Item	Description
1	Eyelet	Holds the tether strap.
2	Stylus Holder	Stores the stylus.
3	Camera Flash	Provides flash lighting for use with the camera.
4	CMOS Camera	Allows you to use the camera features.
5	Battery Capacity Indicator	Press the button to light the battery capacity LEDs. More lit LEDs indicate more battery power. The LEDs automatically go off after 5 seconds.
6	Battery Packs	Supplies power to your tablet computer when external power is not connected.
7	SIM Car Slot	Stores the SIM card which provides 3G data connection to your tablet computer.

Bottom View

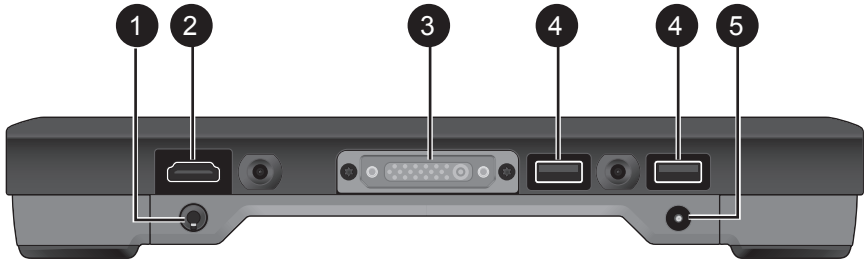

With Battery Packs

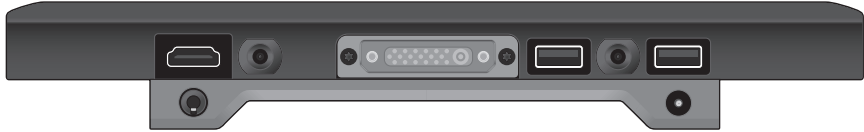

With Battery Packs Removed

No.	Item	Description
1	Audio Connector	Connects to a set of headphones, external speakers, or an audio recording device.
2	HDMI Connector	Connects to an HDMI device such as an external monitor.
3	Docking Connector	Connects to a docking station (optional).
4	USB Ports	Each port connects to a USB device, such as a USB flash drive, mouse, printer, keyboard, etc.
5	Power Connector	Connects to the AC adapter.

Installing the Stylus

Your tablet computer comes with a stylus for use with the touch screen.

The stylus holder at the back of the tablet computer provides a convenient place to store the stylus.

Perform the following to prepare and install the stylus to your tablet computer:

1. Loop one end of the tether to the stylus eyelet.
2. Loop the other end of the tether to the tablet computer eyelet.

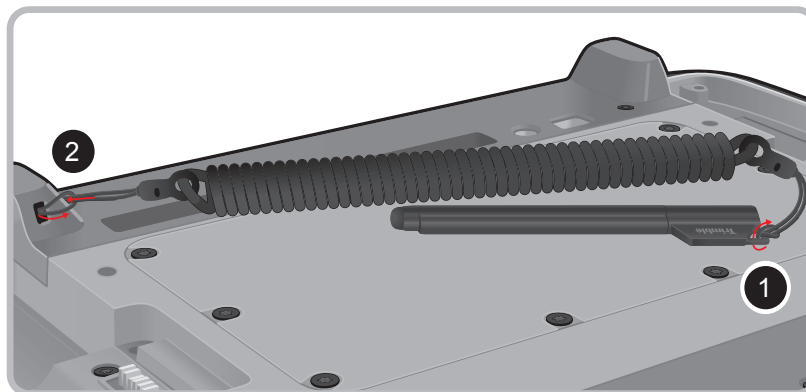

3. Push the stylus on the stylus holder until it locks into place.

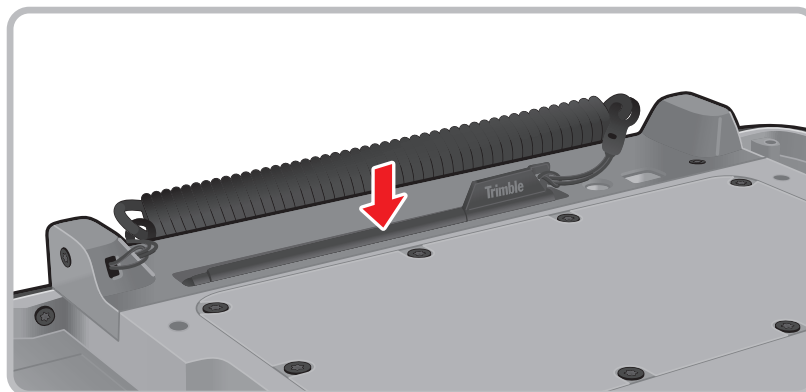

Removing the Stylus

Lift the stylus by its tab to remove it from the stylus holder.

For convenience of use, pull the tab to extend the stylus length.

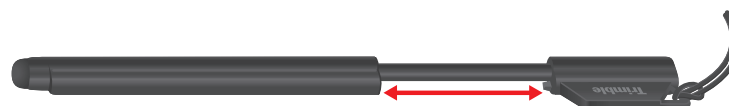

Installing the SIM Card

The tablet computer supports data connection using 3G SIM cards.

Perform the following to install the SIM card to your tablet computer:

1. With battery packs removed, locate the SIM card slot on the back of the tablet computer.
2. Open the SIM card slot cover.

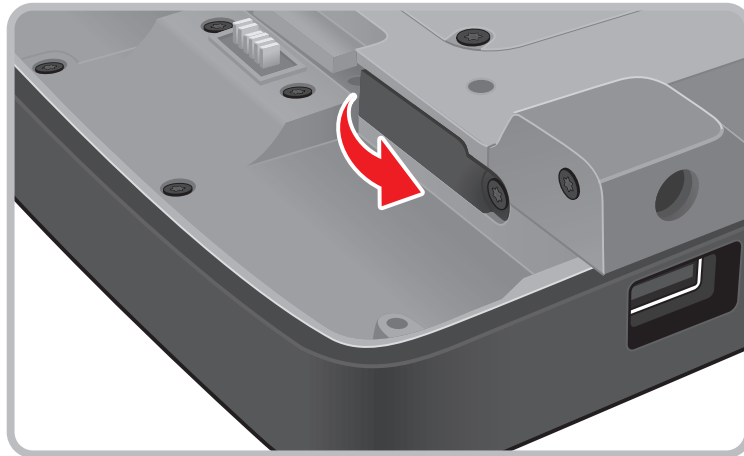

3. Insert the SIM card with the gold contacts facing down.

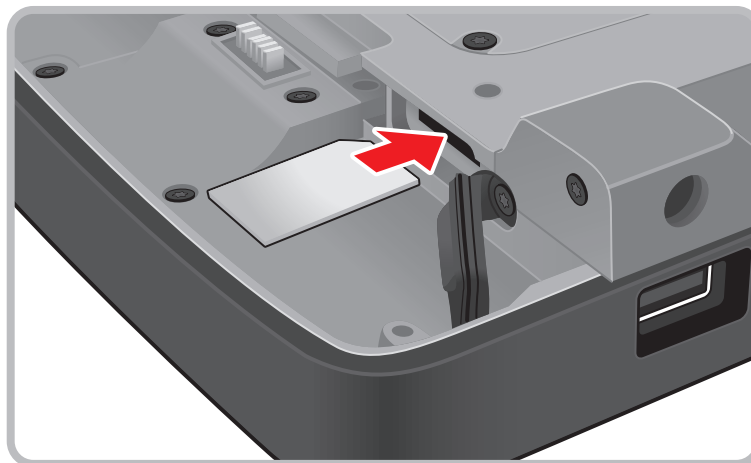

4. Close the SIM card slot cover.

NOTE: For more information on connecting to 3G network, see “Using 3G Network”.

Installing the Battery Packs

Perform the following to install the battery packs to your tablet computer.

1. Place the tablet computer face down on a flat even surface.
2. Fit the two battery packs into place on both sides.

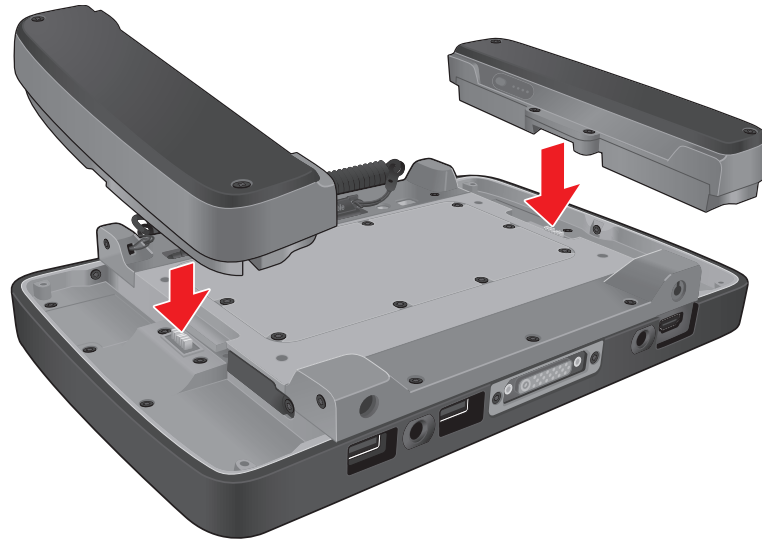

3. Using a small #1 Phillips screwdriver, secure the four screws on each battery taking care not to over tighten.

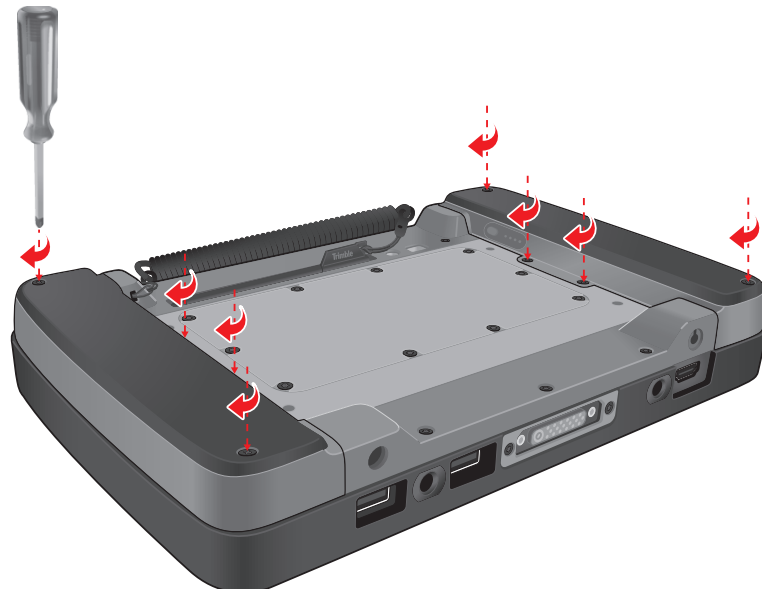

4. Connect the tablet computer to AC power to charge the battery packs. See “Connecting to AC Power” on page 1-10.

Connecting to AC Power

The tablet computer operates either on the external AC power or internal battery power. It is recommended to use AC power when you start up the tablet computer for the first time.

CAUTION: Use only the AC adapter included with your tablet computer. Using other AC adapters may damage the tablet computer.

Perform the following to connect the tablet computer to AC power:

1. With the battery packs installed, plug the DC cord of the AC adapter into the power connector of the tablet computer.
2. Plug the female end of the AC power cord into the AC adapter.
3. Then plug the male end of the AC power cord into an electrical outlet.

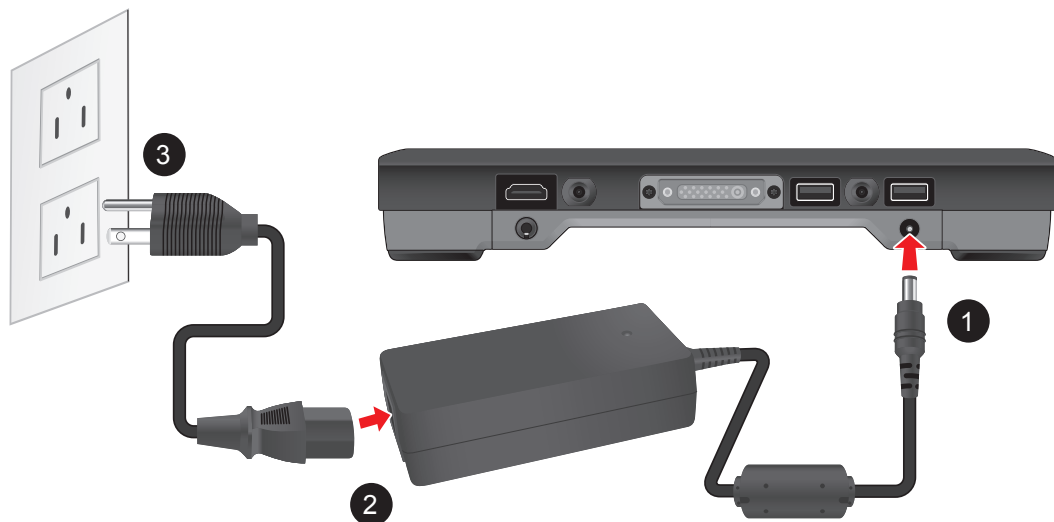

When the AC adapter is connected, the battery packs are charging. The battery LED indicator (🔋) shows three different states:

- **Solid amber:** Battery is charging
- **Solid green:** Battery is fully charged.
- **Blinking red:** Battery power is low.

CAUTION:

- When you disconnect the AC adapter, disconnect from the electrical outlet first and then from the tablet computer. A reverse procedure may damage the AC adapter or the tablet computer.
- When unplugging the connector, always hold the plug head. Never pull on the cord.

Turning the Tablet Computer On and Off

Turning On

1. Make sure that the tablet computer is either connected to an AC power or the battery packs are charged.
2. Press the power button . Notice the screen remains blank for 8 ~ 10 seconds but the power LED lights up.



The power LED indicator (①) shows two different states:



- **Solid green:** Tablet computer is turned on
- **Blinking green:** Tablet computer is in sleep mode.
- **Off:** Tablet computer is turned off.

Turning Off

To turn off the tablet computer, use the “**Shut Down**” command of your operating system.

CAUTION: Wait for at least five seconds after turning off the tablet computer before turning it back on.

When you finish a working session, you can stop the tablet computer by shutting it down or leaving the tablet computer in Sleep or Hibernation mode:

To stop in this mode...	Do this...
Off	Use the Windows Start Menu and follow the shut down procedure.
	You can force the tablet computer to turn off by pressing and holding the power button  for more than 6 seconds. This is not the recommended method, but may be necessary if the system is locked up.
Hybrid Sleep	Short press the power button  or use the Windows Start Menu to put the tablet computer in Hybrid Sleep mode.
Hibernation	Use the Windows Start Menu to put the tablet computer in hibernation mode.

Press the power button to resume or turn on the tablet computer from any of these modes. See ** “Power Management” for more information.

NOTE: By configuring the BIOS Setup Utility, you can have the tablet computer automatically start up or resume when the external AC power is plugged in. See ** BIOS Setup for more information.

Operating Your Tablet Computer

This chapter provides information about the use of the tablet computer and describes the operating basics of these components and features:

- Touch Screen
- Input Panel
- Control Panel
- Wireless LAN Features
- Bluetooth Features
- 3G Network Features
- GPS Features
- Camera

Using the Touch Screen

The touch screen is a touch-sensitive device that allows you to control and make selections on the tablet computer by controlling the location of the pointer on the screen.

CAUTION: Do not use sharp or pointed objects on the touch screen. These objects may scratch the screen. Use only the spring-tip end of the stylus or the tip of your finger.



Here are some common terms that you should know when using the touch screen.

Term	Action
Tap	Tap gently on the touch screen to select or open an item. Tapping is the same as clicking the left mouse button of a PC.
Double-tap	Rapidly tap twice on the touch screen. This action is similar to double-clicking the left mouse button of a PC.
Tap and hold	Tap and hold the stylus lightly on the display. A big circle appears to indicate that a pop-up menu will soon appear. Lift up the stylus and a pop-up menu appears. Select the desired function. This action is similar to a right mouse click on a PC.
Drag	Hold the stylus on the screen and drag across the screen to select text and images or move icons to a new location.

For a more customized stylus settings, go to **Start > Control Panel > Pen and Touch**.

Calibrating the Screen

When there is a noticeable discrepancy in the placement of the stylus on the screen and the indicated position of the onscreen pointer, recalibrate the screen.

Perform the following to calibrate the screen:

1. Tap **Start > Control Panel > Tablet PC Settings**.
2. On the **Display** tab, tap **Calibrate**.

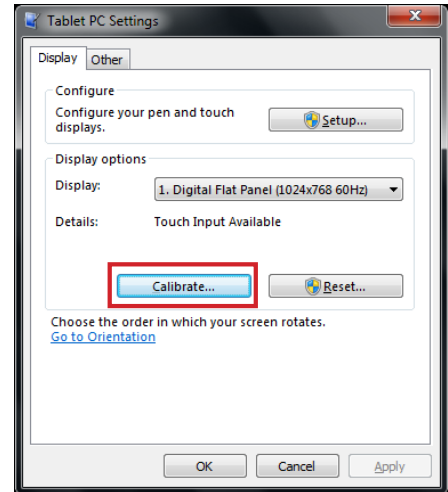

3. Tap the cross-hair with the stylus as it moves around the screen.

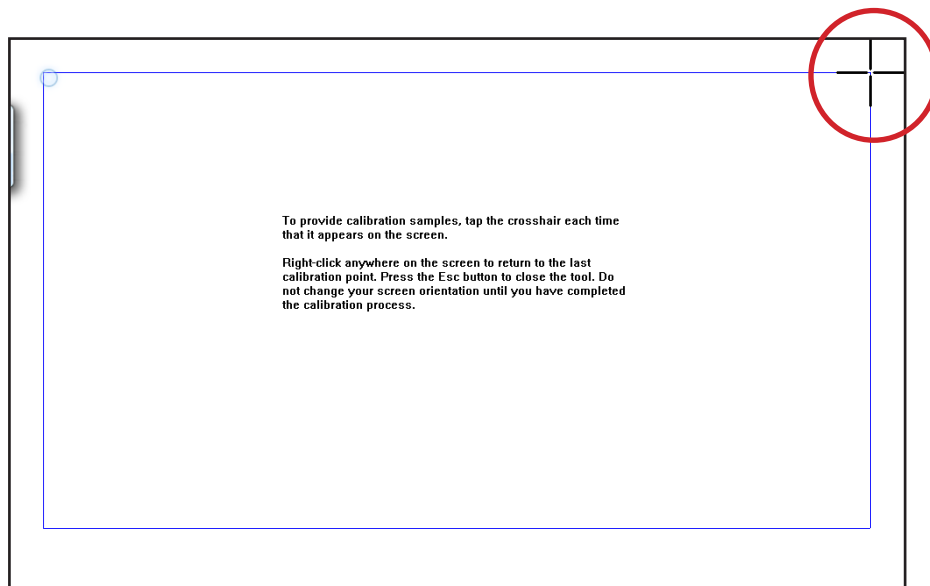

4. When calibration is complete, tap **Yes** to close the calibration utility screen.

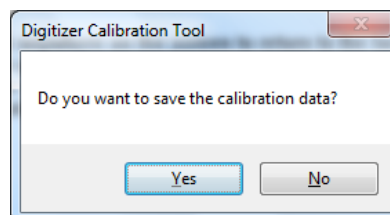

Using the Input Panel

The Tablet Computer Input Panel is a virtual keyboard that allows you to enter text and perform various keyboard functions.

There are two types of Input Panels for you to use:

- **Touch Keyboard**

Allows you to enter text by tapping the keys with the stylus, like pressing the keys on a standard keyboard.



- **Writing Pad**

Allows you to write on the writing pad, like writing on a piece of paper. Your handwriting will be converted into typed text.

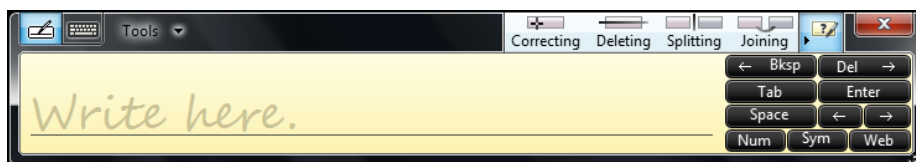

Opening the Input Panel



To open the Input Panel

There are two ways to open the Input Panel.

- Press Fn + F1
- From the left side of the screen, drag the edge of the Input Panel towards the center.



To switch between keyboards

To switch between Touch Keyboard and Writing Pad, tap  or  at the upper left corner of the Input Panel.

Managing the Input Panel

To change the Input Panel size

To increase the size of the Input Panel, select the lower right corner of the Input Panel and drag.

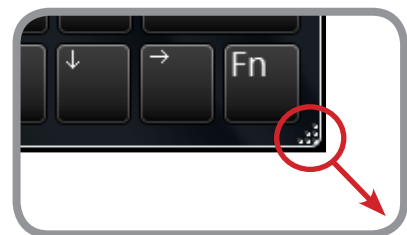

To position the Input Panel

The Input Panel floats on top of the screen by default. To move the Input Panel to an area on the screen, place the stylus on the title bar and drag the Input Panel to a new location on the screen.

To dock the Input Panel

You can dock the Input Panel so that it is anchored at the top or the bottom of the screen. On the Input Panel, tap **Tools** > **Docking**, and tap **Dock at top of screen** or **Dock at bottom of screen**.

NOTE: For more information on using the Input Panel, see Windows' online help.

Using the Control Panel

The Control Panel provides shortcuts for you to utilize the applications and functions of your Tablet Computer, such as opening an application, adjusting the brightness setting or volume, and others.

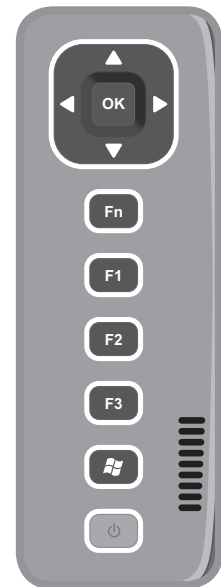



Using the Function Keys

Press the **Fn** key to display the Control Panel button information. The buttons have three settings: Setting A, Setting B, and Setting C.

By pressing a combination of function keys, you can open an application or bring up the Input Panel.

By default, the following function keys are configured with the corresponding applications:

Function Keys	Applications to Access
F1	Windows Help
	Start Menu
Fn + F1	Virtual Keyboard (Input Panel)
Fn + F2	Internet Explorer
Fn + F3	Media Player
Fn + 	Task Manager (similar to pressing Ctrl + Alt + Del in PC)
Fn + Fn + F1	Notepad Starter.xml
Fn + Fn + F2	Starter.xml
Fn + Fn + F3	Calculator

To configure the Function Keys

1. Open an application.
2. Press and hold a Function Key that you want to associate with the application.

Adjusting Volume

Perform the following to adjust the volume of your Tablet Computer:

- To increase volume, press **Fn + Fn**, then press **▲** or **▶** repeatedly.
- To decrease volume, press **Fn + Fn**, then press **▼** or **◀** repeatedly.

Adjusting Screen Brightness

Perform the following to adjust the screen brightness of your Tablet Computer:

- To increase brightness, press **Fn**, then press **▲** or **▶** repeatedly.
- To decrease brightness, press **Fn**, then press **▼** or **◀** repeatedly.

Using Wireless LAN

Your Tablet Computer has a built-in wireless antenna which automatically detects wireless networks that are within range.

It takes approximately 30 seconds for your Tablet Computer to make a successful wireless connection and approximately 10 seconds to disconnect.

Turning the Wireless Antenna On and Off

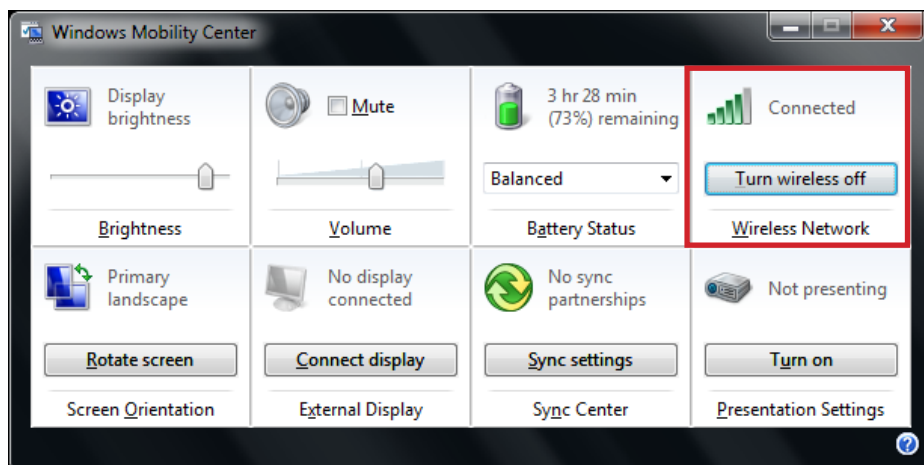

By default, the wireless antenna is turned on. In case you need to turn the wireless antenna on or off, perform the following:

1. Tap **Start > Control Panel > Windows Mobility Center**.
2. To turn the wireless antenna on or off, tap **Turn wireless on** or **Turn wireless off**.



Connecting to a Wireless Network

Perform the following to connect to a wireless network:

1. Make sure that the wireless antenna is “on” (The Wifi LED indicator in solid green and the Wireless network icon on the taskbar shows ).
2. Tap the Wireless Network icon () on the taskbar.
3. In the list of available networks, tap a network.



4. Tap **Connect**.
5. If the network requires authentication, enter the security key or passphrase.

NOTE:

- Once you are connected to a wireless network, Windows saves the network profile and will automatically connect to that network when it is in range.
- For more information on connecting to a wireless network, see Windows's online help.

Using Bluetooth

Your Tablet Computer has integrated Bluetooth capability for short-range wireless communication between Bluetooth-enabled devices.

By default, the Bluetooth feature is enabled as indicated by the Bluetooth icon () on the taskbar; but your Tablet Computer is not visible to other devices. To make your Tablet Computer visible, check the **Discovery** box in Bluetooth settings (see “*Configuring Bluetooth Settings*” on page 2-13).

Turning the Bluetooth Adapter On and Off

In case you need to turn the Bluetooth adapter on or off, perform the following:

1. Tap the Bluetooth On () or Bluetooth off () icon on the taskbar.
2. A pop up menu appears. Tap **Turn adapter on** or **Turn adapter off**.



NOTE: If the Bluetooth icon is not shown on the taskbar, tap **Start > Devices and Printers**. Under **Devices**, tap and hold the Bluetooth adapter icon, a pop up menu appears. Tap **Bluetooth settings**, then check **Show the Bluetooth icon in the notification area**, and tap **OK**.

Pairing with Bluetooth Devices

Before you can pair with Bluetooth devices for the first time, you need to add and save the device profile to your Tablet Computer.

To add and pair a Bluetooth device

Perform the following to pair your Tablet Computer with Bluetooth devices:

1. Make sure the Bluetooth adapter is on as indicated by the Bluetooth icon () on the taskbar.
2. Tap the Bluetooth icon () to display a pop up menu.

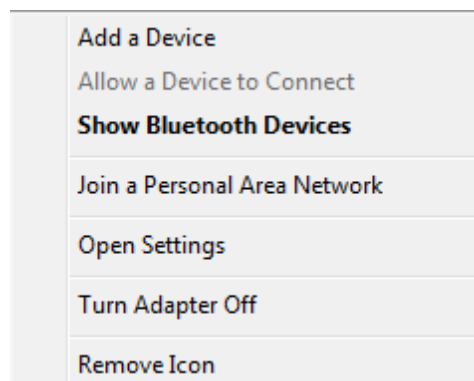

3. Tap **Add a Device**. The Tablet Computer will scan for Bluetooth devices within range.
4. Tap the device you want to pair with, then tap **Next**.

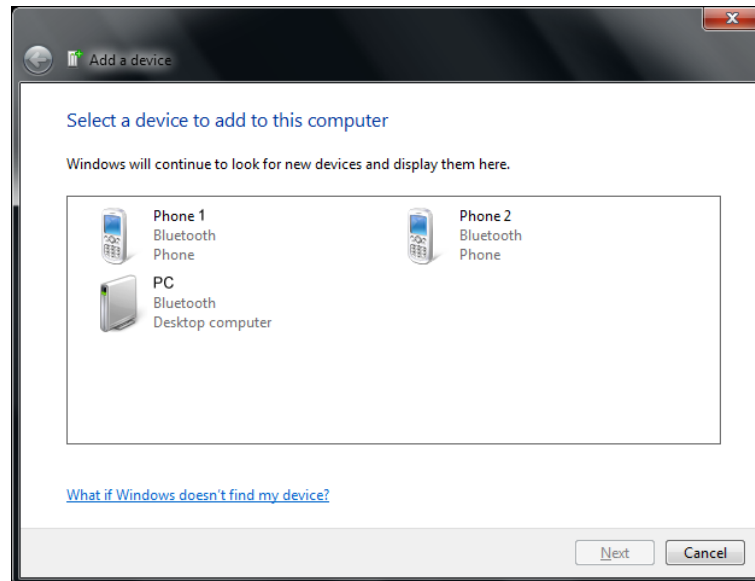

5. Depending on the device you are pairing, you may be prompted to enter or verify the pairing code. The pairing code entered or shown on your Tablet Computer and the Bluetooth device must be the same. Click **Next** to continue.

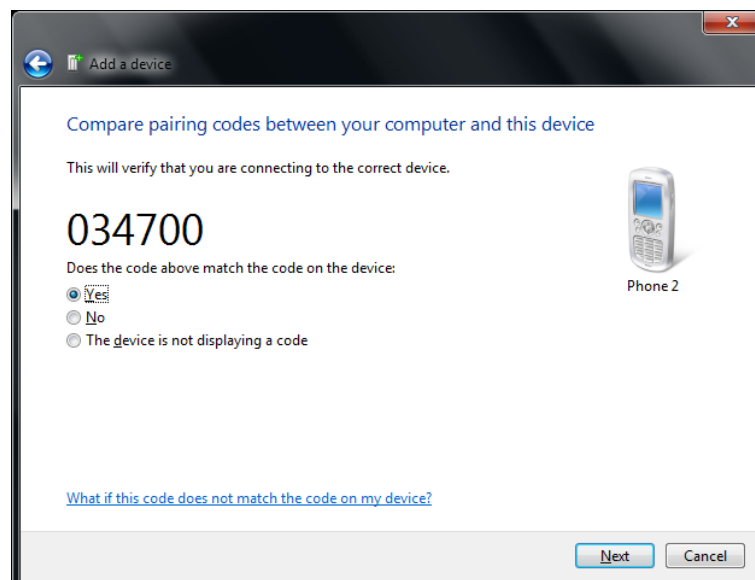

6. Windows will check for the device driver and install, if necessary. Tap **Close** to close the screen.

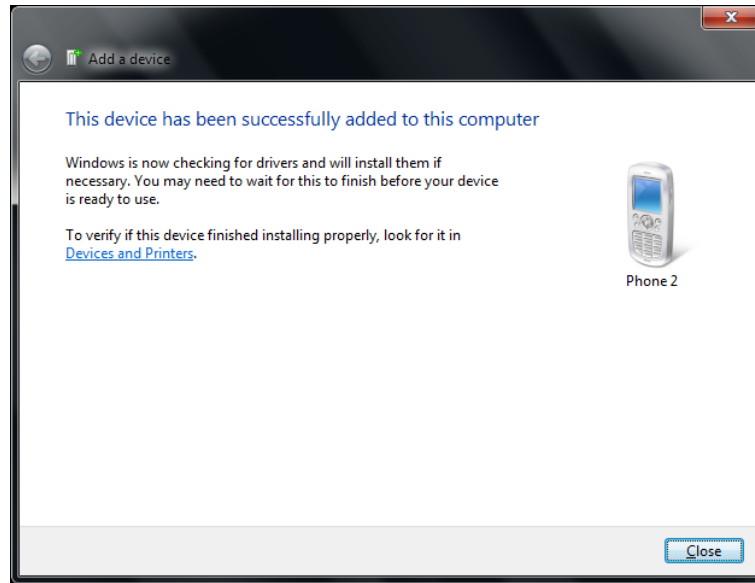

Depending on the paired Bluetooth device, you may use your Tablet Computer speakers to listen to music played from the Bluetooth device, transfer files, and more.

NOTE: For more information on using Bluetooth features, see Windows online help.

To reconnect to a Bluetooth device

Once a Bluetooth device has been paired with your Tablet Computer, you do not need to enter or verify the pairing code as you did the first time.

To reconnect to a Bluetooth device, perform the following:

1. Make sure the Bluetooth adapter is on as indicated by the Bluetooth icon (📶) on the taskbar.
2. Tap the Bluetooth icon (📶) to display a pop up menu.

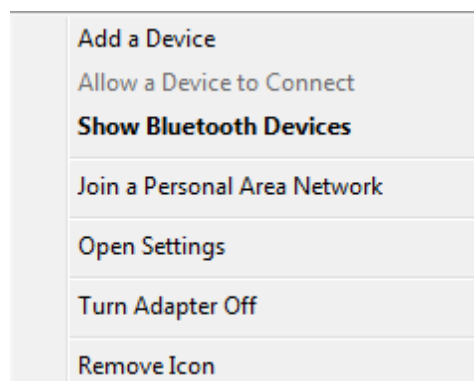

3. Tap **Show Bluetooth Devices**.

4. Tap and hold the Bluetooth device to display the pop up menu.
5. Tap **Advanced Operation**, then tap the applicable connection operation.

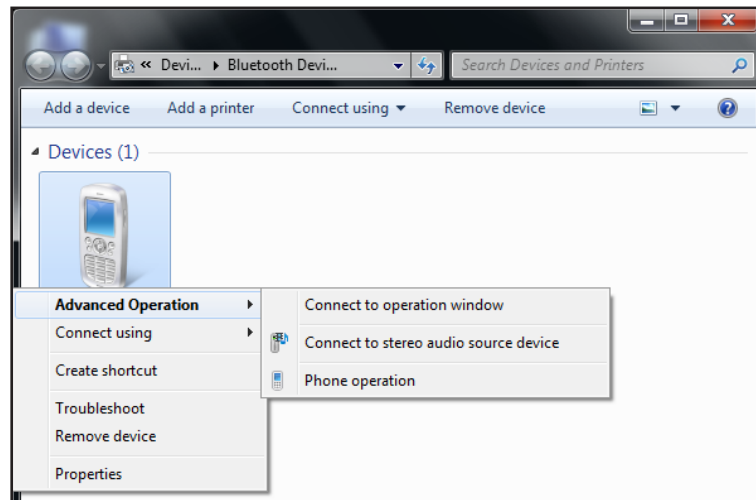

When a Bluetooth device wants to pair with your Tablet Computer, a pop up message appears on the taskbar, tap the message to pair with the device.

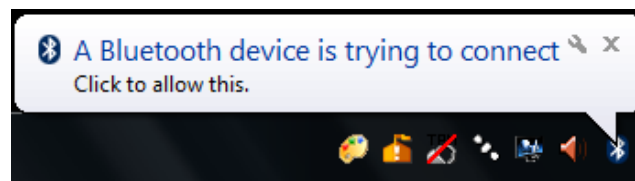

Configuring Bluetooth Settings

The Bluetooth Settings allows you to configure how you want to connect to Bluetooth devices, sync data, and other options. To access the settings, tap and hold the Bluetooth icon () on the taskbar, and tap **Open Settings**.

Regulatory Information

This appendix provides regulatory statements and safety notices about your Tablet Computer.

NOTE: Marking labels located on the exterior of your Tablet Computer indicate the regulations that your model complies with. Check the marking labels and refer to the corresponding statements in this appendix. Some notices apply to specific models only.

FCC Regulations

This device complies with part 15 of the FCC Rules. Operation is subject to the following two conditions: (1) This device may not cause harmful interference, and (2) this device must accept any interference received, including interference that may cause undesired operation.

This device has been tested and found to comply with the limits for a Class B digital device, pursuant to Part 15 of the FCC Rules. These limits are designed to provide reasonable protection against harmful interference in a residential installation. This equipment generates, uses and can radiated radio frequency energy and, if not installed and used in accordance with the instructions, may cause harmful interference to radio communications. However, there is no guarantee that interference will not occur in a particular installation. If this equipment does cause harmful interference to radio or television reception, which can be determined by turning the equipment off and on, the user is encouraged to try to correct the interference by one or more of the following measures:

- Reorient or relocate the receiving antenna.
- Increase the separation between the equipment and receiver.
- Connect the equipment into an outlet on a circuit different from that to which the receiver is connected.
- Consult the dealer or an experienced radio/TV technician for help.

Changes or modifications not expressly approved by the party responsible for compliance could void the user's authority to operate the equipment.

Operation on the 5.15-5.25GHz frequency band is restricted to indoor use only. The FCC requires indoor use for the 5.15-5.25GHz band to reduce the potential for harmful interference to co-channel Mobile Satellite Systems. Therefore, it will only transmit on the 5.25-5.35 GHz, 5.47-5.725 GHz and 5.725 –5.850 GHz band when associated with an access point (AP).

RF Exposure Information (SAR)

This device is compliance with SAR for general population /uncontrolled exposure limits in ANSI/IEEE C95.1-1999 and had been tested in accordance with the measurement methods and procedures specified in OET Bulletin 65 Supplement C.

This equipment complies with FCC RF radiation exposure limits set forth for an uncontrolled environment. This device was tested for operations with the device contacted directly to the human body to the back side of the EUT. To maintain compliance with FCC RF exposure compliance requirements, avoid direct contact to the transmitted antenna during transmitting.

IC Regulations

This device complies with Industry Canada license-exempt RSS standard(s). Operation is subject to the following two conditions:

- (1) this device may not cause interference, and
- (2) this device must accept any interference, including interference that may cause undesired operation of the device.

Le présent appareil est conforme aux CNR d'Industrie Canada applicables aux appareils radio exempts de licence. L'exploitation est autorisée aux deux conditions suivantes:

- (1) l'appareil ne doit pas produire de brouillage, et
- (2) l'utilisateur de l'appareil doit accepter tout brouillage radioélectrique subi, même si le brouillage est susceptible d'en compromettre le fonctionnement."

This Class B digital apparatus complies with Canadian ICES-003

Cet appareil numérique de la classe B est conforme à la norme NMB-003 du Canada.

The device could automatically discontinue transmission in case of absence of information to transmit, or operational failure. Note that this is not intended to prohibit transmission of control or signaling information or the use of repetitive codes where required by the technology.

The device for the band 5150-5250 MHz is only for indoor usage to reduce potential for harmful interference to co-channel mobile satellite systems; the maximum antenna gain permitted (for devices in the bands 5250-5350 MHz and 5470-5725 MHz) to comply with the e.i.r.p. limit; and The maximum antenna gain permitted (for devices in the band 5725-5850 MHz) to comply with the e.i.r.p. limits specified for point-to-point and non point-to-point operation as appropriate, as stated in section A9.2(3). In addition, High-power radars are allocated as primary users (meaning they have priority) of the band 5250-5350 MHz and this radar could cause interference and/or damage to LE-LAN devices.

À

Le dispositif pour la bande 5150-5250 MHz est réservé à un usage intérieur pour réduire l'interférence nuisible potentielle aux co-canal systèmes mobiles par satellite, le gain d'antenne maximal autorisé (pour les dispositifs fonctionnant dans les bandes 5250-5350 MHz et 5470-5725 MHz) à se conformer à la pire limite, et Le gain d'antenne maximal autorisé (pour les dispositifs fonctionnant dans la bande 5725-5850 MHz) pour se conformer à la pire limites spécifiées pour le point-à-point et non as appropriate opération de point-à-point, comme indiqué à la section A9.2 (3). En outre, les radars à haute puissance sont désignés comme utilisateurs principaux (ils ont la priorité) de la bande 5250-5350 MHz et ce radar peuvent provoquer des interférences et / ou endommager les dispositifs LAN-EL.

The County Code Selection feature is disabled for products marketed in the US/ Canada. For product available in the USA/ Canada markets, only channel 1~11 can be operated. Selection of other channels is not possible.

Important Note

IC Radiation Exposure Statement

This EUT is compliance with SAR for general population/uncontrolled exposure limits in IC RSS-102 and had been tested in accordance with the measurement methods and procedures specified in IEEE 1528.



www.trimble.com

© 2012 Trimble Navigation Limited. All rights reserved.

This product is protected by US and international copyright, trademark and patent law.