

CLMTM

Installation & Operation Manual

Triple+

Detect. Connect. Protect.

Triple+

Detect. Connect. Protect.

CLM™



Leak management and damage prevention

Safe Connected Property



Thank you for choosing the Triple+ CLM™

Cloud-based Leak Management

system designed to detect water leaks and prevent the subsequent damages. Triple+ CLM™ system will give you peace of mind while at home and away.



Triple+ CLM™ line of products is the most comprehensive leak management and damage prevention in the market. The battery operated system includes; wireless water flood detectors, shutoff units and HUB. Signal repeaters can be included if necessary. The HUB is connected to the TriplePlus Cloud, which End-Users and Installers are connected to via user friendly Smartphone APPs.

The **Triple+ CLM™** serves as a Secure Gateway that ensures a long range and secured communication between the connected system components by the utilization of RF communication methods.

Additionally, the HUB is connected to the internet through a local Router (either WiFi or Ethernet cable).



The smartphone application,
to stay in full control
of the property

The primary advantage of the **Triple+ CLM™** lies in the simplicity and completeness of the solution. Having a wireless and battery operated system assures that the installation is handled in minutes without the need to trench cables or involvement of an electrician.

The **Triple+ CLM™** smartphone APP offers a true remote management regardless of being in or away. The Triple+ CLM™ system is fully resilient to any Internet communication failure and will work in its autonomous offline mode, providing a complete protection of the premises against water leak damages.

With the **Triple+ CLM™** You have the peace of mind and you know that your property is safe.

Either in a new or existing property, TriplePlus introduces a new era in the water leak damage prevention. Installations are guaranteed to be handled in minutes. There is no need to trench communication or power cables during the installation of leak management system. The **Triple+ CLM™** fully address the most demanding needs and requirements of the professional installer in the industry and eliminates the boundaries for future system derivatives.



General Info

+ Warning

- This product was designed to prevent water leak damages and as such should be used for water piping only.
- Please read through the instructions carefully and follow the steps of the system's installation.
- Please maintain this document in a safe place for future reference. When in any doubt, contact your authorized distributor or installer.
- The product includes moving parts. Keep your fingers or other objects away from moving parts.

+ Battery replacement

Installation and/or replacement of unit batteries should be performed by a certified professional installer only.

+ System component pairing and positioning

TriplePlus CLM™ system is installed by a certified professional installer and activated using the mobile installer's APP. Please look for **TriplePlus CLM™** Installer APP in Google Play for Android OS-based smartphones or in the App Store for iOS devices.

The professional installer will pair the system components, install them on permanent locations within the premises, verify that they communicate properly between them and the system is ready to be monitored and controlled via your End-User smartphone APP. It can function either in a wired LAN (local area) or wireless network.

+ System components' placement limitations

	HUB/ Repeater	Flood Sensor	Integrated shutoff unit	Actuator
Metal cabinet installation	—	—	—	—
Indoor use	+	+	+	+
Outdoor use	—	—	—	+

Triple+ CLM™ HUB



Triple+ CLM™ HUB performs the functions of a system gateway. It is used to provide access to the Internet or a private computer network. It can function in a wired LAN (local area network), in a wireless-only LAN (WLAN), or in a mixed wired/wireless network, depending on the need. Once paired by the professional installer using the Triple+ CLM™ Installer's APP, the HUB is ready for action.



The HUB allow understanding of devices' state
& Remote control of water shutoff units.

+ HUB description

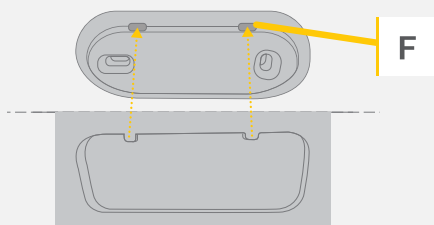
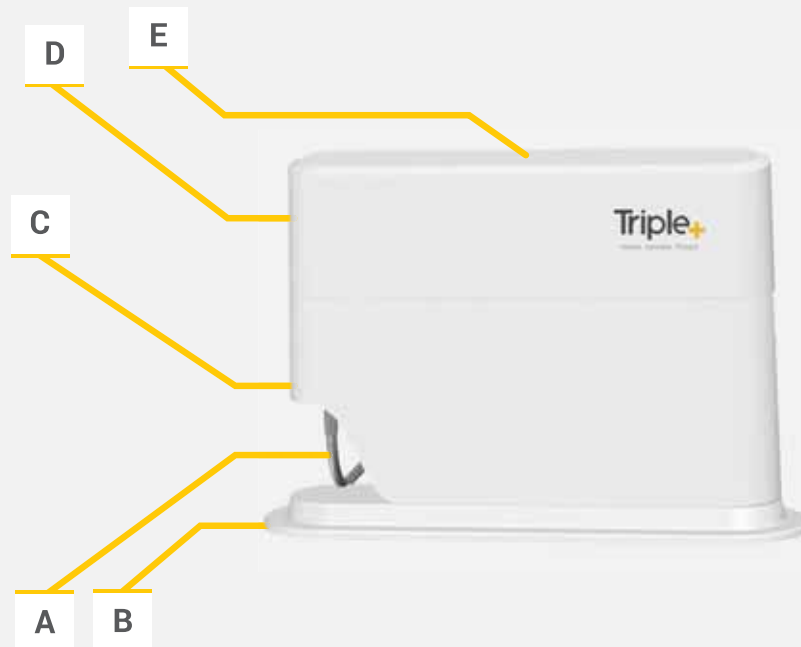

- A** _ Power cable.
- B** _ Table mount bracket.
- C** _ Lower cover.
- D** _ HUB circuit body
- E** _ RGB LED indicator.
- F** _ Wall mounting bracket (on the rear part)

+ HUB installation

When interested in HUB wall mounting, please follow the following instructions:

1. Detach the HUB from the table stand as described below.



2. Attach the wall mounting bracket to intended location and mark the holes for the mounting screws.

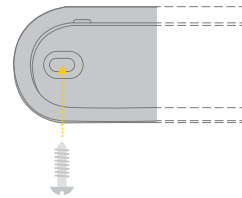

3. Connect the HUB to the AC/DC adaptor jack. Plug the LAN cable into the LAN inlet, if the HUB will be permanently operated via the LAN.

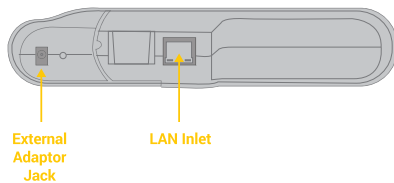

4. Position the HUB on its permanent location. For wall mounting, bring the HUB's rear mounting pins close to the wall and gently slide it down the wall mount's dimples. Please do not attempt to rotate the HUB on the mounting in order to avoid physical damage to the enclosure.

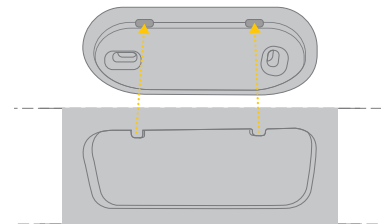

5. For table mounting, connect the table stand to the HUB and place it on the table.

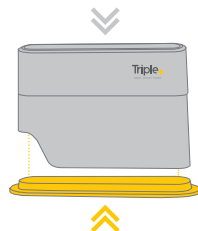

+ Expected HUB LED behavior

- 1. Faultless communication of the HUB with all the components and with the server :**
The HUB RGB LED will repeatedly **blink in GREEN** every 5 seconds.
- 2. Failure in communication with the server or with any of the system components:**
The HUB RGB LED will repeatedly **blink in BLUE** every 5 seconds.
- 3. Battery status of at least one the shutoff units is too low and is not allowing to close it (them) in case of leak event (installation/reset):**
The HUB RGB LED will repeatedly **blink in RED** every 5 seconds.
- 4. Reset to factory settings:**
The HUB RGB LED will be **GREEN steady** for 10 seconds after the unit reset.



Flood Detector Setup



The **Triple+ CLM™** flood detectors are to be installed in places prone to water floods or leaks. When a puddle of water is detected, wireless signal is dispatched to initiate closure of the shutoff unit(s) and push notifications is sent to the End User's APP.



Detect the water flood

+ Flood Detector description

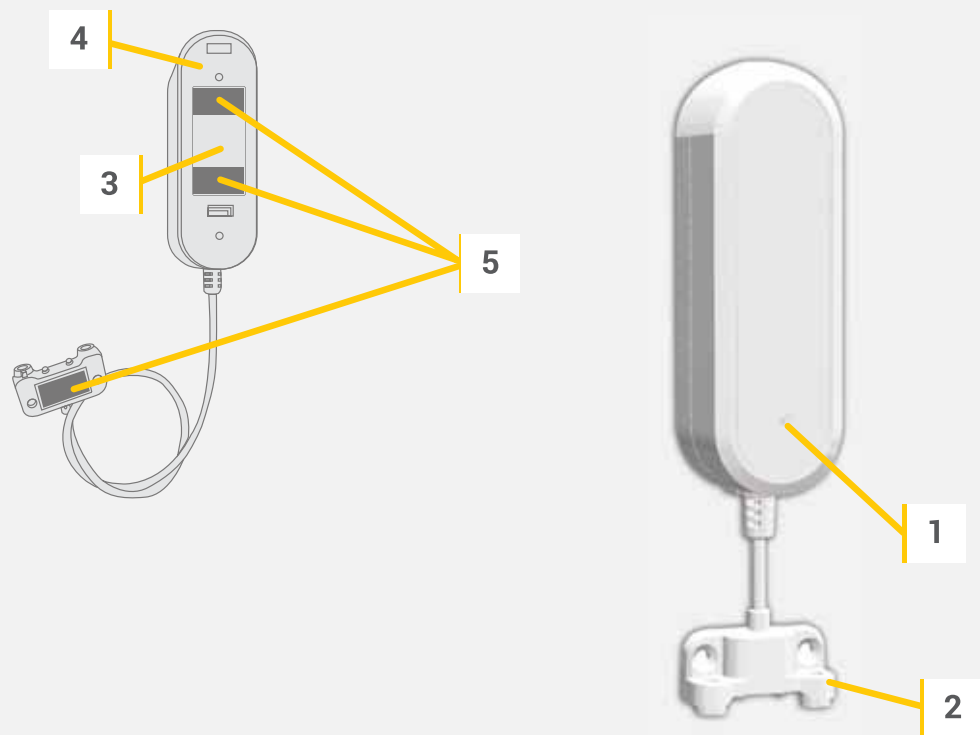

- 1_Indication LED
- 2_Water detector
- 3_Battery housing cover
- 4_Wall mount bracket
- 5_Double-sided adhesive tape application locations (rear)

+ Flood Detector installation

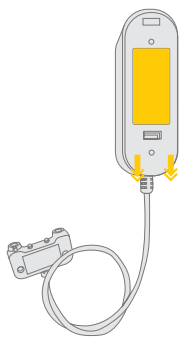

1. Open the battery housing cover by pulling it towards the cable, while holding the detector body.



2. Remove the cover and expose the battery housing.



3. Install 2 AAA batteries in the battery housing, please note the polarity marking.

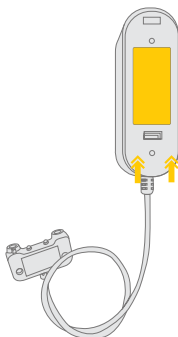

4. Close the battery housing cover.

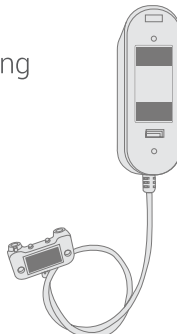

5. Apply the attached double-sided adhesive tape strips to the battery housing cover in the placed defined on the picture.

6. Choose the position and height from the floor level most suitable for installation, so during flooding detector's only electrodes would get wet. Fix both parts of the detector to the wall using the double sided adhesive tape. The bottom part might be fixed using 2 screws (not attached). Ensure that the box will not be exposed to water. The flood detector contains an electronic circuit and is not within a watertight casing (the two electrodes are the only part that should come in contact with water).

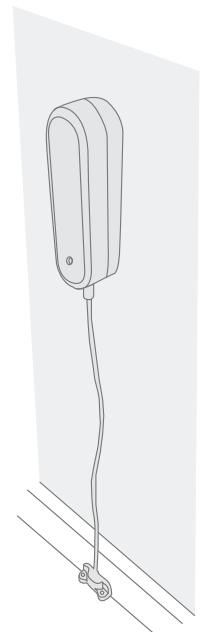

+ Expected Flood Detector LED behavior

1. **GREEN blink** once in 30 seconds – **all is OK**
2. **RED blink** once in 30 seconds – **communication problems**
3. **RED blink** once in 10 seconds – **ongoing water leak**
4. **BLUE blink** once in 30 seconds – **low flood detector battery**

+ Flood Detector installation limitations

Places where the detector should not be installed or positioned at:

- Within a metal cabinet or anywhere that might influence wireless communications.
- Where the temperature exceeds the range between -20C and +50C degrees (-4F and 122F).
- Where there is an apprehension of being hit or damaged.
- In an external place where exposed to rain and direct sunlight and/or to the elements.
- In such a case, the unit should be installed in a water tight plastic casing.
- Where there is humidity

Integrated Shutoff Setup

The Integrated $\frac{3}{4}$ "-pipe diameter compatible Shutoff unit is installed on the main water supply pipe within the premises (or outdoors, in a water tight plastic casing) and controls the water flow within the pipeline. When needed, using standard plumbing adapters, the unit can interface various pipe diameters.

1. The system should not disconnect a fire extinguishing line or a fire sprinkler line.
2. Ensure easy access to the battery housing (opened with a screwdriver) ensure a minimal access space of 30Cm/1Ft.
3. Ensure easy access to the manual override handle.



Controls the water flow

+ Integrated Shutoff unit description



- 1_Closing/ opening handle.
- 2_Close/ open dial.
- 3_Disconnection unit (valve) body.
- 4_Battery cover
- 5_Entry/ exit 3/4" adapter.
- 6_Base for non-wall mounted valve
- 7_Base for wall mounted valve.

+ Integrated Shutoff unit installation

1. Installation and/or replacement of a battery should be performed by authorized personnel.
2. The system should not disconnect a fire extinguishing line or a fire sprinkler line.
3. Locate the most suitable place for installation on the water line (as indicated above.)
4. Shut down the water supply, using the main valve of the building or site.
5. Dismantle the water line connectors in a way that would leave a gap suitable for installing the 3/4" valve.
6. Install the unit on the water line.
7. Should it be required to have a flexible water pipe for mounting the disconnection unit on the wall, dismantle the base unit by removing 4 screws to replace it with the appropriate base unit.
8. Mark the holes' position on the wall, drill and attach 4 studs and screws.
9. Manual opening and closing of the valve handle should be possible after installation.
10. Enable passage of water in the main line and prevent leaks or drippings.
11. Ensure easy access to the battery housing (opened with a screwdriver) - ensure a minimal access space of 30cm\1ft.
12. If unit wetting is probable, install an external protective casing.

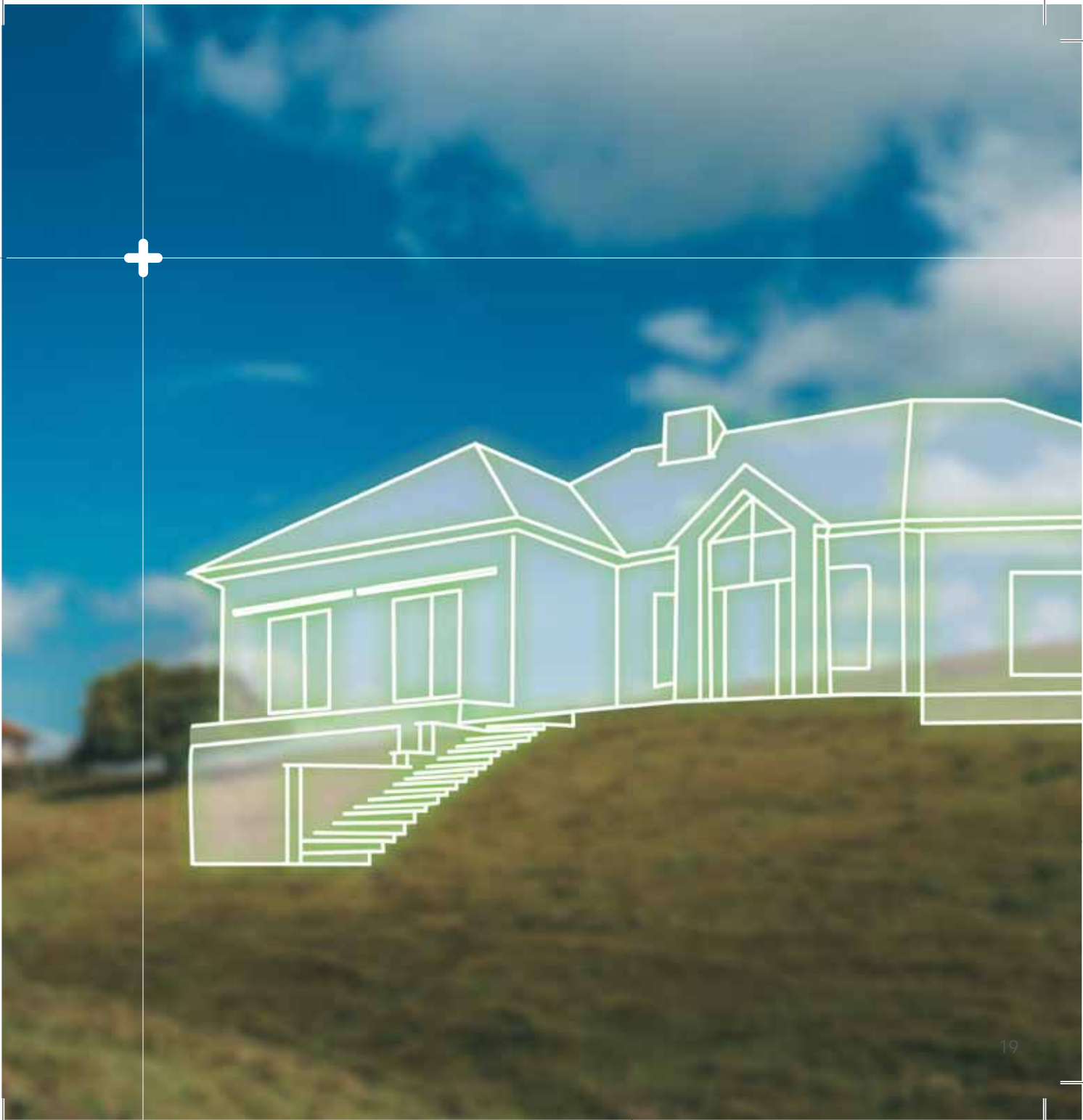

Triple+ CLM™ Actuator Shutoff Unit

The wireless, battery operated water and gas Shutoff unit is installed on any ISO5211 valve. It will actuate whenever a risky event is identified or when manually requested by the user. This actuator is mounted on a ISO5211 flange using 2 screws, provided with the installation kit. It is IP68-rated, meaning that its enclosure is both dust and water tight and can also be submerged into water.

The unit fits 1/2", 3/4", 1" and 1 1/4" pipe diameters.



+ Actuator Shutoff unit description

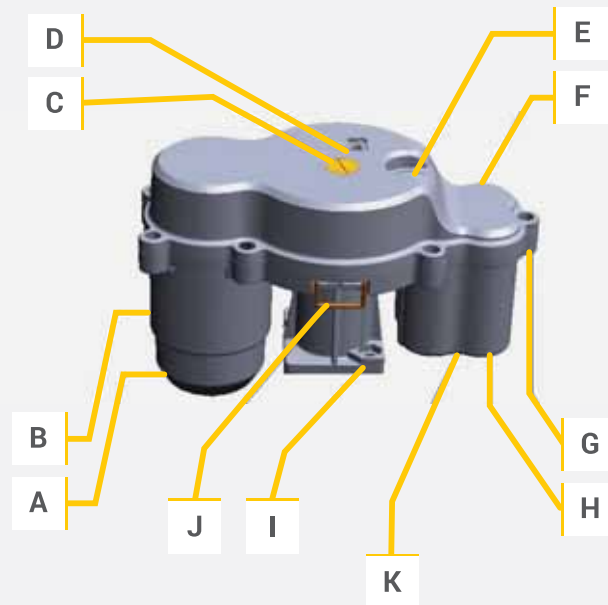

A_Shutoff unit motor
B_Bottom part of the case
C_Motor stem position windows
D_Indication RGB LED
E_Multipurpose button

F_Top part of the case
G_Screw tunnel
H_Battery housing
I_Mounting fitting
J_Lock
K_Battery housing cover*

*Just in the version 2 of the Shutoff unit 21

+ Actuator Shutoff unit Warnings

1. The system should not disconnect a fire extinguishing line or a fire sprinkler line.
2. Ensure easy access shut off unit in case it might be required for service.
3. The unit can be installed perpendicularly or in parallel with the pipe.
4. With the utilization of the locking pin, a comfortable shutoff disconnection should be possible after installation.
5. Do not position shutoff units within metal cabinets.
6. The wireless, battery operated water Shutoff unit is installed on ISO5211 valve. It will actuate whenever a risky event is identified or when manually requested by the user. This actuator is mounted on a ISO5211 flange using 2 screws, provided with the installation kit. It is IP68-rated, meaning that its enclosure is both dust and water tight and can also be submerged into water.

+ Actuator Shutoff unit batteries insertion/replacement

v 1.5

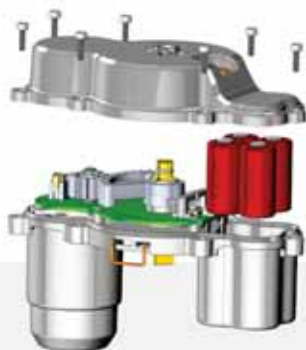

For **version 1.5**, slide out the locking pin about ½" from the enclosure to allow the separation of shut off unit enclosure parts. Remove the screws attaching the bottom and the top shutoff enclosure parts (use 3/32" or 2.5mm Allen wrench) and install 4 x CR123 batteries into the compartment. Assemble the enclosure and fasten the screws.

For **version 2**, use a Philips screwdriver to remove the battery housing cover and replace the batteries.

v 2

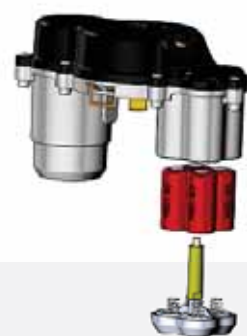

+ Shutoff unit setup and mounting

1. Locate the most suitable place for installation on the water line.
2. Shut down the water supply, using the main valve of the building or site.
3. Mount the neck assembly on the shutoff and install it on ISO5211 mounting pad using the attached screws, washers and nuts. Please note, that the long neck is necessary while mounting the shutoff in parallel with the water pipe and the short neck is required when the shutoff is mounted perpendicularly to the water pipe.
4. Once the shutoff unit is installed, push the lock wire inwards until it reaches a mechanical limit.

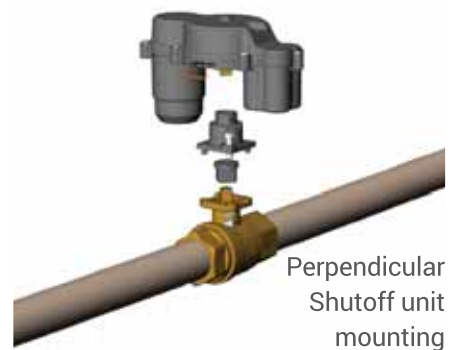

+ Actuator Shutoff unit alignment reset

The shutoff unit alignment reset is necessary in order to indicate the CLM™ HUB that the unit is in the “CLOSED” position and thus prevents the water from passing through the pipe.

1. Regardless of the shutoff mounting, whether parallel or perpendicular to the water flow direction, align the slot on the top part of the shutoff motor stem perpendicularly to the water flow direction. If the stem slot is parallel to the water flow direction after the shutoff mounting, the shutoff has to be toggled manually by pressing the unit button for 2 seconds.

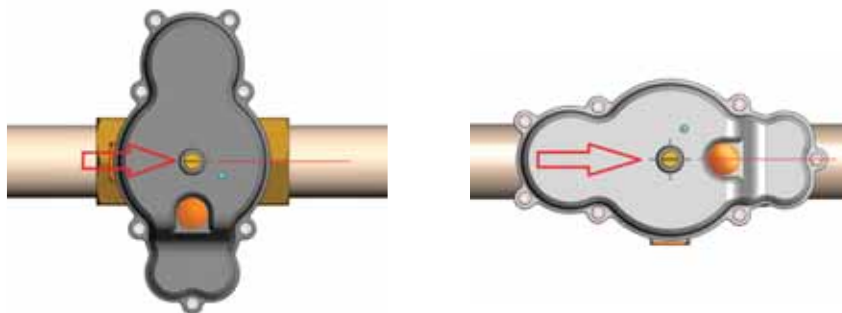

3. Reset the shutoff unit alignment by pressing on the shutoff unit button for at least 20 seconds. The RGB LED on the top part of the shutoff enclosure should turn ON and remain GREEN so for 10 seconds after the successful alignment reset.
4. Once the alignment is reset, toggle the shutoff unit to the “OPENED” position manually by pressing on the button.
5. Enable passage of water in the main line and prevent leaks or drippings.

+ Expected Actuator Shutoff unit LED behavior

In order to save the shutoff unit battery, the LED indicator is not active, unless the unit button is momentarily pressed. The activity time frame of the LED indicator is 30 seconds.

- 1. Faultless communication of the HUB with all the components and with the server:**
The SHUTOFF UNIT LED will repeatedly **blink in GREEN** every 5 seconds (see attached time diagram).
- 2. Problematic communication with the server or with any of the system components:**
The SHUTOFF UNIT LED will repeatedly **blink in BLUE** every 5 seconds.
- 3. Battery status of the shutoff unit is too low and is not allowing to close it in case of leak event:**
The SHUTOFF UNIT LED will repeatedly **blink in RED** every 5 seconds.
- 4. Alignment reset:**
The SHUTOFF UNIT LED will turn ON and remain **GREEN** for 10 seconds after the successful alignment reset.



Statement



This device complies with FCC Rules Part 15 and with Industry Canada license-exempt RSS standard(s). Operation is subject to two conditions: (1) This device may not cause harmful interference, and (2) this device must accept any interference that may be received or that may cause undesired operation.

This equipment has been tested and found to comply with the limits for a Class B digital device, pursuant to part 15 of the FCC Rules. These limits are designed to provide reasonable protection against harmful interference in a residential installation.

This equipment generates, uses and can radiate radio frequency energy and, if not installed and used in accordance with the instructions, may cause harmful interference to radio communications. However, there is no guarantee that interference will not occur in a particular installation. If this equipment does cause harmful interference to radio or television reception, which can be determined by turning the equipment off and on, the user is encouraged to try to correct the interference by one or more of the following measures:

- Reorient or relocate the receiving antenna.
- Increase the separation between the equipment and receiver.
- Connect the equipment into an outlet on a circuit different from that to which the receiver is connected.
- Consult the dealer or an experienced radio/TV technician for help.

Changes or modifications to this equipment not expressly approved by the party responsible for compliance (TriplePlus Ltd.) could void the user's authority to operate the equipment.

Murata WLAN Smart module LBWB1ZZYDZ-740 FCC/IC CAUTION:

- Changes or modifications not expressly approved by the party responsible for compliance could void the user's authority to operate the equipment.
- This transmitter must not be co-located or operated in conjunction with any other antenna or transmitter.
- When installing it in a mobile equipment This equipment complies with FCC/IC radiation exposure limits set forth for an uncontrolled environment and meets the FCC radio frequency (RF) Exposure Guidelines and RSS-102 of the IC radio frequency (RF) Exposure rules. This equipment should be installed and operated keeping the radiator at least 20cm or more away from person's body.

Statement



Le présent appareil est conforme aux CNR d'Industrie Canada applicables aux appareils radio exempts de licence. L'exploitation est autorisée aux deux conditions suivantes : (1) l'appareil ne doit pas produire de brouillage, et (2) l'utilisateur de l'appareil doit accepter tout brouillage radioélectrique subi, même si le brouillage est susceptible d'en compromettre le fonctionnement.

Cet équipement a été testé et jugé conforme aux limites s'appliquant à un appareil numérique de classe B, conformément à la Partie 15 des réglementations de la FCC. Ces limites ont été élaborées pour offrir une protection raisonnable contre les interférences nuisibles dans une installation résidentielle.

Cet équipement génère, utilise et peut émettre de l'énergie de fréquence radio et, s'il n'est pas installé et utilisé conformément aux instructions du fabricant, peut provoquer des interférences dangereuses pour les communications radio. Toutefois, rien ne garantit l'absence d'interférences dans une installation particulière. Si cet équipement provoque des interférences nuisibles au niveau de la réception radio ou télévision, ce qui peut être déterminé par la mise hors, puis sous tension de l'équipement, vous êtes invité à essayer de corriger les interférences en prenant les mesures suivantes:

- Réorientez ou déplacez l'antenne réceptrice.
- Augmentez la distance qui sépare l'équipement et le récepteur.
- Branchez l'équipement à une prise d'un circuit différent de celui auquel est branché le récepteur.
- Consultez le revendeur ou un technicien radio/télévision expérimenté pour obtenir de l'aide.

Murata WLAN Smart module LBWB1ZZYDZ-740 FCC/IC ATTENTION:

■ Cet équipement est conforme aux limites d'exposition aux rayonnements énoncées pour un environnement non contrôlé et respecte les règles des radioélectriques (RF) de la FCC lignes directrices d'exposition et d'exposition aux fréquences radioélectriques (RF) CNR-102 de l'IC. Cet équipement doit être installé et utilisé en gardant une distance de 20 cm ou plus entre le dispositif rayonnant et le corps.

Triple+

Detect. Connect. Protect.

Tripleplus Ltd. | 5 Hamada St., High Tech Park, Yoqneam, 2069200, Israel
+972-(0)72-2211370 | info@tripleplus.io | www.tripleplus.io