

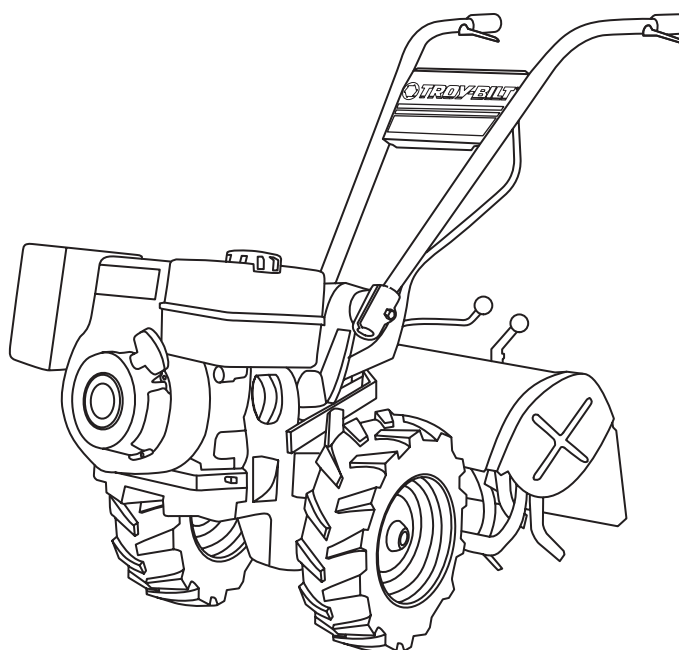

## OPERATOR'S MANUAL



### Rear-Tine Tiller — Horse/Big Red

#### **⚠ WARNING**

**READ AND FOLLOW ALL SAFETY RULES AND INSTRUCTIONS IN THIS MANUAL  
BEFORE ATTEMPTING TO OPERATE THIS MACHINE.  
FAILURE TO COMPLY WITH THESE INSTRUCTIONS MAY RESULT IN PERSONAL INJURY.**

TROY-BILT LLC, P.O. BOX 361131 CLEVELAND, OHIO 44136-0019

## Thank You

Thank you for purchasing a Troy-Bilt Garden Tiller. It was carefully engineered to provide excellent performance when properly operated and maintained.

Please read this entire manual prior to operating the equipment. It instructs you how to safely and easily set up, operate and maintain your machine. Please be sure that you, and any other persons who will operate the machine, carefully follow the recommended safety practices at all times. Failure to do so could result in personal injury or property damage.

All information in this manual is relative to the most recent product information available at the time of printing. Review this manual frequently to familiarize yourself with the machine, its features and operation. Please be aware that this Operator's Manual may cover a range of product specifications for various models. Characteristics and features discussed and/or illustrated in this manual may not be applicable to all models. We reserve the right to change product specifications, designs and equipment without notice and without incurring obligation.

If applicable, the power testing information used to establish the power rating of the engine equipped on this machine can be found at [www.opei.org](http://www.opei.org) or the engine manufacturer's web site.

If you have any problems or questions concerning the machine, phone a authorized Troy-Bilt service dealer or contact us directly. Troy-Bilt's Customer Support telephone numbers, website address and mailing address can be found on this page. We want to ensure your complete satisfaction at all times.

Throughout this manual, all references to *right* and *left* side of the machine are observed from the operating position

The engine manufacturer is responsible for all engine-related issues with regards to performance, power-rating, specifications, warranty and service. Please refer to the engine manufacturer's Owner's/Operator's Manual, packed separately with your machine, for more information.

## Table of Contents

<b>Safe Operation Practices .....</b>	<b>3</b>	<b>Service .....</b>	<b>38</b>
<b>Assembly &amp; Set-Up .....</b>	<b>7</b>	<b>Troubleshooting .....</b>	<b>41</b>
<b>Controls &amp; Features.....</b>	<b>13</b>	<b>Replacement Parts .....</b>	<b>42</b>
<b>Operation.....</b>	<b>14</b>	<b>Warranty .....</b>	<b>Back Cover</b>
<b>Maintenance &amp; Adjustments.....</b>	<b>26</b>		

## Record Product Information

Before setting up and operating your new equipment, please locate the model plate on the equipment and record the information in the provided area to the right. You can locate the model plate by standing at the operator's position and looking down at the rear of the deck. This information will be necessary, should you seek technical support via our web site, Customer Support Department, or with a local authorized service dealer.

### MODEL NUMBER

--	--	--	--	--	--	--	--	--	--	--

### SERIAL NUMBER

--	--	--	--	--	--	--	--	--	--	--

## Customer Support

**Please do NOT return the machine to the retailer or dealer without first contacting the Customer Support Department.**

If you have difficulty assembling this product or have any questions regarding the controls, operation, or maintenance of this machine, you can seek help from the experts. Choose from the options below:

- ◇ Visit us on the web at [www.troybilt.com](http://www.troybilt.com)



See How-to Maintenance and Parts Installation Videos at [www.troybilt.com/tutorials](http://www.troybilt.com/tutorials)

- ◇ Call a Customer Support Representative at (800) 828-5500 or (330) 558-7220
- ◇ Write to Troy-Bilt LLC • P.O. Box 361131 • Cleveland, OH • 44136-0019



**WARNING!** This symbol points out important safety instructions which, if not followed, could endanger the personal safety and/or property of yourself and others. Read and follow all instructions in this manual before attempting to operate this machine. Failure to comply with these instructions may result in personal injury.

When you see this symbol. **HEED ITS WARNING!**

## CALIFORNIA PROPOSITION 65



**WARNING!** Engine Exhaust, some of its constituents, and certain vehicle components contain or emit chemicals known to State of California to cause cancer and birth defects or other reproductive harm.



**WARNING!** Battery posts, terminals, and related accessories contain lead and lead compounds, chemicals known to the State of California to cause cancer and reproductive harm. *Wash hands after handling*



**DANGER!** This machine was built to be operated according to the safe operation practices in this manual. As with any type of power equipment, carelessness or error on the part of the operator can result in serious injury. This machine is capable of amputating fingers, hands, toes and feet. Failure to observe the following safety instructions could result in serious injury or death.

## Training

1. Read, understand, and follow all instructions on the machine and in the manual(s) before attempting to assemble and operate. Keep this manual in a safe place for future and regular reference and for ordering replacement parts.
  2. Be familiar with all controls and their proper operation. Know how to stop the machine and disengage them quickly.
  3. Never allow children under 14 years of age to operate this machine. Children 14 and over should read and understand the instructions and safe operation practices in this manual and on the machine and be trained and supervised by an adult.
  4. Never allow adults to operate this machine without proper instruction.
  5. Keep the area of operation clear of all persons, particularly small children and pets. Stop machine if anyone enters the area.
2. Wear sturdy, rough-soled work shoes and close fitting slacks and shirt. Loose fitting clothes or jewelry can be caught in moving parts. Never operate this machine in bare feet or sandals.
  3. Disengage clutch levers and shift (if provided) into neutral ("N") before starting the engine.
  4. Never leave this machine unattended with the engine running.
  5. Never attempt to make any adjustments while engine is running, except where specifically recommended in the operator's manual.

## Safe Handling of Gasoline:

To avoid personal injury or property damage use extreme care in handling gasoline. Gasoline is extremely flammable and the vapors are explosive. Serious personal injury can occur when gasoline is spilled on yourself or your clothes which can ignite. Wash your skin and change clothes immediately.

- a. Use only an approved gasoline container.
- b. Never fill containers inside a vehicle or on a truck or trailer bed with a plastic liner. Always place containers on the ground away from your vehicle before filling.

## Preparation

1. Thoroughly inspect the area where the equipment is to be used. Remove all stones, sticks, wire, and other foreign objects which could be tripped over and cause personal injury.

- c. When practical, remove gas-powered equipment from the truck or trailer and refuel it on the ground. If this is not possible, then refuel such equipment on a trailer with a portable container, rather than from a gasoline dispenser nozzle.
  - d. Keep the nozzle in contact with the rim of the fuel tank or container opening at all times until fueling is complete. Do not use a nozzle lock-open device.
  - e. Extinguish all cigarettes, cigars, pipes and other sources of ignition.
  - f. Never fuel machine indoors.
  - g. Never remove gas cap or add fuel while the engine is hot or running. Allow engine to cool at least two minutes before refueling.
  - h. Never over fill fuel tank. Fill tank to no more than ½ inch below bottom of filler neck to allow space for fuel expansion.
  - i. Replace gasoline cap and tighten securely.
  - j. If gasoline is spilled, wipe it off the engine and equipment. Move unit to another area. Wait 5 minutes before starting the engine.
  - k. To reduce fire hazards, keep machine free of grass, leaves, or other debris build-up. Clean up oil or fuel spillage and remove any fuel soaked debris.
  - l. Never store the machine or fuel container inside where there is an open flame, spark or pilot light as on a water heater, space heater, furnace, clothes dryer or other gas appliances.
11. After striking a foreign object, stop the engine, disconnect the spark plug wire and ground against the engine. Thoroughly inspect the machine for any damage. Repair the damage before starting and operating.
  12. Disengage all clutch levers (if fitted) and stop engine before you leave the operating position (behind the handles). Wait until the tines come to a complete stop before unclogging the tines, making any adjustments, or inspections.
  13. Never run an engine indoors or in a poorly ventilated area. Engine exhaust contains carbon monoxide, an odorless and deadly gas.
  14. Muffler and engine become hot and can cause a burn. Do not touch.
  15. Use caution when tilling near fences, buildings and underground utilities. Rotating tines can cause property damage or personal injury.
  16. Do not overload machine capacity by attempting to till soil too deep at too fast of a rate.
  17. If the machine should start making an unusual noise or vibration, stop the engine, disconnect the spark plug wire and ground it against the engine. Inspect thoroughly for damage. Repair any damage before starting and operating.
  18. Keep all shields, guards, and safety devices in place and operating properly.
  19. Never pick up or carry machine while the engine is running.
  20. Use only attachments and accessories approved by the manufacturer. Failure to do so can result in personal injury.
  21. If situations occur which are not covered in this manual, use care and good judgement. Contact Customer Support for assistance and the name of you nearest servicing dealer..

## Operation

1. Do not put hands or feet near rotating parts. Contact with the rotating parts can amputate hands and feet.
2. Do not operate machine while under the influence of alcohol or drugs.
3. Never operate this machine without good visibility or light. Always be sure of your footing and keep a firm hold on the handles.
4. Keep bystanders away from the machine while it is in operation. Stop the machine if anyone enters the area.
5. Be careful when tilling in hard ground. The tines may catch in the ground and propel the tiller forward. If this occurs, let go of the handle bars and do not restrain the machine.
6. Exercise extreme caution when operating on or crossing gravel surfaces. Stay alert for hidden hazards or traffic. Do not carry passengers.
7. Never operate the machine at high transport speeds on hard or slippery surfaces.
8. Exercise caution to avoid slipping or falling.
9. Look down and behind and use care when in reverse or pulling machine towards you.
10. Start the engine according to the instructions found in this manual and keep feet well away from the tines at all times.

## Maintenance & Storage

1. Keep machine, attachments and accessories in safe working order.
2. Allow a machine to cool at least five minutes before storing. Never tamper with safety devices. Check their proper operation regularly.
3. Check bolts and screws for proper tightness at frequent intervals to keep the machine in safe working condition. Also, visually inspect machine for any damage.
4. Before cleaning, repairing, or inspecting, stop the engine and make certain the tines and all moving parts have stopped. Disconnect the spark plug wire and ground it against the engine to prevent unintended starting.
5. Do not change the engine governor settings or over-speed the engine. The governor controls the maximum safe operating speed of engine.
6. Maintain or replace safety and instruction labels, as necessary.
7. Follow this manual for safe loading, unloading, transporting, and storage of this machine.
8. Always refer to the operator's manual for important details if the machine is to be stored for an extended period.

9. If the fuel tank has to be drained, do this outdoors.
10. Observe proper disposal laws and regulations for gas, oil, etc. to protect the environment.
11. According to the Consumer Products Safety Commission (CPSC) and the U.S. Environmental Protection Agency (EPA), this product has an *Average Useful Life* of seven (7) years, or 130 hours of operation. At the end of the *Average Useful Life* have the machine inspected annually by an authorized service dealer to ensure that all mechanical and safety systems are working properly and not worn excessively. Failure to do so can result in accidents, injuries or death.

## Notice Regarding Emissions

Engines which are certified to comply with California and federal EPA emission regulations for SORE (Small Off Road Equipment) are certified to operate on regular unleaded gasoline, and may include the following emission control systems: Engine Modification (EM), Oxidizing Catalyst (OC), Secondary Air Injection (SAI) and Three Way Catalyst (TWC) if so equipped.

## Spark Arrestor









**WARNING!** This machine is equipped with an internal combustion engine and should not be used on or near any unimproved forest-covered, brushcovered or grass-covered land unless the engine's exhaust system is equipped with a spark arrestor meeting applicable local or state laws (if any).

If a spark arrestor is used, it should be maintained in effective working order by the operator. In the State of California the above is required by law (Section 4442 of the California Public Resources Code). Other states may have similar laws. Federal laws apply on federal lands.

A spark arrestor for the muffler is available through your nearest engine authorized service dealer or contact the service department, P.O. Box 361131 Cleveland, Ohio 44136-0019.

## Safety Symbols

This page depicts and describes safety symbols that may appear on this product. Read, understand, and follow all instructions on the machine before attempting to assemble and operate.

Symbol	Description
	<b>READ THE OPERATOR'S MANUAL(S)</b> Read, understand, and follow all instructions in the manual(s) before attempting to assemble and operate.
	<b>WARNING— ROTATING TINES</b> Do not put hands or feet near rotating parts. Contact with the rotating parts can amputate hands and feet.
	<b>WARNING— ROTATING TINES</b> Do not put hands or feet near rotating parts. Contact with the rotating parts can amputate hands and feet.
	<b>WARNING—GASOLINE IS FLAMMABLE</b> Allow the engine to cool at least two minutes before refueling.
	<b>WARNING— CARBON MONOXIDE</b> Never run an engine indoors or in a poorly ventilated area. Engine exhaust contains carbon monoxide, an odorless and deadly gas.
	<b>WARNING— HOT SURFACE</b> Engine parts, especially the muffler, become extremely hot during operation. Allow engine and muffler to cool before touching.



**WARNING!** Your Responsibility—Restrict the use of this power machine to persons who read, understand and follow the warnings and instructions in this manual and on the machine.

**SAVE THESE INSTRUCTIONS!**

## Contents of Carton

- One Tiller
- One Hardware Pack
- One Engine Operator's Manual
- One Handlebar Support
- One Wheels/Tines PTO Lever
- One Handlebar Assembly
- One Operator's Manual



**WARNING!** To prevent personal injury or property damage, do not start the engine until all assembly steps are complete and you have read and understand the safety and operating instructions in this manual.

## Recommended Tools for Assembly

- 3/8" open-end wrench (1)
- 7/16" open-end wrench (2)
- 1/2" open-end wrench (2)
- 9/16" open-end wrench (1)
- 3/4" open-end wrench (1)
- Flat blade screwdriver (1)
- Scissors (to trim plastic ties)
- Tire pressure gauge (1)
- 4-1/2" high wood block to prop machine

## Contents of Hardware Pack

- 26 oz. Bottle SAE 30W Oil (1)
- Clutch Pawl Spring (1)
- Belt Adjusting Tool (1)
- Plastic Cable Ties (2)
- Curved Head Screw, 1/4-20 x 2 (1)
- Flanged Lock Nut, 1/4-20 (1)
- Pan Head Screw, #10-32 x 1/2 (1)
- The following parts (electric start models only), packaged separately.
- Nuts, 1/4-20 for battery terminals (2)
- Screws, 1/4-20 x 5/8 for battery terminals (2)
- Keys in ignition switch (2)

## Assembly

### Unpacking Instructions

**NOTE:** Do not severely bend any of the control cables on the tiller.

1. The tiller is heavy. Do not attempt to remove it from the shipping platform until instructed to do so in these assembly steps.
2. Remove all loose parts from the carton. The hardware bag is included in your literature packaging.

3. Check that you have the items listed above (contact your local dealer or the Troy-Bilt Technical Service Department if any items are missing or damaged).

### Handle

**NOTE:** When disassembling the handlebar assembly, keep the left-side clamp and ratchet separated from the right-side clamp and ratchet.

1. Disassemble the handlebar assembly. To do this, remove the height adjustment lever by turning the lever in a counterclockwise direction. See Fig. 3-1.

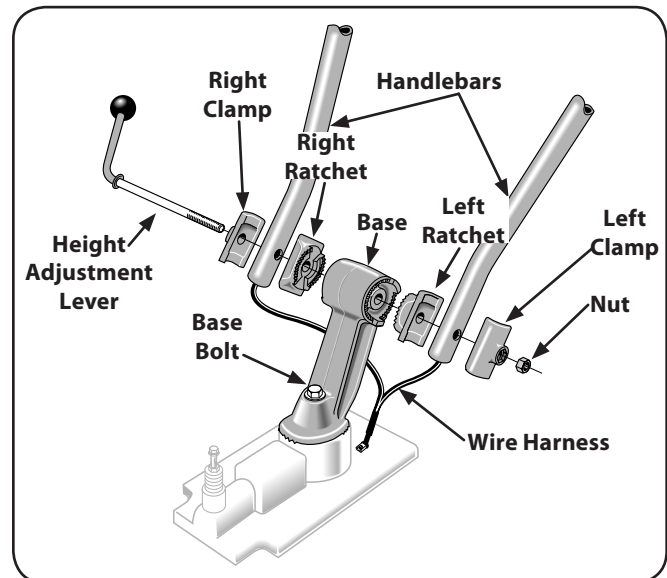

**Figure 3-1**

2. Place the handlebar ends on either side of the base, with the wire harness toward the rear of the base. See Fig. 3-1.
3. Install the height adjustment lever through the right-side clamp, handlebar end, ratchet, and base; then out through the left-side ratchet, handlebar end, and clamp. See Fig. 3-1. Secure with the nut, but do not fully tighten.

**NOTE:** Do not force the height adjustment lever through the handlebars. The interlock wires may be blocking the lever and could be damaged. You may gently move the wires aside if this condition occurs.

4. Raise the handlebars to one of two height settings and tighten the height adjustment lever. Also, make sure all other mounting hardware is securely tightened.

## Moving the Tiller off the Shipping Platform

1. Set the Depth Regulator Lever to the "TRAVEL" position. Do this by lifting the tiller by the handlebars, then pulling straight back on the lever and sliding down to the highest notched setting. See Fig. 3-2.

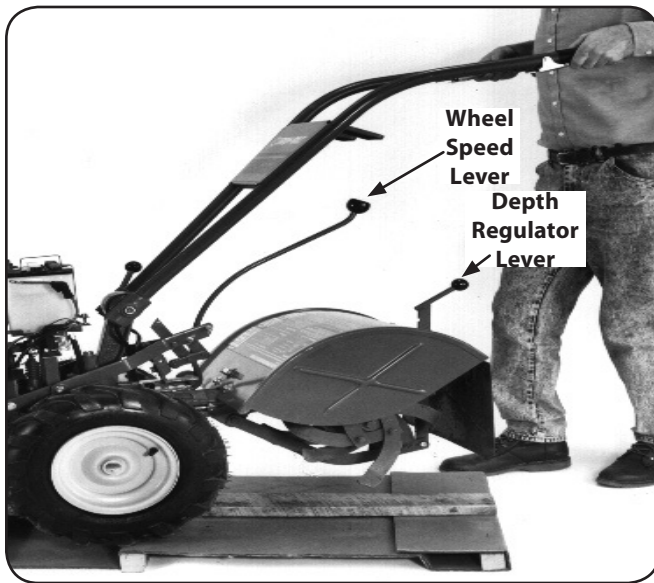

Figure 3-2

2. Set the Wheel Speed Lever to the Freewheel position. To do this, move the lever approximately halfway between the Fast and Slow settings while you rock the tiller forward and backward until the wheels move freely. See Fig. 3-2
3. Lift the Handlebars high enough to clear the tiller tines and pull back firmly to dislodge the tiller from the platform wheel wells.

## Wire Harness

1. Ground the green (and red for electric start tillers) wire(s) to the engine block. See Fig. 3-3.

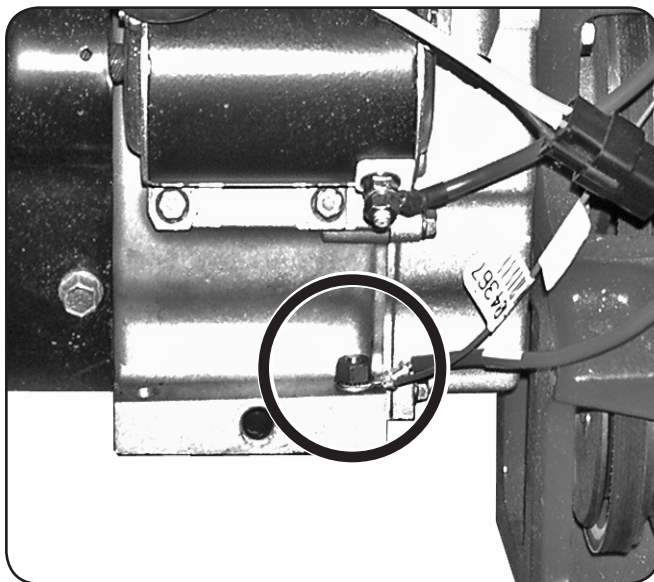

Figure 3-3

2. Connect the safety wire assembly (green and yellow wires). See Fig. 3-4.



Figure 3-4

3. Connect the tiller's main harness connection to the neutral safety switch receptacle. See Fig. 3-5.

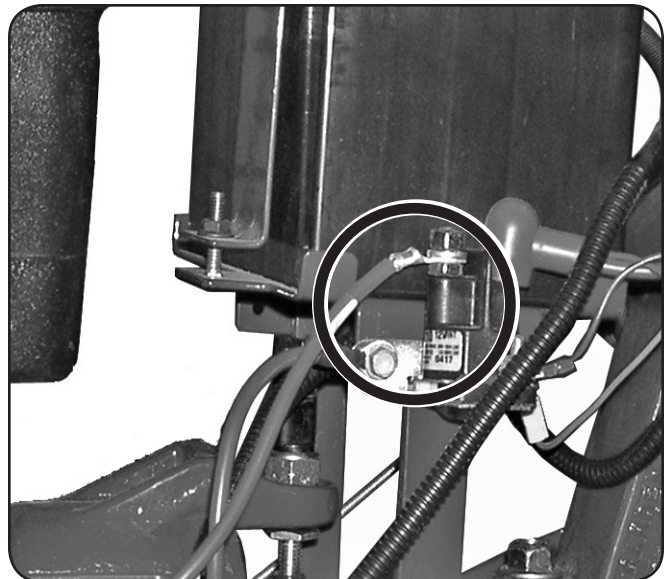

Figure 3-5



## Wheels/Tines PTO Drive Lever

1. Loosen the bolt on the handlebar base and swing the handlebars out to the right side. See Fig. 3-1.
2. Remove both sets of nuts, star washers, screws, and one bushing from the yoke plates. See Fig. 3-6. There is a bushing inside the short link. Be careful not to lose it when removing screw.

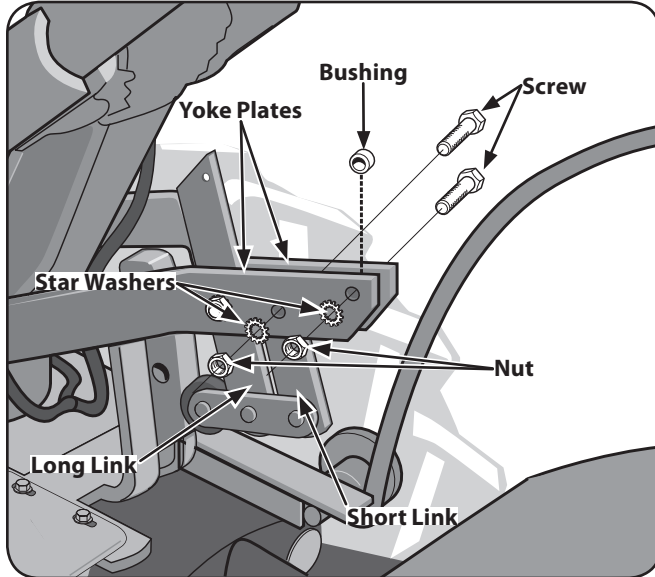

Figure 3-6

3. Slide the plates at the end of the Wheels/Tines/PTO Lever over the yoke plates. See Fig. 3-7. To aid in the next step, insert a screw temporarily into the forward most holes of the yoke plates and the lever.

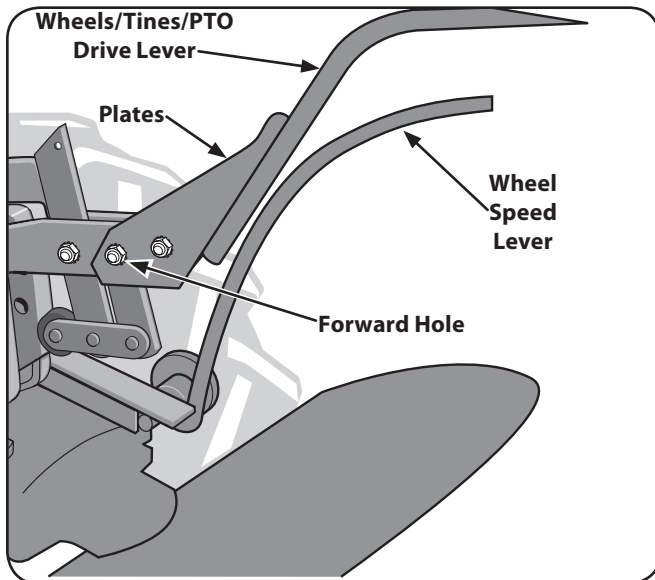

Figure 3-7

4. Align the rear most holes of the yoke plates and the Wheels/Tines PTO Lever. Use long nose pliers to hold the bushing in place while inserting the screw through the lever and yoke plates. See Fig. 3-8. Install the star washer and the nut then hand tighten.

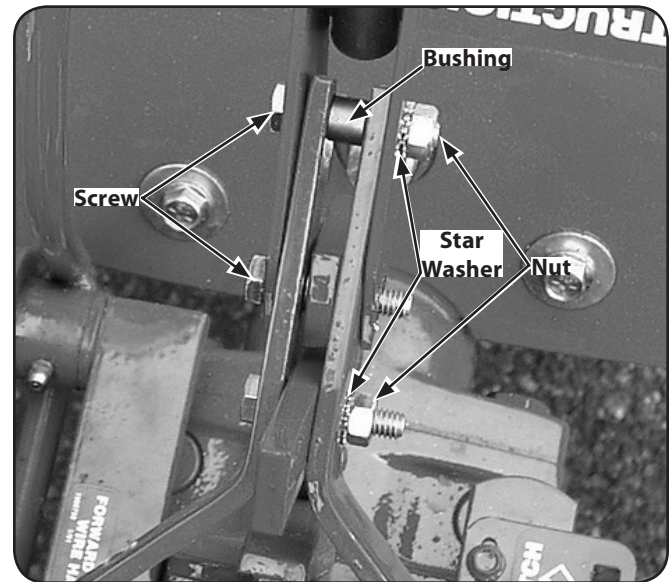

Figure 3-8

5. Retrieve the clutch pawl spring from hardware bag. Remove the temporary screw from the forward holes inserted in Step 3 and move the Wheels/Tines/PTO Lever fully forward. Install the wider hook end of the clutch pawl spring down into the small hole at the end of the handle. Use pliers to insert the other end into the hole in the long link bar. See Fig. 3-9.

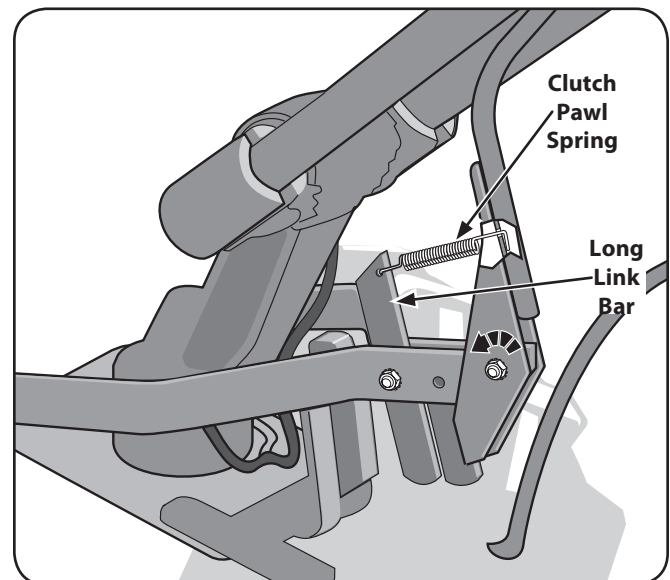

Figure 3-9

**NOTE:** Do not bend or over stretch the spring while installing.

6. Pull the Wheels/Tines/PTO Lever back to align the forward most holes in the yoke plate with the holes in the lever plates. Also align the bushing that is inside the short link bar. Install the screw, star washer, and nut, then tighten securely. Securely tighten all other hardware. Also ensure that the spring is properly seated at both ends. Completed assembly should appear as illustrated in Fig. 3-10.

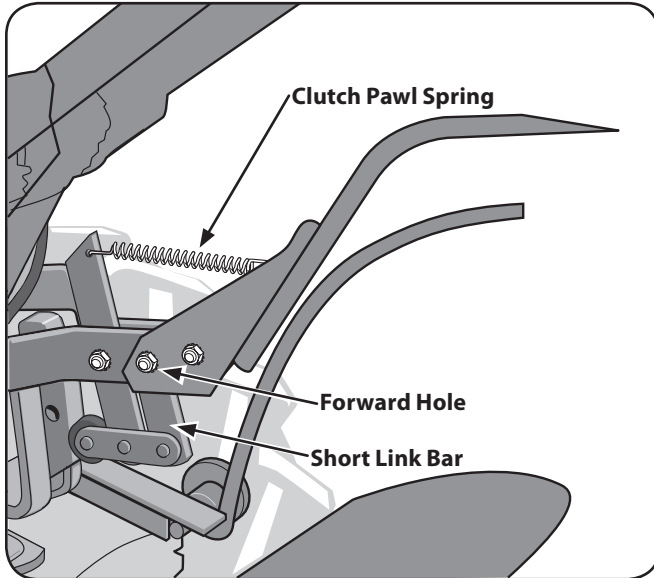

Figure 3-10

7. Test the operation of the Wheels/Tines/PTO Lever. Push the lever down until it engages in the Forward position. The clutch roller must rest beneath the adjustment block. Next, move the lever up to the Neutral position. See Fig. 3-11.

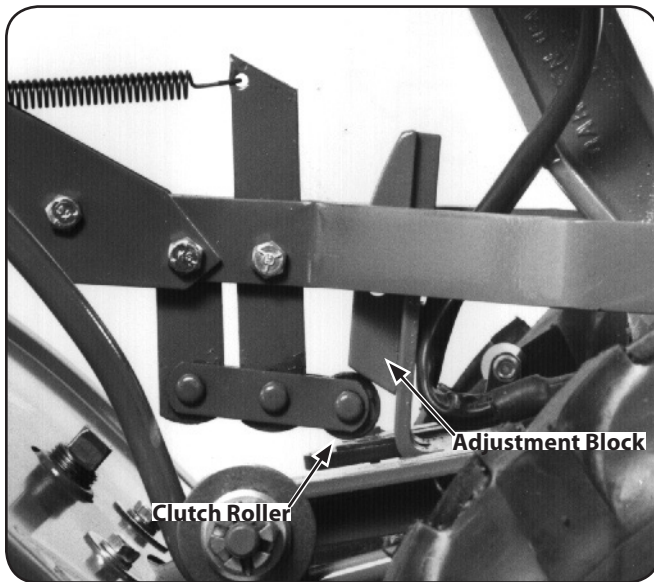

Figure 3-11

8. To test Reverse, lift and hold the lever all the way up in the Reverse position, then let it go. The lever should automatically return to the Neutral position. See Fig. 3-12. If not, do not use the tiller. See your local authorized dealer or call the TROYBILT Technical Service Department for instructions.

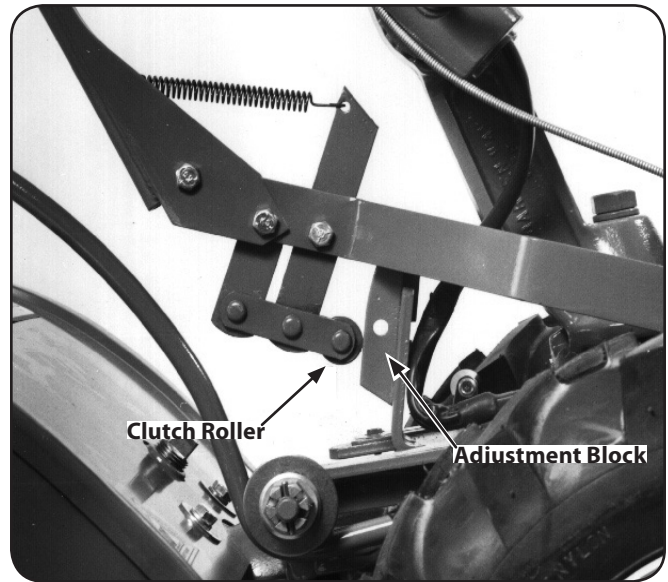

Figure 3-12

## Engine Throttle Lever and Cable

For shipping purposes, the throttle cable, together with the throttle lever, is wound around the engine. Carefully unwind the cable. If the throttle control label is covered with a clear protective coating, peel it off.



**WARNING!** To avoid electric shock from a short circuit (electric start tillers only), never allow the throttle cable to touch the battery. Route the cable below the battery, on the outside of the battery holder.

To attach the throttle lever and cable:

1. Run the throttle cable up the inside edge of the right handlebar and position the lever as shown in Fig. 3-13.

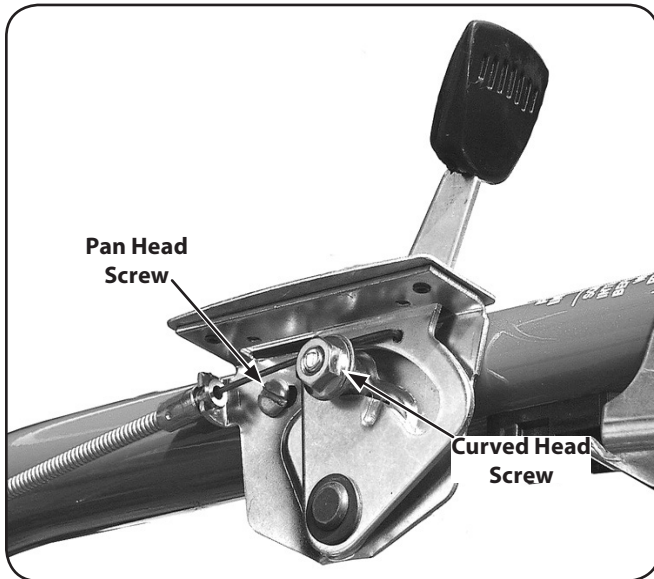

Figure 3-13

2. From the outside of the handlebar, insert the curved head screw, through the handlebar and the center hole in the throttle lever mounting bracket. See Fig. 3-13.
3. Loosely install the flanged lock nut and move the throttle lever back to the STOP position.
4. From the lever side of the bracket, thread a pan head screw through the small hole in the throttle lever bracket and into the handlebar. Tighten the screw securely.
5. Securely tighten both the flanged lock nut and the curved head screw.
6. Use two plastic ties to secure the throttle cable to the right handlebar in two places. Loop each tie around the handlebar and cable (serrated side faces in) and pull the ties tight. Trim the ends.

## Electric Start System (If Equipped)

The following steps explain how to install and charge the battery on electric start tillers. For your safety, follow all steps and observe all accompanying safety messages. The Maintenance & Adjustments section contains other general battery maintenance and recharging instructions.



**WARNING!** Battery produces explosive gases. Keep away sparks, flames, and cigarettes. Ventilate area when charging or using battery in an enclosed space. Make sure battery vent tube is always open after battery is filled with acid.



**WARNING!** Remove metal jewelry before working near the battery or near the electrical system. Failure to comply may cause a short circuit, resulting in electrical burns, a shock, or battery gas explosion.

**NOTE:** If the battery is put into service after the date shown on the top of the battery, charge for a minimum of one hour at 6-10 amps. Refer to the Maintenance & Adjustments section of this manual for more detailed instructions regarding proper battery charging procedure.



**WARNING!** Never jump start the battery with a vehicle battery or charging system. This may produce a battery explosion, causing acid or electrical burns.

1. Before installing the battery and its hold-down clamp, insert the plastic wire harness receptacle into the prongs of the keyswitch located on the hold-down clamp. See Fig. 3-14.

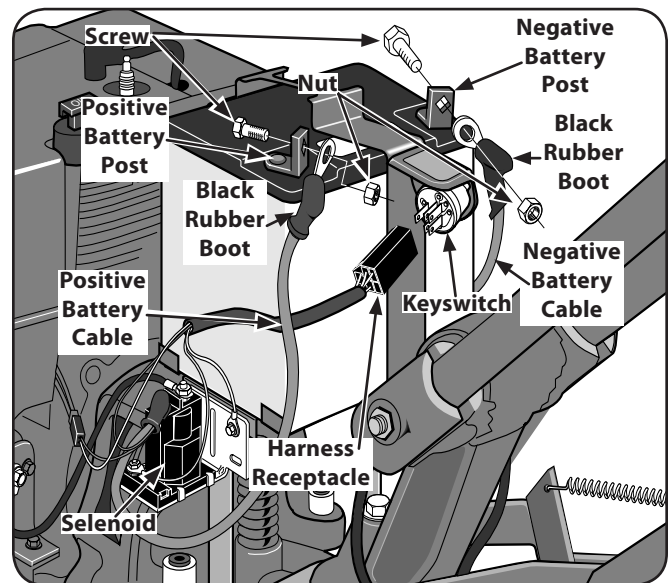

Figure 3-14

2. Remove the ignition keys from the keyswitch and store them safely away. Do not insert the key into the keyswitch until you complete this section and read the Operation section. See Fig. 3-14.

- Use a  $\frac{5}{8}$ " long screw and  $\frac{1}{4}$ -20 hex nut to connect the positive (+) battery cable to the positive (+) battery post. Make sure that this is the cable on the left side, with one end attached to the solenoid. See Fig 3-14.



**WARNING!** To Avoid Personal Injury or Property Damage: Do not touch the positive battery terminal and any surrounding metal objects with tools, jewelry or other metal items. Failure to comply could cause a short circuit leading to electrical burns or an explosion of battery gases. Never bring a gas can near the positive (+) battery terminal. A short circuit could occur leading to an explosion of the gasoline or the battery gases. Always fill the engine fuel tank from the front or side of the engine.

- Slide the black rubber boot completely over the battery post and cable connector. See Fig. 3-14.
- Use a  $\frac{5}{8}$ " long screw and  $\frac{1}{4}$ -20 hex nut to connect the negative (-) battery cable to the negative (-) battery post and secure with screw and nut. See Fig. 3-14.
- Slide the black rubber boot completely over the battery post and cable connector. See Fig. 3-14.

## Set-Up

### Tires

For shipping purposes, the tires may be overinflated. Check the air pressure in each tire and adjust them to between 10 and 20 pounds per square inch. You must inflate each tire to equal air pressures to prevent the tiller from pulling to one side.

### Gas & Oil Fill-Up

Service the engine with gasoline and oil as instructed in the Engine Operator's Manual packed separately with your tiller. Read the instructions carefully.



**WARNING!** Use extreme care when handling gasoline. Gasoline is extremely flammable and the vapors are explosive. Never fuel the machine indoors or while the engine is hot or running. Extinguish cigarettes, cigars, pipes and any other sources of ignition.

### Transmission Gear Oil

The transmission was filled with gear oil at the factory. However, be sure to check the oil level at this time to make certain it is correct. See the Maintenance & Adjustments section for instructions on checking and adding transmission gear oil.

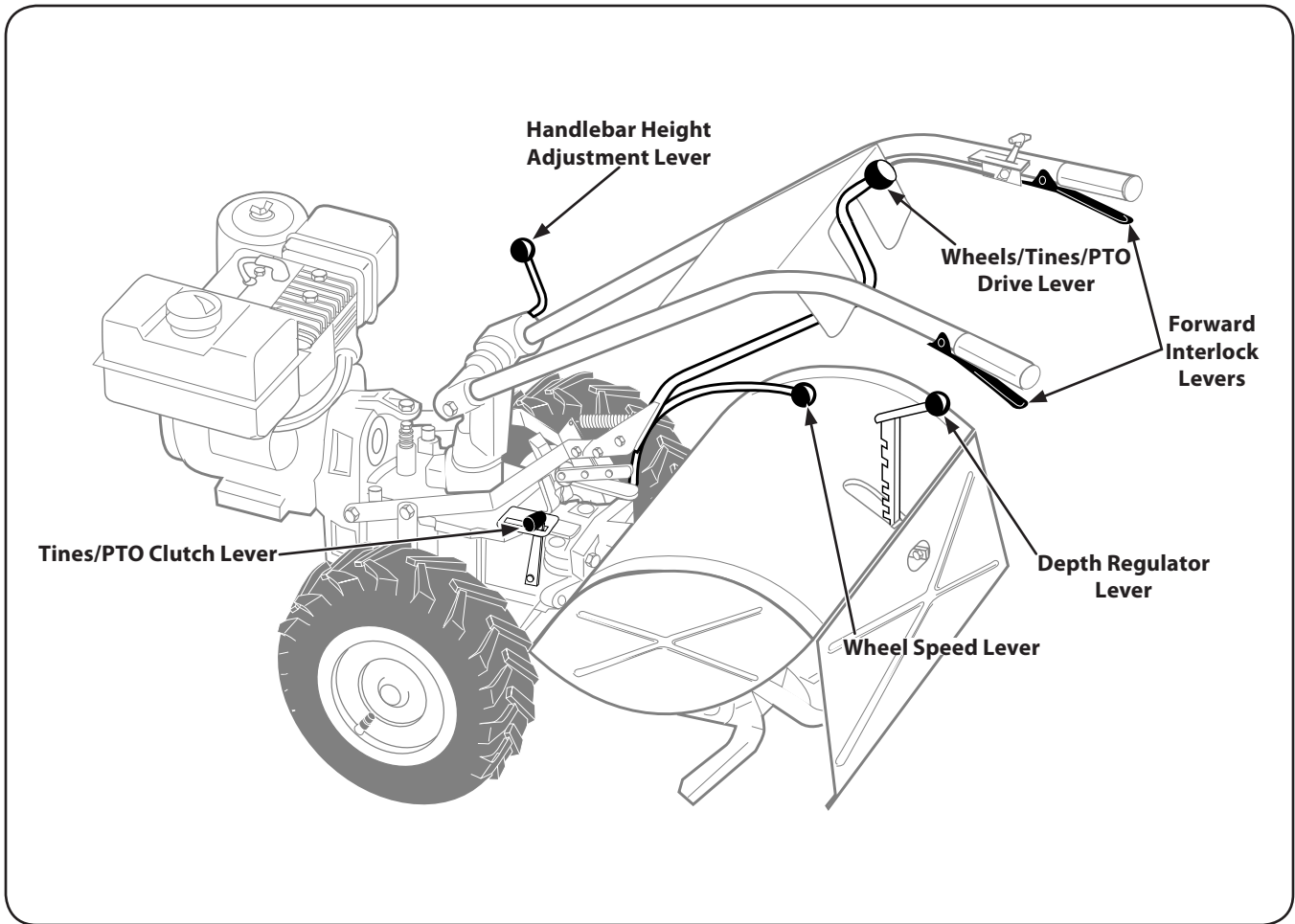

**Figure 4-1**

Tiller controls and features are described below and illustrated in Fig. 4-1.



**WARNING!** Be familiar with all the controls and their proper operation. Know how to stop the machine and disengage it quickly.

**NOTE:** For detailed information on all engine controls refer to the separate Engine Operator's Manual.

### Wheels/Tines/PTO Drive Lever

Use the Wheels/Tines/PTO Drive Lever to engage and disengage power to the transmission.

### Forward Interlock Levers

The Forward Interlock Levers are attached under the handlebar grip and will stop the engine if both levers are released.

### Wheel Speed Lever

The Wheel Speed Lever controls the speed at which the wheels spin.

### Tines/PTO Clutch Lever

The Tines/PTO Clutch Lever is used to engage or disengage power to the transmission.

### Depth Regulator Lever

The Depth Regulator Lever is used to regulate the tilling depth of the tines.

### Handlebar Height Adjustment Lever

The Handlebar Height Adjustment Lever is used to adjust the handlebars to one of two heights.

### Engine Throttle Lever

Use the throttle lever to adjust engine speed as well as to start and stop the engine.

### Keyswitch Starter (If So Equipped)

The keyswitch starter on electric start models is used to start, run and stop the tiller.

## Starting the Engine

The following steps describe how to start and stop the engine.

**NOTE:** Do not attempt to engage the tines, wheels, or any PTO attachment until you have read all of the operating instructions in this section.

### Pre-Start Checklist

Make the following checks and perform the following services before starting the engine.

1. Read the Safe Operation Practices and Features & Controls sections in this Manual. Read the separate Engine Operator's Manual.
2. Check the tiller for loose or missing hardware. Service as required.
3. Check the engine oil level. See Engine Operator's Manual.
4. Shift the Wheels/Tines/PTO Drive lever into NEUTRAL position. See the Controls and Features section for more information on this lever.
5. Check the safety guards. All guards and covers must be securely in place.
6. Check the air cleaner. See the Engine Operator's Manual.
7. Attach the spark plug wire to the spark plug.
8. Check Engine Cooling System. Clear cooling fins and air intake screen of debris. See the Engine Operator's Manual.
9. Select High/Low Belt Speed range.
10. Adjust the Handlebar Height.
11. Fill the fuel tank with gasoline in accordance with the directions in the separate Engine Operator's Manual. Follow all instructions and safety rules carefully.



**WARNING!** Never run the engine indoors or in an enclosed, poorly ventilated area. Engine exhaust contains carbon monoxide, an odorless and deadly gas. Avoid engine muffler and nearby areas. Temperatures in these areas may exceed 150° F.

**NOTE:** After the first two hours of operation, perform the maintenance procedures shown in the Maintenance Schedule in the Maintenance & Adjustments Section of this manual.

### Starting the Engine

1. With the engine off, place the Wheels/Tines/PTO Drive Lever in the NEUTRAL position. If in the FORWARD position, tap the lever sharply upward, it should automatically move into NEUTRAL position.
2. Put the Depth Regulator Lever in the Travel position (lever all the way down) so that the tines are off the ground. To do this, lift up on the handlebars, pull the lever back, and push it down all the way to the top detent (notched) position.
3. Move the Wheel Speed Lever to either the SLOW or FAST position. Be sure to roll the wheels while shifting the lever until the wheels engage.

**NOTE:** If using a PTO stationary attachment, move the Wheel Speed Lever into FREEWHEEL and block the wheels to prevent the equipment from moving. See Fig. 4-1.

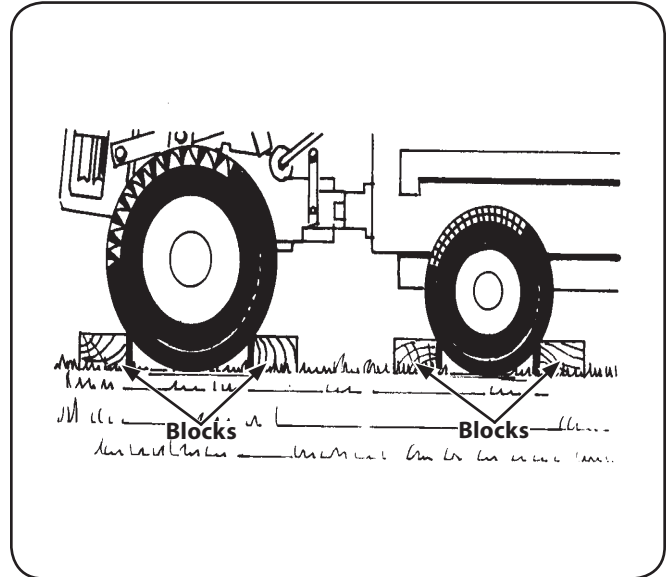

**Figure 4-1**

4. Move the Tines/PTO Clutch Lever into DISENGAGE position.
 

**NOTE:** Use the ENGAGE position if you want the tines to revolve or to apply power to a PTO-driven stationary attachment.
5. If the engine is equipped with a fuel valve, turn the valve to the OPEN position as instructed in the separate Engine Operator's Manual.
6. If the engine is equipped with an ON/OFF switch, move the switch to ON. Move engine throttle lever away from STOP. Choke or prime the engine as instructed in the separate Engine Operator's Manual.
7. If not equipped with an electric start system, place one hand on the fuel tank to stabilize the tiller when you pull the recoil starter rope.
8. If equipped with an electric start system, turn the key to START position to crank the engine then release when the engine starts. If the engine does not start right away, do not hold the key at START for more than a few seconds. Release then try again after a short pause. Damage to the starter motor can occur if it is cranked more than 15 seconds per minute.
9. If the engine does not start after a number of tries, refer to the Engine Operator's Manual for specific instructions.
10. When the engine starts, move the Throttle Lever to the SLOW position and then gradually move the choke lever (on engines so equipped) to OFF or RUN position.
11. Move the throttle speed control to FAST setting when tilling.

## Starting Electric Start Engine with Recoil Starter

You may, at some point, have to start an electric start engine with the recoil starter rope. Before attempting to do so, perform the following applicable steps:

- If you suspect the battery charge is weak, and there is no visible damage. Disconnect the cables from the battery and clean both cable terminals, and the battery posts in accordance with the instructions provided in the Maintenance & Adjustments section. Reconnect the cables and securely tighten to the battery posts. The engine will recharge the battery if the battery is still good.
- If you suspect the battery is “dead”, or if the battery is damaged, disconnect, and remove it. Have it checked by a qualified technician.
- If the battery has been removed, wrap the cable terminals at the end of the positive cable with electrical tape and secure the cable to the battery bracket. This will prevent electrical discharge.
- Before pulling the recoil starter rope, turn the keyswitch to the RUN position. Move the Throttle Lever away from the STOP position and set the choke as applicable. See the Engine Operator’s Manual.

## Cold Weather Operation

When temperatures fall below 40° F, do the following steps to protect your engine and transmission from damage:

1. Refer to the Engine Operator’s Manual for the motor oil specifications for cold weather operation.
2. Use winter blend gasoline.
3. Warm the engine up before putting it under a load.
4. Use the correct weight gear oil in the PTO Power transmission.
5. Warm up the transmission gear oil as follows:
  - a. With the engine running, move the Wheel Speed Lever to FREEWHEEL (then block the wheels so they can’t roll).
  - b. Put the Tines/PTO Clutch Lever into DISENGAGE, then squeeze one of the Forward Interlock Levers and shift the Wheels/Tines/PTO Drive Lever to FORWARD.
6. If the wheels are frozen to the ground, melt the ice with warm water.

## Stopping the Engine and the Tiller

1. To stop the wheels and tines, move the Wheels/Tines/PTO Drive Lever into NEUTRAL position and then release both Forward Interlock Levers.
2. Move the engine Throttle Lever to the STOP position. Then on electric start models, turn the key to OFF. Remove the key for safekeeping.

**NOTE:** The engine may have a separate Throttle Control Lever and ON/OFF switch on the engine. These controls can also be used to stop the engine. See the Engine Operator’s Manual for information specific to your engine.

## Engaging the Drive & Tines

**NOTE:** This is a traditional standard-rotating-tine (SRT) tiller with forward rotating tines. It operates in a completely different manner than counter-rotating-tine (CRT) tillers, or from front-tine tillers.



**WARNING!** To help avoid personal injury, be aware that the tiller can unexpectedly bounce up or jump ahead and propel away from you if the tines strike hard or frozen ground, or buried obstacles like large stones, roots or stumps.

1. Start the engine and gradually increase the engine speed to FAST.
2. Test the Forward Interlock Safety System. See the Forward Interlock System in the Maintenance & Adjustments section for more information.



**WARNING!** The Forward Interlock Safety System is designed for the operator’s safety. Do not disconnect or attempt to defeat the purpose of the system. If the system malfunctions, immediately contact your local authorized dealer or the TROYBILT Technical Service Department for assistance. Do not use the tiller or the PTO power feature until the Forward Interlock Safety System is functioning properly.

3. When practicing, set the Depth Regulator Lever to Travel position. Otherwise, set the Depth Regulator Lever to a desired depth.
4. Move Tines/PTO Clutch Lever to ENGAGE position if you want the tines to turn. If practicing, leave in DISENGAGE.

**NOTE:** Do not move Tines/PTO Clutch Lever to ENGAGE unless Wheels/Tines/PTO Drive Lever is in NEUTRAL. Tiller damage may occur.
5. To move the tiller forward and engage the tines, squeeze and hold either Forward Interlock Lever against the handlebar grip (See Fig. 4-2), then move the Wheels/Tines/PTO Drive Lever down to FORWARD position.

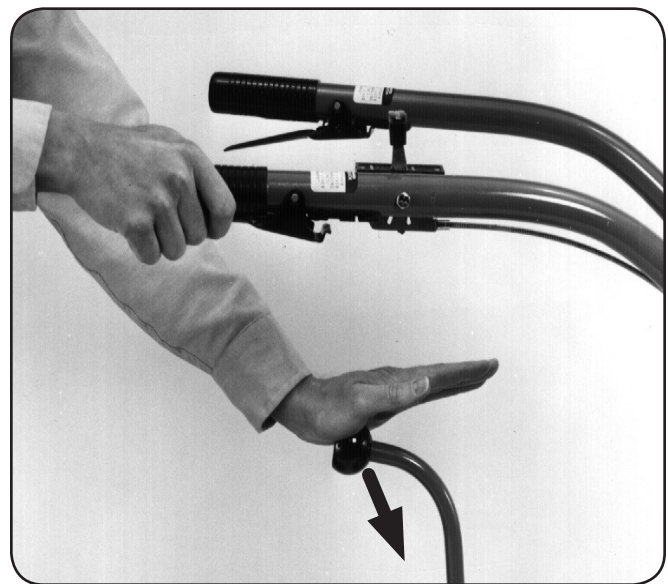

Figure 4-2

- When the tiller moves forward, relax and let the wheels power the tiller along while the tines dig. Walk behind and to one side of the tiller. Walk on the side that is not yet tilled. Use a firm grip on the handlebars but keep your arm relaxed. See Fig. 4-3.



Figure 4-3

**NOTE:** Let the tiller move ahead at its own pace. Do not push it ahead — this reduces operator control and tilling efficiency. Do not push the handlebars down in an attempt to dig deeper — this takes weight off the wheels, reduces traction, and causes the tines to try to propel the tiller.

### Stopping Forward Motion & Tines

- To stop forward motion, tap Wheels/Tines/PTO Drive Lever upward into NEUTRAL. Then release the Forward Interlock Levers. The wheels and tines will stop and the engine will continue running.
- In an emergency, release all of the control levers. This stops forward motion and shuts-off the engine.

### Moving in Reverse



**WARNING!** To help avoid personal injury or damage to the equipment be sure no obstacles are behind you before operating the tiller in REVERSE. Disengage the tines, reduce engine speed, and move the Wheel Speed Lever to SLOW position before operating in REVERSE. Avoid using FAST wheel speed until you are familiar with backing the tiller.

**NOTE:** Do not till while in REVERSE.

- Shift the Tines/Wheels/PTO Drive Lever into NEUTRAL and move the Wheel Speed Lever to the SLOW position.
- Move the Tines/PTO Clutch Lever into DISENGAGE position.
- Verify that the area behind you is clear.

- Lift up the handlebars until the tines are off the ground, then shift the Wheels/Tines/PTO Drive Lever all the way up and hold. You do not need to squeeze the Forward Interlock Levers to use reverse.
- The tiller immediately engages in reverse. Periodically check behind you while holding the handlebars up and the Wheels/Tines/PTO Lever in its upper-most position.

### Stopping Reverse Motion

Release the Wheels/Tines/PTO Drive Lever — the lever automatically returns to the NEUTRAL position. This stops the wheels immediately. The Forward Interlock Levers will not stop REVERSE motion.

### Turning the Tiller

Turning the tiller is easy and just requires practice. First find the balance point between the engine and the tines by lifting up the handlebars. See Fig. 4-4. Once you find the balance point, then let the powered wheels do the turning as you push sideways on the handlebars in the direction of the turn. Practice the turning maneuver described here in a large open area. Once comfortable turning the tiller, you can then take it to the garden area.



Figure 4-4

- At the end of a row, move the Wheels/Tines/PTO Drive Lever to NEUTRAL position and reduce the engine speed.
  - Move the Tines/PTO Clutch Lever into the DISENGAGE position.
  - Resume forward operation, and lift the handlebars until the tines are off the ground. Refer to Fig. 4-4. Find the balance point between the engine and the tines. Then push the handlebars in the direction of the turn. Be very careful to keep feet and legs away from the tines — which should be disengaged. Let the powered wheels do the hard work.
- NOTE:** Use REVERSE if necessary to turn in a limited space.
- When the turn is complete, shift to NEUTRAL and lower the handlebars. Move the Tines/PTO Clutch Lever back to ENGAGE position and resume forward operation.



## Choosing Wheel & Tine Speeds

The tiller has four FORWARD wheel/tine speed combinations for handling a variety of tilling tasks and gardening jobs. Experiment with the tine depth, engine speed, and wheel/tine speed to determine the combination that provides the best results. Here are some tips:

1. Advance the throttle lever so the engine has sufficient power.

2. When tilling untilled or hard earth, do not set the Depth Regulator too deep. The tiller will buck and the engine will load down.
3. You will know your settings are ideal when the tines break-up the soil easily, the engine does not labor, and your progress is steady and smooth. See Fig. 4-5.

### WHEEL SPEED AND BELT RANGE SELECTION GUIDE

SLOW GEAR, LOW BELT RANGE	SLOW GEAR, HIGH BELT RANGE	FAST GEAR, LOW BELT RANGE	FAST GEAR, HIGH BELT RANGE
For:	For:	For:	For:
<ol style="list-style-type: none"> <li>1. Tilling in sod.</li> <li>2. Tilling in hard clay.</li> <li>3. Tilling under standing cornstalks in tough soil conditions.</li> <li>4. Tilling under cover crops.</li> <li>5. Preparing a deep seedbed.</li> <li>6. Tilling in stony soil.</li> <li>7. Tilling under residues and organic matter.</li> <li>8. Mixing in fertilizers, manure.</li> </ol>	<ol style="list-style-type: none"> <li>1. Tilling in sod or hard clay.</li> <li>2. Tilling under standing cornstalks (slow, steady speed allows time to shred stalks).</li> <li>3. Tilling under cover crops (best wheel speed and belt speed range in most soils).</li> <li>4. Preparing seedbeds (best speed choice in most soils).</li> <li>5. Tilling in stony ground.</li> <li>6. Building raised garden beds.</li> <li>7. Mixing in fertilizer.</li> <li>8. Using tiller wings in hard soil.</li> <li>9. Mixing fertilizer and manure.</li> <li>10. Tilling residues and organics.</li> </ol>	<ol style="list-style-type: none"> <li>1. Going over seedbed for the last time before planting crops.</li> <li>2. Covering over seeds in wide row or plot planting (lift handlebars to avoid going too deep).</li> <li>3. Hilling and furrowing.</li> <li>4. Making raised beds.</li> <li>5. Cultivating (lift handlebars to avoid going too deep).</li> <li>6. Tilling large areas.</li> <li>7. Tilling organic matter in.</li> <li>8. Cultivating between raised beds with optional hiller/furrower attachment.</li> </ol>	<ol style="list-style-type: none"> <li>1. Preparing seedbeds for planting.</li> <li>2. Covering seeds with less need to hold up the handlebars.</li> <li>3. Cultivating (tiller travels faster, rides higher on the soil; allows engine RPM to be reduced; handlebars don't have to be raised).</li> <li>4. Keeping large areas tilled and cultivated in the summer.</li> <li>5. Tilling organic matter under.</li> <li>6. Moving tiller quickly.</li> <li>7. Cultivating between raised beds using the optional hiller/furrower.</li> </ol>

Figure 4-5

## Changing Belt speed

Your tiller has two belt-driven speed ranges — HIGH RANGE and LOW RANGE — you pick one or the other by deciding which set of pulley grooves to move the forward belt into. By moving the belt from one speed range into the other, in combination with the FAST and SLOW wheel speeds, you obtain a choice of four different forward wheel speeds and two different tine speeds.



**WARNING!** To help avoid serious personal injury, stop the engine, remove the ignition key, disconnect spark plug wire and move the wire away from the spark plug and let engine and muffler cool down before changing the belt speeds.

Changing the belt from LOW range into HIGH range (or back again) is a matter of moving the belt from one set of pulley grooves to a second set of pulley grooves. This change is done quickly and without tools.

When the tiller is moving in REVERSE, the wheels are powered by a rubber reverse disc, not by the belt. Therefore, you have only two reverse speeds SLOW and FAST, as set with the Wheel Speed Lever.

Fig. 4-6 shows the range of wheel and tine speeds available when using the two belt speed ranges and the FAST and SLOW selections on the Wheel Speed Lever.

Available wheel and tine speeds at 3000 RPM engine speed.			
Belt Position	Wheel Speed Lever	Wheel Speed	Tine Speed
Low Range	Slow	.5 MPH	146RPM
Low Range	Fast	1.2 MPH	146RPM
High Range	Slow	.7 MPH	200RPM
High Range	Fast	1.72 MPH	200RPM

Figure 4-6

## Changing Belt From Low Range to High Range

1. To avoid personal injury, shut off the engine, let all moving parts come to a complete stop, then disconnect the spark plug wire from the spark plug and move the wire away from the spark plug before making any adjustments. Wait for the engine and muffler to cool down.
2. Move the Wheels/Tines/PTO Drive Lever into NEUTRAL.



**WARNING!** The HIGH speed belt range position combined with a FAST wheel speed setting propels the tiller at the fastest pace. Reduce the engine throttle speed when starting out to help avoid personal injury or property damage if using this speed combination.

3. Kneel on the left side of tiller. To create belt slack, reach over to the right side of the pulleys and push in at the center of the belt with a finger. At the same time, use your left hand to work the belt part-way onto the lower-front transmission pulley groove. See Fig. 4-7.



Figure 4-7

4. Go to the other side of the tiller to finish seating the belt onto the pulley groove.

5. Working from the left side of the tiller, work the belt as much as possible onto the top-front engine pulley groove. See Fig. 4-8.

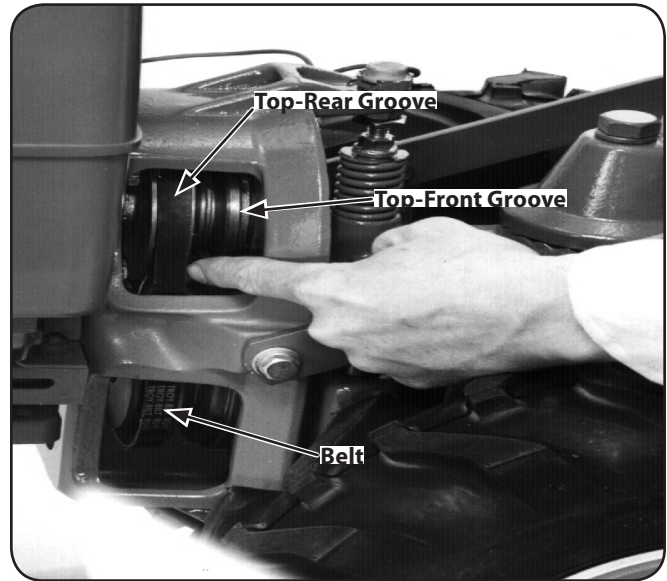

Figure 4-8

6. Finish seating the belt from the right side of the tiller.  
**NOTE:** Proper belt tension is important for good performance. See the Maintenance & Adjustment Section for instructions on adjusting belt tension.  
**NOTE:** If extra belt slack is needed to move the belt, just raise the Wheels/Tines/PTO Drive Lever up into REVERSE. This lowers the engine pulley, and creates more slack.
7. Check both sides of the high range pulley grooves to verify that the belt is properly seated.

## Changing Belt From High Range to Low Range

1. To avoid personal injury, shut off the engine, let all moving parts come to a complete stop, then disconnect the spark plug wire from the spark plug and move the wire away from the spark plug before making any adjustments. Let engine and muffler cool.
2. Move the Wheels/Tines/PTO Drive Lever into NEUTRAL.

- Stand on the left side of the tiller. Use your right hand to hold the Wheels/Tines/PTO Drive Lever up into REVERSE position. Use your left hand to move the belt off the top-front engine pulley groove to top-rear engine pulley groove. See Fig. 4-9.

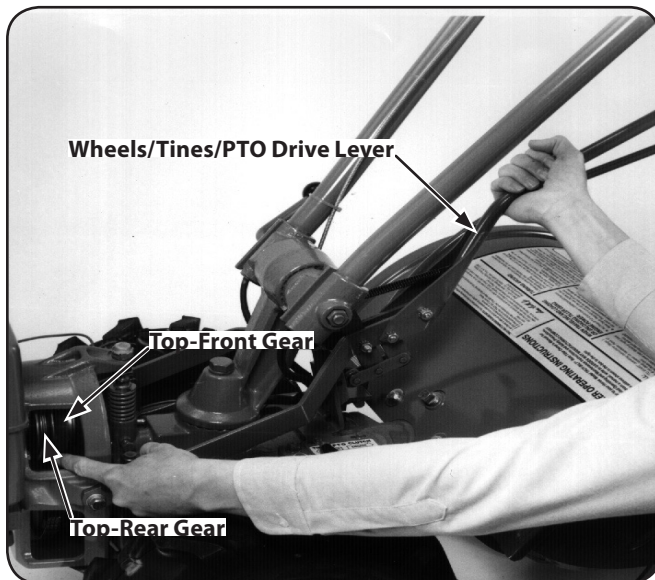

Figure 4-9

- Go to the right side of the tiller and finish seating the belt.
- Still holding the lever up in REVERSE position, and working from the left side of the tiller, move the belt from the lower front transmission groove to the lower rear transmission groove.
- Go to the right side of the tiller and finish seating the belt. See Fig. 4-10.

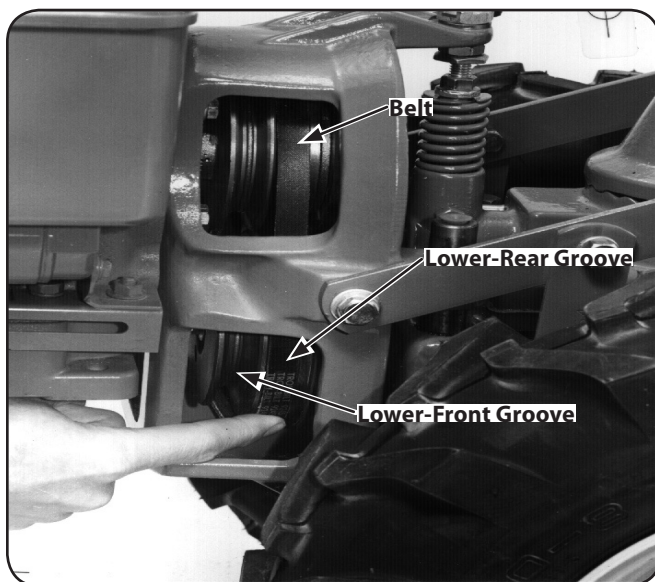

Figure 4-10

- Check that the belt is fully seated in the pulley grooves. Check this from both sides of the tiller.

## Clearing the Tines

The tines have a self-clearing action which helps to eliminate most tangling of debris. However, occasionally dry grass, stringy stalks or tough vines may become tangled. Follow these procedures to help avoid tangling and to clear the tines, if necessary.

- To reduce tangling, set the Depth Regulator deep enough to get maximum “chopping” action as the tines chop the material against the ground. Also, try to till under crop residues or cover crops while they are green, moist and tender.
- While power composting, try swaying the handlebars from side to side (about 6” to 12”). This “fishtailing” action often clears the tines of debris.
- It may be necessary to remove the debris by hand (a pocket knife will help you to cut away the material).



**WARNING!** Before clearing the tines by hand, stop the engine, allow all moving parts to stop and disconnect the spark plug wire. Failure to follow this warning could result in personal injury.

## Tilling Tips & Techniques

### Let the Tiller Do the Work

- While tilling, relax and let the wheels pull the tiller along while the tines do the digging. Walk on the side that is not yet finished to avoid making footprints in the freshly tilled soil and lightly, but securely grip the handlebar with just one hand. Refer to Fig. 4-3.
- Avoid pushing down on the handlebars in an attempt to force the tiller to dig deeper. Doing so takes the weight off the powered wheels, causing them to lose traction. Without the wheels helping to hold the tiller back, the tines will attempt to propel the tiller — often causing the tiller to skip rapidly across the ground. Sometimes, slight downward pressure on the handlebars will help get through a particularly tough section of sod or unbroken ground, but in most cases this won't be necessary.

### Tilling Depths

- Avoid trying to dig too deeply too quickly, especially when busting sod or tilling soil that hasn't been tilled for some time. Use shallow depth settings (only an inch or two deep) for the first passes through the garden area. With each succeeding pass, adjust the depth regulator to dig another inch or two deeper. Watering the garden area a few days prior to tilling will make tilling easier, as will letting the newly worked soil set for a day or two before making a final, deep tilling pass.
- When cultivating — breaking up the surface soil around plants to help destroy weeds — use very shallow depth settings to prevent injury to plants whose roots often grow close to the surface. If needed, lift up on the handlebars slightly to prevent the tines from digging too deeply. Cultivating on a regular basis not only eliminates weeds, it also loosens and aerates the soil for better moisture absorption and faster plant growth.

### Avoid Tilling Wet, Soggy Soil

- Tilling wet soil often results in large, hard clumps of soil that can interfere with planting. If time permits, wait a day or two after heavy rains to allow the soil to dry before tilling. Test the soil by squeezing it into a ball. If it compresses too easily, it is too wet to till.

### Avoid Making Footprints

- When possible, walk on the untilled side of the tiller to avoid making footprints in the freshly tilled soil. See Fig. 4-3. Footprints cause soil compaction that can hamper root penetration and contribute to soil erosion. They can also “plant” unwanted weed seeds back into the newly tilled soil.

### Suggested Tilling Patterns

- When preparing a seedbed, go over the same path twice in the first row, then overlap one-half the tiller width on the rest of the passes. See Fig. 4-11.

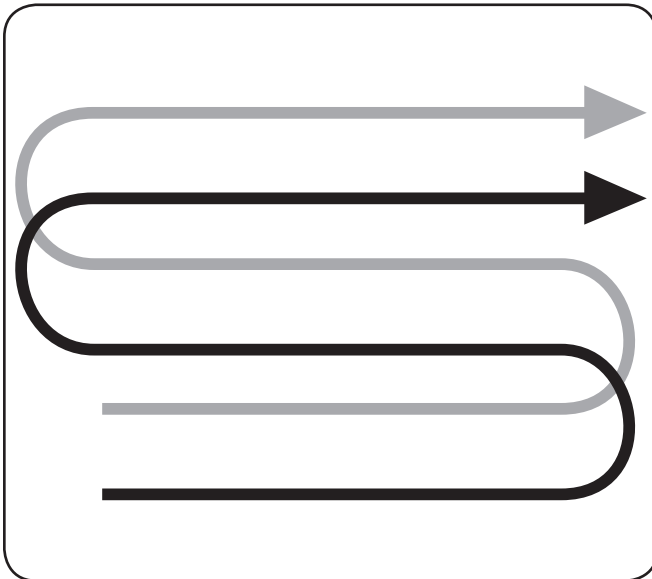

Figure 4-11

- When finished in one direction, make a second pass at a right angle. See Fig. 4-12. Overlap each pass for best results. In very hard ground it may take three or four passes to thoroughly pulverize the soil.

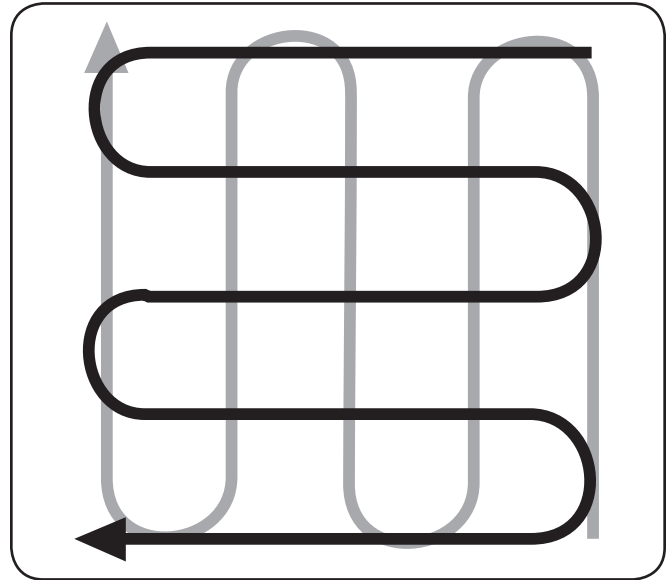

Figure 4-12

- If the garden size will not permit lengthwise and then crosswise tilling, then overlap the first passes by  $\frac{1}{2}$  a tiller width, followed by successive passes at  $\frac{1}{4}$  width. See Fig. 4-13.

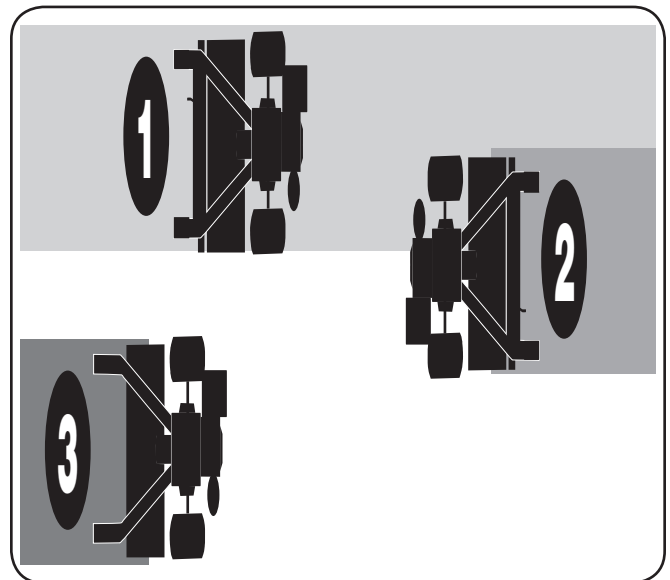

Figure 4-13

- With planning, you can allow enough room between rows to cultivate. Leave room for the hood width, plus enough extra room for future plant growth. See Fig. 4-14.

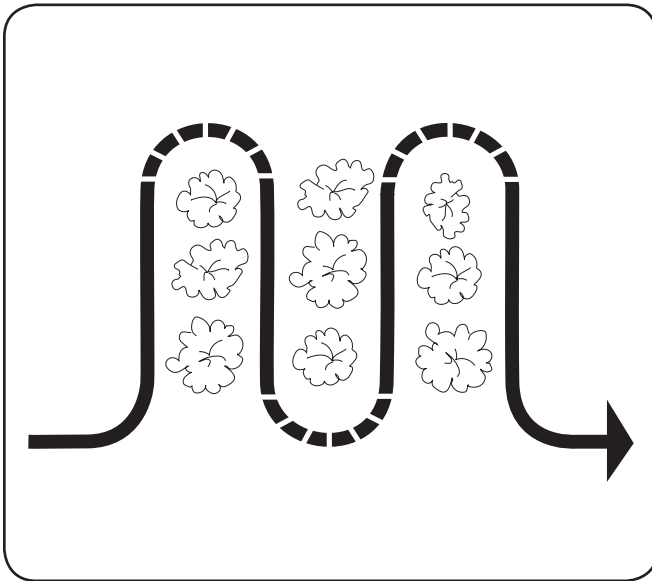

Figure 4-14

### Tilling on Slopes

If you must garden on sloping ground, please follow two very important guidelines:

1. Till only on moderate slopes, never on steep inclines where footing is difficult review the safety rules in the Safe Operation Practices section.
2. It is recommend that you till up and down slopes rather than terracing. Tilling vertically on a slope allows maximum planting area and also leaves room for cultivating.

**NOTE:** When tilling on slopes, be sure the correct oil level is maintained in the engine (check every ½ hour of operation). The incline of the slope will cause the oil to slant away from its normal level and this can starve engine parts of required lubrication. Keep the engine oil level at the full point at all times.

Tilling up and down slopes:

- To keep soil erosion to a minimum, be sure to add enough organic matter to the soil so that it has good moisture holding texture and try to avoid leaving footprints or wheel marks.
- When tilling vertically, try to make the first pass uphill as the tiller digs more deeply going uphill than it does downhill. In soft soil or weeds, you may have to lift the handlebars slightly while going uphill. When going downhill, overlap the first pass by about ½ the width of the tiller.

**NOTE:** For the best results, use the HIGH belt range and SLOW wheel speed lever position. See Changing Speed Belts in this section for more information on changing to high range.

Terrace Gardening:

- When a slope is too steep or too short for vertical tilling, it may be necessary to till across the slope and create terraced rows. Terraces are rows that are cut into the side of a slope, creating a narrow, but flat area on which to plant.
- On a long slope, you can make several terraces, one below the other.
- Terraces should be only 2-to-3 feet wide. Digging too far into the side of the slope will expose poor subsoil that is unproductive for plants.
- To create a terrace, start at the top of the slope and work down. Go back and forth across the first row. See Fig. 4-15.

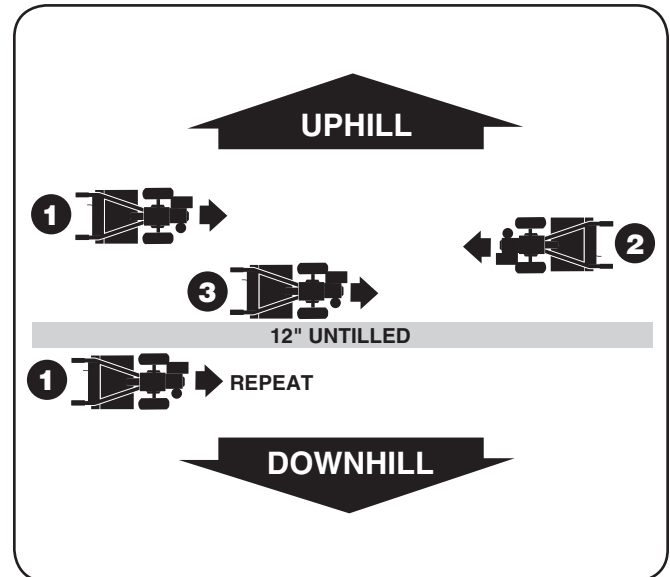

Figure 4-15

- Each succeeding lower terrace is started by walking below the terrace you're preparing. For added stability of the tiller, always keep the uphill wheel in the soft, newly tilled soil. Do not till the last 12" or more of the downhill outside edge of each terrace. This untilled strip helps prevents the terraces from breaking apart and washing downhill. It also provides a walking path between rows.

Tilling across slopes without terracing:

- If vertical or terracing gardening aren't practical for you, then you can till laterally across a slope. We don't really recommend this method as it can create unsure footing and invites soil erosion.
- Study the terrain to make certain the slope is not too Steep for safe tilling. If possible, make terraced rows or till vertically.

- Move the belt into LOW belt range and the Wheel Speed Gear Lever to SLOW position. As in terrace gardening, start at the top of the slope and overlap the first pass by half the width of the tiller. For added stability, keep the uphill wheel in the soft, newly tilled soil. Each succeeding terraced area is started by walking below the terrace you are preparing. See Fig. 4-16.



Figure 4-16

- Standing cornstalks of reasonable height can be power composted. See Fig. 4-17. Pushing over (but not uprooting) cornstalks will often make it easier for your tiller to chop up the stalks. Keep the tines clear of excessive tangling by “fishtailing” or frequently using reverse. Make several passes, then return a few days later to finish off any remaining stubble.



Figure 4-17

## Power Composting

Power composting means tilling under and burying in the soil all manner of organic matter such as crop residues, leaves, grass clippings and cover crops. This material will decompose during the non-growing season and add important natural nutrients to the soil.



**WARNING!** When power composting, do not keep the Depth Regulator Lever at a deep setting if the tiller jumps or bucks. If jumping or bucking occurs, move the Depth Regulator Lever down to one of the shallower settings and then slowly increase the tilling depth on later passes. Failure to comply could result in loss of tiller control, property damage or personal injury.

- Begin by composting crop residues such as leftover vines, stalks, stems and roots. Power compost these crop residues as soon as they finish bearing. The sooner this is done, the better, as tender green matter is easier to till under. Use the deepest depth regulator setting possible without causing the engine to labor or the tiller to jump ahead.

- After tilling under crop residues, add more organic matter such as leaves, grass clippings and even kitchen scraps. When tilled into the soil, this organic matter will decompose and add even more important nutrients to the soil.
- After power composting, you may want to plant a “green manure” cover crop to protect the soil during the off-season. Grow a crop of clover, alfalfa, buckwheat, peas, beans, rye grass, grain, or kale and then till it into the soil prior to the planting season.

## Wide-Row Planting

The wide-row planting technique is spreading seeds anywhere from 10 inches to 2 feet wide or more. As a result, you can grow anywhere from 3 to 4 times (or more) produce in the same space that is normally set aside for an area that has narrow, single rows.

Wide-row planting automatically shades the ground which keeps weed growth down and also holds moisture in the soil. And of course, harvesting is much easier — everything is right at hand to be picked. Preparing wide rows is easy — after you prepare the seedbed and mark off the rows with string, hand-broadcast the seeds as if seeding a lawn — not quite as much as lawn seed). Cover with soil and tamp the area firmly with a hoe.

## Tilling Under Corn

After corn is harvested, the stalks should be tilled into the soil while still green. Dry plants are more difficult to till under, and the roots break loose too easily.

**NOTE:** Do not pull the roots out by hand or cut the stalks before tilling. Stalks that are firmly anchored by their roots are much easier for the tines to chop, cut, and work under.

1. As you move forward into a row of stalks, aim the tiller so that the stalks go between the left wheel and the transmission case. See Fig. 4-17. Do not use the right wheel because damage could occur to the air cleaner, carburetor or throttle linkage.
2. Each new pass should overlap the previous pass by one-half the width of the tiller.
3. Till as deeply as possible. Pull the Depth Regulator all the way UP and engage the lowest notch for deep tilling. Use either LOW or HIGH belt range and SLOW wheel speed gear position. Let the tilled-in stalks decompose for a week or so. Then till in the remaining residue as deep as possible.

## PTO Power Feature

Your tiller is a self-contained PTO (Power Take-Off) Power machine that was shipped with a tine attachment installed. The tine attachment can be quickly removed and replaced with other optional attachments. See Fig. 4-18. The following instructions will familiarize you with your PTO Power machine. Please read these pages carefully. The following steps explain how to remove and replace the tine attachment. You will need a  $\frac{3}{4}$ " wrench, minimum 12" long for leverage.



Figure 4-12

**NOTE:** Before operating your PTO Power machine for the first time, make sure that you have Read all the safety instructions in the Safe Operation Practices section of this manual and in the as well as the manual supplied with any attachment. Read the controls information and operating procedures for the tiller and engine described in the Assembly & Set-Up and the Controls & Features sections. Also be sure to read the Engine Operator's Manual.

## Removing the Tine Attachment

1. Move the tiller to level ground.
2. Be sure the engine is stopped, the electric start key is removed, and the spark plug wire is disconnected and moved away from the spark plug.
3. Place a sturdy support under the engine to prevent the engine from tipping forward when the tine attachment is removed. See Fig. 4-19.

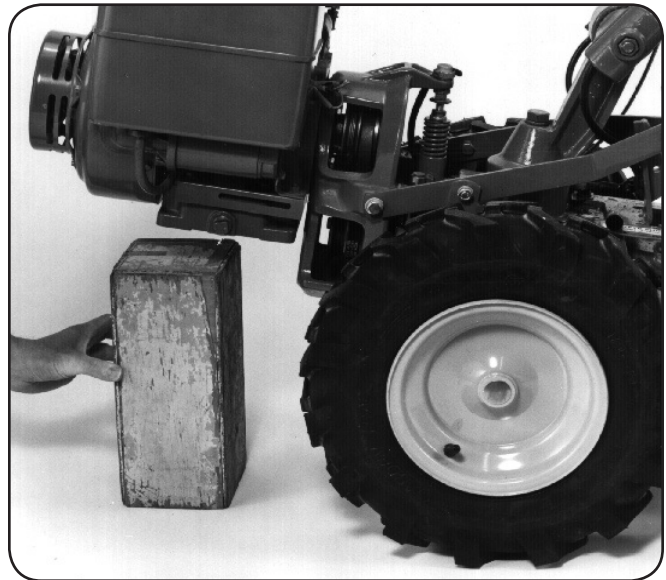

Figure 4-19

4. Place the Wheels/Tines/PTO Drive Lever into NEUTRAL.
5. Place Tines/PTO Clutch Lever in DISENGAGE.
6. Place Wheel Speed Lever into FREE WHEEL.
7. Loosen the two swing-out bolts that connect the power transmission to the tine attachment. See Fig. 4-20.



Figure 4-20

- Then move the swing-out bolts out. See Fig. 4-21.

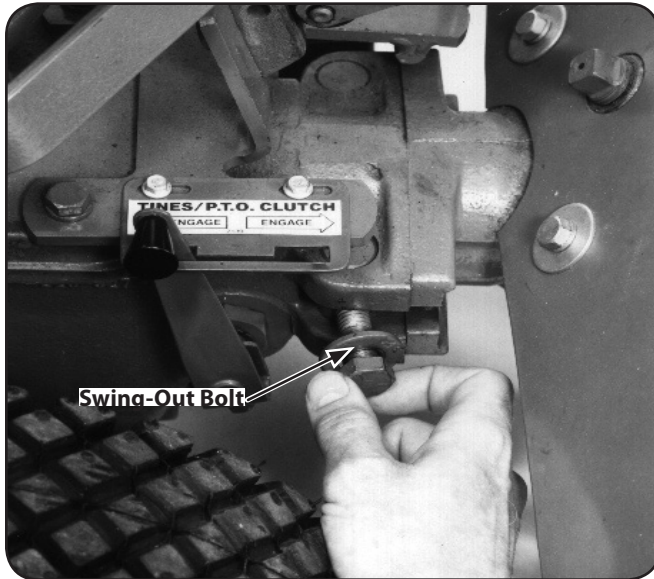

Figure 4-21

**NOTE:** Loosening swing-out bolts can be difficult. Use an extra-long wrench for leverage.

- Tip the PTO power machine forward about one inch with one hand while pulling the tine attachment back. Fig. 4-22.

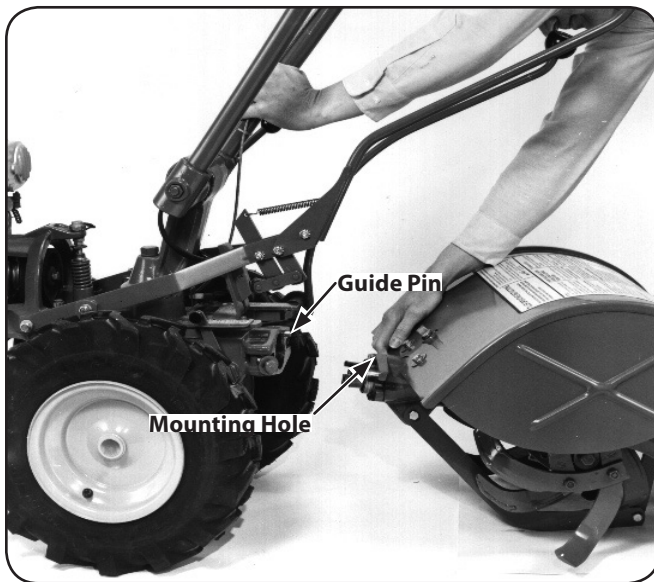

Figure 4-22

- The guide pin on the power unit will slide out of the guide hole in the tine attachment. See Fig. 4-23.

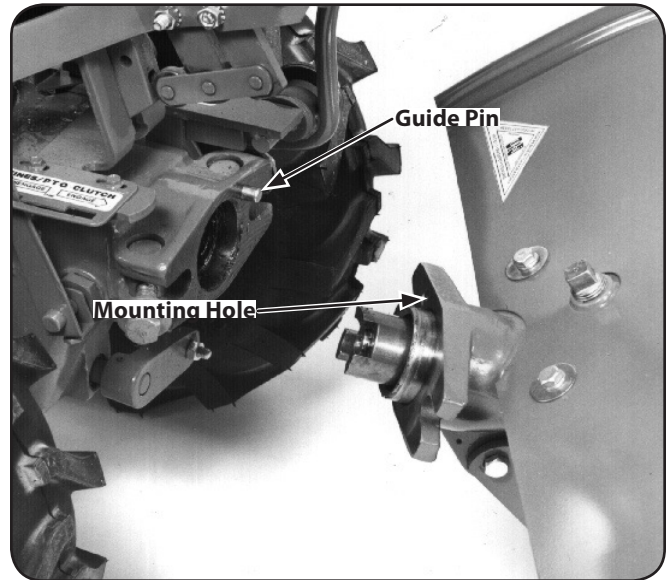

Figure 4-23

### Installing the Tine Attachment

- Move the two PTO Power Unit swingout bolts outward and slide the washers up against the bolt heads.
- Remove the support block from under the engine and slowly roll the power unit back next to the tine attachment. Place the support block back under the engine.
- Remove the dust cap (or protective wrapping) from the dog clutch coupling on the tine attachment.
- Carefully align the guide pin on the PTO Power Unit with the alignment hole in the tine attachment and bring the two units together. See Fig. 4-23.
- Move the two swing-bolts into the slots of the tine attachment. Alternately tighten each bolt until they are tight enough to make the concave washers flat. The bolts must be very tight — if you have a torque wrench, tighten each bolt to between 70 and 80 ft.-lbs.

**NOTE:** The swing-bolts must be kept very tight to prevent damaging wear to the dog clutch coupling, alignment pin or the alignment hole. Check the bolt tightness every 2-½ operating hours.

- Remove the engine support before moving the tiller in a forward direction.



## Moving the Tiller

When the engine is running, the tiller's powered wheels make moving the tiller to and from the garden easy. If the engine is not running, set the Wheel Speed Lever to FREEWHEEL position to roll the tiller to another location.



**WARNING!** To help avoid personal injury from revolving tines, always put the Tines/PTO Clutch Lever in DISENGAGE position before transporting, loading, or unloading tiller.

1. Place the Tines/PTO Clutch Lever in DISENGAGE position.
2. Move the Depth Regulator Lever down all the way into the Travel setting.
3. If using engine power, move Wheel Speed Lever to either SLOW or FAST, and use the Wheels/Tines/PTO Drive Lever to drive the wheels.
4. If the engine is stopped, move Wheel Speed Lever to FREEWHEEL, and manually push the tiller.

## Loading & Unloading the Tiller

The following provides information on tiller loading, unloading, and requirements before loading and unloading the tiller. Read the following instructions carefully before attempting to load or unload your tiller.

Follow these steps before loading or unloading the Tiller

- Ramps must be strong enough to support the combined weight of the tiller and the operator. They should provide good traction to prevent slipping; they should have side rails to guide the tiller along the ramps; and they should have a locking device to secure them to the vehicle.
- Operators should wear sturdy footwear that will help to prevent slipping.
- Turn the vehicle's engine off and apply its parking brake.
- Position the loading vehicle so that the ramp angle is as flat as possible (the less incline to the ramp, the better)

### Loading the Tiller

1. Use loading ramps that are strong and wide enough to safely hold the weight of the tiller and the operator combined — your tiller weighs between 280 and 325 lbs.
2. Move the Tines/PTO Clutch Lever into DISENGAGE position.
3. Set the Depth Regulator lever to the Travel position.
4. Move Wheel Speed Lever into SLOW position and reduce the engine throttle speed.
5. Shift the Wheels/Tines/PTO Lever into FORWARD position and follow the tiller up the ramps. Check the wheels as you move the tiller forward. Ensure that they move up the center of each ramp.
6. Prevent the tiller from rolling in the vehicle. Leave Wheel Speed Lever in FAST or SLOW position, chock the wheels with blocks and tie down the tiller.

### Unloading the Tiller

**NOTE:** Never unload the tiller in FORWARD drive. The tiller could tip forward and expose you to the tines (which should be disengaged as instructed).

1. Use loading ramps that are strong and wide enough to safely hold the weight of the tiller and the operator combined — your tiller weighs between 280 and 325 lbs.
2. Move the Tines/PTO Clutch Lever to DISENGAGE position.
3. Set the Depth Regulator Lever to the TRAVEL position.
4. Move Wheel Speed Lever to SLOW position and reduce the engine throttle speed.

**NOTE:** Look behind you before you back down the ramp to ensure that all is clear. While descending, keep checking for obstacles behind you.

5. Move and hold the Wheels/Tines/PTO Lever into REVERSE drive and back down the ramps. Check the wheels as you move the tiller backward. Ensure that they move down the center of each ramp.

## Maintenance Schedule

	After 2-hour Break-In	Before Each Use	Every 10 Hours	Every 25 Hours	Every 30 Hours	Refer to Engine Manual
Check Engine Oil Level						✓
Clean Engine Cooling System						✓
Test Operation of FWD. Interlock Safety System		✓				
FWD. Interlock Safety System — Check Wire Condition/Connections		✓	✓			
Check Electrical Connections		✓				
Recharge Battery						
Check Drive Belt Tension	✓	✓				
Check Nuts and Bolts	✓	✓	✓			
Clean Tiller Tine Shaft		✓	✓			
Lubricate Tiller		✓	✓			
Check Gear Oil Level in Both Transmissions	✓			✓	✓	✓
Check Bolo Tines for Wear					✓	
Check Reverse Disc for Wear					✓	
Check Air Pressure in Tire					✓	



**WARNING!** Before inspecting, cleaning or servicing the tiller, shut off the engine and wait for all the parts to come to a complete stop. Disconnect the spark plug wire and move the wire away from the spark plug. Remove the ignition key on the electric start models. Failure to follow these instructions can result in serious personal injury or property damage.

### Tire Pressure

Check the air pressure in both tires every 30 operating hours. Deflate or inflate both tires evenly to 15- to 20-PSI (pounds per square inch).

Be sure that both tires have the same air pressure or the tiller will tend to pull to one side.

## Maintenance

### Engine

Refer to the Engine Operator's Manual packed with your machine for all engine maintenance.

## Battery



**WARNING!** When removing the battery, always disconnect the negative (-) cable first followed by the positive (+) cable. Reverse this procedure when reinstalling the battery.

The battery is sealed and is maintenance free. Acid levels cannot be checked.

- Always keep the battery cables and terminals clean and free of corrosive build-up.
- After cleaning the battery and terminals, apply a light coat of petroleum jelly or grease to the terminals and cover both terminals with the rubber boots.

## Tine Shaft

After every 10 operating hours, remove the left- and right-side Bolo Tine holders and clear away dirt and debris that have accumulated on the tine shaft or inside the tine holders. Please follow this maintenance recommendation, as debris can cause premature wear to the tine shaft and its oil seals. Refer to the previous tine holder removal instructions. After cleaning away any debris and removing old grease from the tine shaft, apply fresh grease to the tine shaft.

## Wheel Shaft Maintenance

After every 10 operating hours, remove the wheels and clear away dirt and debris that has accumulated on the wheel shaft. Please follow this maintenance recommendation, as debris can cause premature wear to the wheel shaft and its oil seals.

1. Prop the transmission up with a sturdy block to raise the wheels off the ground.
2. Remove the wheels by removing the hex bolt and lock nut which secures each to the wheel shaft.
3. After cleaning away any debris and removing old grease, apply fresh grease to the wheel shaft before re-installing the wheels.

## Hardware

Check for loose or missing hardware every ten (10) operating hours. Failure to tighten or replace fasteners can cause poor performance, equipment damage or oil leakage. Most hardware on your tiller is visible. Pay particular attention to hardware listed below.

## Transmission Pulley Mounting Bolt

- If the washer behind the bolt head is loose, the bolt needs tightening. To do this, first insert a punch or thick screwdriver into the hole next to the bolt and wedge the tool against the side of the motor mount casting. This immobilizes the pulley while you tighten the bolt. See Fig. 6-1.

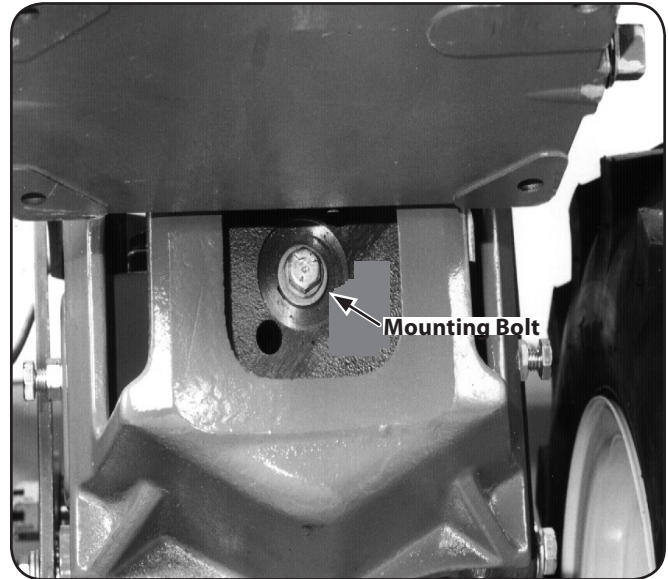

Figure 6-1

## Neutral Plunger Assembly Jam Nut

- The jam nut is located on the left side of the neutral plunger. If loose, immobilize bolt head with one wrench and use another wrench to tighten the nut. See Fig. 6-2.

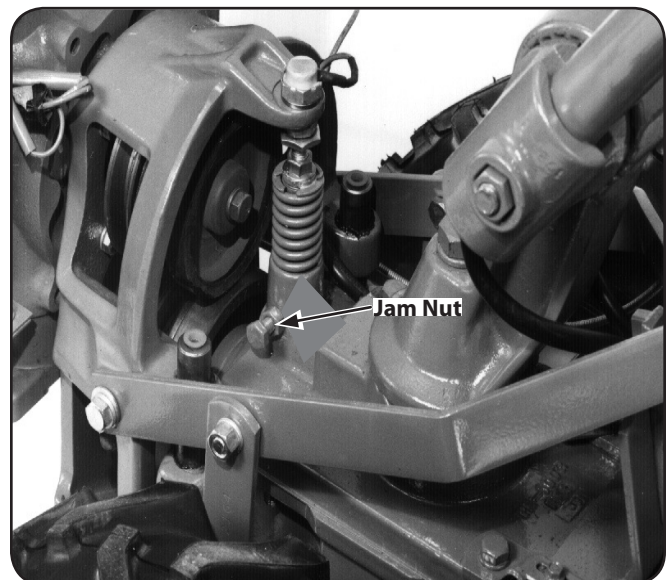

Figure 6-2

### Rear Bearing Cap Screws

- The three rear bearing cap screws are located under the depth regulator mounting bracket. If any are loose, it can cause an oil leak or drive shaft end play. See Fig. 6-3.

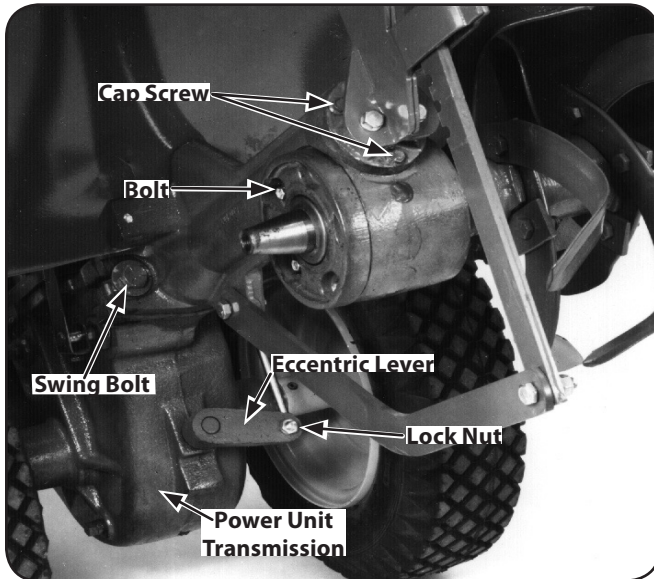

Figure 6-3

### Housing Cover Bolts

- Check the five bolts securing the tiller housing cover to the left side of the transmission. Gear oil can leak from a loose housing cover. To reach the bolts, remove the left side tine holder. See Tine Replacement in the Service section.

### Swing Bolts

- Check both of the swing-bolts that connect the power unit transmission to the tine attachment. Both bolts should be checked every 2-½ hours of operation. If loose, wear can occur on the locating pin on the power unit, and cause enlargement of the locating hole in the tine attachment. Using a torque wrench, tighten these bolts to 70-to-80 ft.-lbs.

### Lock Nut on the Shifting Linkage

- Check the locknut that fastens the shifting linkage to the eccentric shifting lever. See Fig. 6-3. Do not tighten the locknut against the eccentric lever. It should be very close to, but not touching the lever.

### Tine Hardware

- Check the four bolts and nuts securing left and right tine holders to the tine shaft. See Fig. 6-4.

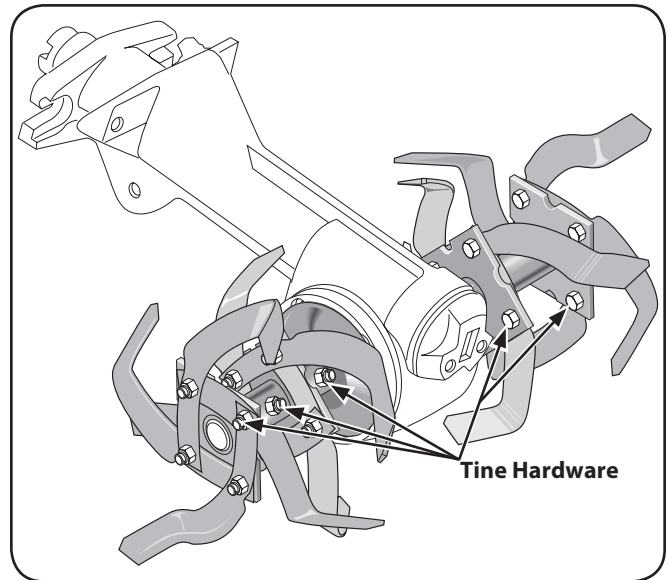

Figure 6-4

### Transmission Gear Oil

#### Checking for oil leaks

- At 25-hour operation intervals, check the tiller for oil leaks. Inspect for oil accumulations on the tiller or the floor where it is stored.
- A small amount of oil seepage or wetness around a shaft opening or cover is no cause for alarm. But a heavy concentration of oil is more serious. You should tighten all bolts immediately, and replace any worn seals or gaskets.
- It may be impossible to determine how much oil has been lost, so check the oil levels in the PTO transmission and the tine attachment before using the tiller again. Add any necessary gear oil. Serious damage to the transmission components can result from operation when gear oil levels are low.

- If tilling during very hot weather, the gear oil may heat up and expand inside the transmissions. To allow for this oil expansion, both the power unit transmission and the tine attachment transmissions have oil relief vents. See Fig. 6-5.

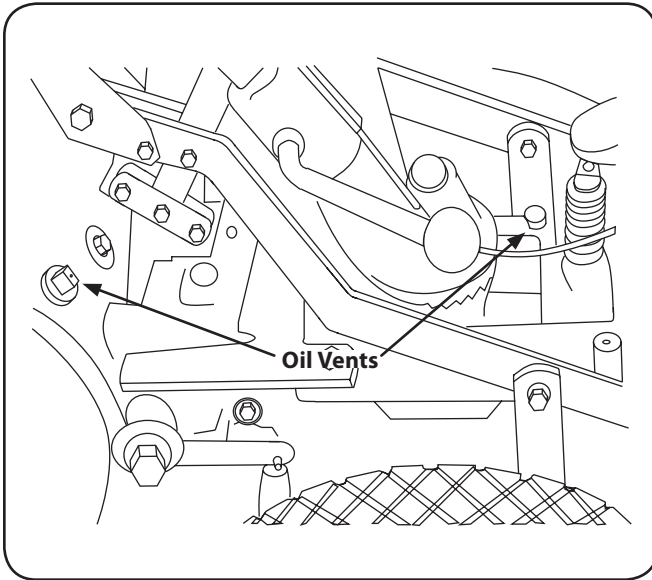

**Figure 6-5**

- The vents allow small amounts of oil to seep out.
- If a serious leak is discovered, please contact your authorized dealer or the TROY-BILT Technical Service Department for service advice.

#### Checking Gear Oil Levels

Every 30 hours of operation, check the gear oil level in both the power unit transmission and the tine attachment transmission. Operating them while low on gear oil — even briefly — can cause serious damage to internal components.

1. The transmissions must be cool, since hot gear oil expands and gives a false reading.
2. The power unit transmission and the tine attachment transmission must be connected when checking — or adding — gear oil.
3. Move the tiller to level ground. Move the Depth Regulator up so the tines rest on the ground.

4. Use a  $\frac{3}{8}$ " wrench to remove the oil level check plug on the left side of the transmission housing. See Fig. 6-6.

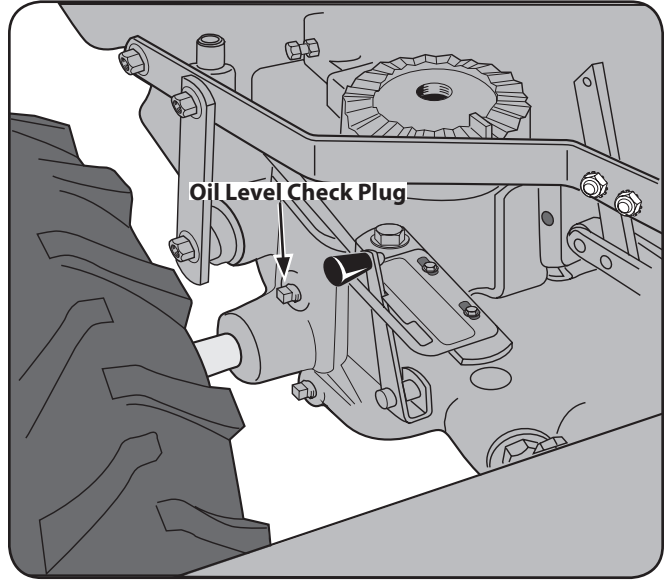
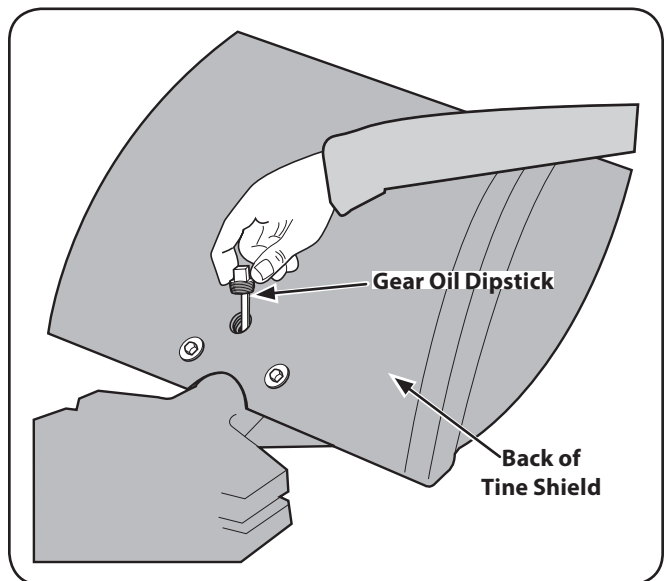

**Figure 6-6**

5. If the oil level is correct, oil will seep out of the check hole (allow extra time in cold weather). If it does, the level is fine and you should replace the check plug. If no oil seeps out add oil as demonstrated in the Adding Oil Section on the next page.

#### Tine Attachment Oil Level

**NOTE:** Two different gear oil checking procedures for the tine attachment transmission are described next. Use the first procedure if the dipstick in your tine attachment has only a 'Check Cold' marking. Use the second procedure if the dipstick has both cold and hot markings at the end. First remove the dipstick from the tine attachment transmission to see which type of dipstick you have. See Fig. 6-7. Then replace the dipstick with the markings on the dipstick facing to the rear.



**Figure 6-7**

**For dipsticks With ‘Check Cold’ Marking** (Cold means 2 hours have passed since the tiller was used.)

1. Move the tiller to level ground.
2. Pull the Depth Regulator Lever back, then push it down all the way (to engage its top notch).
3. Place a sturdy support under the engine to prevent the tiller from tilting too far.
4. Now slide three pieces of 2" x 4" lumber underneath the drag bar — raising the drag bar about 4-½" above ground. This elevation allows an accurate “cold” gear oil reading .
5. Wait two hours with tiller elevated (allow more time if temperature is below 40°F).
6. Loosen and remove the transmission dipstick on the back of the tine shield. See Fig. 6-7. Wipe it clean with a rag.
7. Hold the dipstick so its markings face to the rear of tiller. Lower it straight down into the sump hole to touch the drive shaft inside. See Fig. 6-7. Don’t force or try to thread it back in; an incorrect reading will result.
8. Remove the dipstick and check the oil level. It should be anywhere within the crosshatched area or even slightly above the Max marking. If correct, replace the dipstick and remove the boards used as props.
9. If the oil level was low, gear oil must be added before using the tiller. See Adding or Changing Gear Oil.

#### **For Dipsticks With Hot/Cold Markings**

1. Move the tiller to level ground.
2. Pull the Depth Regulator Lever back, then push it down all the way (to engage its top notch).
3. Place a sturdy support under the engine to prevent the tiller from tilting too far.
4. Cold reading (preferred method): (Two hours has passed since the tiller was used.) Place a 2" x 4" board (on edge) under the drag bar — raising the tiller and drag bar about 3-½" above ground. Hot reading: (Tiller was operated for more than 30 minutes within the past hour.) Do not use the wood prop to elevate the tiller.
5. Follow Steps 4, 5 and 6 given for the other dipstick type.
6. Remove the dipstick and check the level. It should be within or above the “Cold” range marking if taking a cold reading. If taking a hot reading, the level should be within or slightly above the “Hot” range.
7. If the level is incorrect, see Adding or Changing Gear Oil.

#### **Adding or Changing Gear Oil**

For partial fill-ups (just a few ounces or less), use SAE 140, SAE 85W-140, or SAE 80W-90 weight gear oil with an API rating of GL-4 or GL-5. For full replacement, use SAE 140 or SAE 85W-140 gear oil with an API rating of GL-4 only. (At the factory, SAE 85W-140 weight gear oil is used.)

**NOTE:** Do not use automatic transmission fluid or engine oil. They are too light in weight and will result in transmission damage.

**NOTE:** The gear oil does not need to be changed. Do so only if you know, or suspect, it is contaminated with dirt, sand or other foreign particles.

Gear oil is available at authorized dealers and most service stations, power equipment centers, or farm/heavy equipment outlets.

Capacities: The Power Unit transmission holds approximately 60 ounces and the Tine Attachment transmission holds approximately 12-½" ounces.

#### **Adding Gear Oil to the PTO Power Unit Transmission**

1. Do steps 1 and 2 of Checking the Power Unit Oil Level.
2. Using a ¾" wrench (or socket), remove the bolt securing the handlebar base to the top of the transmission (prop the handlebars first to prevent them from falling). Then, unplug the Forward Interlock wire harness receptacle at the bottom of the handlebars. Set the handlebar base and bolt aside on a clean surface. The bolt hole in the top of the transmission is the gear oil fill hole. See Fig. 6-7.
3. Slowly pour gear oil through a clean funnel into the transmission. Stop when gear oil begins to flow from the oil level check hole on the left side of the transmission. See Fig. 6-7.
4. Reinstall the oil level check plug. Tighten it securely.
5. Reinstall the handlebars using the mounting bolt previously removed. Align the handlebars so they point straight backwards, not at an angle. Then tighten the mounting bolt securely.
6. Reconnect the Forward Interlock wire harness to the receptacle. Be certain it’s secure.
7. Test the operation of the Forward Interlock Safety System. See Forward Interlock System on the next page.

#### **Draining and Filling the PTO Power Unit Transmission**

1. Place a shallow pan under the transmission gear oil drain plug. See Fig. 6-8.

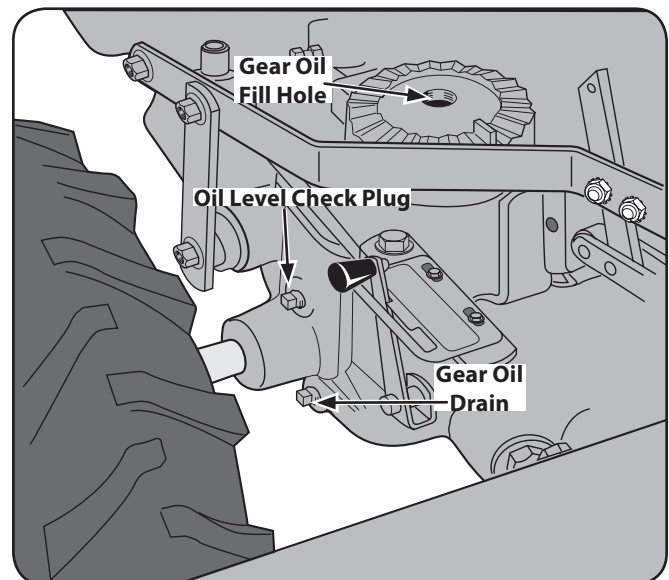

**Figure 6-8**

2. Remove the oil level check plug with a ¾" wrench. This vents the transmission for faster oil draining.

3. Using the  $\frac{3}{8}$ " wrench, remove the drain plug. The gear oil will drain quite slowly since it is thick. After about two quarts have drained, tilt the tiller forward so any oil at the rear of the transmission will drain out.
4. Clean the drain plug threads, put non-hardening gasket sealant on the threads, and reinstall the plug.
5. Refill the transmission with the correct amount of gear oil before operating the tiller again. When oil seeps from the oil level check hole, the right amount of gear oil has been added. Replace all plugs.

#### Adding Gear Oil to the Tine Attachment Transmission

1. Select the right Depth Regulator Lever setting:
  - a. If filling an empty transmission, raise the Depth Regulator Lever so tines are on the ground.
  - b. If topping off the gear oil, move Depth Regulator Lever down to engage its top notch.
2. Remove the dipstick from the tine attachment. See Fig. 6-6.
3. Slowly add gear oil in the dipstick hole. Add  $\frac{1}{2}$ -ounce at a time to avoid overfilling. It takes about 12- $\frac{1}{2}$  ounces.
4. Take dipstick readings frequently. Stop when oil reaches "Cold" range marking on dipstick. Replace dipstick securely.

#### Draining and Filling the Tine Attachment Transmission

1. The tine attachment transmission is not equipped with an oil drain plug. To drain just a small amount of gear oil, remove the dipstick and tilt the attachment forward, first uncoupling it from the Power Unit.
2. For complete drainage, remove the left-side tine assembly (See Tine Replacement in the Service section.), then remove just one of the lower screws from the tiller housing cover. See Fig. 6-9. To speed drainage, remove the tine attachment dipstick to vent transmission.



**Figure 6-9**

**NOTE:** If you find a plastic washer on the cover screw you removed, discard the washer. There is no need to install a replacement washer.

3. Once all the gear oil has drained, reinstall the housing cover screw securely (first coat its threads with non-hardening gasket sealant).
4. Be certain to refill the transmission with the correct amount of gear oil before operating the tiller again.

#### Forward Interlock System

The wiring circuit for the Forward Interlock Safety System is designed to ground out the engine's ignition system.

There are three switches in the circuit which, when open, let the engine run. One switch is on the neutral plunger tab of the cast iron motor mount. This switch is open whenever the Wheels/Tines/PTO Drive Lever is in NEUTRAL or REVERSE positions. The other two switches are located inside the handlebars, directly above the two Forward Interlock Levers. The switches are wired so when squeezed (open) the engine will run. There is a fourth switch located in the wiring harness connector on the top, right side of the transmission cover. It warns you if the connection is not mated by not letting the engine run while the Wheels/Tines/PTO Drive Lever is in FORWARD.

1. A broken or disconnected wire could let the engine run without you having to press one of the Forward Interlock Levers.
2. A bare wire touching the tiller or engine metal could ground out the engine's ignition.
3. A switch that has failed allows the engine to run. Or it may prevent the engine from running.

#### Lubrication

Proper lubrication of the tiller's mechanical parts is an essential part of good maintenance. Lubrication should be done after every ten (10) hours of operation.

Use ordinary motor oil (#30 weight or lighter) where oil is specified. Use a quality grease with a metal lubricant where grease is recommended (regular grease is acceptable). Do not over lubricate. If there is a build-up of dirt, remove the build-up and re-apply oil or grease.

**NOTE:** Do not allow oil or grease to contact the pulleys, drive belt or reverse disc. This can cause the belt or disc to slip on the pulleys.

Lubricate the tiller as follows:

1. Oil the wheel shaft between the wheel hubs and the transmission housing. See Fig. 6-10.

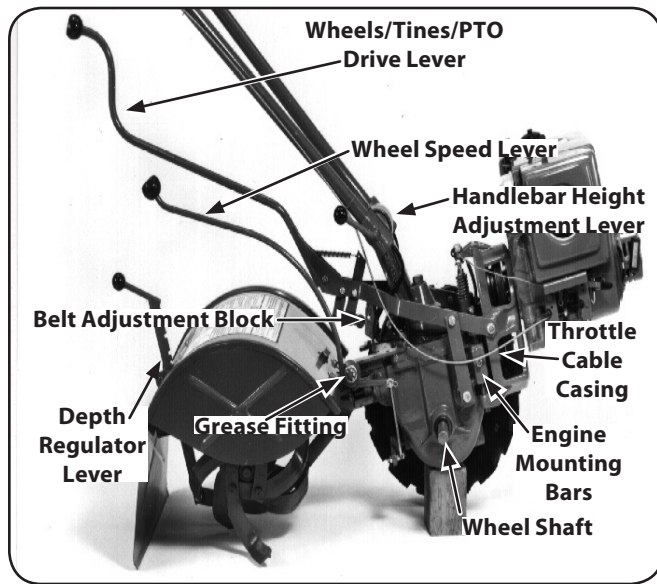

Figure 6-10

2. Oil all pivoting and connecting points on the Wheels/Tines/PTO Drive Lever and the Wheel Speed Lever. See Fig. 6-10.
3. Grease the face of the belt adjustment block. See Fig. 6-10.
4. Oil the Depth Regulator Lever, including the spring in the mounting bracket. See Fig. 6-10.
5. Oil the full length of the throttle cable casing. Oil threads on Handlebar Height Adjustment Lever. See Fig. 6-10.
6. Grease the left- and right-side engine mounting bars at the top, middle and bottom. See Fig. 6-10.
7. Grease the zerk grease fitting located on the pivot point at the end of the Wheel Speed Lever. See Fig. 6-10. If the Wheel Speed Lever has a grease fitting on the pivot assembly, apply 2-to-3 strokes of multipurpose grease at beginning and end of tilling season.

8. Keep the PTO access area well-greased. See Fig. 6-11. If the Tines/PTO Clutch Lever becomes hard to move, squirt some oil into its access hole, and work it back and forth to disperse the oil.



Figure 6-11

## Adjustments

### Drive Belt

On a new tiller (or if a new belt is installed), the belt tension will probably need to be adjusted after the first two (2) hours of operation. Thereafter, check the belt tension every ten (10) operating hours.

Maintaining the right tension is important to good tiller performance and long belt life. If too loose, the belt will slip on the pulleys, and be unable to deliver full power to the wheels and tines. A loose belt will also wear prematurely.

While checking the belt tension, also inspect the belt for cuts, cracks, deterioration, etc. Don't continue using a belt that isn't in good shape. You're sacrificing tiller performance by doing so.

Tips on keeping the drive belt in top condition include:

- Always put the Wheels/Tines/PTO Drive Lever in NEUTRAL when the tiller is not in use.
- Keep the tension adjusted correctly.
- Don't "speed shift" when moving the Wheels/Tines/PTO Drive Lever between FORWARD and REVERSE.



### How to Measure the Belt Tension

1. Before taking a measurement, be sure the linkages and pivot points on the Wheels/Tines/PTO Drive Lever are clean and lubricated. If there is any binding, you won't get true measurements. Also, you'll need the belt adjustment tool you received with your new tiller. See Fig. 6-12.

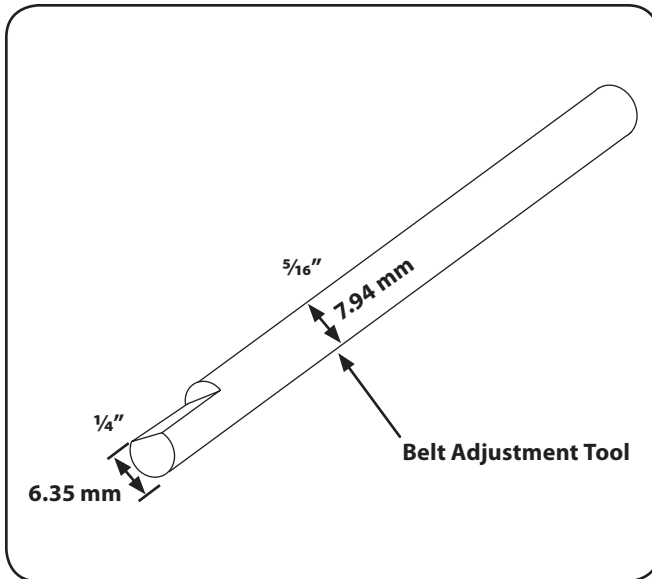

Figure 6-12

2. Move the Wheels/Tines/PTO Drive Lever fully down to the FORWARD position. The clutch roller at the bottom of the lever should be positioned underneath the belt adjustment block. See Fig. 6-13. Don't let the clutch roller move during the next few steps. If it moves, you'll get a false belt tension reading.

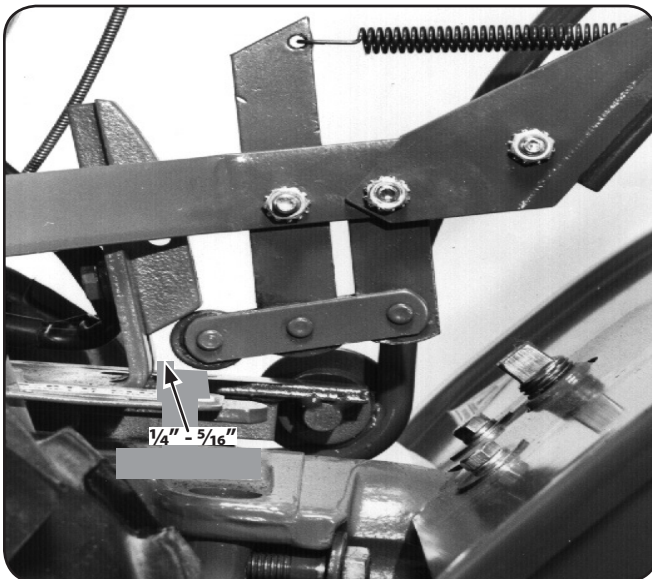

Figure 6-13

3. The belt tension is correct if the front of the clutch roller is  $\frac{1}{4}$ "-to- $\frac{5}{16}$ " away from the face of the upright bracket that holds the adjustment block in place. See Fig. 6-13. To measure this distance:

- a. Without moving the clutch roller, try inserting the  $\frac{1}{4}$ "-thick, slotted end of the belt adjustment tool in between the roller and the upright bracket. The flat edge of the tool must be facing the roller. See Fig. 6-14.

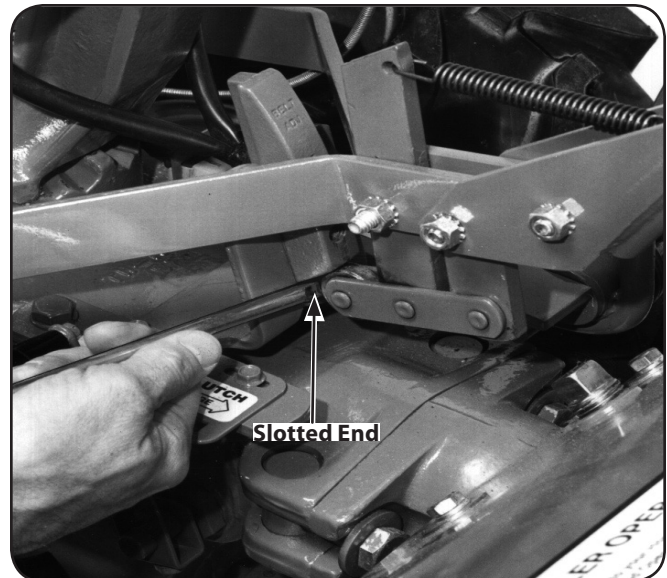

Figure 6-14

- b. If only the slotted portion of the tool will fit, the belt tension is correct.
  - c. If the slotted part of the tool will not fit in, the belt is too loose.
  - d. If the full thickness ( $\frac{5}{16}$ ") of the tool easily fits in, the belt is too tight.
4. If the belt tension is correct, move the Wheels/Tines/PTO Drive Lever back to NEUTRAL.

### How to Adjust the Belt Tension

1. As described in the following steps, the drive belt tension is adjusted by moving the adjustment block up or down. Moving it down will tighten the belt; moving it up loosens the belt.

**NOTE:** The distance the block moves approximately equals the distance the roller moves. In most cases, the clutch roller will not have been very far out of position, so the adjustment block will only need to be moved slightly (up or down).

2. Move the Wheels/Tines/PTO Drive Lever to NEUTRAL position. The clutch roller will come to rest anywhere on the face of the belt adjustment block, depending upon drive belt length and current belt tension adjustment.

3. Insert the belt adjustment tool through the hole in the side of the adjustment block, spacing the ends of the tool equally on both sides. See Fig. 6-15. Rotate the tool so the slotted end faces down.

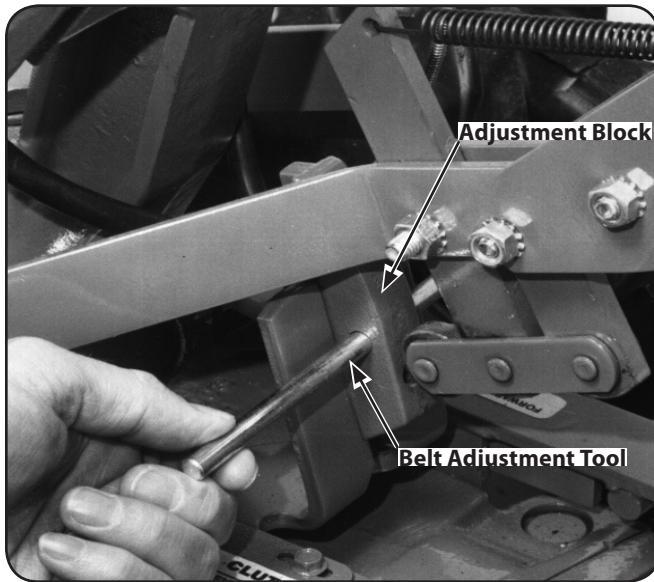

Figure 6-15

4. Place the Wheels/Tines/PTO Drive Lever in FORWARD position. The arms of the clutch control yoke will be resting on the belt adjustment tool and the clutch roller should be engaged slightly beneath the adjustment block. See Fig. 6-16.

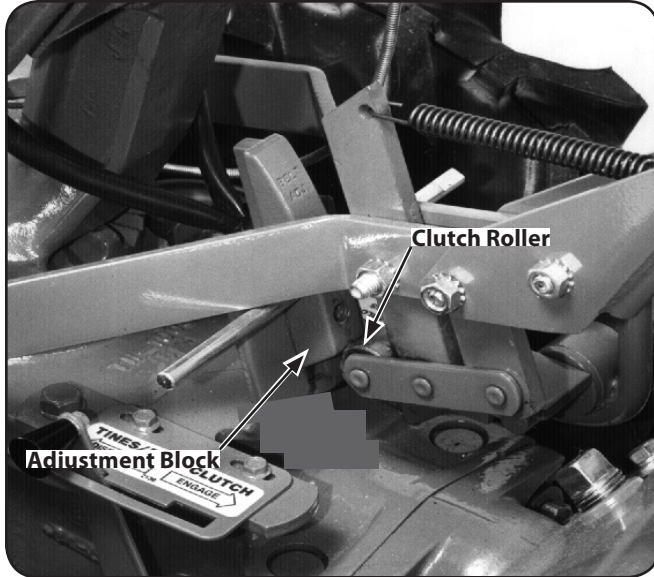

Figure 6-16

5. Use one hand to hold the drive lever in FORWARD while using a  $\frac{1}{16}$ " wrench to loosen — don't remove — the bolt at the back of the belt adjustment block. See Fig. 6-17. The adjustment block should be free to move either up or down.

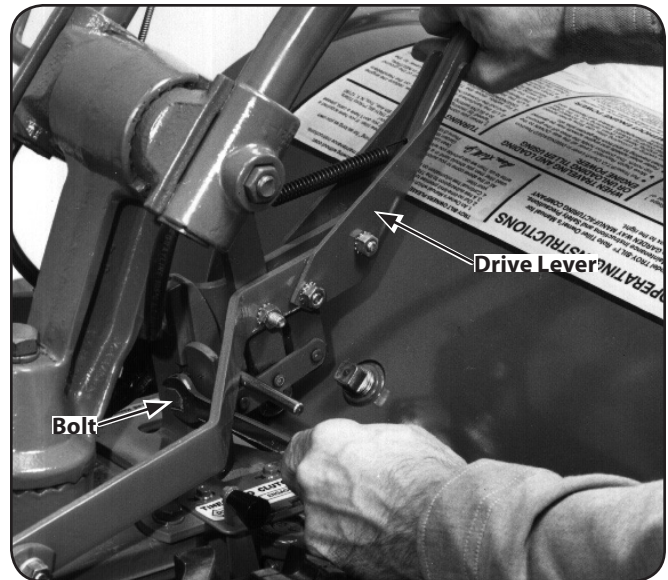

Figure 6-17

6. Push the drive lever down if the belt needs tightening. Pull the lever up if the belt needs to be loosened. Hold the drive lever in place and tighten the bolt in the adjustment block firmly.
7. Let go of the drive lever and remove the belt adjustment tool from the hole in the adjustment block.
8. Check the tension on the belt by following the previous instructions "How to Measure Belt Tension."

**NOTE:** If the adjustment block is all the way down and the measurement between the clutch roller and the bracket is less than  $\frac{1}{4}$ ", then a new drive belt is needed.

### Reverse Drive System

These instructions explain how to inspect and adjust the various reverse drive components.

But first, here's how the reverse drive system works. When you raise the Wheels/Tines/PTO Drive Lever up in REVERSE position, this lowers the rubberized reverse disc — it's attached to the engine drive pulley — until this rotating disc contacts the transmission drive pulley. The friction between the rotating reverse disc and the transmission pulley causes the transmission drive shaft to be powered in a counterclockwise direction — as viewed from the operator's position behind handlebars. The drive shaft then turns the wheels and tine shafts in a reverse direction.

The reverse disc is made of steel with a special, long-lasting rubber compound bonded to the disc rim. Since this is a wearing part, it should be inspected after every 30 operating hours.

1. Measure the width of the outside edge of the disc as shown in Fig. 6-18. Replace the disc before the rubber edge wears to a thickness of  $\frac{1}{8}$ " or less. Failure to do so could cause the steel underneath the rubber to damage the transmission pulley.

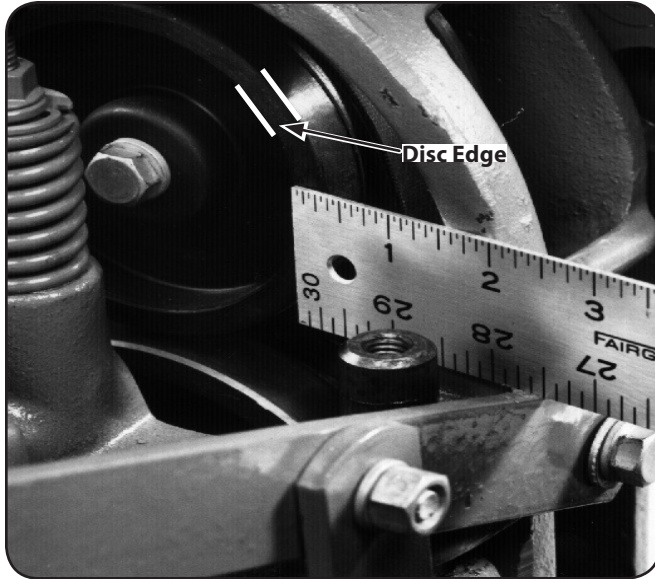

Figure 6-18

2. Look for big cracks or missing chunks of rubber from the disc. If so damaged, the disc should be replaced immediately. See the Service section of this manual for instructions on replacing the disc.

**NOTE:** Extend the life of the reverse disc by always pausing in NEUTRAL before shifting between FORWARD and REVERSE. Also, the reverse disc is not suited for continuous or sustained reverse operation. Use reverse sparingly.

#### Checking and Adjusting the Reverse Drive System

When the Wheels/Tines/PTO Drive Lever is moved up into REVERSE, the engine and engine mount move down to press on the reverse adjustment bolt. See Fig. 6-19.

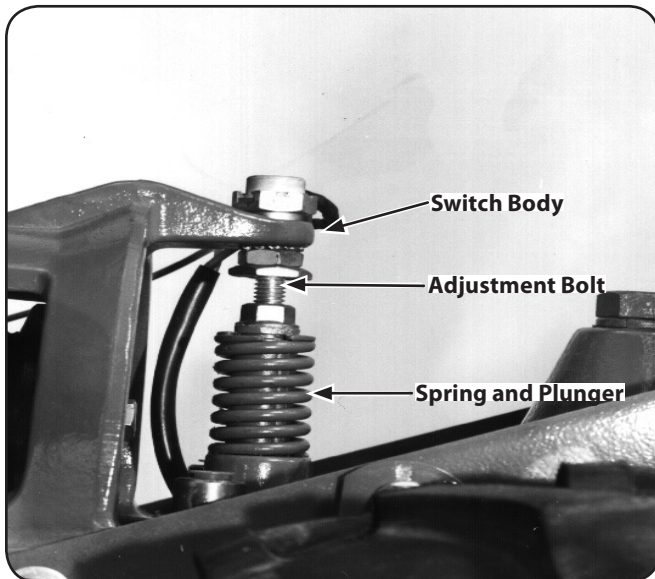

Figure 6-19

This action compresses the reverse spring and plunger assembly, requiring you to hold the lever up in REVERSE. When you release the lever, the spring automatically pushes the lever back into NEUTRAL position.

The spring and plunger assembly is designed to prevent the reverse disc from making contact with the transmission pulley until you shift into REVERSE. When the lever is in NEUTRAL, the switch body on the bottom of the engine mount tab should be resting squarely on top of the reverse adjustment bolt. See Fig. 6-19. The reverse adjustment bolt can be adjusted up or down to correct a number of reverse drive operating problems, as explained next.

#### Checking and Adjusting the Reverse Disc

1. Verify that the linkages for Wheels/Tines/PTO Drive Lever are lubricated with oil and engine mount bars and belt adjustment block are lubricated with grease. See Lubrication earlier in this section.
2. Place Wheels/Tines/PTO Drive Lever in NEUTRAL. Briefly pull out the engine recoil starter handle while watching the reverse disc. The disc should turn, but lower pulley should not. See Fig. 6-20. If the reverse disc turns the lower pulley, or if it is located closer than  $\frac{3}{16}$ " to the pulley, reverse adjustment bolt should be adjusted upward. Moving the adjustment bolt upward will also solve the problem of a tiller that goes into REVERSE on its own.

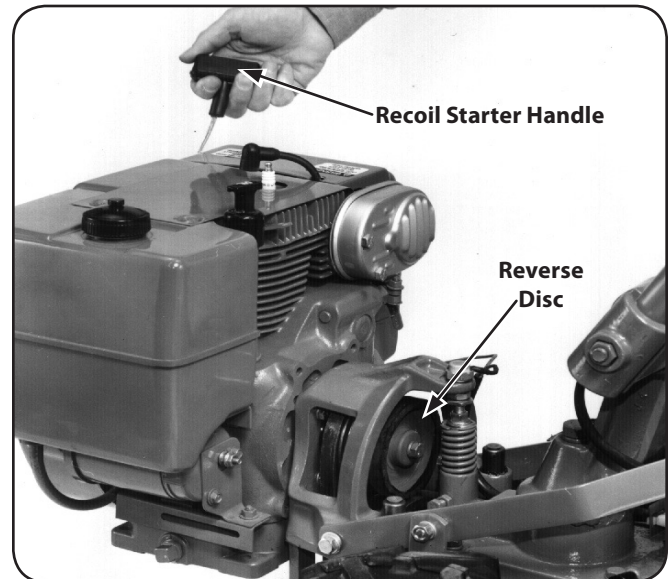
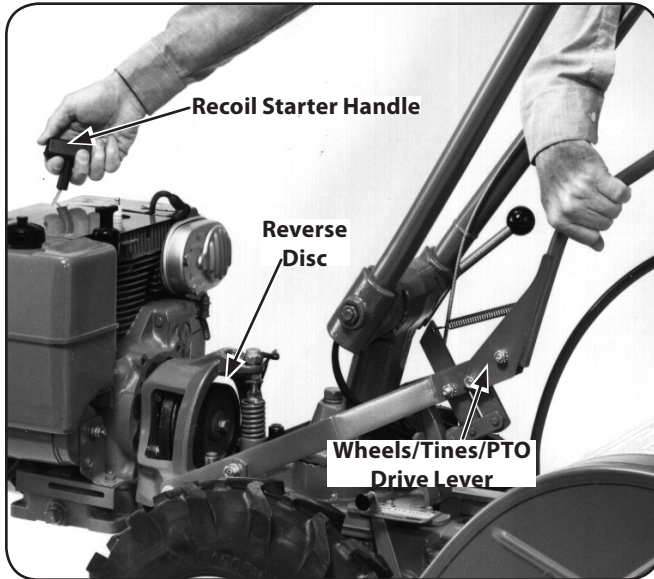

Figure 6-20

- Use your left hand to hold the Wheels/Tines/PTO Drive Lever up in REVERSE, while briefly pulling out the engine recoil starter. The reverse disc should turn the lower pulley. See Fig. 6-21. If not, or it requires a lot of pressure to hold the lever up in REVERSE, then the reverse adjustment bolt must be adjusted downward. When correctly adjusted, the Wheels/Tines/PTO Drive Lever should pop out of reverse when the lever is released, but not require exceptional effort to hold it up in the reverse position.

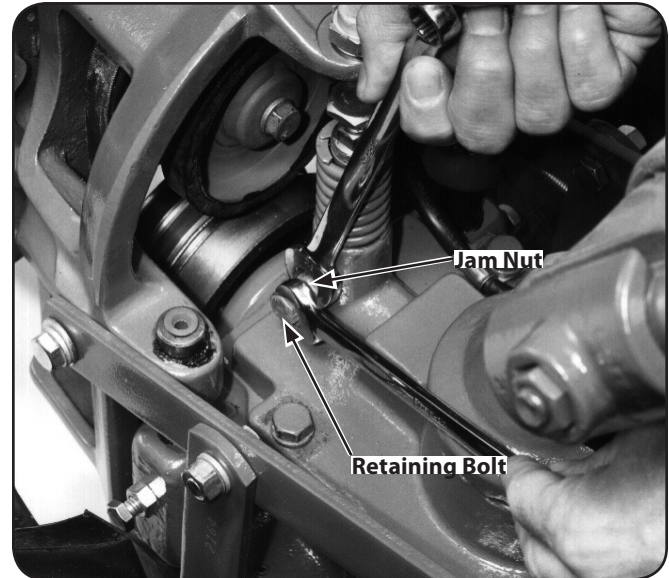

**Figure 6-21**

- Shift the Wheels/Tines/PTO Drive Lever to REVERSE and then let it go. The lever should return to NEUTRAL. If not, the reverse adjustment bolt will have to be adjusted upward.

### Adjusting the Reverse Drive:

- Place the Wheels/Tines/PTO Drive Lever in FORWARD position.
- On the left side of the tiller, put a  $\frac{1}{2}$ " wrench on the plunger retaining bolt and another  $\frac{1}{2}$ " wrench on the jam nut next to it. See Fig. 6-22.



**Figure 6-22**

- While holding the bolt steady, loosen the jam nut (counterclockwise) until it touches the bolt head.
- Turn the bolt in until it tightens against the plunger inside the spring. The bolt must be tight to prevent the plunger from turning — be careful not to overtighten and break the bolt.
- Place a  $\frac{7}{8}$ " wrench on the head of the reverse adjustment bolt and a  $\frac{9}{16}$ " wrench on the jam nut below it. See Fig 6-23. Hold the bolt steady while loosening the jam nut three or four turns.

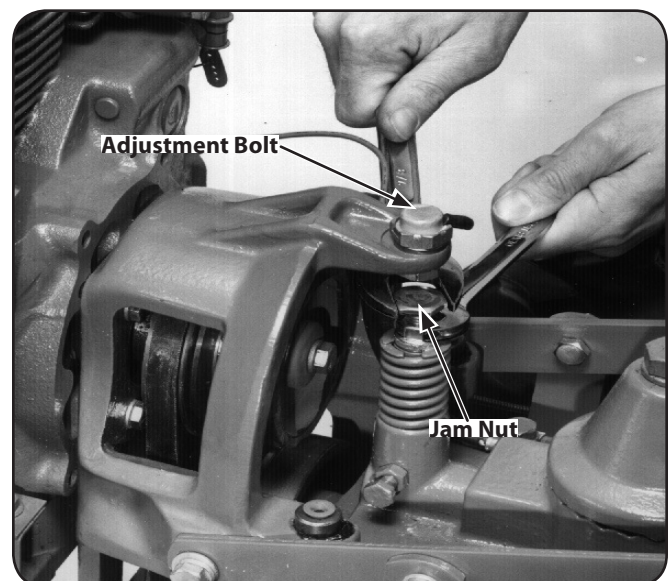

**Figure 6-23**

6. Move the Wheels/Tines/PTO Drive Lever to NEUTRAL. The switch body on the bottom of the engine mount tab should be resting squarely on top of the reverse adjustment bolt, and the reverse disc should be at least  $\frac{3}{16}$ " away from the transmission drive pulley. See Fig. 6-19. If the reverse disc is any closer than this, raise the reverse adjustment bolt (turn it counterclockwise).
7. Check that the reverse disc is at least  $\frac{3}{16}$ " away from the transmission drive pulley. Then hold the reverse adjustment bolt steady with one wrench while tightening the jam nut with a second wrench. See Fig. 6-23.
8. Place a chalk or pencil mark on the top edge of the plunger retaining bolt. Now, while watching the mark, loosen the bolt  $\frac{3}{4}$ -turn. See Fig. 6-24. Do not exceed a  $\frac{3}{4}$  turn. This would disengage the bolt from the locking groove in the side of the plunger.

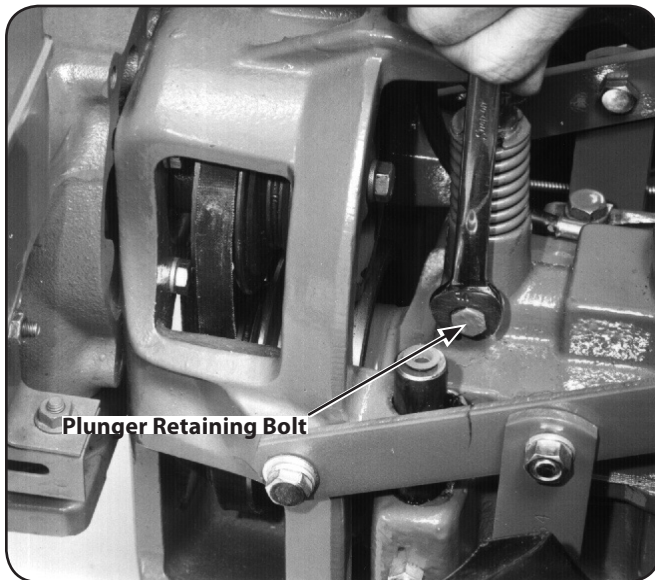

**Figure 6-24**

9. Hold the plunger retaining bolt steady with a wrench while tightening the jam nut against the side of the plunger housing. See Fig. 6-22.
10. Check the action of the reverse disc as explained previously.
 

**NOTE:** If the above adjustments have not corrected an improperly working reverse drive, contact an authorized dealer or the TROYBILT Technical Service Department for assistance.

### Throttle Cable

The throttle lever settings are factory adjusted, so unnecessary adjustments should not be made. However, if the engine does not start or stop, or respond immediately to various throttle lever settings, then adjustments may be necessary. Please refer to the Engine Operator's Manual supplied with your tiller for specific adjustment instructions.

### Ignition System

Your engine is equipped with an electronic ignition. It does not have a condenser or points, so there is no need to perform any regular tune-up maintenance on this system other than adjusting or replacing the spark plug.

### Spark Plug

1. The spark plug must be in good condition for proper engine operation. Remove and inspect the plug every 50 operating hours or annually, whichever occurs first. The correct electrode gap is .030". Check the gap with a feeler gauge. Do not use a spark plug if the porcelain is cracked, the electrodes are pitted or burned, or if other visible damage is present.

**NOTE:** Do not wire brush or sandblast the spark plug to clean it — loose particles can enter the engine, causing damage. To replace the plug, first tighten it securely by hand, then use a spark plug wrench to tighten the plug an extra  $\frac{1}{4}$  turn.

### Off-Season Storage

When your tiller will not be used during the off-season, prepare it for storage with the following steps:

1. Clean the tiller and the engine.
2. Do routine tiller lubrication and check for loose hardware.
3. Protect the engine from deterioration or damage by referring to the engine storage instructions in your engine manual literature.
4. When engine is still warm, drain oil from engine crankcase. Refill with fresh motor oil.
5. Protect the internal cylinder against rust by removing the spark plug and pouring one ounce of clean engine oil into spark plug hole. Then slowly pull out the recoil start rope 2 or 3 times to distribute the oil internally. Replace spark plug, but do not reconnect the plug wire. Pull the rope until resistance is felt — let rope rewind.
6. Charge the battery (electric start option). Store the battery in cool, dry location.
7. Move the Wheels/Tines/PTO Drive Lever to NEUTRAL position. Keep the tiller in a clean, dry area.
8. Never store the tiller with fuel in the fuel tank in an enclosed area where gas fumes could reach an open flame or spark, or where ignition sources are present (space heaters, hot water heaters, furnaces, etc.).

## Belt Replacement

### Drive Belt

1. Move the Wheels/Tines/PTO Drive Lever to NEUTRAL position.
2. While kneeling on the right side of the tiller, create slack in the belt by reaching over to the left side of the pulleys and pushing in on the center of the belt with your finger.
3. Use your right hand to move the belt down and away from the lower pulley, in the direction of the engine. See Fig. 7-1.

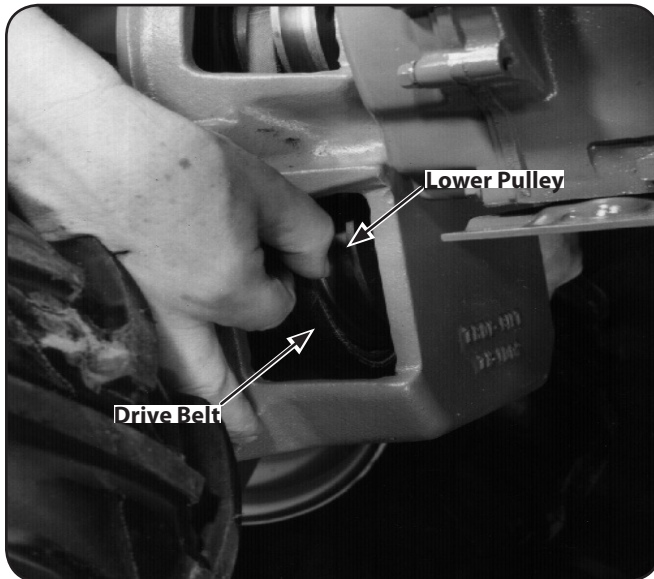

**Figure 7-1**

4. Push the belt upward to create slack in the belt. See Fig. 7-2.

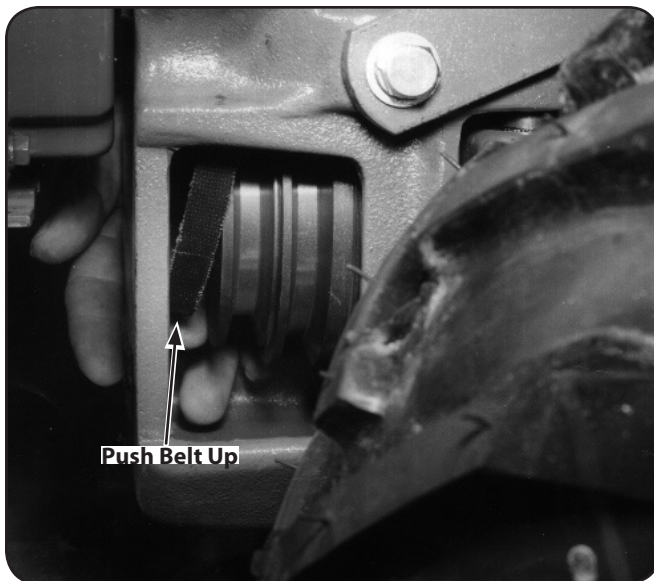

**Figure 7-2**

5. Lift the top half of the belt up and over the upper pulley and the rubber reverse disc, moving it in front of the reverse disc. See Fig. 7-3.

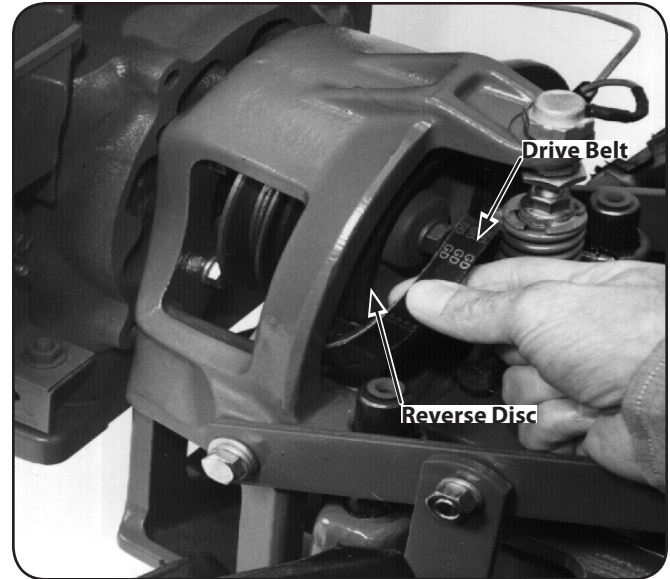

**Figure 7-3**

6. Push the Wheels/Tines/PTO Drive Lever down into the FORWARD position. This increases the distance between the upper and lower pulleys. Next, lift and pull the entire belt out from between the pulleys. See Fig. 7-4.

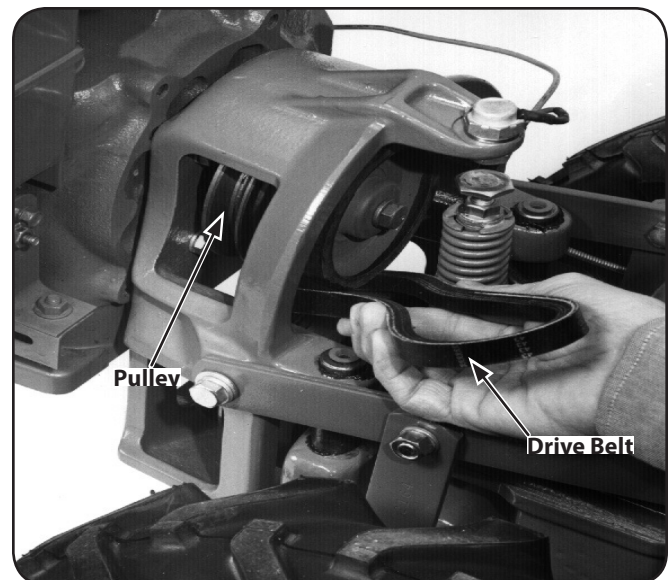

**Figure 7-4**

7. Place the Wheels/Tines/PTO Drive Lever in FORWARD position.
8. Squeeze the belt in the middle and insert one end in between the pulleys. See Fig. 7-4.

9. Push the belt forward then down until it is looped over the lower pulley. See Fig. 7-2. Do not yet seat it in either of the lower pulley's grooves.  
**NOTE:** A blunt object, like a ruler, can help you push the belt downward if needed.
10. Move the top half of the belt up and over the rubber reverse disc, but do not seat it in either of the grooves in the top pulley.
11. Place the Wheels/Tines/PTO Drive Lever in NEUTRAL.
12. Move the top half of the belt into the HIGH Range groove, the groove closest to the engine, on the top pulley. See Fig. 7-5.

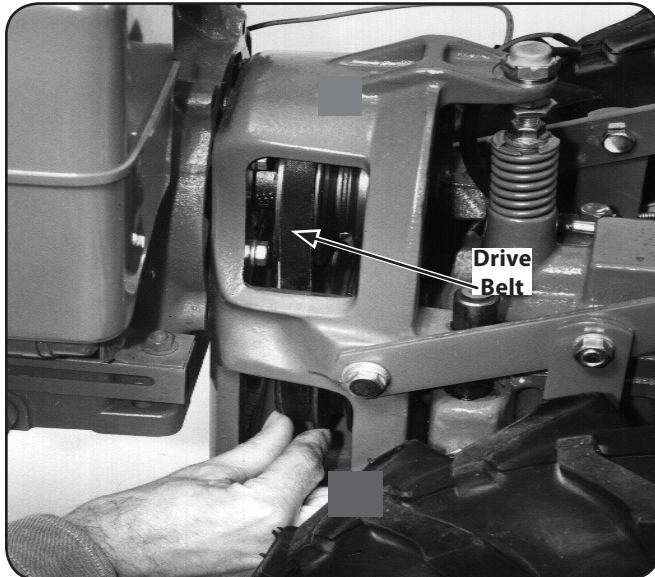

Figure 7-5

13. Move the bottom half of the belt into the HIGH Range groove of the lower pulley. If extra slack is needed, hold up Wheels/Tines/PTO Drive Lever while moving the belt. Verify the belt is seated properly on the pulleys.
14. To move the belt to the Low Range position. See Changing Belt Speed in the Operation Section.
15. After installing the belt, check and adjust for correct belt tension as explained previously.

## Reverse Disc

Follow these steps to replace the reverse disc. If your tiller has a Bumper Attachment mounted, it must be removed first.

1. Move Wheels/Tines/PTO Drive Lever in NEUTRAL position.
2. Wedge a  $\frac{5}{16}$ "-thick board between the top of the engine pulley and the cast iron housing next to it. This immobilizes the pulley. Avoid contacting the reverse disc.

3. Use a  $\frac{1}{16}$ " wrench to loosen the mounting bolt shown in Fig. 7-6. Remember to immobilize the pulley with the wood wedge while loosening the bolt. If necessary, pry the disc from the pulley with the tip of a screwdriver. Back the bolt out as far as possible. Then angle the disc a little to remove it. Bring the bolt and lockwasher along with the disc. Installing a new Reverse Disc.

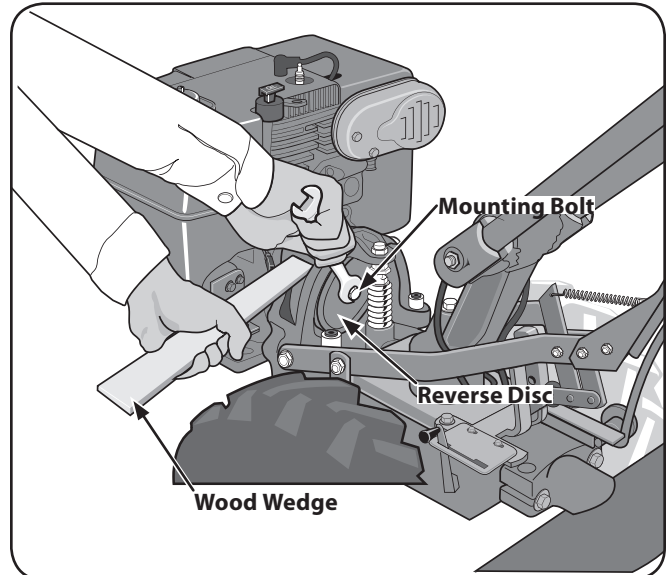

Figure 7-6

4. Do steps 1-through-3, in the opposite order to install the new reverse disc.
5. Tighten the mounting bolt securely, and check for correct operation — see the Maintenance & Adjustments section.

## Tines

Inspect the tines for wear or damage after every 30 operating hours. The rate of wear depends upon the hours of use and soil conditions. With use, the tines get shorter, narrower and more pointed. See Fig. 7-7.

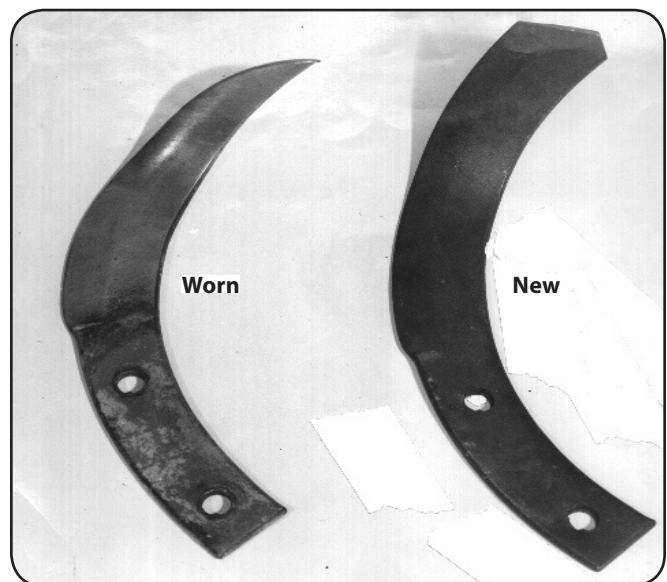

Figure 7-7

If badly worn, they lose the ability to till deeply. Worn tines leave an ever-increasing gap in the middle of a tilled row. The normal gap is 3" between the tine tips — replace the tines when the gap widens to 5". See Fig. 7-8. The tines can be replaced individually or as a complete set.

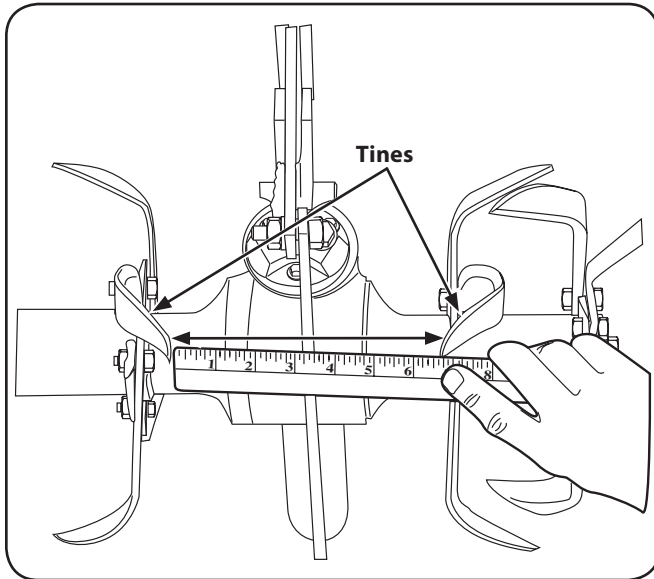

Figure 7-8

### Replacing a Single Tine



**WARNING!** The tines or tine hooded edges may be sharp. Wear thick gloves to protect your hands from cuts or scrapes.



**WARNING!** Wear safety goggles to protect your eyes. When loosening hardware, do not hit a wrench with a metal tool. This could shatter the tool or wrench sending metal particles into your eyes.

1. Move the Wheels/Tines/PTO Drive Lever to NEUTRAL, the Wheel Speed Lever to either FAST or SLOW position, and the Tines/PTO Clutch Lever to ENGAGE.
2. Gently tilt the tiller forward until the engine rests on the ground.
3. Raise the hood flap at the back of the tiller and tie it up with string.
4. Before removing a tine, note in which direction the bent tip points. The new tine must be installed in the same direction.

5. Use two  $\frac{9}{16}$ " wrenches to remove the two bolts and nuts securing the tine to the tine holder plate. See Fig. 7-9. Use penetrating oil on the hardware if it is rusted or hard to remove.

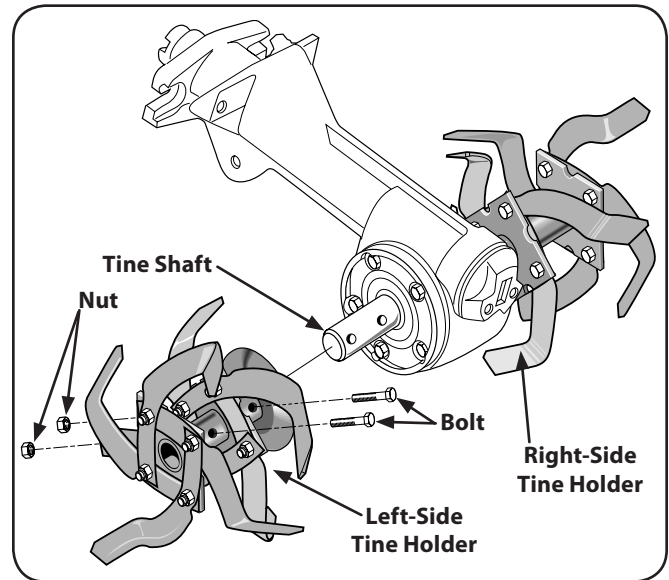

Figure 7-9

6. Mount the new tine exactly the way the old tine was positioned. (The sharp edge of the tine, which enters the soil first, must face forward when above the tine shaft.) Replace the bolts and nuts and tighten them securely.

### Replacing A Tine Holder Assembly

The 16 Bolo Tines are mounted eight per side on left-side and right-side tine holders. Here's how to replace the tines and holders as assemblies.



1. Follow steps 1-3 in Single Tine Replacement above.
2. Identify the tine holders as left-side and right-side holders — they must be replaced on the same side from which they were removed. Use a piece of chalk or a grease pencil to mark them L and R.
3. Remove the two bolts and nuts securing each holder. See Fig. 7-9.
4. Use a soft mallet to drive the holder off the tine shaft. Use a heavy hammer and block of wood to knock off the immobilized tine holder.
5. When the holder is off, clean all dirt and debris from the shaft and the holder. Apply fresh grease to the tine shaft.

### Replacing Tines Holder Assembly

1. Replace the holder so the sharp tine edges face forward (toward the front of the tiller). Tap tine holder back on the tine shaft.
2. Grease the threads on the mounting bolt(s). Install and tighten the bolt(s) securely.

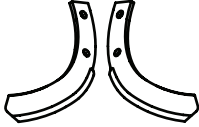
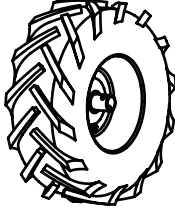
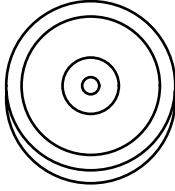

Problem	Cause	Remedy
Wheels and tines do not turn	<ol style="list-style-type: none"> <li>1. Mis-adjusted drive belt and/or reverse disc</li> <li>2. Loose bolt on transmission drive pulley</li> <li>3. Worn worm gears</li> </ol>	<ol style="list-style-type: none"> <li>1. See Maintenance &amp; Adjustments Section</li> <li>2. Tighten bolt</li> <li>3. See authorized service dealer</li> </ol>
Wheels and tines turn on top of ground, but stop or hesitate in soil	<ol style="list-style-type: none"> <li>1. Loose drive belt</li> <li>2. Loose bolt on transmission drive pulley</li> </ol>	<ol style="list-style-type: none"> <li>1. Adjust drive belt (See Maintenance &amp; Adjustments Section)</li> <li>2. Tighten bolt</li> </ol>
Wheels turn, but tines do not	<ol style="list-style-type: none"> <li>1. Tines/PTO clutch lever not engage</li> <li>2. Tines/PTO clutch lever out of adjustment</li> <li>3. Dog clutch key missing</li> <li>4. Worn worm gears</li> <li>5. Missing or broken tines or tine hardware</li> </ol>	<ol style="list-style-type: none"> <li>1. Engage lever</li> <li>2. See Maintenance &amp; Adjustments Section</li> <li>3. Contact authorized service dealer</li> <li>4. Contact authorized service dealer</li> <li>5. See Service Section</li> </ol>
Tines turn, but wheels do not	<ol style="list-style-type: none"> <li>1. Missing Hi-Pro key inside wheel clutch</li> <li>2. Worn gears</li> <li>3. Drive dogs on wheel clutch worn out or broken</li> </ol>	<ol style="list-style-type: none"> <li>1. Contact authorized service dealer</li> <li>2. Contact authorized service dealer</li> <li>3. Contact authorized service dealer</li> </ol>
Wheels/Tines/PTO Lever does not stay in forward	<ol style="list-style-type: none"> <li>1. Drive belt too tight</li> <li>2. Clutch Pawl spring overstretched</li> </ol>	<ol style="list-style-type: none"> <li>1. See Maintenance &amp; Adjustments Section</li> <li>2. Replace spring</li> </ol>
Wheels/Tines/PTO Lever hard to shift into reverse	<ol style="list-style-type: none"> <li>1. Worn reverse disc</li> <li>2. Motor mount bars sticking</li> </ol>	<ol style="list-style-type: none"> <li>1. Replace reverse disc</li> <li>2. Lubricate mount bars</li> </ol>
Tiller stays in reverse or forward when Wheels/Tines/PTO Lever is released or lever is hard to shift	<ol style="list-style-type: none"> <li>1. Motor mount bars sticking</li> </ol>	<ol style="list-style-type: none"> <li>1. Lubricate motor mount bars</li> </ol>
Wheel Speed Lever is hard to shift	<ol style="list-style-type: none"> <li>1. Eccentric lever is sticking</li> <li>2. Clutch inside transmission binding</li> </ol>	<ol style="list-style-type: none"> <li>1. Lubricate the eccentric lever and linkage to wheel speed lever</li> <li>2. Contact authorized service dealer</li> </ol>
Wheel Speed Lever shifts into FAST gear, but not SLOW	<ol style="list-style-type: none"> <li>1. Connecting rod at back of lever backwards or bent in towards transmission and hitting it</li> <li>2. Clutch inside transmission binding</li> </ol>	<ol style="list-style-type: none"> <li>1. Straighten or replace linkage</li> <li>2. Contact authorized service dealer</li> </ol>
Wheel Speed Lever moves freely, but does not change gears	<ol style="list-style-type: none"> <li>1. Broken or worn eccentric shifting pin</li> </ol>	<ol style="list-style-type: none"> <li>1. Contact authorized service dealer</li> </ol>
Tiller jumps while tilling	<ol style="list-style-type: none"> <li>1. Depth Regulator Lever is too deep for soil conditions</li> </ol>	<ol style="list-style-type: none"> <li>1. Use a shallower setting</li> </ol>
Depth Regulator Lever difficult to move	<ol style="list-style-type: none"> <li>1. Depth Regulator Lever bent</li> <li>2. Depth Regulator Lever sticking</li> </ol>	<ol style="list-style-type: none"> <li>1. Straighten lever</li> <li>2. Lubricate lever</li> </ol>

Component	Part Number and Description
	GW-9245      V-Belt
	742-04223      Bolo Tine (LH), 12" 742-04224      Bolo Tine (RH), 12"
	934-04231      Wheel, 16 x 4.6 x 8
	756-04171      Reverse Disc
	1909286P      Throttle Cable

Phone (800) 800-7310 to order replacement parts or a complete Parts Manual (have your full model number and serial number ready).  
 Parts Manual downloads are also available free of charge at [www.mtdproducts.com](http://www.mtdproducts.com).

---

---

---

---

---

---

---

---

---

---

---

---

---

---

---

---

---

---

---

---

---

---

---

---

---

# MANUFACTURER'S LIMITED WARRANTY FOR



The limited warranty set forth below is given by Troy-Bilt LLC with respect to new merchandise purchased and used in the United States and/or its territories and possessions, and by MTD Products Limited with respect to new merchandise purchased and used in Canada and/or its territories and possessions (either entity respectively, "Troy-Bilt").

"Troy-Bilt" warrants this product (excluding its *Belts, Transmission and Attachments* as described below) against defects in material and workmanship for a period of two (2) years commencing on the date of original purchase and will, at its option, repair or replace, free of charge, any part found to be defective in materials or workmanship. This limited warranty shall only apply if this product has been operated and maintained in accordance with the Operator's Manual furnished with the product, and has not been subject to misuse, abuse, commercial use, neglect, accident, improper maintenance, alteration, vandalism, theft, fire, water, or damage because of other peril or natural disaster. Damage resulting from the installation or use of any part, accessory or attachment not approved by Troy-Bilt for use with the product(s) covered by this manual will void your warranty as to any resulting damage.

*Belts* are warranted to be free from defects in material and workmanship for a period of thirty (30) days from the date of purchase.

*Transmission* — Troy-Bilt warrants the transmission (including all gears, shafts and housings) against defects in material and workmanship for the life of the tiller, to the original purchaser only, commencing on the date of original purchase or lease.

*Attachments* — Troy-Bilt warrants attachments for this product against defects in material and workmanship for a period of one (1) year, commencing on the date of the attachment's original purchase or lease. Attachments include, but are not limited to items such as: grass collectors and mulch kits.

**HOW TO OBTAIN SERVICE:** Warranty service is available, WITH PROOF OF PURCHASE, through your local authorized service dealer. To locate the dealer in your area:

## **In the U.S.A.**

Check your Yellow Pages, or contact Troy-Bilt LLC at P.O. Box 361131, Cleveland, Ohio 44136-0019, or call 1-866-840-6483, 1-330-558-7220 or log on to our Web site at [www.troybilt.com](http://www.troybilt.com).

## **In Canada**

Contact MTD Products Limited, Kitchener, ON N2G 4J1, or call 1-800-668-1238 or log on to our Web site at [www.mtdcanada.com](http://www.mtdcanada.com).

This limited warranty does **not** provide coverage in the following cases:

- a. The engine or component parts thereof. These items may carry a separate manufacturer's warranty. Refer to applicable manufacturer's warranty for terms and conditions.

- b. Log splitter pumps, valves, and cylinders have a separate one-year warranty.
- c. Routine maintenance items such as lubricants, filters, blade sharpening, tune-ups, brake adjustments, clutch adjustments, deck adjustments, and normal deterioration of the exterior finish due to use or exposure.
- d. Service completed by someone other than an authorized service dealer.
- e. Troy-Bilt does not extend any warranty for products sold or exported outside of the United States and/or Canada, and their respective possessions and territories, except those sold through Troy-Bilt's authorized channels of export distribution.
- f. Replacement parts that are not genuine Troy-Bilt parts.
- g. Transportation charges and service calls.
- h. Troy-Bilt does not warrant this product for commercial use.

**No implied warranty, including any implied warranty of merchantability or fitness for a particular purpose, applies after the applicable period of express written warranty above as to the parts as identified. No other express warranty, whether written or oral, except as mentioned above, given by any person or entity, including a dealer or retailer, with respect to any product, shall bind Troy-Bilt. During the period of the warranty, the exclusive remedy is repair or replacement of the product as set forth above.**

**The provisions as set forth in this warranty provide the sole and exclusive remedy arising from the sale. Troy-Bilt shall not be liable for incidental or consequential loss or damage including, without limitation, expenses incurred for substitute or replacement lawn care services or for rental expenses to temporarily replace a warranted product.**

Some states do not allow the exclusion or limitation of incidental or consequential damages, or limitations on how long an implied warranty lasts, so the above exclusions or limitations may not apply to you.

In no event shall recovery of any kind be greater than the amount of the purchase price of the product sold. **Alteration of safety features of the product shall void this warranty.** You assume the risk and liability for loss, damage, or injury to you and your property and/or to others and their property arising out of the misuse or inability to use the product.

This limited warranty shall not extend to anyone other than the original purchaser or to the person for whom it was purchased as a gift.

**HOW STATE LAW RELATES TO THIS WARRANTY:** This limited warranty gives you specific legal rights, and you may also have other rights which vary from state to state.

**IMPORTANT:** Owner must present Original Proof of Purchase to obtain warranty coverage.

**Troy-Bilt LLC, P.O. BOX 361131 CLEVELAND, OHIO 44136-0019; Phone: 1-866-840-6483, 1-330-558-7220  
MTD Canada Limited - KITCHENER, ON N2G 4J1; Phone 1-800-668-1238**