

# Blood Pressure Monitor DB85 Instruction Manual

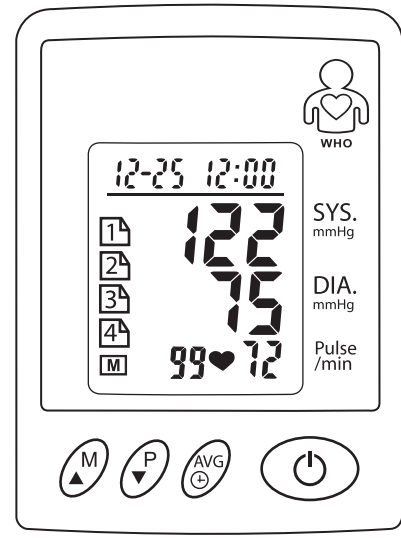

## SAFETY PRECAUTIONS

- Babies, young children or individuals who cannot express their consent are not suitable to take blood pressure measurement.
- Individuals with serious arteriosclerosis are not suitable to take blood pressure measurement.
- Blood pressure readings may change in case of pregnancy. Pregnant women can consult their doctor before taking measurement.
- Self-measurement is not medical treatment. If there are unusual values, please consult your doctor.
- Handling batteries properly:
  - As soon as old batteries run out, replace with new batteries.
  - Do not use old and new batteries together.
  - Align the polarities of batteries correctly.
  - When the unit will not be used for more than 3 months, remove the batteries. Otherwise, batteries may leak and cause damage to the unit.
- Handling AC adapter properly:
  - Never unplug the power cord with wet hands.
  - Use only the original AC adapter designed for this unit.

This device complies with part 15 of the FCC Rules. Operation is subject to the following two conditions: (1) This device may not cause harmful interference, and (2) this device must accept any interference received, including interference that may cause undesired operation.

### Setup Procedures

**Installation**  
Prior to first use, Download and install "TRULY" application to your iOS device. (Bluetooth 4.0 capabilities, e.g. iPhone 4S, iPhone 5, NewiPad and iPadMini).

## QUICK START GUIDE

Avoid smoking, eating or exercising for 30 minutes before taking measurement

- Sit upright in a chair with your both feet on the floor.
- Remove tight fitting clothing from your upper arm and thick clothing.
- Pull on the end of the cuff until it wraps securely around your upper arm. Place your arm on a table so that the cuff will be at the same level as your heart.
- Connect iOS device via Bluetooth (Turn Bluetooth "On" under the "Settings" menu on the iOS device).
- Open "TRULY" application, and then press the Blood Pressure icon on Measure screen.
- Press the "ON" button. The cuff will automatically inflate and the measurement will start.
- When the measurement is complete, the cuff will automatically deflate and your systolic and diastolic pressure values and pulse rate will display on Blood Pressure monitor & save on iOS application screen.

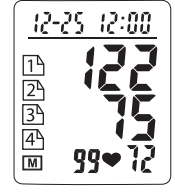

- After that check the measurement history on History screen or chart screen by iOS application.

## OVERVIEW

### Monitor

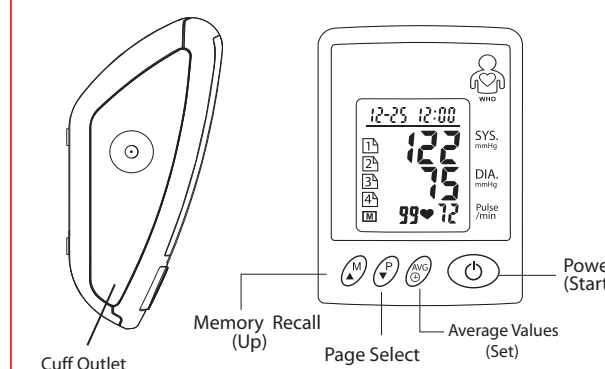

### Features

- Bluetooth 4.0 compatible
- One Touch Operation
- Irregular Heartbeat Detector
- Blood Pressure Mode and Clock Mode
- 4 User / 396 Total Memory
- 4 Alarm Clock Settings
- 5 Mode Averaging Function - Hour, Day, Week, Month, and Overall
- WHO Blood Pressure Indicator
- Auto-off Power Saving Feature
- Operated by 4 AA batteries (AC Adapter optional)

### Display

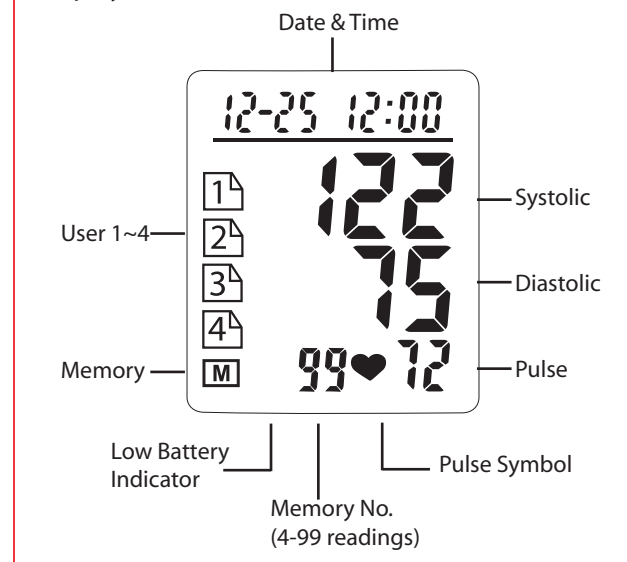

### Package Contents

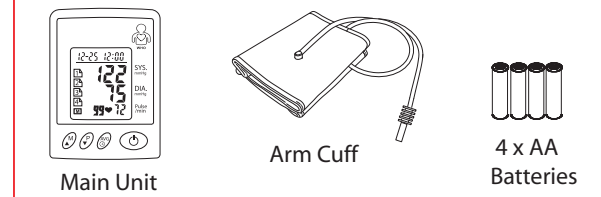

## PREPARATION

### 2.1 Battery Installation

- Pull and lift on the lock to remove the battery cover.
- Insert 4 AA batteries with the polarities in correct direction.
- Replace the battery cover. Press it lightly until the lock securely clicks into place.

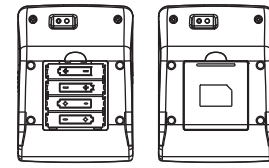

Note: Replace batteries when the battery indicator "L" shows low voltage.

### 2.2 Date & Time Setting

- Note:
- Set the correct date and time before taking a measurement.
  - Date and time should be reset after replacing new batteries.
- Press and hold the "AVG" button for a few seconds until the Year display flashes.
  - Press the "M" or "P" button to select the current year.
  - Press the "AVG" button to confirm Year Setting.
  - Follow the same steps to set the Month, Date, Hour and Minute.

### 2.3 Date & Time Setting

- Note:
- Set the correct date and time before taking a measurement.
  - Date and time should be reset after replacing new batteries.

- Press and hold the "AVG" button for a few seconds until the Year display flashes.
- Press the "M" or "P" button to select the current year.
- Press the "AVG" button to confirm Year Setting.
- Follow the same steps to set the Month, Date, Hour and Minute.

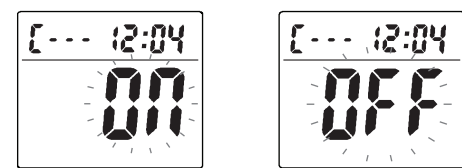

- You can choose Clock Function "ON" or "OFF" while the monitor is not in use. Press "M" or "P" button to select. Press the "AVG" button to confirm.

Note: If you select Clock Function "ON", you will continue at the Alarm Setting section. Otherwise, setting will end.

### 2.4 Alarm Setting

- Note:
- You will not be able to set alarm clock if Clock Function is set to "OFF".
  - You can set a maximum of 4 alarms.

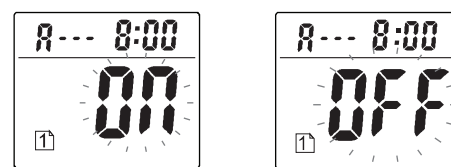

- To disable Alarm, Press the "M" or "P" button to select "OFF" and press the "AVG" button to confirm.
- To set 1st Alarm, Press the "M" or "P" button to select "ON". Press the "AVG" button to confirm.
- When Hour digit flashes, press the "M" or "P" button to select Hour. Press the "AVG" button to confirm.
- When Minute digit flashes, press the "M" or "P" button to select Minute. Press the "AVG" button to confirm.
- Follow the same steps to set the 2nd, 3rd, and 4th Alarm.

- Note:
- Press the "ON" button anytime during clock setting/ alarm setting to start over if an error occurs.
  - Each alarm clock lasts 45 seconds, or you can turn it off by pressing the "ON" button.

### 2.5 Language Setting

When a measurement is completed, DB85 will read aloud the systolic value, diastolic value and pulse automatically. The default language is English.

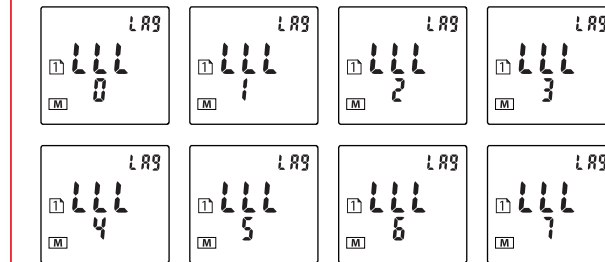

- Press and hold the "MEMO" button until the screen displays (LLL) (x = 0 ~ 7), then release the button.
- Press the "MEMO" button to select language. Number 0 ~ 7 represents the following languages:
  - Mute
  - English
  - German
  - Russian
  - Polish
  - Czech
  - Turkish
  - Chinese
- Press the "ON" button to confirm the selection and begin measurement.

## TAKING MEASUREMENT

- Note:
- Avoid smoking, eating or exercising for 30 minutes before taking measurement.
  - Do not move or talk during measurement.
  - Measurement can be taken on either arm.

### 3.1 Sitting Correctly

- Relax
- Sit upright in a chair with your both feet on the floor.
- Remove tight fitting clothing from your upper arm and thick clothing. Do not roll up your sleeve if it is too tight.
- Place your arm on a table so that the cuff will be at the same level as your heart.



### 3.2 Applying the Arm Cuff

- Place your elbow on a table and palm facing upward, and wrap the arm cuff around the upper left arm.
- Pull on the end of the cuff until it wraps securely around your upper arm. Do not over tighten the cuff. Allow 1-2 cm or 1/2 inch between the bottom of the cuff and your elbow joint.
- Make sure the cuff is at the same level as your heart.

### 3.3 Taking Measurement

- Press the "ON" button. The cuff will automatically inflate and the measurement will start.
- When the measurement is complete, the cuff will automatically deflate and your systolic and diastolic pressure values and pulse rate will display.
- Remove the arm cuff and take note of your measurement results.

Note: You can press the "ON" button to stop measurement at any time.

### 3.4 Heartbeat Readings

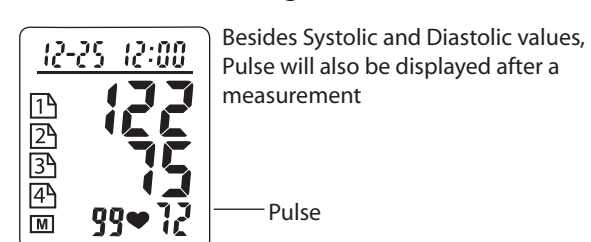

Besides Systolic and Diastolic values, Pulse will also be displayed after a measurement

### Irregular Heartbeat

This unit has a unique feature that alerts user of irregular heartbeat detection during measurement.

Note: An irregular heartbeat is defined as a heartbeat rhythm that has a variation of more than 25% from the average rhythm detected during measurement.

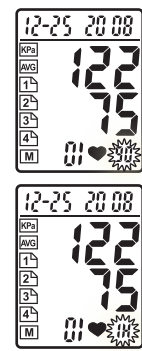

If such irregular rhythm occurs twice or more during the same measurement, the display screen will show the pulse value and "IH" symbol alternately. Example: (90 / IH)

Note: Please consult your doctor if irregular heartbeat occurs often.

### Regular but Below Normal Heartbeat

If the monitor detects a pulse rate below 60 beats per minute during measurement, the monitor will display the pulse value and "LO" symbol alternately. Example: (58 / LO)

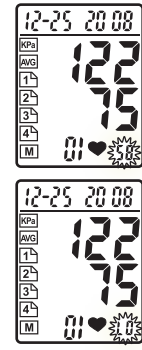

### Regular but Above Normal Heartbeat

If the monitor detects a pulse rate above 100 beats per minute during measurement, the monitor will display the pulse value and "HI" symbol alternately. Example: (102 / HI)

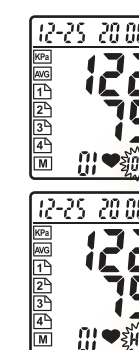

### 3.5 WHO Light Indicator

This unit features a 6-color LED light indicator to display blood pressure level in accordance with the WHO (World Health Organization) classification.

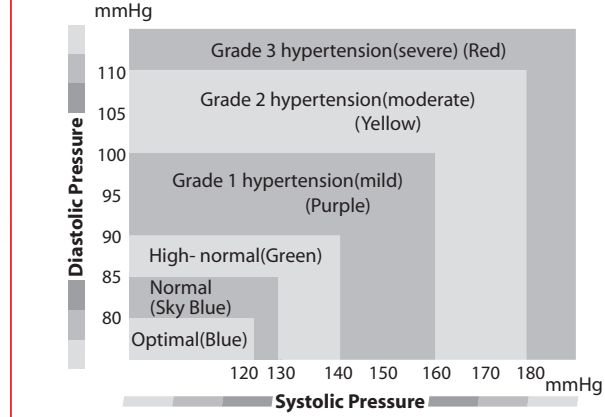

WHO Classification	Color
Optimal	Blue
Normal	Sky Blue
High-normal	Green
Mild hypertension	Purple
Moderate hypertension	Yellow
Severe hypertension	Red

Example: If your measurement reading is 122/75, the LED light will display the color in blue.

## MEMORY FUNCTIONS

After measurement, the last set of measured values will be saved automatically after measurement when the unit is turned off by pressing "ON" button or by automatic power off after 3 minutes.

### 4.1 View Past Readings

- Press the "M" button to enter memory function.
- If the User Page is not what you want to view, press the "P" button to select.
- Press the "M" button to display the next sets of values. Past readings are displayed from the most recent to the oldest.
- This can store up to 99 sets of past readings for each user (4 x 99).

### 4.2 View Average Readings

- Press the "AVG" button to enter Average function.
- If the User Page is not what you want to view, press the "P" button to select.
- Press the "AVG" button to view different Average Values. 5 different Average Values are available:

Symbol on Display	Average Values of
1 h	One Hour
1 d	One Day
7 d	One Week
30 d	One Month
ALL	All Readings

### 4.3 Delete Past Readings

User can delete all the past readings stored in each User Page.

- Press the "P" button to select the User Page you want to delete.
- Press and hold the "M" & "P" button simultaneously for 5 seconds. Symbol of "ALL EE" will be displayed and all past readings stored in that User Page will be deleted.

## TROUBLESHOOTING

Problem	Cause	Solution
No display when you press the Power/Start button	Have the batteries run out? Are the battery polarities wrong?	Replace new batteries. Re-align batteries in correct polarities.
"Err P" displayed	Fail to inflate	Check if the cuff is properly connected. Replace the air tube if it is broken.
"Err 1" displayed	Deflate too rapidly	Return for servicing.
"Err 2" displayed	Movement during measurement	Do not move during measurement
	Signal interference	Remove interfering source e.g. mobile phones, magnets.
"Err 3" displayed	Incorrect results	Measure again.

Note: If your problem cannot be solved by the above, consult your store of purchase. Do not disassemble the unit.

## STORAGE & MAINTENANCE

- Keep away the unit from direct sunlight, extreme temperatures, humidity or moisture.
- Use a dry, soft cloth to clean the unit, or if desired, use a cloth lightly dampened with water.
- Do not use alcohol, benzene, thinner or other volatile liquids to clean the unit.
- Do not wash or expose the arm cuff to liquid.
- Remove batteries from the unit when it will not be used for more than 3 months.

## SPECIFICATIONS

Model No.	DB85
Measurement Method	Oscillometric
Measurement Range	Pressure: 20 - 280 mmHg Pulse Rate: 40 - 195 beats/min
Accuracy	Pressure: +/- 3 mmHg Pulse Rate: +/- 5%
Inflation	Pump driven
Pressure Detection	Semi-conductor
Power Supply	4 x AA batteries
Auto Power Off	3 minutes after last operation
Storage Environment	-20°C to 60°C, 10% to 95% RH
Operation Environment	10°C to 40°C, 30% to 85% RH
External Dimensions	5.8" (L) x 4.25" (W) x 2.83" (H) or 14.8 (L) x 10.8 (W) x 7.2 (H) cm
Net Weight	270g (batteries excluded)
Cuff Dimensions	For arm circumference of 22-34 cm (Special size to be ordered separately)
Package Content	Cuff, Instruction Manual, Battery Set, Warranty Card

Note: Subject to modification without prior notice.

Manufactured in accordance with International Standards



Manufacturer: Truly Instrument Ltd.  
2/F, Chung Shun Knitting Centre,  
1-3 Wing Yip St., Kwai Chung, N.T.,  
Hong Kong  
TEL: (852) 24879803  
FAX: (852) 21465756  
EC-Representative: Wellkang Ltd t/a Wellkang Tech Consulting  
Suite B, 29 Harley Street, LONDON W1G 9QR,  
United Kingdom

#### FCC Statement

This equipment has been tested and found to comply with the limits for a Class B digital device, pursuant to part 15 of FCC Rules. These limits are designed to provide reasonable protection against harmful interference in a residential installation. This equipment generates and can radiate radio frequency energy and, if not installed and used in accordance with the instructions, may cause harmful interference to radio communications. However, there is no guarantee that interference will not occur in a particular installation. If this equipment does cause harmful interference to radio or television reception, which can be determined by turning the equipment off and on, the user is encouraged to try to correct

The interference by one or more of the following measures:

Reorient or relocate the receiving antenna.

Increase the separation between the equipment and receiver.

Connect the equipment into an outlet on a circuit different from that to which the receiver is connected.

Consult the dealer or an experienced radio/TV technician for help.

This device complies with Part 15 of FCC Rules.

Operation is subject to the following two conditions:

This device may not cause harmful interference, and This device must accept any interference received, including interference that may cause undesired operation.

Note: The manufacturer is not responsible for any radio or TV interference caused by unauthorized modifications to this equipment. such modifications could void the user's authority to operate this equipment.