

dbRevo[®]

User's Manual

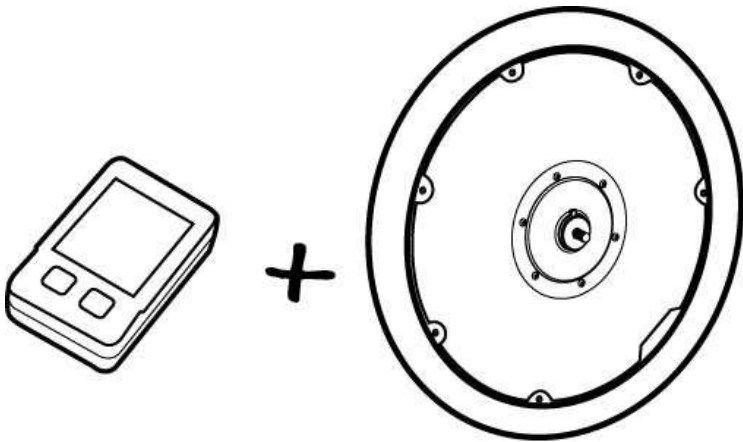

*Wireless Tech
All-in-One Design*

dbRevO User's Manual

1.	Usage Notice (Foreword)	2
2.	Installation Method	3
	Name Of Various Parts:	3
	Installation Of Power Wheel	4
	SENSOR installation.....	6
	Installation Of Console.....	7
	Accessories bag	7
3.	Operation Instructions Of Console.....	8
	Istructions of data readout on console.....	8
	Operation Instructions Of Console	10
4.	Charging Method.....	11
	To Charge The Console.....	11
	To Charge The Power Wheel.....	11
5.	Maintenance and Repair	12
	Maintenance	12
	Simple Repair Instruction.....	13
6.	Error Code.....	14
7.	Specification	16

“This device complies with Part 15 of the FCC Rules. Operation is subject to the following two conditions: (1) this device may not cause harmful interference, and (2) this device must accept any interference received, including interference that may cause undesired operation.”

Warning: Changes or modifications to this unit not expressly approved by the party responsible for compliance could void the user authority to operate the equipment.

1. Usage Notice (Foreword)

■ Be sure to read and abide by following instructions then abide by traffic rules for your driving safety. Products may be damaged to endanger personal life safety if there is any violation.

- 1 Be sure to wear safety helmets when driving bicycles.
- 2 Power wheel may be damaged with speed deceleration due to passengers or heavy articles.
- 3 Users shall prevent batteries from being affected with damp when driving across low-lying water.
- 4 It is strictly prohibited to reconstruct wheel body or detach parts to avoid reduction of products life of power wheel.
- 5 Be sure to inspect and maintain periodically to reduce failures.
- 6 It is strictly prohibited to drive on excessively instable pavement to avoid damaging power wheel.
- 7 It is strictly prohibited to use assistance power for slope section to avoid danger.
- 8 Motor will stop power supply automatically. if super-high motor temperature is caused by continuous climbing. Climbing slope is limited to 13°
- 9 Users shall pay attention to pits, stones on roads and rails, etc which may deviate from driving direction at any time during driving.
- 10 Users shall stop driving if driving safety is influenced by damaged parts during driving.
- 11 It is suggested to use parts of original manufacturer according to replacement demand.
- 12 Power wheel is originally designed for urban usage. It is strictly prohibited to use in following locations such as cross-country, athletics or instable pavement to avoid personal injury or Power wheel damaged
- 13 Users shall stop driving and take care of it as soon as possible if there is noise or sound under abnormal conditions.
- 14 It is strictly prohibited to use solvent or other chemical medicine on battery cell. It can be wiped by dipping cloth by water.
- 15 Note! Users can not reconstruct power wheel easily.

2. Installation Method

■ Name Of Various Parts:

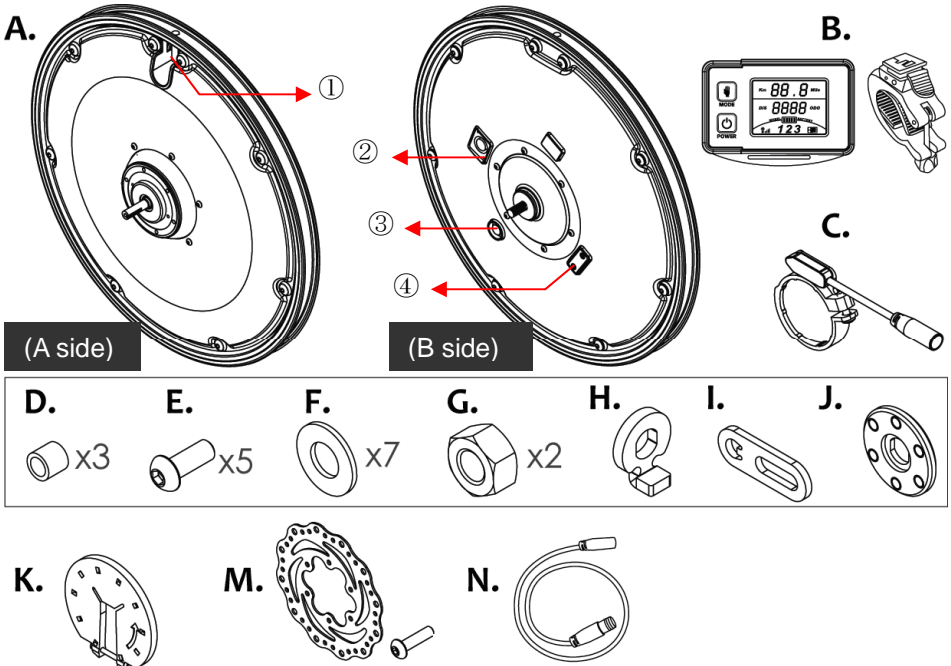

① Tyre aeration hole		② Charging hole		③ Power switch		④ Software updating location	
A.	Power wheel			F.	Washer (Users shall install the washer according to the space between front fork)		
B.	Console			G.	Screw cap		
C.	sensor			H.	Axle center fixation sheet iron		
D.	Sleeve (M4,M5,M6)			I.	Front fork fixation piece		
E.	Truss headhexagon screws	M5XP0.8X25		J.	Magnetic disc for sensor		
		M5xP0.8x15		K.	Magnetic disc		
		M4XP0.7X15		M.	Disc brake +Screw x 6 (optional)		
		M5xP0.8x15		N.	Connecting wire		
		M6xP1.0x15					

■ Installation Of Power Wheel

1. To place the wheel via aligning the front side of J. to the axis of the power wheel (B side).

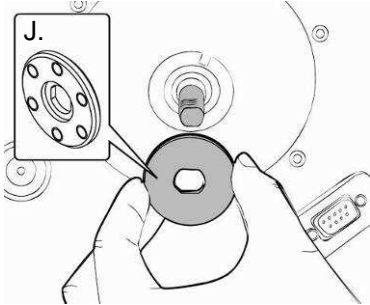

2. To place the M. disc brake on the power wheel (A side) to be locked by M. screw (Disc brake is optional)

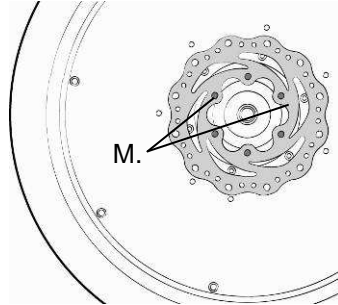

3. To invert the bicycle and place the the power wheel on the front fork. The A side of the wheel should be on right side of front fork. The B side of wheel is on the left side of front fork. on the

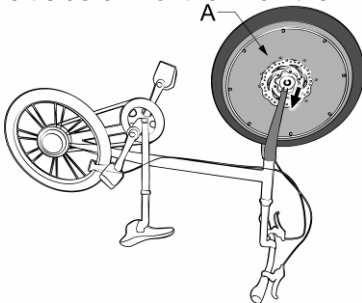

4. To place the power wheel via aligning the center of two sides to the front fork connection.

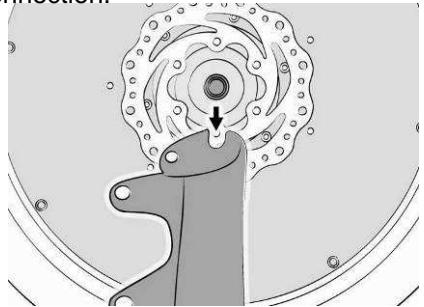

5. Power wheel (A side) : To align I. to axle center.

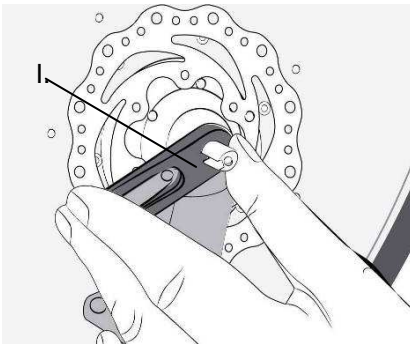

6. Power wheel (A side) : To install E. onto F. and place into I. for lock (according to E.D. conditions). To install axle center onto G. then lock.

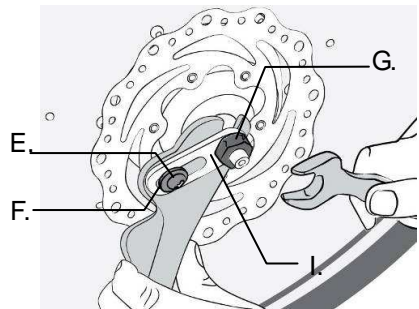

■ Installation Of Power Wheel

7. Power wheel (B side): To align H. into groove and place into axle center (in charging side) for locking.

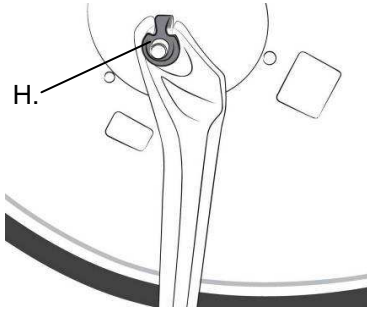

8. To check if tyre is perpendicular to ground or not.

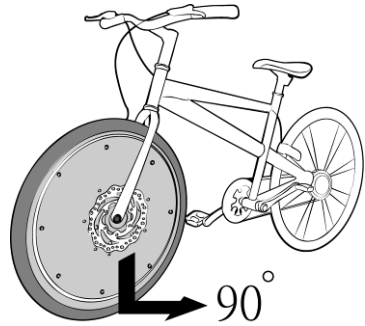

■ SENSOR installation

1. To invert the bicycle for sensor installation.

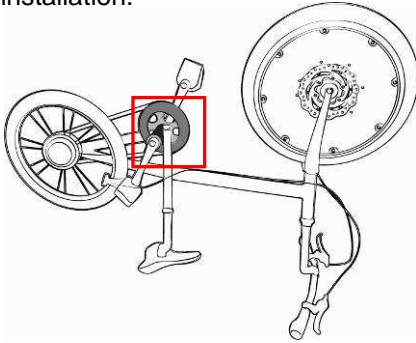

2. To place C. outward and lock at the part highlighted with oblique line shown in the photo.

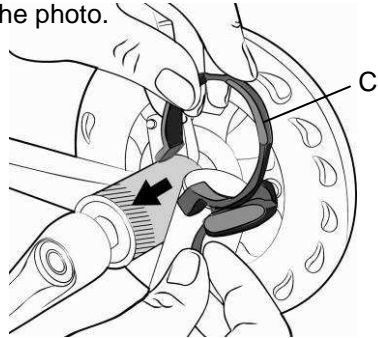

3. Place K. into it and arrow direction on magnetic disk must be consistent with pedal movement direction.

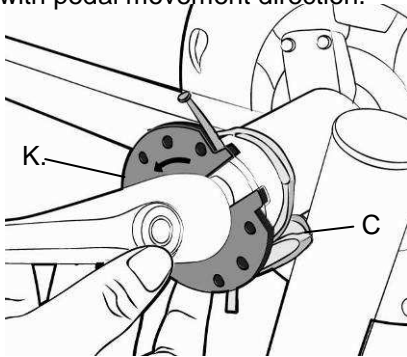

4. The proper gap between magnetic disk and sensor is 2-3mm. Tighten the magnetic disc by nut.

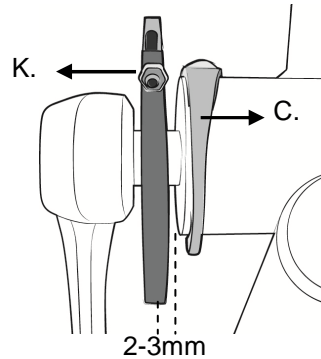

5. Install the bracket on the handlebar.

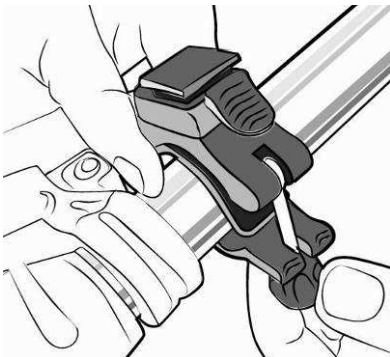

■ Installation Of Console

1. Insert console into bracket.

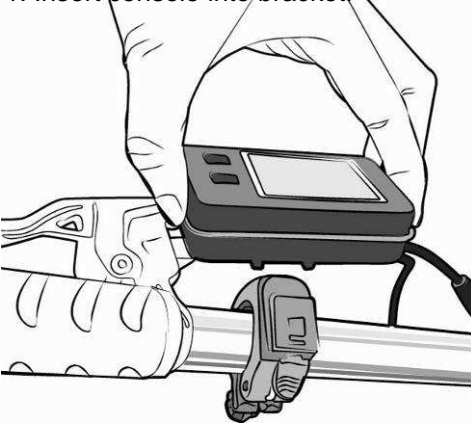

2. To connect N. with the joints of the sensor and the console, respectively.

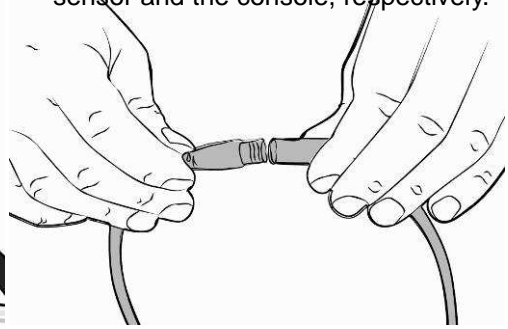

Detachment method is opposite to above steps.

Note! Users shall store detached power wheel properly for best condition.

■ Accessories bag

Power wheel charger set

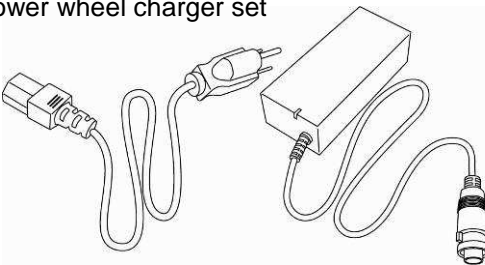

Console charger set

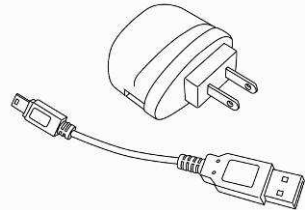

3. Operation Instructions Of Console

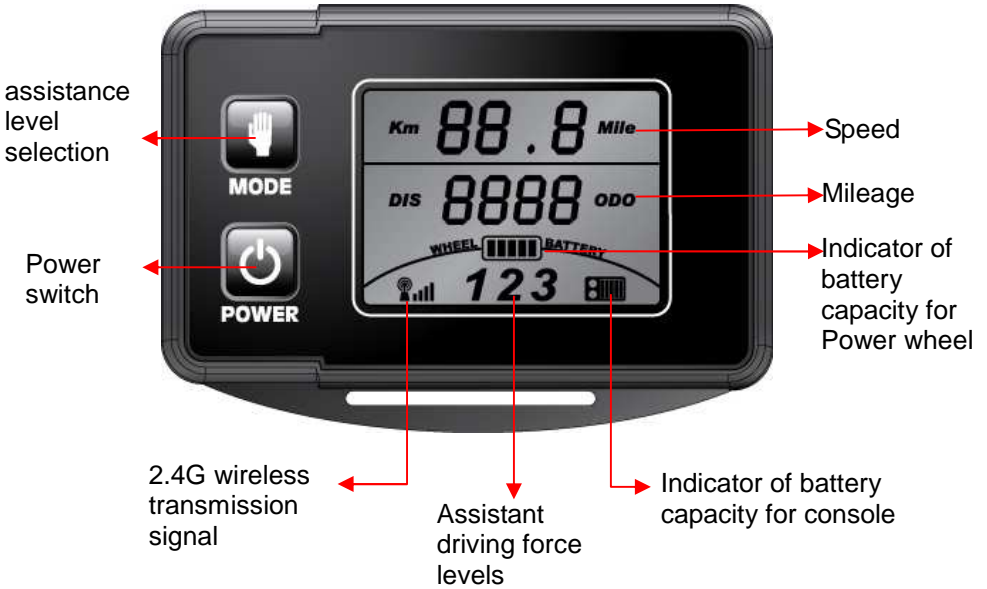

■ Instructions of data readout on console

(a) Speed:

Display the speed per hour of the bike by KM/H(Mile), speed range: 0~99.9.
Note: The speed shown by KM/H or Mile has been pre-set up.

(b)DIS/ODO:

Positive number—Distance counting is set to 0.
Distance increases from 0000 to 9999 by 1km/h(mile). When the distance is over 9999, the system will automatically reset and record from 0.

■ Operation Instructions Of Console

(c)  Indicator of battery capacity for Power wheel
Energy column will display full number (namely, 5 BARs) when power volume is full. BAR will flicker (with frequency of once every second) if there are only 2 BARs. It will begin to flicker and alarm to notify users of charging need.
The battery indicator will display full 5 BARs when fully charged. BAR will flicker (with frequency of once every second) if there are only 2 BARs It will begin to flicker and as an alarm to notify users of charging need.

(d)  Battery volume display of electronic watch
Energy column will display full number (namely, 5 BARs) when power volume is full. BAR will flicker (with frequency of once every second) if there are only 2 BARs. It will begin to flicker and alarm to notify users of charging need.
The battery indicator will display full 5 BARs when fully charged. BAR will flicker (with frequency of once every second) if there are only 2 BARs It will begin to flicker and as an alarm to notify users of charging need.







(e)  2.4G wireless transmission signal display
Full signal (of 4 BARs) refers to strong transmission signal and no signal (of 0 BAR) means the transmission stops.

(f)  **POWER** Power switch
Power switch function of console: Press to turn on the console with blue backlight; press again to turn off the console.

(g)  **MODE** Auxiliary power set key

- Press to select the assisted power level from none, level 1, level 2 and level 3.
- Console only displays SPEED and DISODO when selecting no assisted power.
- The assisted power will supply according to the selected level (from level 1 to level 3) when users start pedaling.
- Controller shall supply assisted power instantly when receiving the signal from speed sensor. It will cut off power supply instantly when speed reaches 24.5KM.

■ Operation Instructions Of Console

1.  flickers when user brake the power-off brake.
2. Integrated energy-saving technology will power off the system if the bike stopped for more than 15 minutes. To re-start the system, user has to switch off the power for 3 to 5 seconds before to power on again.
3. The console and controller will communicate through 2.4G wireless transmission when use dbRevO wheel for the 1st time.
4. Users shall power on the wheel before power on the console. After the console and controller communicate through 2.4G wireless transmission, user will see  which means the communication is successful. If to power on the console before to power on the wheel, error code E-0 will flicker on the console screen.
5. Wheel size setup
 - User shall press  **MODE** key for 10 seconds to enter into wheel size setup under standby mode, when not braking the power-off brake. .
 - To select the wheel size from 16-30 inch by pressing  **MODE** key. Press  **MODE** once to increase 2 inch each time.
 - Then, press  **POWER** key to save the setup and return to standby mode

4. Charging Method

■ To Charge The Console

- Charging time is about 3-4 hours. Be sure to charge the console for 12 hours before using the battery for the 1st time.
- Suitable ambient temperature for charging is 0~45°C.
- Users shall charge the battery immediately after using, and to charge at least once every month for better maintenance.
- Meanings of the LED colors on console charger.

Orange LED	Red LED	Orange LED
Standby: Power supply	In charging	Full charged

■ To Charge The Power Wheel

- Charging time is about 4-6 hours. Be sure to charge the console for 12 hours before using the battery for the 1st time.
- Users shall use the charger provided by the original manufacturer. It is strictly prohibited to use charger from other manufacturers randomly.
- Suitable ambient temperature for charging is 0~45°C.
- Users shall charge the battery immediately after using, and to charge at least once every month for better maintenance.
- Meanings of the LED colors on dbRevO Wheel charger.

Green LED	Orange LED	Green LED
Standby: Power supply	In charging	Full charged

5. Maintenance and Repair

■ Maintenance

1. To check if there's any rusty part or leaks carefully. Leaks may be eroded to accelerate damage and enlarge the leaks itself.
2. To clean dbRevO wheel periodically and keep away from all corrosive materials such as salt.
3. Do not polish, drill or carve on wheel surface. Leaks may be caused by large scratch, chisel hole or nick.
4. Users shall pay attention to find out noise source if any, and try to solve the problems as soon as possible.
5. It is strictly prohibited to wash the wheel by strong spout to avoid damaging the battery. Users shall clean the wheel by clean mop.
6. Users shall use neutral or soft detergent to avoid damaging the wheel housing.
7. It is strictly prohibited to clean the wheel by sea water or salty water. Users shall use cold water to avoid corrosion problems.
8. It is suggested to park the bicycle indoor or at cool places to avoid being exposed to the sun and rain. Users shall keep the wheel dry to avoid rusty problems. .
9. It is strictly prohibited to drop or to dash against the wheel. Huge external force may cause the deformation and damage the internal electrical parts, which is dangerous for users safety.

■ Simple Repair Instruction

1. To inspect the safety mark on the tire and to replace new tire instantly if abrasion exceeds the mark.
2. To inspect the front and rear brakes and parts of the bike to see if any operation fails, wire disconnection, or damage problems.
3. To keep the tire pressure within the marked scope on the tire because tire may be burst when driving.
4. To check if there is chapping, damage or abnormal abrasion on tire or not. Users shall replace a new tire instantly if it is damaged severely.
5. To check if there is excessive abrasion for brake pad or not. It shall be replaced to avoid inflexible brake.

6. Error Code

Error Code will flicker when control system is under abnormal conditions.

The console will be powered off automatically after Error Code flickers for 10 seconds.

Troubles And Troubleshooting		
Trouble code	Trouble Description	Troubleshooting
E1	No speed signal from motor during driving.	1. To check if motor signal wire is disconnected.
		2. To replace motor.
E3	Controller fails when motor operates	1. To replace control board.
E4	Controller fails when motor operates.	1. To replace control board.
E7	Torque Sensor voltage is abnormal or out of the scope of standard.	1. To check if Torque Sensor zeroing voltage setting is correct.
		2. To check if Torque Sensor signal wire is disconnected.
		3. To replace Torque Sensor.
E-8	UVW wire is disconnected when motor operates.	1. To check if motor signal wire is disconnected.
		2. To replace motor.
		3. To replace lower controller.
E-9	Short-circuit after motor start-up	1. To replace motor.
		2. To replace lower controller.
E-A	Motor cannot operate	1. To check if motor signal wire is disconnected.
		2. To replace motor.
		3. To replace lower controller.

E-B	Controller current is over the scope of standard.	1. To replace motor.
E-0	Battery voltage is lower than the scope of standard	1. To power on the console after the battery is placed well and switch on for 3-5 seconds. As the console and controller are checking the battery capacity after the battery is switched on. To power on the console within 3-5 seconds, E-0 will flickers on the console.
		2. To check if battery voltage is lower than 16V or not. If yes, to charge the battery to full.
		3. To replace console

●Users shall contact with local dealers if troubles still cannot be solved under above situations!

7. Specification

Color	Standard	
Battery Housing	AL alloy	
Wheel rim	26" AL alloy	20" AL alloy
Tire	26"X1.5	20"X1.5
G.W.	26" : 8.6 kgs	20" : 6.4 kgs
Power System Specification		
Motor	24V250W DC Brushless	
Battery	26"	20"
	24V8.8Ah Lithium Battery	24V6.6Ah Lithium Battery
	Optional 11A	Optional 8.8A
Charger	24V2A charger for battery & 5V500mA USB charger for console	
Display	LCD Console (Quick-released, wireless)	
Sensor Device	Speed Sensor Inside Motor or Quick-Released Speed Sensor for pedelec	

2012/8/21 V1.3

FCC statement

NOTE: This equipment has been tested and found to comply with the limits for a Class B digital device, pursuant to part 15 of the FCC Rules. These limits are designed to provide reasonable protection against harmful interference in a residential installation.

This equipment generates, uses and can radiate radio frequency energy and, if not installed and used in accordance with the instructions, may cause harmful interference to radio communications. However, there is no guarantee that interference will not occur in a particular installation. If this equipment does cause harmful interference to radio or television reception, which can be determined by turning the equipment off and on, the user is encouraged to try to correct the interference by one or more of the following measures:

- Reorient or relocate the receiving antenna.
- Increase the separation between the equipment and receiver.
- Connect the equipment into an outlet on a circuit different from that to which the receiver is connected.
- Consult the dealer or an experienced radio/TV technician for help.