

R8300 User Guide

Table of Contents

Notices, Compliance and Safety	5	<i>Auto Dim Feature</i>	18
Disclaimer	5	<i>Simultaneous or Extended Display</i>	18
Trademark and Patent Notice	5	<i>Cursor Visibility</i>	18
Compliance Statements	5	<i>Lid Switch</i>	18
Warnings and Cautions	6	LED Status Indicators	19
Safety	6	Audio	20
<i>Service and Upgrade Safety and Precautions</i>	7	<i>To Adjust the Volume</i>	20
<i>Battery Pack Safety and Precautions</i>	7	<i>The PC Card Slot (Option)</i>	20
Getting Started	8	<i>Inserting the Card</i>	20
Standard Features	8	<i>Ejecting a Card</i>	20
Optional Features	8	TouchPad	21
Operating System Information	8	<i>Selecting Objects</i>	21
Tips for New Owners	8	<i>Dragging Objects</i>	21
Turning Off the Device	8	<i>Scrolling</i>	21
Getting Familiar With Your Notebook ...	9	<i>Zooming</i>	21
Front View	9	<i>Rotating Objects</i>	21
Left Side View	10	<i>Application Gestures</i>	22
Right Side View	11	<i>Adjusting the TouchPad Settings</i>	22
Back Edge View	11	<i>TouchPad Precautions</i>	22
Bottom View	12	Smart Card or EXPRESS Card Slot (Option) ...	23
Keyboard Basics	13	<i>To Insert a Card</i>	23
<i>Primary Keys</i>	13	<i>To Remove a Card</i>	23
<i>Arrow Keys</i>	14	The Hard Disk Drive (HDD)	23
<i>Function Keys and Key Combinations</i>	14	<i>Replacing the hard disk drive</i>	23
<i>Numeric Keypad</i>	15	<i>Hard Disk Drive Heater</i>	24
<i>Lock Keys</i>	15	The Media Bay	24
<i>Windows Keys</i>	16	<i>To Change Swappable Media Bay Device</i>	24
Radio ON/OFF Switch (Option)	16	<i>To Insert a Disk</i>	24
<i>To Turn all Radios on or off</i>	16	<i>To Remove a DVD or CD</i>	24
Application Launch Key	16	<i>Precautions for Handling DVDs and CDs</i>	25
<i>To Program the Application Launch Key in Windows 7</i>	16	Device Security	25
Display	17	<i>Security Slot</i>	25
<i>Install the Stylus Tether</i>	17	<i>BIOS Level Passwords</i>	25
<i>Calibrate the Touch Screen</i>	17	<i>Smart Card Reader (Option)</i>	25
<i>Adjusting Display Brightness</i>	17	<i>Fingerprint Scanner (Option)</i>	25
<i>Adjusting Display Resolution</i>	17	<i>Stealth Mode</i>	25
		<i>Trusted Platform Module (TPM)</i>	25
		ENERGY STAR®	26

Making Connections	27	Battery Calibration	34
Attaching Power	27	When to calibrate the battery:.....	34
To Attach AC Power.....	27	About Battery Calibration	34
To Use the Vehicle Adapter (optional)	27	Managing Power	34
USB Devices	27	Low-Power States	34
External keyboard or pointing device	27	Battery Tips	35
Ethernet (LAN).....	28	Tip 1. Avoid excessive heat and cold	35
Audio Devices.....	28	Tip 2. Prevent wasted power	35
External Monitor or Video Device	28	Tip 3. Calibrate your battery	35
Using Simultaneous Display.....	28	Tip 4. Get a good charge	36
Using Extended Display	28	Tip 5. Prevent data loss.....	36
Wireless Communication.....	29	Tip 6. Clean terminals.....	36
WLAN radio option	29	Tip 7. Storing batteries.....	36
About WLAN	29	Customizing Your BIOS	37
CRMA Express WWAN (Option).....	29	Starting the Setup Utility	37
LTE	29	Navigation and Help	37
HSPA+.....	29	The Main Menu	38
HSPA.....	29	The Advanced Menu	39
EDGE/GPRS/GSM Network	29	Trusted Computing.....	40
UMTS/GPRS/GSM Network.....	29	Intel TXT(LT) Configuration	41
EV-DO Rev A/EV-DO Rev 0/1xRTT/CDMA.....	29	Radio Devices Configuration	42
GPS (option)	30	Stealth Mode Configurations	43
Bluetooth (option).....	30	F81216 Super IO Configuration.....	44
Antennas.....	30	FAN Calibration.....	45
Improving Radio Coverage.....	31	Battery Calibration.....	45
On the Street	31	The Boot Menu.....	46
Inside a Building.....	31	The Security Menu.....	47
When to use Landline Communication.....	31	The Save & Exit Menu	48
Operating with Battery Power	32	Optional Equipment and Accessories..	49
Frequently Asked Battery Questions	32	Surge Protection	49
The Battery	32	Vehicle Adapter	49
Using a battery for the first time	32	To connect the vehicle adapter.....	49
Battery and Temperature	32	Vehicle Dock.....	49
Replacing the Battery.....	33	To charge a battery installed in the device	49
Battery Charging	33	Communicating with Other Devices	50
When to Replace the Battery.....	33	External Antennas	50
Heat Considerations.....	33	Memory Upgrade.....	50

Maintenance and Storage.....	51
Taking Care of Your Device	51
Taking Care of Your AC Adapter	51
Servicing Your Device	51
Storing Your Device.....	51
Taking Care of Your Batteries.....	52
Taking Care of Your Hard Drive	52
For Internal Hard Drives	52
For External PC Cards	52
Cleaning Your Device	52
Cleaning the Outside Case.....	52
Cleaning the Display.....	52
Cleaning the External Power Connector.....	53
Cleaning the RJ-45 / USB Connectors	53
Data Backup	53
Saving Important System Information.....	53
Data Recovery.....	53
Option 1: Restoring System Information.....	53
Option 2 : Restoring a Backup.....	53
Option 3: Restoring Drive C:	53
Troubleshooting.....	54
Application Troubleshooting	54
My application locks up, acts strangely, or produces a General Protection Fault (GPF) error or blue screen.....	54
Battery Troubleshooting.....	54
The battery does not charge.....	54
The batteries take much longer than seven hours to charge.....	54
The batteries don't last very long	54
The gas gauge isn't full after charging the battery.....	54
The gas gauge reads "full," but the charging LED is still lit	54
My battery seems to have less and less capacity.....	54
Display / Touch Screen	55
The display performance is slow.....	55
I can't read the display.....	55
The underlined, inverse, and hypertext characters are difficult to read on the screen	55
I can't see the cursor while using the DOS editor.....	55
I changed my display resolution, but I see no difference on the screen	55
Nothing happens when I try to use the stylus on my touch screen.....	55
The touch screen doesn't respond after a suspend	55
Hard Disk.....	55
The hard disk will not spin up so the device can't boot up.....	55
The notebook does not startup properly	55
Keyboard and Mouse Troubleshooting	56
Something unexpected happens when I press a key	56
Incorrect characters appear on the screen when I press certain keys	56
I have difficulty double-clicking the mouse fast enough...	56
PC Cards.....	56
I can't remove the PC card.....	56
Read Error	56
The device locks up when I remove the PC card	56
Miscellaneous Troubleshooting	56
The device shuts off unexpectedly.....	56
The speaker volume is too high or too low	56
The device won't turn on.....	56
The device won't turn off.....	56
The device enters suspend mode too quickly.....	56
The device doesn't automatically suspend.....	57
The system date and time are incorrect.....	57
I receive an "out of memory" error message	57
Holding down the Power button to reset the device doesn't always work.....	57
The device doesn't make any sounds, even during boot-up.....	57
The fan stopped running	57
Can I improve the startup speed of my programs by cleaning up and rearranging files on the hard drive?.....	57

Notices, Compliance and Safety

Disclaimer

Twinhead International Corp. reserves the right to revise the manual and make periodic changes to the content without a direct or inferred obligation to notify any person of such revision or changes. Twinhead International Corp. does not assume responsibility for the use of this manual, nor for any patent infringements or other rights or third parties who may use the manual.

This document contains proprietary information of Twinhead International Corp.

This product is available for purchase under Twinhead International Corp.'s standard terms and conditions of sale. Hardware products may be reconditioned, or be manufactured from parts and components that may be new, used, rebuilt, or recycled and in some cases, the hardware product may not be new and may have been previously installed. In any event, Twinhead International Corp. warranty terms apply.

Trademark and Patent Notice

Microsoft, MS, Windows, and MS-DOS are registered trademarks of Microsoft Corporation.

The following United States Patent Numbers apply to any unit which incorporates a DVD drive - 5,434,678; 5,589,945; 5,913,013; 6,151,444; and 6,208,805.

This product incorporates copyright protection technology that is protected by U.S. patents and other intellectual property rights. Use of this copyright protection technology must be authorized by Macrovision, and is intended for home and other limited viewing uses only unless otherwise authorized by Macrovision. Reverse engineering or disassembly is prohibited.

ENERGY STAR® is a registered trademark of the U.S. Environmental Protection Agency. As an ENERGY STAR partner, Twinhead International Corp. has determined this device meets ENERGY STAR program requirements for computers.

Compliance Statements

This notebook has been tested and found to comply with the limits for a Class B digital device, pursuant to Part 15 of the FCC Rules. These limits are designed to provide reasonable protection against harmful interference in a residential installation. This equipment generates, uses, and can radiate radio frequency energy and, if not installed and used in accordance with the instructions, may cause harmful interference to radio communications. However, there is no guarantee that interference will not occur in a particular installation.

If this equipment does cause harmful interference to radio or television reception, which can be determined by turning the equipment off and on, the user is encouraged to try to correct the interference by one or more of the following measures:

- Reorient or relocate the receiving antenna.
- Increase the separation between the equipment and receiver.
- Connect the equipment into an outlet on a circuit different from that to which the receiver is connected.
- Consult the dealer or an experienced radio/TV technician for help.

This device complies with Part 15 of the FCC Rules. Operation is subject to the following two conditions: (1) this device may not cause interference, and (2) this device must accept any interference, including interference that may cause undesired operation of the device.

This Class B digital apparatus complies with Canadian ICES-003.

Cet appareil numérique de la classe B est conforme à la norme NMB-003 du Canada.

Notices, Compliance and Safety

Warnings and Cautions

WARNING It is important that only authorized personnel service and attempt repairs on the equipment. Unauthorized service or repair may void the warranty and any maintenance contract in effect for the equipment. Unauthorized service personnel might be subject to shock hazard on some equipment if removal of protective covers is attempted.

There is danger of explosion if the battery is incorrectly replaced. Replace only with the same or equivalent type recommended by the manufacturer. Dispose of used batteries according to the manufacturer's instructions.

The product you have purchased is powered by a rechargeable battery. The battery is recyclable and, under various state and local laws, it may be illegal to dispose of this battery into the municipal waste stream. Do not crush the battery or place it in a fire. Check with your local solid-waste officials for details on recycling options or proper disposal.

CAUTION Internal components of the notebook will be damaged if exposed to contaminants. When dust covers, the PC card door, or the bottom access panel are open on the device, shield the unit from all contaminants such as liquids, rain, snow, and dust.

This device may contain a WLAN radio transmitter, a WPAN radio transmitter, and a WAN radio transmitter.

Each internal radio may or may not have an individual FCC Identifier label. That FCC Identifier label is not applicable to this configuration. Only the external FCC ID label is applicable.

Only the antenna with which an intentional radiator is authorized may be used with the intentional radiator.

The WAN embedded antenna location is in the upper center edge of the display screen and is not to be modified.

The WPAN embedded antenna location is near the lower left edge of the Keyboard and is not to be modified.

The WLAN embedded dual antennas are located internally in the upper right and left edges of the display screen and are not to be modified.

To comply with FCC RF exposure requirements when using the WAN radio transmitter, a minimum separation distance of 20 cm must be maintained between the upper center edge of the display screen antenna and all users/bystanders.

When using the WLAN transmitter, a minimum separation distance of 20 cm must be maintained between the upper right and left edges of the display screen and all users/bystanders.

The WAN transmitter, WLAN transmitter and WPAN transmitter should be turned off before carrying the laptop PC in order to comply with FCC RF exposure requirements.

The equipment has been approved to [Commission Decision "CTR21"] for pan-European single terminal connection to

the Public Switched Telephone Network (PSTN). However, due to differences between individual PSTNs provided in different countries the approval does not, of itself, give an unconditional assurance of successful operation on every PSTN network termination point.

In the event of problems, you should contact your equipment supplier in the first instance.

Safety

Do not proceed beyond a WARNING or CAUTION until the indicated conditions are fully understood and met.

Read these instructions carefully. Following these guidelines will help prevent damage to your device and help protect your personal safety.

- Read and follow all **WARNINGS, CAUTIONS** and instructions marked on the product and noted in this documentation.
- Before using your device, read the Power Management section to familiarize yourself with basic battery information and ensure optimum performance.
- **CAUTION** To reduce the risk of fire, only use a No. 26 AWG or larger telecommunication line cord.
- **CAUTION** This device is designed to be used with the provided dedicated AC Adapter or Vehicle Adapter.
- Unplug the device from the power outlet before cleaning.
- Use a damp cloth for cleaning. Aerosols, solvents, or strong detergents are not recommended cleaning solutions and may void your warranty. For system decontamination recommendations please contact your service technician.
- Slots and openings in the device case are for ventilation purposes. Do not block or cover these openings or the system could overheat.
- Do not place the product on a soft surface such as a bed, sofa, or rug where the ventilation slots and openings may be blocked.
- Do not place this product near or over a radiator or heat register.
- Do not place this product in a built-in installation unless proper ventilation is provided.
- Do not operate the device at temperatures above 140°F (60°C) or below -10°F (-23°C).
- Do not store the device at temperatures above 167°F (75°C) or below -67°F (-55°C).
- Do not step on or place anything on the power cord.
- Do not slam the display lid when you close it.
- Do not place any object on top of the device.
- If you use the device with an extension cord, ensure that

Notices, Compliance and Safety

the total ampere ratings of all the devices sharing the extension do not exceed the rating of the extension cord or the rating of the wall outlet.

- Do not push foreign objects into the device through any of the slots or openings. Dangerous voltages are present, which could cause electric shock, fire, or damage sensitive components.
- The device is designed to withstand spills. If a spill occurs, immediately power off the device and wipe it down.
- For best results, use a power strip with a built-in surge protector. Do not use inferior extension cords as this may result in damage to your device.
- FAA regulations require that all transmit/receive devices be turned off during flight. If you have radios in your device (including GPS) and your device is equipped with a **Radio ON/OFF Switch**, please use it to turn your radios off during flight. If you have radios and you do not have a switch to turn the radios off, either leave your device off during flight or contact your help desk for assistance.

Service and Upgrade Safety and Precautions

Do not service this product yourself. Opening or removing covers may expose you to dangerous voltage points or other risks and may void your warranty. Damage caused by servicing that is not authorized may void your warranty. If your device needs service, remove power and turn it off, then contact authorized service personnel.

Refer all servicing to authorized service personnel under the following conditions:

- When the power cord or plug is damaged or frayed.
- If the product does not operate normally when the operating instructions are followed. Adjust only those controls that are covered by the instructions in this manual.
- If the product exhibits a distinct change in performance, indicating a need for service.

Before performing any manufacturer authorized service or upgrade, first follow these instructions:

- Prevent damage from static electricity by following ESD precautions.
- Place the device on a clean, flat surface.
- Turn off the device and disconnect the power supply.
- Undock the device if it is in an office dock or vehicle dock.
- Disconnect any attached peripherals.
- Disconnect any attached network, telephone or telecommunication line.
- Remove any PC Cards, EXPRESS Cards, Smart Cards, CDs, DVDs or any other media in your device's slots or bays.

- Remove the battery (See **Battery Removal**).
- Remove the hard drive (See **Hard Disk Drive Removal**).

Battery Pack Safety and Precautions

- **WARNING!** There is danger of explosion if the battery is incorrectly replaced. Replace only with a manufacturer approved battery.
- **WARNING!** Dispose of used batteries promptly and according to the manufacturer's instructions
- **WARNING!** Batteries may explode if not handled properly. Do not disassemble, open, puncture or dispose of battery packs in a fire. The battery pack could burst or explode releasing hazardous chemicals.
- **WARNING!** Keep battery packs away from children.
- Follow the safety instructions printed on the battery.
- Only use approved manufacturer approved battery packs with your device.
- Do not abuse, deliberately pierce, or subject the battery pack to excessive impact.
- Immediately discontinue use of the battery if it appears damaged or abnormal in any way and consult your local provider for advice.
- Do not immerse the battery pack in liquid.
- Do not short together the battery connections. Do not store the battery pack with metallic objects due to the risk of short circuit.
- Battery chemical leakage is harmful. In the unlikely event of battery leakage; **DO NOT TOUCH**. In case of accidental contact with the eyes or skin, immediately wash with running water and seek medical advice. In the case of accidental ingestion, seek immediate medical attention.
- Follow **Battery Tips** for use and storage.

Standard Features

- XGA Color **Display**
- Shock-mounted, ruggedized, removable **Hard Disk Drive** with heater
- Fully-rugged magnesium case
- Full-size, 87-key sealed keyboard with embedded numeric keypad and 12 function keys
- Multi-Touch **TouchPad**
- **Lid Switch**: The lid switch can be configured to suspend your device when the lid is closed and to resume when the lid is opened.
- **Application Launch Key** and user programmable buttons
- Internal Gigabit **Ethernet LAN**
- Three USB 2.0 Ports
- One USB 3.0 Port
- **Audio** Jacks for external speakers and microphone and internal speakers and microphone
- **Stealth Mode**: This feature allows you to use the device in an environment where sound and light could be dangerous or disruptive
- Microsoft Windows 7 operating system
- Three-year limited warranty

Optional Features

Below is a list of some of the optional features supported by your device. Contact your authorized dealer if you decide to perform a key component upgrade.

- **XGA Transmissive HiBright DynaVue® Touch Screen Display**
- **Fingerprint Scanner**
- **Radio ON/OFF Switch**
- **Smart Card reader (FIPS 201) or EXPRESS Card/54 slot**
- **CRMA Express** radio technology: Flexible, upgradeable radio module for significant cost savings
- Integrated **Wireless LAN** Communications: 802.11a/b/g/n Wireless LAN with Mini-PCI wireless card support
- **Bluetooth**
- **GPS**
- **Media Bay** Device: DVD multi drive or media bay battery
- Backlit **Keyboard**
- Hazloc
- **Memory**
- Type II **PC Card Slot**
- Extra Media Bay Battery

Operating System Information

For information and help with Windows 7, select **Start, Help and Support, How to get started with your computer**. You can also browse or search help topics to learn more about using the Windows 7 Operating System.

Tips for New Owners

- Back up files often. Users who need to manage large amounts of data may wish to use backup devices.
- Create a set of recovery CDs or DVDs to recover your hard disk in case it becomes corrupted. To do this, use the Recovery CD Wizard by selecting **Start, Programs, Mobile Computer Tools**.
- Don't leave passwords anywhere on your notebook or carrying case.
- Install antivirus software and keep it updated.
- For added security, consider using a notebook lock with the device's **Security Slot**.
- Develop ergonomic work habits to help prevent related health issues. The science of ergonomics studies the relationship between health and a suitable work environment. For more information on ergonomics, contact your nearest computer bookstore, local library, reputable website.

Turning Off the Device

To turn off your device, select **Start, Shut Down** and follow the instructions on the screen.

If you are going to be away from the device for a short period, you can conserve power without shutting down the system. See **Managing Power** and **Battery Tips** for details.

NOTE If you are unable to shut down your device normally, follow the instructions in **Troubleshooting**.

CAUTION Shutting off the device improperly may result in data loss.

Getting Familiar With Your Notebook

Front View

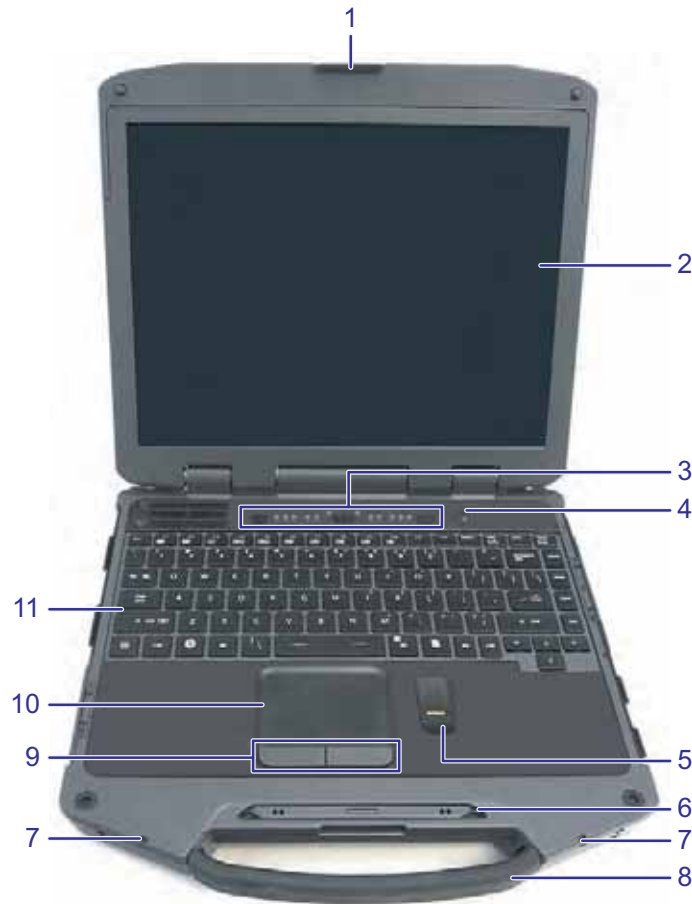







No.	Feature	Description
1	Display Latch	The display latch holds the display when closed.
2	Display	13.3-inch (4:3) XGA, outdoor-viewable, color display with an touch screen.
3	Button and LED indicator	Area above the keyboard with the power button, Radio ON/OFF Switch , Application Launch Key and LED Status Indicators .
4	Internal Microphone	Integrated, weatherized microphone can be used with various software applications that require audio input.
5	Fingerprint scanner	Scan your fingerprint to prevent access to your notebook by unauthorized users.
6	Pen / Stylus Slot	Store the provided custom touch screen pen (stylus) in this slot.
7	Tether Slot	A stylus tether can be attached at this location.
8	Handle	Integrated handle for convenient carrying.
9	TouchPad Buttons	Use like the buttons on a mouse.
10	TouchPad	Use to point, select, drag, or scroll objects on the screen.
11	Keyboard	Standard keyboard with embedded numeric keypad

Getting Familiar With Your Notebook

Left Side View





No.	Icon	Feature	Description
1		Back Handle Mount	The back handle mount, located on both sides of the device is used with an optional back handle.
2		DC-in Jack	Connects to an AC power adapter.
3		Network Jack (RJ45/LAN)	Connects to an Ethernet-based network. The connection speed is 10/100/1000 Mbps.
4		USB 2.0 Port	Connects to USB devices (e.g., USB digital camera).
5		Microphone Jack	Connect a microphone to this jack to record audio.
6		Audio Out Jack	Connect external speakers or a stereo headset to this jack to listen to multimedia.
7		External Monitor Port	Connects to a display monitor (up to 2048x1536 resolution).
8		Cooling Fan Exhaust	Cooling Fan exhaust area. DO NOT Block. This area may become hot as air vents from the device.
9		Smart Card Reader or Express Card Slot (optional)	Depending on your configuration, use with a Smart Card or EXPRESS Card.

Getting Familiar With Your Notebook

Right Side View



No.	Icon	Feature	Description
1		USB 3.0 Port	Connects to USB devices (e.g., USB digital camera).
2		Two USB 2.0 Ports	Connects to USB devices (e.g., USB digital camera).
3		Serial Port	Connects your device to serial devices such as a fax/modem or a serial mouse. This port is identified as COM1.
4		PC Card Slot	Use this slot for Type II PC Card devices.
5		Media Bay Combo	DVD-ROM/CD-RW, DVD Multi-Drive (DVD-RAM/DVD-ROM/DVD-RW/CD-R/CD-ROM/CD-RW), or second battery module.
6		Back Handle Mount	The back handle mount located on both sides of the device is used with an optional back handle.

Back Edge View



No.	Icon	Feature	Description
1		Battery Release Latches	Slide these toward the center of the unit to release the battery.
2		Battery Release Lock	Press this in (toward the display) to unlock the battery.
3		Cooling Fan Intake	Air intake for fan. DO NOT block this area.
4		Security Slot	The security slot can be used with a standard laptop-locking device, such as a Kensington lock. You can connect the device to a large object with the lock to prevent theft. See the documentation that comes with your lock for more information.

Getting Familiar With Your Notebook

Bottom View

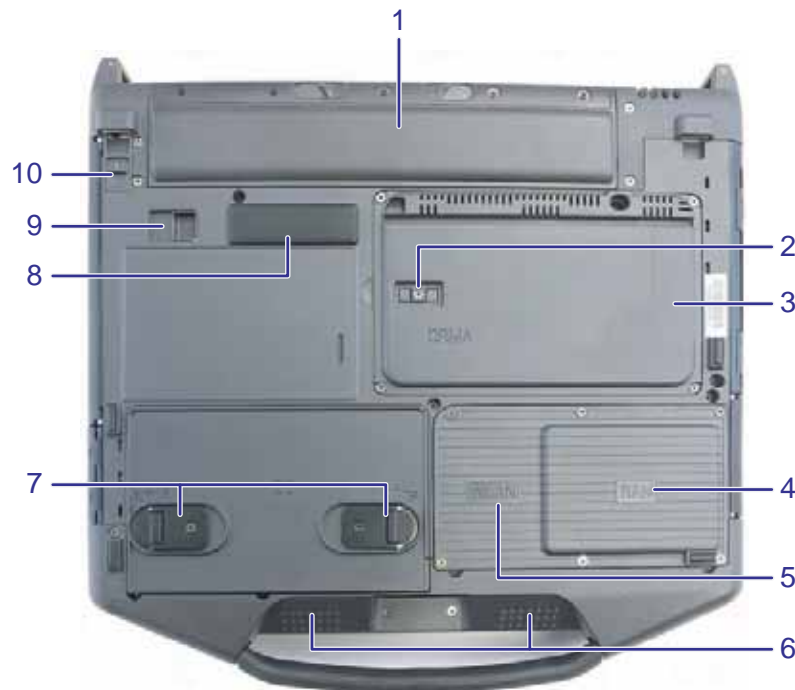

No.	Feature	Description
1	Battery Pack	Smart Lithium-Ion battery.
2	Dual External Antenna Connector (DEAC)	The DEAC gives you the ability to switch the internal WLAN and WWAN to an external antenna to gain better performance when you are in a vehicle.
3	CRMA Express Module	Upgradeable WWAN radio module (optional).
4	Memory compartment	User expandable memory slot.
5	WLAN compartment	Integrated wireless LAN radio.
6	Speakers	Integrated stereo speakers for audio output.
7	Hard Disk Drive Locks	Open and turn these to lock or unlock the removable hard disk drive.
8	Docking Connector	84-pin cradle connector that mates with the Vehicle Dock, or Office Dock.
9	Media Bay Release	After unlocking the media drive, slide this to release the media drive.
10	Media Bay Lock Slide	Slide this to unlock the media drive before releasing it.

Keyboard Basics

The R8300 features:

- Full size keys on a 85-key keyboard
- Twelve function keys
- Embedded numeric keypad
- **Application Launch Key** (programmable button)
- **Radio ON/OFF Switch**
- Ergonomically designed wide palm rest located below the keyboard

Primary Keys

Key	Description
Alt	The Alt (alternate) key is used with other keys to perform special tasks. On some operating systems pressing Ctrl + Alt + Del twice soft reboots the device.
Backspace	The Backspace key, sometimes represented on the keyboard as a left arrow, moves the cursor one position to the left. The character to the left of the cursor is erased.
Caps Lock	Pressing the Caps Lock key one time locks keys A through Z in the UPPER CASE position. Pressing the Caps Lock key again returns the letters to lower case. While in the upper case mode, pressing the Shift key results in lowercase characters when entered. You still have to use the Shift key to display characters located on the upper portion of the keyboard. For example, press Shift + 8 to type an asterisk (*), even when the Caps Lock key is activated. The Caps Lock LED  lights when the keyboard is in Caps Lock mode.
Ctrl	The Ctrl (control) key works with other keys to perform a variety of functions.
Enter	The Enter key signals the device that you have completed your entry. This is your way of telling the device to process the information that you have entered.
Esc	The Esc (escape) key allows you to exit a pop-up window or message box.
PrtSc	In Windows, pressing the PrtSc (print screen) key or Alt + PrtSc key copies the current screen or window to the clipboard so you can paste it into documents.
Shift	The Shift key changes the keys A through Z to the UPPER CASE position. When you press an alphabetic key, the character appears as a capital letter. When you press Shift with other keys, the characters on the upper part of the keys appear. For example, pressing Shift + 7 displays an ampersand (&).
Fn	Some special Fn (function) keys have been established to perform important tasks when pressed in combination with the Fn key. These keys are described later in this document. The Fn key legend is color keyed to other special keys on the keyboard.
Spacebar	Use the Spacebar to enter a space and move the cursor one character to the right.
Tab	The TAB key moves the cursor to the next tab stop or field. Tab stops are defined by your operating system or application program. Press the Tab key to move from one field or text box to another.

Getting Familiar With Your Notebook

Arrow Keys

The arrow keys are defined by the software application.

UP ARROW: usually moves the cursor up one line. In some cases, you can use the up arrow to make selections from menus and scrollable list boxes.

DOWN ARROW: usually moves the cursor down one line. In Windows, you can use the down arrow to make selections from menus and scrollable list boxes.

RIGHT ARROW: usually moves the cursor one character position to the right.

LEFT ARROW: usually moves the cursor one character position to the left.



Function Keys and Key Combinations

When using function keys, press and hold the **FN** key before pressing the other key in the key combination.

Function Key	Icon	Function	Description
Fn + F1		Screen blank	Turns off the display screen backlight. Press it again to turn the light back on.
Fn + F2		Display toggle	Switches the display output between the display screen, external monitor (if connected) and both the display screen and external monitor. NOTE When a DVD or VCD is playing display toggle is disabled.
Fn + F3		Standby	Puts the device in standby mode.
Fn + F4		Keyboard Backlight Brightness Down	Decreases the keyboard backlight brightness if you have the optional EL keyboard.
Fn + F5		Keyboard Backlight Brightness Up	Increases the keyboard backlight brightness if you have the optional EL keyboard.
Fn + F6		Display Brightness Down	Decreases the screen brightness.
Fn + F7		Display Brightness Up	Increases the screen brightness.
Fn + F8		Audio Volume Down	Decreases the audio volume.
Fn + F9		Audio Volume Up	Increases the audio volume.
Fn + F10		Speaker on/off	Turns the speakers on and off; mutes the sound.
Fn + F12		Stealth mode	Provides the ability to disable sound and light features such as system beeps, fan, and display backlight.
Fn + RIGHT Alt		TouchPad on/off	Toggles the TouchPad on and off.
Fn + LEFT Shift		Keyboard backlight	Toggles the keyboard backlight (option) on and off.

Getting Familiar With Your Notebook

Numeric Keypad

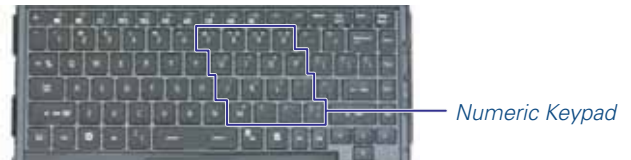

Standard Key	Key with Numlock On
7	7
8	8
9	9
0	*
U	4
I	5
O	6
P	-
J	1
K	2
L	3
;	+
M	0
.	.
/	/
Enter	Carriage Return

The embedded numeric keypad consists of sixteen keys that make number intensive input more convenient. It is indicated by small characters located on the lower right corner of the key. Press **NumLk** to enable or disable the numeric keypad.



Lock Keys







The keyboard has three lock keys you can toggle on and off.

Lock Key	Description
CAPS LOCK	<p>Pressing the Caps Lock key one time locks keys A through Z in the UPPER CASE position. Pressing the Caps Lock key again returns the letters to lower case. While in the upper case mode, pressing the Shift key results in lowercase characters when entered. You still have to use the Shift key to display characters located on the upper portion of the keyboard. For example, press Shift+8 to type an asterisk (*), even when the Caps Lock key is activated.</p> <p>The Caps Lock LED  lights when the keyboard is in Caps Lock mode.</p>
NUM LOCK	<p>Press the NumLk key to enter the Num Lock mode. When the Num Lock mode is on, the embedded keypad is in numeric mode. The keys function as a calculator (with the arithmetic operators +, -, *, and /). Use this mode when you need to do a lot of numeric data entry. Alternately, connect an external keypad. See External keyboard.</p> <p>The Num Lock LED  lights when the keyboard is in Num Lock mode.</p>
SCROLL LOCK	<p>Press the ScrLk key to enter the Scroll Lock mode. Scroll Lock varies between applications. It does not work with some applications.</p> <p>The Scroll Lock LED  lights when the keyboard is in Scroll Lock mode.</p>

Getting Familiar With Your Notebook

Windows Keys

The keyboard has two keys that perform Windows-specific functions.

Key	Icon	Description
Windows Logo Key		<p>Start button. Combinations with this key perform special functions. Below are a few examples:</p> <ul style="list-style-type: none">  + T (Activates next Taskbar button)  + E (Opens My Computer in Windows Explorer)  + M (Minimizes all Windows) Shift +  + M (Restores Minimized Windows)  + R (Displays Run dialog box) <p>Refer to Keyboard Shortcuts in Windows Help and Support for a complete list of Windows key combinations.</p>
Application Key		Opens the application's context menu (same as right-click).

Radio ON/OFF Switch (Option)

The keyboard has two keys that perform Windows-specific functions.

CAUTION FAA regulations require that all transmit/receive devices be turned off during flight. If you have radios in your device (including GPS) and your device is equipped with a Radio ON/OFF Switch, please use it to turn your radios off during flight. If you have radios and you do not have a switch to turn the radios off, either leave your device off during flight or contact your help desk for assistance.

The wireless Radio ON/OFF Switch is the middle button above the keyboard. This switch toggles the power on and off to all radio devices. Radio devices include GPS, Bluetooth, WLAN, and WWAN radios.

To Turn all Radios on or off

1. Slide the radio switch to the left to power off all radio devices (airplane mode).
2. Slide the radio switch to the right to turn radio power on.



Application Launch Key

The application launch key is the right button above the keyboard. Press this key to open a specific application you have set following the instructions below:

To Program the Application Launch Key in Windows 7

1. Select **Mobile Computer Tools, OnScreenControl**.
2. Select **Launch Key Settings, Set**, and then select **Run**. Click on **Configure**. Select **Browse** and choose an application based on its path. To complete the settings, select **Ok** three times.

Getting Familiar With Your Notebook

Display

This notebook features a 13.3-inch, XGA, outdoor-viewable, color display with an integrated touch screen. You can start programs and input data on the touch screen using an approved pen (stylus) that comes with the device. The Colorvue™ Transmissive display technology uses a built-in backlight for easy reading in most ambient light conditions. DynaVue® display technology provides improved outdoor visibility and even works well in sunlight.

CAUTION To avoid damaging the display, do not slam it when you close it. Also, do not place any object on top of the device when the display is closed.

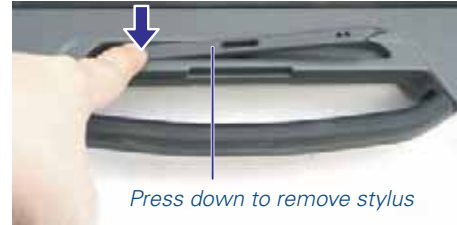

Install the Stylus Tether

1. Insert one tether loop through one of the holes on the end of the stylus, then pull it back through the adjacent hole.

NOTE The holes in the stylus are notched on one side and smooth on the other. Feed the tether through the smooth side first, so that it lies inside the notch when finished.

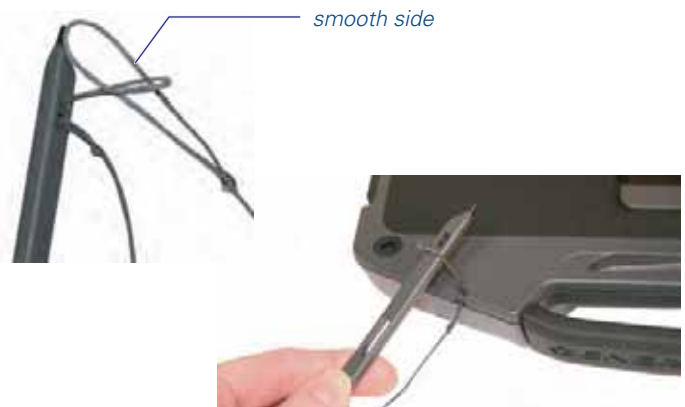

2. Insert the free end of the tether through the loop and pull the slack back through the loop to secure the stylus.
3. Repeat these steps with the other end of the tether to attach it to one of the tether slots on the front on your device.



Calibrate the Touch Screen

1. Press down on one side of the stylus to remove it from its slot below the TouchPad.
2. From the **Start** menu select **All Programs, eGalaxTouch**.
3. On the **Tools** tab, select **Linearization**.
4. Use an approved stylus and follow the instructions provided to complete touch screen calibration.
5. Click **OK** to save the new settings and click **OK** again to begin using your notebook.

Adjusting Display Brightness

- Press **Fn + F6**  to decrease display brightness.
- Press **Fn + F7**  to increase display brightness.

Adjusting Display Resolution

Windows 7:

1. Click on the **Start** button and then on **Control Panel**.
2. Under **Appearance and Personalization**, click on **Adjust Screen Resolution**.
3. On **Resolution**, use the slide bar to adjust the resolution.
4. Click **Apply** to save the new setting.

NOTE Using a lower resolution than the screen designation will reduce the area of the display.

Getting Familiar With Your Notebook

Auto Dim Feature

To save the battery power, your device automatically dims the display when the device is not attached to external power.

NOTE You may still use the display brightness function keys (**FN+F6** and **FN+F7**) to adjust display brightness.

See **Managing Power** for more information on power management features.

Simultaneous or Extended Display

This device supports simultaneous LCD and external display output via the external monitor port located on the back edge of the device. You can also connect other output display devices such as LCD projection panels for large audience presentations. See **Attaching an External Monitor or Video Device** for more information.

FEATURE When using an external monitor you can extend your desktop. This allows you to open and view one program on the external monitor while viewing a different program on your laptop's display.

Windows 7:

1. Select **Start, Control Panel, Appearance and Personalization**.
2. Under **Display**, select **Connect to an external display**.
3. On **Multiple displays**, click **Extend these displays**. Then click **Apply**.

Cursor Visibility

To improve the visibility of the mouse cursor, you should:

- Enable the **"Pointer Trails"** feature to add trailing cursors
- Use a slow or medium speed/sensitivity level

You can combine a higher level of acceleration with a slow or medium speed/sensitivity level. This allows you to move the mouse cursor quickly by increasing your finger pressure, while still providing a finer degree of control when you apply minimum pressure.

NOTE To change the speed of the mouse, do the following:

Windows 7: Select **Start, Control Panel, Hardware and Sound**, and then choose **Mouse**. On the **Mouse Properties** window, select the **Pointer Options** tab to make cursor visibility adjustments.

Lid Switch

Your device has a lid switch that can automatically suspend and resume your device when you close and open the display. To change the power management settings for the lid switch, perform the following:

Windows 7:

1. On the System Tray area of the Taskbar, click the **DynaPower** icon  and select **DynaPower Grid**.
2. At the top of the grid, select the appropriate **Power** plan.
3. Select the desired action settings for both battery or AC power.
4. Select **Save Changes** and repeat steps 2 through 3 until all power plan settings you wish to modify.

Getting Familiar With Your Notebook

LED Status Indicators

The activity indicators, located above the keyboard, light up when a particular function of the device is active. Each indicator is marked with an icon.

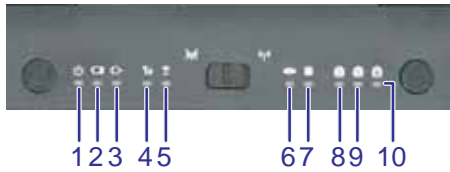

Display Hinge LEDs - visible when the display lid is closed

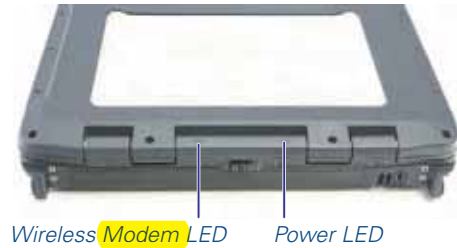



No.	Icon	Function	LED	Description
1		Power	Lit	Power is ON.
			Flashing	Suspend to RAM.
2		Battery	Lit	Battery charging.
			Flashing	Low battery.
			LED off	No battery / battery fully charged (will always be OFF without external power connected to the unit).
3		External Power	Lit	External power is connected to the unit.
4		WWAN Communication	Lit	WWAN radio is on.
5		WLAN Communication	Lit	Wireless LAN, Bluetooth, and/or GPS radio(s) are on.
6		Media Bay	Lit	The notebook is equipped with a DVD/CDRW Combo, CD-ROM, or DVD-ROM.
7		Disk Status (HW)	Lit	The hard disk drive is being accessed.
8		Caps Lock	Lit	The keyboard is in Caps Lock mode.
9		Number Lock	Lit	The keyboard is in Num Lock mode.
10		Scroll Lock	Lit	The keyboard is in Scroll Lock mode.

Getting Familiar With Your Notebook

Audio

Your device includes 24-bit high-fidelity stereo audio output and an integrated microphone. You can also attach external audio devices via the audio in and out jacks on the left side of the device.

To Adjust the Volume

- To decrease volume, press **Fn + F8** .
- To increase volume, press **Fn + F9** .
- To mute the volume, press **Fn + F10** .

You can also adjust the volume with the Windows volume control applet located on the taskbar. However, the volume control function keys override the Windows volume control applet. If your volume is too low or too high after setting the volume in the applet, adjust the volume with the function keys.

The PC Card Slot (Option)

Use the PC card slot, located on the right side of the device under the media bay, as an interface between your device and a variety of communications devices, such as network adapters, SCSI adapters, and fax/modems, or to provide additional data storage capacity. Your device's PC Card slot supports single Type I or II PC Cards, 32-bit CardBus cards, and Zoomed Video cards.



CAUTION Do not remove or change any hardware while your device is hibernating or in a Sleep/Standby state.

Inserting the Card

1. The top side of a PC Card is usually identified with a label. Insert the card into the slot with the top up and the edge with pinhole contacts or arrow, going in first. You will feel some resistance as the card slides into the back of the slot.
2. PC Cards require drivers, or a program that allows the operating system to use a specific device. Many drivers are included with Windows so the PC Card will be automatically recognized; but if not, you will be prompted to install the driver included with your card.
3. The PC Card becomes a removable disk drive and is assigned a letter drive.

NOTE Please read the instructions included with individual PC Cards. Some cards may be inserted with power on, while others require that the device be turned off.

Ejecting a Card

1. First, exit the application using the card.
2. On the taskbar, left-click on the **Safely Remove Hardware** icon  or .
3. Press the slot eject button once to pop it out; then press it again to eject the PC Card.



Getting Familiar With Your Notebook

TouchPad

The integrated TouchPad is a pointing device that senses movement on its surface so the cursor responds as you move your finger over of the TouchPad. The buttons located directly below the TouchPad have the same function as a two-button mouse. Press these buttons to make selections, drag objects, or perform a variety of other functions depending on the software.

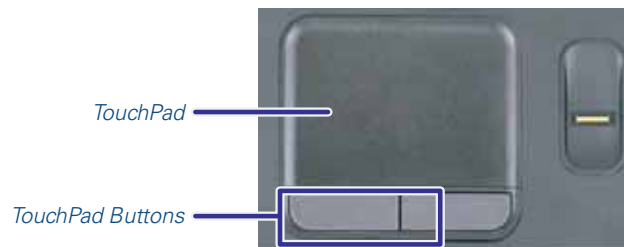

Selecting Objects

1. Move the pointer over the object to be selected
2. Double-tap the TouchPad or double-click the left TouchPad button. The TouchPad will respond like a mouse.

Dragging Objects

1. Place the cursor over the desired object.
2. Press and hold the left button or tap the TouchPad two times as if you were double-clicking but do not remove your finger after the second tap.
3. Move the cursor to the desired location and release the button or lift your finger to finish dragging.

Scrolling

Two-Finger Scrolling

The two-finger scrolling feature allows you to scroll vertically or horizontally and initiate scrolling from anywhere on the TouchPad surface.

4. Place two fingers down on the TouchPad surface. The fingers should be slightly separated.
5. Using a straight continuous motion, slide both fingers in the desired direction.
6. Lift both fingers up off the TouchPad surface to stop scrolling.

Zooming

Pinch Zoom

The Pinch Zoom gesture delivers smooth zooming functionality in many applications, including Microsoft Office 2003 and 2007, MS IE 6,7, and 8, as well as Adobe Acrobat/Reader and PhotoShop CS3 and CS4, MS Windows Media Player 11, WinDVD 9, and iTunes. This feature is enhanced with PointZoom(TM) for intelligent and contextual zoom control.

Users surfing the Web can pinch over a site's text enlarging the font, pinch over a map and zoom the map - all in the same browser window.

The Pinch Zoom gesture can be used to perform the same function as a scroll wheel on a standard Windows applications that support CTRL-SCROLL WHEEL zoom functionality.

To use the Pinch Zoom gesture:

1. Place two fingers down on the TouchPad surface.
2. Slide the fingers further apart to zoom in or slide the fingers closer together to zoom out. For the best zooming experience, use the tips of your fingers.

Rotating Objects

Pivot Rotate

The Pivot Rotate gesture allows objects such as a photo, PDF file, or other selected object, to be rotated in 90 degree increments.

1. Place one finger down on the left "target" zone (adjustable scroll zone) of the TouchPad surface and keep it stationary.
2. Place another finger down near the middle of the TouchPad.
3. Slide the second finger in a circular motion around the first finger. Ensure that the space between the two fingers remains the same while making the circular motion. Slide clockwise or counterclockwise to rotate the selected object in the desired direction.

Getting Familiar With Your Notebook

Application Gestures

Three Finger Flick

The Three-Finger Flick gesture enhances navigation for a variety of applications. It can be used to browse the Internet or scroll through photos in a photo viewer window. It can also be used to enter or exit slideshow mode.

To enable this feature, select the **Enable Three-Finger Flick** check box.

To use the Three-Finger-Flick gesture for navigation:

1. Place three fingers, slightly separated, down on the TouchPad surface.
2. Flick your fingers in a straight, continuous motion in the desired direction, moving from one side of the TouchPad to the opposite side.
3. Slide your fingers to the right or left to page forward or backward in a photo viewer or an Internet browser window, and then lift the fingers.

To use the Three-Finger-Flick gesture for slideshow mode, slide your fingers vertically.

- Slide fingers upward to launch slideshow mode.
- Slide fingers downward to exit slideshow mode.

Three Finger Press

The Three-Finger Press gesture provides a shortcut for launching a specified application or applications.

To enable this feature, select the **Enable Three-Finger Press** check box. To customize the applications that launch, click the **Configure** button.

To use the Three-Finger-Press feature:

1. Place three fingers down on the TouchPad surface. Ensure that there is a small gap between the fingers.
2. Hold fingers still until the application or applications begin to launch.
3. Lift fingers upward off the TouchPad surface.

Adjusting the TouchPad Settings

These settings allow you to change the orientation from righthanded to left-handed, and fine-tune the pointer movement and timing of clicks.

Windows 7:

1. Select **Start, Control Panel, Hardware and Sound**.
2. Under **Devices and Printers**, select **Mouse**. This will bring you to the **Mouse Properties** window.
3. On the **Buttons** tab, use the **Devices** drop-down menu to select **Synaptics TouchPad V7.2 on PS/2 Port 1**. Now you can choose TouchPad settings for the way you work.

The Synaptics TouchPad can also be accessed via the  icon in system tray.

TouchPad Precautions

The TouchPad is a sensitive device. If not properly cared for, it can be easily damaged. Please take note of the following precautions:

- Make sure the TouchPad does not come into contact with dirt, liquids or grease.
- Keep the TouchPad area dry and clean.
- Do not touch the TouchPad if your fingers are dirty
- Do not rest heavy objects on the TouchPad or TouchPad buttons
- Keep your fingers dry and clean when using the TouchPad.
- Avoid tapping too hard. The TouchPad is sensitive to finger movements and responds best to light touches.

Getting Familiar With Your Notebook

Smart Card or EXPRESS Card Slot (Option)

Your device comes with a Smart Card Reader or ExpressCard slot (option) that supports ExpressCard/34 and ExpressCard/54. This slot is located on the left side of the device.

To Insert a Card

Insert the compatible card with the label side up into the slot until it clicks into place. The card will appear as a removable storage device that you can copy files to and from.

To Remove a Card

1. Make sure no operation is using the card (such as file copying or deletion).
2. Press the card further into the slot to release the card. You will hear a click.
3. Remove the card.



CAUTION Do not remove or change any hardware while your device is hibernating or in a Sleep/Standby state.

The Hard Disk Drive (HDD)

Your device features a removable, shock-mounted hard disk to provide high-capacity storage and fast access. The operating system and most programs are stored here. Your device identifies the hard disk drive as drive C. You can do a one-time configuration of your hard disk space through the **HDD Space Setup Wizard**. The Wizard can run when it is convenient for you; however, should be run after first start-up.

See the **BIOS Setup Utility** to password protect your removable hard disk drive.

Replacing the hard disk drive

1. You should print these instructions before continuing. They will not be available after you shut down the device in step two.
2. Shut down the device and remove power.
3. Remove the battery (see **Battery Removal**).
4. Turn the device over so you are looking at the bottom.
5. If installed, use a Phillips screwdriver to remove the two optional screws in the hard disk drive cover.
6. Flip open the HDD locks and turn both of them toward the center of the device.
7. Lift the HDD cover off of the device.
8. Using the ribbon, remove the HDD from the device.
9. Align the connectors and insert the HDD in the device.
10. Replace the door and turn the HDD locks toward the outside of the device to lock it.
11. If desired, install the optional HDD screws.

Remove screws



Turn toward inside



Remove by the ribbon



Getting Familiar With Your Notebook

Hard Disk Drive Heater

The hard disk drive heater warms the HDD before spinning up in temperatures below 5°C, the minimum safe operating temperature for the HDD. The heater is integrated and operates as needed when the device is on. If the temperature is below 5°C when booting or resuming you will see the message "**Warming internal hard drive. Please wait...**" The unit will continue booting when it detects the HDD is warm enough to operate safely.

NOTE If you are using the device in a cold temperature environment and the battery level is too low for the heater to operate, you will see the error message "**Battery too low to warm the hard drive. Shutting down...**" and the device will shut down. Apply external power and reboot.

The Media Bay

Depending on your configuration, your device may have an optional DVD multi-drive (DVD-RAM/DVD-ROM/DVD-RW/CD-R/CD-ROM/CD-RW) or media bay battery. The multi-drive allows you to read data from DVDs and CDs, including audio or video CDs, and enables you to burn your data onto a CD or DVD recordable disc. Please refer to the recording software online help for more information.



If you have the media bay battery, it extends your unplugged runtime.

Your notebook identifies the drive with the letter following the hard drive and/or recovery partition letter. If your hard drive is C, then the media bay will be E if you have a recovery partition. It will be D if you do not have a recovery partition.



Media Bay Release
Media Bay Screw and Lock

To Change Swappable Media Bay Device

1. Make sure the device is not accessing the media bay drive.
2. Open the media bay door cover.
3. Left-click on the **Safely Remove Hardware** icon  or  on the Windows tray taskbar.
4. Select the **Media Bay** device, then select **Stop**.
5. Wait for the "**safe to remove hardware**" message, then click **OK**.
6. Turn your device over so you are looking at the bottom.
7. If installed, remove the screw in the media bay lock.
8. Slide the media bay lock toward the back of the device and hold.
9. While holding the media lock in the unlocked position, slide the media bay release toward the outside of the device. The media bay should come part way out of the device.
10. Grasp the media bay device by the edges and pull straight out until it is clear from the slot.
11. Re-insert the next media bay device by firmly pushing it back into the slot until it clicks into place.

CAUTION Do not remove or change any hardware while your device is hibernating or in a Sleep/Standby state.

To Insert a Disk

1. Open the media bay door cover.
2. Insert the disk into the media bay slot.



To Remove a DVD or CD

1. Make sure the device is not accessing the DVD drive.
2. Press the eject button. The disk will automatically eject.
3. Pick up the disk by the edges and remove it from the slot.

CAUTION When the device is reading from a DVD or CD, the Optical Disk Drive LED will flash on. Do not attempt to remove a disk while this light is active.



Multi Drive Eject Button

Getting Familiar With Your Notebook

Precautions for Handling DVDs and CDs

Keep these precautions in mind when handling DVDs and CDs:

- Always hold the disk by the edges; avoid touching the surface of the disk.
- Use a clean, dry, cloth to remove dust, smudges, or fingerprints.
- Wipe from the center outward.
- Do not write on the surface of the disk.
- Extremes in temperature may damage disks. Store disks in a cool dry place.
- Do not use benzene, thinners, or cleaners with detergent. Only use cleaning kits designed for DVDs or CDs.
- Do not bend or drop the disks.
- Do not place objects on top of disks.

Device Security

Your device includes several security features to help prevent theft and protect data. These include a security slot, multiple levels of password protection, an optional fingerprint scanner, an optional Smart Card slot, stealth mode and Trusted Platform Module (TPM).

Security Slot

The security slot located on the back edge of the device lets you connect a Kensington compatible notebook security lock so you can connect the device to an immovable object to prevent theft. Insert the lock into the notch and turn the key to secure the lock. Some keyless models are also available.

See the documentation that comes with your lock for more information.

BIOS Level Passwords

Passwords protect your device from unauthorized access. When set, no one can access the device without entering the correct password.

There are two types of passwords you can set:

- Supervisor Password secures your device against unauthorized entry to critical parameters in the BIOS Utility.
- User Password secures your device against unauthorized use, and allows limited access to the BIOS Utility.

NOTE Do not forget to set your password! If you forget your password, please get in touch with your dealer or an authorized service center.

Smart Card Reader (Option)

If your device has the Smart Card Reader option, you can use smart card technology for added security.

Fingerprint Scanner (Option)

The optional swipe style fingerprint scanner can be used for all standard security uses. The optional fingerprint scanner provides a greater level of security and convenience for your device and your private data. Use the fingerprint scanner instead of passwords for the following:

- during device login
- during login at secure websites
- when opening password protected applications
- to provide encryption security for individual files

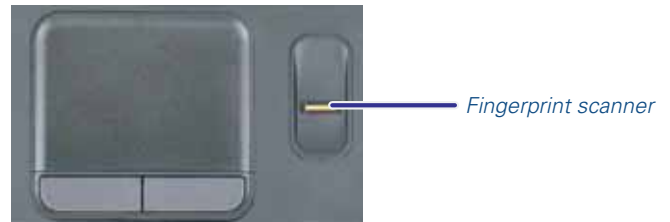

Fingerprint Scanner Software

Before using the fingerprint scanner, you must first install compatible software. If the optional fingerprint scanner was present during initial user setup, you should have the **"Install Finger Print Software"** link on your desktop. Click this link and follow the instructions to install the software. A wizard may guide you through the process.

CAUTION Before installing any third party software, ensure it is approved for use with this device.

When accessing some secure websites, you may need to specify you are using the fingerprint scanner instead of a password. Refer to the fingerprint scanner software documentation for setup information.

Stealth Mode











The stealth mode feature enables you to use the device where light or sound could be dangerous or disruptive, such as a military or public safety environment. Enabling stealth mode allows you to disable sound and light features such as system beeps, the fan, and the display backlight. Refer to the **BIOS Setup Utility** section for information about how to configure stealth mode.

NOTE The Stealth mode hotkey is **Fn + F12**.

Trusted Platform Module (TPM)

Enable or disable TPM in the System BIOS. TPM provides a platform root of trust which uniquely identifies a particular platform and provides various crypto capabilities including hardware-protected storage.

Getting Familiar With Your Notebook

Ports and Connectors	Icon	Connection	Location
RJ-45		Ethernet	Left Side
DC-in		AC Adapter (power)	Left Side
USB Universal Serial Bus 2.0		USB Peripherals such as a mouse, printer or optical disk drive	Left Side
2 USB Universal Serial Bus 2.0		USB Peripherals such as a mouse, printer or optical disk drive	Right Side
USB Universal Serial Bus 3.0		USB Peripherals such as a mouse, printer or optical disk drive	Right Side
External Monitor		External Monitor	Left Side
Audio In		Microphone	Left Side
Audio Out		Speakers or headphones	Left Side
PC Card Slot		Type II PC Cards	Right Side
Smart Card Reader or EXPRESS Card Slot		Smart Cards or EXPRESS Cards	Left Side
Security Slot		Notebook lock such as a Kensington lock	Back Edge
Multi I/O Docking Connector		Compatible office dock or vehicle dock	Bottom
Serial Port		Connects your device to serial devices such as a fax/modem or a serial mouse. This port is identified as COM1	Right Edge

ENERGY STAR®

Twinhead International Corp. is committed to designing mobile computers with the environment in mind. Not only do we design devices that withstand the environment – with rugged features that enable you to use them in extreme operating conditions, we design devices that use less energy, reducing environmental pollution.

That's why our ENERGY STAR compliant mobile computers meet or exceed the stringent ENERGY STAR standards set by the Environmental Protection Agency (EPA). According to the EPA, ENERGY STAR qualified products use as much as 60% less energy than standard equipment. By lowering energy consumption, our devices help customers save money while reducing greenhouse gas emissions.

For more information about ENERGY STAR (in English), go to www.energystar.gov.

To help you conserve energy on both AC and battery power, by default this device:

- turns off the display after 15 minutes of inactivity
- enters standby, a low power mode, after 15 minutes of inactivity, compared to 30 minutes required for ENERGY STAR compliance

Press any key to wake the device or turn the display back on after a period of inactivity.

This device was also designed with other power saving features that go beyond ENERGY STAR requirements. See the **Managing Power** section to make the most efficient use of those features.



This section describes how to connect peripherals and hardware options that help you maximize your device's features.

Before connecting peripherals, first read the manual included with the peripheral for connection and operation instructions. You can purchase most of these and other options directly from authorized dealers.

If you are a mobile worker, you may want to purchase an approved docking solution such as the Vehicle Dock or Office Dock. These docks provide drop-in convenience, port expansion, and automatic battery recharging, enabling you to leverage your device's features without having to attach and reattach cables and connectors when you move your device from office to vehicle.

Attaching Power

Your device can be powered by battery, by attaching an AC Adapter or Vehicle Adapter to the DC power port, or by connecting the device to a powered Vehicle Dock or Office Dock.

NOTE When external power is properly applied, the External Power LED  lights.

CAUTION This device is designed to be used with the provided dedicated AC Adapter or Vehicle Adapter.

To Attach AC Power

1. Connect the AC adapter power cord to the AC adapter.



2. Connect the AC adapter to the DC power port on the left side of your notebook.



3. Connect the AC adapter power cord to a properly grounded AC outlet.

NOTE It is recommended you use a quality surge protector.

To Use the Vehicle Adapter (optional)

1. Insert the vehicle adapter's power cord into the DC-in jack on the left side of the device.
2. Insert the 12V (cigarette lighter) adapter into the vehicle's 12V socket, turning it slightly to make a good connection.

CAUTION The vehicle adapter is not intended to be used continuously. It is intended to provide a convenient, temporary power source for powering and charging this device while in transit in a vehicle. For permanent installations, it is recommended that the (fused) vehicle charger adapter be wired directly to the vehicle power supply. For additional information regarding permanent installation, contact your sales representative.

3. The power LED illuminates to indicate that current is reaching the vehicle adapter. When you connect the vehicle adapter, it automatically begins charging the device's battery. At moderate temperatures, around 20°C (68°F), the battery should charge from empty to 90% in less than three hours if the unit is suspended or off. It should take less than four hours if the unit is in use.

NOTE As the battery temperature approaches the ends of its temperature range (5°C/ 41°F to 50°C/122°F), it may take longer to charge the battery.

CAUTION Avoid exposing batteries to extremely hot or cold temperatures for long periods. To prevent possible damage to the battery, the notebook does not allow the battery to charge if the internal temperature of the battery gets too low (< 5°C or < 41°F) or too high (> 50°C or > 122°F).

USB Devices

Your notebook comes with three Universal Serial Bus (USB) 2.0 ports and one Universal Serial Bus (USB) 3.0 port. This enables you to attach various devices such as a keyboard, mouse, scanner, or printer. USB devices can be chained together on a single cable.

External keyboard or pointing device

This notebook has a keyboard with full-sized keys and an embedded numeric keypad. If you feel more comfortable using a desktop keyboard, you can connect a USB external keyboard to one of the USB ports. You can also connect a USB mouse or other pointing device to one of the USB ports.



Ethernet (LAN)

With the built-in Ethernet LAN, you can make LAN connections with 10/100/1000 Mbps connection speed. To use the network feature, connect an Ethernet cable from the network jack on the left side of the device to a network jack or hub on your network.



Ethernet Port (RJ45)

Audio Devices

Audio devices are easy to connect with the audio ports accessible from the left side of the device. You can plug an external microphone (or an audio line-in device) into the line-in jack. Amplified speakers or headphones connect to the line-out jack.

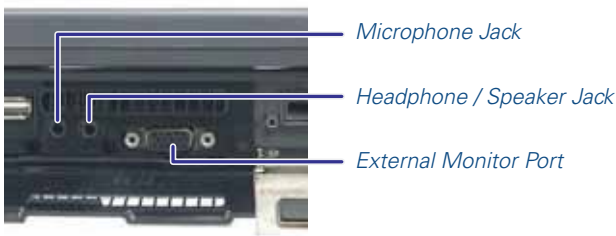

Microphone Jack

Headphone / Speaker Jack

External Monitor Port

External Monitor or Video Device

You may use an external monitor simultaneously with your notebook's display, instead of your notebook's display, or as an extension of your notebook's display. To attach an external monitor, do the following:

4. Connect the video signal cable from the external monitor (or the VGA adapter) to the external monitor port on the left side of your device.
5. Connect the power cable from the external monitor to a power outlet and turn on the monitor.
6. Read the monitor manual for additional instructions.

Using Simultaneous Display

Your device takes advantage of Windows dual-display capability, allowing you to use your device for presentation purposes. To use simultaneous display, connect an external display device to the external monitor port. You can then toggle the display output location by pressing **Fn + F2** . It will output to your device's display, the attached external display, or both displays simultaneously. Keep pressing **Fn + F2** until you have the output option you want.

Using Extended Display

When using an external monitor you can extend your desktop. This allows you to open and view one program on the external monitor while viewing a different program on your laptop's display.

Windows 7:

1. Select **Start, Control Panel, Appearance and Personalization**.
2. Under **Display**, select **Connect to an external display**.
3. On **Multiple displays**, click **Extend these displays**. Then click **Apply**.

Wireless Communication

This notebook supports up to four integrated radios for superior wireless communication (One radio per category listed below).

- Wireless Local Area Network (WLAN)
- Wireless Wide Area Network (WWAN) with CRMA Express
- Global Positioning System (GPS)
- Bluetooth

Since each customer's radio configuration is unique, please read the radio help installed on your desktop and refer to the manufacturer documentation to setup and use your radio(s).

If you have the Radio ON/OFF option, slide the **Radio ON/OFF Switch** to the left to power off all radio devices (airplane mode).

CAUTION FAA regulations require that all transmit/receive devices be turned off during flight. If you have radios in your device (including GPS) and your device is equipped with a Radio ON/OFF Switch, please use it to turn your radios off during flight. If you have radios and you do not have a switch to turn the radios off, either leave your device off during flight or contact your help desk for assistance.

WLAN radio option

Your device may include an integrated Wireless Local Area Network (WLAN) capability. See the radio help file on your desktop for more information.

About WLAN

WLAN provides all the features and benefits of traditional LAN technologies, such as Ethernet, without the limitations of wires or cables. It enables mobility and flexibility without compromising connectivity for today's mobile user.

CRMA Express WWAN (Option)

If you ordered the CRMA Express module option, your device may support one or more of these Wireless Wide Area Network (WWAN) radios:

LTE

LTE (Long Term Evolution) is part of the GSM evolutionary path beyond 3G technology, following EDGE, UMTS, HSPA (HSDPA and HSUPA combined) and HSPA Evolution (HSPA+). The overall objective for LTE is to provide an extremely high performance radio-access technology that offers full vehicular speed mobility and that can readily coexist with HSPA and earlier networks.

The main advantages with LTE are high throughput, low latency, plug and play, FDD and TDD in the same platform. LTE will also support seamless passing to cell towers with

older network technology. LTE downlink peak data rates up to 50Mbps with 10MHz (category 3, MIMO).

HSPA+

High-Speed Packet Access Plus (HSPA+) is also known as HSPA Evolution and Evolved HSPA. HSPA+ was standardized in recent releases. HSPA+ will apply some of the techniques developed for Long Term Evolution (LTE) and allow operators to extend the life of their HSPA networks. HSDPA+ deployments/cards/modules can support up to 42 Mbps downlink and up to 5.76 Mbps in the uplink mode.

HSPA

High-Speed Packet Access (HSPA) combines High-Speed Download Packet Access (HSDPA) and High-Speed Upload Packet Access (HSUPA). It is a 3G GSM Mobile protocol in the HSPA family, which provides a roadmap for UMTS-based networks to increase their data transfer speeds and capacity. HSPA deployments/cards/modules can support 1.8 Mbps, 3.6 Mbps, 7.2 Mbps and 14.4 Mbps in downlink mode and 2.0 Mbps and 5.7 Mbps in the uplink mode.

EDGE/GPRS/GSM Network

The Enhanced Data Rates for Global Evolution (EDGE) network allows users to transfer data with download speeds up to 237 Kbps (70-130 Kbps typical). It is more than three times the speed of GPRS. The EDGE network can help you perform at higher levels of productivity by providing real-time wireless access to critical business systems and applications.

UMTS/GPRS/GSM Network

Universal Mobile Telecommunications System (UMTS) - also referred to as wideband code division multiple access (W-CDMA), is one of the most significant advances in the evolution of telecommunications into 3G networks.

UMTS is a worldwide standard for wide-area wireless data communication based on Global Systems for Mobile communications (GSM™). UMTS provides broadband mobile access to business systems and applications that can help improve mobile users' productivity.

UMTS provides broadband speeds with download speeds up to 2Mbps (220-320 Kbps typical). It delivers four-to-six times the speed of dial-up Internet access and eight times the speed of GPRS wireless data service. UMTS allows mobile users to respond to urgent email and access the Internet.

EV-DO Rev A/EV-DO Rev 0/1xRTT/CDMA

CRMA Express is upgradeable and when WWAN radio technology changes, you can change with it. You can upgrade your radio to the various supported CRMA Express modules through Twinhead International Corp. service centers,

Wireless Communication

giving you greater wireless access when you need it. After initialization the first time the unit is booted, refer to the radio help found on your desktop for information about setting up and using your radio.

NOTE All WWAN radios are capable of backward compatibility to support slower technologies when necessary to provide the greatest possible coverage to the user.

EVDO Rev. A

EVDO Revision A (1x Evolution-Data Optimized) is a wireless radio broadband data standard that offers download speeds up to 3.1 Mbps (500 to 800 Kbps typical). Revision A integrates faster data technology and improves latency. These enhancements allow features such a VoIP and video calling.

EV-DO Rev 0

Evolution Data Only or Evolution Data Optimized (EV-DO) Rev 0 is a 3G wireless technology with average user download speeds up to 2.4 Mbps (400-700 kbps typical). When you spend a lot of time away from your desk, the faster speeds from EV-DO can lead to greater productivity. It's more than just fast email retrieval. Get fast and secure access to your information and applications with EV-DO. EV-DO Rev 0 was upgraded to EV-DO Rev A.

1XRTT - Single Carrier (1x) Radio Transmission Technology

1xRTT is a pre-2G wireless technology based on the CDMA platform. It has the capability to provide ISDN like speeds that offer up to 144 Kbps (50-70 Kbps typical). 1xRTT is also referred to as CDMA2000. 1xRTT was upgraded to EV-DO.

GPS (option)

The Global Positioning System (GPS) is a worldwide radio navigation system formed from a constellation of satellites and their ground stations. GPS uses these satellites as reference points to calculate positions accurate within five meters.

Bluetooth (option)

Bluetooth is a short range, wireless technology. Bluetooth systems create a Wireless personal-area network (WPAN). When Bluetooth-capable devices come within range of one another, an electronic conversation automatically takes place to determine whether they have data to share or whether one needs to control the other. Then, the devices hop frequencies in unison so they stay in touch with one another and avoid interference with other devices.

Bluetooth devices send out weak signals of 1 milliwatt. Class II Bluetooth devices have a range of about ten meters while Class I devices have a range up to 100 meters. The R8300 Bluetooth option is a Class I device with the greater range.

Even with the low power, the walls in your house won't stop a Bluetooth signal. This makes the standard useful for controlling several devices in different rooms. However, obstructions such as walls do degrade the signal and reduce its range.

Antennas

This notebook has several embedded antenna options to support wireless communications. They require no user action.

CAUTION Use only the supplied or an approved antenna(s). Use of unauthorized antennas, modifications, or attachments may void your warranty and could impair call quality, damage the radio, or result in violation of FCC regulations.

This notebook may contain the radio transmitters listed below. The following statements are relevant when using these radios:

This device may contain a WLAN radio transmitter, a WPAN radio transmitter, and a WAN radio transmitter.

Each internal radio may or may not have an individual FCC Identifier label. That FCC Identifier label is not applicable to this configuration. Only the external FCC ID label is applicable.

Only the antenna with which an intentional radiator is authorized may be used with the intentional radiator.

The WAN embedded antenna location is in the upper center edge of the display screen and is not to be modified.

The WPAN embedded antenna location is near the lower left edge of the Keyboard and is not to be modified.

The WLAN embedded dual antennas are located internally in the upper right and left edges of the display screen and are not to be modified.

To comply with FCC RF exposure requirements when using the WAN radio transmitter, a minimum separation distance of 20 cm must be maintained between the upper center edge of the display screen antenna and all users/bystanders.

When using the WLAN transmitter, a minimum separation distance of 20 cm must be maintained between the upper right and left edges of the display screen and all users/bystanders.,

The WAN transmitter, WLAN transmitter and WPAN transmitter should be turned off before carrying the Laptop PC in order to comply with FCC RF exposure requirements.

Since each customer's radio configuration is unique, please read the radio help installed on your desktop and refer to the manufacturer documentation to setup and use your radio(s).

Improving Radio Coverage

Radio connectivity between your device and your wireless network may vary at different times of the day and in different types of weather. It may also be influenced by terrain, buildings or even a crowded room. Follow these tips to improve radio coverage between your device and your wireless network, depending on your location.

On the Street

- Try all sides of a building to see which side provides the strongest radio signal.
- Move from under trees. Pine needles absorb radio signals more than leaves.
- Move away from overhead electrical wires.
- Move away from buildings. Radio signals reflect off other buildings.
- Try not to hold the unit. If possible, place it in a vehicle, on a cabinet or desk.
- If holding the unit, turn the unit in 90-degree increments to avoid shielding it with your body.
- Move several feet in any direction if needed for a stronger signal since the signal is 1-2 feet across.

Inside a Building

- Move toward windows.
- Move above ground. Signals do not penetrate the ground so there will probably be no signal in basements.
- Try the side of the building that is least likely to have coated windows. Reflective coatings on windows reflect radio signals.
- Open blinds. Closed metal blinds can reflect radio signals.
- Try different rooms. Dropped ceilings sometimes hide an accumulation of electrical cable.
- Avoid sources of Electromagnetic Interference (EMI). Electromagnetic Interference (EMI) is generated by switching circuitry closets or Un-interruptible Power Source (UPS) systems found near computer rooms and can block the radio signal.

When to use Landline Communication

If these tips do not improve radio signal strength, switch to landline communication. Switching to landline communication is faster than searching for and trying to improve the radio signal.

Operating with Battery Power

This notebook operates on AC or battery power. This section contains the information you need to know to operate the device on battery power and describes how your device manages and saves power. Effective use of power management options can greatly conserve and extend your battery life.

Be sure to read the **Battery Safety and Precautions** section.

Frequently Asked Battery Questions

Does it harm the Li-Ion battery pack to frequently “top off” the batteries?

No. Connect the device to an approved charging source whenever available.

What constitutes a charge cycle?

A full recharge of the battery to 100%.

Where can general battery charge state information be obtained?

To see how much power the battery has left, move the cursor over the **Power Saver** icon (🔋 or 🔌) or **DynaPower** icon (🔋) in the System Tray area of the Taskbar. The status will show as a pop-up.

What effect will temperature have on battery life and performance?

Using the device at very low temperatures will reduce the battery performance and may decrease how long the battery lasts compared to operation at moderate temperatures. The battery performance will recover when the device returns to a normal range, around 20°C (68°F). However, storing Li-Ion batteries at low temperatures reduces Li-Ion aging effects.

The Battery

- Employs current battery technology standards. The device uses a “smart” Lithium-Ion battery to consistently provide the long battery life best suited for mobile users.
- Uses a temperature sensor and memory device to gather and store information about the battery, such as how much charge is left and how many times it has been recharged.
- Warns when the battery charge level is low by sounding an alarm beep or displaying a warning on the screen. If you receive a battery low warning you should save your work and recharge the battery as soon as possible.
- Use the AC adapter whenever possible and consider carrying an extra fully-charged battery as backup.

Using a battery for the first time

The first time you use the battery, you should:

- Connect the AC adapter to the device and a power source.
- Calibrate the battery to set the gas gauge to accurately reflect battery capacity. You only need to do this once with a new battery or with a battery that’s been stored without being used for a long time. If the device will be stored for more than two weeks, it is recommended you remove the battery.

Battery and Temperature

The battery is most efficient at room temperature. It operates in a wide temperature range but the battery capacity is affected by higher or lower temperatures.

WARNING Do not expose the battery to temperatures below 0°C (32°F) or above 46°C (115°F). This may adversely affect the battery pack.

NOTE While the battery may not provide 100% capacity at temperature extremes, its capacity is restored when the battery temperature return to a normal range, around 20°C (68°F).

Temperature	Approximate Available Capacity
0°C (32°F)	80%
20°C (68°F)	100%
45°C (113°F)	100%

Operating with Battery Power

Replacing the Battery

CAUTION Before removing the battery pack, make sure that you have an AC adapter connected to the device or a media bay battery installed; otherwise, first turn off the device.

To Remove the Battery:

1. Plug in AC power or turn off the device.
2. Turn over the notebook so you are looking at the bottom.
3. Press and hold down the battery lock in the hinge to unlock the battery.
4. Slide the battery release latches toward the inside of the device to release the battery.
5. Gently slide the battery out of the notebook.



Press down Battery Lock Battery Release Latches

To Install the Battery:

1. Turn the notebook over so you are looking at the bottom.
2. Align the battery connector.



3. Press gently on the battery until it clicks into place.

NOTE When using a battery pack for the first time, it is recommended that you calibrate the battery so the gas gauge accurately displays battery capacity.

Battery Charging

To charge the battery, install the battery pack and plug the AC adapter into the device and an electrical outlet. You can use your device while charging the battery. However, this will increase the charging time.

While the battery is charging, the **Battery Power LED**  will be active after 6-12 seconds and stay lit until the battery is fully charged. When the battery is fully charged, the LED turns off.

If your device is off or suspended, a fully discharged battery takes about 4 hours to recharge. If your device is turned on it may take four to six (4- 6) hours to recharge the battery.

State	Charging	Discharging
System On	3-6 hours depending on temperature and processes running	6-8 hours
System Off	3 hours	-
Suspend to RAM		72 hours
Suspend to Disk		7 days

NOTE A fully charged battery can power the device for approximately eight (8) hours, depending on usage patterns. If your device also has the optional Media Bay battery, it will power the device for an additional four (4) hours.

When to Replace the Battery

Over time, the battery's capacity gradually decreases. We recommend that you replace your battery if it no longer provides 70% of its original rated capacity.

WARNING Only use approved batteries when replacing the battery.

Heat Considerations

The device's processor has been specially designed to consume as little power as possible. However, working in a hot environment, or working for long periods may raise the temperature. Your device takes the following steps to lower temperature:

- The cooling fan turns on. You may hear the fan and feel air coming from a vent on the left side of the device when this happens.
- If the temperature continues to rise, processor activity is reduced. You may notice a slight loss of performance if this happens.
- To prevent damage, if the device gets too hot, the processor stops and the device shuts down.

Operating with Battery Power

Battery Calibration

Over time, as the battery is repeatedly drained and recharged, battery runtime may decrease. Calibrate the battery the first time you use it and then periodically for maximum performance. The calibration process empties and charges the battery. This allows the Windows battery gauge to accurately monitor battery status.

Battery calibration will take from 6 to 12 hours, depending on how much power the battery already contains. The unit will not suspend while calibration is running. It is okay to use your device during battery calibration.

CAUTIONS

- Do not disconnect AC power while battery calibration is running.
- Do not remove the battery while battery calibration is running.

When to calibrate the battery:

- The first time you use it
- After it has been in storage
- If the gas gauge has become inaccurate
- Every three months for optimum performance

Windows 7 Battery Calibration

1. To run the **Battery Calibration** program select **Start, All Programs**, and **Mobile Computer Tools**.
2. Next, select **DynaPower Battery Calibration**. If you get a pop-up window asking if you want to allow the program to make changes to the device, select **Yes**.
3. Select **Start** to begin calibrating or **Cancel** to exit.

NOTE The battery calibration process may take up to 8 hours to complete.

About Battery Calibration

Battery calibration may take up to 12 hours to complete. After starting calibration, the application requires no further input from the user. During calibration it goes through three steps:

1. Charge - the battery is fully charged to 100 %.
2. Discharge and calibrate - the battery is discharged to zero, then calibrated but not charged. You may stop the process after this point and let the battery charge outside of the battery calibration application.
3. Charge - if battery calibration continues running, the battery will fully charge to 100%.

Managing Power

Your device has power management capability so you can reduce the amount of energy used, especially during periods of inactivity. Effective use of power management options can greatly conserve and extend your battery life. The power management unit monitors system activity, such as hard drive, keyboard, mouse, or any devices attached to a port. If it does not detect activity for a period of time, the device stops some or all of these devices to conserve energy.

Your device employs a power management scheme that supports ACPI (Advanced Configuration and Power Interface), allowing for maximum power conservation and maximum performance at the same time. Windows handles all powersaving chores for your device.

For more information search for **Power Options** in Microsoft® **Help and Support**.

Low-Power States

Your device can enter three different low-power states to conserve power: Standby/Sleep, Hibernate and Power Off.

These states can be entered manually or after a period of inactivity. From the **Power Saver** or **DynaPower** utilities, you can configure the Power Button, Sleep Button (**FN+F3**) and Lid Switch to initiate any of the low-power states.

Standby/Sleep

Most system devices are powered off, but the contents of system memory are retained. Standby/Sleep is sometimes referred to as Suspend to RAM. When the device returns from Standby mode, the desktop appears with the same files and programs open as when the device was suspended. Resume time is very quick.

Windows 7: Select **Start** and click on the arrow next to the Shut down menu. Then select **Sleep** to enter Standby/Sleep mode.

Hibernate

Hibernate, or Suspend to Disk, is similar to Standby except the current state of the device is copied to the hard disk in a special file. Then, all equipments in the device are turned off. When the device returns from hibernation, the desktop appears with the same files and programs open as when the device was suspended. Hibernation saves more power than Standby, but takes slightly longer to resume.

Windows 7: On the System tray area of the Taskbar, right click the **DynaPower** icon, then select **DynaPower Grid** and make your desired changes.

Power Off

All applications are closed and the system shuts down. To power off the device, select **Start, Shut Down**.

Operating with Battery Power

Battery Tips

Tip 1. Avoid excessive heat and cold

- Your battery will last longer during the day if it is used, charged and stored between 50°F and 86°F (10°C and 30°C).
- Charge the battery nightly where the temperature will remain around 68°F (20°C). Your battery may not last as long through the day if you charge it at higher or lower temperatures.
- Allow unrestricted airflow while the device is connected to external power. Make sure that the fan inlet and outlet are unobstructed.
- Avoid exposure to extreme temperatures for long periods as this can shorten battery charge life or damage the battery.

How your battery behaves in warm conditions

- To prevent possible battery damage, the system may not allow a charge if the battery temperature is above 122°F (50°C), such as in a closed, unattended vehicle during the summer. In this case, the **Battery LED**  may indicate the device has stopped charging your battery; however, your battery may not be fully charged.
- If possible, turn off or suspend your device while the battery is charging in a warm environment to avoid overheating.
- In warmer temperatures, your battery may take much longer to fully charge.

How your battery behaves in cold conditions

- When using a battery in cold conditions, the battery capacity may drain significantly faster than normal.
- To prevent possible battery damage, the system will not allow a charge if the battery temperature is below 41°F (5°C), such as in a closed, unattended vehicle during the winter. In this case, the **Battery LED**  may indicate the device has stopped charging your battery; however, your battery may not be fully charged.
- In cooler temperatures, your battery can take much longer to fully charge.

Tip 2. Prevent wasted power

- Manually turn off or suspend your device whenever you are not using it.
- Reduce the screen brightness. Decrease brightness by pushing **FN + F6**. Increase it by pushing **FN + F7**.
- Enable the display's **automatic dimming feature**.
- Use the AC adapter or vehicle adapter whenever possible.

- To help save power, use the DynaPower utility.
- When running on battery power, make sure your system suspends automatically after a few minutes of inactivity. PC Cards, radios, custom applications, or modified system settings may affect this.
- Remove PC Cards and unplug peripherals when you are not using them. They may draw power from the system even when not in use.
- Avoid operating the fax/modem, or audio and video applications when using battery power. Operating a fax/modem, video, or audio equipment increases the device's power requirements.
- Don't use screen savers as they draw excessive current, especially "3D" screen savers.
- Turn off the Wireless LAN when not using it. Turning on the Wireless LAN increases the device's power requirements.
- Avoid or minimize using applications that keep the CPU busy a large percentage of the time. The following will help you determine if your system is running such applications:

Identifying power wasting programs

To determine if applications or processes are keeping the CPU busy:

1. Start the **Task Manager** utility. To open **Windows Task Manager**, right-click an empty space on the taskbar, and then click **Start Task Manager**.
2. Select the **Performance** tab to view running applications, and the **Processes** tab to view running processes.
3. Watch the CPU Usage. It is okay if the processor usage is occasionally 100 percent, but if it is 100 percent most of the time, this may indicate a problem.

What to do if applications are keeping the CPU busy

- If possible, close applications that keep the CPU busy when you are not using them.
- Turn off or suspend your device whenever you are not using it. This will help to conserve power.

Tip 3. Calibrate your battery

Over time the accuracy of the Windows battery gas gauge battery. Calibrating the battery every 3 or 4 months helps to keep the gas gauge accurate. Refer to **Battery Calibration** for more information.

Operating with Battery Power

Tip 4. Get a good charge

- Your device will charge more quickly if it is turned off or suspended.
- In warmer or cooler temperatures the battery can take much longer to fully charge.
- If your battery is charged in a cold (less than 41°F/5°C) or very warm (greater than 122°F/50°C) environment, it is possible that the **Battery LED**  will indicate that the charge has stopped; however, this does not necessarily mean that your battery is fully charged.

Tip 5. Prevent data loss

Follow these guidelines to prevent data loss when removing your battery or storing your device:

- You will lose data if you remove the battery while the device is operating or suspended and AC power is disconnected. To prevent this, shutdown your device or put it into hibernate (suspend-to-disk) mode before removing your battery.
- If you plan to store your device for more than a few days, shutdown your device or put it into hibernate mode. **Remove the battery** before storing the device.

Tip 6. Clean terminals

Dirty terminals can be a cause of charging problems. Clean battery terminals with a cotton swab dipped in isopropyl alcohol. Make sure that the alcohol has evaporated before reinstalling the battery.

Tip 7. Storing batteries

Stored Li-Ion battery packs gradually deteriorate, particularly if they are not stored in ideal conditions, and their life expectancy decreases. When storing Li-Ion battery packs for extended periods, consider these recommendations:

- When storing batteries for extended periods store them between 3°C to 7°C (38°F to 45°F) to slow self-discharge and battery aging. If you store batteries at normal ambient temperatures, use the following charging policy to maintain battery pack condition:
 - Charge installed batteries every 21 days to maintain their charge capacity.
 - Charge uninstalled batteries every 6 months.
- Unused or stored batteries can lose power over time. When you install a battery that has not been used recently, connect external power to the device and fully charge your battery.

- Fully charged Li-Ion batteries deteriorate faster than partly discharged ones. For ideal storage, charge the battery to 100% and then discharge them to 50% charge before storing.
- Do not allow stored Li-Ion batteries to discharge completely, as this may permanently damage them. Stored batteries should be recharged to 50% capacity every six months.

When you turn your device on, the system reads the BIOS Settings to test and initialize components and make sure everything runs properly when the system is operating. You can use the Setup Utility to change your device's startup configuration. For example, you can change your system's security routine.

This notebook is configured with a set of default values. The default values may not be appropriate for your work environment. For example, you can set a boot password to protect your system when booting.

CAUTION It is recommended that you use the default settings. If you set incorrect system option settings, the system may not run properly.

In this section the default field values are shown in bold.

Starting the Setup Utility

You can only start the Setup Utility shortly after the device has been turned on or rebooted. To execute a controlled reboot, select **Start, Shut Down, Restart**. Shortly after the device restarts, press the **Del** key to enter Setup.

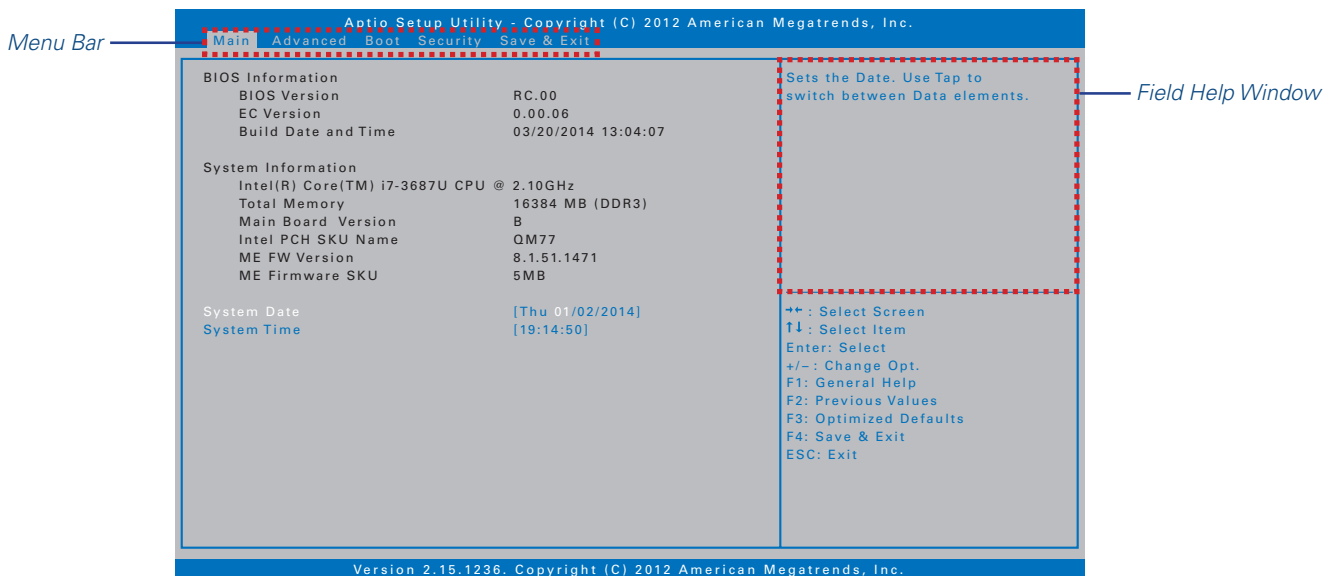

Navigation and Help

The Setup Utility has five menu options in the Menu Bar at the top of the window. Press the left or right arrow keys to cycle through these menu screens:

Main: Displays basic system information and allows you to set the date and time

Advanced: Use to set the advanced features

Boot: Use to select the sequence of boot devices that are searched to load an operating system

Security: Use to set user and supervisor passwords

Save & Exit: Use to exit the current Setup session

The **Field Help Window** is on the right side of each menu. It displays the help text for the currently selected field. This text updates as you move the cursor from field to field.

The **General Help Window** describes the legend keys. You can display it by pressing **F1** on any menu.

CAUTION Incorrect settings can cause your system to malfunction. To correct mistakes, restore the Optimized Defaults by pressing **F3**.

The Main Menu

The Main menu displays detailed information about the device, including the system time and date.

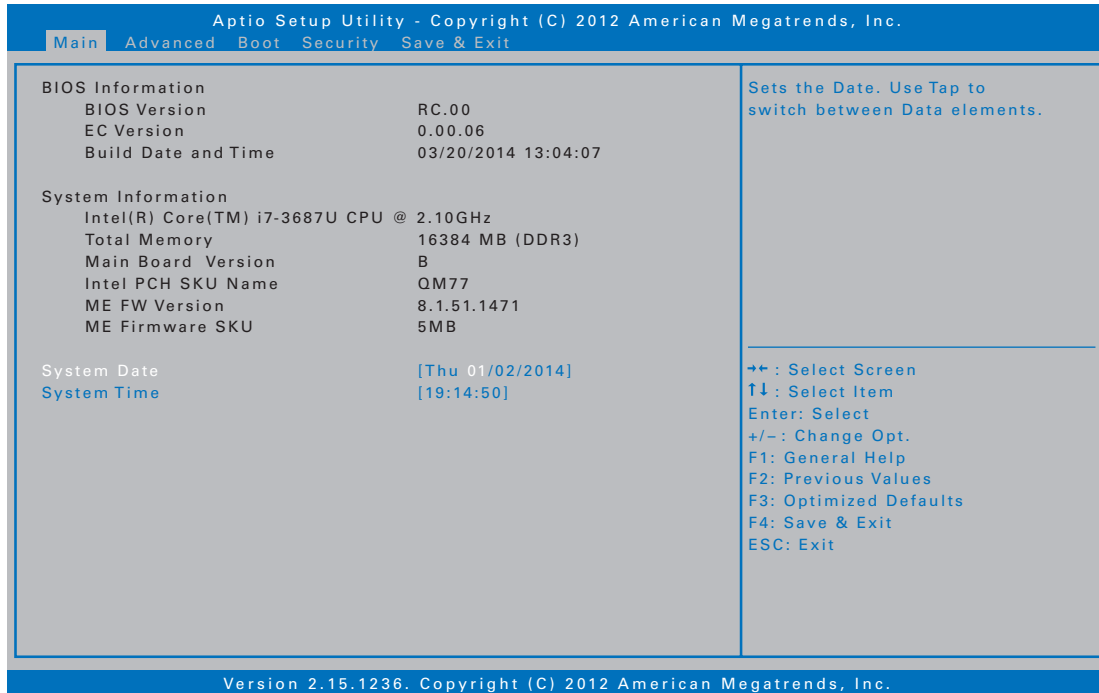

Field	Setting	Description
BIOS Information	N/A	Displays the BIOS version detected during boot up.
System Information	N/A	Displays the amount of memory detected during the boot process.
System Date	MM/DD/YYYY	Sets the date. The value set takes effect immediately. NOTE Once a change is made, press the Enter key to continue.
System Time	HH:MM:SS	Sets the time. The time is displayed in 24 hour format. The value set takes effect immediately. NOTE Once a change is made, press the Enter key to continue.

The Advanced Menu

The Advanced menu provides the user with the ability to configure specific system settings.

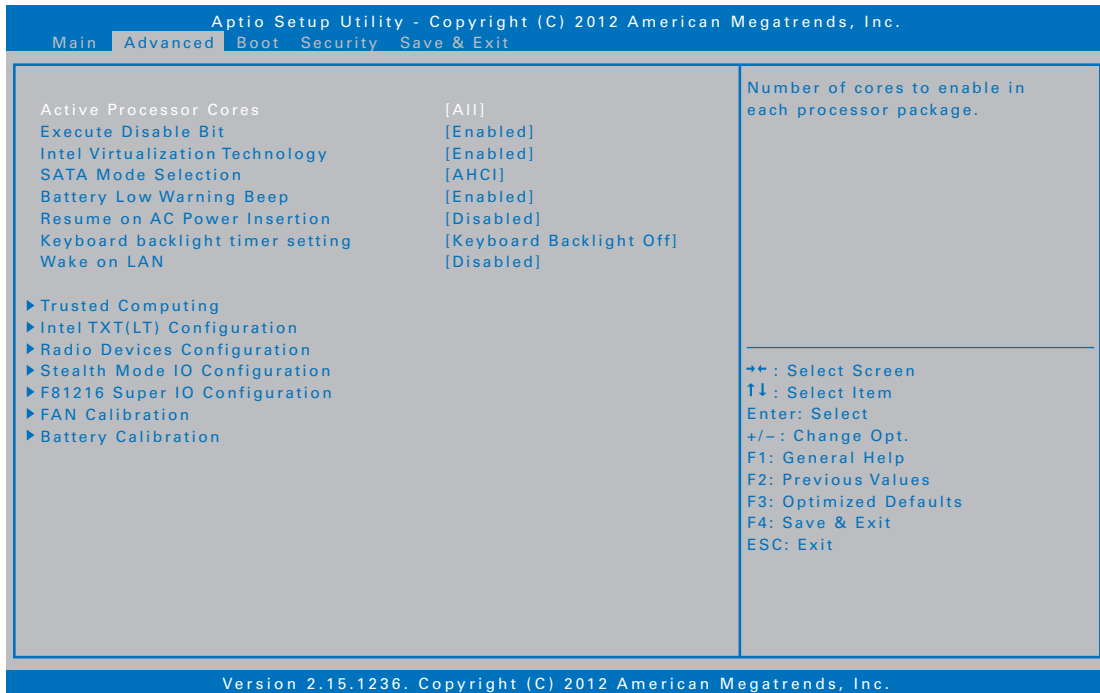

Field	Setting	Description
Active Processor Cores	All 1	Sets the number of cores to enable in each processor package.
Execute Disable Bit	Enabled Disabled	When enabled, XD can prevent certain classes of malicious buffer overflow attacks when combined with a supporting OS.
Intel Virtualization Technology	Enabled Disabled	When enabled, a VMM can utilize the additional hardware capabilities provided by Vanderpool Technology.
SATA Mode Selection	AHCI IDE	Determines how SATA controller(s) operate.
Battery Low Warning Beep	Enable Disable	When enabled, the system will sound 3 beeps per 10 seconds during both battery capacity below 7%.
Resume on AC Power Insertion	Disable Enable	When enabled, the system will wake from standby or hibernation state when the AC power is plugged.
Keyboard backlight timer setting	Keyboard Backlight Off 5~240 Minutes	Selects the length of time for keyboard backlight to remain lit before turning off. If the device is left idle for a specified period of time, the keyboard backlight will automatically turn off to conserve the battery power.
Wake on LAN	Disabled Enabled	Enables or disables integrated LAN to wake the system. (The Wake On LAN cannot be disabled if ME is on at Sx state.)
Trusted Computing	Submenu	Trusted Computing Settings
Intel TXT(LT) Configuration	Submenu	Intel Trusted Execution Technology
Radio Devices Configuration	Submenu	Enable/Disable Radio Devices

Field	Setting	Description
Stealth Mode Configurations	Submenu	Stealth Mode Setup
F81216 Super IO Configuration	Submenu	System Super IO Chip Parameters
FAN Calibration	Submenu	FAN calibration
Battery Calibration	Submenu	Battery Calibration

Trusted Computing

Trusted Platform Module (TPM) is a secure micro-controller with added cryptographic functions.

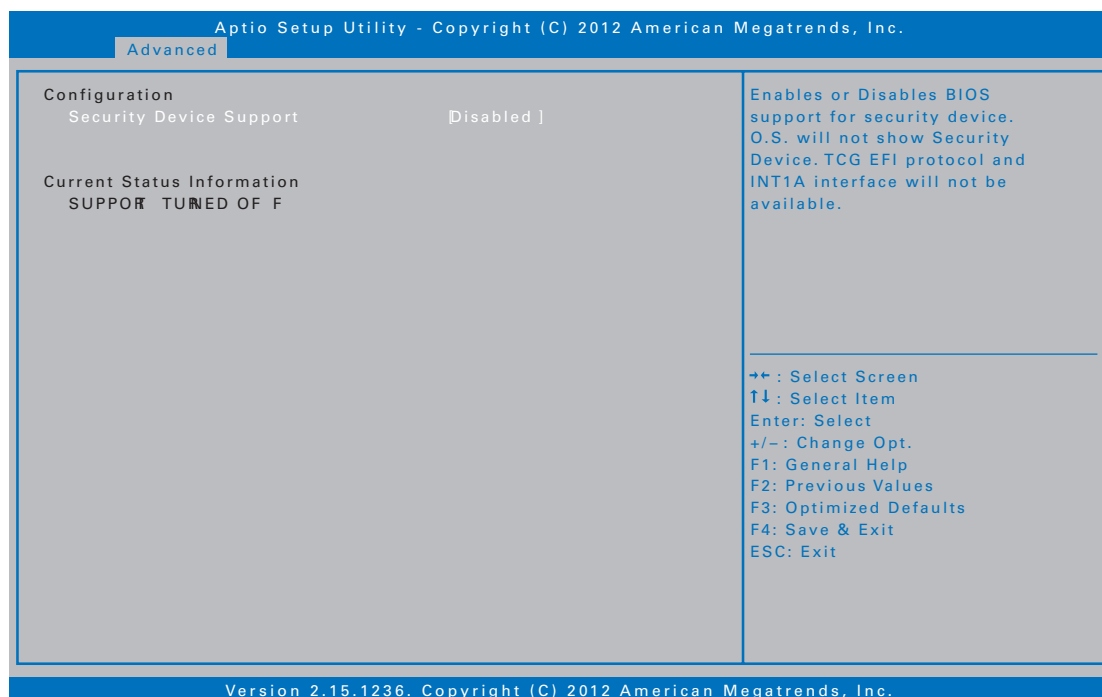

Field	Setting	Description
Security Device Support	Disable Enable	Enables or disables BIOS support for security device. Operating system will not show Security Device. TCG EFI protocol and INT1A interface will not be available.
Current Status Information	N/A	Displays the TPM status.

Intel TXT(LT) Configuration

This menu option only can be configured if the SMX is enabled. VT and VT-d support must be also enabled prior to TXT.

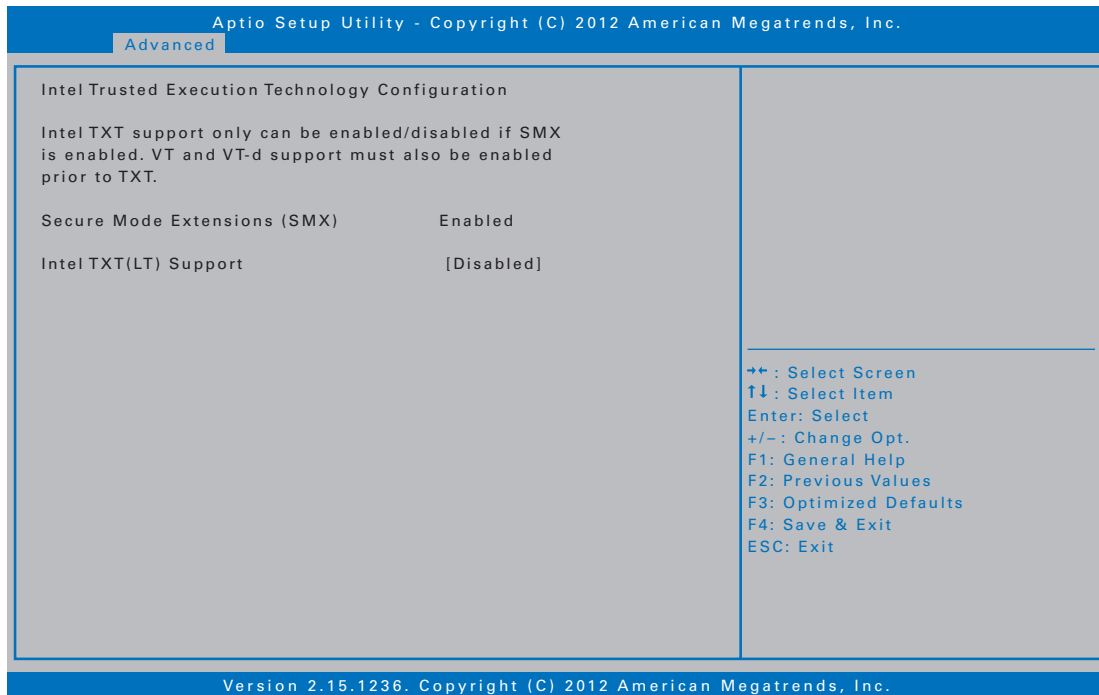

Field	Setting	Description
Secure Mode Extensions (SMX)	N/A	Displays the SMX status.
Intel TXT(LT) Support	N/A	Displays the Intel TXT(LT) Support status.

Radio Devices Configuration

This menu option allows you to configure the Bluetooth, WLAN, and GPS function.

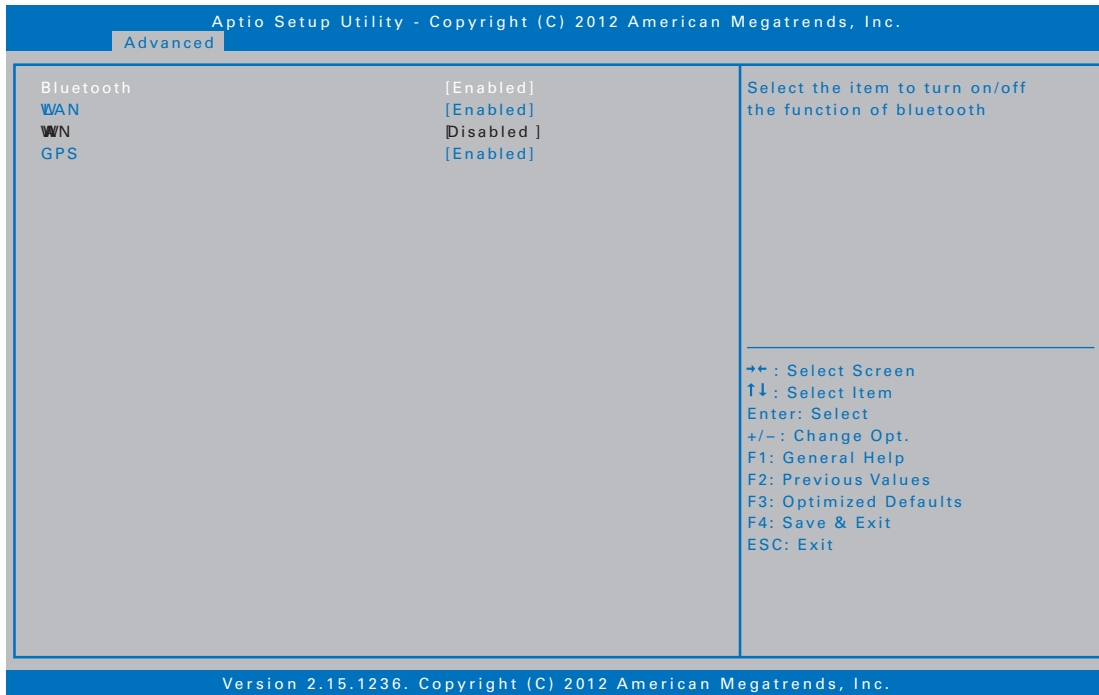

Field	Setting	Description
Bluetooth	Enable Disable	Enables or disable the Bluetooth function.
WLAN	Enable Disable	Enables or disable the WLAN function.
GPS	Enable Disable	Enables or disable the GPS function.

Stealth Mode Configurations

Stealth mode is a feature that allows the device to be used in an environment where sound and light could be dangerous or disruptive.

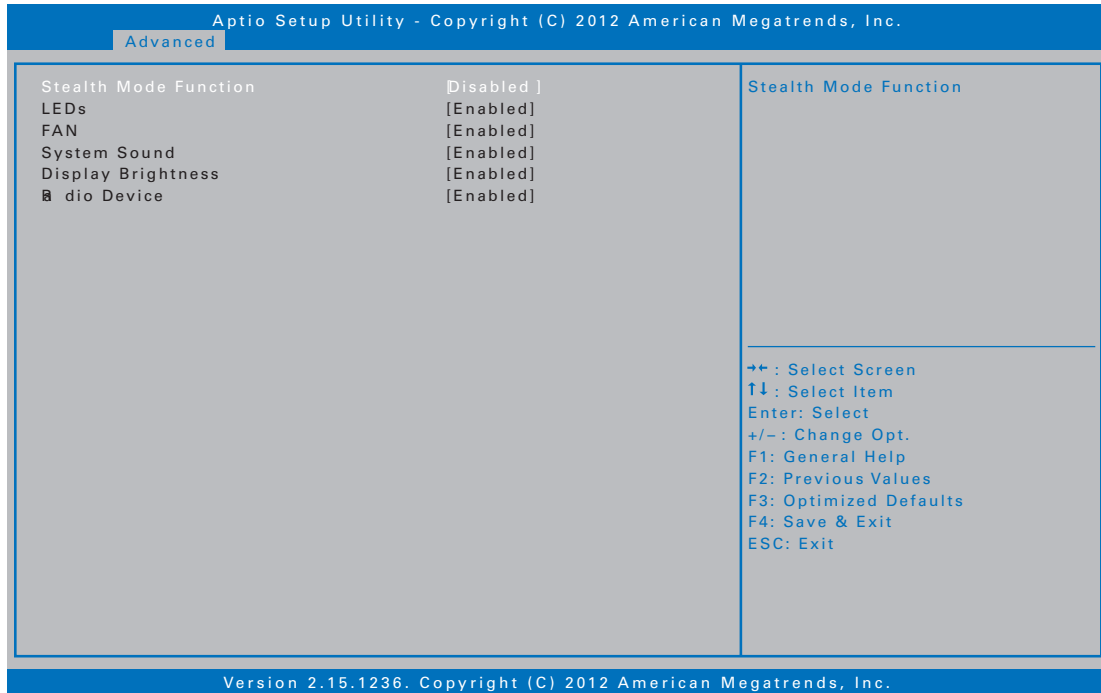

Field	Setting	Description
Stealth Mode Function	Disabled Enabled	When disabled, the LEDs, fan, system sound, display brightness, and system radio devices setting operate normally.
LEDs	Enabled Disabled	Enables or disables the LED indicators when the Stealth mode is enabled.
FAN	Enabled Disabled	Enables or disables the FAN function when the Stealth mode is enabled.
System Sound	Enabled Disabled	Enables or disables the system output sound setting when the Stealth mode is enabled.
Display Brightness	Enabled Disabled	Enables or disables the display brightness setting when the Stealth mode is enabled.
Radio Device	Enabled Disabled	Enables or disables the system radio devices setting when the Stealth mode is enabled.

F81216 Super IO Configuration

This menu option allows you to assign serial port settings.

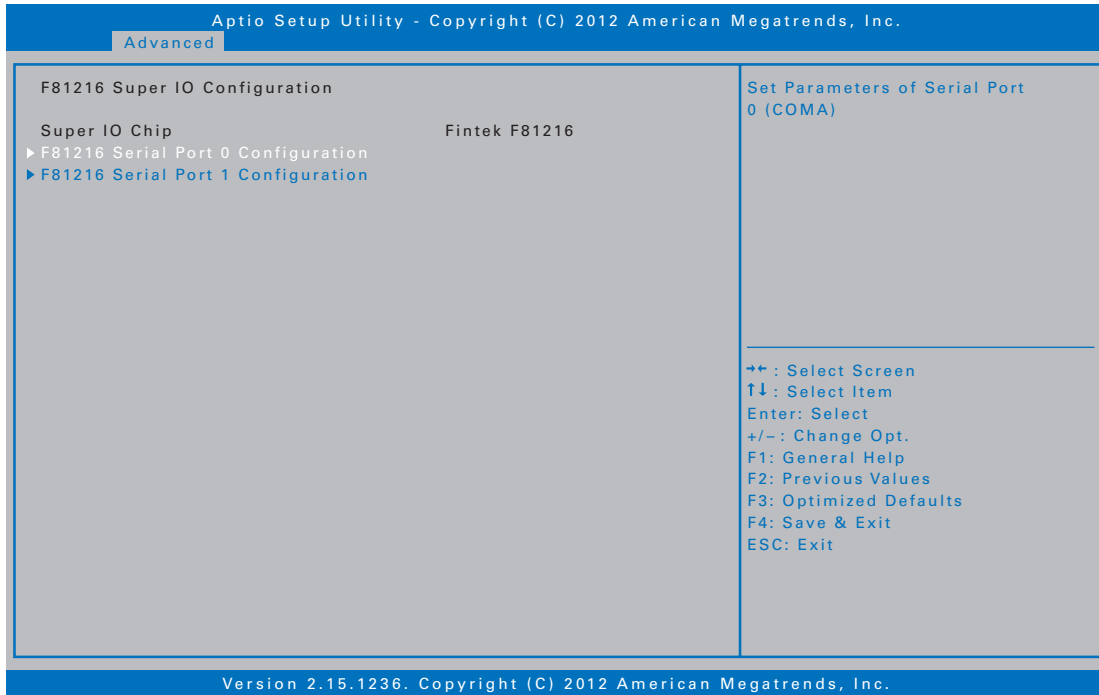

Field	Setting	Description
Serial Port 0 Configuration	Submenu	Allows the BIOS to select Serial Port 0 Base Addresses.
Serial Port 1 Configuration	Submenu	Allows the BIOS to select Serial Port 1 Base Addresses.

FAN Calibration

This menu option allows you to do the fan calibration. The calibration process takes approximately 3 minutes to complete.

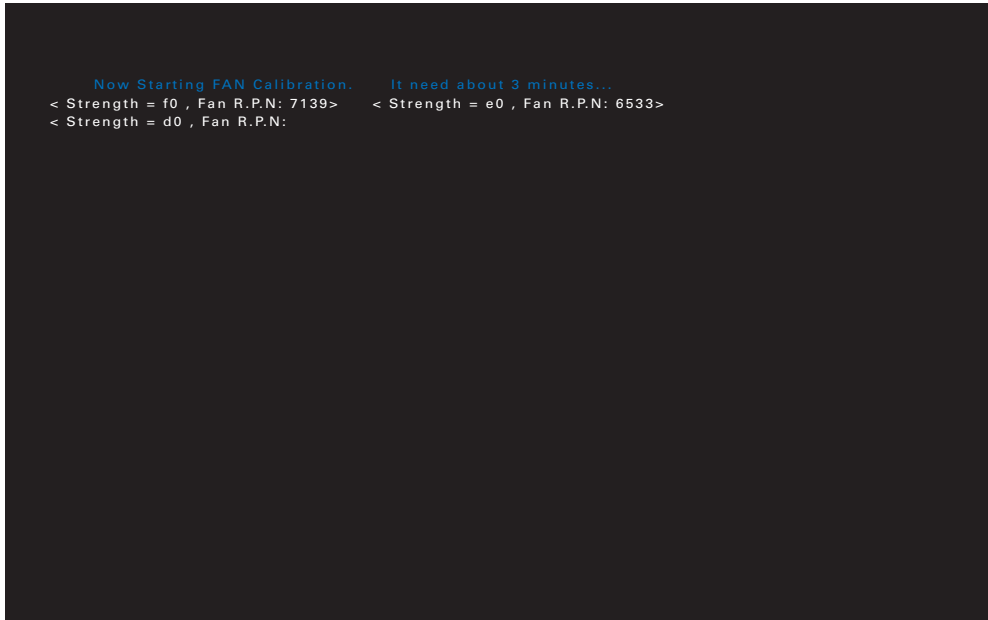

Battery Calibration

This menu option allows you to do the battery calibration. Be sure that the AC adapter and the battery are properly installed on the notebook. Then press any key to start the battery calibration.

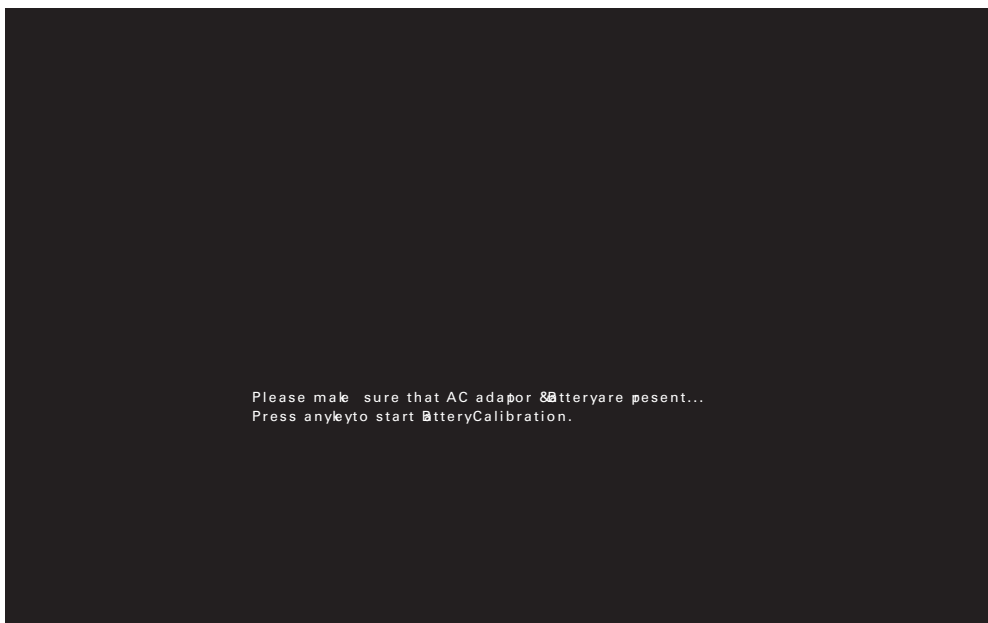

The Boot Menu

The Boot menu allows you to configure the boot settings and boot sequence, depending on your configuration. The boot device fields are dynamic and change depending on the devices installed on your notebook during that boot sequence. For example, if you have a DVD/CDRW Combo drive or a USB floppy drive installed, they appear as options in the boot device fields. If you only have a hard disk drive, it will be the only option that displays. When you select a device, it is disabled in the other boot device fields.

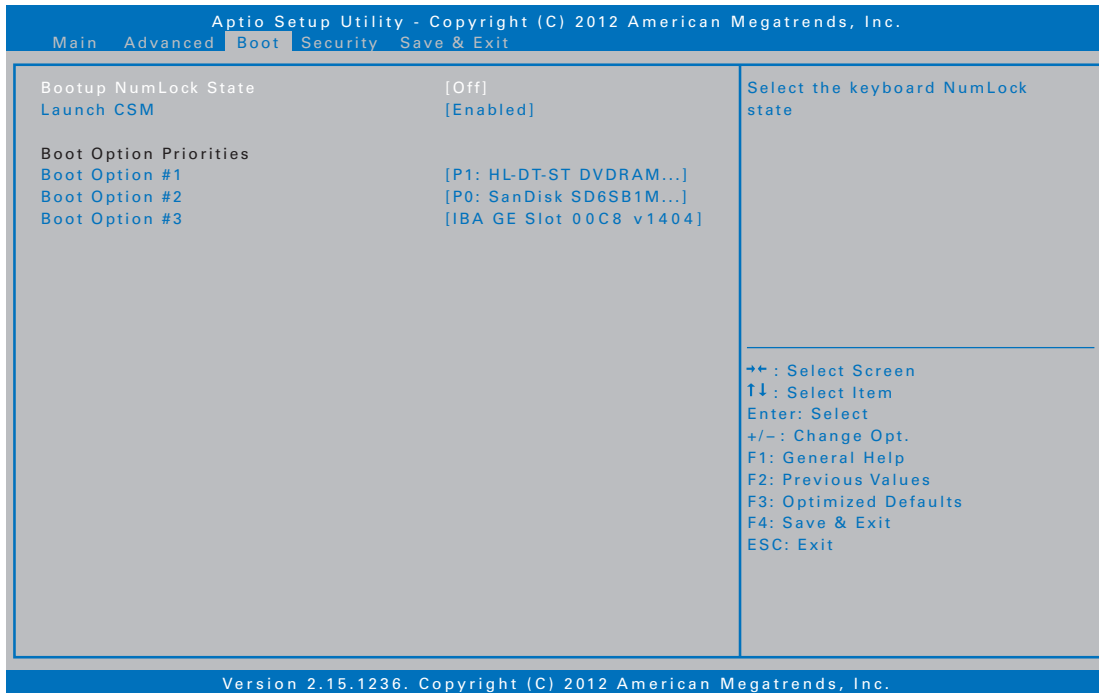

Field	Setting	Description
Bootup NumLock State	Off On	Select the keyboard NumLock state.
Launch CSM	Enabled Disabled	Enables or disables the system to launch an older operating system.
Boot Option #1		Sets the system boot order.
Boot Option #2		Sets the system boot order.
Boot Option #3		Sets the system boot order.

The Security Menu

The Security menu allows you to set or change the Administrator and User passwords.

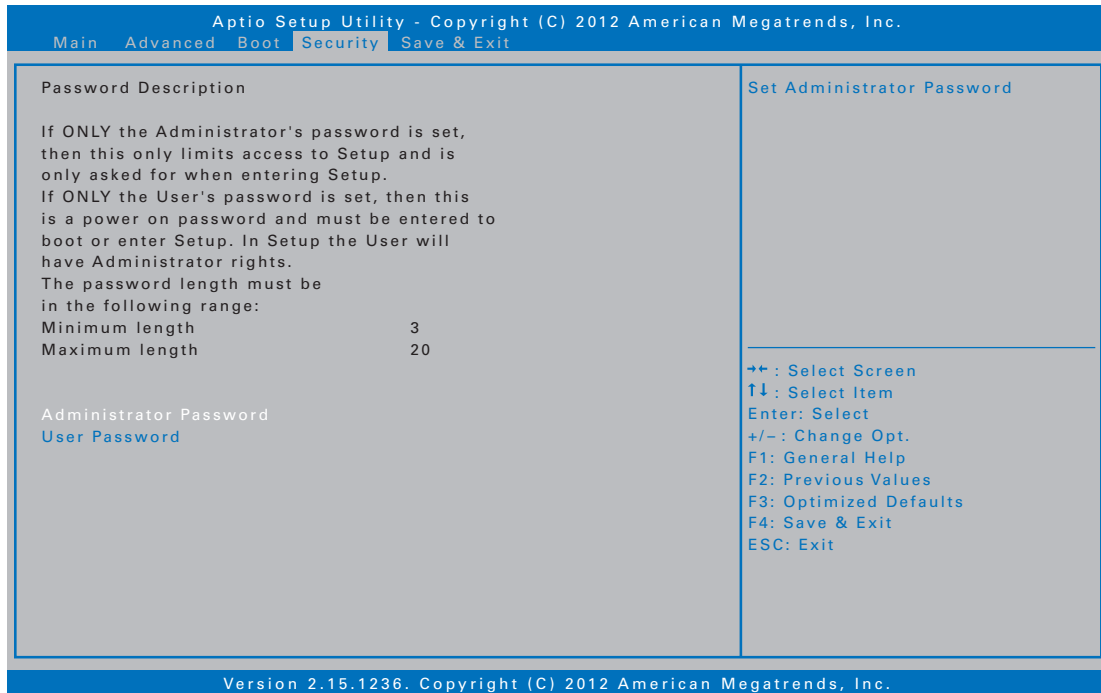

Field	Setting	Description
Administrator Password	Create New Password	Create the Supervisor password. This field must be set before a user level password can be set.
User Password	Create New Password	Create the User password.

The Save & Exit Menu

The Save & Exit menu allows you to save/discard the changes and restore the default values for all setup options before leaving the Setup Utility Menu.

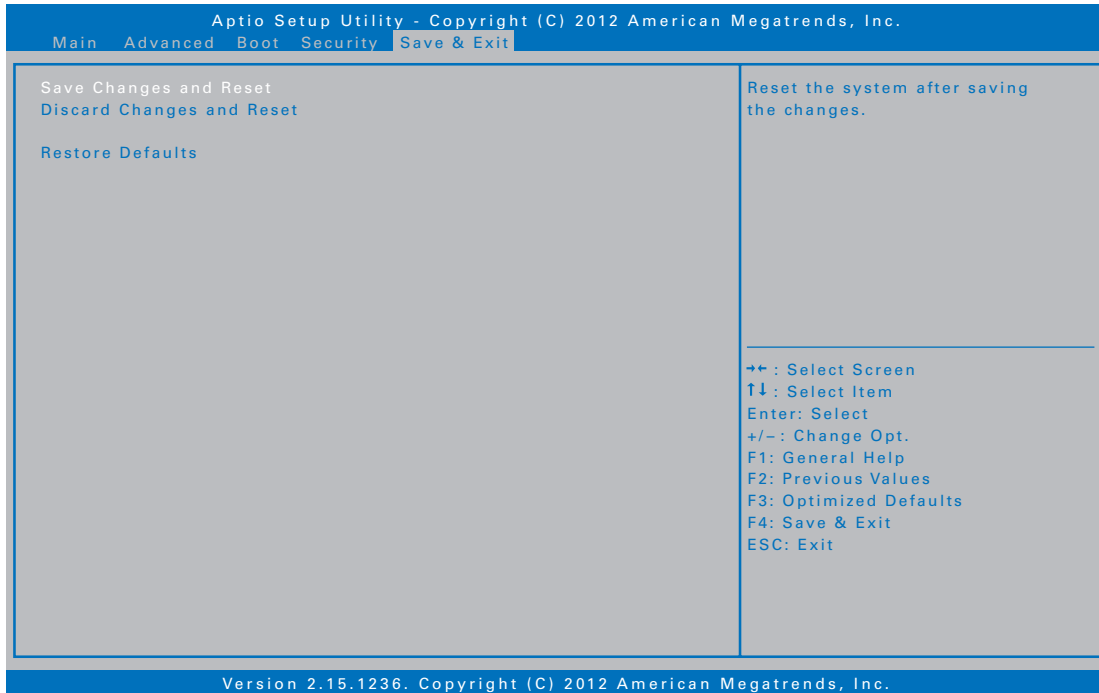

Field	Setting	Description
Save Changes and Reset	Yes No	Reset the system after saving the changes.
Discharge Changes and Reset	Yes No	Reset the system setup without saving any changes.
Restore Defaults	Yes No	Restore/Load default values for all the setup options.

Optional Equipment and Accessories

This notebook has several equipment and accessory options to further enhance your mobile computing experience from an optional shoulder strap to docking solutions. Click here for a current list of optional peripherals and accessories.

CAUTION Only purchase accessories that are approved for use with your device. Some accessories are proprietary items and can be obtained through your system vendor. If you use items that are not approved for use with this device, you may cause your device to malfunction, or to emit or receive electromagnetic radiation in excess of regulations. For non-proprietary accessories such as PC Cards or printers, ensure that the accessory functions properly with your device before making the purchase. Your system vendor may be able to recommend reliable brands and models.

Surge Protection

A large number of computer and high technology equipment damage is directly related to AC power and telephone line problems. These problems can include surges, spikes, noise, interference, and weather-related issue that may cause glitches, hang-ups, crashes, performance slow downs, and computer down time. It is recommended that you use a quality surge protector with your device and any attached peripherals.

Vehicle Adapter

The vehicle adapter is an optional device that supplies power from the vehicle battery to operate the device and charge the battery installed in the unit. It typically connects to the vehicle battery using the cigarette lighter socket.

CAUTION The vehicle adapter is only designed for temporary use. Use the optional vehicle dock to power and secure the notebook for frequent or long term vehicle installations.

To prevent possible damage to the battery, the system will not allow the battery to charge at extreme temperatures. Be aware of the following charging characteristics, especially if the device is left unattended in a closed vehicle.

Temperature	Charging Activity
<5°C (<41°F)	Battery will not charge
>50°C (>122°F)	Battery will not charge

To connect the vehicle adapter

1. Insert the vehicle adapter power cord into the power port on the device.
2. Insert the cigarette lighter adapter into the vehicle's cigarette lighter socket (12V), turning it slightly to make a good connection.

The Power LED on the adapter lights to indicate current is reaching it. When you connect the vehicle adapter, it automatically begins charging the device's battery. At moderate temperatures, around 20°C (68°F), the battery will be fully charged in approximately four to five hours. However, as the battery temperature approaches the ends of its temperature range (5°C/41°F to 50°C/122°F), it will take longer to charge the battery.

CAUTION Avoid exposing batteries to extremely hot or cold temperatures for long periods. To prevent possible damage to the battery, the notebook does not allow the battery to charge if the internal temperature of the battery gets too low (< 5°C or < 41°F) or too high (> 50°C or > 122°F).

Vehicle Dock

The vehicle dock is designed to safely secure the device in a vehicle. It includes a key lock for security. You can use the vehicle dock to:

- Charge batteries with voltage from the vehicle battery
- Communicate with other devices
- Automatically connect to an external antenna

CAUTIONS

- Do not open the vehicle dock case. It has no user-replaceable parts. The vehicle dock is internally protected; it resets automatically if there is a power fault.
- Do not use the vehicle dock to charge the device battery overnight. Turn off the vehicle dock at the end of each work day to prevent draining the voltage in your vehicle's battery below starting levels.

To charge a battery installed in the device

1. Place the device onto the vehicle dock, making sure it is securely latched.
2. If charging is required it begins automatically. The Battery Power LED lights.
3. When the battery is fully charged, the Battery Power LED turns off.

Optional Equipment and Accessories

CAUTIONS

- Refer to **Battery Tips** for recommended charging temperature ranges and other recommendations
- If you charge the battery daily rely on the gas gauge reading to determine battery capacity. The gas gauge may show that the battery is full while still charging. This happens because the charging process is trying to put a little more capacity into the battery. External power can be removed at this time since the battery is virtually full.
- If your battery is new or has not been used for several weeks, rely on the indicator light to determine when the battery is fully charged. The gas gauge is unreliable in these cases; it may read 100%, when the actual capacity is only 10%. **Recalibrate the battery** to correct this issue.

Communicating with Other Devices

Connect external devices to the ports on the back of the dock, and then place the notebook onto the vehicle dock. You can install or remove the device from the vehicle dock without connecting or disconnecting the cables.

External Antennas

The vehicle dock integrates GPS and WWAN antennas with switching capability. You can also connect an external RF antenna to the dock using the SMA RF connector on the back of the vehicle dock. FCC regulations require that users of vehicle-mounted antennas must use only antennas authorized for use with this notebook in order to meet FCC RF exposure limits. Please contact your organization's help desk for a list of approved vehicle-mounted antennas. Before mounting an external antenna, refer to the installation instructions provided with the antenna.

Vehicle-mounted Antenna Placement

WARNING Improper installation and/or operating configurations of permanent and magnetic vehicle-mounted antennas may cause FCC RF exposure limits to be exceeded. Vehicle-mounted antennas must be placed at least 20 cm from operators and bystanders and at least 92cm (36 inches) from any existing roof mounted antennas.

1. Measure and identify an area 20 cm (8 inches) in from the edges of the vehicle roof.
2. Place the antenna within that area.

To maximize RF performance, position the antenna in the center of the vehicle roof.

CAUTION Do not place any metal objects on top of the dock that might make contact with the metal pins of the contact connector. Doing so may cause an electrical short and subsequent damage to the dock.

Memory Upgrade

Adding memory allows the device to operate faster, handle more tasks simultaneously, and work more smoothly with large files. Users who increase memory demands - by adding additional programs, for example - may notice a slowdown in operating speed, and wish to increase memory. This notebook comes with a user accessible memory sockets for memory upgrades. Please consult your dealer if you need to add more memory.

CAUTIONS

- First read and follow the guidelines in the **Safety** section.
- Only use memory cards approved for use in your notebook. Failure to do so may void your warranty.

Maintenance and Storage

This notebook is rugged and weather resistant and you can use it under a wide range of environmental conditions. However, to ensure long use and continued high performance, follow these tips and precautions:

Taking Care of Your Device

- Follow all warnings and instructions noted in this documentation and in the operating system documentation.
- Read the **Safety** and **Battery Tips** sections.
- Unplug the device from the power outlet before cleaning. Use a damp cloth for cleaning. Aerosols, solvents, or strong detergents are not recommended cleaning solutions and may void your warranty. For system decontamination recommendations please contact your support representative.
- Do not block or cover slots and openings in the unit case. These are for ventilation purposes and covering them could cause the system to overheat.
- Do not use or store the device near a source of heat or dust.
- If you use the device with an extension cord, ensure that the total ampere ratings of all the devices sharing the extension do not exceed the rating of the extension cord or the rating of the wall outlet.
- Never insert objects into the device through any of the slots or openings. Dangerous voltages are present, which could cause electric shock or fire, or damage sensitive components.
- For best results, use a power strip with a built-in surge protector. Do not use inferior extension cords as this may result in damage to your device.
- Set the device on a flat, stable surface. To prevent damage to the device's hard disk drive, avoid using the device where it will be exposed to extreme vibration.
- Do not operate the device to temperatures below -23°C (-10°F) or above 60°C (140°F). Operate the device within the recommended temperature ranges of -23°C to +60°C (-10°F to +140°F).
- Do not subject the device to magnetic fields.
- Do not intentionally spill liquid on the device.
- Do not subject the device to extreme shock and vibration.
- Do not place objects on top of the device.
- Do not place the device on uneven surfaces.
- Periodically inspect the device and accessories for wear, damage, loose or missing parts. Identifying and correcting potential problems early can help reduce the need to return the unit for service.

- Periodically inspect the ports and connectors for damage and contamination.
- Turn off the device when you are not using it.
- Charge the batteries daily or whenever their capacity is low.

Taking Care of Your AC Adapter

- Do not connect the adapter to any other device.
- Do not step on the power cord or place anything on top of it. Carefully route the power cord and any cables away from all potential traffic.
- When unplugging the power cord, do not pull on the cord itself but pull on the plug.
- The total ampere ratings of the equipment plugged in should not exceed the ampere rating of the cord if you are using an extension cord. Also, the total current rating of all equipment plugged into a single wall outlet should not exceed the fuse rating.

Servicing Your Device

Contact your dealer or see your service technician if any of the following occurs:

- The device has been dropped and the body has been damaged.
- Liquid has been spilled into the product.
- The device does not operate normally.

Storing Your Device

1. Save and backup files and data before storing the notebook.
2. Remove any PC Cards, Smart Cards, or EXPRESS Cards from the card slots.
3. Remove any media from the **media bay**.
4. Exit all applications.
5. Shut down and turn off the device.

Windows 7:

Select **Start, Shut down**.

6. **Remove the battery** from the unit and store it in a dry place.
7. Store the device within the recommended temperature ranges of -55°C to +75°C (-67°F to +167°F).
8. If you use PC cards, refer to the manufacturer's instructions you received with the card for storage and care information.

Taking Care of Your Batteries

- Read and follow all battery precautions in the **Safety** section.
- Use only batteries of the same kind as replacements.
- Turn the power off before removing or replacing batteries.
- Do not tamper with the batteries.
- Keep batteries away from children.
- Before storing your battery, read and follow the recommendations in the **Battery Tips** section.
- Dispose of used batteries according to local regulations. Recycle if at all possible.
- Avoid exposing batteries to extremely hot or cold temperatures for long periods. To prevent possible damage to the battery, this notebook does not allow the battery to charge if the internal temperature of the battery gets too low (< 5°C or < 41°F) or too high (> 50°C or > 122°F).
- Charge the battery nightly where the temperature will remain around 20°C (68°F).
- **Recalibrate your battery** when your battery performance degrades.

Taking Care of Your Hard Drive

This notebook hard drive is a removable, shock-mounted drive. You can reduce the risk of damage to the hard drive and increase the reliability of the hard drive and data integrity by following the recommendations below.

For Internal Hard Drives

- Do not intentionally drop the device. The unit is designed to withstand the day to day rigors of the mobile environment and provide years of reliable service. The useful life of the product can be enhanced by not intentionally abusing it.
- Whenever possible, suspend the unit by pressing **FN+F3** before moving it from one location to another. This unloads the read/write heads and spins down the disk, reducing exposure to high operating shocks.
- Maintain the environmental seal of the device by keeping all external access doors closed and latched.
- Avoid exposing the unit to extreme temperatures or moisture when the doors are open.
- Periodically backup or archive important files and data.

For External PC Cards

Each PC Card manufacturer provides specific guidelines for the care and handling of the product. In addition, follow these recommendations:

- When the PC Card is not inserted in a PC Card socket, store the PC Card in a protective carrying case. This will help protect it from inadvertent shocks.
- Always use care when handling PC Cards. Do not drop, bend, flex, or crush them.
- Avoid exposing PC Cards to extreme moisture, heat, or sunlight.
- Keep all debris out of the connector to ensure good electrical connections.
- There are no user repairable parts in the PC Card slot. Do not attempt to disassemble any part of the device. The warranty will be voided if drive seals are broken or screws have been removed.
- Periodically backup or archive important files and data.
- If you have problems with your PC Card, contact the manufacturer for more information and troubleshooting information.

Cleaning Your Device

Cleaning the Outside Case

1. Disconnect external power and turn off the notebook.
2. **Remove the battery.**
3. Add a small amount of water to a soft cloth and clean the device case. Do not use paper products because they can scratch the surface.
4. Wipe off any excess liquid with a soft cloth.
5. Reinstall the battery.

CAUTION Aerosols, solvents, or strong detergents are not recommended cleaning solutions and may void your warranty. For system decontamination recommendations please contact your support representative.

Cleaning the Display

Use a soft, dry cloth. In some cases, you can use a small amount of water to remove streaks or smears. For difficult display cleaning tasks, use a 50/50 mixture of isopropyl alcohol and water. Do not use paper products because they can scratch the screen.

Cleaning the External Power Connector

The external power connector may sometimes be exposed to moisture and/or contamination causing an unreliable connection to the external power source. Clean the connector with a cotton swab dipped in electronics grade isopropyl alcohol.

Cleaning the RJ-45 / USB Connectors



If the connector pins get dirty, clean the connector with a cotton swab dipped in electronics grade isopropyl alcohol.

Data Backup

Regularly backup your data to ensure the greatest data integrity, provide the fastest recovery options, and minimize downtime.

After you have installed all applications and have your device configured as desired, create a backup of drive C: using the **Hard Disk Backup and Recovery Utility**. Then use the **Windows Backup Utility** frequently to backup data. It is recommended you set the backup utility to run automatically.

Saving Important System Information

By default, your device is set up to automatically save certain critical information, such as the registry, on a regular basis. This information is saved as a restore point. You can also create restore points manually by using the **System Restore Utility**. Select **Start, All Programs, Accessories, System Tools, System Restore**. Then, follow the instructions in the Wizard.

Backing Up Files in Windows 7:

Select **Start, Control Panel**. Under **System and Security**, select **Back up your computer**. From here you can set up backup, create a system image or create a system repair disc.

Backing Up Drive C:

You can make an exact copy of drive C: and save the backup image on the Recovery Partition of your hard disk (usually drive D:). In the future, you can restore drive C: to its previous state if it becomes corrupted. To make a backup copy of drive C:, use the **Hard Disk Backup and Recovery Utility**. Select **Start, All Programs, Mobile Computer Tools, Hard Disk Backup and Recovery**. You will be prompted for additional information.

NOTE The **Hard Disk Backup and Recovery Utility** is only available on computers configured with a recovery partition.

Data Recovery

There are several methods to restore your data. Start with the least destructive and fastest recovery options, listed below in the order in which you should restore data.

1. Restore system information.
2. Restore a backup using the **Windows Backup Utility**.
3. Restore the entire contents of drive C:

Option 1: Restoring System Information

Windows 7:

Select **Start, Control Panel, System and Maintenance, Backup and Restore Center**. On the **Tasks** menu on the left-hand side of the screen, select **Repair Windows using System Restore**.

Option 2 : Restoring a Backup

Windows 7:

Select **Start, Control Panel, System and Security**. Under **Backup and Restore**, select **Restore files from backup**. From here you can select a backup file to restore.

Option 3: Restoring Drive C:

If you used the **Hard Disk Backup and Recovery Utility** to create a backup disk image you can use it to restore drive C:.

CAUTION Restoring a previously saved disk image overwrites the entire contents of drive C:. Before running this process, save your data to another location, such as a USB flash drive.

NOTE The **Hard Disk Backup and Recovery Utility** is only available on computers configured with a recovery partition. If it is not available, you will either need to contact your company's help desk about obtaining a recovery CD or return your unit for service.

Windows 7:

Select **Start, All Programs, Mobile Computer Tools, Hard Disk Backup and Recovery** and follow the prompts.

This section is designed to help you determine and fix issues you might encounter while operating this notebook. Try the following things in order:

- First look through the categories in this section for a solution.
- If you are having a problem with the application installed on the device, use the **Help** that comes with the application to find a solution.
- If you are having a problem with the operating system, refer to its **Help and Support**, found on the **Start** Menu.
- If you still cannot resolve your problem, contact the help desk at your organization.

Application Troubleshooting

My application locks up, acts strangely, or produces a General Protection Fault (GPF) error or blue screen

Using Windows 7:

Select **Start** and click on the arrow next to the **Shut down** menu. Then select **Restart**.

Battery Troubleshooting

The battery does not charge

- To prevent possible damage to the battery, the device does not allow the battery to charge if the internal temperature of the battery gets too low (< 5°C or < 41°F) or too high (> 50°C or > 122°F). If possible, charge the battery in a location with a moderate temperature of around 20°C (68°F).
- If possible, turn off the device while the battery is charging.
- If the battery is new or has been stored for a week or more, follow this procedure:
 1. Make sure the device is turned off.
 2. **Remove the battery.**
 3. Connect the AC adapter to the device and an AC wall outlet, and then turn on the device by pressing the **POWER** button.
 4. Let the device complete the boot process. Then reinstall the battery.
- Allow the system to remain idle for one hour with the AC adapter connected to the device.
- The **Battery Power LED**  lights when the battery starts charging.

- If the battery still fails to start charging after an hour, remove the battery, wait several seconds, and then install it again.
- If the battery does not begin charging within several minutes, return the unit for service.

The batteries take much longer than seven hours to charge

- Under moderate temperatures, about 20°C (68°F), the device's battery takes approximately 4 to 5 hours to completely charge.

NOTE As the battery temperature approaches the ends of its temperature range (5°C/ 41°F to 50°C/122°F), it may take longer to charge the battery.

The batteries don't last very long

- **Calibrate the battery.** If your battery is new or has not been used for several weeks, calibrating the battery accurately sets the gas gauge.
- As your battery ages, its maximum capacity naturally decreases, and even the best maintained batteries eventually need to be retired. Consider replacing the battery if you are not getting the usage you need from it.
- To meet ENERGY STAR® requirements, **Wake-on-LAN** is enabled by default. If running on battery power this may decrease battery run-time. To change **Wake-on-LAN** settings, open the **Device Manager, Network Adapters** and select the LAN device. Open the device **Properties** and select **Power Management**. Disable the **Wake-on-LAN** setting by unchecking **Allow this device to wake the computer**.

The gas gauge isn't full after charging the battery

This may indicate that the charging process terminated prematurely.

The gas gauge reads "full," but the charging LED is still lit

If you charge your battery daily, rely on the gas gauge reading to determine battery capacity. The charging process may continue even if the gas gauge reads full. External power can be removed because the battery is virtually full.

My battery seems to have less and less capacity

- If your battery is new, or if you are using it for the first time, you will need to **calibrate it** prior to using it.
- As your battery ages, the maximum capacity that it can hold naturally decreases, and even the best maintained

batteries eventually need to be retired. Consider replacing the battery if you are not getting the usage you need from it.

Display / Touch Screen

The display performance is slow

The temperature may be too cold. Move the device to a warmer operating environment.

I can't read the display

- Adjust the brightness level using **FN+F6** and **FN+F7**.
- The automatic power-saving mode may have shut off (suspended) the device. Press any key to resume.
- If the display brightness is unreadable after a resume or reboot but is easily adjusted with **FN+F6** and **FN+F7**, you may have set **Stealth mode** in the Setup Utility. If you disable Stealth mode, the display and backlight will operate normally.

The underlined, inverse, and hypertext characters are difficult to read on the screen

For Windows 7:

Right click on the Windows Desktop, select **Personalize**, **Window Color and Appearance** to change the color and style of your Windows.

I can't see the cursor while using the DOS editor

Press **Fn + Ins** to change from insert mode to overwrite mode and enable a block cursor. When it defaults to insert mode, the DOS editor uses an underline cursor which is less visible than the block cursor for overwrite mode.

I changed my display resolution, but I see no difference on the screen

For Windows 7:

Select **Start** and click on the arrow next to the **Shut down** menu. Then select **Restart**.

Nothing happens when I try to use the stylus on my touch screen

If you cannot select objects accurately with the stylus, you may need to **calibrate the touch screen**.

The touch screen doesn't respond after a suspend

The touch screen needs a few seconds to work after a suspend. Wait a moment and try again.

Hard Disk

The hard disk will not spin up so the device can't boot up

This occurs if the unit is exposed to extreme low temperatures. This is not a hardware failure associated with the hard disk. The integrated hard disk drive heater will warm the drive to a safe operating temperature.

The notebook does not startup properly

- Make sure you remove any USB drives from the unit before you start it.
- Connect the AC adapter to charge the battery if it is not charged.

NOTE Push the DC jack firmly into the device until it "clicks". If the AC adapter is connected and functioning properly, the Power LED on the AC adapter should be lit as well as the External Power LED on the device.

- If the AC adapter is connected but the unit will still not turn on, make sure the electrical outlet you are using is working.
- Check to make sure the battery is installed and charged properly.
- If the battery does not begin charging, perform the following:
 1. **Remove the battery.**
 2. Connect the AC adapter.
 3. Turn on the device by pressing the **POWER** button.
 4. Reinstall the battery. The Battery LED is a steady blue while the battery is charging.

Keyboard and Mouse Troubleshooting

Something unexpected happens when I press a key

You may have pressed a key combination that performs a Windows function. Make sure you are pressing the correct keys for the application you are running.

Incorrect characters appear on the screen when I press certain keys

You may be in Num Lock mode. Press the **NumLk** key to toggle Num Lock mode off. **NumLk** is on the top row of buttons on your keyboard next to the **F12** key.

I have difficulty double-clicking the mouse fast enough

For Windows 7:

1. Select **Start, Control Panel, Hardware and Sound**.
2. Under **Devices and Printers**, select **Mouse**. This will bring you to the **Mouse Properties** window.
3. On the **Buttons** tab, use the **Devices** drop-down menu to select your mouse. Then you can set double-click speed.

PC Cards



I can't remove the PC card

- Press the ejector button located inside the PC card door on the side of the device. The button will pop out. Press the ejector button again to eject the PC card. Slide the card out.
- If the ejector button malfunctions when you press it, release the button and then press it again.

Read Error

If a memory card that is not properly formatted is installed in the PC Card slot, it will cause this error.

The device locks up when I remove the PC card

Before you remove the card, select the PC card icon ( or ) on the taskbar (in the tray area near the clock in the lower right corner) and choose " **Stop [card name] card.**"

Miscellaneous Troubleshooting

The device shuts off unexpectedly

- The device has entered suspend mode. Press any key to resume from the standby state. Press the **POWER** button to resume from the hibernate state.
- The battery capacity may be low. Connect external power to charge the battery, or replace the battery with a fully charged one.

The speaker volume is too high or too low

Refer to the **audio section** for instructions on adjusting volume.

The device won't turn on

- Make sure a fully charged battery is properly installed.
- Connect external power to charge the battery if it is not charged.
- If you are using the AC adapter check the electrical outlet you are using to make sure it is working properly.
- If the device does not turn on, reset the device by holding down the **POWER** button for at least ten seconds, release it, then press the **POWER** button again.

The device won't turn off

For Windows 7:

1. Select **Start** and click on the arrow next to the **Shut down** menu. Then select **Restart** to reboot the device.
2. If that does not work, press **Ctrl + Alt + Del** and then select **Start Task Manager**.
3. If any programs are open, use your arrow keys to highlight each one and select **End Task**. Repeat this until all programs are closed.
4. If that still does not work, press and hold the **POWER** button for approximately ten seconds and then release it.

The device enters suspend mode too quickly

For Windows 7:

Select **Start, Control Panel, System and Security**. Under **Power Options**, select **Change when the computer sleeps**. Modify the **Put the computer to sleep** option.

The device doesn't automatically suspend

- Exit any application that uses COM ports.
- Make sure external power is not connected. Depending on power settings, some systems will not suspend automatically when they are connected to external power.

The system date and time are incorrect

For Windows 7:

Select **Start, Control Panel**. Then select **Clock, Language and Region**. Under **Date and Time**, make the appropriate changes.

I receive an "out of memory" error message

- Restart the device.
- Too many applications may be running at the same time. Close applications you don't need.
- Make sure you have enough space on your hard disk (at least 15% free).

Holding down the Power button to reset the device doesn't always work

- Try resetting the device again. If this doesn't work, remove all power, including the battery pack, and allow the unit to remain idle for ten minutes. After ten minutes, connect external power and retry.
- The LEDs, backlight, and/or keyboard backlight don't illuminate.
- You may have enabled **Stealth mode** in the Setup Utility. Disable Stealth mode.

The device doesn't make any sounds, even during boot-up

You may have enabled **Stealth mode** in the Setup Utility. Disable Stealth mode.

The fan stopped running

You may have enabled Stealth mode in the Setup Utility. Disable Stealth mode.

Can I improve the startup speed of my programs by cleaning up and rearranging files on the hard drive?

Using the Windows utilities to defragment your drive may improve the startup speed of programs.