WARNING

This manual contains information on limitations regarding product use and function and information on the limitations as to liability of the manufacturer. The entire manual should be carefully read.

NT9010
v 1.0

Installation Guide

DLS-3 v1.3 and higher

DSC
ENVOLY™

Limited Warranty

Digital Security Controls Ltd. warrants the original purchaser that for a period of twelve months from the date of purchase, the product shall be free of defects in materials and workmanship under normal use. During the warranty period, Digital Security Controls Ltd. shall, at its option, repair or replace any defective product upon return of the product to its factory, at no charge for labour and materials. Any replacement and/or repaired parts are warranted for the remainder of the original warranty or ninety (90) days, whichever is longer. The original owner must promptly notify Digital Security Controls Ltd. in writing that there is defect in material or workmanship, such written notice to be received in all events prior to expiration of the warranty period.

International Warranty

The warranty for international customers is the same as for any customer within Canada and the United States, with the exception that Digital Security Controls Ltd. shall not be responsible for any customs fees, taxes, or VAT that may be due.

Warranty Procedure

To obtain service under this warranty, please return the item(s) in question to the point of purchase. All authorized distributors and dealers have a warranty program. Anyone returning goods to Digital Security Controls Ltd. must first obtain an authorization number. Digital Security Controls Ltd. will not accept any shipment whatsoever for which prior authorization has not been obtained.

Conditions to Void Warranty

This warranty applies only to defects in parts and workmanship relating to normal use. It does not cover:

- damage incurred in shipping or handling;
- damage caused by disaster such as fire, flood, wind, earthquake or lightning;
- damage due to causes beyond the control of Digital Security Controls Ltd. such as excessive voltage, mechanical shock or water damage;
- damage caused by unauthorized attachment, alterations, modifications or foreign objects;
- damage caused by peripherals (unless such peripherals were supplied by Digital Security Controls Ltd.);
- defects caused by failure to provide a suitable installation environment for the products;
- damage caused by use of the products for purposes other than those for which it was designed;
- damage from improper maintenance;
- damage arising out of any other abuse, mishandling or improper application of the products.

Digital Security Controls Ltd.'s liability for failure to repair the product under this warranty after a reasonable number of attempts will be limited to a replacement of the product, as the exclusive remedy for breach of warranty. Under no circum-

stances shall Digital Security Controls Ltd. be liable for any special, incidental, or consequential damages based upon breach of warranty, breach of contract, negligence, strict liability, or any other legal theory. Such damages include, but are not limited to, loss of profits, loss of the product or any associated equipment, cost of capital, cost of substitute or replacement equipment, facilities or services, down time, purchaser's time, the claims of third parties, including customers, and injury to property.

Disclaimer of Warranties

This warranty contains the entire warranty and shall be in lieu of any and all other warranties, whether expressed or implied (including all implied warranties of merchantability or fitness for a particular purpose) And of all other obligations or liabilities on the part of Digital Security Controls Ltd. Digital Security Controls Ltd. neither assumes nor authorizes any other person purporting to act on its behalf to modify or to change this warranty, nor to assume for it any other warranty or liability concerning this product.

This disclaimer of warranties and limited warranty are governed by the laws of the province of Ontario, Canada.

WARNING: Digital Security Controls Ltd. recommends that the entire system be completely tested on a regular basis. However, despite frequent testing, and due to, but not limited to, criminal tampering or electrical disruption, it is possible for this product to fail to perform as expected.

Installer's Lockout

Any products returned to DSC which have the Installer's Lockout option enabled and exhibit no other problems will be subject to a service charge.

Out of Warranty Repairs

Digital Security Controls Ltd. will at its option repair or replace out-of-warranty products which are returned to its factory according to the following conditions. Anyone returning goods to Digital Security Controls Ltd. must first obtain an authorization number. Digital Security Controls Ltd. will not accept any shipment whatsoever for which prior authorization has not been obtained.

Products which Digital Security Controls Ltd. determines to be repairable will be repaired and returned. A set fee which Digital Security Controls Ltd. has predetermined and which may be revised from time to time, will be charged for each unit repaired.

Products which Digital Security Controls Ltd. determines not to be repairable will be replaced by the nearest equivalent product available at that time. The current market price of the replacement product will be charged for each replacement unit.

Table of Contents

Chapter 1: Quick Set Up

Section 1.1: Introduction

1.1.1 About the NT9010 System	1
1.1.2 About the NT9010 Manual Set	1
1.1.3 Main system Specifications	2
1.1.4 Additional Devices	3
1.1.5 Peel-off Instruction Labels	4

Section 1.2: Installing The NT9010

1.2.1 Out of the Box	5
1.2.2 Create an Installation Plan	5
1.2.3 Prepare the Mounting Location	5
1.2.4 Installing the NT9010	5
1.2.5 Connecting the Battery	6
1.2.6 Mounting the Wireless Devices	10
1.2.7 Enrolling Devices and Setting Up the System	10
1.2.8 Other NT9010 Options	13
1.2.9 Deleting Wireless Devices	13

Section 1.3: Troubleshooting

1.3.1 Typical Installation Problems and Solutions	14
---	----

Chapter 2: Advanced Programming

Section 2.1: Programming the NT9010

2.1.1 How to Enter Advanced Programming	15
2.1.2 Programming Decimal Data	15
2.1.3 Programming Hexadecimal Data	16
2.1.4 Programming Toggle Options	16
2.1.5 Programming Audio Labels	16
2.1.6 Reviewing Programming	18
2.1.7 Exiting Programming	18

Section 2.2: Changing How the NT9010 Works For Users

2.2.1 Accessing the NT9010 System Using a Telephone 19	
2.2.2 Access Codes	20
2.2.3 Voice Prompt Interface	22
2.2.4 Alarm Announce-ments	23
2.2.5 Arming and Disarming Options	24
2.2.6 Automatic Arming	25

2.2.7 Entry and Exit Delay Options	25
2.2.8 Bell Options	26
2.2.9 User Commands	27
2.2.10 Function Keys	31
2.2.11 Programming Wireless Keys	33
2.2.12 Fire, Auxiliary, and Panic Keys	33
2.2.13 Keypad Options	34
2.2.14 Sleep Mode	35

Section 2.3: Changing Other NT9010 Functions

2.3.1 Zone Definitions	36
2.3.2 Zone Attributes	38
2.3.3 Enrolling Hardwired Zones	39
2.3.4 Wireless Device Serial Numbers	39
2.3.5 Wireless Zone Supervision	40
2.3.6 RF Jamming Detection Zone	40
2.3.7 Zone Tamper/Fault Options	41
2.3.8 Communicator Dialing	41
2.3.9 Communicator Telephone Numbers	43
2.3.10 Communicator Account Codes	44
2.3.11 Communicator Reporting Formats	44
2.3.12 Communicator Reporting Codes	47
2.3.13 Talk/Listen-in Programming	49
2.3.14 Downloading	51
2.3.15 Telephone Line Monitoring (TLM)	53
2.3.16 Test Transmissions	53
2.3.17 Event Buffer	54
2.3.18 Swinger Shutdown	54
2.3.19 Timebase	54
2.3.20 Factory Default	54
2.3.21 Installer Lockout	55
2.3.22 Walk Test	56

Appendix A: Guidelines for Locating Smoke Detectors **57**

Appendix B: Reporting Codes **58**

Appendix C: WLS925L-433 Mini Door/ Window Contact Installation Instructions **61**

Appendix D: WLS904P Wireless Motion Detector Installation Instructions **62**

WARNING Please Read Carefully

Note to Installers

This warning contains vital information. As the only individual in contact with system users, it is your responsibility to bring each item in this warning to the attention of the users of this system.

System Failures

This system has been carefully designed to be as effective as possible. There are circumstances, however, involving fire, burglary, or other types of emergencies where it may not provide protection. Any alarm system of any type may be compromised deliberately or may fail to operate as expected for a variety of reasons. Some but not all of these reasons may be:

Inadequate Installation

A security system must be installed properly in order to provide adequate protection. Every installation should be evaluated by a security professional to ensure that all access points and areas are covered. Locks and latches on windows and doors must be secure and operate as intended. Windows, doors, walls, ceilings and other building materials must be of sufficient strength and construction to provide the level of protection expected. A reevaluation must be done during and after any construction activity. An evaluation by the fire and/or police department is highly recommended if this service is available.

Criminal Knowledge

This system contains security features which were known to be effective at the time of manufacture. It is possible for persons with criminal intent to develop techniques which reduce the effectiveness of these features. It is important that a security system be reviewed periodically to ensure that its features remain effective and that it be updated or replaced if it is found that it does not provide the protection expected.

Access by Intruders

Intruders may enter through an unprotected access point, circumvent a sensing device, evade detection by moving through an area of insufficient coverage, disconnect a warning device, or interfere with or prevent the proper operation of the system.

Power Failure

Control units, intrusion detectors, smoke detectors and many other security devices require an adequate power supply for proper operation. If a device operates from batteries, it is possible for the batteries to fail. Even if the batteries have not failed, they must be charged, in good condition and installed correctly. If a device operates only by AC power, any interruption, however brief, will render that device inoperative while it does not have power. Power interruptions of any length are often accompanied by voltage fluctuations which may damage electronic equipment such as a security system. After a power interruption has occurred, immediately conduct a complete system test to ensure that the system operates as intended.

Failure of Replaceable Batteries

This system's wireless transmitters have been designed to provide several years of battery life under normal conditions. The expected battery life is a function of the device environment, usage and type. Ambient conditions such as high humidity, high or low temperatures, or large temperature fluctuations may reduce the expected battery life. While each transmitting device has a low battery monitor which identifies when the batteries need to be replaced, this monitor may fail to operate as expected. Regular testing and maintenance will keep the system in good operating condition.

Compromise of Radio Frequency (Wireless) Devices

Signals may not reach the receiver under all circumstances which could include metal objects placed on or near the radio path or deliberate jamming or other inadvertent radio signal interference.

System Users

A user may not be able to operate a panic or emergency switch possibly due to permanent or temporary physical disability, inability to reach the device in time, or unfamiliarity with the correct operation. It is important that all system users be trained in the correct operation of the alarm system and that they know how to respond when the system indicates an alarm.

Smoke Detectors

Smoke detectors that are a part of this system may not properly alert occupants of a fire for a number of reasons, some of which follow. The smoke detectors may have been improperly installed or positioned. Smoke may not be able to reach the smoke detectors, such as when the fire is in a chimney, walls or roofs, or on the other side

of closed doors. Smoke detectors may not detect smoke from fires on another level of the residence or building.

Every fire is different in the amount of smoke produced and the rate of burning. Smoke detectors cannot sense all types of fires equally well. Smoke detectors may not provide timely warning of fires caused by carelessness or safety hazards such as smoking in bed, violent explosions, escaping gas, improper storage of flammable materials, overloaded electrical circuits, children playing with matches or arson.

Even if the smoke detector operates as intended, there may be circumstances when there is insufficient warning to allow all occupants to escape in time to avoid injury or death.

Motion Detectors

Motion detectors can only detect motion within the designated areas as shown in their respective installation instructions. They cannot discriminate between intruders and intended occupants. Motion detectors do not provide volumetric area protection. They have multiple beams of detection and motion can only be detected in unobstructed areas covered by these beams. They cannot detect motion which occurs behind walls, ceilings, floor, closed doors, glass partitions, glass doors or windows. Any type of tampering whether intentional or unintentional such as masking, painting, or spraying of any material on the lenses, mirrors, windows or any other part of the detection system will impair its proper operation.

Passive infrared motion detectors operate by sensing changes in temperature. However their effectiveness can be reduced when the ambient temperature rises near or above body temperature or if there are intentional or unintentional sources of heat in or near the detection area. Some of these heat sources could be heaters, radiators, stoves, barbecues, fireplaces, sunlight, steam vents, lighting and so on.

Warning Devices

Warning devices such as sirens, bells, horns, or strobes may not warn people or waken someone sleeping if there is an intervening wall or door. If warning devices are located on a different level of the residence or premise, then it is less likely that the occupants will be alerted or awakened. Audible warning devices may be interfered with by other noise sources such as stereos, radios, televisions, air conditioners or other appliances, or passing traffic. Audible warning devices, however loud, may not be heard by a hearing-impaired person.

Telephone Lines

If telephone lines are used to transmit alarms, they may be out of service or busy for certain periods of time. Also an intruder may cut the telephone line or defeat its operation by more sophisticated means which may be difficult to detect.

Insufficient Time

There may be circumstances when the system will operate as intended, yet the occupants will not be protected from the emergency due to their inability to respond to the warnings in a timely manner. If the system is monitored, the response may not occur in time to protect the occupants or their belongings.

Component Failure

Although every effort has been made to make this system as reliable as possible, the system may fail to function as intended due to the failure of a component.

Inadequate Testing

Most problems that would prevent an alarm system from operating as intended can be found by regular testing and maintenance. The complete system should be tested weekly and immediately after a break-in, an attempted break-in, a fire, a storm, an earthquake, an accident, or any kind of construction activity inside or outside the premises. The testing should include all sensing devices, keypads, consoles, alarm indicating devices and any other operational devices that are part of the system.

Security and Insurance

Regardless of its capabilities, an alarm system is not a substitute for property or life insurance. An alarm system also is not a substitute for property owners, renters, or other occupants to act prudently to prevent or minimize the harmful effects of an emergency situation.

Chapter 1: Quick Set Up

Section 1.1: Introduction

1.1.1 About the NT9010 System

The NT9010 is a full-featured, wireless security system. It has been designed for fast and easy installation.

The NT9010 system is made up of the following components:

- A main control unit
- Up to 32 wireless detectors and panic pendants (total)
- You can also add up to 16 wireless keys.

The NT9010 system supports up to 32 zones (detectors and panic pendants), and 32 system users. The NT9010 main control unit guides users through their available options with easy-to-understand audio prompts. The status of the NT9010 system can be monitored over a telephone line.

You can program the system using the keypad on the NT9010 control unit, or using DLS-3 downloading software and a computer. If you program the system from the NT9010 control unit, you can do the basic zone enrollment and programming using Flash Programming. See *Chapter 1: Quick Set Up* in the *Installation Guide* for more information on using Flash Programming.

1.1.2 About the NT9010 Manual Set

The NT9010 system has three manuals, *Installation Guide*, *Programming Worksheets*, and *User's guide*.

☛ **Installation Guide**

The *Installation Guide* contains two main chapters.

Chapter 1: Quick Set Up

This chapter is for people who will be installing NT9010 systems requiring only basic programming. This will be the case in the majority of installations. Please review this chapter before beginning your installation. The *Quick Set Up* covers the following topics:

- An overview of the system
- How to mount and complete NT9010 wiring
- How to enroll devices and program the system using Flash Programming
- Basic troubleshooting tips
- Guidelines for placing smoke detectors

Chapter 2: Advanced Programming

This chapter is for people who will be installing a system that needs special features or custom programming. If your installation requires more programming than is included in Flash Programming, review the relevant sections of this chapter for more information.

☛ **Programming Worksheets**

This manual is used to record your zone choices and other programming for the system.

NOTE: *Keep this manual in a safe place for future reference.*

☛ **User's Guide**

The *User's Guide* provides easy to follow instructions for NT9010 users. This *Guide* contains instructions on turning the system on or off, dealing with alarms and emergencies, using advanced functions, fire safety, and how to replace wireless device batteries.

Installers should also review this manual, in order to properly instruct the end-users once the installation is complete.

1.1.3 Main system Flexible Zone Configuration: Specifications

- 32 fully programmable zones
- 23 zone types, 8 programmable zone options
- Connect up to 2 hardwired zones

Access Codes:

- 38 access codes: 32 user codes, 1 Master code, 2 supervisor codes, 2 duress codes, and 1 maintenance code

Remote Sounder Output:

- Four-wire supervised connection to optional remote sounder
- Can be wired up to 500ft (152m), 22AWG from the NT9010 control unit
- Capable of steady or pulsed siren, voice prompts, and central station talk/listen-in sessions

EEPROM Memory:

- Will not lose programming or system status on complete AC and battery failure

Power Requirements:

- Plug-in transformer = 9VAC, 20VA (use only DSC transformer PTD920)
- Battery = 6 volt 3.5 Ah rechargeable sealed lead acid (use only DSC battery BD3.5-6V)

Digital Communicator Specifications:

- Supports all major formats including SIA, Contact ID, and 20bps formats
- Split reporting of selected transmissions to each telephone number
- 3 programmable telephone numbers
- 2 system account codes
- DTMF and pulse dialing
- DPDT line seizure
- Anti-jam detection
- Event-initiated personal paging

System Supervision Features

The NT9010 continuously monitors a number of possible trouble conditions including:

- AC power failure (system enters “Sleep” mode on loss of AC power for longer than 30 seconds)
- Trouble by zone
- Fire trouble
- Telephone line trouble
- Low battery condition
- Remote sounder supervisory
- Loss of internal clock
- Tamper by zone
- Failure to communicate
- Improper zone placement

False Alarm Prevention Features

- Audible exit delay
- Audible exit fault
- Urgency on entry delay
- Quick exit
- Swinger shutdown
- Recent closing transmission
- Communication delay
- Rotating keypress buffer

Additional Features

- Keypad activated alarm output and communicator test
- Keypad lockout
- 128 event buffer, time and date stamped
- Uploading/downloading capability

1.1.4 Additional Devices***WLS904-433 Wireless Motion Detector***

The wireless motion detector can be used to provide wireless interior protection. The unit comes with four AAA batteries.

WLS904P-433 Wireless Motion Detector with Pet Immunity

The wireless motion detector can be used to provide wireless interior protection. The unit comes with four AAA batteries.

WLS906-433 Wireless Smoke Detector

The wireless smoke detector can be used to provide wireless smoke detection. The unit comes with six AA batteries.

WLS912-433 Wireless Glassbreak Detector

The wireless glassbreak detector can be used to provide wireless glassbreak detection. The unit comes with three AA batteries.

WLS914-433 Dual PIR Wireless Motion Detector

The dual PIR wireless motion detector can be used to provide wireless space protection. The unit comes with four AA batteries.

WLS925L-433 Mini Wireless Universal Transmitter

The WLS925L-433 wireless universal transmitter is a smaller transmitter that can be used for door and window contacts. The unit comes with one Lithium battery and has built-in contacts.

WLS929-433 Wireless Key

The wireless key can be used to provide a simple and mobile method of arming and disarming the system. The unit comes with three Photo/Electronic 1.5V batteries. This system can have a maximum of 16 Wireless Keys.

NT9201 Remote Sounder

You can connect a hardwired remote sounder to the NT9010 system. This sounder provides an additional station for the NT9010 to sound alarms and system status, and for central station talk/listen-in sessions.

NOTE: *Maximum distance for the Remote Sounder is 500ft (152m) using 22AWG sheilded cable.*

1.1.5 Peel-off Instruction Labels

The Envoy unit comes with a set of peel-off instruction labels already applied. Installer should remove these labels after installation. For future programming needs, please see sample labels below for instructions.

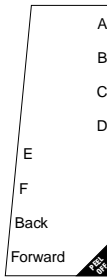

- A = Stay
- B = Away
- C = Chime
- D = Exit
- E = Status
- F = Volume
- Back = Record
- Forward = Playback

The NT9010's "Flash" programming will help you to quickly set up the system. To begin:

1. Press [*][8]
2. Enter the default installer's code: [5555]
3. Follow the audio instruction

For contacts used on the hardwired zones:

- Enter serial number 200001 for the first hardwired zone.
 - Enter serial number 200002 for the second hardwired zone.
- Use buttons [A] to [F] for entering letters in serial numbers.

1 = YES

2 = NO

Selection	Type 2 (TX)	Type 3 (PIR)	Type 4 (Smoke)
[A] Preset	Front Door	Main Floor Motion	Main Floor Fire
[B] Preset	Back Door	Upstairs Motion	Upstairs Fire
[C] Preset	Garage Door	Downstairs Motion	Downstairs Fire
[D] Preset	Window	Hallway Motion	Hallway Fire
[E] Preset	Patio Door	Garage Motion	Garage Fire

Please use buttons [A] to [E] for standard label options
ALSO REFER TO INSTALLATION MANUAL

Section 1.2: Installing The NT9010

Please read this section to get an overall understanding of the steps involved in installing the NT9010 system. Carefully work through each step. This will help to reduce problems and to reduce the overall installation time required.

1.2.1 Out of the Box

Check that the following parts are included in your NT9010 package:

- NT9010 main control unit and backup battery
- Two WLS925L-433 transmitters
- One WLS904P-433 motion detector with pet immunity
- One 9V, 20VA plug-in transformer
- One set of Installation, Programming Worksheets and User manuals
- Two 5600Ω resistors
- 4 mounting screws

1.2.2 Create an Installation Plan

Draw a rough sketch of the building. Find good locations for the NT9010 control unit and all the detectors. Here are some guidelines for choosing good mounting locations.

Choosing a NT9010 Mounting Location

Before you mount the NT9010, you should find a place that is:

- Dry
- Far from sources of interference, including:
 - electrical noise such as computers, televisions and electric motors in appliances and heating and air conditioning units.
 - large metal objects like heating ducts and plumbing which may shield the antenna.

Choosing Mounting Locations for Wireless Devices

Each type of wireless device has its own set of guidelines for mounting locations. Before deciding on mounting locations, make sure that you review the guidelines in the *Installation Instructions* that come with each device.

1.2.3 Prepare the Mounting Location

Once you have selected a suitable place for the NT9010 control unit, make sure that you will be able to connect the AC power and the telephone line to the NT9010. If necessary, have an electrician route AC wiring to the mounting location, and have a telephone installer route the incoming telephone line to the mounting location.

1.2.4 Installing the NT9010

Mounting the NT9010 Backplate

The NT9010 backplate is the blue-grey piece of plastic that comes attached to the back of the NT9010 control unit. This is the mounting plate for the NT9010 unit. It also provides terminals for connecting the wiring to the NT9010.

NOTE: Complete all wiring before applying AC power.

Figure 1: Removing NT9010 Wall-Mount Backplate

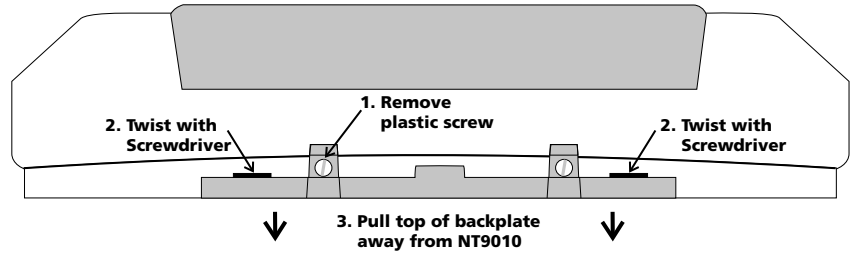

To remove the backplate from the NT9010:

1. Remove the plastic screw from the top of the NT9010 unit (see Figure 1). Keep the screw in a safe location so that you can replace it later.
2. Insert a flathead screwdriver in the slots shown in Figure 1. Twist the screwdriver so that the backplate separates from the plastic housing.
3. Pull the top of the backplate away from the NT9010.
4. Unhook the backplate from the bottom of the NT9010.

Now you can attach the backplate to the wall:

1. Pull the prepared AC and telephone wires through the square hole in the backplate.
2. Place the backplate on the wall in the selected mounting location, and mark the screw locations.
3. Using wall anchors for all screw locations, secure the backplate to the wall.

1.2.5 Connecting the Battery

Before you attach the NT9010 to the backplate, you must connect the battery. The battery is used to provide backup power in the event of an AC power failure and to provide additional current when necessary, such as when the system is in alarm.

NOTE: Place the unit face down before removing the plastic.

1. Remove the two metal screws at the back of the NT9010.
2. Remove the back plastic from the NT9010.
3. Connect the RED battery lead to the positive (+) terminal of the battery, the BLACK battery lead to the negative (-) terminal.
4. Replace the back plastic on the NT9010 and secure it with the metal screws.

NOTE: The unit will not power up if only the battery is connected. AC power must also be connected to the NT9010.

Connecting AC and Telephone Wiring

Connect the AC and telephone line wiring to the terminals mounted on the NT9010 backplate. When you later attach the NT9010 to the backplate, the posts on the back of the unit will plug into the terminals, completing the connection.

AC Terminals

For the NT9010 to work correctly, you will need to connect it to an AC power source that is not controlled by a switch. The system comes with a 9V, 20VA plug-in transformer. Connect the transformer to an unswitched AC source and to the two terminals on the backplate labelled AC.

NOTE: Risk of fire if the rated voltage is not used. Do not power the Envoy controller at a voltage higher than 9V AC. Use only transformer Model PTD920 as supplied with the unit.

NOTE: Do not connect the transformer to a power supply until all other wiring is complete.

NOTE: If you remove power from the unit (AC and battery), you must wait at least 10 seconds before reapplying power.

Telephone Terminals - TIP, RING, T-1, R-1

If a telephone line is required for users to have local or remote telephone access to the system, for central station communication, or for downloading, connect an RJ-31X jack to the R-1, T-1, RING, and TIP terminals on the backplate as shown in Figure 2.

NOTE: Please ensure that all plugs and jacks meet the dimension, tolerance and metallic plating requirements of the Code of Federal Regulations, Title 47, Part 68, Subpart F. For proper operation there must be no other telephone equipment connected between the control panel and the telephone company facilities.

Do not connect the alarm panel communicator to telephone lines intended for use with a FAX machine. These lines may incorporate a voice filter which disconnects the line if anything other than FAX signals are detected, resulting in incomplete transmissions.

Connecting Zone Wiring – Hardwired

You can connect up to two hardwired zones to the NT9010. For the hardwired zones to work correctly, you must enroll them with the system (see **2.3.3 Enrolling Hardwired Zones** on page 39). For a complete description of the operation of all zone types, please see **2.3.1 Zone Definitions** on page 36.

Figure 2: AC and Telephone Line Wiring

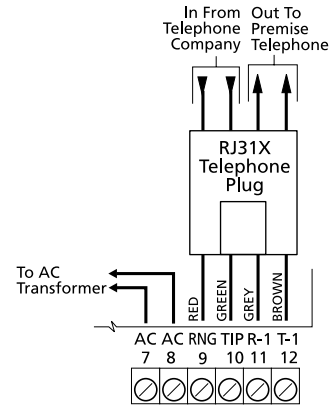

Use the following NT9010 terminals to make your zone connections:

There are two different ways in which zones may be wired, depending on which programming options have been selected. The system can be programmed to supervise normally closed, or Single End of Line loops. Please refer to the following sections to study each type of individually supervised zone wiring.

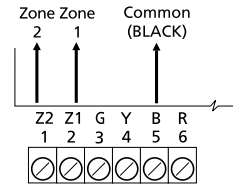

Normally Closed (NC) Loops

To enable normally closed loops, programming section [013], option [1] must be ON.

NOTE: This option should only be selected if Normally Closed (NC) devices/contacts are being used.

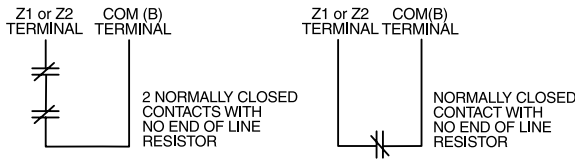

.....
 Normally Closed Loops Section [013], Option [1]

Single End Of Line (EOL) Resistors

To enable system detection of single end of line resistors, programming section [013], option [1] must be OFF.

NOTE: This option should be selected if either Normally Closed (NC) or Normally Open (NO) detection devices or contacts are being used.

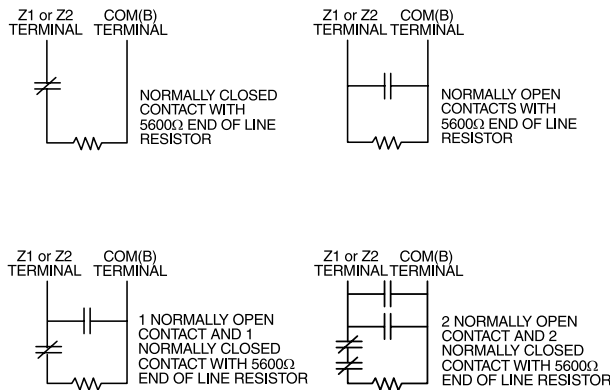

.....
 End of Line Resistors Section [013], Option [1]

Keyswitch Zone Wiring

Zones may be programmed to be used as keyswitch arming zones and must be wired according to the following diagram:

For a complete description of how keyswitch zones operate, see **2.3.1 Zone Definitions** on page 36.

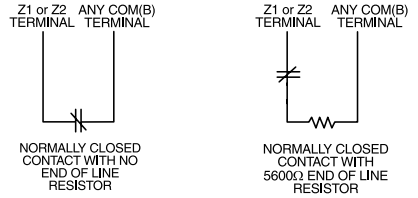

Connecting the Remote Sounder

You can connect a hardwired remote sounder to the NT9010 system. This sounder provides an additional station for the NT9010 to sound alarms and system status, and for central station talk/listen-in sessions.

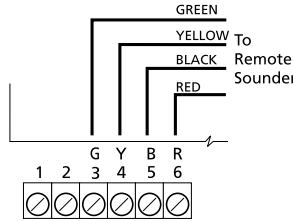

Connect the remote sounder to the NT9010 control unit as shown below:

For the sounder to work on the system you must also turn on the **Remote Annunciation** option. When this option is turned on, the remote sounder will also be supervised.

The **Local Annunciation** option controls the sounder in the NT9010 control unit. If you turn this option off, there will be no alarms or voice

prompts from the NT9010. If both options are on, there will be sound from both the NT9010 and the Remote Sounder.

If there is a Remote Sounder on the system and it does not report a supervisory signal within 30 seconds, a "Service Required" trouble will be generated, and a "Remote Sounder Trouble" event will be logged in the buffer.

See also **2.3.13 Talk/Listen-in Programming** on page 49.

Local Annunciation	Section [017], Option [4]
Remote Annunciation	Section [017], Option [5]

Attach NT9010 to Backplate

NOTE: Before attaching the backplate, be sure to connect the battery. See **1.2.5 Connecting the Battery** on page 6.

When you have mounted the backplate to the wall, completed the wiring, and connected the battery, you can attach the NT9010 unit to the backplate.

1. Push the bottom of the NT9010 onto the backplate posts, as shown at right.
2. Snap the top of the NT9010 onto the top of the backplate, as shown at right.
3. Secure the NT9010 to the backplate by replacing the plastic screw in the top of the NT9010.

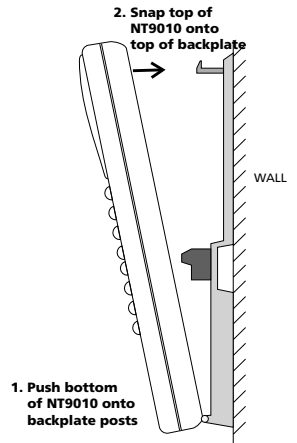

1.2.6 Mounting the Wireless Devices

Do not permanently mount the wireless devices until you have completed the Placement Tests (see **1.2.7 Enrolling Devices and Setting Up the System** on page 10). Once you have a good location for each of the devices, follow the mounting instructions on the *Installation Instruction* sheet for each device. For WLS904P-433, see **Appendix D: WLS904P Wireless Motion Detector Installation Instructions** on page 62. For WLS925L-433, see **Appendix C: WLS925L-433 Mini Door/Window Contact Installation Instructions** on page 61.

1.2.7 Enrolling Devices and Setting Up the System

Flash Programming will guide you through the steps needed to set up each zone and basic system programming. If you need to perform more advanced programming for your installation, please see **Chapter 2: Advanced Programming** on page 15.

To access Flash Programming:

1. Press [★][8].
2. Enter the Installer's code. The Installer Code is [5555] at default, but should be changed to prevent unauthorized access to programming.
3. Press [1] to enter Flash Programming.
4. Follow the audio instructions announced by Flash Programming. Flash Programming will guide you through the following programming areas:
 - Device enrollment
 - Zone label assignment
 - Central station telephone number
 - System account code
 - Placement tests of each wireless device

You can use the Forward (Playback) button to advance to the next section in Flash Programming, and the Backward (Record) button to return to the previous section.
5. Be sure to record all the zone serial numbers and your programming choices in the *NT9010 Programming Worksheets*.

Here are some notes about system programming done through Flash Programming.

Zone Definitions

When you enter a serial number for a device into the NT9010 Flash Programming, the unit will analyze the number to determine what kind of device you are enrolling. Based on the type of device, the system will make the following programming choices:

Device Type	Zone Definition	Other Programming
Door/window contact (2XXXXX, including hard-wired contacts entered as 200001 and 200002)	Delay 1 (Type [01])	For hardwired zones (serial numbers 200001 and 200002), Zone Supervision disabled (section [804])
Motion or glassbreak detector (3XXXXX)	Interior Stay/Away (Type [05])	None
Smoke detector (4XXXXX)	Delayed 24 Hour Fire (Type [87])	None
Wireless key (6XXXXX)	None	None

NOTE: To ensure that the NT9010 works properly, you should enroll all entry/exit point zones first.

NOTE: PIR's covering entry points should be zone type [06] Delay Stay/Away

[01] Delay 1 Zone: If this zone is violated when the system is armed (e.g. door or window is opened), the entry delay will begin. The buzzer will sound to warn the user that the system must be disarmed. If the system is not disarmed before the entry delay expires, an alarm will be generated.

[05] Interior Stay/Away Zone: If this type of zone is violated when the system is armed (e.g. the motion detector senses motion), an instant alarm will be generated unless a Delay Zone is violated first. If a Delay Zone is violated first, this zone will also follow the entry delay.

The zone will be automatically bypassed under the following conditions:

- the NT9010 is armed in the Stay Mode
- the NT9010 is armed without entry delay ([★][9] arming)
- the NT9010 is armed with an access code and during the exit delay a Delay zone is NOT violated (user does not go through the entry/exit door).

If zones are automatically bypassed, the user can reactivate the zones by entering [★][1].

[87] Delayed 24 Hour Fire (Wireless): If this zone is violated (e.g. the smoke detector senses smoke), the alarm will immediately sound, but the alarm communication to the central station will be delayed for 30 seconds. If during the 30 second delay the user presses the [#] key, the alarm and communicator will be delayed an additional 90 seconds. This provides time for a user to correct the problem.

If after the 90 second delay the zone is still violated the process will begin again: the alarm will sound but the alarm communication will be delayed for 30 seconds.

If the user does not press the [#] key, after 30 seconds the alarm will latch on and the system will communicate a fire alarm to the central station. The alarm will sound until the Bell Cutoff time expires, or until a valid code is entered.

Programming Zone Labels

If an enrolled device is a door/window contact, motion detector, glassbreak detector, or smoke detector the system will then prompt you to enter an audio label for the new zone. You can choose from any of the following preset audio labels:

Press Function Key:	Door/window contacts (2XXXXX)	Motion or glassbreak detector (3XXXXX)	Smoke detector (4XXXXX)
A	Front door	Main floor motion	Main floor fire
B	Back door	Upstairs motion	Upstairs fire
C	Garage door	Downstairs motion	Downstairs fire
D	Window	Hallway motion	Hallway fire
E	Patio door	Garage motion	Garage fire

If necessary, you can also program custom labels for the zones through the NT9010 Flash Programming.

1. For door/window contacts, motion detectors, and glassbreak detectors, at the appropriate place in Flash Programming, instead of selecting labels A to E, press function key F.
2. You can now enter up to six pre-programmed words from the Audio Label Library. For each word you want to program, enter a 3-digit code from the Label Library (for a list of labels and codes, see the *NT9010 Programming Worksheets*, Appendix A). If your label is less than six words, press [#] at the end of the label.
3. If you want to use a recorded label instead of the words available in the Audio Label Library, enter [244] for the first label entry, then the number of the label [001] to [005]. The recorded label will replace all six words in the section. You will not be able to add additional words to the label. To record a label for a zone, please see section **2.1.5 Programming Audio Labels** on page 16.
4. When you have entered the label, the system will recite it. If the label is correct, press [1]. If the label is not correct, press [2] and repeat steps 1 to 3 to fix the label.

NOTE: You must accept a label to exit this section. If you choose F for a custom label, then you must create your own label using the Audio Label Library and accept it.

NOTE: If you chose one of the audio labels, section [001] to [005] (#3 above) and there is no audio label recorded, the label will default to "zone X" where "X" is the zone number of the device enrolled. When the label is recorded in section [807], [701] to [705] it will be used.

Entering the Central Station Telephone Number

When prompted, enter the telephone number for the central station. The number can be up to 32 digits long. When you program the number, the system automatically inserts the hexadecimal digit "D" at the beginning, to tell the system to con-

duct a dial tone search before dialing. If necessary, you can enter the following hexadecimal digits in the telephone number:

- HEX B to dial “★” (function button B “Away”)
- HEX C to dial “#” (function button C “Chime”)
- HEX D for an additional dial tone search (function button D “Exit”)
- HEX E to insert a 2-second pause (function button E “Status”)

When you have finished entering the telephone number, press [★]. The system will recite the number back to you.

Entering the Account Code

The system will send the account code to the central station when communicating system events (e.g. Low Battery, Test Transmission). Enter a 4-digit code.

Testing the Placement of Wireless Devices

Each wireless detector must pass three consecutive placement tests before it will work properly on the system. Follow the instructions in Flash Programming to conduct the tests. The buzzer will squawk once for “Good” placement and three times for “Bad” placement.

If you exit the Placement Test section before all the zones have passed the necessary placement tests, a General System Trouble is generated. This trouble can only be cleared by re-entering the Placement Test and testing all of the devices that have not yet passed, or by deleting the serial numbers of the devices that did not pass the test (see **1.2.9 Deleting Wireless Devices** on page 13).

NOTE: *Deleting or passing the zone through DLS will not clear this trouble.*

1.2.8 Other NT9010 Options

After all zones have passed the Placement Test, Flash Programming will move to the advanced programming sections. If you do not need to do more programming, press [#] to exit.

If you need to complete programming not covered by Flash Programming, please see **Chapter 2: Advanced Programming** on page 15. For example, you may need to change the definitions of one or more zones. This programming is described in **2.3.1 Zone Definitions** on page 36.

1.2.9 Deleting Wireless Devices

To remove a wireless device from the system, you will need to use the advanced programming sections.

1. Press [★][8], then enter the Installer’s code. The default Installer’s code is [5555].
3. When prompted, press [2] to go to advanced programming.
4. Enter [804], then enter the 2-digit number of the zone you want to delete (01 - 32). The system announces the current serial number for the zone.
5. Program the serial number for the zone as [000000]. The wireless device for the zone will be removed.

NOTE: *You may need to remove power from the system and then restore it to clear troubles caused by deleted zones.*

Section 1.3: Troubleshooting

1.3.1 Typical Installation Problems and Solutions

When I try a placement test I get no result or “Bad” results.

Check the following:

- Are you testing the correct zone?
- Was the correct serial number entered when the device was enrolled?
- Is the device in range of the NT9010? Try testing the device in the same room as the NT9010.
- Are you testing the zone correctly? (See the *Installation Instruction* sheet for each device for testing instructions.)
- Are the batteries working and installed correctly?
- Are there any large metal objects that may be preventing the signal from reaching the NT9010?

The device must be located where at least three “Good” results are obtained. If several devices show “Bad” results, or if wireless keys operate inconsistently, you may need to move the NT9010. See **1.2.2 Create an Installation Plan** on page 5 for tips on choosing a mounting location for the NT9010.

The LED on the motion detector does not turn on when I walk in front of the unit.

The LED is for walk test purposes only. See your *WLS904-433*, *WLS904P-433* or *WLS914-433 Installation Instruction* sheet for walk test instructions.

Chapter 2: Advanced Programming

Section 2.1: Programming the NT9010

The chapter describes how to use advanced programming. For instructions on using Flash Programming, please see *Chapter 1: Quick Set Up Guide*.

2.1.1 How to Enter Advanced Programming You can use the Advanced Programming to set all communicator and system options. The **Installer Code** is [5555] at default, but should be changed to prevent unauthorized access to programming.

Step 1: From any keypad enter [★][8][Installer Code].

- The System light will flash and the Armed light will turn on to indicate you are in programming
- The NT9010 will announce “To use Flash Programming press 1. To bypass Flash Programming press 2.”

Step 2: To skip Flash Programming and go to the advanced programming sections, press [2].

Step 3: Enter the 3-digit section number you want to program.

- The Armed light will turn off and the Ready light will turn on to indicate the system is ready for the information for the selected section
- You can use the Forward (Playback) button to go forward through the advanced programming data. The Backward (Record) button will not work in the advanced programming sections, except for sections [301] to [303], and [402].

Step 4: Sections [802], [804], or [807] have 2- or 3-digit sub-sections. To access programming in these sections enter the programming sub-section number.

NOTE: *If the section number entered is not valid, the NT9010 will sound an error tone and say the section number that was entered.*

.....
Installer Code Section [006]
.....

2.1.2 Programming Decimal Data When the Ready light is ON the NT9010 is waiting for the information to be programmed for the selected section.

If a digit is entered for each program box in a section the system will automatically exit from the section. It will turn OFF the Ready light and turn the Armed light back ON.

You can also press the [#] key to exit a section before entering data for every box. This is handy if you only need to change the first few program boxes. All other locations in the section will remain unchanged. If the [#] key is pressed the system will turn OFF the Ready light, turn ON the Armed light and exit from the section.

You can use also the Forward (Playback) button to go forwards through the programming data. The Backward (Record) button will not work in the advanced programming sections (except for sections [301] to [303], and section [402]).

2.1.3 Programming Hexadecimal Data

You may need to enter hexadecimal (HEX) digits for some of the programming sections. To program a HEX digit press the function button corresponding to the HEX digit you want to program:

Button Name	HEX Digit
Stay	A
Away	B
Chime	C
Exit	D
Status	E
Volume	F

If you enter information into a section and make a mistake, press the [#] key to exit the section. Select that section again and re-enter the information correctly.

If you are using a pulse communications format, a decimal zero [0] does not transmit. Programming a zero [0] tells the system not to send any pulses for that digit. To make a zero [0] transmit, it must be programmed as a Hexadecimal 'A'.

2.1.4 Programming Toggle Options

Some sections contain several toggle options. Refer to the *Programming Worksheets* to determine what each option represents. When you enter a toggle option section, the NT9010 recites the numbers of the options that are currently ON.

Press the number corresponding to the option to toggle it ON or OFF. Once all the toggle options have been selected correctly press the [#] key to exit the section and save the changes.

2.1.5 Programming Audio Labels

You can program audio labels for the system, and for each of the zones. If you enroll the zones using Flash Programming, you can choose from five pre-set labels for the zone (please see *Chapter 1: Quick Set Up*).

Alternatively, you can program custom labels using the advanced programming sections. To program or change a label:

1. From Advanced Programming, enter section [807].
2. Enter the 3-digit sub-section number of the label ([601] to [633]). The system announces the section number and then recites the words presently programmed in the label. Each label may have up to six words. The system then prompts:
"Enter three digit word. To exit, press pound".
3. Enter the 3-digit code for each word you want to program. You can enter up to six words for each label. Please see **Appendix A: Audio Label Library** on page 27 in *Programming Worksheets* for a list of the 3-digit codes for each available word. To add numbers to a label, see **Adding Numbers to Labels** on page 17. If your label is less than six words, press [#] at the end of the label.

4. If you want to use a recorded label, in place of the first word of the label enter [244], then the number of the label [001] to [005]. The recorded label will replace all six words in the section. To record a label, see *Recording Custom Labels* on page 17.
5. When you have entered the label, the system will recite it. If the label is correct, press [#]. To change the label, repeat steps 1-4, above.
6. Record the new label in the appropriate section of the *Programming Worksheets*.

Adding Numbers to Labels

Three special Number Commands are available to allow the system to include a number in the voice label. The number commands allow the system to announce the number in three different modes:

Label 000: Number Command 1, Combined Form. The number will be announced in its full form. For example, the number 401 would be announced as “four hundred and one”.

Label 001: Number Command 2, Ordered Form. The number will be announced in a descriptive form. For example, the number 401 would be announced as “four hundred and first”.

Label 002: Number Command 3, Individual Numbers. Each digit in the number will be announced individually. For example, the number 401 would be announced as “four zero one”.

The number commands take up two of the six available word spaces in a label. In the first space select the type of announcement for the number (Number Command 000, 001 or 002). In the second space program the 3-digit number to be read (from 000 to 999).

NOTE: *Because number commands take up 2 label spaces, you cannot program them in the sixth entry spot for a label.*

Recording Custom Labels

You can record up to five custom labels for the system and for the zones using programming sections [701] to [705]. You can use any of these labels for the system or zone labels, instead of the words available in the Audio Label Library. To record a custom label:

1. From Advanced Programming, enter [807].
2. Enter one of sub-sections [701] to [705].
3. Press the Record function key on the NT9010.
4. Speak into the NT9010 microphone. Each label can be up to 1.5 seconds long. To stop recording, press [#].
5. When you are finished recording, press the Playback function key. The NT9010 plays your recorded label back to you. To listen to the label again, press Playback again.
6. If you want to re-record the label, press the Record function key again.
7. To record more labels, repeat steps 1 to 5.

NOTE: *If the NT9010 is completely powered down (both AC and battery power are lost), the recorded labels will be lost.*

2.1.6 Reviewing Programming To review the current programming for a section enter the 3-digit section number. The NT9010 will announce the data programmed. If the programming is correct press [#] to exit the section, otherwise enter the correct data.

2.1.7 Exiting Programming When the NT9010 announces "Enter Section Number", press the [#] key.

Section 2.2: Changing How the NT9010 Works For Users

Most NT9010 installations will only require basic programming. You can complete the basic programming using the NT9010 Flash Programming (please see *Chapter 1: Quick Set Up* for more information). The *NT9010 User's Guide* provides basic directions for arming and disarming the system, bypassing zones and performing user functions. The following sections provide information on how to customize the NT9010 interface for your users, and how to change which options are available to NT9010 users.

2.2.1 Accessing the NT9010 System Using a Telephone

Accessing the NT9010 Using a Local Telephone

To access the NT9010 system using a premise telephone, pick up any local Touch-Tone¹ telephone and enter the three digit **Telephone Access Code** (default [***]). The NT9010 will seize the line and announce

“Hello.”

If the **Access Code Required for Local Access** option is enabled (section [807]-[021] option [02]) the NT9010 will announce:

“Enter your Access Code.”

Enter your four or six-digit system access code. Invalid access codes count towards the **Keypad Lockout**, if enabled.

You can access the NT9010 using a local telephone, even if the telephone line is disconnected. For this to operate properly, you must enable **Telephone Line Monitoring** on the system (see **2.3.15 Telephone Line Monitoring (TLM)** on page 53).

You can change the Telephone Access Code to any 3 digit code using numbers 0 through 9 as well as the [*] and [#] keys. This access code can only be changed through Advanced Programming.

NOTE: *Avoid programming this code as a valid 3 digit area code or telephone service. Avoid numbers such as [911], [411], [611] or [0XX]. Do not try to exit this section by pressing [#], it will be accepted as a valid digit. To exit, program all 3 digits of the code or press [Forward].*

Telephone Access Code	Section [807]-[020]
Code Required for Local Access	Section [807]-[021], Option [2]
TLM Enable/Disable	Section [015], Option [7]
Keypad Lockout	Section [012]

Accessing the NT9010 Using a Remote Telephone

If the **Remote Access** option (section [807]-[021], option [01]) is enabled users can access the system from any Touch-Tone* telephone in the world.

NOTE: *Please pause for 1 second between key presses when entering access codes or commands on a remote phone.*

1. Touch-Tone is a trademark of Stentor Resource Centre Inc.

1. Call the telephone number the NT9010 system is connected to.
2. Let the telephone ring one or two times.
3. Hang up and wait 10 seconds before calling again. The NT9010 will answer after the first or second ring and announce "Hello."
4. Enter the 3-digit Telephone Access Code. If this is not entered within 10 seconds the NT9010 will hang up. Once the correct code has been entered, the system will prompt, "Enter your Access Code."
5. Enter a 4- or 6-digit access code. The NT9010 will begin to announce the status of the system. If you do not enter an access code within 20 seconds, or if you enter it incorrectly 3 times, the NT9010 will hang up. **Invalid access codes count towards the Keypad Lockout, if enabled (see 2.2.13 Keypad Options on page 34).**

NOTE: *The Maintenance Code can be used to access the system from a remote telephone.*

.....
Remote Access Enabled/Disabled Section [807]-[021], Option [1]
.....

2.2.2 Access Codes

For instructions on programming access codes, see the *NT9010 User's Guide (Programming Access Codes)*.

General access codes can arm and disarm the system. When the **Code Required for Bypassing** option is enabled, users will need to enter a valid access code in order to bypass zones. Individual access codes can have the Zone Bypassing attribute disabled under Access Code Attribute programming, see **Programming Access Code Attributes** on page 21.

If the **6-Digit User Access Codes** option is enabled, all the access codes may be programmed with six digits instead of four, with the exception of the Panel ID code and the Downloading Access Code. The Installer's Code will become [555555]. If 4-digit codes are already programmed and this option is selected, the first four digits of the programmed codes will remain as programmed and the last two digits will be [00].

If the **4-Digit User Access Codes** is selected, all codes will be 4-Digits in length. If 6-digit codes were previously programmed and this option is enabled, the last two digits of each code will be erased.

The available access codes are as follows:

General Access Codes - Access Codes [01] to [32]

Each access code can be used to arm and disarm the system. Additional access code attributes are also programmable to determine what abilities the code will have.

You can program access code attributes by following the instructions in this section.

Duress Codes - Access Codes [33] and [34]

When a Duress Code is used to perform any function the system will send a Duress Reporting Code to the central station (see **2.3.12 Communicator Reporting Codes** on page 47).

Master Code - Access Code [40]

The Master Codes can perform any keypad function. These codes can be used to program all access codes, including the Duress Codes.

If the **Master Code Not Changeable** option is enabled users will not be able to change the Master Code [40]. You will only be able to change it using Advanced Programming.

Supervisor Codes - Access Codes [41] to [42]

Supervisor Codes can program additional access codes. By default, Supervisor codes have the same attribute programming as the Master code. You can change the attribute programming for these codes by following the instructions in this section.

Maintenance Code

The maintenance code can only be used to arm and disarm the system. The maintenance code will also allow remote (telephone) access to the system.

It cannot be used to bypass zones, or for any other function. This code can only be programmed in Advanced Programming.

Installer's Code

You will use the Installer's Code to set up and to program the system. The **Installer Code** is [5555] at default, but should be changed to prevent unauthorized access to programming.

Telephone Access Code

If the NT9010 system is connected to the premise telephone line, users will be able to access their system using a premise or phone (see **2.2.1 Accessing the NT9010 System Using a Telephone** on page 19). Users will need to enter a Telephone Access Code before they can use the NT9010 system. The default Telephone Access Code is [***]. You can change this to any 3 digit code using numbers 0 through 9 as well as the [*] and [#] keys. This access code can only be changed through Advanced Programming.

NOTE: *Avoid programming this code as a valid 3 digit area code or telephone service. Avoid numbers such as [911], [411], [611] or [0XX]. Do not try to exit this section by pressing [#], it will be accepted as a valid digit. To exit, program all 3 digits of the code or press [Forward].*

Programming Access Code Attributes

Attributes determine what abilities an access code will have.

By default, each code has the attributes of the code used to program it. For example, if you use the Master code to program other access codes, the new codes will have the same attributes as the Master code. You can change the attribute programming by following the instructions below.

You cannot change Master code attribute programming. The Master code has all attributes turned on, except for the Bell Squawk on Arming/Disarming attribute.

To program each attribute:

1. Enter [*][5][Master code][9] to enter the attribute programming mode.
2. Enter the 2-digit number of the access code you want to edit.
3. Enter the attribute number to toggle it on or off.

The programmable attributes are as follows:

- Attribute 1: User enabled for arming, disarming, alarm reset, auto-arm cancel (on by default)
- Attribute 2: For future use
- Attribute 3: Zone Bypass enabled
This attribute allows the user to bypass zones.
- Attribute 4: NT9010 Telephone Access
This attribute allows the user to access the security system from a telephone when an access code is required.
- Attributes 5-6: For future use
- Attribute 7: Bell Squawk on Arming/Disarming. When this attribute is turned on, the bell will squawk when the access code is entered to arm or disarm the system. For example, you can use the arm/disarm bell squawk attribute to have wireless key access codes squawk the bell, while other codes are silent. To do this, enable attribute [7] on all access codes associated with wireless keys.

NOTE: *If you enable the Bell Squawk on Arming/Disarming option (section [014], option [1]), the bell will sound arm/disarm bell squawks for all access codes, regardless of the programming for attribute [7] (see 2.2.5 Arming and Disarming Options on page 24).*

.....

Installer's Code	Section [006]
Master code	Section [007]
Maintenance Code	Section [008]
Master Code Not Changeable	Section [015], Option [6]
Code Required for Bypassing	Section [015], Option [5]
6-digit User Access Codes	Section [701], Option [5]
Telephone Access Code	Section [807]-[020]

.....

2.2.3 Voice Prompt Interface

You can customize the voice prompt interface for the NT9010 users by turning individual prompts on or off, and by changing how the NT9010 system announces the current time.

To have the NT9010 system announce the time in am/pm format (e.g. 9:00am), turn on the **Clock is AM/PM** option. To have the system announce the time in 24-hr format (e.g. 21:00), turn on the **Clock is 24 Hour** option.

The NT9010 system is designed to be easy to use by reminding users of available commands. For example, after a user accesses the system, they can press [*] and the NT9010 system will announce the [*] commands that are available.

You can avoid confusing users by turning on only the prompts that apply to the system you are installing. The options in sub-section [004] only affect the NT9010 sys-

tem [★] command prompts: if a prompt is disabled, users will still be able to enter the command it refers to.

Sub-section [003] determines which Status prompts the user will hear. If an option is "ON", the system will announce the prompt when the appropriate condition is present. If an option is "OFF", the system will not announce the prompt if the condition is present. For example, if you turn off the "Zone Tamper" prompt, when a zone is tampered on the system, the NT9010 system will not announce it to the user.

You can also have the NT9010 system announce the names of zones that are opened or closed by turning on the **Verbal Chime** option. When this option is turned on, if the **Verbal Chime for Zone Openings** is also enabled, whenever a zone with the Chime attribute enabled is opened, a series of beeps will sound and the NT9010 will prompt (for example):

"Front Door"

If the **Verbal Chime for Zone Closings** is enabled, the NT9010 system will announce the zone label when the zone is closed. See also [*] [4] *Door Chime On/Off* on page 29.

You can create custom labels for the system and for each zone in the **Labels** programming area. Please see **2.1.5 Programming Audio Labels** on page 16 for more information.

.....

Clock is AM/PM	Section [807]-[002], Option [1]
System Status Prompts	Section [807]-[003]
[★] Command Prompts	Section [807]-[004]
Door Chime Zone Attribute	Sections [101] to [132], Option [3]
Verbal Chime Enabled/Disabled	Section [017], Option [2]
Verbal Chime for Zone Openings	Section [807]-[002], Option [2]
Verbal Chime for Zone Closings	Section [807]-[002], Option [3]
Custom Zone Labels	Sections [807]-[601] to [807]-[632]

.....

2.2.4 Alarm Announcements

If the **Verbal Alarm** option is turned on, the system will announce the first and last zones that have gone into alarm, along with the alarm tone. When a zone with the Audible attribute turned on goes into alarm, the NT9010 system will sound an alarm tone, but every 15 seconds it will pause the siren and the speaker will announce the zone(s) in alarm, for example:

"Alarm South Bedroom Window"

You can change the number of seconds between alarm announcements in the **Alarm Tone Period for Verbal Alarm** section.

Zones programmed as Silent, and 24 Hour Supervisory Buzzer zones will not be announced or cause the unit to annunciate at full volume.

NOTE: *Fire annunciation always overrides any burglary zone alarm annunciation. Alarms from Fire or Panic keys override all other alarm annunciations.*

NOTE: *The alarm announcements will stop with the siren at the end of the Bell Time Out period.*

.....
 Verbal Alarm Section [017], Option [3]
 Alarm Tone Period for Verbal AlarmSection [807]-[030]

2.2.5 Arming and Disarming Options

If the **Arm/Disarm Bell Squawk** option is enabled the system will squawk the alarm output once upon arming and twice upon disarming. If an alarm is in memory, when the system is disarmed the bell will sound three pairs of disarm squawks.

NOTE: *If you enable the Bell Squawk on Arming/Disarming (section [014], option [1]), the bell will sound arm/disarm bell squawks for all access codes, regardless of the programming for attribute [7] (see 2.2.2 Access Codes on page 20).*

Enable both the **Squawk on Away Arming/Disarming Only** and the **Arm/Disarm Bell Squawk** options to have the system squawk the bell only when the system is away armed or disarmed.

If the **Opening After Alarm Keypad Ringback** option is turned on, the system will beep the keypad 10 times rapidly if the system is disarmed after an alarm occurred. If the **Opening After Alarm Bell Squawk** option is turned on, the system will squawk the bell output 10 times rapidly if the system is disarmed after an alarm occurred.

If the system is armed using the Stay function key, or by entering [★][9][access code], there will be no bell squawks during entry and exit delays, except for the arm/disarm bell squawks.

Closing Confirmation, if enabled, will cause the keypad to beep 10 times rapidly after the closing reporting code has been successfully transmitted to central station.

If the **AC/DC Inhibit Arming** option is enabled, the system will not arm if there is an AC or DC (battery) trouble present on the system. Arming will not be allowed until the AC or battery trouble is cleared. If no AC or battery trouble is currently present, when a user attempts to arm the system, the system will do an automatic battery test. If the battery is good, the system will arm. If the battery is bad, the system will not arm.

If the AC/DC Inhibit Arming option is disabled, the system will not do an automatic battery test when arming is attempted and the user will not be prevented from arming the system when there is an AC or battery trouble.

If you enable the **WLS Key Does Not Use Access Codes** option, the disarm button *will* work on wireless keys which have not been assigned access codes.

To prevent disarming by wireless keys which don't have access codes, *disable* this option. (See also **2.2.11 Programming Wireless Keys** on page 33.)

.....
 Arm/Disarm Bell Squawk Section [014], Option [1]
 WLS Key Does Not Use Access Codes Section [017], Option [1]
 Bell Squawk on Away Arming Section [017], Option [8]
 Opening After Alarm Keypad Ringback Section [381], Option [1]

Opening After Alarm Bell Ringback Section [381], Option [2]
 Closing Confirmation. Section [381], Option [4]
 AC/DC Inhibit Arming Section [701], Option [3]

2.2.6 Automatic Arming

You can program the system to automatically arm at a specific time every day. Three items must be enabled in order to activate the auto arming function:

1. The correct time of day must be programmed. For instructions on programming the time and date, see the *NT9010 User's Guide* ("Setting the Time and Date").
2. Enter [★][6][Master Code][2] to enable (three keypad beeps) or disable (one long beep) the auto-arm feature.
3. Program the auto-arm time using the [★][6][Master Code][3] command.

When the internal system clock matches the programmed auto arm time, the system will check its status. If the system is armed, the NT9010 will do nothing until the programmed auto-arm time for the next day, when it will check again.

If the system is disarmed at the auto-arm time, the NT9010 control unit will sound the keypad buzzer for one minute. This is the auto arm pre-alert period.

If the **Bell Squawk During Auto Arm** option is enabled, the bell will squawk while the system is auto-arming in order to notify anyone on the premises that the system is being armed.

If a valid access code is entered during the auto arm pre-alert period, automatic arming will be cancelled. If automatic arming is cancelled by a user, the system will send the **Auto Arm Reporting Code** to the central station.

NOTE: *The Maintenance code cannot be used to cancel automatic arming.*

If no code is entered during the auto-arm prealert, the system will auto-arm. If a zone is violated when the system arms, the system will transmit a **Partial Closing Reporting Code** (if programmed), to indicate the system was not secure. If the zone is restored, the NT9010 will arm the zone and add it back into the system.

.....
 Program Time and Date [★][6][Master Code][1]
 Enable Auto Arming [★][6][Master Code][2]
 Program Auto Arm Time [★][6][Master Code][3]
 Partial Closing Reporting Code Section [343]
 Auto Arm Cancellation Reporting Code Section [348]
 Bell Squawk During Auto Arm Section [014], Option [2]

2.2.7 Entry and Exit Delay Options

Upon arming, the system will begin the exit delay. If **Audible Exit Delay** is enabled the keypad will beep every second until the exit delay expires. The keypad will beep rapidly for the last 10 seconds of exit delay to warn the user the system is about to arm.

Users can restart the exit delay one time while it is counting down by pressing the Away key. The system will not log the user who re-started the exit delay, unless the **Quick Arming Disabled/Function Keys Require Code** option is turned on (section [015], option [4]).

NOTE: *If the system has been Stay armed, or armed with no entry delay ([*][9]), pressing the Away key will not start an exit delay.*

For some applications **Bell Squawk on Exit Delay** may be enabled. The system will squawk the alarm output once every second when the exit delay is initiated and 3 times a second for the last 10 seconds until the exit delay expires.

Upon entry, if a Delay type zone is violated, the system will begin entry delay. The keypad will emit a steady tone. The keypad will pulse the keypad sounder during the last 10 seconds to warn the user the system is about to go into alarm. If there was an alarm during the armed period, the keypad sounder will pulse for the entire entry delay to warn the user of the previous alarm.

For some applications **Bell Squawk on Entry Delay** may be enabled. The system will squawk the alarm output once every second until the entry delay expires or the system is disarmed.

NOTE: *Since two Delay zones are programmable, and therefore two different Entry Delays, when the system is armed it will use the Entry Delay for the first Delay zone violated.*

If **Exit Delay Termination** is enabled the system will monitor the Delay zones during exit delay. If a Delay type zone is violated then secured during the exit delay, the exit delay will be terminated and the system will be armed immediately.

To prevent false alarms, use the built-in feature **Audible Exit Fault**. If a delay type zone is violated within 10 seconds after the exit delay has expired, the system will sound the entry delay warning through the keypad and siren alerting the customer that an improper exit was made. If the system is disarmed within the entry delay no signal is sent. If not, the system will continue to sound the alarm and send a signal to central station. This feature can be disabled in Section [013] Option [6].

.....

Bell Squawk During Auto Arm	Section [014], Option [2]
Bell Squawk on Exit Delay	Section [014], Option [3]
Bell Squawk on Entry Delay	Section [014], Option [4]
Audible Exit Delay	Section [014], Option [6]
Audible Exit Fault.	Section [013], Option [6]
Exit Delay Termination	Section [014], Option [7]

.....

2.2.8 Bell Options

When the system goes into alarm, the siren will sound. The siren will silence after the number of minutes programmed for the **Bell Cut-off** time have passed.

The system supervises the remote sounder. If an open condition is detected, the system will immediately indicate a trouble condition by beeping the keypad twice every 10 seconds to alert users to the problem.

If the **Temporal Three Fire Signal** option is enabled, all Fire signals will follow the Temporal Three Pattern as described in NFPA 72. If turned OFF all Fire signals will sound a one second on, one second off cadence.

If **Fire Bell Continuous** is enabled, the alarm output will sound until a code is entered. If disabled, the alarm will sound until a code is entered or the bell cut-off time has expired.

NOTE: Only fire zones will follow the Temporal Three Fire Signal.

.....

Bell Cut-off	Section [005]
Temporal Three Fire Signal Enable/Disable	Section [013], Option [8]
Fire Bell Continuous	Section [014], Option [8]

.....

2.2.9 User Commands

[*] [1] Zone Bypassing

Users can bypass individual zones using the [*][1] keypad command. This command can be used if users want to have access to an area while the system is armed, or to bypass a defective zone (bad contact, damaged wiring) until service can be provided.

A bypassed zone will not cause an alarm. Instructions on zone bypassing can be found in the *NT9010 User's Guide* ("Zone Bypassing").

When the system is disarmed, all zones bypassed using [*][1] will be unbypassed, except for 24-Hr zones.

If the **Code Required for Bypass** option is enabled, an access code will be required to enter the Bypass mode. Only access codes with the Bypass attribute enabled will be able to bypass zones (see **2.2.2 Access Codes** on page 20).

If the **Bypass Status Displayed While Armed** option is chosen, the System light will be ON while the system is armed to indicate that there are bypassed zones.

NOTE: If a 24 hour zone is bypassed, ensure that the zone is restored or disabled before removing the bypass.

.....

Code required for bypass	Section [015], Option [5]
Bypass Displayed While Armed	Section [016], Option [7]

.....

[*] [2] Trouble Announcements

The system constantly monitors itself for several different trouble conditions. If a trouble condition is present, the System light will be ON and the keypad will beep twice every 10 seconds. The trouble beep can be silenced by pressing any key on the keypad. If **Bell Squawk on Trouble** is enabled (section [014], option[5]), the bell will squawk every 10 seconds when a trouble condition is present.

To listen to an announcement of trouble conditions:

1. Press [*] [2].
2. The system will announce each trouble condition.

Possible trouble conditions are described below:

Service Required: The system has one or more of the following problems:

- Low Battery: Main system backup battery charge is low. Trouble is restored when the battery is fully charged.
- Remote Sounder Supervisory Trouble: The remote sounder is disconnected.
- Bad Module Placement: One or more devices have not passed the Placement Test.
- System Fault: Internal error on the system, return for repair.

The NT9010 will only announce "Service Required". If the control unit announces this trouble, users can press [1] to expand the troubles. The user should call for assistance. The specific trouble will be logged in the event buffer.

AC Failure: AC power is no longer being supplied to the NT9010 control unit. To conserve power, when there is an AC Failure all lights will turn off, except for the flashing System light.

Telephone Line Monitoring Trouble (TLM): There is a problem with the telephone line (See **2.3.15 Telephone Line Monitoring (TLM)** on page 53.)

Failure to Communicate (FTC): The communicator failed to communicate with any of the programmed telephone numbers (see **2.3.8 Communicator Dialing** on page 41).

Zone Fault (including Fire Zone): A zone on the system is experiencing trouble. This means that a zone could not generate an alarm on the system if required to do so (e.g. a fire zone is open, or a supervisory fault on a wireless zone). When a zone fault occurs, the unit will start to beep. Press [5] while in Trouble mode to hear an announcement of the affected zones.

NOTE: *A Fire zone trouble will be generated and announced in the armed state.*

Zone Tamper: The tamper switch is open on a wireless device. When a tamper condition occurs, the NT9010 will start to beep (if the system is armed, an alarm will occur). Press [6] while in the Trouble mode to hear an announcement of the affected zones. If a zone is tampered or faulted, it must be fully restored to clear the trouble. If a smoke detector is tampered, the Ready light will remain on and the system can be armed.

NOTE: *Once a zone is tampered or faulted, it must be completely restored before the trouble condition will clear.*

Device Low Battery: A wireless device has a low battery condition. Press [7] one, two, or three times to hear which devices are experiencing battery failure. The following will occur:

	Keypad beeps:	NT9010 Announces:
Press [7]	1	Zones with low batteries
Press [7] twice	3	Wireless keys with low batteries

Loss of System Time: When the system is powered up, the internal clock needs to be set to the correct time. This trouble is cleared when an attempt is made to reset the clock.

[*] [3] Alarm Memory

If there is an alarm in memory when the system is disarmed, the System light will be on. Press [*][3] to enter the alarm memory mode. The NT9010 system will announce the alarms that are in memory by zone number or label. For example:

"There is 1 alarm in memory. Fire Zone. To exit, Press '#'. "

Press [#] to return to the "Ready" mode. Alarm Memory is cleared when the system is armed.

[*] [4] Door Chime On/Off

Users can turn the **Door Chime** feature on or off by pressing [*][4]. If the door chime feature is enabled the keypad will beep 6 times rapidly when a zone is opened and closed. The system will only do this for zones with the **Door Chime Attribute** enabled and if the door chime feature is enabled (see **2.3.2 Zone Attributes** on page 38).

You can have the NT9010 system announce the names of zones when they are opened or closed by turning on the **Verbal Chime** feature. Please see **2.2.3 Voice Prompt Interface** on page 22.

.....

Door Chime Zone Attribute	Sections [101] to [132], Option [3]
Verbal Chime Enabled/Disabled	Section [017], Option [2]
Verbal Chime for Zone Openings	Section [807]-[002], Option [2]
Verbal Chime for Zone Closings	Section [807]-[002], Option [3]

.....

[*] [5] Programming Access Codes

All access codes can be programmed using the [*][5] command. For complete instructions on programming access codes, see the *NT9010 User's Guide* ("Programming Access Codes"). For information on access code attribute programming, see **2.2.2 Access Codes** on page 20.

[*] [6] User Functions

To program user functions, perform the following:

1. Press [*] [6] [Master code]. The keypad will flash the 'System' light.
2. Press the number [1] to [7] for the item to be programmed.
 - **[1] - Time and Date**
See the *NT9010 User's Guide* for instructions on setting the time and date ("Setting the Time and Date").
 - **[2] - Auto-Arm Enable/Disable**
Enter [2] to enable (three keypad beeps) or disable (one long beep) the auto-arm feature.
 - **[3] - Auto-Arm Schedule**
Enter [3] to change the auto-arm time.
Enter the auto-arm time in 24-hour format (i.e. enter a 4-digit number in [hhmm] format).
 - **[4] - System Test**
For step-by-step instructions on performing a system test, see the *NT9010 User's Guide* ("Full System Test"). When [4] is pressed the system will perform the following:
 - sound the alarm output for two seconds
 - light all lights on the keypad
 - sound the keypad buzzer for two seconds
 - test the NT9010 battery
 - send a System Test Reporting code, if programmed (see **2.3.12 Communicator Reporting Codes** on page 47).
 - **[5] - Enable DLS (Downloading)**
When [5] is pressed the system will turn on the downloading option for 1 or 6

hours. During this time the system will answer incoming downloading calls (see **2.3.14 Downloading** on page 51).

- **[6] – User-Initiated Call-Up**

When [6] is pressed, the system will initiate a call to the downloading computer.

- **[7] Telephone Volume Control**

You can change the volume of the voice prompts heard when you access the NT9010 system by telephone. When you press [7], the NT9010 will prompt “Phone Volume is High. To change phone volume, press ‘1’. To exit press #.” Options are ‘Low’, ‘Medium’, and ‘High’, with ‘High’ as the default. You can change the current selection by pressing [1].

NOTE: *To change the volume of the voice prompts from the NT9010 unit you must use the Volume Key on the NT9010.*

- **[*] [8] Flash Programming / Advanced Programming**

Enter [*][8] followed by the Installer Code to enter Flash Programming, or the Advanced Programming sections (see **Section 2.1: Programming the NT9010** on page 15).

- **[*] [9] Arming Without Entry Delay**

When a system is armed with the [*][9] command the system will remove the entry delay from the system. After the exit delay, Delay 1 and Delay 2 type zones will be instant and Stay/Away zones will remain bypassed. (see **2.3.1 Zone Definitions** on page 36). When the system is armed in this mode, the Armed light will be flashing and NT9010 will announce that there are zones bypassed.

For more information regarding this feature, see the *NT9010 User’s Guide*.

- **[*] [0] Quick Arm**

If the **Quick Arm Enable** option is on, the system can be armed by entering [*][0]. This is a useful method of arming the system when someone doesn’t have an access code.

NOTE: *The Quick Arm feature must be enabled in order for the Stay/Away function keys to operate as intended. If the feature is not enabled, the user will be required to enter a valid access code after pressing the Stay or Away function key in order to arm the system in the stay or away mode.*

- **[*] [0] Quick Exit**

Quick Exit will allow someone to leave an armed premise through a Delay type zone without having to disarm and rearm the system.

When [*][0] is entered, if the **Quick Exit Enabled** option is on, the system will provide a two minute window to exit. During this time the system will ignore the first activation of a Delay type zone. When the Delay zone is secured the system will end the two minute time period.

If a second Delay zone is tripped, or if the zone is not restored after two minutes, the system will start entry delay.

Quick Arm Enable	Section [015], Option [4]
Quick Exit Enable.	Section [015], Option [3]

2.2.10 Function Keys

There are eight function keys on the NT9010 labelled Stay, Away, Chime, Exit, Status, Volume, Record and Playback. The operation of these keys is described below. Users can activate each function by pressing the key.

The programming of any function key on the NT9010 may be changed to any of the options listed below. To change the programming of a function key:

1. Enter [*][8][Installer's Code].
2. Enter section [807].
3. Enter [000] for function key programming.
4. Enter the 2-digit code for the function you want to program for each key. (Each function is described below.)
5. When you are finished, press [#] to exit.

[00] - Null Key

The key is not used and will perform no function when pressed.

[01] - [02] For future use

[03] - Stay Arm

Arms the system in Stay mode. All Stay/Away type zones will be automatically bypassed. Delay type zones will provide entry and exit delay. The **Quick Arm** feature must be enabled for this key to function (*Section [015], Option [4]*). If Quick Arming is not enabled, the user must enter a valid access code after pressing the function key in order to arm the system in the Stay mode.

[04] - Away Arm

Arms the system in Away mode. All Stay/Away type zones will be active at the end of the exit delay. Delay type zones will provide entry and exit delay. The **Quick Arm** feature must be enabled for this key to function (*Section [015], option [4]*). If Quick Arming is not enabled, the user must enter a valid access code after pressing the function key in order to arm the system in the Away mode.

[05] - [*]+[9] No-Entry Delay Arm

After this function key is pressed the user must enter a valid access code. The system will arm and remove entry delay from the system when the exit delay expires (see *[*] [9] Arming Without Entry Delay* on page 30).

[06] - [*]+[4] Door Chime On/Off

Pressing the key will toggle the Door Chime feature ON or OFF. One solid beep means the feature has been disabled, three short beeps means it has been enabled.

[07] - [*]+[6]...[4] System Test

This function key provides the user with a simple method for testing the system (see *[*] [6] User Functions* on page 29).

[08] - [*]+[1] Bypass Mode

This function key provides the user with a simple method for entering the Bypass Mode. If an access code is required it must be entered before bypassing can be performed (see *[*] [1] Zone Bypassing* on page 27).

[09] - [*][2] Trouble Display

This function key provides the user with a simple method for entering the Trouble Display Mode (see **[*] [2] Trouble Announcements** on page 27).

[10] - [*][3] Alarm Memory

This function key provides the user with a simple method for entering the Alarm Memory Display Mode (see **[*] [3] Alarm Memory** on page 28).

[11] - [*][5] Programming Access Codes

This function key provides the user with a simple method for programming access codes. After this key is pressed a valid System Master or Supervisor Code will have to be entered before the system will allow programming to be performed (see **[*] [5] Programming Access Codes** on page 29).

[12] - [*][6] User Functions

This function key provides the user with a simple method for programming User Functions. After this key is pressed a valid System Master or Supervisor code must be entered before the system will allow User Functions to be performed (see **[*] [5] Programming Access Codes** on page 29).

[13] - [15] For future use

[16] - [*][0] Quick Exit

Pressing this key will cause the system to activate the Quick Exit feature (see section **[*] [0] Quick Exit** on page 30).

[17] - [*][1] Reactivate Stay/Away Zones

This function key provides the user with a simple method for adding Stay/Away zones back into the system (see **[*] [1] Zone Bypassing** on page 27).

[18] - [26] For future use

[27] - Status

Press this key to have the NT9010 announce the time and the current status of the system. For example, the system may announce:

“Zones are open. Zone 1. Secure system before turning on. For more options, press [*].”

Pressing this key while the unit is speaking will cause the unit to stop speaking.

[28] - Volume

To change the volume of NT9010 announcements, press this key. The NT9010 will announce the different volume levels.

[29] - Record

Press this key to begin recording a message through the NT9010 microphone. After you hear the prompt “Record Memo Now” and a single 1 second tone, begin recording your message. When you are finished recording, press [#].

[30] - Playback

Press this key to listen to a recorded message. If there is no message recorded, the NT9010 will sound an error tone. You can stop playback of the recorded memo any time by pressing [#].

NOTE: Keys [27] to [30] are instant function keys. They do not have to be held for 2 seconds to activate.

2.2.11 Programming Wireless Keys

If you will be adding WLS929-433 wireless keys, after you enroll them on the system you may want to change the functions of the buttons on these devices.

If you enable the **WLS Key Does Not Use Access Codes** option, the disarm button *will* work on wireless keys which have not been assigned access codes. To prevent disarming by wireless keys which don't have access codes, *disable* this option.

To change wireless key function buttons, from Advanced Programming:

1. Enter section [804].
2. Enter the 2-digit sub-section number of the button you want to program:
 - [61] = Wireless key button 1
 - [62] = Wireless key button 2
 - [63] = Wireless key button 3
 - [64] = Wireless key button 4
3. Enter the 2-digit code from the list below for the function you want the button to have:

Entry	Description	Can Be Used on Wireless Key
00	Null Key (Key not used)	Yes
03	Stay Arm	Yes
04	Away Arm	Yes
05	No entry delay arming	No
06	Door Chime On/Off	Yes
07	System Test	Yes
16	Quick Exit	Yes
17	Activate Stay/Away Zones	Yes
27	Disarm (Off)	Yes
28	Fire Alarm	Yes
29	Auxiliary Alarm	Yes
30	Panic Alarm	Yes
31	Status	Yes

4. Repeat steps 1 to 3 until all buttons are programmed.

.....

Wireless Key Function	
Button Programming	Sections [804]-[61] to [804]-[64]
WLS Key Does Not Use Access Codes	Section [017], Option [1]

.....

2.2.12 Fire, Auxiliary, and Panic Keys

Three emergency keys are available on the NT9010. Each pair of keys must be pressed and held for 2 seconds before they will activate. This 2 second delay is designed to help prevent accidental activation.

If the **Fire Keys** option is enabled, when the Fire keys are pressed and held for 2 seconds, the system will activate the alarm output. It pulses one second on, one second off only if option 8 of Section [013] is disabled (Standard Fire option). If **Fire Bell Continuous** is selected the alarm output will sound until a code is entered; otherwise it will sound until a code is entered or the alarm output times out. Communication of the signal to central station is immediate.

If the Auxiliary Keys are pressed and held for 2 seconds, the unit beeps three times to verify activation. The system will beep the keypad ten times rapidly to verify communication to the central station.

If the Panic Keys are pressed and held for 2 seconds, the system will immediately communicate the signal to central station. If **Panic Keys Audible** is enabled, the system will beep the keypad three times upon activation and activate the alarm output until a code is entered or the alarm output times out. Otherwise the alarm will be completely silent.

NOTE: *The Fire, Auxiliary, Panic keys will operate even if Keypad Lockout is active (see 2.2.13 Keypad Options on page 34).*

Fire Keys Enable.	Section [015], Option [1]
Panic Keys Audible	Section [015], Option [2]
Fire Bell Continuous.	Section [014], Option [8]

2.2.13 Keypad Options

The system can be programmed to 'lockout' keypads if a series of incorrect access code entries are made. After the **Number of Invalid Codes Before Lockout** has been reached the system will lock out the keypad for the **Lockout Duration** and log the event to the event buffer. For the duration of the lockout the system will sound an error tone when any key is pressed. The invalid code counter will be reset every hour.

To disable Keypad Lockout program the **Number of Invalid Codes Before Lockout** as (000).

NOTE: *If Keypad Lockout is active, the system cannot be armed or disarmed with a keyswitch.*

If the **Keypad Blanking Option** is enabled the system will turn off all lights on the NT9010 if no key is pressed for 30 seconds. The keys, however, will remain backlit.

The system will turn the NT9010 lights back on if entry delay begins or an audible alarm occurs. If the **Code Required to Restore Blanking Option** is enabled, the lights will turn on when a valid access code is entered. Otherwise, the lights will turn on when a key is pressed.

NOTE: *Keypad function keys will still operate when the keypad is blank, unless the function key is programmed to require an access code.*

The keys of all the keypads can be backlit to provide easy viewing in dim lighting conditions. If the **Keypad Backlighting Option** is enabled the keys will be illuminated.

If the **Bypass Status Displayed While Armed** option is chosen, the System light will be ON while the system is armed to indicate that there are bypassed zones.

.....

Number of Invalid Codes Before Lockout	Section [012]
Lockout Duration	Section [012]
Keypad Blanking Option	Section [016], Option [3]
Code Required to Restore Blanking	Section [016], Option [4]
Keypad Backlighting Option	Section [016], Option [5]
Bypass Displayed While Armed	Section [016], Option [7]
Keypad Lockout Reporting Code	Section [338]

.....

2.2.14 Sleep Mode

To conserve the backup battery during the loss of AC power, the NT9010 control unit will enter “sleep mode” after AC power is missing for 30 seconds. When the NT9010 is in sleep mode, all the lights on the unit will turn off, except for the System light, which will flash regardless of Keypad Blanking options.

NOTE: *The system will not enter “sleep mode” during some trouble conditions.*

NOTE: *There will be no remote sounder supervision when the system is in “sleep mode”.*

The system will “wake up” and run on the backup battery when any system event occurs, or when a user presses a button on the unit. The key used to “wake up” the system will be ignored.

NOTE: *Double calls for remote access should be done between 10 and 30 seconds from the first call. The first call may only wake up the system; an additional call may then be required if the NT9010 does not pick up on the second call.*

Section 2.3: Changing Other NT9010 Functions

Most installations will only require basic programming. You can complete the basic programming using the NT9010's Flash Programming (please see *Chapter 1: Quick Set Up* for more information). This section explains programmable features that affect the internal functioning of the system, including zone operation, central station communications, talk/listen-in features, computer downloading features, and other advanced options.

2.3.1 Zone Definitions

You can change how each of the 32 zones will operate in programming sections [001] - [004]. For each zone that will be used, enter a 2-digit zone definition.

NOTE: *In addition to selecting how each zone will operate, attributes may be programmed by zone (see 2.3.2 Zone Attributes on page 38).*

NOTE: *PIR's covering entry/exit zones should be type [06] Delay Stay/Away.*

- [00] Null Zone:** The zone will not operate in any way. Zones that are not used should be programmed as Null zones.
- [01] Delay 1 Zone:** If this zone is violated when the system is armed it will provide an entry delay. The keypad buzzer will sound to warn the user that the system must be disarmed. If the system is not disarmed before the entry delay expires an alarm will be generated. Typically this type of zone will be used for the front door, back door or any other entry/exit point. Refer to Section [005], "System Times", to program the Delay 1 zone entry delay time.
- [02] Delay 2 Zone:** This zone type operates the same as the Delay 1 zone option but can provide a different entry delay. Typically this zone will be used for a garage door. Refer to Section [005], "System Times", to program the Delay 2 zone entry delay.
- [03] Instant Zone:** If this zone type is violated when the system is armed it will cause an instant alarm. Typically this zone is used for windows, patio doors or other perimeter type zones.
- [04] Interior Zone:** If this type of zone is violated when the system is armed it will follow entry delay if a delay type zone was violated first. Otherwise it will cause an instant alarm. Typically this zone is used for interior protection devices, such as motion detectors.
- [05] Interior Stay/Away Zone:** This zone type works the same as the Interior zone type with one exception. The zone will be automatically bypassed under the following conditions:
- the system is armed in the Stay Mode (see **2.2.10 Function Keys** on page 31)
 - the system is armed without entry delay (see **[*] [9] Arming Without Entry Delay** on page 30)
 - the system is armed with an access code and during the exit delay a Delay type zone is NOT tripped
- The automatic bypass avoids having the user manually bypass interior type zones when arming at home. If automatically bypassed, the user can reactivate the zones by entering the **[*][1]** command (see **[*] [1] Zone Bypass-**

ing on page 27). Typically this zone is used for interior protection devices, such as motion detectors.

- [06] **Delay Stay/Away Zone:** This zone type will operate the same as the Interior Stay/Away zone type except that it will always provide entry delay. Typically this zone is used for interior protection devices, such as motion detectors, and will help prevent false alarms since it will always provide the user the entry delay time to turn off the system.

[07] - [09] **For future use**

- [10] **24 Hour Supervisory Buzzer Zone:** Whether armed or disarmed, when this zone type is violated the system will immediately latch the keypad buzzer until a valid access code is entered and will communicate immediately to the central station.

- [11] **24 Hour Burglary Zone:** If this zone is violated, whether armed or disarmed, the system will immediately latch the alarm output and communicate to the central station. The alarm will sound for the Bell Cutoff time programmed in Section [005] "System Times" or until a valid access code is entered.

[12]-[20]:

The following zone definitions operate similar to the 24 Hour Burglary except for System Event output type, SIA identifier, and some zone attributes:

- [12] 24 Hour Holdup Zone
- [13] 24 Hour Gas Zone
- [14] 24 Hour Heat Zone
- [15] 24 Hour Medical Zone
- [16] 24 Hour Panic Zone
- [17] 24 Hour Emergency Zone
- [18] 24 Hour Sprinkler Zone
- [19] 24 Hour Water Flow Zone
- [20] 24 Hour Freezer Zone

NOTE: [12] 24 Hour Holdup zones give a silent alarm by default.

- [21] **24 Hour Latching Tamper:** If this zone is violated the installer must enter Installer Programming before the system can be armed. The bell output will also activate for the programmed time and the system will communicate the alarm.

- [22] **Momentary Keyswitch Arm Zone:** Momentary violation of this zone will alternately arm/disarm the system.

- [23] **Maintained Keyswitch Arm Zone:** When this zone is violated, the system will arm. When this zone is secured, the system will disarm.

NOTE: Do not program wireless zones as [22] or [23] Keyswitch zones.

[24] **For future use**

- [25] **Interior Delay Zone:** When the system is fully armed (i.e. away armed), this zone will follow the exit delay. It will also follow the entry delay, provided that a delay zone is tripped first. If the delay zone is not tripped first, a zone defined as "Interior Delay" will go into alarm instantly. When the sys-

tem is stay armed, this zone will be active, but when it is tripped, it will initiate the entry delay.

- [87] Delayed 24 Hour Fire (Wireless):** If this zone is violated (e.g. the smoke detector senses smoke), the alarm will immediately sound, but the alarm communication to the central station will be delayed for 30 seconds. If during the 30 second delay the user presses the [#] key, the alarm and communicator will be delayed an additional 90 seconds. This provides time for a user to correct the problem.

NOTE: *If a second Fire zone is violated, or if the Fire keys are pressed during the delay time, the panel will latch the alarm output and communicate immediately.*

- [88] Standard 24 Hour Fire (Wireless):** When this zone is violated (e.g. the smoke detector senses smoke), the panel will immediately latch the alarm output and communicate to central station. The alarm will sound for the Bell Cutoff time programmed in Section [005], or can be programmed to sound until a valid code is entered (Section [014], Option [8]).

NOTE: *A faulty fire zone will not inhibit arming.*

2.3.2 Zone Attributes

Each zone will operate according to the Zone Definition selected for it (see **2.3.1 Zone Definitions** on page 36).

You can customize the operation of a zone for a specific application by changing the zone attributes. The following attributes are programmable by zone:

NOTE: *Do not change attributes for Fire Zones from the default settings.*

- **Audible/Silent** Determines whether the zone will activate the alarm output or will be silent.
- **Pulsed/Steady** Determines if the alarm output will be steady or pulse on for 1 second and off for one second.
- **Activate Chime** Determines if the zone will activate the chime feature (see **[*] [4] Door Chime On/Off** on page 29).
- **Bypass Enable** Determines if the zone can be manually bypassed (see section **[*] [1] Zone Bypassing** on page 27).
- **Force Arm Enable** Determines if the system can be armed with the zone violated. At the end of exit delay, if this type of zone is violated, it will be ignored by the system. Once the zone is secured it will be added back into the system. This zone attribute is useful for a garage door. The customer can arm the system with the garage door open. Later when the customer closes the door it becomes part of the system.

NOTE: *24-hour zones must not have Force Arm enabled.*

- **Swinger Shutdown Enable** Determines if the system will shut down the communicator for the zone after the swinger limit is reached (see **2.3.18 Swinger Shutdown** on page 54).
- **Transmission (TX) Delay Enable** Determines if the system will delay communicating the alarm reporting code to the central station (see **2.3.12 Communicator Reporting Codes** on page 47).

- **Wireless Zone** Determines if the zone is a wireless zone or a hardwired zone. Allows the system to generate low battery trouble and zone supervisories.

NOTE: *The wireless zone attribute must be enabled for all enrolled wireless zones.*

Audible/Silent Alarm	Section [101] to [132], Option [1]
Pulsed/Steady Alarm	Section [101] to [132], Option [2]
Activate Chime	Section [101] to [132], Option [3]
Bypass Enable	Section [101] to [132], Option [4]
Force Arm Enable	Section [101] to [132], Option [5]
Swinger Shutdown Enable	Section [101] to [132], Option [6]
Transmission Delay Enable	Section [101] to [132], Option [7]
Wireless Zone	Section [101] to [132], Option [8]

2.3.3 Enrolling Hardwired Zones

You can install up to two hardwired zones on the NT9010 system. To make the wiring connections for these zones, please see **Connecting Zone Wiring – Hardwired** on page 7. You must also enroll the hardwired zones on the system.

To do this, in Flash Programming enter serial number [200001] for the first hardwired zone, and [200002] for the second hardwired zone. The NT9010 system will automatically assign the hardwired zone to the next available zone number.

If you need to change the zone assignment of the hardwired zones, you can do this in the Advanced programming sections:

1. Enter programming section [807].
2. Enter sub-section [091] for the first hardwired zone, or sub-section [092] for the second hardwired zone.
3. Enter the 2-digit number of the zone that will be hardwired.

NOTE: *Entering a zone as a hardwired zone will override any wireless device serial number that may be programmed for the zone.*

NOTE: *Fire zones are not supported as hardwired zones.*

2.3.4 Wireless Device Serial Numbers

Normally, you will use the NT9010 Flash Programming to enter device serial numbers. If you need to delete a device from a zone, or replace a device, you can use the advanced programming section. To add, replace, or delete devices:

1. From Installer’s Programming, enter section [804]
2. Enter the 2-digit number of the zone you want to delete (01 - 32). The system announces the current serial number for the zone.
3. Enter the new serial number for the zone. To delete a device, enter [000000]. The wireless device for the zone will be removed.

NOTE: *You may need to remove power from the system and then restore it to clear troubles caused by deleted zones.*

2.3.5 Wireless Zone Supervision

NOTE: *The RF Jam Detect zone, hardwired zones, and Panic Pendants must have the supervision option disabled.*

Wireless Supervisory Window

Each wireless zone will send a supervisory signal every 64 minutes. If the receiver does not receive a signal within the time programmed for the **Wireless Supervisory Window**, it will generate a supervisory fault.

To program the wireless supervisory window, from Advanced Programming:

1. Enter section [804].
2. Enter sub-section [81].
3. Enter the time period for the supervisory window (valid entries are 01-24 hours).
4. To exit press [#].

Disable/Enable Zone Supervision

When you enroll a zone through the NT9010 Flash Programming, the Wizard will automatically turn on supervision for the zone. To disable supervision for any zone, enter the following through Advanced Programming:

1. Enter section [804].
2. Enter sub-section [82], [83], [84] or [85]. Disable or enable supervision for each wireless zone by turning each relevant option on or off.
3. To exit press [#].

NOTE: *If you replace an RF Jam Detect zone or hardwired zone with a different type of device (e.g. a motion detector), supervision of the device will not be turned on automatically. You must turn it on as described above.*

2.3.6 RF Jamming Detection Zone

For RF jamming detection to work, you must select an unused zone to be used as the RF Jam Detect zone. When the NT9010 system detects an attempt to jam the RF signal, the RF Jam Detect zone will be violated and the system will generate a tamper signal. When the jamming signal is gone, the RF Jamming Detection zone closes and the system sends a tamper restore signal.

To enable RF jamming detection, from Advanced Programming:

1. Enter programming section [807], then sub-section [093].
2. Select an unused zone to be the RF Jam Detect zone. Enter the 2-digit number ([01] to [32]) of the RF Jam Detect zone on the keypad.
3. Program a Zone Definition for the zone number you assigned to the RF Jam Detect zone. A 24-hour zone type is recommended if this is used.
4. RF jamming detection is now enabled. To exit Advanced Programming, press [#].

NOTE: *If you need to change the RF Jamming Detection Zone, you should first delete the zone by entering (00) in section [807], sub-section [093].*

NOTE: *Programming RF Jam Zone will automatically program the corresponding label as RF Jam. Please be sure that the corresponding serial number is (000000). RF Jam will not work properly otherwise*

.....
 RF Jamming Detection Zone. Section [807]-[093]

**2.3.7 Zone Tamper/
 Fault Options**

By enabling **Tampers/Faults Do Not Show as Open**, faults and tampers for wireless zones will not be annunciated, and will be hidden from the end user. If the option is disabled, faults and tampers will be annunciated.

NOTE: *Once a zone is tampered or faulted, it must be completely restored before the trouble condition will clear.*

If the **All System Tampers Require Installer Reset** option is enabled, any zone faults must be reset by entering [*][8][Installer's Code] before the system can be armed. Auto-Arming and Keyswitch arming will also be prevented in the presence of any zone fault.

NOTE: *The Auto Arm cancellation code will not be transmitted if arming is inhibited due to a zone fault. The Auto Arm cancellation code will be transmitted if arming is inhibited due to Latching Tamper.*

.....
 Tampers/Faults Do Not Show As Open Section [013], Option [4]
 All System Tampers Require Installer Reset Section [701], Option [4]

**2.3.8 Communicator
 Dialing**

If the **Communicator Disable** option is selected the system will never attempt to call central station. If the Communicator is enabled, the system will attempt to call central station when an event occurs that has a valid reporting code programmed (see **2.3.12 Communicator Reporting Codes** on page 47). You must also program a valid telephone number for the communicator to work.

Communicator Call Direction Options are used to select where the system will send different kinds of reporting codes when events occur. You can choose to have the system send reporting codes to:

- 1st telephone number
- 2nd telephone number

These options are programmed separately for each type of reporting code.

The different types of reporting codes are:

- Alarm/Restore codes
- Tamper Alarm/Restore codes
- Opening/Closing codes
- System Maintenance Alarm/Restore codes
- System Test Transmission codes

When the **Force Dialing** option is enabled, the system will dial out regardless of the presence of dial tone. Each dialing attempt will follow this pattern:

- a) the system picks up the telephone line and searches for dial tone for 5 seconds
- b) if no dial tone is found, the system hangs up and waits for 20 seconds

- c) the system picks up the telephone line again and searches for a dial tone for 5 seconds
- d) the system will then dial regardless of the presence of dial tone

If there is no initial handshake recognized within 40 seconds the system will then hang up the line.

If the Force Dialing option is disabled, each attempt will still follow the above pattern, except that the system will not dial in step (d) if no dial tone is detected.

The **Delay Between Dialing Attempts** timer adds a delay before the next call is dialed.

If the **Busy Tone Detection** option is enabled, the system will hang up after detecting busy tone for 5 seconds and will redial after the amount of time programmed in the Delay Between Dialing Attempts section.

If **DTMF Dialing** is enabled the system will dial using DTMF (Touch-Tone). If **Switch to Pulse Dial** is enabled the system will switch to pulse dialing on the 5th attempt to call the central station. If disabled the system will always dial DTMF.

If **DTMF Dialing** is disabled the system will always pulse dial.

The **Post Dial Wait for Handshake** determines the amount of time the system will wait for a valid handshake from the receiver. If the system does not hear the handshake it will consider the call a failed attempt, hang up and try again.

The **Maximum Dialing Attempts** determines the maximum number of attempts the system will make to send a signal to the central station before indicating a Failure to Communicate (FTC) trouble condition. The 3rd telephone Number can be used to back up the 1st in this situation (see **2.3.9 Communicator Telephone Numbers** on page 43).

When **Bell on FTC when Armed** is enabled, a failure to communicate (FTC) during the armed period will sound an audible alarm for the length of Bell time-out, or until the system is disarmed. If **FTC Trouble Only when Armed** is enabled, only the keypad buzzer will sound trouble beeps every 10 seconds until a key is pressed.

The **Pulse Dialing Make/Break Ratio** option can change the Make/Break ratio to 33/67 from the North American ratio of 40/60.

With **ID Tone Enabled** the system will pulse a tone on the telephone line to indicate that the system is on the line.

The **2100Hz/1300Hz ID Tone** option selects the frequency of the ID tone that is pulsed on the line.

If you enable the **Standard Communications Priority** option, the NT9010 system will only disconnect DLS and Talk/Listen sessions for alarm and Priority (FAP) events that are programmed to communicate. If the **UL Communications Priority** option is enabled, the NT9010 system will disconnect DLS and Talk/Listen sessions on any event programmed to communicate, with the exception of Test Transmissions and System Tests.

NOTE: *Contact your local telephone company to confirm which settings should be used.*

.....

Communicator Enabled/Disabled	Section [380], Option [1]
Pulse Dialing	Section [380], Option [3]
Switch to Pulse Dial	Section [380], Option [4]
Post Dial Wait for Handshake.	Section [161]
Maximum Dialing Attempts	Section [160]
Communicator Call Direction Options	Sections [361] to [368]
Busy Tone Detection	Section [701], Option [6]
Standard/UL Communications Priority	Section [701], Option [8]
Pulse Dialing Make/Break Ratio	Section [702], Option [1]
Force Dialing	Section [702], Option [2]
ID Tone Enabled.	Section [702], Option [5]
2100Hz/1300Hz ID Tone	Section [702], Option [6]
Bell on FTC/Trouble Only	Section [702], Option [8]
Delay Between Dialing Attempts	Section [703]

.....

2.3.9 Communicator Telephone Numbers

The system can call 3 different telephone numbers for communication to central station. The **1st Telephone Number** is the primary number, the **2nd Telephone Number** is the secondary number and the **3rd Telephone Number** will back up the 1st telephone number if enabled.

You can program the 1st Telephone Number using Flash Programming, or in the Advanced Programming (section [301]). The 2nd and 3rd Telephone Numbers must be programmed in the Advanced Programming sections.

NOTE: *The 3rd telephone Number will NOT back up the 2nd telephone Number.*

If Alternate Dial is enabled the system will alternate between the 1st and 3rd telephone numbers when attempting to call the central station. If disabled the system will only attempt to call the 3rd telephone number after failing to communicate on the 1st telephone number.

NOTE: *For Alternate Dial to work properly the 3rd telephone Number must be both enabled and programmed.*

Telephone numbers can be up to 32 digits which will allow you to add special digits if required. To program the telephone number enter numbers 0 through 9 as required. The following is a list of HEX digits which can also be programmed and the function they perform:

- HEX (B) - simulates the [*] key on a Touch-Tone telephone
- HEX (C) - simulates the [#] key on a Touch-Tone telephone, or end of telephone number marker
- HEX (D) - forces the system to search for dial tone
- HEX (E) - forces the system to pause for 2 seconds
- HEX (F) - end of telephone number marker

.....

1st telephone number	Section [301]
2nd telephone number	Section [302]

3rd telephone number Section [303]
3rd telephone number enable Section [380], Option [5]
Alternate Dial Section [380], Option [6]
.....

2.3.10 Communicator Account Codes

The system Account Codes will be used by the NT9010 when communicating system events (e.g. Low Battery, Test Transmission). This account code can be up to four digits in length.

You can program two account codes: one for the first and third telephone numbers, and one code for the second telephone number. You can also program the Telephone Number 1/3 Account Code in Flash Programming (see the *Quick Set Up Guide*).

.....
Telephone Number 1/3 Account Code Section [310]
Telephone Number 2 Account Code Section [311]
.....

2.3.11 Communicator Reporting Formats

You can program the NT9010 system to report events using any one of the 5 formats available. The system can report using different formats for Telephone Numbers 1/3, and for Telephone Number 2. The following formats are supported: Pulse (20bps), Contact ID, SIA, and a Pager format. The following is a description of each.

.....
Communicator Format Options Section [350]
.....

Pulse Formats

Depending on the pulse format selected the system will communicate using the following:

- 3/1, 3/2, 4/1 or 4/2
- 1400 or 2300 Hz handshake
- 20bps
- non-extended

With the **1600Hz Handshake** option enabled, the communicator will respond to 1600Hz handshakes when using the reporting Communication Formats 01 and 02 only. When the Standard Handshake option is enabled, the communicator will respond to the handshake specified by the BPS format (1400Hz or 2300Hz).

Additional Notes on Pulse Formats

1. The digit '0' will send no pulses and is used as a filler.
2. When programming account numbers enter four digits.
3. When programming a three digit account number the fourth digit must be programmed as a plain '0' which will act as a filler digit.
4. If an account number has a '0' in it, substitute the HEX digit 'A' for the '0'.
Examples:
 - 3 digit account number [123] - program [1230]
 - 3 digit account number [502] - program [5A20]

- 4 digit account number [4079] - program [4A79]
- 5. When programming reporting codes two digits must be entered. If one digit reporting codes are to be used the second digit must be programmed as a '0'. If a '0' is to be transmitted substitute the HEX digit 'A' for the '0'. Examples:
 - 1 digit reporting code [3] - program [30]
 - 2 digit reporting code [30] - program [3A]
- 6. To prevent the system from reporting an event, program the reporting code for the event as [00] or [FF].

.....
1600Hz/Standard Handshake. Section [702], Option [4]
.....

Contact ID

Contact ID is a specialized format that will communicate information quickly using tones rather than pulses. In addition to sending information more quickly the format also allows more information to be sent. For example, rather than reporting an alarm zone 1 the Contact ID format can also report the type of alarm, such as Entry/Exit alarm zone 1.

If **Contact ID Sends Automatic Reporting Codes** is selected, the system will automatically generate a reporting code for each event. These identifiers are listed in Appendix A. If the Automatic Contact ID option is not selected, reporting codes must be programmed. The 2-digit entry determines the type of alarm. The system will automatically generate all other information, including the zone number.

NOTE: *If the Automatic Contact ID option is selected, the system will automatically generate all zone and access code numbers, eliminating the need to program these items.*

NOTE: *Regardless of the zone type programmed, the system will report all zones as burglary zones when Automatic Contact ID is selected. If you need to report other zone types, you must use Programmed Contact ID reporting codes.*

NOTE: *The zone number for Zone Low Battery and Zone Fault events will not be identified when Programmed Contact ID is used.*

If the **Contact ID uses Automatic Reporting Codes** option is enabled, the system will operate as follows:

1. If an event's reporting code is programmed as [00], the system will not attempt to call the central station.
2. If the reporting code for an event is programmed as anything from [01] to [FF], the system will automatically generate the zone or access code number. See Appendix A for a list of the codes which will be transmitted.

If the **Contact ID uses Programmed Reporting Codes** option is enabled, the system will operate as follows:

1. If an event's reporting code is programmed as [00] or [FF], the system will not attempt to call central station.
2. If the reporting code for an event is programmed as anything from [01] to [FE], the system will send the programmed reporting code.

Additional Notes on Contact ID

1. Account numbers must be four digits.
2. If the digit '0' is in the account number substitute the HEX digit 'A' for the '0'.
3. All reporting codes must be two digits.
4. If the digit '0' is in the reporting code substitute the HEX digit 'A' for the '0'.
5. To prevent the system from reporting an event program the reporting code for the event as [00] or [FF].

.....
Communicator Format Options Section [360]
Contact ID Sends Automatic Reporting Codes Section [381], Option [7]
.....

SIA (Level 2)

SIA is a specialized format that will communicate information quickly using frequency shift keying (FSK) rather than pulses. The SIA format will automatically generate the type of signal being transmitted, such as Burglary, Fire, Panic etc. The two digit reporting code is used to identify the zone or access code number.

If the SIA format is selected the system can be programmed to automatically generate all zone and access code numbers eliminating the need to program these items.

If the **SIA Sends Automatic Reporting Codes** option is enabled the system will operate as follows:

1. If the reporting code for an event is programmed as [00] the system will not attempt to call the central station.
2. If the reporting code for an event is programmed as anything from [01] to [FF] the system will AUTOMATICALLY generate the zone or access code number.
3. Bypassed zones will always be identified when partial closing of the system occurs.

The Communicator Call Direction Options can be used to disable reporting of events such as Openings/Closings. Also, if all the Opening/Closing reporting codes were programmed as [00] the system would not report.

If the **SIA Sends Automatic Reporting Codes** option is disabled the system will operate as follows:

1. If the reporting code for an event is programmed as [00] or [FF] the system will not attempt to call central station.
2. If the reporting code for an event is programmed as anything from [01] to [FE] the system will send the programmed reporting code.
3. Bypassed zones will not be identified when partial closing of the system occurs.

NOTE: *The zone number for Zone Low Battery and Zone Fault events will not be identified when Programmed SIA is used.*

.....
Communicator Format Section [360]
SIA Sends Automatic Reporting Codes Section [381], Option [3]
Communicator Call Direction Options Sections [361] to [368]
SIA Identifiers Appendix B
.....

Pager Format

The **Communicator Format** option for either telephone number can be programmed for Pager Format. If an event occurs and the **Communicator Call Direction** options direct the call to a telephone number with the Pager Format selected the system will attempt to page.

When calling a pager extra digits will be required to make it work properly.

The following is a list of Hex digits and what function they perform:

HEX (B) - simulates the [*] key on a Touch Tone telephone

HEX (C) - simulates the [#] key on a Touch Tone telephone, or end of telephone number marker

HEX (D) - forces the system to search for dial tone

HEX (E) - forces the system to pause for 2 seconds

HEX (F) - end of telephone number marker

The system will attempt to call the pager one time. After dialing the digits in the telephone number the system will send the account number and reporting code followed by the [#] key (Hex [C]).

There is no ringback when using Pager Format. The system has no way of confirming if the pager was called successfully. A failure to communicate trouble will only be generated once the maximum number of attempts has been reached.

NOTE: Do not use the digit C in a reporting code when using Pager Format. In most cases, the digit C will be interpreted as a [#], which will terminate the page before it has finished.

NOTE: If the system detects a busy signal, it will attempt to page again. It will make the maximum number of attempts programmed in section [160].

NOTE: Force dialing should be disabled when using Pager format.

NOTE: When using Pager format, you must program two pauses (hex digit E) at the end of the telephone number.

.....
 Communicator Format Options Section [360]

2.3.12 Communicator Reporting Codes

Unless you are using Automatic Contact ID or Automatic SIA formats, reporting codes must be programmed in order for the system to report events to the central station.

Reporting codes are two digits and can use hexadecimal digits A through F. To disable a reporting code, program it as "FF" (default setting) or "00". For a complete description of reporting codes which can be programmed and lists of automatic Contact ID and SIA format codes, please see **Appendix B: Reporting Codes** on page 58.

Transmission Delay

The Transmission Delay feature is used to delay reporting of alarms. When a zone is violated and causes an alarm, the **Transmission Delay Timer** will start. When the

timer expires, the system will transmit the programmed reporting code. If the system is disarmed before the timer expires, the alarm will not be transmitted.

The Transmission Delay zone attribute determines which zones will start the timer.

.....
Transmission Delay Zone Attributes Sections [101] to [132], Option [7]
Transmission Delay Timer Section [370]
.....

Low Battery Transmission Delay

When using wireless devices, the battery status of the devices will be monitored by the system. If a low battery condition exists, the system will indicate a general transmitter low battery trouble. The system will delay reporting the event for the number of days programmed as the **Low Battery Transmission Delay**. This delay provides the user with an opportunity to change the batteries on the units before the condition is reported to the central station. Instruct the customer on how to change the batteries of wireless devices to gain maximum use of this feature.

NOTE: *After the first Wireless Device Low Battery reporting code is sent, the system will not send additional low battery events until the first low battery trouble is restored.*

.....
Low Battery Transmission Delay Section [370]
.....

Cross Zone Police Code Reporting

The system will transmit the **Cross Zone Police Code** reporting code, if programmed, when two different zones are violated within the same armed-to-armed period.

.....
Cross Zone Police Code Section [328]
.....

Delinquency Reporting

The Delinquency feature is used to monitor system activity. When the **Delinquency Transmission Delay** timer expires, the system will transmit the Delinquency reporting code.

If the system is programmed to monitor **Activity Delinquency**, the timer will be programmed in hours. The timer will start under the following conditions:

- When the system is armed in the Stay mode
- When the system is disarmed
- When a zone is violated and restored while the system is disarmed/Stay armed (Interior, Interior Delay, Interior Stay/Away, or Delay Stay/Away zones only).

The activity delinquency timer will be ignored when the system is armed in the Away mode. Zones that are bypassed in the [✱][1] Bypass menu will not reset the timer.

If the system is programmed to monitor **Closing Delinquency**, the timer will be programmed in days. The timer will restart every time the system is disarmed.

.....
Activity/Closing Delinquency Section [380], Option [8]
Delinquency Transmission Delay Section [370]
.....

Zone Restorals

If the **Restoral on Bell Time-out** option is selected, the system will send the **Zone Restoral** Reporting Code for the zone if the bell cut-off time has expired *and* the zone is secured. If the zone is not secured when the bell cut-off time expires, the system will send the restoral immediately once the zone is secured, or when the system is disarmed. If the **Restoral on Bell Time-out** option is not selected, the system will immediately send the **Zone Restoral** Reporting Code when the zone is secured, regardless of whether or not the alarm output is active.

NOTE: *24 Hour type zones will report the restoral immediately when the zone is secured.*

.....
 Restoral on Bell Time-out Section [380], Option [2]
 AC Failure Communication Delay Time Section [370]

2.3.13 Talk/Listen-in Programming

NOTE: *The Event Buffer follows Swinger Shutdown option must be enabled if Talk/Listen-In is used.*

The NT9010 system has a Talk/Listen-In feature. This feature allows central station operators to listen in on what is happening on the premises, and for some events to talk to anybody present on the premises. You can program Talk/Listen-in sessions to be triggered by zone alarms, keypad-activated Auxiliary and Panic alarms, openings/closings, duress alarms, tamper alarms, or opening after alarm conditions.

For this feature to work, communications must be enabled (section [380], option [1]), and the system must be programmed to report the event. For example, if a reporting code for a zone is not programmed, an event in that zone will not initiate Talk/Listen-In session. See **2.3.12 Communicator Reporting Codes** on page 47.

You can allow or disallow talk/listen-in sessions on telephone lines 1 and 3 by changing the **Talk/Listen on Phone Lines 1/3** option. You can allow or disallow talk/listen-in sessions on telephone line 2 by changing the **Talk/Listen on Phone Line 2** option.

Zone Options

For the feature to work on a zone alarm, you must do the following:

- enroll the zone on the NT9010 (see **Chapter 1: Quick Set Up** on page 1)
- enable the talk/listen-in feature on the zone (section [802], sub-sections [50] to [53])
- program a reporting code for each zone alarm

You can have the talk/listen-in session take place on either the NT9010 control unit or the remote sounder (if installed). In the **Port Assignments** sections (section [802], sub-sections [10] to [13]), choose the unit that is closest to the zone. If you do not assign one of the units, the talk/listen-in session will not take place over both units.

NOTE: *All zones programmed as silent will not initiate a Talk/Listen-In session. Only a Listen-In session can occur.*

NOTE: If Talk/Listen-In is used in a multiple room situation, an NT9201 remote sounder is highly recommended.

Event Options

Panic key alarms will activate the Listen-In feature, if the **Panic Keys Alarm** option is enabled. Auxiliary key alarms will activate the feature if the **Auxiliary Keys Alarm** option is enabled.

Listen-in will be initiated if a Duress code is entered at a keypad and the **Duress Alarm** option is enabled.

Talk/Listen-In will be initiated when the system transmits opening and closing signals if the **Openings & Closings** option is enabled. If this option is enabled, it is recommended to enable the **Duress Alarm** option.

Talk/Listen-In will be initiated when a zone tamper condition occurs if the **Tampers Enabled** option is enabled.

Talk/Listen-In will be initiated when the system is disarmed after an alarm condition (Opening After Alarm) if the **Opening After Alarm** option is enabled.

NOTE: A Talk/Listen-In session cannot be initiated for a Fire key alarm.

The NT9010 system will end the Talk/Listen-In communication after the programmed **Audio Duration Time** expires. The central station operator can extend the on-line time by entering the extend time command. (See **Central Station Talk/Listen-In Functions** on page 50, below).

Central Station Talk/Listen-In Functions

Once the central station has established an audio link with the NT9010 system there are several commands available to the central station operator. Operators can access these commands using telephone keys [0] through [9], [#] and [*].

The central station may already be using other Talk/Listen-In equipment. Because of this the NT9010 offers flexible programming for the various commands so the central station operator can use the same commands for all equipment. Program these commands in the **Audio Control Telephone Key** programming sections. Additional commands may be programmed as **Mode Keys** which are two button entries.

The following is the list of options available:

[00] Key Not Used	[10] For Future Use
[01] Talk To All Speakers	[11] Cancel First Keypress
[02] For Future Use	[12] For Future Use
[03] Listen to All Stations	[13] Zone Select for Listen-In (input)
[04]-[06] For Future Use	[14] Increase Selected Microphone (Input)
[07] Extend Time	[15] Decrease Selected Microphone (Input)
[08] For Future Use	[16] For Future Use
[09] Terminate Call	[17] Mode Key

NOTE: All keys will also act as extend time [07] except Terminate Call [09] and Mode Key [17].

Information regarding the programming of the Command Keys must come from the central station to which you will be reporting.

Once you have talked to the central station, program the telephone keys to operate as they require.

.....

Talk/Listen-in on Phone Lines 1/3	Section [381], option [5]
Talk/Listen-in on Phone Line 2	Section [381], option [6]
Port Assignments	Sections [802]-[10] to [802]-[13]
Enable Talk/Listen-in on Zones 1-32	Sections [802]-[50] to [802]-[53]
Talk/Listen-in Event Options	Section [802]-[54]
Audio Duration	Section [802]-[55]
Telephone Key Programming	Section [802]-[40]
Telephone Mode Key Programming	Section [802]-[41]

.....

2.3.14 Downloading Downloading allows programming of the entire system via a computer, modem and telephone line. All functions and features, changes and status, such as trouble conditions and open zones can be viewed or programmed by downloading.

NOTE: *When power is applied to the system, a 6 hour downloading window will be enabled. This will allow you to perform downloading without having to do any keypad programming.*

When an event occurs that the system is programmed to communicate to the central station, the system will disconnect from the downloading computer and report the event. This will happen for all events except test transmissions.

If you enable the **Standard Communications Priority** option, the NT9010 system will only disconnect DLS and Talk/Listen sessions for alarm and Priority (FAP) events that are programmed to communicate. If the **UL Communications Priority** option is enabled, the NT9010 system will disconnect DLS and Talk/Listen sessions on any event programmed to communicate, with the exception of Test Transmissions and System Tests.

If the **Answering Machine/Double Call** option is enabled (or during the first 6 hours after power up) the system will answer incoming calls for downloading provided the following conditions occur:

1. The system hears one or two rings, then misses a ring.
2. The system starts the **Answering Machine Double Call Timer**.
3. If the system hears another ring before the timer expires, it will answer on the first ring of the second call.
4. The system will immediately go on line and begin the download process unless the **Call Back** option is enabled.
5. If Call Back is enabled, the system and computer will both hang up. The system will then call the **Download Computer Telephone Number** and wait for the computer to answer. Once the computer answers, downloading will begin.

If the **User Enabled DLS Window** option is ON, the user can activate the downloading feature for a set period of time by entering [★][6][Master Code][5].

If the **Full 6-hour User Enabled DLS Window** option is enabled, when the user opens the DLS window with [*][6][Master code][5], the DLS window will remain open for six hours. The DLS window will remain open after a successful hang-up from a downloading call. If the **One Time 1-hour User Enabled DLS Window** option is enabled, when the user opens the DLS window with [*][6][Master code][5], the DLS window will stay open for one hour, and will close after a successful hang-up from a downloading call.

Except for the first six hours after power up, the system will not answer incoming calls unless the **Answering Machine/Double Call** option is enabled, or the **Number of Rings** is programmed to be more than [0].

If the **User-Initiated Call-Up** option is enabled, the user can have the system initiate a call to the downloading computer by pressing [*][6][Master Code][6].

The **Download Access Code** and **Panel Identifier Code** are for security and proper identification. Both the system and the computer file should have the same information programmed before attempting to download.

The time to complete a successful download can be significantly reduced with the use of the PC-Link adaptor. This adaptor makes it possible to perform on-site downloading.

To perform PC-LINK please do the following:

- Set up the downloading computer close to where the NT9010 is installed.
- Remove the NT9010 from the top two latches and allow the unit to sit at a 90 degree angle to the backplate. The unit may also be completely removed from the backplate.
- Connect the PC-LINK header in the slot provided in the back of the unit.
- Ensure that the downloading computer has initiated the PC-LINK session.

To **Initiate Local Downloading via PC-Link**, enter [*] [8] [Installer’s Code] [499] [Installer’s Code] [499]. The keypad will be busy for the duration of the PC-Link connection. The status LEDs will display the current system status. For more information on connecting the PC-Link adaptor, refer to your “PC-Link Download Kit Instruction Sheet”.

.....

Answering Machine/Double Call	Section [401], Option [1]
User Enable DLS Window	Section [401], Option [2]
Call Back	Section [401], Option [3]
User-Initiated Call-up	Section [401], Option [4]
Answering Machine Double Call Timer	Section [405]
Download Computer Telephone Number	Section [402]
Download Access Code	Section [403]
Panel Identifier	Section [404]
Standard/UL Communications Priority	Section [701], Option [8]
One-time 1-hour user enabled DLS window	Section [702], Option [7]

.....

2.3.15 Telephone Line Monitoring (TLM)

When the **TLM Enable** option is selected, the system will supervise the telephone line and will indicate a trouble condition if the telephone line is disconnected.

If the TLM Enable option is ON, the system will check the telephone line every 10 seconds. If the telephone line voltage is below 3V for the number of checks programmed in the **TLM Trouble Delay** section, the system will report a TLM trouble. The default number of checks is 3. Enter a number from (000) to (255) in the TLM Trouble Delay section to change the number of checks before the TLM trouble is reported. Programming a delay means that a momentary interruption of the telephone line will not cause a trouble condition.

If the **TLM Trouble Beeps When Armed** option is enabled, the system will indicate a TLM trouble at the keypad while the system is armed. To activate the bell output in the case of a TLM trouble while the system is armed, the **TLM Audible (Bell) When Armed** option must be selected.

When the trouble condition is restored, the system can send a **TLM Restoral** reporting code. Any events which occur while the telephone line is down will also be communicated.

.....

TLM Enable/Disable	Section [015], Option [7]
TLM Trouble Beeps When Armed or TLM Audible (Bell) When Armed	Section [015], Option [8]
TLM Restoral Reporting Code	Section [350]
TLM Trouble Delay	Section [370]

.....

2.3.16 Test Transmissions

To ensure that the communication link with the central station is functioning properly, the system can be programmed to send a test transmission signal on a regular basis.

The system can send a **Periodic Test Transmission Reporting Code** at the programmed **Test Transmission Time of Day**. The **Test Transmission Cycle** determines the period of time between tests. The option **Land Line Test Transmission in Minutes/Days** allows you to select whether the Land Line Test Transmission cycle will be counted in minutes or days. If you have selected the test transmission cycle to be in minutes, the Test Transmission Time of Day counter will not apply.

NOTE: *The Test Transmission Cycle must be greater than 10 minutes. A cycle timer of less than 10 minutes will cause damage to the system.*

When the test transmission cycle is programmed, the system will send a test transmission the following day. This will indicate the beginning of the new test transmission cycle to central station.

The end user can also generate a communicator test. If the **System Test Reporting Code** is programmed, the system will send the signal when the System Test keypad command is entered (see **[*] [6] User Functions** on page 29).

.....

Test Transmission Reporting Codes	Section [352]
Test Transmission Time of Day	Section [371]
Test Transmission Cycles	Section [370]
Land Line Test Transmission in Minutes/Days	Section [702], Option [3]

.....

2.3.17 Event Buffer The system will store the last 128 events that have occurred on the system. Each event will contain the time, date, and the event itself along with the zone number, access code number or any other information pertaining to the event. If the **Event Buffer Follows Swinger Shutdown** feature is enabled the event buffer will not store events after the swinger shutdown level has been reached. This will prevent the system from overwriting the entire buffer if a problem exists (see **2.3.18 Swinger Shutdown** on page 54). The event buffer can be uploaded to a computer for viewing through the DLS software.

Event Buffer Follows Swinger Shutdown Section [013], Option [7]

2.3.18 Swinger Shutdown The swinger shutdown feature is designed to prevent a runaway communicator from tying up the central station. Different limits can be programmed for **Zone Alarms, Zone Tamper**s and **Maintenance** signals. After the system has communicated the programmed number of transmissions for an event it will no longer report that event until the swinger shutdown is reset. For example, the swinger shutdown limit for Zone Alarms is set to [003]. The system will not send more than 3 alarm signals for each zone with a swinger attribute until the swinger shutdown is reset. The Bell output will not be activated for alarms on zones that have exceeded the limit of alarms set in the Swinger Shutdown counter. **Swinger Shutdown** will be reset when the system is armed, or every day at midnight. Once reset, the system will again communicate normally.

Swinger Shutdown Limit (Alarms/Tampers/Maintenance) Section [370]

2.3.19 Timebase In cases of unstable AC power input you can use the internal crystal to keep a more accurate timebase by enabling the **Timebase is Internal Crystal** option. If the AC power input is very stable it can be used as the timebase, by enabling the **Timebase is AC line** option.

Timebase Internal Crystal/AC line Section [701]: [2]

2.3.20 Factory Default On occasion it may be necessary to return the NT9010 system to factory default settings. You can either default all the programming in the NT9010 (including device serial numbers), or you can default only certain sections of the programming.

Performing a Software Default of the NT9010 System
This procedure will return all NT9010 system programming to the factory default settings.

1. Enter [★][8][Installer's Code].
2. Enter programming section [999].
3. Enter the Installer's Code.
4. Enter programming section [999] again.

The system will take a few seconds to reset. When the keypad is operational, the default is complete.

You can also return the main controller, wireless receiver and audio interface programming to factory default settings individually. To return the main control to default settings, use section [992]. To return the wireless receiver to default settings, use section [996]. To return the voice prompt and audio interface programming to default settings, use section [995].

NOTE: *If Installer Lockout is enabled [990], the relay will click 10 times when individual defaults are performed (the section will still default).*

NOTE: *It is recommended that an NT9010 default be performed when any defaulting is required.*

.....

Restore NT9010 to default programming	Section [999]
Restore main control only to default programming	Section [992]
Restore wireless receiver only to default programming	Section [996]
Restore voice prompt and audio interface only to default programming	Section [995]

.....

Performing a Hardware Default of Main Controller

This procedure will return all NT9010 system programming to the factory default settings, except for zone serial numbers, wireless receiver, and voice prompt interface programming.

1. Remove the NT9010 unit from its backplate (see the *Quick Set Up Guide* for instructions).
2. Remove all wires from the BLACK and GREEN terminals.
3. Disconnect the battery and wait 10 seconds.
4. With a piece of wire short the BLACK terminal to the GREEN terminal.
5. Return the NT9010 to the backplate until you hear a series of beeps from the unit.
6. Remove the NT9010 from the backplate again.
7. Reconnect all original wiring and the battery then return the NT9010 to the backplate.

NOTE: *AC power must be used to power the system. The system will not default if only the battery is used.*

2.3.21 Installer Lockout

If **Installer Lockout** is selected a hardware default cannot be performed.

When **Installer Lockout Disable** is selected the system will restore all programming to factory defaults if a hardware or software default is performed.

To enable or disable Installer Lockout perform the following:

1. Enter Advanced Programming.
2. To enable Installer Lockout, enter section [990]. To disable Installer Lockout, enter section [991].
3. Enter the Installer Code.
4. Enter section [990] or [991] again.

.....
Installer Lockout Enable. Section [990]
Installer Lockout Disable Section [991]
.....

2.3.22 Walk Test

The **Installer Walk Test** can be used to test the alarm state of each zone of the system. Before beginning the walk test, ensure the following conditions are met:

1. The system is disarmed
2. The Keypad Blanking option is disabled (section [016]: [3])
3. The **Fire Bell is Continuous** option is disabled (section [014]: [8])
4. The Transmission Delay is disabled, if Transmission Delay is not required (section [370])

NOTE: *Fire Troubles are not supported in Walk Test.*

To perform a Walk Test, do the following:

1. Enter Advanced Programming
2. Enter Section [901]

When any zone is violated the system will activate the Bell Output for two seconds, log the event to the Event Buffer and communicate the alarm to the central station. Each zone should be tested several times during the test. Check the event buffer to ensure that all zones and FAP keys are functioning properly.

NOTE: *The transmission delay timer will affect the communication of events during walk test mode.*

To stop the test, you must do the following:

1. Enter Advanced Programming
2. Enter Section [901]

Zones do not have to be restored to stop the test.

NOTE: *The Alarm Memory is cleared upon entering Walk Test mode.*

Appendix A: Guidelines for Locating Smoke Detectors

Research has shown that all hostile fires in homes generate smoke to a greater or lesser extent. Experiments with typical fires in homes indicate that detectable quantities of smoke precede detectable levels of heat in most cases. For these reasons, smoke alarms should be installed outside of each sleeping area and on each story of the home.

The following information is for general guidance only and it is recommended that local fire codes and regulations be consulted when locating and installing smoke alarms.

It is recommended that additional smoke alarms beyond those required for minimum protection be installed. Additional areas that should be protected include: the basement; bedrooms, especially where smokers sleep; dining rooms; furnace and utility rooms, and any hallways not protected by the required units.

On smooth ceilings, detectors may be spaced 9.1m (30 feet) apart as a guide. Other spacing may be required depending on ceiling height, air movement, the presence of joists, uninsulated ceilings, etc. Consult National Fire Alarm Code NFPA 72, CAN/ULC-S553-M86 or other appropriate national standards for installation recommendations.

Do not locate smoke detectors at the top of peaked or gabled ceilings; the dead air space in these locations may prevent the unit from detecting smoke.

Avoid areas with turbulent air flow, such as near doors, fans or windows. Rapid air movement around the detector may prevent smoke from entering the unit.

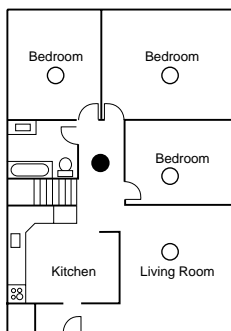

Figure 1

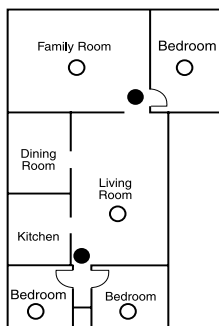

Figure 2

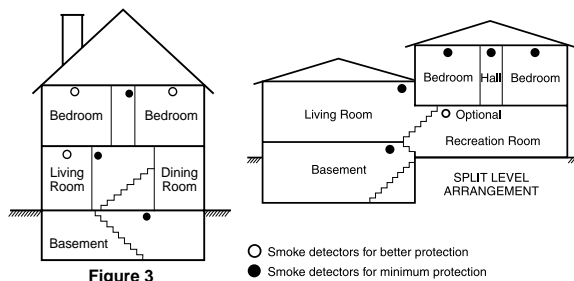

Figure 3

○ Smoke detectors for better protection
● Smoke detectors for minimum protection

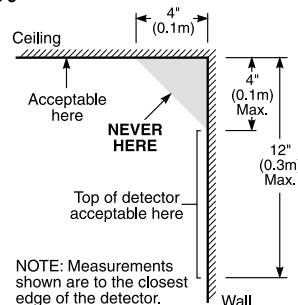

Figure 4

NOTE: Measurements shown are to the closest edge of the detector.

Do not locate detectors in areas of high humidity. Do not locate detectors in areas where the temperature rises above 38°C (100°F) or falls below 5°C (41°F). Smoke detectors should always be installed in accordance with NFPA 72, the National Fire Alarm Code. Smoke detectors should always be located in accordance with:

- Paragraph 2-2.1.1.1 of NFPA 72, Chapter 2.: "Smoke detectors shall be installed outside of each separate sleeping area in the immediate vicinity of the bedrooms and on each additional story of the family living unit, including basements and excluding crawl spaces and unfinished attics. In new construction, a smoke detector also shall be installed in each sleeping room."
- Paragraph 2-2.1.1.2 of NFPA 72, Chapter 2.: "Split level arrangement. Smoke detectors are required where shown. Smoke detectors are optional where a door is not provided between living room and recreation room."

Appendix B: Reporting Codes

The following tables contain Contact ID and Automatic SIA format reporting codes. For more information on reporting code formats and notes about individual reporting codes, see **2.3.11 Communicator Reporting Formats** on page 44 and **2.3.12 Communicator Reporting Codes** on page 47.

Contact ID

The first digit (in parentheses) will automatically be sent by the control. The second two digits are programmed to indicate specific information about the signal.

For example, if zone 1 is an entry/exit point, you could program the event code as [34]. The central station would receive the following:

*BURG - ENTRY/EXIT - 1

where the "1" indicates which zone went into alarm.

SIA Format - Level 2 (Hardcoded)

The SIA communication format used in this product follows the level 2 specifications of the SIA Digital Communication Standard - October 1997. This format will send the Account Code along with its data transmission. The transmission would look similar to the following at the receiver:

```
N Ri01      BA 01
           N   =   New Event
           Ri01 =   Area Identifier
           BA   =   Burglary Alarm
           01  =   Zone 1
```

Section #	Reporting Code	Code Sent When...	Dialer Direction*	Automatic Contact ID Codes	SIA Auto Rep Codes**
[320] to [323]	Zone Alarms	zone goes into alarm	A/R	(1) 3A	See Table 3
[324] to [327]	Zone Restorals	alarm condition has been restored	A/R	(1) 3A	
[328]	Duress Alarm	duress code entered at keypad	A/R	(1) 21	HA-00
[328]	Opening After Alarm	system disarmed with alarm in memory	A/R	(4) A6	OR-00
[328]	Recent Closing	alarm occurs within two minutes of system arming	A/R	(4) 59	CR-00
[328]	Cross Zone (Police Code) Alarm	two zones on the system go into alarm during any given armed-to-armed period (incl. 24Hr zones)	A/R	(1) 4A	BV-00
[329]	[F] Key Alarm/Rest.	Keypad fire alarm (alarm and restore reporting codes sent together)	A/R	(1) 15	FA-00/FH-00
[329]	[A] Key Alarm/Rest.	Keypad auxiliary alarm (alarm and restore reporting codes sent together)	A/R	(1) AA	MA-00/MH-00
[329]	[P] Key Alarm/Rest.	Keypad panic alarm (alarm and restore reporting codes sent together)	A/R	(1) 2A	PA-00/PH-00
[330] to [337]	Zone Tamper/Restoral	zone is tampered / tamper condition restored	T/R	(1) 44	TA-ZZ/TR-ZZ

* A/R = alarms/restorals; T/R = tampers/restorals; O/C = openings/closings; MA/R = miscellaneous alarms/restorals; T = test transmissions

** UU = user number (user01-42); ZZ = zone number (01-32)

***Program the "Fail to close" event code [(4)54] to report either closing or activity delinquency. Make sure your central station is aware of the application of this reporting code.

****Zones are identified, panic pendants, wireless keys, and handheld keypads are not.

Section #	Reporting Code	Code Sent When...	Dialer Direction n*	Automatic Contact ID Codes	SIA Auto Rep Codes**
[338]	Keypad Lockout	maximum number of incorrect access codes has been entered at a keypad	T/R	(4) 21	JA-00
[339] to [343]	Closings	system armed (user 01-34, 40-42 indicated)	O/C	(4) A2	CL-UU
[343]	Partial Closing	one or more zones bypassed when system armed	O/C	(4) 7A	CG-ZZ
[343]	Special Closing	Closing (arming) using one of the following methods: quick arm, auto arm, keyswitch, function key, maintenance code, DLS software, wireless key	O/C	(4) AA	CL-00
[344] to [348]	Openings	system disarmed (user 01-34, 40-42 indicated)	O/C	(4) A2	OP-UU
[348]	Auto Arm Cancellation	automatic arming cancelled by a user	O/C	(4) A5	CE-00
[348]	Special Opening	Opening (disarming) using one of the following methods: keyswitch, maintenance code, DLS software, wireless key	O/C	(4) AA	OP-00
[349] to [350]	Battery Trouble/Rest.	NT9010 battery is low/battery restored	MA/R	(3) A2	YT-00/YR-00
[349] to [350]	AC Line Trouble/Rest.	AC power to system is disconnected or interrupted/AC power restored (Both codes follow AC Failure Comm. Delay)	MA/R	(3) A1	AT-00/AR-00
[349] to [350]	Fire Trouble/Rest.	a trouble occurs/restores on a fire zone	MA/R	(3) 73	FT-00/FJ-00
[349] to [350]	Gen System Trouble/Rest.	"Service Required" trouble occurs (view troubles using [★][2])/trouble restored	MA/R	(3) AA	YX-00/YZ-00
[351]	Line 1 or 2 FTC Restoral	system has restored communications to central station on line 1 or 2 (after FTC)	MA/R	(3) 54	YK-00
[351]	Event Buffer is 75% Full	event buffer is almost full since last upload	MA/R	(6) 23	JL-00
[351]	DLS Lead In	downloading session start	MA/R	(4) 11	RB-00
[351]	DLS Lead Out	downloading session complete	MA/R	(4) 12	RS-00
[351]	Zone Fault/Rest.	one or more zones have faults/restored	MA/R	(3) 72	UT-ZZ/UJ-ZZ
[351]	Delinquency	programmed amount of time (days or hours) for delinquency has expired without zone activity, or without system being armed	MA/R	(4) 54***	CD-00
[353]	Wireless Device Low Battery Trouble/Rest.	wireless zones, panic pendants, handheld keypads, wireless keys have low battery/all low batteries restored	MA/R	(3) 84	XT-00/XR-00 XT-ZZ/XR-ZZ****
[352]	Periodic Test	periodic system test transmission	T	(6) A2	RP-00
[352]	System Test	[★][6] bell/communications test	T	(6) A1	RX-00

* A/R = alarms/restorals; T/R = tampers/restorals; O/C = openings/closings; MA/R = miscellaneous alarms/restorals; T = test transmissions

** UU = user number (user01-42); ZZ = zone number (01-32)

***Program the "Fail to close" event code [(4)54] to report either closing or activity delinquency. Make sure your central station is aware of the application of this reporting code.

****Zones are identified, panic pendants, wireless keys, and handheld keypads are not.

Table 2: Contact ID Zone Alarm/Restoral Event Codes (as per ADEMCO):

Program any of these codes for zone alarms/restorals when using the standard (non-automatic) Contact ID reporting format.

Medical Alarms

- (1)AA Medical
- (1)A1 Pendant Transmitter
- (1)A2 Fail to Report In

Fire Alarms

- (1)1A Fire Alarm
- (1)11 Smoke
- (1)12 Combustion
- (1)13 Water Flow
- (1)14 Heat
- (1)15 Pull Station
- (1)16 Duct
- (1)17 Flame
- (1)18 Near Alarm

Panic Alarms

- (1)2A Panic
- (1)21 Duress
- (1)22 Silent
- (1)23 Audible

Burglar Alarms

- (1)3A Burglary
- (1)31 Perimeter
- (1)32 Interior
- (1)33 24 Hour

- (1)34 Entry / Exit
- (1)35 Day / Night
- (1)36 Outdoor
- (1)37 Tamper
- (1)38 Near Alarm

General Alarms

- (1)4A General Alarm
- (1)43 Exp. module failure
- (1)44 Sensor tamper
- (1)45 Module Tamper
- (1)4A Cross Zone Police Code

24 Hour Non-Burglary

- (1)5A 24 Hour non-Burg
- (1)51 Gas detected
- (1)52 Refrigeration
- (1)53 Loss of Heat
- (1)54 Water Leakage
- (1)55 Foil Break
- (1)56 Day Trouble
- (1)57 Low bottled Gas level
- (1)58 High Temp
- (1)59 Low Temp
- (1)61 Loss of Air Flow

Table 3: SIA Format Automatic Zone Alarm/Restoral Codes

Zone Definition	SIA Auto Rep Codes*
	Zone Alm/Rest.
Delay, Instant, Interior, Delay Stay/Away, Interior Stay/Away, 24Hr Burg.	BA-ZZ/BH-ZZ
24Hr Supervisory Buzzer	UA-ZZ/UH-ZZ
24Hr Sprinkler	SA-ZZ/SH-ZZ
24Hr Gas	GA-ZZ/GH-ZZ
24Hr Heat	KA-ZZ/KH-ZZ
24Hr Medical	MA-ZZ/MH-ZZ
24Hr Emergency (non-medical)	QA-ZZ/QH-ZZ
24Hr Waterflow	WA-ZZ/WH-ZZ
24Hr Freeze	ZA-ZZ/ZH-ZZ
24Hr Holdup	HA-ZZ/HH-ZZ
24Hr Panic	PA-ZZ/PH-ZZ
Latching 24Hr	BA-ZZ/BH-ZZ
* ZZ = zones 01-32	

Appendix C: WLS925L-433 Mini Door/Window Contact Installation Instructions

Remove Cover

At the notched location on the cover, insert the flat blade of a small screwdriver between the base and the cover and twist the screwdriver to pop the cover off.

Install Battery

Use care when installing the battery and observe the correct polarity (see diagram below). Use only Eveready Lithium Energizer No. EL123AP battery.

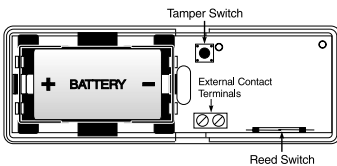

NOTE: Battery replacement must only be done by a qualified technician.

WARNING!:
Battery may explode if mistreated. Do not recharge, disassemble or dispose of in fire.

Locate Transmitter

Locate where the transmitter is to be mounted. Perform the Module Placement Test to ensure that the selected location is in range of the wireless receiver (see receiver Installation Manual for instruction).

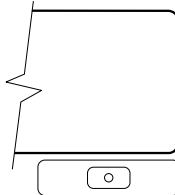

Determine where the magnet will be placed. In order to activate the reed switch, the magnet must line up with the end of the transmitter.

Remove Circuit Board

Before mounting the unit, remove the circuit board. At the notched location on the base which is on the same side as the reed switch, insert the blade of a small screwdriver between the base wall and the bottom of the circuit board and pry the circuit board up.

NOTE: Do not touch the coils on the circuit board as this may damage the unit.

Mount Transmitter and Magnet

Mount the backplate of the transmitter using the screws provided and replace the circuit board. The

head of the screw must be below the circuit board so that the sensor is not shorted out. Use flat-headed screws only.

Mount the magnet no more than ¼" (6.4mm) from the transmitter. Use the spacers provided. Once the unit and magnet are mounted, open and close the window/door to ensure that none of the parts interfere with this movement. Only one magnet can be used per transmitter.

Using External Contacts

The external contact terminals can be used to connect external contacts or other switches/devices to the universal transmitter. Install the additional device as per the manufacturer's instruction. Connect the device to the contact terminals of the WLS925L-433.

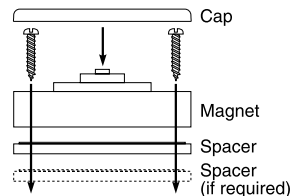

The input is normally closed and is not supervised. For UL installations, the wires connecting the external device to the input terminals must not exceed 36" (90.5 cm) in length. The contact and transmitter must also be in the same room.

For non-UL installations, the wires connecting the external device to the input terminals can be any length provided that the resistance of the wire does not exceed 100Ω.

Only one contact can be used. If an external contact is used, do not install the magnet.

Tamper Switch

There is one tamper switch on the WLS925L-433 board. Removing the cover will cause a zone tamper.

Enrolling a WLS925L-433

On the back of the door contact housing, there will be two serial numbers, a five digit and six digit. Please refer to your receiver installation manual for information on which serial number should be enrolled.

Appendix D: WLS904P Wireless Motion Detector Installation Instructions

The WLS904P is designed to combine the convenience of a wireless detector with effective and reliable detection of human motion as well as good protection against the nuisance alarms associated with pets weighing up to 60 lbs (27.3 kg)

Installing The Detector

WLS904P provides effective immunity to single or multiple pets whose total combined weight does not exceed 60 lbs. (27.3kg) when installed and configured in the following manner.

Location

Select a detector location that will provide the coverage required and will allow the detector to be mounted a minimum of 6¾ ft (1.95m) high and not higher than 10ft (3m) (7¾ ft / 2.3m recommended). Consider the following to avoid false alarms:

- Do not aim the detector at a stairwell to which a pet has access to.
- Do not place furniture or objects higher than 3ft (0.9m) which a pet can climb onto (e.g. a cat on a couch), closer than 10ft (3m) from the detector.
- Mount the detector flat on a wall or in a corner. Do not angle it downwards or use mounting brackets with this detector when it is used in conjunction with pets.
- Do not aim the detector at reflective surfaces such as mirrors or windows as this may distort the coverage pattern or reflect sunlight directly onto the detector.
- Avoid locations that are subject to direct high air flow such as near an air duct outlet.
- Do not locate the detector near sources of moisture such as steam or oil.
- Do not limit the coverage by large obstructions in the detection area such as plants or cabinets.

NOTE: No detector should be mounted without first performing a module placement test to determine that it is in range of the wireless receiver. See the Placement Test instructions in the Instruction Sheet for your receiver, or in the installation manual for your system.

When a location has been determined, remove the plastic from the mounting holes and locate the backplate on the wall and mark screw locations. It is suggested that wall anchors be used for all screw locations. Secure the backplate to the wall, and then secure the enrolled Detector to its backplate.

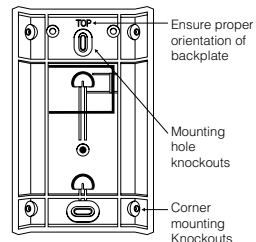

NOTE: The coils and antenna on the Motion Detector circuit board are very sensitive components precisely adjusted for maximum performance.

Do not touch the coils or antenna! Even minor distortions can affect the performance of the Motion Detector.

Enrolling a WLS904P

On the back of the PIR housing, there will be two serial numbers: a five-digit number and a six-digit number. Please refer to your receiver installation manual for information on which serial number should be enrolled.

Changing the Sensitivity Setting

The WLS904P features "Fast" and "Slow" settings on jumper J1 which is used to configure the detector for the weight of the pet(s) and the environment. For an environment with a single pet whose weight does not exceed 30lbs (13.6kg) the jumper should be set to "Fast" setting. In an environment with single or multiple pets whose combined weight is greater than 30lbs (13.6kg) but not greater than 60 lbs. (27.3kg) the jumper must be set to the "Slow" setting. In a hostile environment or where the installation conditions can not be controlled J1 must be set to the "Slow" setting.

The diagram above shows the jumper location. To change the setting from Fast to Slow, move the jumper over one pin, as shown in the diagram.

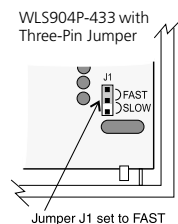

High Traffic Shutdown Mode

To prolong battery life, the motion detector uses a feature called High Traffic Shutdown. When motion is detected, the device will transmit to the receiver and will then shut down for three minutes. If motion is detected again during the shutdown time, the unit will not transmit the event to the receiver. The detector will thus remain in the shutdown mode until three minutes after the first motion detected was transmitted. The detector will transmit detected motion every three minutes.

The High Traffic Shutdown Mode affects testing the motion detector in two ways:

When performing the **module placement test**, the unit must be tampered by removing the unit from the backplate and replacing it. The placement test cannot be performed by creating motion in front of the device.

When performing a **system test**, the unit must be left idle for three minutes before testing can be performed. Once three minutes has passed, create motion in front of the detector to see if the device is both detecting motion and transmitting to the receiver.

NOTE: Refer to the *PC5132 and PC5010 Installation Instructions for UL/ULC requirements. For UL/ULC installations where the WLS904P is used on entry or exit delay zones, the entry delay must not be longer than 39 seconds, and the exit delay must not be longer than 54 seconds.*

Motion Detector Transmission Delay

A motion detector transmission is always delayed by six seconds. This is necessary to prevent false alarms caused by a motion sensor transmitting before a delay zone has a chance to report. This six-second delay cannot be altered or disabled.

Walk Test Mode

The motion detector has a walk test mode which will activate an LED for testing purposes. During normal operation, the LED will not turn on.

To put the detector in walk test mode, create a tamper by removing the detector from its backplate and then replacing it. Each time the detector senses motion, it will turn on the red LED. Five seconds after motion is detected, the detector will send a signal to the receiver, and the LED will flash rapidly 5 times. The detector will be in walk test mode until it has sent 10 transmissions.

To verify the pet immunity of the detector place the animal(s) within the coverage area and then move out of the zone. Encourage the pet to move around as it normally would and ensure that it moves across the detection pattern of the detector. Verify that no alarm is initiated.

To test for catch performance of humans, create motion in the entire area where coverage is desired by walking perpendicular to the lens pattern. Should the coverage be incomplete, readjust or relocate the detector.

NOTE: The Walk Test Mode will override the High Traffic Shutdown Mode.

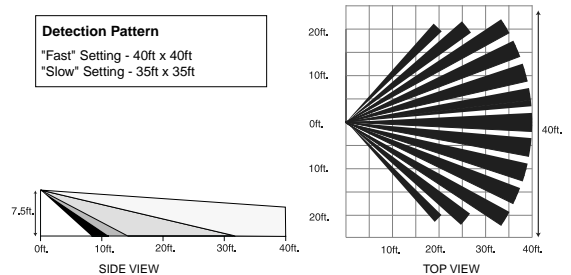

Battery Installation

- This system is designed to work with Eveready Alkaline Energizer Batteries. Do not install any other type. The reliability of the security system depends on its batteries, and "no name" or generic brand batteries may not provide the best quality and dependability.
- Use fresh batteries. Most batteries have a "best before" date printed on their packaging or on the batteries themselves. Buy batteries that have a "best before" date of two years or more from your purchase date.
- When disposing of used batteries, follow the instructions and precautions printed on the batteries. Many cities and communities have collection sites or services for used household batteries. Contact your municipal offices for information on the disposal of used batteries.

Remove the motion detector from its mounting plate by holding the sensor by its sides and pushing up. Install four fresh Eveready Alkaline Energizer AAA batteries. Be sure to insert the batteries in the proper orientation. Replace the sensor on its mounting plate, making sure it snaps into place. After all the batteries are installed, the detector will take 60 seconds to warm up. During this time the LED will flash slowly.

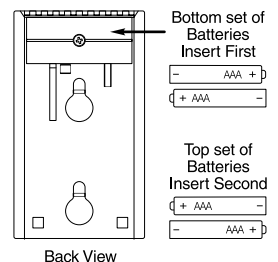

FCC COMPLIANCE STATEMENT

CAUTION: Changes or modifications not expressly approved by Digital Security Controls Ltd. could void your authority to use this equipment.

This equipment has been tested and found to comply with the limits for a Class B digital device, pursuant to Part 15 of the FCC Rules. These limits are designed to provide reasonable protection against harmful interference in a residential installation. This equipment generates, uses and can radiate radio frequency energy and, if not installed and used in accordance with the instructions, may cause harmful interference to radio communications. However, there is no guarantee that interference will not occur in a particular installation. If this equipment does cause harmful interference to radio or television reception, which can be determined by turning the equipment off and on, the user is encouraged to try to correct the interference by one or more of the following measures: Re-orient the receiving antenna.

Increase the separation between the equipment and receiver.

Connect the equipment into an outlet on a circuit different from that to which the receiver is connected.

Consult the dealer or an experienced radio/television technician for help. The user may find the following booklet prepared by the FCC useful: "How to Identify and Resolve Radio/Television Interference Problems". This booklet is available from the U.S. Government Printing Office, Washington D.C. 20402, Stock # 004-000-00345-4.

IMPORTANT INFORMATION

This equipment complies with Part 68 of the FCC Rules. On the side of this equipment is a label that contains, among other information, the FCC registration number of this equipment.

Notification to Telephone Company The customer shall notify the telephone company of the particular line to which the connection will be made, and provide the FCC registration number and the ringer equivalence of the protective circuit.

FCC Registration Number: F53CAN-34664-AL-E

Ringer Equivalence Number: 0.4B

USOC Jack: RJ-31X

Telephone Connection Requirements Except for the telephone company provided ringers, all connections to the telephone network shall be made through standard plugs and telephone company provided jacks, or equivalent, in such a manner as to allow for easy, immediate disconnection of the terminal equipment. Standard jacks shall be so arranged that, if the plug connected thereto is withdrawn, no interference to the

operation of the equipment at the customer's premises which remains connected to the telephone network shall occur by reason of such withdrawal.

Incidence of Harm Should terminal equipment or protective circuitry cause harm to the telephone network, the telephone company shall, where practicable, notify the customer that temporary disconnection of service may be required; however, where prior notice is not practicable, the telephone company may temporarily discontinue service if such action is deemed reasonable in the circumstances. In the case of such temporary discontinuance, the telephone company shall promptly notify the customer and will be given the opportunity to correct the situation.

Additional Telephone Company Information The security control panel must be properly connected to the telephone line with a USOC RJ-31X telephone jack.

The FCC prohibits customer-provided terminal equipment be connected to party lines or to be used in conjunction with coin telephone service. Interconnect rules may vary from state to state.

Changes in Telephone Company Equipment or Facilities The telephone company may make changes in its communications facilities, equipment, operations or procedures, where such actions are reasonably required and proper in its business. Should any such changes render the customer's terminal equipment incompatible with the telephone company facilities the customer shall be given adequate notice to the effect modifications to maintain uninterrupted service.

Ringer Equivalence Number (REN) The REN is useful to determine the quantity of devices that you may connect to your telephone line and still have all of those devices ring when your telephone number is called. In most, but not all areas, the sum of the RENs of all devices connected to one line should not exceed five (5.0). To be certain of the number of devices that you may connect to your line, you may want to contact your local telephone company.

Equipment Maintenance Facility If you experience trouble with this telephone equipment, please contact the facility indicated below for information on obtaining service or repairs. The telephone company may ask that you disconnect this equipment from the network until the problem has been corrected or until you are sure that the equipment is not malfunctioning.

Digital Security Controls Ltd. 160 Washburn St., Lockport, NY 14094

AVIS: L'étiquette de l'Industrie Canada identifie le matériel homologué. Cette étiquette certifie que le matériel est conforme à certaines normes de protection, d'exploitation et de sécurité des réseaux de télécommunications. Industrie Canada n'assure toutefois pas que le matériel fonctionnera à la satisfaction de l'utilisateur.

Avant d'installer ce matériel, l'utilisateur doit s'assurer qu'il est permis de le raccorder aux installations de l'entreprise locale de télécommunication. Le matériel doit également être installé en suivant une méthode acceptée de raccordement. L'abonné ne doit pas oublier qu'il est possible que la conformité aux conditions énoncées ci-dessus n'empêchent pas la dégradation du service dans certaines situations.

Les réparations de matériel homologué doivent être effectuées par un centre d'entretien canadien autorisé désigné par le fournisseur. La compagnie de télécommunications peut demander à l'utilisateur de débrancher un appareil à la suite de réparations ou de modifications effectuées par l'utilisateur ou à cause de mauvais fonctionnement.

Pour sa propre protection, l'utilisateur doit s'assurer que tous les fils de mise à la terre de la source d'énergie électrique, les lignes téléphoniques et les canalisations d'eau métalliques, s'il y en a, sont raccordés ensemble. Cette précaution est particulièrement importante dans les régions rurales.

AVERTISSEMENT: L'utilisateur ne doit pas tenter de faire ces raccordements lui-même; il doit avoir recours à un service d'inspection des installations électriques, ou à un électricien, selon le cas.

L'indice de charge (IC) assigné à chaque dispositif terminal indique, pour éviter toute surcharge, le pourcentage de la charge totale qui peut être raccordée à un circuit téléphonique bouclé utilisé par ce dispositif. La terminaison du circuit bouclé peut être constituée de n'importe quelle combinaison de dispositifs, pourvu que la somme des indices de charge de l'ensemble des dispositifs ne dépasse pas 100.

L'Indice de charge de ce produit est 0.4B.

NOTICE: The Industry Canada label identifies certified equipment. This certification means that the equipment meets certain telecommunications network protective, operational and safety requirements. Industry Canada does not guarantee the equipment will operate to the user's satisfaction.

Before installing this equipment, users should ensure that it is permissible to be connected to the facilities of the local telecommunications company. The equipment must also be installed using an acceptable method of connection. The customer should be aware that compliance with the above conditions may not prevent degradation of service in some situations.

Repairs to certified equipment should be made by an authorized Canadian maintenance facility designated by the supplier. Any repairs or alterations made by the user to this equipment, or equipment malfunctions, may give the telecommunications company cause to request the user to disconnect the equipment.

User should ensure for their own protection that the electrical ground connections of the power utility, telephone lines and internal metallic water pipe system, if present, are connected together. This precaution may be particularly important in rural areas.

CAUTION: Users should not attempt to make such connections themselves, but should contact the appropriate electric inspection authority, or electrician, as appropriate.

The Load Number (LN) assigned to each terminal device denotes the percentage of the total load to be connected to a telephone loop which is used by the device, to prevent overloading. The termination on a loop may consist of any combination of devices subject only to the requirement that the total of the Load Numbers of all the devices does not exceed 100.

The Load Number of this unit is 0.4B.



©2000 Digital Security Controls Ltd.

Toronto • Canada • www.dsc.com • 1-800-387-3630

Printed in Canada

29005094 R005