INSTRUCTION MANUAL

Axciter

Digital Modulator/Upconverter System

AXCERA, LLC

103 FREEDOM DRIVE P.O. BOX 525 LAWRENCE, PA 15055-0525 USA
(724) 873-8100 • FAX (724) 873-8105
www.axcera.com • info@axcera.com



CHAPTER 1: INTRODUCTION.....	1
MANUAL OVERVIEW	1
AXCITER OVERVIEW	1
SAFETY.....	2
<i>Read All Instructions</i>	2
<i>Retain Manuals</i>	2
<i>Heed Notes, Warnings, and Cautions</i>	2
<i>Follow Instructions</i>	2
<i>Cleaning</i>	2
<i>Ventilation</i>	2
<i>Replacement Parts</i>	3
RETURN MATERIAL PROCEDURE.....	3
WARRANTY FOR BROADCAST PRODUCTS.....	4
<i>Limited One-year Warranty</i>	4
CHAPTER 2: INSTALLATION AND OPERATING INSTRUCTIONS	5
INSTALLATION.....	5
SETUP AND OPERATION PROCEDURES	10
MODULATOR OPERATIONAL OVERVIEW	10
USER INTERFACE.....	11
<i>Navigating the User Interface</i>	11
<i>User Interface Conventions</i>	13
SCREEN DISPLAYS AND DETAILS.....	15
<i>Axciter Main Screen</i>	15
<i>Control and Status Screen</i>	16
<i>Signals Status Screen</i>	17
<i>Channel Offset Example</i>	18
<i>AXACT Equalizers</i>	19
<i>Clock and Power Status Screen</i>	21
<i>LED Status Screen</i>	22
<i>History</i>	24
DTVISION LINEAR - OPTIONAL	25
<i>DTVision Linear Home/ Spectrum Screen</i>	26
<i>DTVision Constellation Screen</i>	27
<i>DTVision Eye Screen</i>	28
<i>Linear Equalizer Graph</i>	29
<i>Linear Quad Display Screen</i>	30
DTVISION NON-LINEAR - OPTIONAL	31
<i>DTVision Non-Linear Home/Spectrum Screen</i>	32
<i>DTVision Peak to Average Screen</i>	33
<i>Nonlinear Phase Amplitude Display</i>	34
<i>Nonlinear Equalizer Display</i>	35
<i>Nonlinear Quad Display Screen</i>	36
<i>Upconverter Screen</i>	37
<i>Setup Screen</i>	39
CHAPTER 3: UPCONVERTER/DOWNCONVERTER TRAY OR MODULE ASSEMBLIES	42
UPCONVERTER/DOWNCONVERTER TRAY AND MODULES OVERVIEW	42
UPCONVERTER/DOWNCONVERTER BOARD DESCRIPTIONS.....	43
<i>Final Conversion Board, Axciter (1307263)</i>	43
<i>L-Band PLL Board, Axciter (1307206)</i>	43
<i>First Conversion Board, Axciter (1306759)</i>	44
<i>AGC Control Board, Axciter (1307366)</i>	44
<i>Downconverter Board, Axciter (1306807)</i>	46

CHAPTER 4: AXCITER MODULATOR AND TRANSMITTER SET UP PROCEDURES	47
AXCITER ALIGNMENT OVERVIEW	47
TRANSMITTER SET UP PROCEDURES	47
SYSTEM PREPARATION	47
INITIAL TEST SET UP	47
SETTING UP THE OUTPUT POWER OF THE TRANSMITTER IN SLED-BASED SYSTEM	48
<i>SETTING UP OF AGC 1</i>	48
<i>SETTING UP OF AGC 2</i>	48
<i>SETTING UP OF OVERDRIVE THRESHOLD</i>	48
(K2) AXCITER PRE AND POST FILTER SAMPLE VALUES	49
<i>UPCONVERTER DOWN CONVERTER ADJUSTMENT</i>	49
SYSTEM CALIBRATION OF FORWARD AND REFLECTED POWERS USING THE HX OR LX DRIVER/AMPLIFIER, IN SLED-BASED SYSTEMS	49
<i>FORWARD POWER CALIBRATION</i>	49
<i>REFLECTED POWER CALIBRATION</i>	50
CHAPTER 5: MAINTENANCE.....	51
MAINTENANCE	51
APPENDIX A: SYSTEM & MODULATOR DRAWINGS.....	A-1
APPENDIX B: UPCONVERTER/DOWNCONVERTER TRAY DRAWINGS (USED WITH VISIONARY IOT TRANSMITTERS)	B-1
APPENDIX C: UPCONVERTER AND DOWNCONVERTER MODULE ASSEMBLY DRAWINGS (USED WITH INNOVATOR LX & HX SERIES TRANSMITTERS)	C-1
APPENDIX D: GLOSSARY OF TERMS.....	D-1

Chapter 1: Introduction

This manual explains the installation, setup, operation, alignment and maintenance for the Axciter 8VSB digital television modulator. It is intended that persons installing, operating, or maintaining the Axciter read this manual for important safety and operational instructions.

Manual Overview

This instruction manual is divided in 5 chapters and four supporting appendices. **Chapter 1**, Introduction, contains information on safety, general maintenance, product return procedures, and warranties. **Chapter 2**, Installation and Operating Instructions, describes the system installation and setup of the Axciter. **Chapter 3**, Detailed Alignment, contains alignment instructions for each circuit card that contains alignment controls. **Chapter 4**, Upconverter/Downconverter Tray or Module Assemblies, contains descriptions of the tray and module assemblies and the boards and subassemblies that make up the tray and module assemblies. **Chapter 5**, Maintenance, contains maintenance instructions. **Appendix A**, System & Modulator Drawings, contains the System Drawings for both the stand alone and the sled based Axciter systems. **Appendix B**, Upconverter/Downconverter Tray Drawings, contains the tray interconnect, board schematics and assembly drawings. **Appendix C**, Upconverter and Downconverter Module Assembly Drawings, contains the interconnects of the module assemblies, and the schematics and assembly drawings of the boards that make up the module assemblies. **Appendix D** contains a glossary of acronyms that is provided for reference.

Axciter Overview

The Axciter represents the most up-to-date technology available in digital television (DTV) modulators. The Axciter DTV exciter was designed to address many of the problems facing digital television transmitter engineers. The Axciter accepts SMPTE-310M encoded digital video and performs all processing necessary to create an ATSC compatible RF output. The exciter is equipped with high speed digital signal processing systems that monitor not only the incoming digital video signal but the transmitted signal as well. Critical information about the incoming digital video is provided to aid in trouble-shooting the digital video chain leading up to the exciter. On the output side, the Axciter monitors the RF output of the transmitter power amplifier and automatically computes precorrection information that is used to produce the highest quality over-the-air 8VSB signal possible. This system is called Adaptive Digital Equalization and throughout this manual is referred to as simply ADE. Optional software called DTVision™ is available for viewing the performance of the adaptive system directly on the self-contained color LCD of the Axciter.

While the Axciter performs all of these tasks automatically it is important to understand how the Axciter operates. There are no controls inside the Axciter due to its digital nature and it is quite likely that the transmitter engineer will never have to even open the cover. Even so there are several selections and options that must be made from the front panel of the

Axciter. It is important to know what these selections do and when they should be used. The Axciter is designed to work over a wide range of transmitter types and field conditions. There are certain front panel settings that if improperly selected could cause undesired results. Please pay particular attention to any warnings or notes in this manual about various selections to make sure that your transmitter is always operating at its peak performance.

Safety

The digital modulators manufactured by Axcera are designed to be easy to use and repair while providing protection from electrical and mechanical hazards. Listed throughout the manual are notes, cautions, and warnings concerning possible safety hazards that may be encountered while operating or servicing the system. Please review these warnings and familiarize yourself with the operation and servicing procedures before working on the system.

Read All Instructions

All of the operating and safety instructions should be read and understood before operating this equipment.

Retain Manuals

The manuals for the system should be retained at the transmitter site for future reference. We provide two sets of manuals for this purpose; one set can be left at the office while one set can be kept at the site.

Heed Notes, Warnings, and Cautions

All of the notes, warnings, and cautions listed in this safety section and throughout the manual must be followed for your safety and optimum performance of this equipment.

Follow Instructions

All of the operating and use instructions for the system should be followed.

Cleaning

Unplug or otherwise disconnect power from the equipment before cleaning. Do not use liquid or aerosol cleaners. Use a damp cloth for cleaning.

Ventilation

Openings in the back of the cabinet and tray front panel are provided for ventilation. There is a small fan mounted near the rear of the Axciter to pull cool air into the cabinet. To ensure reliable operation, and to protect the unit from overheating, these openings must not be blocked. Pay particular attention to the ventilation holes in the bottom of the Axciter front panel. These holes are placed in locations necessary to affect proper cooling of the high-speed digital circuits. They should not be blocked by equipment placed directly below the Axciter. **NOTE:** *Never operate the Axciter for extended periods of time with the top cover removed. The top cover is an integral component of the overall cooling system. If it is*

removed then the airflow will be altered such that some circuits do not receive proper cooling.

Servicing

Do not attempt to service this product yourself until becoming familiar with the equipment. If in doubt, refer all servicing questions to qualified Axcera service personnel.

Replacement Parts

When replacement parts are used, be sure that the parts have the same functional and performance characteristics as the original part. Unauthorized substitutions may result in fire, electric shock, or other hazards as well as improper operation. Please contact the Axcera Technical Service Department if you have any questions regarding service or replacement parts.

Return Material Procedure

To insure the efficient handling of equipment or components that have been returned for repair, Axcera requests that each returned item be accompanied by a Material Return Authorization Number (RMA#).

An RMA# can be obtained from any Axcera Field Service Engineer by calling the Axcera Field Service Department, at 1-724-873-8100. This procedure applies to all items sent to the Field Service Department regardless of whether the item was originally manufactured by Axcera.

NOTE: *To prevent damage to the product during shipping, Axcera will supply a shipping container to the customer, upon request, at no cost.*

When equipment is sent to the field on loan, an RMA# is included with the unit. The RMA# is intended to be used for the return of the unit to Axcera. In addition, all shipping material should be retained for the return of the unit to Axcera. Replacement assemblies are also sent with an RMA# to allow for the proper routing of the exchanged hardware. Failure to close out this type of RMA# will normally result in the customer being invoiced for the value of the loaner item or the exchange assembly.

When shipping an item to Axcera, please include the RMA# on the packing list and on the outside of the shipping container. The packing slip should also include contact information and a brief description of why the unit is being returned.

Please forward all RMA items to:

Axcera, LLC
103 Freedom Drive
P.O. Box 525
Lawrence, PA 15055-0525 USA

For more information concerning this procedure, call the Axcera Field Service Department, at 1-724-873-8100 or by fax at 1-724-873-8105.

Axcera can also be contacted through e-mail at info@Axcera.com and on the Web at www.Axcera.com

Warranty for Broadcast Products

Limited One-year Warranty

Axcera warrants each new product that it has manufactured and sold against defects in material and workmanship under normal use and service for a period of one (1) year from the date of shipment from Axcera's plant, when operated in accordance with Axcera's operating instructions. This warranty shall not apply to tubes, fuses, batteries, or bulbs.

Warranties are valid only when and if (a) Axcera receives prompt written notice of breach within the period of warranty, (b) the defective product is properly packed and returned by the buyer (transportation and insurance prepaid), and (c) Axcera determines, in its sole judgment, that the product is defective and not subject to any misuse, negligence, improper installation, accident, or (unless authorized in writing by Axcera) repair or alteration. Axcera's exclusive liability for any personal and/or property damage (including direct, consequential, or incidental) caused by the breach of any or all warranties, shall be limited to the following: (a) repairing or replacing (in Axcera's sole discretion) any defective parts free of charge (F.O.B. Axcera's plant) and/or (b) crediting (in Axcera's sole discretion) all or a portion of the purchase price to the buyer.

Equipment furnished by Axcera, but not bearing its trade name, shall bear no warranties other than the special hours-of-use or other warranties extended by or enforceable against the manufacturer at the time of delivery to the buyer.

NO WARRANTIES, WHETHER STATUTORY, EXPRESSED, OR IMPLIED, AND NO WARRANTIES OF MERCHANTABILITY, FITNESS FOR ANY PARTICULAR PURPOSE, OR FREEDOM FROM INFRINGEMENT, OR THE LIKE, OTHER THAN AS SPECIFIED IN PATENT LIABILITY ARTICLES, AND IN THIS ARTICLE, SHALL APPLY TO THE EQUIPMENT FURNISHED HEREUNDER.

Chapter 2: Installation and Operating Instructions

This section provides information on how to install and set up the Axciter exciter system.

Installation

To install the Axciter stand alone tray system: If the trays are not pre-installed in a cabinet, follow the steps below.

1. Remove the modulator tray and upconverter/downconverter tray from the shipping boxes and inspect them for any damage that may have occurred during shipment. Remove all packing material used in shipment.
2. Install the tray slides that have been provided for the modulator and the upconverter/downconverter trays into a standard 19" rack or cabinet with the upconverter/downconverter tray slides located in a convenient position, close to the Axciter. Slide the Axciter modulator into the cabinet and adjust or align the tray so that it slides in and out easily without interfering with cabling or other pieces of equipment. Slide the upconverter/downconverter tray into the cabinet and adjust or align the tray so that it slides in and out easily without interfering with cabling or other pieces of equipment.

Note: Refer to Figures 2-4, 2-5 & 2-6 for the location of the rear panel connections.

3. Connect the AC power cord, provided in the installation kit, to the AC input jack, located on the rear of the Axciter modulator. Do not plug the AC power cord into a source of power, at this time.
4. Connect another AC power cord to the IEC connector AC input jack, located on the rear of the upconverter/downconverter. Do not plug the AC power cord into a source of power, at this time.

To install the Axciter sled based system: If the tray and sleds are not pre-installed in a cabinet and the chassis assembly, follow the steps below.

1. Remove the modulator tray and the upconverter and downconverter sleds from the shipping boxes and inspect them for any damage that may have occurred during shipment. Remove all packing material used in shipment.
2. Install the tray slides that have been provided for the modulator into a standard 19" rack or cabinet. Slide the Axciter modulator into the cabinet and adjust or align the tray so that it slides in and out easily without interfering with cabling or other pieces of equipment. Slide the Downconverter Sled and the Upconverter Sled into chassis assembly, as shown below.

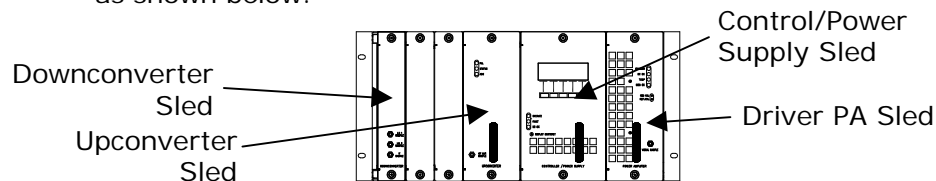

Figure 2-1: HX or LX Driver/Amplifier Chassis Assembly, Front View

3. Connect the AC power cord, provided in the installation kit, to the AC input jack, located on the rear of the Exciter modulator. Do not plug the AC power cord into a source of power, at this time.

The following steps apply to the Exciter tray-based or sled-based system.

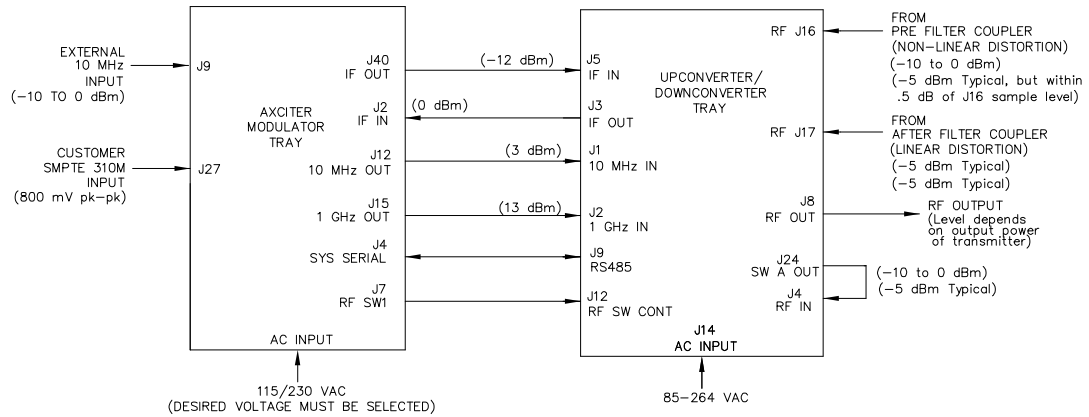

Figure 2- 2: Block Diagram Exciter tray-based system

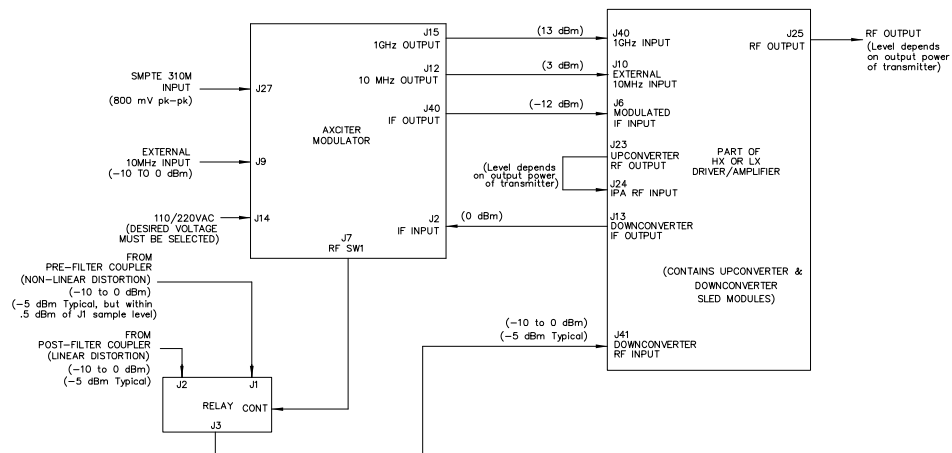

Figure 2-3: Block Diagram Exciter sled-based system

1. Using the supplied cables and any other cables needed, make the necessary interconnections between the Exciter modulator tray and the upconverter/downconverter tray, in a tray-based system or the driver/amplifier chassis assembly, in a sled-based system. Refer to Figures 2-4, 2-5 & 2-6, the information in Tables 2-1, 2-2, 2-3 & 2-4 and the preceding block diagrams to aid in the reconnection of the system.
2. The required external interconnections are detailed in Table 2-3. Connect the SMPTE 310M signal source to the J27 or J23 input as selected on the front panel of the Exciter modulator tray. This connection applies to both the tray-based and sled-based systems
3. Connect the RF output of the upconverter/downconverter tray at J8 to the driver or IPA of the transmitter, in a tray-based system. In a sled-based system, connect the RF output of the driver/amplifier chassis assembly at J25 to the driver or IPA of the transmitter

4. There is a SPDT RF relay, mounted in the upconverter/ downconverter tray, in a tray-based system or externally in a sled-based system, which selects an RF sample from one of two places. The samples are from either before the transmitter output channel mask filter, Non-Linear Distortion, or after it, Linear Distortion. These samples are used in the adaptive equalization process. Connect one 500 coax cable from the directional coupler installed before the channel mask filter to the normally open position of the RF relay at J17 on the rear of the upconverter tray or to J1 on the external relay. Connect another 500 coax cable from the directional coupler installed after the channel filter to the normally closed input on the RF relay at J16 on the rear of the upconverter tray or to J2 on the external relay. In a tray-based system, connect a 500 coaxial jumper cable from the common connection of the relay at J24 to the sample RF input jack at J4 on the rear of the upconverter tray. In a sled-based system, connect a 500 coaxial jumper cable from the common connection of the external relay at J3 to the downconverter sample RF input jack at J41 on the rear of the driver/amplifier assembly. The relay, mounted in the upconverter or external, will select between the two samples under software control from the Axciter Modulator tray.
5. Optional connections. There are several optional connections, detailed in table 2-4. An external 10 MHz reference input can connect to J9. An active loop-thru (that is, regenerated and reclocked) SMPTE 310 signal is available at the SMPTE 310 output located on the rear panel.
6. Ethernet connection. J1 on the rear of the Axciter modulator provides an Ethernet connection that is used for troubleshooting.

Axciter Modulator, Upconverter/Downconverter & Driver/Amplifier Rear Panels

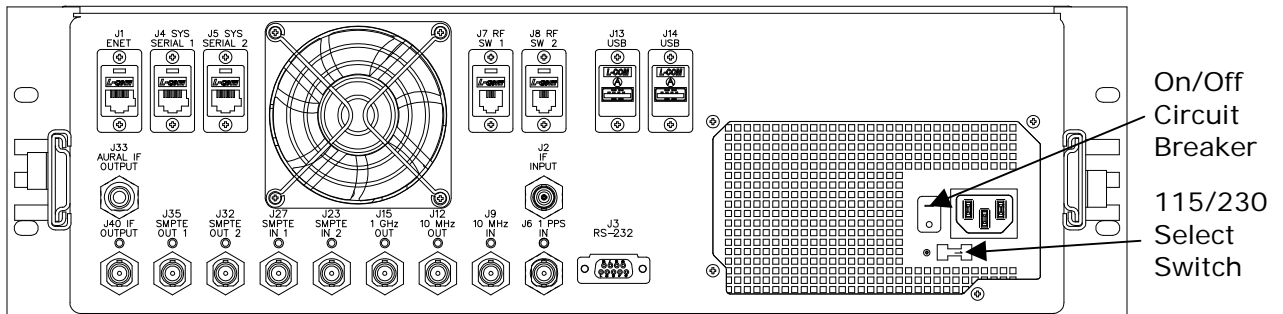

Figure 2-4: Axciter Modulator Tray, Rear View

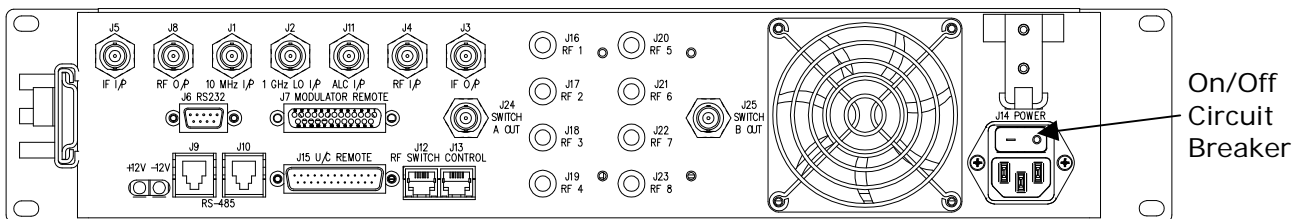

Figure 2-5: Upconverter/Downconverter Tray, Rear View

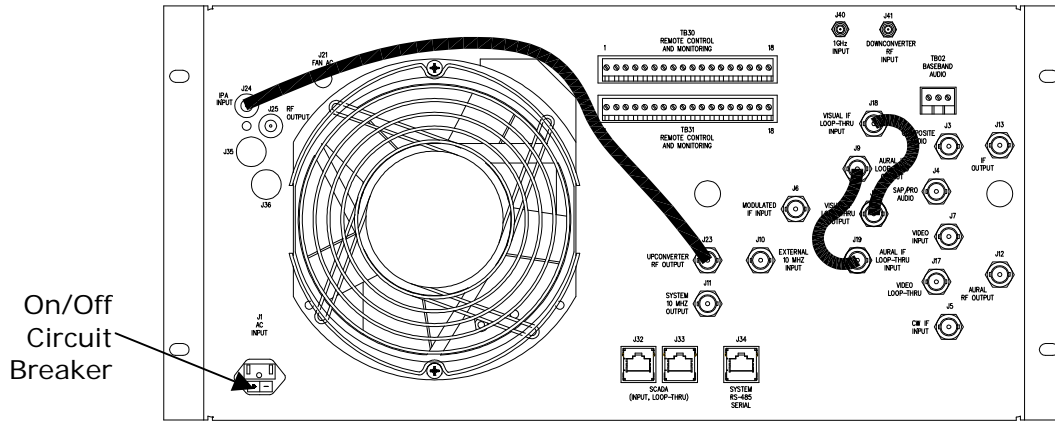

Figure 2-6: HX or LX Driver/Amplifier Chassis Assembly, Rear View

Table 2-1. Interconnections between modulator and upconverter (Tray Based System)

MODULATOR TRAY	UPCONVERTER TRAY	LEVEL	CONNECTOR
(J2) IF input	(J3) IF output	0 dBm	50Ω BNC
(J4) RS-485 serial 1 data	(J9) RS-485 serial data	N/A	RJ-45
(J7) RF SW1 output	(J12) RF SW CONT input	N/A	RJ-12
(J12) 10 MHz output	(J1) 10 MHz input	3 dBm	50Ω BNC
(J15) 1GHz output	(J2) 1GHz LO input	13 dBm	50Ω BNC
(J40) IF output	(J5) IF input	-12 dBm	50Ω BNC

Table 2-2. Interconnections between modulator and driver/amplifier (Sled Based System)

MODULATOR TRAY	DRIVER/AMPLIFIER	LEVEL	CONNECTOR
(J2) IF input	(J13) IF output	0 dBm	50Ω BNC
(J7) RF SW1 output		N/A	RJ-12
(J12) 10 MHz output	(J10) 10 MHz input	3 dBm	50Ω BNC
(J15) 1GHz output	(J40) 1GHz LO input	13 dBm	50Ω BNC
(J40) IF output	(J6) Modulated IF input	-12 dBm	50Ω BNC

Table 2-3. Connections between modulator, upconverter, and external equipment (Tray Based System)

MODULATOR TRAY	UPCONVERTER TRAY	LEVEL	CONNECTOR
(J27) SMPTE 310 input #1		N/A	75Ω BNC
	(J4) RF input (Normally jumpered to J24)	-5 dBm Typical	50Ω BNC
	(J8) RF output	Level depends on transmitter output power	50Ω BNC

MODULATOR TRAY	UPCONVERTER TRAY	LEVEL	CONNECTOR
	(J16) Post-Filter sample input (Linear Distortion)	-10 to 0 dBm (-5 dBm Typical)	50Ω BNC
	(J17) Pre-Filter sample input (Non-Linear Distortion)	-10 to 0 dBm (-5 dBm Typical but within .5 dB of J6 sample level)	50Ω BNC
	(J24) SW A output (Normally jumpered to J4)	N/A	50Ω BNC

Table 2-4. Optional Connections to Axciter Modulator (Tray or Sled Based System)

MODULATOR	NOTES
(J1) Ethernet input	RJ-45 connector
(J3) RS-232 input	DE-9 connector
(J5) RS-485 serial 2 data	RJ-45 connector
(J6) 1 PPS external reference input	50Ω or 1kΩ BNC connection selectable on screen
(J13 & J14) USB inputs	USB connectors
(J8) RF SW 2 input	RJ-12 connector
(J9) 10 MHz external reference input	50Ω BNC connection
(J23) SMPTE 310 input #2	75Ω BNC connection
(J33) Aural IF output	50Ω BNC connection
(J35) SMPTE 310 Serial #1 active output	75Ω BNC connection
(J32) SMPTE 310 Serial #2 active output	75Ω BNC connection

Power Supply Voltage

The power supply mounted in the Axciter modulator tray is capable of operating using either 115 or 230 volts, by moving a switch, located below the AC input jack located on the rear of the tray. The power supplies used in the Axciter upconverter/downconverter tray, in the tray based system, is of a type that requires no switching or jumper selection for operation from 115 or 320 volts. The power supply will operate correctly with any voltage from 85-264 volts AC, 47-440 Hz.

Note: There is an on/off circuit breaker located on the rear of the Axciter modulator tray, the upconverter/downconverter tray and the driver/amplifier chassis assembly, near the AC input plug. If the trays do not power up, check that the on/off circuit breakers are on.

This completes the installation procedure for the Axciter tray-based and sled-based systems.

Setup and Operation Procedures

The initial setup and operation of the ATSC modulator should be performed after the unit has been connected to an external SMPTE 310M source and the Axciter modulator has been connected to the upconverter or to the driver/amplifier chassis. Also check that the output of the upconverter or the driver/amplifier is connected to the transmitter and that the pre-filter and post-filter sample inputs from the transmitter are connected to the upconverter or the relay as detailed in Tables 2-1, 2-2, 2-3, & 2-4. A detailed description of the operational modes, menus, and setup of the Axciter modulator can be found in rest of Chapter 2 of this manual. A description of the upconverter/ downconverter tray and sled-based upconverter and downconverter modules can be found in Chapter 3.

Modulator Operational Overview

The Axciter 8-VSB modulator accepts an ATSC transport stream in SMPTE 310M Format input and outputs an 8-VSB IF signal centered at 44 MHz.

The 44 MHz IF signal is upconverted to the desired channel by the upconverter located in the upconverter tray or, in a sled-based system, as an upconverter sled mounted in the driver/amplifier chassis assembly.

The signal generation function of the Axciter is also referred to as the "forward signal path" in this manual. There is also a "reverse signal path" that is used for automatic adaptive equalization.

Two transmitter output samples are taken from directional couplers located before and after the channel mask filter and are applied to the upconverter tray or the external Relay. The upconverter tray also contains a downconverter that converts the RF sample to an IF output. In a sled-based system, the downconverter sled is mounted in the driver/amplifier chassis assembly.

The downconverted IF transmitter sample is digitized by the Axciter modulator. It is then demodulated in non-real time software. The result is analyzed to calculate linear and nonlinear adaptive equalizers to improve the transmitted signal quality by compensating for the nonlinear compression of the power amplifier, and the linear distortions (mostly group delay effects) of the channel filter.

When a linear adaptive equalizer is being calculated, the transmitter sample is taken after the channel mask filter so that its linear distortions can be "seen."

When a nonlinear adaptive equalizer is being calculated, the transmitter sample is taken before the channel mask filter, so that the distortion sidebands being generated by the power amplifier can be seen (the channel filter would remove the out-of-band sidebands).

The Axciter modulator contains a standard Personal Computer. The PC performs user interface functions and the numerical processing necessary for the adaptive linear and nonlinear equalization. The PC is not in the forward signal path; if it fails the exciter will continue to generate a signal with the most recently calculated equalization.

SMPTE 310 Connection

The SMPTE 310 input receives a serial ATSC bitstream at a data rate of 19.392658 megabits per second. Line code is biphase mark. Signal amplitude should be 800 millivolts peak to peak when terminated in a 75 ohm load.

The SMPTE 310 signal is internally regenerated and reclocked by the Axciter modulator, and is available for testing or other uses at the connectors on the rear panel.

IF Output Connection

The IF output is available on the rear connector labeled IF OUT. A sample of the IF can be made available on the front panel. This sample should only be used for test purposes and not for the primary IF output.

10 MHz Reference Connection

The modulator allows for the use of a 10 MHz external reference. If precise frequency control is required, an external 10 MHz reference from a highly stable source (such as a rubidium standard or GPS) may be applied to the Axciter. With the external 10 MHz present, the internal 10 MHz OCXO is phase locked to the high accuracy external reference.

1 PPS Reference Connection

Used for Single Frequency Network applications only.

Rear Panel LEDs

The rear panel of the modulator has an LED next to each coaxial connector. During operation, a green LED next to the connector means that the signal is present. A red LED means that the signal is absent or in a fault condition. A dark LED means that the signal is not being used.

Graphical User Interface

The front panel of the modulator includes a color LCD that shows a wide range of information about the operation of the Axciter modulator and the upconverter. Details in the next section.

User Interface

This section describes the user interface, which is implemented as a graphical set of screens following a menu structure. These screens are displayed on the LCD screen on the front panel of the Axciter.

Topics include:

- Navigating the user interface
- Screen Displays and Details
- User Interface Conventions

Navigating the User Interface

Each screen can contain a number of soft buttons, fields, graphs, and values. The soft buttons along the right side of the screen display the function of the corresponding adjacent front panel buttons. (NOTE: It is not a touch screen). The primary function for these soft buttons is navigation between screens.

The Color of values and fields indicate status. Graphs are used to display DTVision analysis.

The top level menu structure has 5 options:

1. Control/Status
2. DTVision Linear (if installed)
3. DTVision Nonlinear (if installed)
4. Upconverter
5. Setup

Example of screen is shown below.

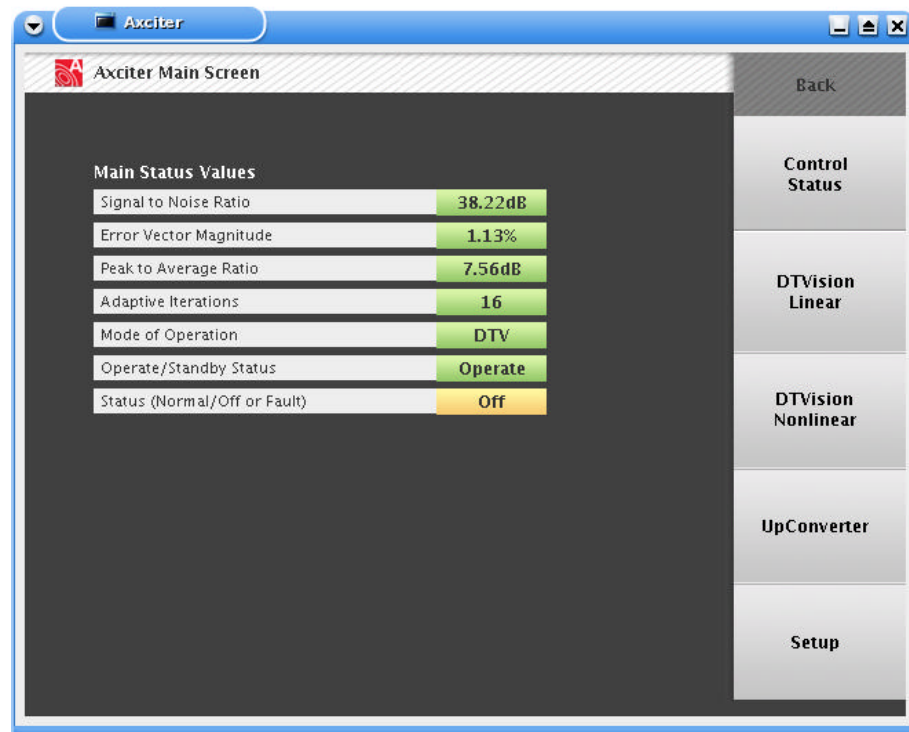

Screens for Control/Status

Access the Control/Status screens by pressing the top soft button from the main screen. Control/Status screens are listed in Table 2-4.

Table 2-4. Screens for Control/Status

SCREEN	DESCRIPTION
Control/Status	Provides a navigation home point for the control/status.
Signals	See page 14 for more information.
Power/Clocks	See page 14 for more information.
Axact Equalizers	See page 16 for more information.
LEDs	See page 19 for more information.
History	See page 21 for more information.

Screens for DTVision Linear

Access the DTVision Linear screens by pressing the second soft button on the Main Status screen. DTVision Linear screens are listed in Table 2-5.

Table 2-5. ATSC Screens

SCREEN	DESCRIPTION
DTVision Linear Home (Spectrum)	See page 22 for more information.
DTVision Const	See page 24 for more information.
DTVision Eye	See page 25 for more information.
DTVision Linear Equalizer	See page 26 for more information.
DTVision Linear Quad	See page 27 for more information.

Screens for DTVision Non-Linear

Access the DTVision Linear screens by pressing the second soft button on the Main Status screen. DTVision Linear screens are listed in Table 2-5.

Table 2-5. ATSC Screens

SCREEN	DESCRIPTION
DTVision Non-Linear Home (Spectrum)	See page 29 for more information.
DTVision Peak Avg	See page 30 for more information.
DTVision Phase Amp	See page 31 for more information.
DTVision Non-Linear Equalizer	See page 32 for more information.
DTVision Non-Linear Quad	See page 33 for more information.

User Interface Conventions

Screens consist of fields, graphs, values and buttons. Fields provide either status information and values or allow the user to change the values. The graphs provide a visual display of the system status and allow analysis. The colored value fields provide status information at a glance.

Soft buttons on the right side of the screen allow navigation. Each soft button corresponds to a menu item on the screen. The Home button will take the user back to the Main Status Screen. The Back button will take the user back to the last screen they were on.

To change values, users must use the keypad to the right of the soft buttons.

Fields**Buttons on the Screen***Buttons on the Front Panel*

Home	When Home is pressed, you are taken back to the home screen.
Back	Back is used to return to the previous screen.
Help	When the help button is pressed, the help screen relevant to the screen you were on at the time you pressed 'Help' is presented.
Show/hide menu	Pressing the show/hide menu button toggles the display of the 5 navigation buttons on the right side of the screen.
Soft Buttons 1-5	These 5 buttons perform the functions or navigation described by the corresponding graphics adjacent to the buttons on the right edge of the LCD screen.
Keypad	The numeric keypad is used for entering values in the control screen fields.

Keyboard Control:

A USB keyboard attached to the front panel will allow a user familiar with Linux to login into a console and check the status of the Axciter.

Special Keyboard Functions:

- Home: takes user to the root screen, General Status Screen.
- Back: ends the help screen and takes user back to previous screen.

Table 2-6. Key Map

KEY	FRONT PANEL BUTTON
Alt F2	GUI interface
Alt F6	Linux Console
F1	Help

Other Interface Options

The user interface supports operation via the front panel mouse.

Screen Displays and Details

Axciter Main Screen

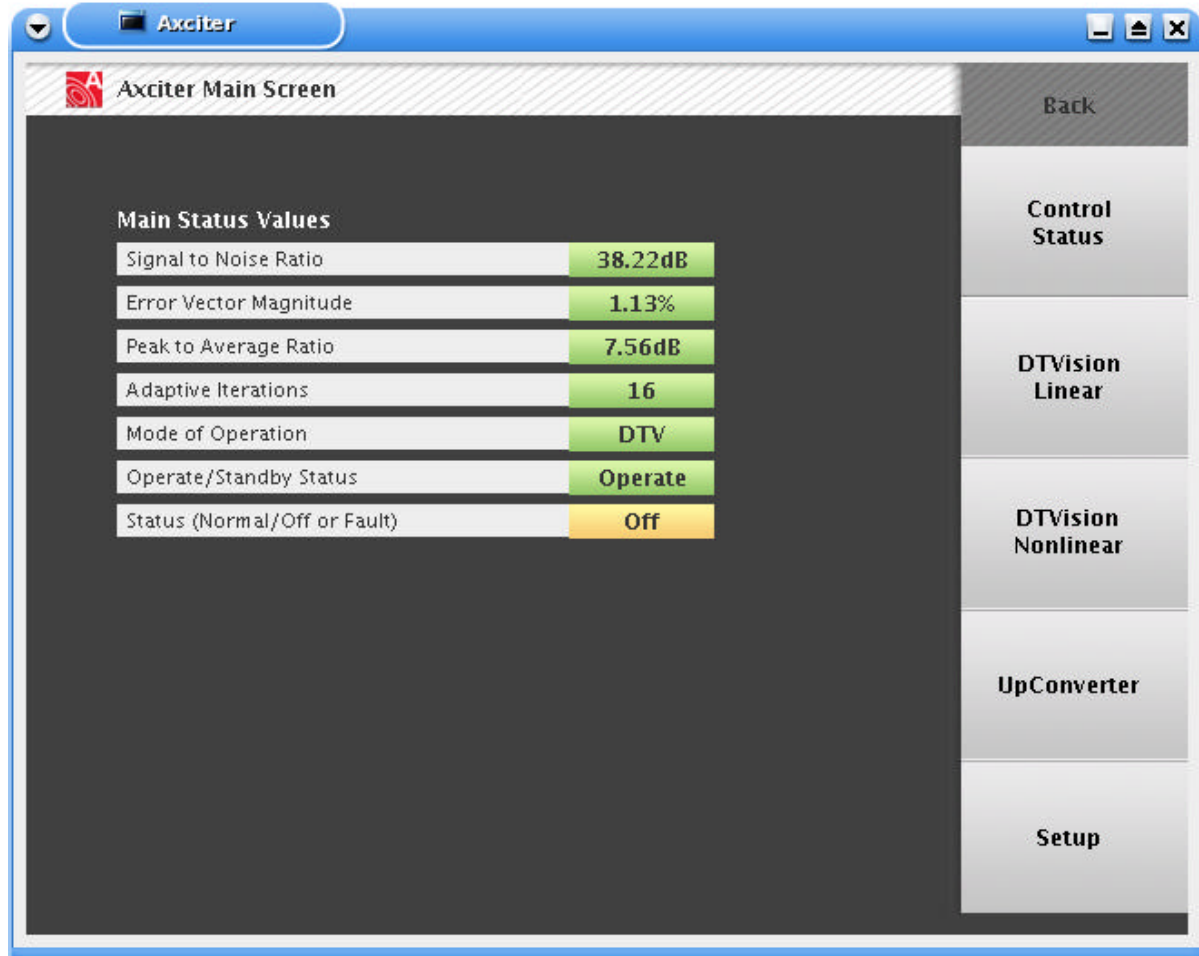

The purpose of this display is to show the general status of the Axciter.

Legend

Green: The green value indicates that there are no errors and everything is normal and present.

Red: The red value indicates there are errors or problems.

Yellow: The yellow indicates the associated value is absent or not on or is at a warning level.

Status

Signal to Noise Ratio: The Signal to Noise ratio expressed in decibels.

Error Vector Magnitude: The error vector magnitude expressed in %.

Peak to Average Ratio: The peak to average ratio of the transmitter output.

Adaptive Iterations: The number of adaptive iterations completed.

Mode of Operation: DTV, NTSC, or signal frequency network slave operation.

Operate/Standby: States whether the Exciter is in standby or operate. This is controlled by a system controller if there is one.

Status: Summary fault status of the exciter. See Control/Status page for more details.

Control and Status Screen



The purpose of this display is to show the general status of the AxciTer.

Status

SMPTE Lock: Indicates whether the SMPTE sync packets are detected.

SMPTE 310 Input #1: The SMPTE 310 (ATSC) input signal is present.

SMPTE 310 Input #2: The SMPTE 310 (ATSC) input signal is present.

10 MHz Ref In: The externally applied 10 MHz reference signal is present.

IF In: The downconverted IF sample of the transmitter's output is present.

IF Out: The exciter is producing an IF output signal.

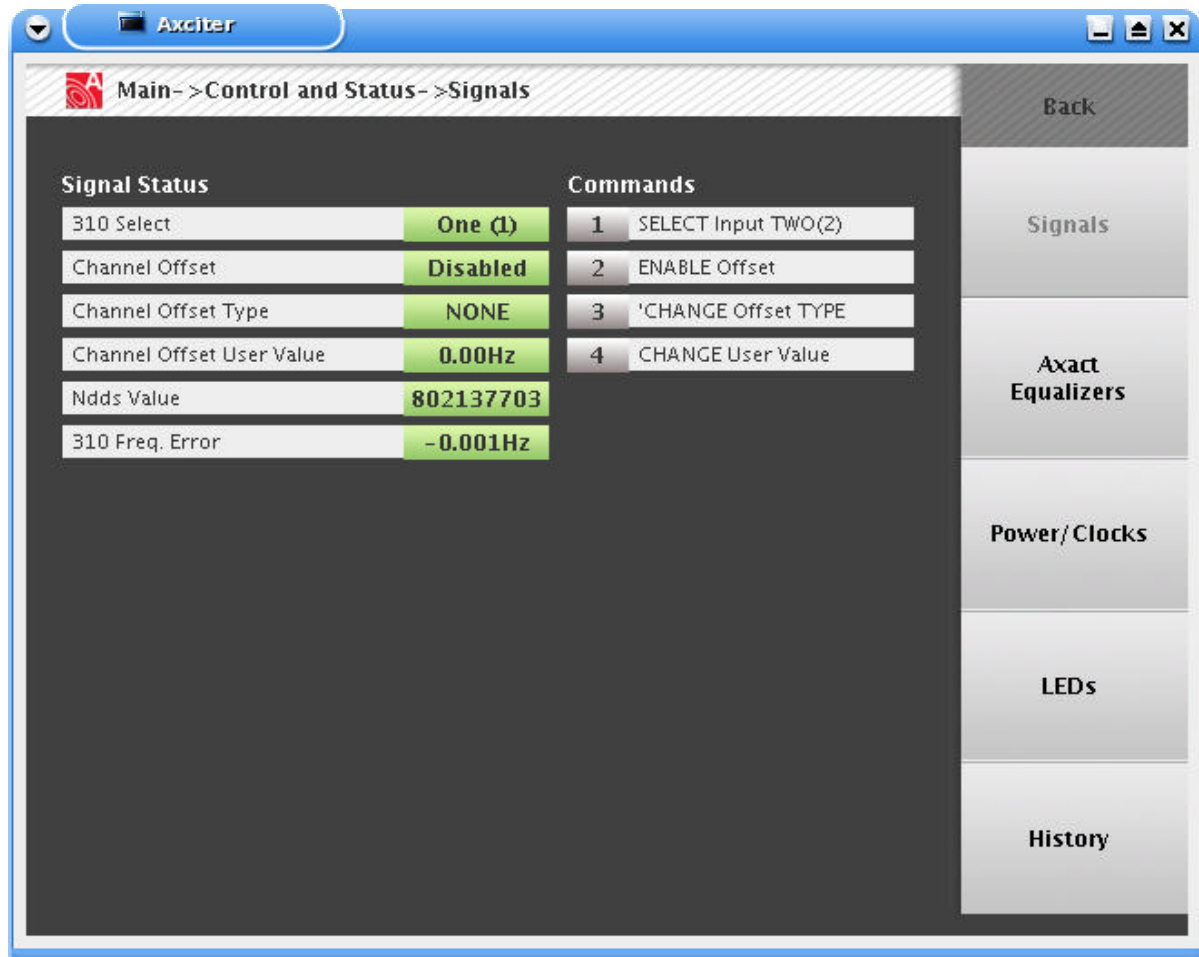
Signals Status Screen**Signals**

+310 Select: Displays which 310 input is being used on air.

Channel Offset: Displays whether an offset is in use.

Channel Offset Type: Displays the type of offset selected.

Channel Offset User Value: The amount of manual offset selected.

NDDS Value: An internal raw reading used for 310 clocking.

310 Frequency Error: The calculated frequency error of the active 310 input.

Commands

1: Toggles between the two 310 inputs.

2: Enables or disables the selected offset.

3: Allows user to select preset, manual offsets, or no offsets.

4: Allows direct entry of manual offset amount.

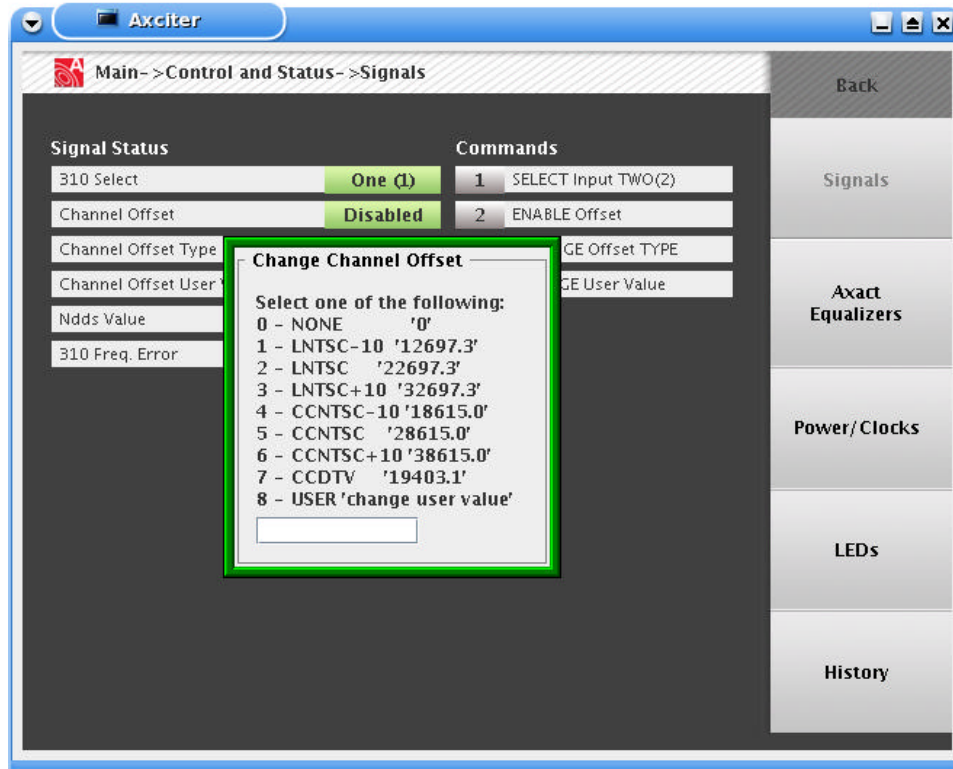
Channel Offset Example**CHANNEL OFFSET****Enable**

Selecting this option will change the transmitted frequency by the selected offset value. (Channel offsets are used to minimize co-channel or adjacent channel interference.)

Disable

Selecting this option will set the transmitted frequency to the standard value for the channel in use (pilot 309.440559 kHz above the lower channel edge.)

This display allows channel offset adjustment for the ATSC mode of the Axciter.

Channel offsets are used to minimize interference between co-channel and/or adjacent channel signals. Selection of a type of channel offset is dependent on the kind of interference being caused or received. Check with the appropriate regulatory body (FCC) and review your DTV channel assignment before beginning transmission with a channel offset.

DTV/DTV

+19403.07Hz

-19403.07Hz

This offset frequency is chosen to minimize co-channel interference between two DTV signals.

Manual

If research into channel offsets produces new values that can mitigate certain interference conditions, any channel offset value can be entered in the box.

None

Disables channel offset. Select this box to transmit without any channel offset.

AXACT Equalizers

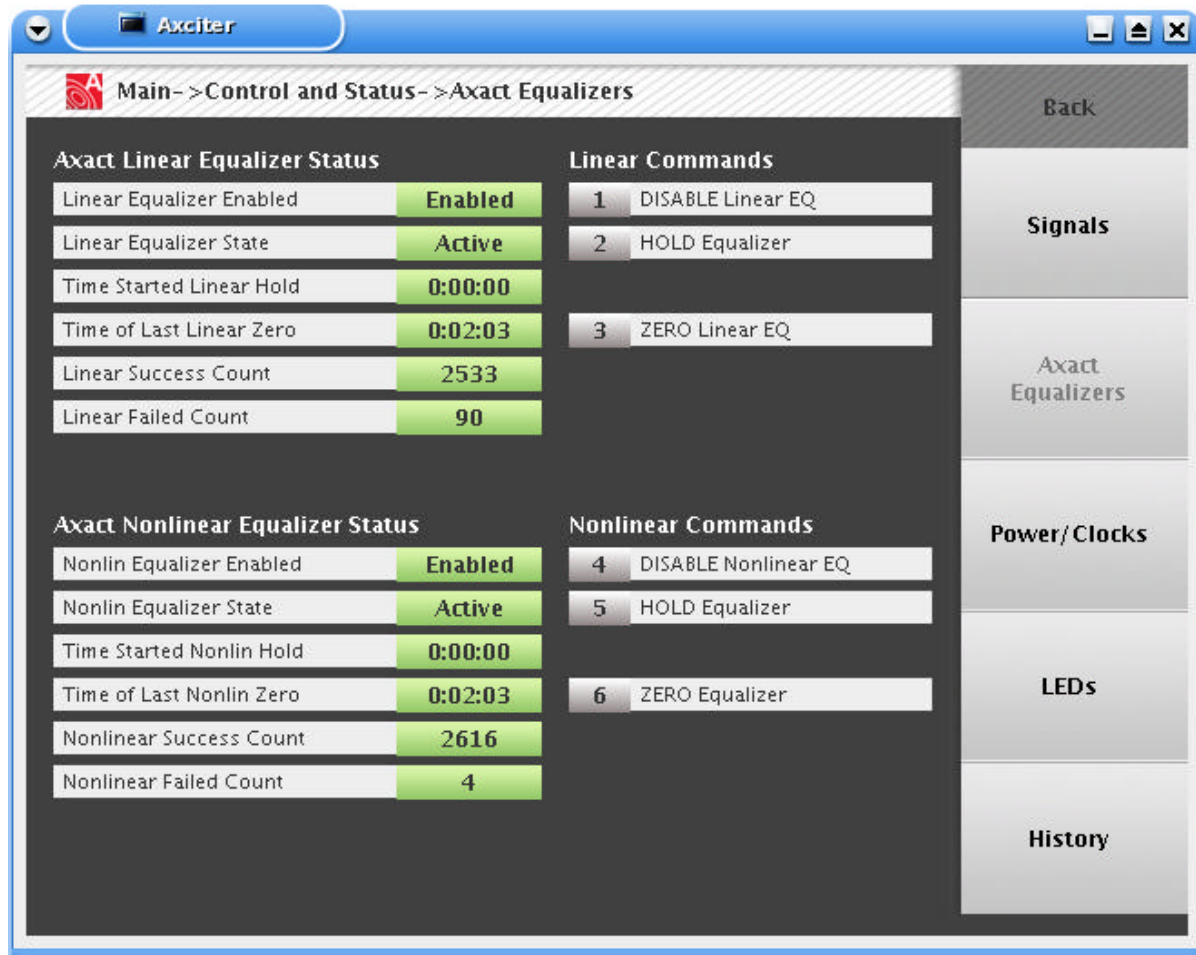

LINEAR EQUALIZER**Hold**

When this option is selected, the linear equalizer is forced to use the current values rather than calculating new values. This will continue until the Hold option is deselected. The equalizer will not adjust to compensate for changes while this is selected.

Zero

When Zero is selected, the linear equalizer is loaded with unity values describing a flat response and the demodulation routine is restarted. This option will clear itself when finished.

Enable

This option turns on the adaptive linear equalizer. The linear equalizer corrects for frequency response and group delay characteristics in the transmitter and the channel filter.

Disable

This option disables the adaptive linear equalizer. Group delay and frequency response characteristics will not be removed from the transmitted signal.

Linear Successes

This value shows the number of times since Axciter started that Linear Adaptive was successful.

Linear Failures

This value shows the number of times since Axciter started that Linear Adaptive was unable to use the data available to fix the equalizer.

NONLINEAR EQUALIZER**Hold**

When this option is selected, the nonlinear equalizer is forced to use the current values rather than calculating new values. This will continue until the Hold option is deselected. The equalizer will not adjust to compensate for changes while this is selected.

Zero

When Zero is selected, the nonlinear equalizer is loaded with unity values with no pre-correction and the demodulation routine is restarted. This option will clear itself when finished.

Enable

This option enables the adaptive nonlinear equalizer. The nonlinear equalizer corrects for nonlinear distortions, such as gain compression and incidental phase modulation, in the transmitter's power amplifier.

Disable

This option disables the adaptive nonlinear equalizer. Any nonlinear distortion added to the signal by the power amplifier will not be corrected.

Nonlinear Success

This value shows the number of times Nonlinear Adaptive was successful.

Nonlinear Failures

This value shows the number of times since Axciter started that Nonlinear Adaptive was unable to use the data available to fix the equalizer.

Clock and Power Status Screen

Clock and Power Values		Voltages	
Ext 10MHz Ref	Missing	+12Volts	12.1Volts
1GHz	Locked	-12Volts	-12.0Volts
IF Out Level 1	NTSC ONLY	+5Volts Digital	5.1Volts
IF Out Level 2	-12.07DBm	+5Volts Analog	5.0Volts
10MHz AFC	0.88Volts	-5Volts Analog	-5.0Volts
1GHz AFC	0.65Volts	+3.3Volts Digital	3.4Volts
10MHz MFC	0.50Volts	+3.3Volts Analog	3.2Volts
External 10MHz	0.00DBm	+2.5Volts	2.5Volts
S310 Cable EQ1	0.84Volts	+1.8Volts	1.8Volts
S310 Cable EQ2	0.82Volts	+1.25Volts	1.2Volts

The screenshot also shows a navigation menu on the right with the following items: Back, Signals, Axcit Equalizers, Power/Clocks, LEDs, and History.

Clock Power

10MHz: External reference presence indication.

1GHz: Lock status of internal 1GHz clock oscillator.

IF Out Level 1: Level of 12VDC source.

IF Out Level 2: Level of 12VDC source.

Supplies (Power)

+12V Supply: Voltage of regulated +12VDC source.

-12V Supply: Voltage of regulated -12VDC source.

+5V Supply: Voltage of regulated +5V source.

Coder +3.3V: Channel Coder's 3.3V voltage regulator output.

Mod +3.3V: Modulator board's 3.3V voltage regulator output.

IF +3.3V: IF board's 3.3V voltage regulator output.

LED Status Screen

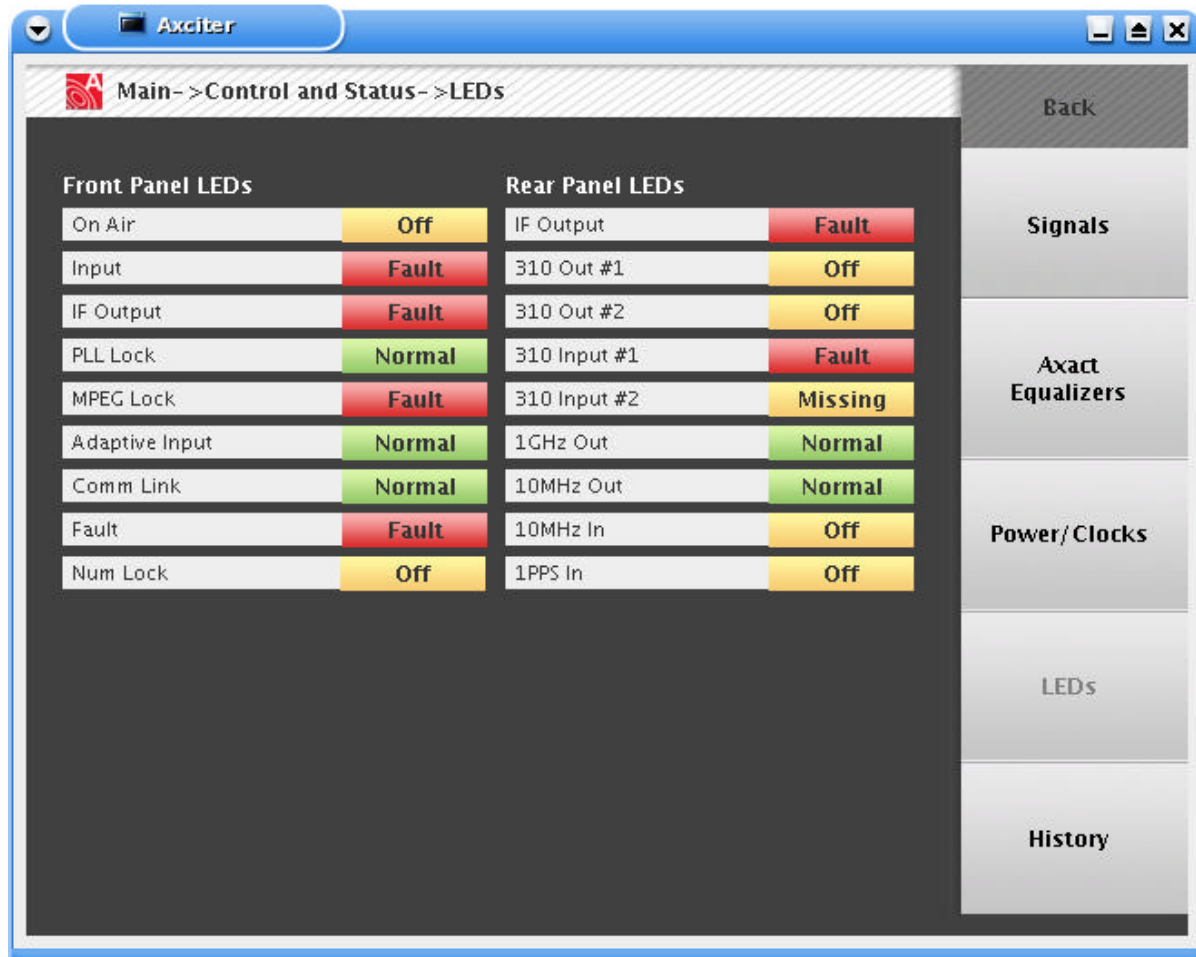

LED Status Screen gives a user a view of the LEDs both on the front of the Axciter as well as the rear. This screen mainly intended for remote viewers.

Front Panel LEDs

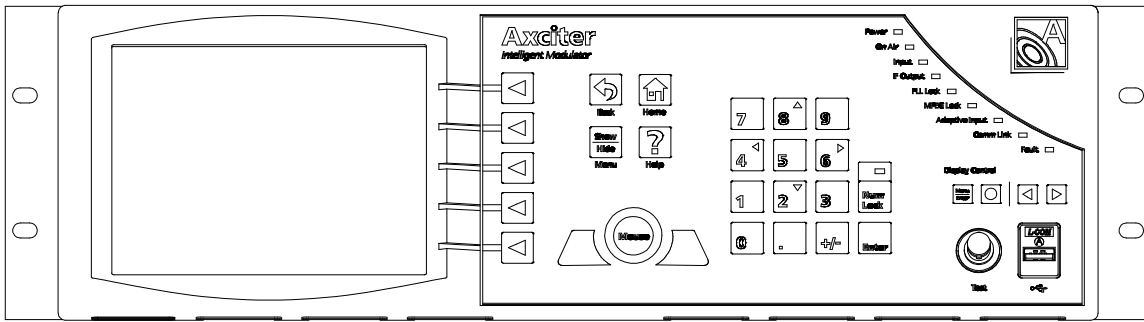

LED	FUNCTION
Power	
On Air	
Input	
IF Output	
PLL Lock	
SMPTE Lock	
Adaptive Input	
Communication Link	
Fault	
Number Lock	Indicates the keypad types numbers only. arrows do not work.

Rear Panel LEDs

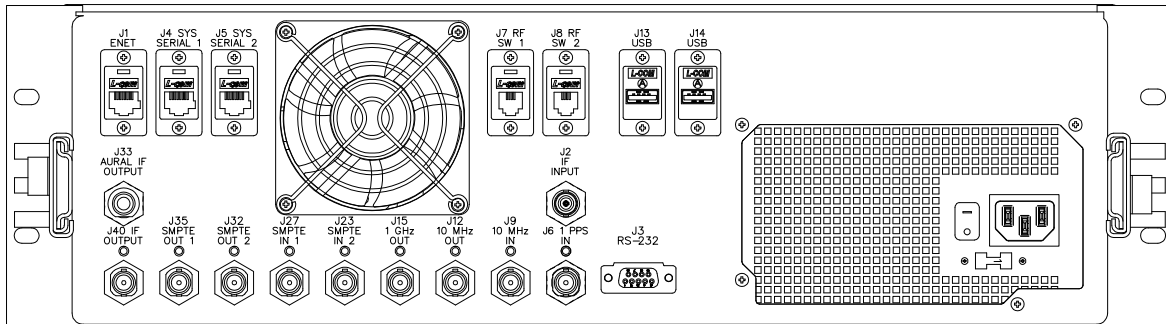

The rear panel of the modulator has an LED next to each coaxial connector. During operation, a green LED next to the connector means that the signal is present. A red LED means that the signal is absent or in a fault condition. A dark LED indicates that the signal is not being used

LED	TITLE	FUNCTION
J40	IF OUTPUT	
J35	310 OUTPUT #1	
J32	310 OUTPUT #2	
J27	310 INPUT #1	
J23	310 INPUT #2	
J15	1 GHz OUT	
J12	10 MHz OUT	
J9	10 MHz IN	
J6	1 PPS IN	

History

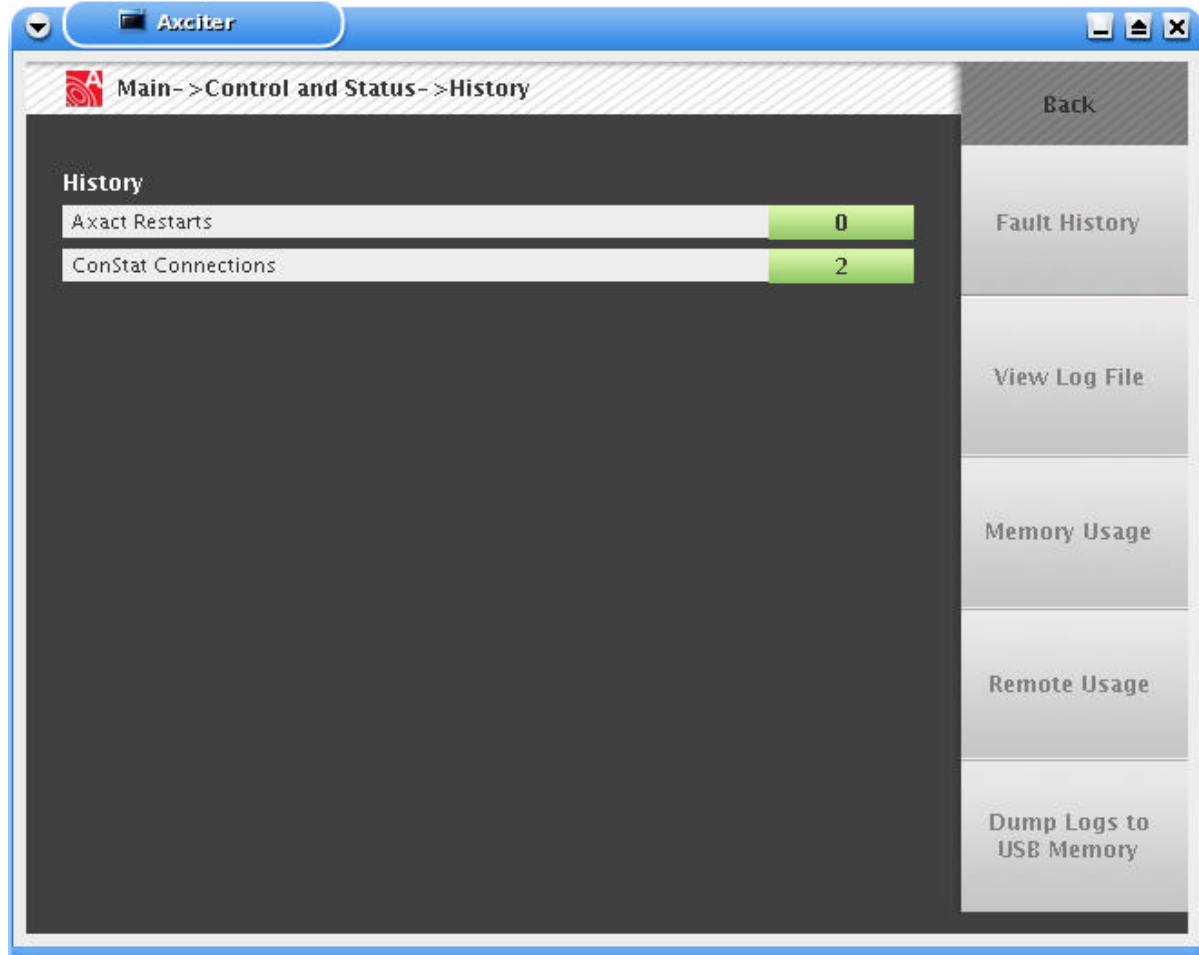

Axact Restarts

This value lists the number of times the AXACT sub-program has restarted. This may indicate a problem with communications and/or hardware.

ConStat Connections

This value lists the number of times the ConStat server has reconnected to the Netburner computer. This may indicate a problem with communications and/or the Netburner itself. This number may not represent the number of times the Netburner has reset itself, just that the server had to reconnect.

DTVision Linear - Optional

This section contains information regarding the DTVision Screens. These screens are optional diagnostic screens. They are not necessary for the operation of the Axciter. However, they greatly enhance the experience. These graphs provide the same type of views as an EFA.

All of the Linear Screens have the following reference values on the bottom of the screens.

dB Stretch

This value is the maximum amount of gain boost being generated by the Nonlinear Equalizer. This value is approximately equal to the maximum amount of gain compression of the power amplifier.

dB Compression

This value is the minimum amount of gain being generated by the Nonlinear Equalizer. This value is indicative of any relative "stretch" being produced in the power amplifier.

Phase Shift

This is the maximum value of instantaneous phase shift being produced by the Nonlinear Equalizer. This value corresponds to the incidental phase modulation of the power amplifier.

dB Boost

This is the maximum amount of amplitude boost being produced by the Linear Equalizer. This value corresponds to the lowest point in the channel frequency response.

dB Attenuation

This is the minimum gain level being produced by the Linear Equalizer. This value corresponds to the highest point in the channel frequency response.

ns Equalizer Delay

This is the maximum group delay variation in nanoseconds of the Linear Equalizer.

EVM

The error vector magnitude (EVM) value indicates quality of the digital modulation. EVM is defined as the RMS error at the sampling instants divided by the RMS of the ideal symbols. The error is expressed as a percentage. As signal quality increases, this value decreases.

S/N

The transmitted signal quality is also expressed as an in-band signal to noise ratio, expressed in dB. As signal quality increases, this value will increase (logarithmically).

DAC Headroom

This parameter shows the amplitude (in dB) of the equalized IF signal with respect to the maximum output from the digital to analog converter (DAC). A positive value indicates normal operation and no clipping. If this value is ever negative, then there is clipping in the IF modulator, nonlinear equalizer,

and/or the DAC. If this happens, lower the unity gain reference point for the nonlinear equalizer.

Peak to Average Ratio

This value shows the peak to average ratio of the transmitted signal. This value is typically 6 to 8 dB for a perfect signal. A value significantly lower will indicate peak compression. A small amount of peak compression is normal.

DTVision Linear Home/ Spectrum Screen

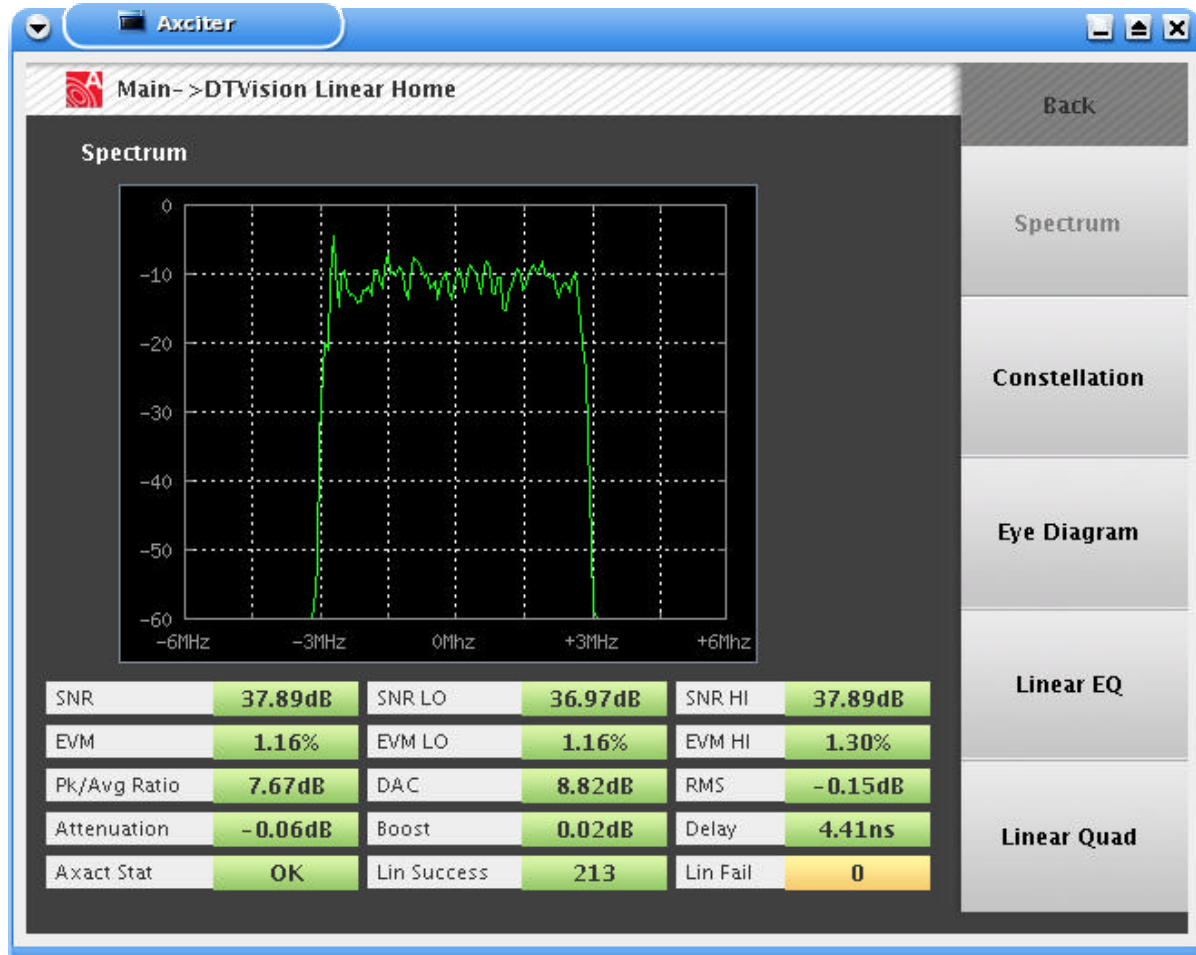

8-VSB Spectrum Display

The spectrum display shows the energy of the output signal as a function of frequency. An ideal 8VSB signal will occupy 6 MHz of bandwidth. Power amplifier nonlinearity will cause undesired "shoulders" to appear on each side of the spectrum.

DTVision Constellation Screen

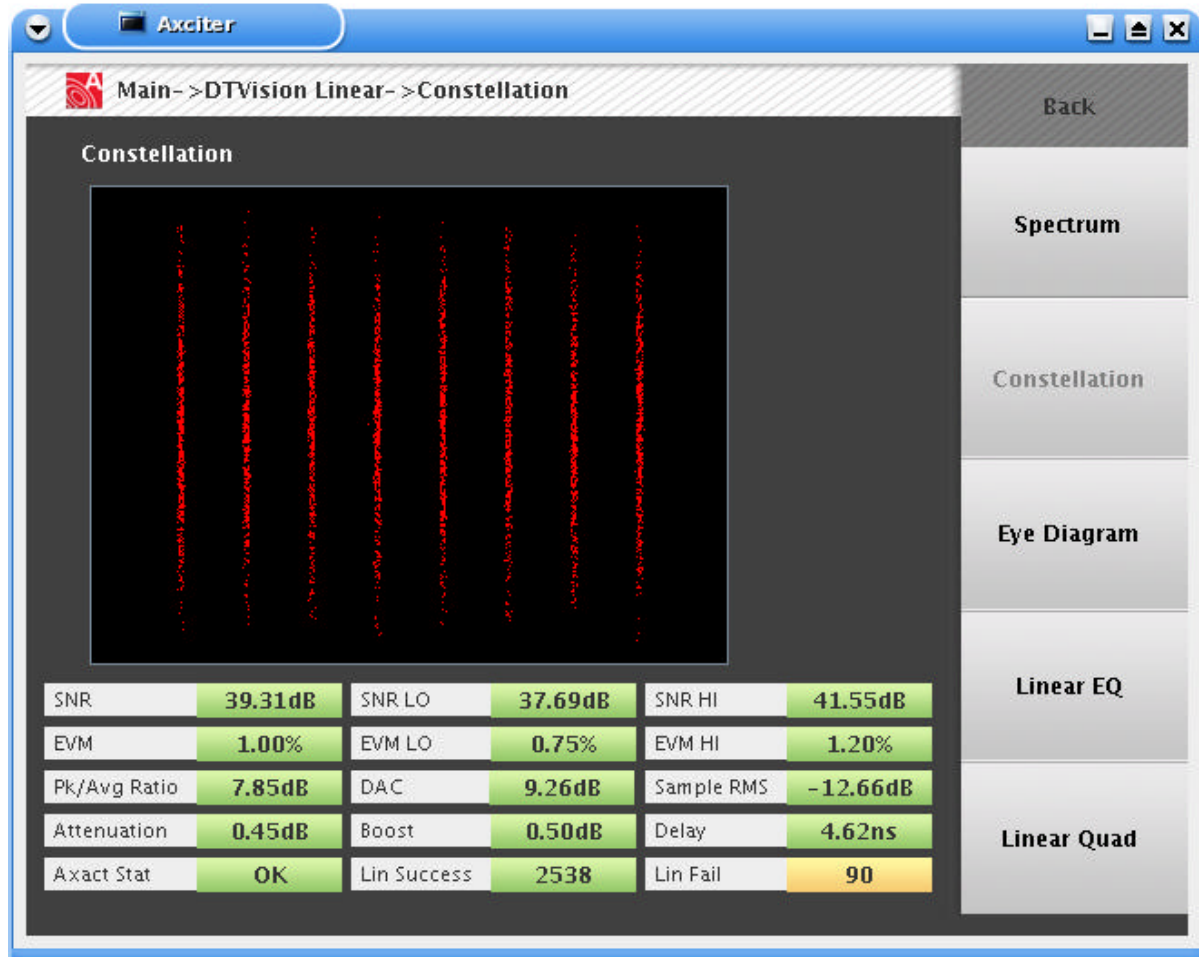

I & Q Constellation Display

This display is created by plotting the 8-VSB in-phase (I) component against the quadrature (Q) component. When the samples are taken at the symbol time, then the data points will be precisely aligned along the eight vertical lines. Those eight vertical lines are the eight VSB data levels.