INSTRUCTION MANUAL

Innovator LX Series

Power Amplifier
Assembly

AXCERA, LLC

103 FREEDOM DRIVE P.O. BOX 525 LAWRENCE, PA 15055-0525 USA
(724) 873-8100 • FAX (724) 873-8105
www.axcera.com • info@axcera.com



TABLE OF CONTENTS

SECTION	PAGE
CHAPTER 1 INTRODUCTION	
1.1 Manual Overview	1-1
1.2 Assembly Designation Numbers	1-1
1.3 Safety.....	1-1
1.4 Maintenance	1-2
1.5 Material Return Procedure	1-2
1.6 Limited One-Year Warranty for Axcera Products	1-3
CHAPTER 2 SYSTEM DESCRIPTION & REMOTE CONTROL CONNECTIONS	
2.1 LX Series Power Amplifier Assembly Overview.....	2-1
2.1.1 Power Amplifier Module, 250 Watt	2-1
2.1.2 Power Supply Module Assembly.....	2-3
2.1.3 Front Panel LCD Display Screens	2-3
2.2 System Operation	2-3
2.2.1 Principles of Operation.....	2-4
2.3 Customer Remote Connections	2-5
CHAPTER 3 SITE CONSIDERATIONS, INSTALLATION AND SETUP PROCEDURES	
3.1 Site Considerations.....	3-1
3.2 Unpacking the Chassis w/Modules, bandpass and trap filters.....	3-4
3.3 Installing the Chassis w/Modules and filters	3-4
3.4 AC Input	3-5
3.5 Setup and Operation.....	3-5
3.5.1 Input Connections	3-5
3.5.2 Front Panel Screens for the Exciter/Amplifier Chassis Assembly	3-7
3.5.3 Initial Turn On	3-14
CHAPTER 4 CIRCUIT DESCRIPTIONS	
4.1 Power Amplifier Module	4-1
4.1.1 UHF Phase/Gain Board.....	4-1
4.1.2 150 Watt Driver Pallet Assembly	4-1
4.1.3 150 Watt Driver, Dual Output Board	4-1
4.1.4 UHF Module Assembly, RF Module Pallet, Philips	4-2
4.1.5 2 Way UHF Combiner Assembly.....	4-2
4.1.6 Amplifier Control Board.....	4-3
4.2 Power Supply Assembly	4-5
CHAPTER 5 DETAILED ALIGNMENT PROCEDURES	
5.1 Module Replacement.....	5-1
5.1.1 Initial Test Setup.....	5-1
5.2 Innovator LX Series Exciter/Amplifier Chassis Assembly	5-2
5.2.1 Linearity Correction Adjustment	5-3
5.2.2 Frequency Response Delay Equalization Adjustment	5-4
5.2.3 Calibration of Forward Output Power Level.....	5-4
5.2.4 Calibration of Reflected Output Power Level.....	5-5
5.3 Bandpass Filter Assembly	5-5

TABLE OF CONTENTS - (Continued)

5.4 UHF Trap Filter Assembly 5-5
 5.4.1 The Effects of Tuning the Output Trap Filter..... 5-6

APPENDICES

APPENDIX A INNOVATOR LX SERIES SPECIFICATIONS

APPENDIX B DRAWINGS AND PARTS LISTS

FIGURE	LIST OF FIGURES	PAGE
3-1	1 kW Minimum Ventilation Configuration	3-4
3-2	Front and Rear View Reconnection Drawing	3-5
3-3	Rear View of LX Series Translator	3-6
4-1	UHF Amplifier Module, 250 Watts.....	4-2
5-1	Typical Red Field Spectrum.....	5-4

LIST OF TABLES		
TABLE		PAGE
2-1	LX Series Power Amplifier Assemblies	2-1
2-2	Power Amplifier Status Indicators	2-3
2-3	Power Amplifier Control Adjustments.....	2-3
2-4	Power Amplifier Sample	2-3
2-5	Pioneer Chassis Customer Remote Connections	2-5
3-1	Rear Chassis Connections for LX Series Translator.....	3-6
3-2	Menu 01 Splash Screen #1.....	3-7
3-3	Menu 02 Splash Screen #2.....	3-7
3-4	Menu 10 Main Screen	3-7
3-5	Menu 11 Error List Access Screen	3-8
3-6	Menu 12 Translator Device Data Access Screen	3-8
3-7	Menu 13 Translator Configuration Access Screen.....	3-8
3-8	Menu 20 Error List Display Screen.....	3-8
3-9	Menu 30 Translator Device Details Screen	3-9
3-10	Menu 30-1 System Details Screens.....	3-9
3-11	Translator Device Parameters Detail Screens.....	3-9
3-12	Menu 40 Translator Set Up: Power Raise/Lower Screen.....	3-10
3-13	Menu 40-1 Translator Set Up: Model Select Screen	3-10
3-14	Menu 40-2 Translator Set Up: Frequency Select Screen.....	3-11
3-15	Menu 40-3 Translator Set Up: Frequency Table Select Screen.....	3-11
3-16	Menu 40-4 Translator Set Up: IF Frequency Screen.....	3-11
3-17	Menu 40-5 Translator Set Up: Custom Frequency Select Screen.....	3-11
3-18	Menu 40-6 Translator Set Up: Xmtr. Set Up Serial Address Screen	3-12
3-19	Menu 40-7 Translator Set Up: Station ID Screen.....	3-12
3-20	Menu 40-8 Translator Set Up: System Visual Power Cal. Screen.....	3-12
3-21	Menu 40-9 Translator Set Up: System Aural Power Cal. Screen.....	3-12
3-22	Menu 40-10 Translator Set Up: System Rfltd. Power Cal. Screen.....	3-13
3-23	Menu 40-11 Translator Set Up: Fwrdr Pwr Fault Threshold Screen	3-13
3-24	Menu 40-12 Translator Set Up: Refl Power Fault Threshold Screen	3-13
3-25	Menu 40-13 Translator Set Up: Remote Commands Control Screen	3-13

Chapter 1 Introduction

This manual explains the installation, setup, alignment, and maintenance procedures for the Power Amplifier Assembly for the Innovator LX Series translator. It is important that you read all of the instructions, especially the safety information in this chapter, before you begin to install or operate the unit.

1.1 Manual Overview

This instruction manual is divided into five chapters and supporting appendices. Chapter 1, Introduction, contains information on the assembly numbering system used in the manual, safety, maintenance, return procedures, and warranties. The second chapter describes the amplifier assembly and includes discussions on control and status indicators and remote control connections. Chapter 3 explains how to unpack, install, setup, and operate the power amplifier assembly. Chapter 4 contains circuit-level descriptions for boards and board-level components in the power amplifier. Chapter 5, Detailed Alignment Procedures, provides information on adjusting the power amplifier and the system for optimal operation. The appendices contain assembly and subassembly drawings and parts lists and the system specifications.

1.2 Assembly Designators

Axcera has assigned assembly numbers, such as Ax (x=1,2,3...), to all assemblies, trays, and boards that are referenced in the text of this manual and shown on the block diagrams and interconnect drawings provided in the appendices. These supporting documents are arranged in increasing numerical order in the appendices. Section titles in the text for assembly or tray descriptions or alignment procedures contain the associated part number(s) and the

relevant appendix that contains the drawings for that item.

1.3 Safety

The translators and associated power amplifier assemblies manufactured by Axcera are designed to be easy to use and repair while providing protection from electrical and mechanical hazards. Listed throughout the manual are notes, cautions, and warnings concerning possible safety hazards that may be encountered while operating or servicing the translator. Please review these warnings and familiarize yourself with the operation and servicing procedures before working on the assembly.

Read All Instructions – All of the operating and safety instructions should be read and understood before operating this equipment.

Retain Manuals – The manuals for the power amplifier assembly and the translator should be retained at the translator site for future reference. We provide two sets of manuals for this purpose; one set can be left at the office while one set can be kept at the site.

Heed all Notes, Warnings, and Cautions – All of the notes, warnings, and cautions listed in this safety section and throughout the manual must be followed.

Follow Instructions – All of the operating and use instructions for the amplifier assembly should be followed.

Cleaning – Unplug or otherwise disconnect all power from the equipment before cleaning. Do not use liquid or aerosol cleaners. Use a damp cloth for cleaning.

Ventilation – Openings in the cabinets and modules front panels are provided for ventilation. To ensure the reliable operation of the amplifier assembly, and to protect the unit from overheating, these openings must not be blocked.

Servicing – Do not attempt to service this product yourself until becoming familiar with the equipment. If in doubt, refer all servicing questions to qualified Axcera service personnel.

Replacement Parts – When replacement parts are used, be sure that the parts have the same functional and performance characteristics as the original part. Unauthorized substitutions may result in fire, electric shock, or other hazards. Please contact the Axcera Technical Service Department if you have any questions regarding service or replacement parts.

1.4 Maintenance

The LX Series Translator is designed with components that require little or no periodic maintenance except for the routine cleaning of the fans and the front panels of the modules.

The amount of time between cleanings depends on the conditions within the translator room. While the electronics have been designed to function even if covered with dust, a heavy buildup of dust, dirt, or insects will affect the cooling of the components. This could lead to a thermal shutdown or the premature failure of the affected modules.

When the front panels of the modules become dust covered, the top covers should be taken off and any accumulated foreign material should be removed. A vacuum cleaner, utilizing a small, wand-type attachment, is an excellent way to suction out the dirt. Alcohol and other cleaning agents should not be used unless you are certain that the solvents will not damage components or the silk-

screened markings on the modules and boards. Water-based cleaners can be used, but do not saturate the components. The fans and heatsinks should be cleaned of all dust or dirt to permit the free flow of air for cooling purposes.

It is recommended that the operating parameters of the amplifier assembly and translator be recorded from the LEDs on the modules and the LCD system metering on the control/monitoring module at least once a month. It is suggested that this data be retained in a rugged folder or envelope.

1.5 Material Return Procedure

To insure the efficient handling of equipment or components that have been returned for repair, Axcera requests that each returned item be accompanied by a Material Return Authorization Number (MRA#).

An MRA# can be obtained from any Axcera Field Service Engineer by contacting the Axcera Field Service Department at (724) 873-8100 or by fax at (724) 873-8105. This procedure applies to all items sent to the Field Service Department regardless of whether the item was originally manufactured by Axcera.

When equipment is sent to the field on loan, an MRA# is included with the unit. The MRA# is intended to be used when the unit is returned to Axcera. In addition, all shipping material should be retained for the return of the unit to Axcera.

Replacement assemblies are also sent with an MRA# to allow for the proper routing of the exchanged hardware. Failure to close out this type of MRA# will normally result in the customer being invoiced for the value of the loaner item or the exchange assembly.

When shipping an item to Axcera, please include the MRA# on the packing list and on the shipping container. The packing slip should also include contact information and a brief description of why the unit is being returned.

Please forward all MRA items to:

AXCERA, LLC
103 Freedom Drive
P.O. Box 525
Lawrence, PA 15055-0525 USA

For more information concerning this procedure, call the Axcera Field Service Department.

Axcera can also be contacted through e-mail at **info@axcera.com** and on the Web at **www.axcera.com**.

1.6 Limited One-Year Warranty for Axcera Products

Axcera warrants each new product that it has manufactured and sold against defects in material and workmanship under normal use and service for a period of one (1) year from the date of shipment from Axcera's plant, when operated in accordance with Axcera's operating instructions. This warranty shall not apply to tubes, fuses, batteries, or bulbs.

Warranties are valid only when and if (a) Axcera receives prompt written notice of breach within the period of

warranty, (b) the defective product is properly packed and returned by the buyer (transportation and insurance prepaid), and (c) Axcera determines, in its sole judgment, that the product is defective and not subject to any misuse, neglect, improper installation, negligence, accident, or (unless authorized in writing by Axcera) repair or alteration. Axcera's exclusive liability for any personal and/or property damage (including direct, consequential, or incidental) caused by the breach of any or all warranties, shall be limited to the following: (a) repairing or replacing (in Axcera's sole discretion) any defective parts free of charge (F.O.B. Axcera's plant) and/or (b) crediting (in Axcera's sole discretion) all or a portion of the purchase price to the buyer.

Equipment furnished by Axcera, but not bearing its trade name, shall bear no warranties other than the special hours-of-use or other warranties extended by or enforceable against the manufacturer at the time of delivery to the buyer.

NO WARRANTIES, WHETHER STATUTORY, EXPRESSED, OR IMPLIED, AND NO WARRANTIES OF MERCHANTABILITY, FITNESS FOR ANY PARTICULAR PURPOSE, OR FREEDOM FROM INFRINGEMENT, OR THE LIKE, OTHER THAN AS SPECIFIED IN PATENT LIABILITY ARTICLES, AND IN THIS ARTICLE, SHALL APPLY TO THE EQUIPMENT FURNISHED HEREUNDER.

 **WARNING!!!****◀ HIGH VOLTAGE ▶**

DO NOT ATTEMPT TO REPAIR OR TROUBLESHOOT THIS EQUIPMENT UNLESS YOU ARE FAMILIAR WITH ITS OPERATION AND EXPERIENCED IN SERVICING HIGH VOLTAGE EQUIPMENT. LETHAL VOLTAGES ARE PRESENT WHEN POWER IS APPLIED TO THIS SYSTEM. IF POSSIBLE, TURN OFF POWER BEFORE MAKING ADJUSTMENTS TO THE SYSTEM.

★ RADIO FREQUENCY RADIATION HAZARD ★

MICROWAVE, RF AMPLIFIERS AND TUBES GENERATE HAZARDOUS RF RADIATION THAT CAN CAUSE SEVERE INJURY INCLUDING CATARACTS, WHICH CAN RESULT IN BLINDNESS. SOME CARDIAC PACEMAKERS MAY BE AFFECTED BY THE RF ENERGY EMITTED BY RF AND MICROWAVE AMPLIFIERS. NEVER OPERATE THE TRANSLATOR SYSTEM WITHOUT A PROPERLY MATCHED RF ENERGY ABSORBING LOAD ATTACHED. KEEP PERSONNEL AWAY FROM OPEN WAVEGUIDES AND ANTENNAS. NEVER LOOK INTO AN OPEN WAVEGUIDE OR ANTENNA. MONITOR ALL PARTS OF THE RF SYSTEM FOR RADIATION LEAKAGE AT REGULAR INTERVALS.

EMERGENCY FIRST AID INSTRUCTIONS

Personnel engaged in the installation, operation, or maintenance of this equipment are urged to become familiar with the following rules both in theory and practice. It is the duty of all operating personnel to be prepared to give adequate Emergency First Aid and thereby prevent avoidable loss of life.



RESCUE BREATHING

1. Find out if the person is breathing.

You must find out if the person has stopped breathing. If you think he is not breathing, place him flat on his back. Put your ear close to his mouth and look at his chest. If he is breathing you can feel the air on your cheek. You can see his chest move up and down. If you do not feel the air or see the chest move, he is not breathing.

2. If he is not breathing, open the airway by tilting his head backwards.

Lift up his neck with one hand and push down on his forehead with the other. This opens the airway. Sometimes doing this will let the person breathe again by himself.

3. If he is still not breathing, begin rescue breathing.

-Keep his head tilted backward.
-Pinch nose shut.
-Put your mouth tightly over his mouth.
-Blow into his mouth once every five seconds
-DO NOT STOP rescue breathing until help arrives.

LOOSEN CLOTHING - KEEP WARM

Do this when the victim is breathing by himself or help is available. Keep him as quiet as possible and from becoming chilled. Otherwise treat him for shock.

BURNS

SKIN REDDENED: Apply ice cold water to burned area to prevent burn from going deeper into skin tissue. Cover area with clean sheet or cloth to keep away air. Consult a physician.

SKIN BLISTERED OR FLESH CHARRED: Apply ice cold water to burned area to prevent burn from going deeper into skin tissue.

Cover area with clean sheet or cloth to keep away air. Treat victim for shock and take to hospital.

EXTENSIVE BURN - SKIN BROKEN: Cover area with clean sheet or cloth to keep away air. Treat victim for shock and take to hospital.

dBm, dBw, dBmV, dB μ V, & VOLTAGE EXPRESSED IN WATTS

50 Ohm System

WATTS	PREFIX	dBm	dBw	dBm V	dB μ V	VOLTAGE
1,000,000,000,000	1 TERAWATT	+150	+120			
100,000,000,000	100 GIGAWATTS	+140	+110			
10,000,000,000	10 GIGAWATTS	+130	+100			
1,000,000,000	1 GIGAWATT	+120	+ 99			
100,000,000	100 MEGAWATTS	+110	+ 80			
10,000,000	10 MEGAWATTS	+100	+ 70			
1,000,000	1 MEGAWATT	+ 90	+ 60			
100,000	100 KILOWATTS	+ 80	+ 50			
10,000	10 KILOWATTS	+ 70	+ 40			
1,000	1 KILOWATT	+ 60	+ 30			
100	1 HECTROWATT	+ 50	+ 20			
50		+ 47	+ 17			
20		+ 43	+ 13			
10	1 DECAWATT	+ 40	+ 10			
1	1 WATT	+ 30	0	+ 77	+137	7.07V
0.1	1 DECIWATT	+ 20	- 10	+ 67	+127	2.24V
0.01	1 CENTIWATT	+ 10	- 20	+ 57	+117	0.707V
0.001	1 MILLIWATT	0	- 30	+ 47	+107	224mV
0.0001	100 MICROWATTS	- 10	- 40			
0.00001	10 MICROWATTS	- 20	- 50			
0.000001	1 MICROWATT	- 30	- 60			
0.0000001	100 NANOWATTS	- 40	- 70			
0.00000001	10 NANOWATTS	- 50	- 80			
0.000000001	1 NANOWATT	- 60	- 90			
0.0000000001	100 PICOWATTS	- 70	-100			
0.00000000001	10 PICOWATTS	- 80	-110			
0.000000000001	1 PICOWATT	- 90	-120			

TEMPERATURE CONVERSION

$$^{\circ}\text{F} = 32 + [(9/5) ^{\circ}\text{C}]$$

$$^{\circ}\text{C} = [(5/9) (^{\circ}\text{F} - 32)]$$

USEFUL CONVERSION FACTORS

TO CONVERT FROM	TO	MULTIPLY BY
mile (US statute)	kilometer (km)	1.609347
inch (in)	millimeter (mm)	25.4
inch (in)	centimeter (cm)	2.54
inch (in)	meter (m)	0.0254
foot (ft)	meter (m)	0.3048
yard (yd)	meter (m)	0.9144
mile per hour (mph)	kilometer per hour(km/hr)	1.60934
mile per hour (mph)	meter per second (m/s)	0.44704
pound (lb)	kilogram (kg)	0.4535924
gallon (gal) U.S. liquid (One U.S. gallon equals 0.8327 Canadian gallon)	liter	3.7854118
fluid ounce (fl oz)	milliliters (ml)	29.57353
British Thermal Unit	watt (W)	0.2930711 per hour (Btu/hr)
horsepower (hp)	watt (W)	746

NOMENCLATURE OF FREQUENCY BANDS

FREQUENCY RANGE	DESIGNATION
3 to 30 kHz	VLF - Very Low Frequency
30 to 300 kHz	LF - Low Frequency
300 to 3000 kHz	MF - Medium Frequency
3 to 30 MHz	HF - High Frequency
30 to 300 MHz	VHF - Very High Frequency
300 to 3000 MHz	UHF - Ultrahigh Frequency
3 to 30 GHz	SHF - Superhigh Frequency
30 to 300 GHz	EHF - Extremely High Frequency

LETTER DESIGNATIONS FOR UPPER FREQUENCY BANDS

LETTER	FREQ. BAND
L	1000 - 2000 MHz
S	2000 - 4000 MHz
C	4000 - 8000 MHz
X	8000 - 12000 MHz
Ku	12 - 18 GHz
K	18 - 27 GHz
Ka	27 - 40 GHz
V	40 - 75 GHz
W	75 - 110 GHz

ABBREVIATIONS/ACRONYMS

AC	Alternating Current	PCB	Printed circuit board
AFC	Automatic Frequency Control	QAM	Quadrature Amplitude Modulation
ALC	Automatic Level Control		
AM	Amplitude modulation		
AGC	Automatic Gain Control		
AWG	American wire gauge		
BER	Bit Error Rate		
BW	Bandwidth		
DC	Direct Current		
D/A	Digital to analog		
dB	Decibel		
dBm	Decibel referenced to 1 milliwatt		
dBmV	Decibel referenced to 1 millivolt		
dBw	Decibel referenced to 1 watt		
FEC	Forward Error Correction		
FM	Frequency modulation		
Hz	Hertz		
ICPM	Incidental Carrier Phase Modulation		
I/P	Input		
IF	Intermediate Frequency		
LED	Light emitting diode		
LSB	Lower Sideband		
MPEG	Motion Pictures Expert Group		
O/P	Output		
PLL	Phase Locked Loop		

RETURN LOSS VS. VSWR

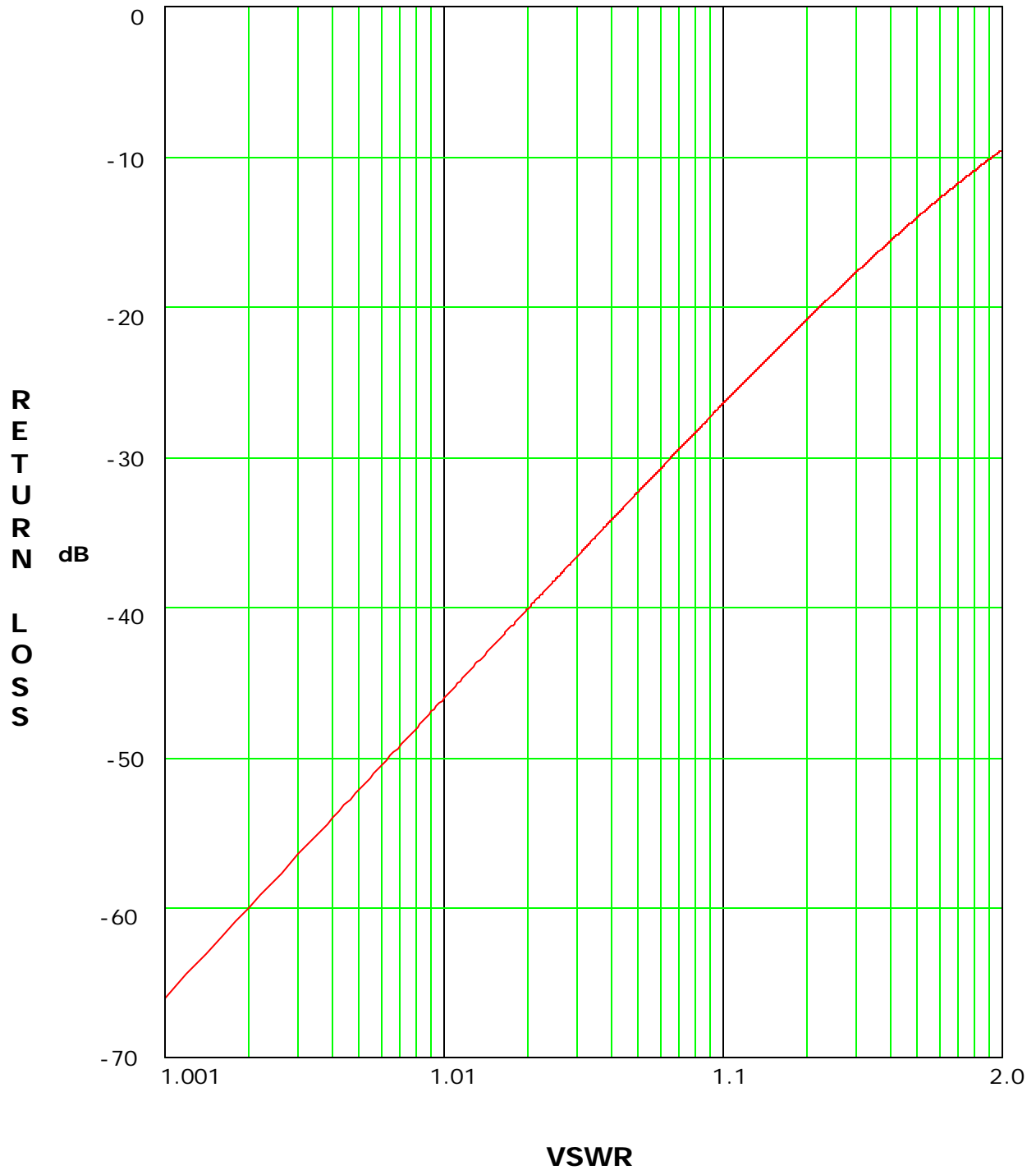

Chapter 2 Amplifier Assembly Description & Remote Control Connections

2.1 LX Series Power Amplifier Assembly Overview

The (A3) power amplifier assembly in the LX Series contains modular television amplifiers that slide into the assembly. There is also needed one external Power Supply Module Assembly for every two PA modules, which also slide into the Power amplifier assembly, under the PA Modules. Four PA modules and two Power Supply modules are the maximum number of modules in a Power Amplifier Assembly. The RF output of the (A2) exciter/driver at the "N" connector J25 connects to the power amplifier assembly at the "N" connector J200. A system serial cable connects from the Power Amplifier Assembly at J232 to J34 on the exciter/driver assembly. If more than two PA modules are used then another serial port J233 is also connected to the

exciter/driver. The output of the amplifier assembly at the "N" connector J205 is cabled to A9 the bandpass filter for the system. The filtered output can connect to (A10) the Optional 1 section or 2 section trap filter that provides even more filtering as needed. The filtered output is connected to A11 a coupler assembly that supplies a forward and reflected sample to the A4 Visual/Aural Metering Board. The Visual/Aural Metering Board supplies reflected, visual and aural output power samples to the exciter/driver for metering purposes. The RF output for the translator is at J2 the 7/8" EIA connector on the A11 coupler assembly.

The LX Series power amplifier assembly is made up of the modules and assemblies listed in Table 2-1.

Table 2-1: LX Series Power Amplifier Assemblies

ASSEMBLY DESIGNATOR	ASSEMBLY NAME	PART NUMBER
	Chassis Assembly	CB001274
A3	Power Amplifier Assembly, 250 Watt	1302868
	Power Supply Assembly	1302893
A11	Coupler Assembly	
A4	Visual/Aural Metering Board	1265-1309

2.1.1 Power Amplifier Module Assembly, 250Watt (1302868; Appendix B)

two RF Module Pallets, Philips (1300116), and (A5) a 2-Way Combiner Board (1303208).

POWER AMPLIFIER MODULE	RF INPUT/OUTPUT:	470 - 880 MHz
	INPUT LEVEL:	+30dBm ±2dB PK SYNC
	INPUT RETURN LOSS:	-10dB
	OUTPUT LEVEL:	+55dBm (300W PK SYNC)
	POWER REQUIREMENTS	+32V @ 20A +12V @ 0.2A -12V @ 0.5A

The Power Amplifier Module contains Broadband LDMOS amplifiers that cover the entire UHF band with no tuning required. Each module amplifies the RF to a nominal 300W output power.

The Power Amplifier Module Assembly is made up of (A6) an Amplifier Control Board (1301962), (A1) a UHF Phase/Gain Board (1303213), (A2) a 150 Watt Driver Pallet Assembly (1303293), (A3 & A4)

The Power Amplifier assembly is used to amplify the RF output of the Translator/Exciter Driver. A cable, located on the rear chassis, connects the RF output from the Exciter/Driver at J25

to J200 the RF input to the PA Assembly. This module contains RF monitoring circuitry for both an analog and a digital system. Control and monitoring lines to the Power Amplifier module are routed through the floating blind-mate connector of the Control & Monitoring/Power Supply module.

The 100 Watt Translator/Exciter Driver Power Amplifier module and any External Amplifier modules contain the same control and monitoring board. This board monitors RF output power, RF reflected power, the current draw of amplifier sections, the supply voltage, and the temperature of the PA heat sink.

The RF power detector circuit outputs vary with operating frequency. These circuits must be calibrated at their intended operating frequency. Front panel adjustment potentiometers are used to calibrate the following:

Table 1: Power Amplifier Calibration Adjustments in Analog Systems

R201	Reflected Power Cal
R202	Forward Power Cal
R204	Meter Offset Zero

In analog systems, the Aural power of an Exciter Driver Power Amplifier and the Aural power of any external amplifier will not be reported by the system Control Monitoring module. Additionally the Visual power of these amplifiers, is reported as Forward Power just like in digital systems. In analog

systems, aural and visual power will only be reported for the final system RF output.

In digital systems, the Forward power of an Exciter Driver Power Amplifier and the Forward power of any external amplifier, is reported by the system Control Monitoring module.

If the Control Monitoring module is monitoring a 5-50 Watt Digital or 10-100 Watt Analog Translator, system power is measured in the Power Amplifier module. The wired connections are transferred through the power supply connector to the backplane board on a five position header. All four positions of control board switch SW1 must be set on to route these lines as the system's RF power signals. In systems of output power greater than 50 Watts digital or 100 Watts aural, system power is monitored by an external module that is connected to TB31 and control board SW1 switches must be set off.

The Forward Power of the Translator/Exciter Driver Power Amplifier module is routed to the Upconverter module as AGC #1. A system over-drive condition is detected when this value rises above 0.9 VDC. When an over-drive condition is detected, the Upconverter module reduces its RF output level. For values less than 0.9 VDC, the Upconverter uses this voltage for automatic gain.

Table 2-2. Power Amplifier Status Indicator

LED	FUNCTION
ENABLED (Green)	When lit Green, it indicates that the PA is in the Operate Mode. If a Mute occurs, the PA will remain Enabled, until the input signal is returned.
DC OK (Green)	When lit Green, it indicates that the fuse protected DC inputs to the PA module are OK.
TEMP (Green)	When lit Green, it indicates that the temperature of the heatsink assembly in the module is below 78 C.
MOD OK (Green)	When lit Green, it indicates that the PA Module is operating and has no faults.

Table 2-3. Power Amplifier Control Adjustments

POTENTIOMETERS	DESCRIPTION
RFL CAL	Adjusts the gain of the Reflected Power monitoring circuit
VISUAL CAL	Adjusts the gain of the Visual / Forward Power monitoring circuit
METER ZERO	Adjusts the offset of the Forward Power monitoring circuit

Table 2-4. Power Amplifier Sample

DISPLAY	FUNCTION
FWD SAMPLE	RF sample of the amplified signal being sent out the module on J25.

2.1.2 Power Supply Module Assembly, 1kW LX Series (1302863; Appendix B)

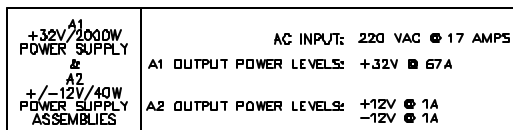

The Power Supply Module Assembly is made up of (A1) a +32V/2000W Switching Power Supply and (A2) a ±12V/40W Switching Power Supply.

The power supply module provides the +32 VDC and the +12 VDC and -12 VDC to the power amplifier module assembly.

2.1.3 Front Panel Display Screens

A 4 x 20 display located on the front of the Control & Monitoring/Power Supply Module is used in the LX Series translator for control of the operation and display of the operating parameters of the entire translator.

2.2 System Operation

When the translator is in operate, as set by the menu screen located on the Control & Monitoring Module in the exciter/driver assembly. The IF Processor will be enabled, the mute indicator on the front panel will be extinguished. The +32 VDC stage of the Power Supply in the Control & Monitoring Module is enabled, the operate indicator on the front panel is lit and the DC OK on the front panel should also be green. The enable and DC OK indicators on the PA Module will also be green.

When the translator is in standby. The IF Processor will be disabled, the mute indicator on the front panel will be red. The +32 VDC stage of the Power Supply in the Control & Monitoring Module is disabled, the operate indicator on the front panel will be extinguished and the DC OK on the front panel should remain green. The enable indicator on the PA Module is also extinguished.

If the translator does not switch to Operate when the operate menu is switched to Operate, check that all faults are cleared and that the remote control terminal block stand-by signal is not active.

The translator can be controlled by the presence of a modulated input signal. If the input signal to the translator is lost, the translator will automatically cutback and the input fault indicator on the IF Processor module will light. When the video input signal returns, the translator will automatically return to full power and the input fault indicator will be extinguished.

2.2.1 Principles of Operation

Operating Modes

This translator is either operating or in standby mode. The sections below discuss the characteristics of each of these modes.

Operate Mode

Operate mode is the normal mode for the translator when it is providing RF power output. To provide RF power to the output, the translator will not be in mute. Mute is a special case of the operate mode where the +32 VDC section of the power supply is enabled but there is no RF output power from the translator. This condition is the result of a fault condition that causes the firmware to hold the IF Processor module in a mute state.

Operate Mode with Mute Condition

The translator will remain in the operate mode but will be placed in mute when the following fault conditions exist in the translator.

- Upconverter is unlocked
- Upconverter module is not present
- IF Processor module is not present

- Modulator (if present) is in Aural/Visual Mute

Entering Operate Mode

Entering the operate mode can be initiated a few different ways by the translator control board. A list of the actions that cause the operate mode to be entered is given below:

- A low on the Remote Translator Operate line.
- User selects "OPR" using switches and menus of the front panel.
- Receipt of an "Operate CMD" over the serial interface.

There are several fault or interlock conditions that may exist in the translator that will prevent the translator from entering the operate mode. These conditions are:

- Power Amplifier heat sink temperature greater than 78 °C.
- Translator is Muted due to conditions listed above.
- Power Amplifier Interlock is high indicating that the amplifier is not installed.

Standby Mode

The standby mode in the translator indicates that the output amplifier of the translator is disabled.

Entering Standby Mode

Similar to the operate mode, the standby mode is entered using various means. These are:

- A low on the Remote Translator Stand-By line.
- Depressing the "STB" key on selected front panel menus.

- Receipt of a "Standby CMD" over the serial interface.

Operating Frequency

The LX Series translator controller is designed to operate on UHF and VHF frequencies. The exact output frequency of the translator can be set to one of the standard UHF frequencies, or it can be set to a custom frequency using software set-up menus. Since RF performance of the translator requires different hardware for different frequency bands, not all frequency configurations are valid for a specific translator. The Power detectors in the translator have frequency dependency,

therefore detectors of power amplifiers are calibrated at their frequency of use. The detectors for System RF monitoring are also calibrated at the desired frequency of use.

2.3 Customer Remote Connections

The remote monitoring and operation of the translator is provided through terminal blocks TB30 and TB31 located on the rear of the chassis assembly. If remote connections are made to the translator, they must be made through terminal blocks TB30 and TB31 at the positions noted on the translator interconnect drawing and Table 2-5.

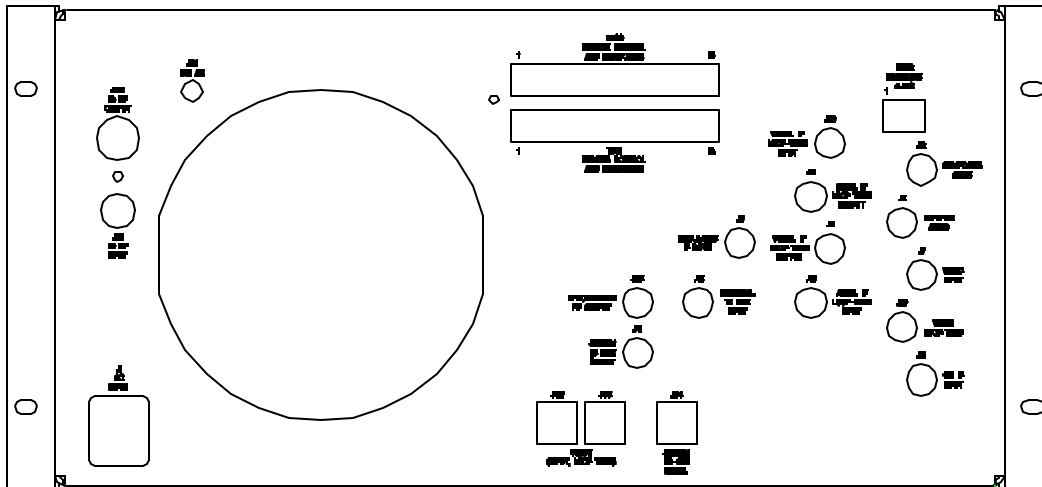

Table 2-5: LX Series Chassis Assembly Hard Wired Remote Interface Connections to TB30 or TB31, 18 pos. Terminal Blocks Located on the Rear of the Assembly

Signal Name	Pin Designations	Signal Type/Description
RMT Translator State	TB30-1	Discrete Open Collector Output - A low indicates that the translator is in the operate mode.
RMT Translator Interlock	TB30-2	Discrete Open Collector Output - A low indicated the translator is OK or completes an interlock daisy chain. When the translator is not faulted, the interlock circuit is completed.
RMT Translator Interlock Isolated Return	TB30-3	Ground - Configurable ground return which can be either jumpered directly to ground or it can be the "source" pin of an FET so that the translator interlock can be daisy chained with other translators. This signal does not directly interface to the microcontroller.

Signal Name	Pin Designations	Signal Type/Description
RMT AUX IO 1	TB30-4	Discrete Open Collector Inputs, Discrete Open Drain Outputs, or 0 - 5 VDC Analog Input - When used as an output, this line is pulled to +5 VDC with a 1.0 k Ω resistor for logic high and pulled to ground for a low. A diode allows this line to be pulled up to 12 VDC. When used as a digital input, this line considers all values over 2 Volts as high and those under 1 volt as low. As an analog input, this line is protected by a 5.1 zener diode.
RMT AUX IO 2	TB30-5	
RMT Translator Operate	TB30-6	Discrete Open Collector Input - A pull down to ground on this line indicates that the translator is to be placed into the operate mode.
RMT Translator Stand-By	TB30-7	Discrete Open Collector Input - A pull down to ground on this line indicates that the translator is to be placed into the standby mode.
RMT Power Raise	TB30-8	Discrete Open Collector Input - A pull down to ground on this line indicates that the translator power is to be raised.
RMT Power Lower	TB30-9	Discrete Open Collector Input - A pull down to ground on this line indicates that the translator power is to be lowered.
RMT System Reflect Power	TB30-10	Analog Output - 0 to 4.0 V- This is a buffered loop through of the calibrated "System Reflected Power " and indicates the translator's reflected output power. The scale factor is 25%/3.2V.
RMT System Visual/Forward Power	TB30-11	Analog Output - 0 to 4.0 V- This is a buffered loop through of the calibrated "System Visual/Avg. Power ". Indicates the translator's Visual / Average power. Scale factor is 100%/3.2V.
RMT System Aural Power	TB30-12	Analog Output - 0 to 4.0 V- This is a buffered loop through of the calibrated "System Aural Power ". Indicates the translator's forward Aural output power. The scale factor is 100%/3.2V.
RMT Spare 1	TB30-13	Remote connection to spare module - Use is TBD.
RMT Spare 2	TB30-14	Remote connection to spare module - Use is TBD.
System Reflect Power	TB31-13	Analog Input - 0 to 1.00 V- This is the input of the "System Reflected Power " indicating the translator's reflected output power. The scale factor is 25%/0.80V.
System Visual / Forward Power	TB31-14	Analog Input - 0 to 1.00 V- This is the input of the "System Visual / Forward Power " indicating the translator's forward Visual / Forward output power. The scale factor is 100%/0.80V.
System Aural Power	TB31-15	Analog Input - 0 to 1.00 V- This is the input of the "System Aural Power " indicating the translator's forward Aural output power. The scale factor is 100%/0.80V.
IF Processor IF Signal Select	TB31-3	Discrete Open Collector Input - A low indicates that the modulator IF source is to be used by the IF Processor module. When floating an analog IP Processor module may use the Modulated IF Input if the IF Processor sled is so configured.
IF Processor	TB31-4	Analog Output - 0 to 5.00 V- This is the input of IF

Signal Name	Pin Designations	Signal Type/Description
DLC Voltage		Processor module for digital system RF output power control.
UC AGC #2 Voltage	TB31-5	Auxiliary Analog Input - 0 to 1V- This voltage is used by the Upconverter for gain control. Linear signal with display resolution of 0.01 %. Primary signal source is J34-1.
RMT Ground	TB30-15, and 17	Ground pins available through Remote
RMT Ground	TB31-1, 2, 6 to 12, and 17	Ground pins available through Remote
RMT +12 VDC	TB30-16 TB31-16	+12 VDC available through Remote w/ 2 Amp re-settable fuse
RMT -12 VDC	TB30-18 TB31-18	-12 VDC available through Remote w/ 2 Amp re-settable fuse

Chapter 3

Site Considerations, Installation and Setup Procedures

There are special considerations that need to be taken into account before the LX Series Power Amplifier Assembly and exciter/driver assembly can be installed. For example, if the installation is completed during cool weather, a heat-related problem may not surface for many months, suddenly appearing during the heat of summer. This section provides planning information for the installation and set up of the translator.

3.1 Site Considerations

The translator requires an AC input line of 220 VAC @ 5 amps for the Driver Assembly and an AC line for each 500 Watt Amplifier Assembly of 220 VAC @ 17 amps maximum.

The LX Series Translators are designed and built to provide long life with a minimum of maintenance. The environment in which they are placed is important and certain precautions must be taken. The three greatest dangers to the translator are heat, dirt, and moisture. Heat is usually the greatest problem, followed by dirt, and then moisture. Over-temperature can cause heat-related problems such as thermal runaway and component failure. Each amplifier module in the translator contains a thermal interlock protection circuit that will shut down that module until the temperature drops to an acceptable level.

A suitable environment for the translator can enhance the overall performance and reliability of the translator and maximize revenues by minimizing downtime. A properly designed facility will have an adequate supply of cool, clean air, free of airborne particulates of any kind, and no excessive humidity. An ideal environment will require temperature in the range of 40° F to 70° F throughout the year, reasonably low humidity, and a dust-free

room. It should be noted that this is rarely if ever attainable in the real world. However, the closer the environment is to this design, the greater the operating capacity of the translator.

The fans are designed and built into the translator will remove the heat from within the modules, but additional means are required for removing this heat from the building. To achieve this, a few issues need to be resolved. The first step is to determine the amount of heat to be removed from the translator room. There are generally three sources of heat that must be considered. The first and most obvious is the heat from the translator itself. This amount can be determined for a 100W translator by subtracting the average power to the antenna (69.5 watts) from the AC input power (675 watts) and taking this number in watts (605.5) and then multiplying it by 3.41. This gives a result of 2,065, the BTUs to be removed every hour. 12,000 BTUs per hour equals one ton. Therefore, a 1/4-ton air conditioner will cool a 100W translator.

The second source of heat is other equipment in the same room. This number is calculated in the same way as the equation for BTUs. The third source of heat is equally obvious but not as simple to calculate. This is the heat coming through the walls, roof, and windows on a hot summer day. Unless the underside is exposed, the floor is usually not a problem. Determining this number is usually best left up to a qualified HVAC technician. There are far too many variables to even estimate this number without reviewing the detailed drawings of the site that show all of the construction details. The sum of these three sources is the bulk of the heat that must be removed. There may be other sources of heat, such as personnel, and all should be taken into account.

Now that the amount of heat that must be removed is known, the next step is to determine how to accomplish this. The options are air conditioning, ventilation, or a combination of the two. Air conditioning is always the preferred method and is the only way to create anything close to an ideal environment.

Ventilation will work quite well if the ambient air temperature is below 100° F, or about 38° C, and the humidity is kept at a reasonable level. In addition, the air stream must be adequately filtered to ensure that no airborne particulates of any kind will be carried into the translator. The combination of air conditioning for summer and ventilation during the cooler months is acceptable when the proper cooling cannot be obtained through the use of ventilation alone and using air conditioning throughout the year is not feasible.

Caution: The use of air conditioning and ventilation simultaneously is not recommended. This can cause condensation in the translators.

The following precautions should be observed regarding air conditioning systems:

1. Air conditioners have an ARI nominal cooling capacity rating. In selecting an air conditioner, do not assume that this number can be equated to the requirements of the site. Make certain that the contractor uses the actual conditions that are to be maintained at the site in determining the size of the air conditioning unit. With the desired conditioned room temperature under 80° F, the unit must be derated, possibly by a substantial amount.
2. Do not have the air conditioner blowing directly onto the translator. Under certain

conditions, condensation may occur on, or worse in, the translator.

3. Do not separate the front of the translator from the back with the thought of air conditioning only the front of the unit. Cooling air is drawn in at the front of all translators and in the front and back of others. Any attempt to separate the front of the translator from the rear of the unit will adversely affect the flow of cooling air.
4. Interlocking the translator with the air conditioner is recommended to keep the translator from operating without the necessary cooling.
5. The periodic cleaning of all filters is a must.

When using ventilation alone, the following general statements apply:

1. The blower, with attendant filters, should be on the inlet, thereby pressurizing the room and preventing dirt from entering the translator.
2. The inlet and outlet vents should be on the same side of the building, preferably the leeward side. As a result, the pressure differential created by wind will be minimized. Only the outlet vent may be released through the roof.
3. The inlet and outlet vents should be screened with 1/8-inch hardware cloth (preferred) or galvanized hardware cloth (acceptable).
4. Cooling air should enter the room as low as practical but in no case higher than four feet above the floor. The inlet must be located where dirt, leaves, snow, etc., will

-
- | | |
|--|--|
| <p>not be carried in with the cooling air.</p> <p>5. The exhaust should be located as high as possible. Some ducting is usually required to insure the complete flushing of heated air with no stagnant areas.</p> <p>6. The filter area must be large enough to insure a maximum air velocity of 300 feet per minute through the filter. This is not a conservative number but a never-exceed number. In a dusty or remote location, this number should be reduced to 150 CFM.</p> <p>7. The inlet and outlet(s) must have automatic dampers that close any time the ventilation blower is off.</p> <p>8. In those cases in which translators are regularly off for a portion of each day, a temperature-differential sensor that controls a small heater must be installed. This sensor will monitor inside and outside temperatures simultaneously. If the inside temperature falls to within 5° F of the outside temperature, the heater will come on. This will prevent condensation when the ventilation blower comes on and should be used even in the summer.</p> <p>9. A controlled-air bypass system must be installed to prevent the temperature in the room from falling below 40° F during translator operation.</p> <p>10. The blower should have two speeds, which are thermostatically controlled, and be interlocked with the translator.</p> <p>11. The blower on high speed must be capable of moving the required volume of air into a half inch of water pressure at the required</p> | <p>elevation. The free air delivery method must not be used.</p> <p>12. Regular maintenance of the filters, if used, can not be overemphasized.</p> <p>13. Above 4000 feet, for external venting, the air vent on the cabinet top must be increased to an 8-inch diameter for a 1-kW translator and to a 10-inch diameter for 5-kW and 6-kW translators. An equivalent rectangular duct may be used but, in all cases, the outlet must be increased by 50% through the outlet screen.</p> <p>14. It is recommended that a site plan be submitted to Axcera for comments before installation begins.</p> <p>In calculating the blower requirements, filter size, and exhaust size, if the total load is known in watts, 2000 CFM into ½ inch of water will be required for each 5000 watts. If the load is known in BTUs, 2000 CFM into ½inch of water will be required for each 17,000 BTUs. The inlet filter must be a minimum of seven square feet, larger for dusty and remote locations, for each 5000 watts or 17,000 BTUs. The exhaust must be at least four square feet at the exhaust screen for each 5000 watts or 17,000 BTUs.</p> <p>The information presented in this section is intended to serve only as a general guide and may need to be modified for unusually severe conditions. A combination of air conditioning and ventilation should not be difficult to design (see Figure 3-1).</p> <p>System interlocking and thermostat settings should be reviewed with Axcera. As with any equipment installation, it is always good practice to consult the manufacturer when questions arise. Axcera can be contacted at (724) 873-8100.</p> |
|--|--|
-

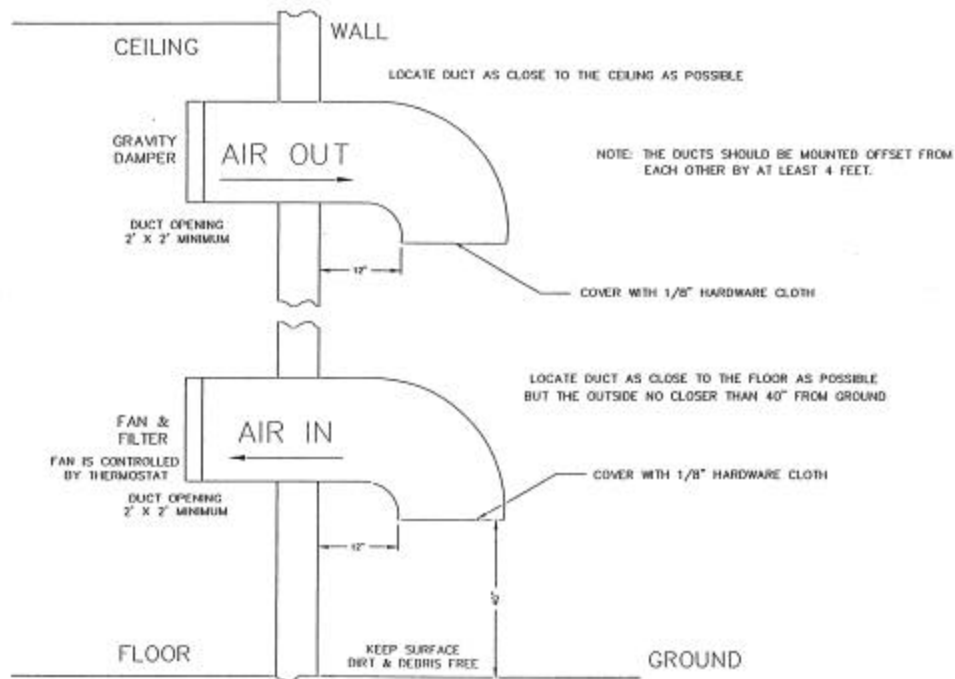

Figure 3-1. 1 kW Minimum Ventilation Configuration

3.2 Unpacking the Chassis w/modules, bandpass and optional trap filters

Thoroughly inspect the chassis with modules and all other materials upon their arrival. Axcera certifies that upon leaving our facility the equipment was undamaged and in proper working order. The shipping containers should be inspected for obvious damage that indicates rough handling.

Remove the chassis and modules, along with bandpass filter and optional trap filter, from the crates and boxes.

Check for dents and scratches or broken connectors, switches, display, or connectors. Any claims against in-transit damage should be directed to the carrier. Inform Axcera as to the extent of any damage as soon as possible.

The modules are mounted to the chassis assembly with slides that are on the top and the bottom of the modules. There

are two thumb screws on the front panel that hold each of the modules in place.

3.3 Installing the Chassis w/modules and filters

The exciter/driver and power amplifier chassis assemblies are made to mount in a standard 19" rack. The chassis assemblies mount using the four #10 clearance mounting holes on the ends. The chassis should be positioned; to provide adequate air intake into the front and the air exhaust of the fan in the rear; the ability to slide the modules out for replacement purposes; the installation of the bandpass filter; optional trap filter; the coupler assembly; and output transmission line. The chassis or cabinet in which it is mounted should be grounded using copper strapping material.

NOTE: To pull out any power amplifier module for replacement purposes, the input and output coaxial cables must first

be removed from the rear of the chassis assembly.

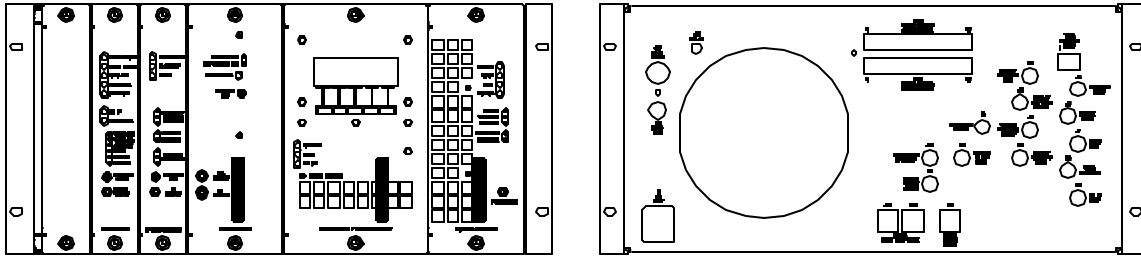

Figure 3-2. Front and Rear View Reconnection Drawing

Connect the transmission line for the antenna system to the output of the optional trap filter. A BNC sample jack of the output on the trap filter can be used for test purpose.

3.4 AC Input

The Driver Assembly requires one AC outlet in which to plug, of 220 VAC @ 5 amps and each 500 Watt power amplifier assembly needs one AC outlet in which to plug, of 220 VAC @ 17 amps maximum. One 500 Watt power amplifier assembly consists of two PA assemblies and one power supply assembly.

This completes the unpacking and installation of the LX Series UHF television translator. Refer to the setup and operation procedures that follow before applying power to the translator.

3.5 Setup and Operation

Initially, the translator should be turned on with the RF output at the directional coupler terminated into a dummy load of at least the rated power of the translator. If a load is not available, check that the output of the directional coupler is connected to the antenna for your system.

3.5.1 Input Connections

The input connections to the translator are to the rear of the exciter/driver chassis assembly for the translator or to the receiver tray in a translator.

Refer to the tables and description that follows for detailed information on the input connections.

Figure 3-3: Rear View of LX Series Translator

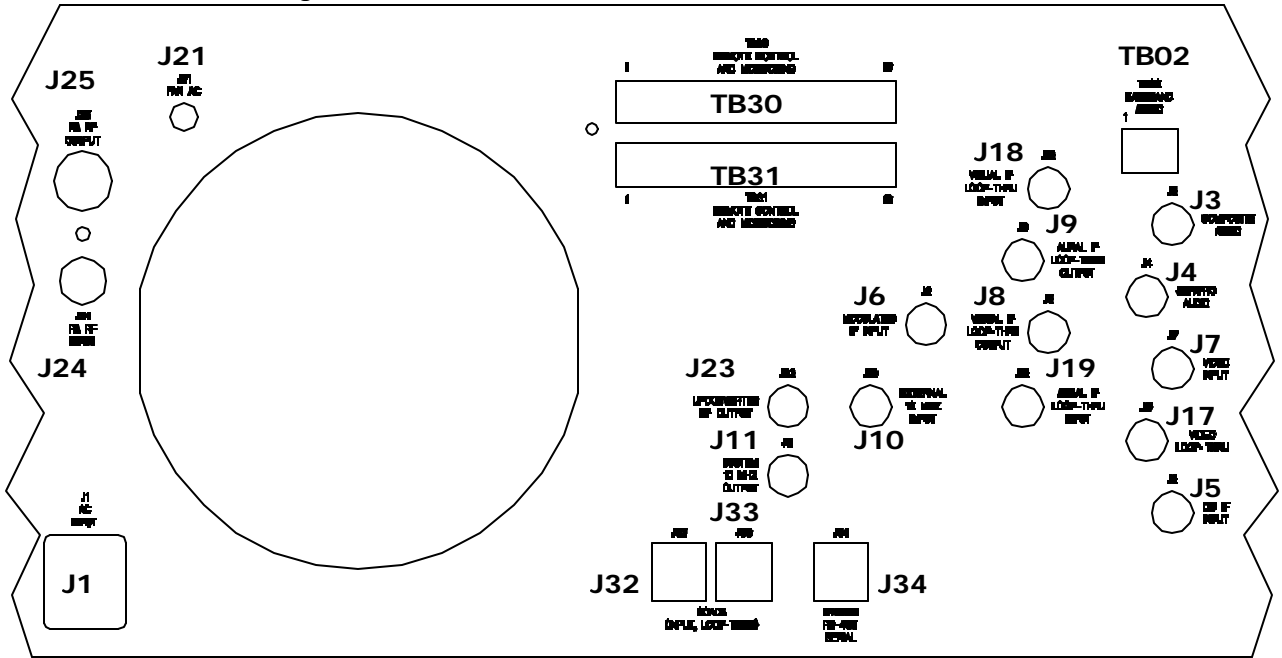

Table 3-1: Rear Chassis Connections for the LX Series Translator.

Port	Type	Function	Ohm
J1	IEC	AC Input	
TB02	Term	Base Band Audio Input	600
J3	BNC	Composite Audio Input	75
J4	BNC	SAP / PRO Audio Input	75
J5	BNC	CW IF Input	50
J6	BNC	Modulated IF Input	50
J7	BNC	Video Input (Isolated)	75
J8	BNC	Visual IF Loop-Thru Output	50
J9	BNC	Aural IF Loop-Thru Output	50
J10	BNC	10 MHz Reference Input	50
J11	BNC	10 MHz Reference Output	50
J17	BNC	Video Loop-Thru (Isolated)	75
J18	BNC	Visual IF Loop-Thru Input	50
J19	BNC	Aural IF Loop-Thru Input	50
J23	BNC	Upconverter RF Output	50
J24	BNC	Power Amplifier RF Input	50
J25	N	Power Amplifier RF Output	50
TB30	Term	Remote Control & Monitoring	
TB31	Term	Remote Control & Monitoring	
J32	RJ-45	SCADA (Input / Loop-Thru)	CAT5
J33	RJ-45	SCADA (Input / Loop-Thru)	CAT5
J34	RJ-45	System RS-485 Serial	CAT5

3.5.2 Front Panel Screens for the Exciter/Amplifier Chassis Assembly

A 4 x 20 display located on the front of the Control & Monitoring/Power Supply Module is used in the LX Series translator for control of the operation and display of the operating parameters of the translator. Below are the display screens for the system. The ↑ and ↓

characters are special characters used to navigate up or down through the menu screens. Display text flashes on discrete fault conditions for all screens that display a fault condition.

When the translator is in operate mode, the STB menu appears. When the translator is in standby mode, the OPR menu appears.

Display Menu Screens for the LX Series Translator

Table 3-2: Menu 01 - Splash Screen #1

A	X	C	E	R	A														
1	0	3		F	R	E	E	D	O	M		D	R	I	V	E			
L	A	W	R	E	N	C	E	,		P	A	.	1	5	0	5	5		
(7	2	4)		8	7	3	-	8	1	0	0						



This is the first of the two translator splash screens that is shown for the first few seconds after reset.

Table 3-3: Menu 02- Splash Screen #2

I	N	N	O	V	A	T	O	R		L	D	U	1	0	0	0	A	L	
C	O	D	E		V	E	R	S	I	O	N		1	.	0				
F	I	R	M	W	A	R	E					1	3	0	2	1	6	4	
S	C	A	D	A		A	D	D	R	E	S	S							5



This is the second of the two translator splash screens

Table 3-4: Menu 10 - Main Screen

	V	I	S	U	A	L		P	W	R		1	0	0	%				
	A	U	R	A	L			P	W	R		1	0	0	%				
	R	E	F	L	E	C	T	E	D		P	W	R	1	.	0	%		
↑																	S	T	B
	↓																		

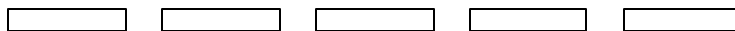

This is the default main screen of the translator. When the translator is in operate, the 'STB' characters appear allowing an operator to place the translator in STAND-BY. When the translator is in standby the 'STB' characters are replaced with 'OPR' and an operator can place the translator into OPERATE by pressing the right most switch on the front panel display. If the ↓ key is activated the system changes to Menu 11, go to Menu 11. If the ↑ key is activated the system displays to Menu 13, go to Menu 13.

Table 3-5: Menu 11 - Error List Access Screen

S	Y	S	T	E	M	E	R	R	O	R	S	6				
E	R	R	O	R	L	I	S	T	D	I	S	P	L	A	Y	
↑					↓				E	N	T			S	T	B

This screen of the translator shows the current number of errors and provides operator access to view the error list. This is the entry point to Menu 20. If ENT is pushed, go to Menu 20. If the ↓ key is activated the system changes to Menu 12, go to Menu 12. If the ↑ key is activated the system returns to Menu 10, go to Menu 10.

Table 3-6: Menu 12 - Translator Device Data Access Screen

T	R	A	N	S	M	I	T	T	E	R	D	E	T	A	I	L	S	
↑						↓					E	N	T			S	T	B

This screen of the translator allows access to various parameters of the translator system. This is the entry point to Menu 30. If ENT is pushed, go to Menu 30. If the ↓ key is activated the system changes to Menu 13, go to Menu 13. If the ↑ key is activated the system returns to Menu 11, go to Menu 11.

Table 3-7: Menu 13 - Translator Configuration Access Screen

T	R	A	N	S	M	I	T	T	E	R	S	E	T	-	U	P		
↑						↓					E	N	T			S	T	B

This screen of the translator allows access to various software setting of the translator system. This is the entry point to Menu 40. If ENT is pushed, go to Menu 40. If the ↓ key is activated the system returns to Menu 10, go to Menu 10. If the ↑ key is activated the system returns to Menu 12, go to Menu 12.

Table 3-8: Menu 20 - Error List Display Screen

S	Y	S	T	E	M	E	R	R	O	R	S	1 /	6					
U	P	C	O	N	V	E	R	T	E	R	M	O	D	U	L	E		
I	N	T	E	R	L	O	C	K	F	A	U	L	T					
↑						↓					C	L	R	E	S	C		

This screen of the translator allows access to system faults. Fault logging is stored in non-volatile memory. The translator's operating state can not be changed in this screen. The 'CLR' switch is used to clear previously detected faults that are no longer active. The ↑ key and ↓ key allow an operator to scroll through the list of system errors that have occurred. The ESC switch is used to leave this screen.

Table 3-9: Menu 30 - Translator Device Details Screen

S	Y	S	T	E	M	D	E	T	A	I	L	S				
X	M	T	R	I	N	O	P	E	R	A	T	E	M	O	D	E
P	O	W	E	R	S	U	P	P	L	Y	:	O	K			
↑					↓								E	S	C	

This screen of the translator allows access to the translator parameters of installed devices. The system is configured to know which devices are present. Current values for all installed devices are shown. If a module is not installed, only a "MODULE NOT PRESENT" message will be displayed. The ↑ and ↓ arrows scroll through the different parameters of each device as shown in table 3-11. Each System Component is a different screen. One IF Processor or the other will be programmed for your system. One Power Amplifier or the other will be programmed for your system. External Amplifier will only be used in high power translators.

Table 3-10: Menu 30-1 – System Details Screen

S	Y	S	T	E	M	D	E	T	A	I	L	S			
				0	%					0	%	0	.	0	%
V	I	S	U	A	L	A	U	R	U	A	L	R	E	F	L
↑					↓							E	S	C	

Table 3-11: Translator Device Parameters Detail Screens

System Component	Parameter	Normal	Faulted (Blinking)
Modulator Details	PLL CIRCUIT	LOCKED	UNLOCKED
	OUTPUT LEVEL	0 - 200 IRE	N/A
	AURAL DEVIATION	0 - 125 kHz	N/A
	CW INPUT	PRESENT	NOT USED
	STATION ID	SEND soft key	N/A
IF Processor Details (Analog Systems)	INPUT SIGNAL STATE	OK	FAULT
	MODULATION	OK	FAULT
	INPUT IF	MODULATOR or J6	N/A
	DLC LEVEL	0 - 5.00 V	N/A
	ALC LEVEL	0 - 5.00 V	N/A
	ALC MODE	AUTO or MANUAL	N/A
(OR) IF Processor Details (Digital Systems)	ALC LEVEL	0 - 5.00 V	N/A
	ALC MODE	AUTO or MANUAL	N/A
	DLC LEVEL	0 - 5.00 V	N/A
Upconverter Details	PLL CIRCUIT	LOCKED	FAULT
	AFC LEVEL	0 - 5.00 V	N/A
	AGC 1 LEVEL	0 - 5.00 V	N/A
	AGC 2 LEVEL	0 - 5.00 V	N/A
	EX. 10 MHz	PRESENT or NOT USED	N/A
	LO FREQ	xxx.xxx MHz	N/A
Driver PA Details	POWER SUPPLY STATE	ON or OFF	N/A
	±12V SUPPLY	OK or OFF	FAULT

System Component	Parameter	Normal	Faulted (Blinking)
	FORWARD POWER	xxx%	xxx%
	REFLECTED POWER	xxx%	xxx%
	AMP 1 CURRENT	xx.xA	xx.xA
	AMP 2 CURRENT	xx.xA	xx.xA
	TEMPERATURE	xxC	xxC
	CODE VERSION	x.x	N/A
Ext. Power Amplifier Modules Details (Only in high power systems)	POWER SUPPLY STATE	ON or OFF	N/A
	±12V SUPPLY	OK or OFF	FAULT
	FORWARD POWER	xxx%	xxx%
	REFLECTED POWER	xxx%	xxx%
	AMP CURRENT 1	xx.xA	xx.xA
	AMP CURRENT 2	xx.xA	xx.xA
	AMP CURRENT 3	xx.xA	xx.xA
	AMP TEMPERATURE	xxC	xxC
CODE VERSION	x.x	N/A	

Table 3-12: Menu 40 - Translator Set-up: Power Raise/Lower Screen

T R A N S M I T T E R S E T - U P				
0 1	P O W E R R A I S E / L O W E R			
	S E T T I N G		1 0 0 %	
↑	↓	(+)	E S C	(-)
<input type="text"/>	<input type="text"/>	<input type="text"/>	<input type="text"/>	<input type="text"/>

This screen of the translator is the first of several that allows access to translator set-up parameters. When + is selected, the Power will increase. When - is selected, the Power will decrease.

Table 3-13: Menu 40-1 - Translator Set-up: Model Select Screen

T R A N S M I T T E R S E T - U P				
0 2	T R A N S M I T T E R M O D E L			
	N U M B E R		L U 0 1 0 0 A T	
↑	↓	(+)	E S C	(-)
<input type="text"/>	<input type="text"/>	<input type="text"/>	<input type="text"/>	<input type="text"/>

This screen is used to specify which components are expected to be part of the system. By specifying the model number, the translator control firmware knows which components should be installed and it will be able to display faults for components that are not properly responding to system commands.

Table 3-14: Menu 40-2 - Translator Set-up: Frequency Select Screen

T	R	A	N	S	M	I	T	T	E	R	S	E	T	-	U	P
0	3	F	R	E	Q	U	E	N	C	Y	S	E	L	E	C	T
		T	A	B	L	E	O	R	C	U	S	T	O	M		
↑		↓		(+)	E	S	C		(-)			

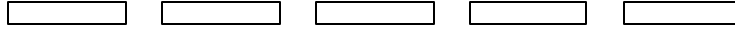

This screen of the translator is allows access to translator frequency set-up parameters. The choices of this screen are 'TABLE' or 'CUSTOM'. When table is selected, the next menu will be used to select the desired operating frequency. When custom is selected, the next menu is used to select a specific operating frequency.

Table 3-15: Menu 40-3 - Translator Set-up: Frequency Table Select Screen

T	R	A	N	S	M	I	T	T	E	R	S	E	T	-	U	P
0	3	F	R	E	Q	U	E	N	C	Y	S	E	L	E	C	T
		C	H	2	0	5	0	6	-	5	1	2	M	H	Z	
↑		↓		(+)	E	S	C		(-)			

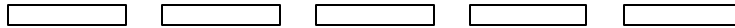

The choices of this screen are from the standard UHF / VHF tables. + and - change the desired value of the translator. Any change to frequency is immediately set to the LO / Upconverter Frequency Synthesizer PLL circuit.

Table 3-16: Menu 40-4 - Translator Set-up: IF Frequency Screen

T	R	A	N	S	M	I	T	T	E	R	S	E	T	-	U	P
0	3	I	F	F	R	E	Q	U	E	N	C	Y				
		I	N	P	U	T	4	4	.	0	0	M	H	Z		
↑		↓		(+)	E	S	C							

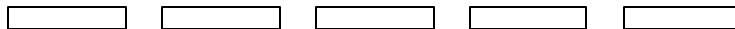

This screen is used to specify the IF Input frequency. This value plus the desired channel value is used to calculated the desired LO frequency. + is used to increase the selected value from 0 to 9. The > key is used to select from each of the different fields that make up the desired frequency. Any change to frequency is immediately set to the LO / Upconverter Frequency Synthesizer PLL circuit.

Table 3-17: Menu 40-5 - Translator Set-up: Custom Frequency Select Screen

T	R	A	N	S	M	I	T	T	E	R	S	E	T	-	U	P
0	3	F	R	E	Q	U	E	N	C	Y	S	E	L	E	C	T
				0	5	0	9	.	0	0	0	M	H	Z		
↑		↓		(+)	E	S	C		(-)			

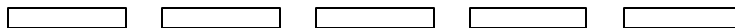

This screen is used to specify the operating frequency to an exact value. + is used to increase the selected value from 0 to 9. The > key is used to select from each of the different fields that make up the desired frequency. Any change to frequency is immediately set to the LO / Upconverter Frequency Synthesizer PLL circuit.

Table 3-18: Menu 40-6 - Translator Set-up: Serial Address Screen

T	R	A	N	S	M	I	T	T	E	R	S	E	T	-	U	P
0	4	S	E	R	I	A	L	A	D	D	R	E	S	S	5	
↑																

This screen allows the user to set the serial address of the translator. The default address is 5. This value and all other set-up parameters, are stored in non-volatile memory.

Table 3-19: Menu 40-7 - Translator Set-up: Station ID Screen

T	R	A	N	S	M	I	T	T	E	R	S	E	T	-	U	P
0	5	M	O	D	U	L	A	T	E	D	S	I	G	N	A	L
		S	T	A	T	I	O	N	I	D	0	0	0	0	0	0
↑																

This screen allows the user to set the serial address of the translator. The default address is 5. This value and all other set-up parameters, are stored in non-volatile memory.

Table 3-20: Menu 40-8 - Translator Set-up: System Visual Power Calibration

T	R	A	N	S	M	I	T	T	E	R	S	E	T	-	U	P
0	6	S	Y	S	T	E	M	C	A	L	I	B	R	A	T	E
		V	I	S	U	A	L	P	O	W	E	R	1	0	0	%
↑																

This screen is used to adjust the calibration of the system's visual power. A symbol placed under the '6' character is used to show minor changes in the calibration value. When the calibration value is at full value, the character will be full black. As the value decreases, the character pixels are gradually turned off.

Table 3-21: Menu 40-9 - Translator Set-up: System Aural Power Calibration

T	R	A	N	S	M	I	T	T	E	R	S	E	T	-	U	P
0	6	S	Y	S	T	E	M	C	A	L	I	B	R	A	T	E
		A	U	R	A	L	P	W	R							
↑																

This screen is used to adjust the calibration of the system's aural forward power. A symbol as on the previous screen is under the '6' character on this screen.

Table 3-22: Menu 40-10 - Translator Set-up: System Reflected Power Calibration

T R A N S M I T T E R S E T - U P				
0 6	S Y S T E M		C A L I B R A T E	
	R E F L E C T	P W R	X . X %	
↑	↓	(+)	E S C	(-)
<input type="text"/>	<input type="text"/>	<input type="text"/>	<input type="text"/>	<input type="text"/>

This screen is used to adjust the calibration of the system's reflected power.

Table 3-23: Menu 40-11 - Translator Set-up: Forward Power Fault Threshold Screen

T R A N S M I T T E R S E T - U P				
0 7	M I N I M U M		F O R W A R D	
	P O W E R	F A U L T	5 0 %	
↑	↓	(+)	E S C	(-)
<input type="text"/>	<input type="text"/>	<input type="text"/>	<input type="text"/>	<input type="text"/>

This screen is used to set the minimum forward power fault threshold. When the translator is operating, it must operate above this value otherwise the system will shut down with fault for 5 minutes. If after five minutes the fault is not fixed, the translator will enable, measure power less than this value and again shut down for five minutes.

Table 3-24: Menu 40-12 - Translator Set-up: Reflected Power Fault Threshold

T R A N S M I T T E R S E T - U P				
0 8	M A X I M U M		R E F L E C T E D	
	P O W E R	F A U L T	1 0 %	
↑	↓	(+)	E S C	(-)
<input type="text"/>	<input type="text"/>	<input type="text"/>	<input type="text"/>	<input type="text"/>

This screen is used to set the maximum reflected power fault threshold. When the translator is operating, it must not operate above this value otherwise the system will shut down with fault for 5 minutes. If after five minutes the fault is not fixed, the translator will enable, measure power above this value and again shut down for five minutes.

Table 3-25: Menu 40-13 - Translator Set-up: Remote Commands Control

T R A N S M I T T E R S E T - U P				
0 9	R E M O T E		C O N T R O L	
	C O M M A N D S		A C C E P T E D	
↑	↓	(+)	E S C	(-)
<input type="text"/>	<input type="text"/>	<input type="text"/>	<input type="text"/>	<input type="text"/>

This screen is used to allow or deny the use of remote control commands. When disabled, remote commands are not used. Remote commands are commands received either through the rear terminal blocks or through serial messages.

This completes the description of the screens for the LX Series exciter/amplifier chassis assembly.

If the translator is already connected to the antenna, check that the output is 100%. If necessary, adjust the

amplifier power detection circuitry or LO / Upconverter AGC settings. The power raise / lower settings are only to be used for temporary reductions in power. The power set-back values do not directly correspond to the power of the translator. Setting for 50% output

sets a linear circuit voltage that is controlling a non-linear power circuit.

If a problem occurred during the setup and operation procedures, refer to Chapter 5, Detailed Alignment Procedures, of this manual for more information.

3.5.3 Initial Turn On

Once the unit has been installed and all connections have been made, the process of turning on the equipment can begin. First verify that AC power is present and connected to the translator. Verify all cables are properly connected and are the correct type. Once all of these things are done, the unit is ready to be turned on following the procedures below.

Turn on the main AC power source that supplies the AC to the translator. Check that the AC power plug is connected to J1 on the rear of the chassis assembly.

Monitor the LCD display located on the front of the control/monitoring module as you proceed through this section. When the translator is in the operate mode, the STB menu appears. When in the standby mode, the OPR menu appears. Press the NXT key after each menu to continue through the sequence.

MODULATOR MODULE LEDs ON FRONT PANEL

Fault Indicators:

AUR UNLOCK: This illuminates Red when the Aural IF PLL is unlocked.

VIS UNLOCK: This illuminates RED when the Visual IF PLL is unlocked.

AUD OV DEV: This indicator will illuminate Red when the audio over-deviates the aural carrier.

VIDEO LOSS: This indicates the loss of Video to the modulator, when Red.

OVER MOD: This illuminates Red when the video is overmodulated.

Status Indicators:

ALT IF CW: This indicates that there is an external IF CW signal applied to the Modulator

10MHz PRES: This indicates the presence of a 10 MHz reference input.

IF PROCESSOR MODULE LEDs ON FRONT PANEL

Fault Indicators:

INPUT FAULT: This illuminates Red if the input to the module is missing or low.

ALC FAULT: This illuminates RED when the needed ALC value to maintain the output level is beyond the range of the circuitry.

MUTE: This indicator will illuminate Red when the translator is muted.

UPCONVERTER MODULE LED ON FRONT PANEL

Fault Indicator:

AGC CUTBACK- This illuminates Red if the required gain to produce the desired output level is beyond the value set by the AGC Cutback circuit.

CONTROLLER MODULE LEDs ON FRONT PANEL

Status Indicators:

OPERATE - This illuminates Green when translator is in operate.

FAULT - This illuminates Red when a fault has occurred in the translator.

DC OK - This illuminates Green when the DC outputs that connect to the modules in the translator are present.

**POWER AMPLIFIER MODULE LEDs
ON FRONT PANEL**

Status Indicators:

ENABLED - This illuminates Green when the PA is in operate.

DC OK - This illuminates Green when the DC inputs to the PA module are present.

TEMP - This illuminates Green when the temperature of the heatsink in the PA is below 78°C.

MOD OK - This illuminates Green when the PA module is operating and has no faults.

This completes the Installation, Set Up and Turn On of the Translator.

Chapter 4 Circuit Descriptions

The RF from the exciter/driver assembly connects from the RF Output "N" Jack J25, through a RG-55 cable, to the PA RF Input SMA Jack J200, located on the rear of the PA chassis assembly. The RF Input is cabled through UT-141 to port J111 on the main chassis. Jack J1 on the PA module assembly connects to the J111 port when the module assembly is slid into place.

The RF output from the 2 way UHF combiner connects to the PA RF Output Jack J2, located on the rear of the PA Module. Jack J2 on the PA module connects to the J115 port, on the main chassis assembly, when the module assembly is slid into place.

4.1 (A4) Power Amplifier Module Assembly (1302868; Appendix B)

The Power Amplifier Module Assembly contains (A1) a UHF Phase/Gain Board (1303213), (A2) a 150W Driver Pallet, Dual Output (1303293), (A3 & A4) UHF RF Module Pallet Assemblies (1300116), (A5) a 2 Way UHF Combiner Assembly (1303208), (A6) an Amplifier Control Board (1301962) and (A7) a Temperature Sensor IC.

4.1.1 (A1) UHF Phase/Gain Board (1303213; Appendix B)

The RF input from J1 on the PA assembly connects to J1 on the Phase/Gain Board. The UHF phase/gain board provides the circuits that adjust the gain and the phase of the RF signal for the PA amplifier assembly in which it is mounted. The input signal connects to the gain circuit through the capacitor C13. The gain circuit consists of U1, R16, CR4, R22, R17, CR5, R23, R27 and the gain pot, R25. U1 is a 90°, 2-way splitter. The signal at pin 1 of U1 is split and applied to pins 3 and 4. The signal reflects off CR4 and CR5 and is passed to

pin 2. The gain between pins 1 and 2 changes with the voltage applied across CR4 and CR5. This voltage is controlled by the gain-adjust pot R25. The more positive the voltage, the more the diodes CR4 and CR5 conduct therefore the less gain through the circuit. The gain controlled output is coupled through C14 and the pi-type divider circuit consisting of R8, R5 and R9 that drops the level before it is applied to the phase-shifter circuit.

The level controlled signal connects to the phase-shifter circuit that consists of U2, C20, C21, CR2, and CR3. U2 is a 90°, 2-way splitter. The signal at pin 1 of U2 is split and applied to pins 3 and 4. The signal reflects off CR2 and CR3 and is passed to pin 2. The phase shift between pins 1 and 2 changes with the voltage applied across CR2 and CR3. This voltage is controlled by the phase-adjust pot R24 through R26, R18 and R19. +12 VDC from an external switching power supply is applied to J3 on the board and is used as the reference that is applied to the phase-control pot. The gain and phase controlled output connects to J2 on the board.

4.1.2 (A2) 150 Watt Driver Pallet Assembly, Dual Output (1303293; Appendix B)

The output of the Phase/Gain Board is connected to the input J1 of (A2) the 150 Watt UHF amplifier assembly. The assembly contains a 150 Watt CW UHF Driver Board, Dual Output (1303169).

4.1.3 150 Watt Driver, Dual Output (1303169; Appendix B)

The board operates class AB and is a highly linear broadband amplifier for the frequency range of 470 to 860 MHz. It can deliver an output power of 150 watts (CW) with approximately 14 dB of gain.

The amplification circuit consists of LDMOS transistors Q1 and Q2 connected in parallel and operating class AB. The paralleling network is achieved with the aid of 3 dB couplers U3 and U4. The quiescent current settings are achieved by means of potentiometers R6 and R10. C39 and C38 are adjusted for best response. The settings are factory implemented and should not be altered.

PIN diode VR1 is a variable-damping circuit that is used to adjust the amplification of the module. The adjustment is performed with the Gain potentiometers R10 and R6. A readjustment of the amplification may be required, after repair work, to ensure that the PAs in multiple PA translators deliver the same output power.

4.1.4 (A3 & A4) UHF Module Assembly, RF Module Pallet, Philips (1300116; Appendix B)

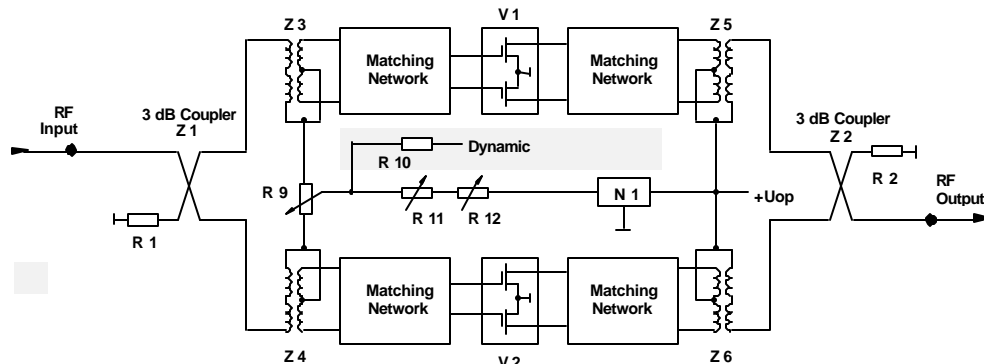

Figure 4-1. UHF Amplifier Module, 250 Watts

4.1.5 (A5) 2 Way UHF Combiner Assembly (1303208; Appendix B)

The 2 Way UHF combiner board assembly combines the two outputs of the UHF Module Assemblies and also provides forward and reflected power samples of the output to (A6) the amplifier control board where it connects to the input of the overdrive-protection circuit.

The RF inputs to the 2 way UHF combiner assembly, from the UHF amplifier modules, are soldered to the external connection points J3 and J4. The RF is

The UHF Module Assembly, 250-watt module (Figure 4-1) is a broadband amplifier for the frequency range 470 to 860 MHz. The amplifier is capable of delivering an output power of $70 W_{\text{rms}}$. The amplification is approximately 13 dB.

The amplification circuit consists of the parallel connected push-pull amplifier blocks V1 and V2 operating in class AB. In order to match the transistor impedance to the characteristic impedance of the input and output sides, matching networks are placed ahead and behind the amplifier blocks. Transformers Z3 to Z6 serve to balance the input and output signals. The paralleling circuit is achieved with the aid of 3-dB couplers Z1 and Z2.

The working point setting is factory implemented by means of potentiometers R9, R11, and R12 and should not be altered.

combined by the stripline tracks and R5 a 100 ohm matching resistor across the two inputs, to the RF Output solder connection point at J5. A hybrid-coupler circuit picks off a power sample that is connected to SMA type connector jack J1 as the forward power sample. Another power sample is taken from the coupler circuit that is connected to SMA type connector jack J2 as the reflected power sample. Two 50Ω terminations, created from two 100 ohm resistors in parallel, used as dissipation loads, connect from the forward and reflected ports to ground.

4.1.6 (A5) Amplifier Control Board (1301962; Appendix B)

The amplifier control board provides LED fault and enable indications on the front panel of the module and also performs the following functions: overdrive cutback, when the drive level reaches the amount needed to attain 110% output power; and overtemperature, VSWR, and overdrive faults. The board also provides connections to the LCD Display for monitoring the % Reflected Power, % Output Power, and the power supply voltage.

Page 1

U4, located upper center of page, is an in circuit microcontroller. The controller is operated at the frequency of 3.6864 MHz using crystal Y1. Programming of this device is performed through the serial programming port J2. U4 selects the desired analog channel of U1 through the settings of PA0-PA3. The outputs of Port A must be set and not changed during an analog input read of channels PA5-PA7. PA4 of U4 is a processor operating LED that monitors the +/- 12 VDC. PA5 is used to monitor the +12VDC supply to the board. PA6 is the selected channel of analog switch U1. PA7 is connected to a via, V10, for future access.

U6 is a serial to RS-485 driver IC. U7 is a watchdog IC used to hold the microprocessor in reset, if the supply voltage is less than 4.21 VDC. U7 momentarily resets the microcontroller if Pin 6 (!ST) is not clocked every second. A manual reset switch is provided but should not be needed.

Upper left corner U3 is used to determine where the amplifier control board is located. The eight inputs come from the main amp connector and are used to set the SCADA address of the controller. Pull-up resistors set a default condition of logic high.

U5 below U3 is used for getting digital input information of the board. Page two has several monitoring circuits that provide information on the amplifier's status. Many of these circuits automatically shut down the amplifier if a specific fault occurs.

U8 below U5 is used to control four board mounted status LEDs. A FET is turned On to shunt current away from the LED to turn it Off. U9 below U8 is used to enable different features within the software. Actual use is to be determined.

Page 2

In the lower right corner are voltage regulator circuits. U22 should allow for 0.14 amps of power using its 92 C/W rating if $T_a = 60^\circ\text{C}$ max and $T_j = 125^\circ\text{C}$ max. 0.26 amps can be obtained from U22 if the mounting pad is 0.5 square inches. The controller will not need this much current.

U23 and U24 are low drop out +5 VDC, voltage regulators with a tolerance greater than or equal to 1%. 100mA of current is available from each device but again the controller will not need this much current.

In the upper left section are circuits with U12 and U13. U12 is used to generate a regulated voltage that is about 5 volts less than the +32 VDC supply, approximately +26.25 VDC. When the +32 VDC supply is enabled, the circuitry around U13B is used to provide gate voltage to Q10 that is 5 volts greater than the source pin of this FET. The gate of Q10 can be turned Off by any one of a few different circuits.

U10A is used to turn Off the gate of Q10 in the event of high current in amplifier #1. At 0.886 VDC the current to amplifier #1 should be greater than 5 Amps. U11B is used to turn off the Q10 FET, if high current is detected in amplifier #2. U11A is used to turn off the Q10 FET, if high current is detected in amplifier #3. With 2.257 VDC at Pin 5 of U11B or Pin 3 of U11A, the voltage output of current sense

amplifier U17 or U18 at high current shut down should be greater than 15 Amps.

U14B is used to turn Off the gate of Q10 in the event of high power supply voltage, approximately +35.4 VDC. U14A is used to keep the FET disabled in the event of low power supply voltage, approximately +25.4 VDC.

Current monitoring sections of the board.

The ICs U16, U17 and U18 along with associated components set up the current monitoring sections of the board. R67, R68 and R69 are 0.01Ω/5W 1% through hole resistor is used for monitoring the current through several sections of the amplifier. The voltage developed across these resistors are amplified for current monitoring by U16, U17 or U18. The LT1787HVCS8 precision high side current sense IC amplifier accepts a maximum voltage of 60 VDC. The 43.2 kΩ resistor from pin 5 to ground sets the gain of the amplifier to about 17.28. This value is not set with much accuracy since the manufacturer internally matches the resistors of this part but their actual resistance value is not closely defined. A trimming resistor is suggested to give a temperature stability of -200 ppm/C, but instead the microcontroller will determine the exact gain of the circuit and use a correction factor for measurements. Circuit loading components are located in the lower portion of each current monitoring circuit. These components allow for short duration high current loading of the supply. By measuring the current through the sense resistor with and without the additional four 30.1 Ω 1% resistors. For very short duration pulses, a 1206 resistor can handle up to 60 watts. The processor requires 226 uSec per conversion. A supply voltage of +32 VDC will pass 1.06 amps + 1% through the load resistors.

A6 is a temperature sensor thermistor that is used to monitor the temperature of the module's heat sink. It connects

to J6 pins 1 & 2 on the board wand is wired to the comparator IC U10B. If the temperature increases above 75°C the output will go Low that is used as a temperature fault output, which generates a Fault alert at U15A and disables Amplifier #1.

Aural, Visual/Average and Reflected power detector sections of the board.

Page 3

A Forward Power Sample enters the board at SMA Jack J3 and is split. One part connects to J4 on the board that is cabled to J1, the SMA Forward Power Sample Jack, located on the front panel of the assembly. The other part of the split forward power sample is detected by CR17 and the DC level amplified by U25A. The output of U25A at pin 1 is split with one part connected to the Aural Power sample, which is not used in this digital translator. The other split output connects to U265A that is part of the Forward Average Power circuit. The detected level is connected to L4 that is part of an intercarrier notch filter circuit that is tuned to eliminate the 4.5 MHz aural intercarrier, if present. The Average power sample is amplified by U26D and connected through the average calibration pot R166 to U26C. The output of U26C is connected to the comparator IC U26B that has Aural Null and Offset Null, if present in the system, connected to the other input. The output Average Forward power level connects to J9 pin 2 of the board.

A Reflected Power Sample enters the board at SMA Jack J5 and is detected by CR20 and the DC level amplified by U28B. The output of U28B at pin 7 is connected through the reflected calibration pot R163 to U28C. The output is split with one part connected to J9 pin 5, the Reflected Power Output level of the board. The other part of the split from U28C connects to the comparator IC U28D that has a reference level connected to the other input. If the reflected level increases above the reference level a low output is produced

and connected to the Reflected Power Shutdown circuit at CR28. The low shuts off Q14 causing pin 3 to go high that is connected to the inverter U15C. The output of U15C goes low producing a Reflected Power Fault that is connected to an output of the board, the Fault Alert circuit and also shuts down Amplifier #1.

Gain of the power measurements is completed through software. Only the Aural Null and Offset Null need to be done through front panel pots.

4.2 Power Supply Assembly (1302863; Appendix B)

The Power Supply Assembly contains (A1) a +32V/2000W switching power supply (1301504) and (A2) a ± 12 V/40W switching power supply (1303242). The +32VDC connects through J1 (+32VDC) and J2 (RTN) to the rest of the amplifier assembly. The +/-12VDC outputs, the +32VDC control lines and the 220VAC connect to the assembly through Jack J3.

Both power supplies contain no customer adjustments.

This completes the description of the Power Amplifier Module Assembly and the Power Supply Assembly.

Chapter 5

Detailed Alignment Procedures

This Power Amplifier Assembly along with the translator was aligned at the factory and should not require additional adjustments to achieve normal operation.

This translator takes the baseband audio and video inputs or, if the (Optional) 4.5-MHz composite input kit is purchased, either a single composite video + 4.5-MHz input or separate baseband video and audio inputs, and converts them to the desired UHF On Channel RF Output at the systems output power level.

The power amplifier assembly of the Innovator LX Series translator is of a Modular design and when a Module fails that module needs to be changed out with a replacement module. The failed module can then be sent back to Axcera for repair. Contact Axcera Customer Service Department at 724-873-8100 or fax to 724-873-8105, before sending in any module.

5.1 Module Replacement

Module replacement on the LX Series products is a relatively simple process. The power supply and power amplifier modules, plug into a blind mating connector located on the chassis. To replace a module, refer to the following procedure.

Loosen the two grip lock connectors, located on the front panel, at the top and bottom of the module, counterclockwise until the module releases. There are two cables connected to the rear of the Power Amplifier Module. These two cables must first be removed before the PA module will slide out.

After removal of the failed module, slide the replacement module in place and make certain it connects to the blind mate connector. Replace the two cables

on the rear of the chassis assembly. If the replacement module does not slide in easily, verify it is properly aligned in the nylon tracks, located on both the top and bottom of the module.

Note: Each Module has an assigned slot and will not fit properly in the incorrect slot. Do not try to place a Module in the wrong slot as this may damage the slot or the blind mate connectors.

5.1.1 Initial Test Set Up

Check that the RF output at the coupler is terminated into a dummy load of at least the rated output of the system. While performing the alignment, refer to the Test Data Sheet for the translator and compare the final readings from the factory with the readings on each of the modules. The readings should be very similar. If a reading is way off, the problem is likely to be in that module.

Switch On the main AC for the system.

5.2 Innovator LX Series Exciter/Amplifier Chassis Assembly

This translator operates using the baseband audio and video inputs or, if the (optional) 4.5-MHz composite input kit is purchased, either a single composite video + 4.5-MHz input or separate baseband video and audio inputs.

On the LCD Display, located on the Controller/Power Supply Module, in Translator Set-Up, push the button to switch the translator to Operate. The check of and the setup of the Audio and Video input levels are completed using the LCD Display and the front panel adjustments on the Modulator assembly. The level of the RF output includes adjustments of the drive level to the Power Amplifier and the adjustment of

the linearity and phase predistortion to compensate for any nonlinear response of the Power Amplifier. The adjustments are located on the front panel of the IF Processor module.

Modulator Module Assembly

Note: The Modulator Assembly is not present in a translator system.

The Modulator Assembly has adjustments for video levels and audio modulation levels, and other related parameters.

Connect an NTSC baseband video test signal input (1 Vpk-pk) to the translator video input jack J7 on the rear of the tray. Jacks J7 and J17 are loop-through connected; the J17 jack can be used as a video source for another translator. Connect a baseband audio input (+10 dBm) to the balanced audio input terminal block TB02-1 [+], TB02-2 [-], and TB02-3 [ground] or, if stereo/composite audio is provided, connect it to BNC jack J3, the composite audio input jack.

Verify that all LEDs located on the front panel of the Modulator are Green. The following details the meaning of each LED:

AURAL UNLOCK (DS5) – Red Indicates that 4.5 MHz Aural IF is unlocked from the 45.75 MHz visual IF.

VISUAL UNLOCK (DS6) – Red Indicates that the 45.75 MHz visual IF is unlocked from the 10 MHz reference.

AUDIO OVER DEVIATION (DS4) – Red Indicates that the input Audio level is too high.

VIDEO LOSS (DS1) – Red Indicates that the input Video level is too low.

OVER MODULATION (DS3) – Red Indicates that the input Video level is too high.

ALTERNATE IF (DS7) – Red Indicates that an external 45.75 MHz IF is not present to the modulator.

10 MHz PRESENT (DS2) – Red Indicates that an external 10 MHz reference is not present to the modulator.

Look at the front panel LCD meter on the Control/Power Supply Module Assembly. Set the LCD screen to the Modulator Details video output level screen, the screen indicates active video from 0 to 1 Vpk-pk. The normal video input level is 1 Vpk-pk on the front panel screen. If this reading is not at the proper level, the overall video level can be changed by adjusting the VIDEO LEVEL control R42 on the front panel of the Modulator to the 1 Vpk-pk level on the front panel screen.

Switch the LCD display to the Modulator Details screen that indicates the AUDIO DEVIATION (modulation level) of the signal from 0 to 100 kHz.

MONO SET UP: The modulator was factory set for a ± 25 -kHz deviation with a mono, balanced, audio input of +10 dBm. If the reading is not at the correct level, adjust the MONO Audio Gain pot R110, located on the front panel of the modulator, as necessary, to attain the ± 25 -kHz deviation on the front panel screen.

STEREO SET UP: The modulator was factory set for a ± 75 -kHz deviation with a stereo, composite, audio input of 1 Vpk-pk. If this reading is not correct, adjust the STEREO Audio Gain pot R132, located on the front panel of the modulator, as necessary, for the ± 75 -kHz deviation.

SECONDARY AUDIO SET UP: NOTE: Remove any stereo or mono audio modulation input to the translator during the set up of the secondary audio. The modulator was factory set for a ± 15 -kHz deviation with a secondary audio input of 1 Vpk-pk. If this reading is not correct, adjust the SAP/PRO Audio Gain pot R150,

located on the front panel of the modulator, as necessary, for the ± 15 -kHz deviation.

IF Processor Module Assembly

Verify that all red LEDs located on the IF Processor front panel are extinguished. The following details the meaning of each LED when illuminated:

- DS1 (input fault) – Indicates that either abnormally low or no IF is present at the input of the IF Processor module.
- DS2 (ALC fault) – Indicates that the ALC circuit is unable to maintain the signal level requested by the ALC reference. This is normally due to excessive attenuation in the linearity signal path or the IF phase corrector signal path, or that switch SW1 is in the Manual ALC Gain position.
- DS4 (Mute) – Indicates that a Mute command is present to the system.

Switch the translator to Standby. The ALC is muted when the translator is in Standby. To monitor the ALC, preset R3, the manual gain adjust pot, located on the front panel of the Upconverter module, fully CCW. Move switch SW1, Auto/Man AGC, on the front panel of the Upconverter module, to the Manual position. Place the translator in Operate. Adjust the ALC GAIN pot on the front panel of the IF Processor to obtain 100% output power on the LCD Display mounted on the Controller/Power Supply in the ALC screen. Move the MAN/AUTO ALC switch back to Auto, which is the normal operating position.

To adjust the AGC Cutback setting, raise the output power of the translator to 120%. Adjust R2, AGC Cutback, located on the front panel, CCW until the LED

DS1, AGC Cutback, just starts to flash. Return the output power of the translator to 100%.

5.2.1 Linearity Correction Adjustment

As shipped, the exciter was preset to include amplitude and phase pre-distortion. The pre-distortion was adjusted to approximately compensate the corresponding non-linear distortions of the Power Amplifier.

NOTE: On the IF processor board inside the module the correction enable/disable jumper W12 on J30 will be in the Enable position, on pins 2 & 3.

Set up a spectrum analyzer with 100 kHz resolution bandwidth and 100 kHz video bandwidth to monitor the intermodulation products of the RF output signal of the Power Amplifier.

A typical red field spectrum is shown in Figure 5-1. There are three Linearity Corrector stage adjustments located on the front panel of the IF Processor Module. The adjustments are threshold settings that are adjusted as needed to correct for any amplitude or phase intermod problems. Adjust the top linearity correction adjustment R211 threshold cut in for the in phase amplitude distortion pre-correction that is needed. Next adjust the middle linearity correction adjustment R216 threshold cut in also for the in phase amplitude distortion pre-correction that is needed. Finally adjust the bottom linearity correction adjustment R231 threshold cut in for the quadrature phase distortion pre-correction that is needed. The above pots are adjusted for the greatest separation between the peak visual carrier and the intermod products.

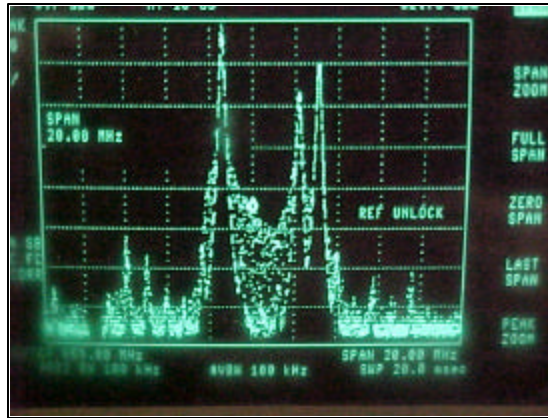

Figure 5-1. Typical Red Field Spectrum

5.2.2 Frequency Response Delay Equalization Adjustment

The procedure for performing a frequency response delay equalization adjustment for the translator is described in the following steps:

The center frequency for the first stage is 45 MHz. Adjust R103, the top frequency response equalizer pot, located on the front panel of the IF Processor Module, for the best depth of frequency response correction at 45 MHz.

The center frequency for the second stage is 43.5 MHz. Adjust R106, the middle frequency response equalizer pot, located on the front panel of the IF Processor Module, for the best depth of frequency response correction at 43.5 MHz.

The center frequency for the second stage is 42 MHz. Adjust R274, the bottom frequency response equalizer pot, located on the front panel of the IF Processor Module, for the best depth of frequency response correction at 42 MHz.

After the three delay attenuation equalizers have been adjusted, fine tune, as needed, for the best frequency response across the channel.

Note: The frequency response adjustment is done at IF, so the frequency cut-in points will be reversed at the UHF frequencies.

5.2.3 Calibration of the Translator Forward Output Power Level

Note: Perform the following procedure only if the power calibration is suspect.

Switch the translator to Standby and preset R51, the aural null pot on (A4) the visual/aural metering board, fully CCW. Switch the LO/Upconverter sled to Manual Gain. Adjust R48, the null offset pot on the visual/aural metering board, full CW. Adjust CCW until 0% visual output is displayed on the LCD Display in the System Visual Power position. Perform the following adjustments with no aural present by removing the jumper cable, the aural IF loop-through, that is connected on the rear of the exciter/driver chassis. Connect a sync and black test signal to the video input jack of the exciter/driver. Switch the translator to Operate.

Next, set up the translator for the appropriate average output power level using the Manual Gain pot on the LO/Upconverter sled:

Example is for 1000 Watt translator.

- Sync + black 0 IRE
setup/wattmeter=595 watts
- Sync + black 7.5 IRE
setup/wattmeter=545 watts

Note: The translator must have 40 IRE units of sync.

Adjust R28, visual calibration, on the (A4) visual/aural metering board for .8V, at TB30-14 and TB30-12 return, on the exciter/driver assembly, then adjust display to read 100% on the front panel meter in the System Forward Power position.

With the spectrum analyzer set to zero span mode, obtain a peak reference on the screen. Reconnect jumper cable on the rear of the exciter/driver. While in the Visual Output Power position, adjust L3 for a minimum visual power reading on the LCD display. Turn the power adjust pot on the LO/Upconverter sled front panel until the original peak reference level is attained. Peak L1 and C8 for a maximum aural power reading, then adjust R20 for .8V, at TB30-15 and TB30-12 return, on the exciter/driver assembly, then adjust LCD display for 100% system aural power reading. Switch to the Visual Output Power position and adjust R51 for 100% visual power on system LCD display.

5.2.4 Calibration of the Translator Reflected Output Level

On the meter, in the Visual Power position, turn the power adjust pot to 25%. Move the Reflected cable on the (A11) coupler to the unused "INC" port on the coupler. Then adjust R39 on (A4) the visual/aural metering board for a .2VDC, at TB30-13 and TB30-12 return, on the exciter/driver assembly. Then adjust the LED display for 25% reading in the System Reflected Power position. At this 25% reference power reading a reflected power fault should appear on

the System Errors Menu. Turn the power adjust pot slightly CCW and the fault should be clearable on the System Error Menu. Turn the pot CW until the Fault appears. The reflected output power is now calibrated.

Switch the translator to Standby and move the Reflected power cable on the A11 Coupler back to the "Reflected Port". Switch the translator to Operate and adjust the front panel power pot for a 100% visual power reading. Switch the LO/Upconverter to the Auto AGC position and adjust the ALC Gain adjust pot on the front of the IF Processor module for 100% visual power reading, if needed.

5.3 (A9) Bandpass Filter Assembly

The Bandpass Filter Assembly is tuned to reject unwanted distortion products generated when the signals are dplexed and also during the amplification process.

The Bandpass Filter is factory tuned to the proper bandwidth and should not need tuned. If you think tuning is needed consult Xcercera Field Support Department before beginning the adjustment.

5.4 (A10) UHF Trap Filter Assembly

The Traps on the output Trap Filter are labeled with their Center Frequency relative to the Frequency of the Carrier. (For Example: The Traps labeled -4.5 MHz are tuned for a Center Frequency of 4.5 MHz Lower than the Frequency of the Visual Carrier.) The first section of the Trap Filter filters out the Visual Carrier plus 9 MHz (f_v+9 MHz). The second and fourth sections work together to filter out the lower spurious product ($f_v-4.5$ MHz). The third section is tuned to remove the ($f_v+8.08$). The output of the Trap Filter is an "N" Type Connector.

The Trap Sections have been factory tuned and should not need major

adjustments. The Trap Filter is comprised of four trap sections connected to the main transmission line.

The Trap Sections are Reflective Notches, adjustable across the entire UHF Frequency Band. The electrical length of the Outer Sleeve and the Center Rod of the Notch can be adjusted to Tune the Notch Frequency. The Depth of the Notch is set by the gap between the Center Conductor of the Trap Section and the Center Conductor of the Main Line. Tight Coupling makes a Deep Notch, while Loose Coupling makes a Shallow Notch.

FINE TUNING of the Notches Center Frequency can be accomplished with the Tuning Bolts located on the side of the Filter Section. Loosen the nut locking the Bolt in place and adjust the Bolt to change the Frequency of the Notch. Monitor the output of the Translator with a Spectrum Analyzer and Null the Distortion Product with the Bolt. Red Field is a good Video Test Signal to use to see the +8.08 MHz Product. Tighten the nut when the tuning is completed. Hold the bolt in place with a screwdriver as the nut is tightened to prevent it from slipping.

MAJOR TUNING, such as changing the Notch Depth or moving the Notch Frequency more than 1 MHz, the Outer Conductor and the Center Conductor of the Trap Section must both be moved. This requires a RF Sweep Generator to accomplish. Apply the Sweep signal to the Input of the Trap Filter and monitor the Output. Loosen the Clamp holding the Outer Conductor in place and make the length longer to Lower the frequency of the Notch or shorter to Raise the frequency of the Notch. Loosen the Center Conductor with an Allen Wrench and move it Deeper for a Lower Frequency Notch or out for a Higher Frequency Notch. These adjustments must both be made to change the Notch Frequency. Moving only the Center Conductor or the Outer Conductor will

effect the Notch Depth in addition to the Center Frequency. The variable that is being adjusted with this procedure is the length of the Center Conductor inside the Trap Filter. The gap between the Trap and the Main Line should not be changed. Moving only the Inner or the Outer Conductors by itself will effect the Gap and the Notch depth.

To effect the Notch Depth Only, both sections will have to be moved. The Notch Depth is controlled by the Gap between the Center Conductor and the Trap Section. This Gap also has an effect on the Center Frequency. To Deepen the Notch, Shorten the Outer Conductor and pull the Center Conductor Out until the Notch is back in the same place. Move the Sections in the opposite direction to make a Shallow Notch. **NOTE:** THE TRAP FILTER IS TYPICALLY ADJUSTED FOR A NOTCH DEPTH OF 10 dB.

5.4.1 The Effects of Tuning the Output Trap Filter

Lengthening Outer Conductor Only - Notch Frequency Up, Shallower Notch.

Shortening Outer Conductor Only - Notch Frequency Down, Deeper Notch.

Inserting Inner Conductor Deeper - Notch Frequency Down, Deeper Notch.

Inserting Less Inner Conductor - Notch Frequency Up, Shallower Notch.

Tuning Bolt In - Notch Frequency Down.

Tuning Bolt Out - Notch Frequency Up.

Moving both Inner and Outer Conductors to keep the Same Gap inside - Center Frequency Moves, Notch Stays the Same.

After tuning has been completed, tighten the Clamp and the Allen Screws that hold the Conductors. Use the Fine Tuning Bolts to bring the Frequency In. The Final Tuning Adjustments should be completed with the Translator driving the

Output Trap Filter for at least one hour to allow for warm-up drift.

This completes the detailed alignment procedures for the LX Series translator.

The Translator is ready for normal operation.

If a problem occurred during the alignment, help can be found by calling Axcera field support at 724-873-8100.

APPENDIX A

LX SERIES
SYSTEM SPECIFICATIONS

Low Power Transmitter 10W-6kW



Designed to provide broadcasters with a product that will meet their needs like no other solution on the market, this new low to medium power transmitter line uses the latest LDMOS devices for broadband operation across the entire UHF band. This allows users to minimize spare parts stock, which is especially important to group owners and networks, and also enables simple and inexpensive channel changes.

The very compact and completely modular design uses a chassis/backplane configuration with parallel amplifier and power supply modules that can be removed and replaced while the transmitter is on the air. Additionally, the Innovator LX series was designed to be field upgradable to digital operation.

Configurations are available in power levels from 10 watts to 6 kilowatts analog and up to 3 kilowatts DTV, and all are manufactured in the USA by Axcera - *The RF Experts*.

Low Power Transmitter 10W - 6kW

Visual Performance

Frequency Range	470 to 806 MHz
Carrier Stability (<i>Transmitters</i>)	
Standard	±1 kHz
Optional w/PFC	±350 Hz
Frequency Translation Stability (<i>Translators</i>)	
Standard	±1 kHz
Optional w/PFC	±350 Hz
Regulation of RF Output Power	3%
Output Variation (<i>Over 1 Frame</i>)	2%
Sideband Response	
-1.25 MHz and below	-20 dB
-0.75 to -0.5 MHz	+0.5 db, -2 dB
-0.5 to +3.58 MHz	±0.5 dB
+3.58 MHz to +4.18 MHz	+0.5, -1.0 dB
Freq Response vs. Brightness	±0.5 dB
Visual Modulation Capability	1%
Differential Gain	5%
Incidental Phase Modulation	±3°
Linearity (<i>Low Frequency</i>)	5%

Visual Performance (*continued*)

Differential Phase	±3°
Signal-to-Noise Ratio	55 dB
2t K-Factor	2%
Noise Factor (<i>Translators</i>)	5 dB (<i>Max</i>)
w/Input Preamp	3 dB (<i>Max</i>)
Input Dynamic Range (<i>Translators</i>)	-60 dB to -15 dBm
w/Input Preamp	-75 dBm to -30 dBm
Env. Delay (<i>Transmitters</i>)	Per FCC Standard
Video Input (<i>Transmitters</i>)	75 ohms (Loop through)
Harmonics	-60 dB or better
Intermodulation Products	-52 dB or better
Spurious (<i>±3 MHz from channel edge</i>)	
100W and lower	-50dB or better
Greater than 100W	-60dB or better

Aural Performance

Frequency Deviation Capability (<i>Transmitters</i>)	±75 kHz
Distortion	0.5%
FM Noise	-60 dB
AM Noise	-55 dB
Aural to Visual Separation	4.5 MHz ± 100Hz
Composite Audio Input (<i>Multi-channel sound Transmitters</i>)	
Input Level	1V peak, nominal
Input Impedance	75 ohms, unbalanced
Frequency Range	
±0.1 dB response	50 Hz to 50 kHz
±0.5 dB response	30 Hz to 120 kHz
Monaural Audio Input (<i>Transmitters</i>)	
Input Level	0 to +10 dBm
Input	600 ohms, balanced
Freq Range (<i>±0.5 dB resp.</i>)	30 Hz to 15 kHz
Pre-emphasis	75µs
Subcarrier Input (<i>Transmitters</i>)	
Input Level	1V peak, nominal
Input Impedance	75 ohms, unbalanced
Freq Range (<i>±0.5 dB resp.</i>)	20 kHz to 120 kHz

General

Model Number*	LU10Ax	LU100Ax	LU250Ax	LU500Ax	LU1000Ax	LU2000Ax	LU3000Ax	LU4000Ax	LU5000Ax	LU6000Ax
Power Output (<i>Watts</i>)										
Visual (<i>Peak</i>)	10	100	250	500	1000	2000	3000	4000	5000	6000
Aural (<i>Avg.</i>)	1	10	25	50	100	200	300	400	500	600
Output Connector	N	N	7/8" EIA	7/8" EIA	7/8" EIA	7/8" EIA	3 1/8" EIA	3 1/8" EIA	3 1/8" EIA	3 1/8" EIA
Power Consumption (<i>Watts</i>)	250	675	1100	1900	3500	6700	10,250	13,500	16,700	19,900
Input Power										
Line Voltage (<i>Volts</i>)	117/230 ±10%		230 ± 10%							
Power Requirements	Single Phase, 50 or 60 Hz									
Size (<i>H x W x D</i>)	8.75"x19"x23" <i>(Chassis Only)</i>		55"x22"x34"				76"x22"x34"		76"x44"x34"	
Weight (<i>lbs.</i>)	45	45	340	360	400	550	700	1030	1180	1330
Operational Temperature Range	0 to +50°, derate 2°C/1000 ft.									
Maximum Altitude ³	8500 feet (2600m) AMSL									
Operational Humidity Range	0% to 95% non-condensing									
RF Load Impedance	50 Ω									

* For transmitters use "T" suffix, translators use "L" suffix (ex. LU100AT - 100W Transmitter)

Specifications published here are current as of the date of publication of this document. Because we are continuously improving our products, Axcera reserves the right to change specifications without prior notice. At any time, you may verify product specifications by contacting our office. Axcera views its patent portfolio as an important corporate asset and vigorously enforces its patents. Products or features contained herein may be covered by one or more U.S. or foreign patents.

APPENDIX B

DRAWINGS AND PARTS LISTS

LX Series High Power System

LX Series Amplifier Line Up Block Diagram.....	1302633
LX Series 500W or 1 kW System Translator Interconnect.....	1303563
LX Series System Typical Racking Plan	1303383

Chassis Assembly, Power Amplifier, LX Series

1 kW LX Series DC Harness Chassis/Airbox Interconnect	1303482
1 kW LX Series AC Harness Chassis/Airbox Interconnect	1303481
1 kW LX Series Coax Assembly Chassis/Airbox Interconnect	1303480
4 Way Splitter Module Assembly (Used with multiple Power Amplifier Assemblies) Contains a 4 Way Splitter Board (1303234).	
4 Way Splitter Board	
Schematic	1303237
4 Way Combiner Module Assembly (Used with four Power Amplifier Assemblies)	
4 Way Combiner Board Schematic	1303241
External Amplifier Signal Board, LX Series	
Schematic	1303346
Visual/Aural Metering Board	
Schematic	1265-3309

Power Amplifier Assembly, 250 Watt, LX Series (Each Amplifier Assembly supplies 250 Watts)

Block Diagram.....	1303585
Interconnect.....	1303510
Amplifier Control Board	
Schematic	1301964
RF Module Pallet, Philips	
Made from a RF Module Pallet w/o Transistors (1152336).	
RF Module Pallet w/o Transistors	
Schematic	51-5379-309-00 WSP
150-Watt UHF Driver Pallet Assembly	
Schematic	1303171
2-Way Combiner Board Assembly	
Schematic	1303211
UHF Phase/Gain Board	
Schematic	1303216

Power Supply Assembly, 1 kW, LX Series (One Power Supply Assembly for two Amplifier Assemblies)

Interconnect.....	1303479
-------------------	---------

