

## **User Manual**

# **Pressure-Sensitive Pen Device**

# **User's Manual**

**For IBM Personal Computers and Compatibles  
with Windows 95/98/ME/NT/2000/XP**

**RS232C: [Windows 95/98/ME/NT/2000/XP](#)**

**USB: [Windows 98/ME/2000/XP](#)**

**Driver and Pen Utilities Version 4.0**

The information contained in this document is subject to change without notice, and no part of this document may be reproduced or transferred in any form or by any means without the written consent of UC-Logic Technology Corporation.

All trademarks referenced in this document belong to their respective owners.

## **General Information**

### **Overview**

Welcome to the world of pen-based computing! You will soon discover how easy it is to control the computer using a pen instead of a mouse. You will also be able to draw, sketch or paint on your computer as easily as you would on paper, using appropriate software such as PhotoImpact, PhotoShop, and Painter. Since all Pen Device models described in this manual are pressure-sensitive, you can choose to emulate a soft-tipped pen.

This manual describes mainly how you install the Pen Device, configure it to best suit your use, and use Pen Utilities that come with the hardware. Specifically, it describes

[pen device functions](#), [items in the package](#), [system requirements](#), [hardware installation procedure](#), [Driver and Pen Utilities installation procedure](#), [verification of hardware installation](#), [verification of overall installation](#), [usage tips](#), [pen scrolling](#), [configuring the pen device](#), [Annotate All program](#), [Annotate for Word program](#), [PenMail Program](#), [PenSigner Program](#), and [PenCommander Program](#).

This manual is applicable to Driver and Pen Utilities Version 4.0.



**Note:** For best results, please try to look at the screen while using the Pen, and avoid looking at Tablet Plate. See the section [Usage Tips](#) for more usage tips.

## Quick Start

To start using your Pen Device quickly, take these steps:

1. Insert Driver Disc into an available CD-R drive, and the Setup program should start automatically. Press Enter key when the Setup message appears on the screen and let the program run its course. If the Setup program does not start automatically, you may start it manually by double tapping My



Computer  on Desktop, the CD-ROM drive icon , and then the Setup program icon .

2. Attach the hardware to your computer according to its type ([Pen Device with USB Interface](#), [Pen Tablet with RS232C Interface](#), or [Tablet Keyboard with RS232C Interface](#)). You have to power off your PC before attaching a Pen Device with RS232C interface.
3. Read [Usage Tips](#).

Start enjoying your Pen Device!

## Pen Device Functions

Your Pen Device, when properly installed and all system requirements met, provides the following functions:

1. Direct Pointing - You can move the cursor to any spot on the screen by moving the Pen over Tablet Plate without touching the Plate.

2. Three-Button [Mouse Commands](#) - The Pen Device provides all functions of a three-button mouse with a Pen Tip and two Barrel Buttons, all [programmable](#).
3. Scrolling documents or images - You can scroll up and down by moving the Pen freely over Tablet Plate ("[Pen Scrolling](#)") without looking for the scroll bar.
4. [Pen Launching](#) - You can launch any application or emulate keyboard pressing by tapping on [Hot Cells](#) on Tablet Plate.
5. [Adjusting](#) the size and position of Pen Area on Tablet Plate.
6. [Pressure Sensitivity](#) - Allows the Pen to emulate various soft-tipped as well as hard-tipped pens.

With the aid of Pen Utilities included in Driver Disc, the Pen Device provides the following functions:

1. [Annotate for Word](#) - Marking up Microsoft Word documents as if on a piece of paper, and storing the markups as part of the document.
2. [Annotate All](#) - Marking up any screen to send to someone on the Net or for later viewing.
3. [PenMail](#) - Writing a letter in your own handwriting and sending it through e-mail.
4. [PenSigner](#) - Capturing your online signature or simple hand drawing and inserting into various documents.
5. [PenCommander](#) - Controlling the computer with a flip of your pen.

With the aid of additional application programs, the Pen Device opens up even more possibilities:

1. Draw with emulated paint brushes, chinks, watercolor, and a host of other pens with programs such as [Corel Painter Classic](#) by [Corel](#) and [PhotoImpact](#) by [Ulead](#).
2. Seal documents with your own signature with signature verification programs such as [PenOp Signature](#) by [PenOp](#).
3. Verify online signature against templates previously stored on a server with programs such as [Cyber-SIGN for Lotus Notes](#) by [Cyber-SIGN](#).
4. Design application systems that can take advantage of full functions of the Pen Device.

## Items in the Package

Please refer to later sections for a description of the [product series](#) and [packed items](#) shown in the following tables.

### Pen Tablet Packing List

Item Series	Plate RS232	Plate USB	Cordless Pen	Pen Holder	Corded Pen	Cordless Mouse	Driver Disc	Application CD
DP – USB		1	0 or 1	0 or 1	1	0 or 1	1	0 or more
DP – RS232	1		0 or 1	0 or 1	1		1	0 or more
WP – USB		1	1	0 or 1		0 or 1	1	0 or more
WP – RS232C	1		1	0 or 1			1	0 or more
PP – RS232C	1			0 or 1	1		1	0 or more

The number in each cell above indicates the number of items packed; an empty cell indicates 0 item.

### Tablet Keyboard Packing List

Item Series	Keyboard RS232	Keyboard USB	Built-in Plate	Cordless Pen	Pen Holder	Corded Pen	Driver Disc	Application CD
KD – USB		1	1	0 or 1	0 or 1	1	1	0 or more
KD – RS232C	1		1	0 or 1	0 or 1	1	1	0 or more
KW – USB		1	1	1	0 or 1		1	0 or more
KW – RS232C	1		1	1	0 or 1		1	0 or more
KP – USB		1	1		0 or 1	1	1	0 or more
KP – RS232C	1		1		0 or 1	1	1	0 or more

The number in each cell above indicates the number of items packed; an empty cell indicates 0 item.

## Description of Product Series

The following is a description of the product series of Pen Tablets and Tablet Keyboards.

- **DP – RS232:** DP Series Tablet with Cordless or Corded Pressure-Sensitive Pen and with RS232C interface.
- **DP – USB:** DP Series Tablet with Cordless or Corded Pressure-Sensitive Pen and with USB interface. A Cordless Mouse may optionally be included for larger-sized Tablets.
- **KD – RS232:** KD Series Keyboard with Cordless or Corded Pressure-sensitive Pen and with RS232C interface.
- **KD – USB:** KD Series Keyboard with Cordless or Corded Pressure-sensitive Pen and with USB interface.
- **KP – RS232:** KP Series Keyboard with Corded Pressure-sensitive Pen and with RS232C interface.
- **KP – USB:** KP Series Keyboard with Corded Pressure-sensitive Pen and with USB interface.
- **KW – RS232:** KW Series Keyboard with Cordless Pressure-sensitive Pen and with RS232C interface.
- **KW – USB:** KW Series Keyboard with Cordless Pressure-sensitive Pen and with USB interface.
- **PP – RS232:** PP Series Tablet with Corded Pressure-Sensitive Pen and with RS232C interface.
- **WP – USB:** WP Series Tablet with Cordless Pressure-Sensitive Pen and with USB interface. A Cordless Mouse may optionally be included for larger-sized Tablets.
- **WP – RS232:** WP Series Tablet with Cordless Pressure-Sensitive Pen and with RS232C interface.

## Description of Packed Items

The following is a description of items that may be included in a product package. The specific items that are included in various models are described in [packing list tables](#).

- **Application CD:** One or more CD's containing bundled application software
- **Built-in Plate:** A Tablet Plate that is built into the keyboard as an integral part, and not detachable
- **Cordless Pen:** A stylus pen working with a Plate without a connecting cable
- **Corded Pen:** A stylus pen working with a Plate connected with a cable
- **Cordless Mouse:** A device without cord that functions as a mouse on the

Tablet Plate

- **Driver Disc:** A CD containing Driver Program, Pen Utilities and User's Manual (this manual)
- **Keyboard RS232:** A keyboard connected through a split data cable with a keyboard connector and an RS232C connector
- **Keyboard USB:** A keyboard connected through a data cable with a USB connector
- **Pen Holder:** A holder for a Cordless or Corded Pen
- **Plate RS232:** A Tablet Plate connected through a split data cable with an RS-232C Connector and two keyboard connectors
- **Plate USB:** A Tablet Plate connected through a data cable with a USB Connector

## System Requirements

- IBM PC or compatible with Intel 80486 or equivalent or above
- Microsoft Windows 95, 98, ME, NT, 2000 or XP for tablet driver support
- At least 64MB of hard disk space for Driver and Pen Utilities installation
- At least 16MB of RAM (64MB recommended)
- **For Pressure Sensitivity:** Microsoft Windows 95, 98, ME, NT, 2000 or XP (supported through a Wintab-compatible interface)
- **For Annotate for Word:** Pentium II 233 MHz or equivalent and above, at least 64MB of RAM, and Microsoft Word in Office 97, Office 2000 or Office XP
- **For RS232C Interface:** An available RS232C port (also known as serial port or COM port) with associated available IRQ
- **For USB Interface:** A USB port and Windows 98, ME, 2000 or XP

**Note:** At most one Pen Device may be attached to a PC at one time

## Parts of a Pen Device

The key parts of a Pen Device are Pen, Tablet Plate and an optional Cordless Mouse. Tablet Plate may be stand-alone or be embedded in another device such as a keyboard; and the Pen may be connected to Tablet Plate with a cord (corded), or be free from it (cordless). The figure below uses a Pen Tablet with USB interface as an example to show the key parts of a Pen Device.

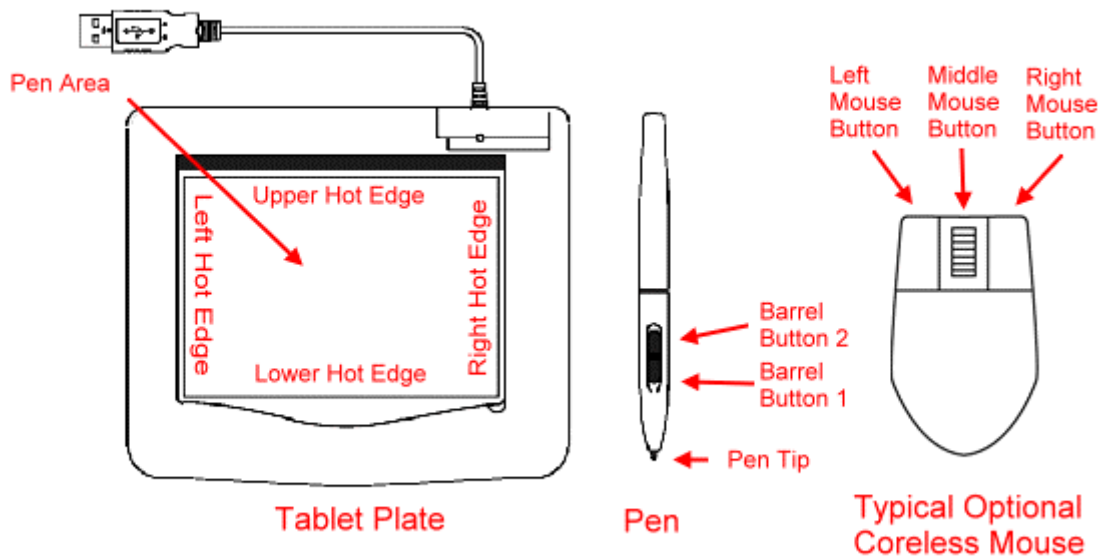

*Figure 1 Parts of a Pen Device*

**Note:** The optional Cordless Mouse requires a **Pen Tablet with USB Interface**.

## Installing Hardware

To install the Pen Device,

1. Attach the hardware to your computer according to its type ([Pen Device with USB Interface](#), [Pen Tablet with RS232C Interface](#), or [Tablet Keyboard with RS232C Interface](#)),
2. [Verify](#) that hardware is installed properly,
3. [Install the Driver and Pen Utilities](#), and
4. [Verify](#) that the pen device as installed functions properly.
5. Install optional Application Software according to its own instructions (not included in this manual). Most Application Software is installed by running its Setup program.

### Installing Pen Device with USB Interface

To attach the Pen Device with USB interface to your computer, first locate an available USB Receptacle on the computer, usually on the back panel, on the monitor, or on the keyboard. Then, plug the USB Connector into the Receptacle, in a way similar to the

figures shown below. On a computer system that fully supports USB interface, there is no need to turn off the power, nor restart the operating system.

The Pen Device may be either a Pen Tablet or a Tablet Keyboard.

When the system detects the presence of a USB Pen Device, it will attempt to look for its driver. Please select Cancel or press the escape key (marked Esc) to get out of it, and start the Setup program on the Driver Disc to install the Driver and Pen Utilities.

If a USB Pen Device has been installed before, and the driver has not been uninstalled, the operating system will automatically find the installed driver when you re-attach a Pen Device, and you need not run the Setup program again unless you wish to upgrade Driver Program.

After the Driver and Pen Utilities is installed, please [verify](#) that the Pen Device functions properly.

The optional Cordless Mouse needs no special installation, and will start to function normally as soon as Pen does.



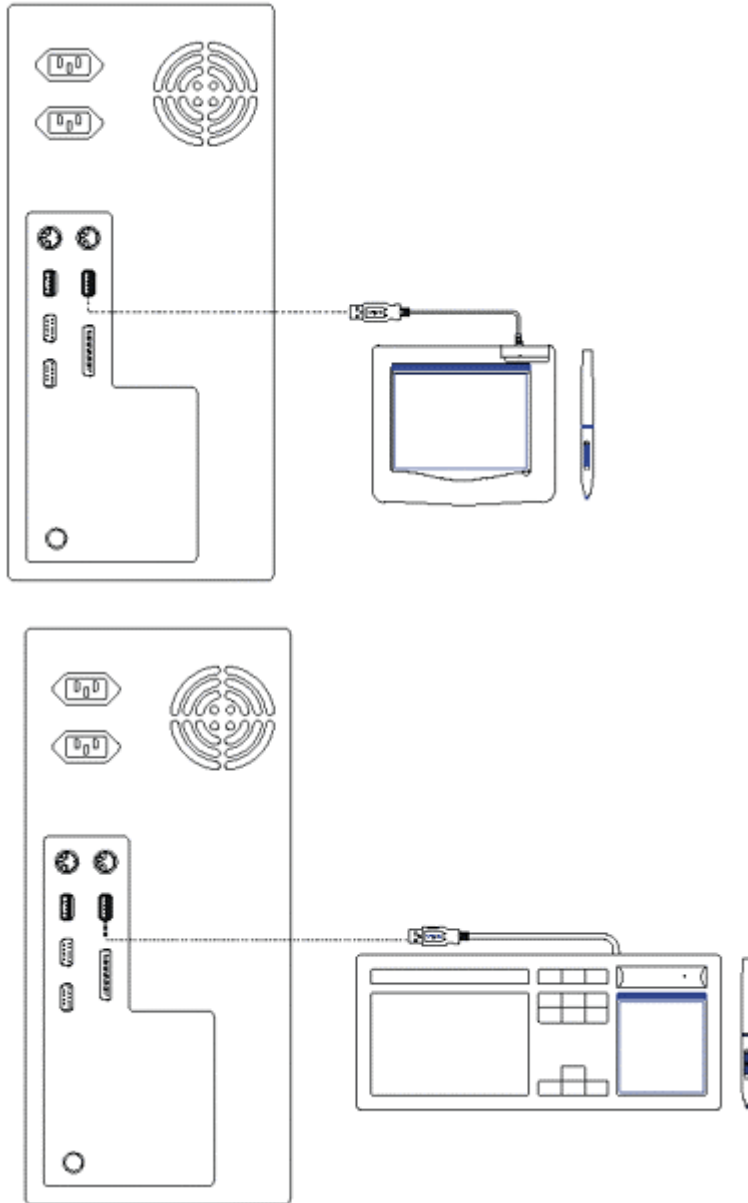

*Figure 2 Attaching a USB Pen Device to PC*

## Installing Pen Tablet with RS232C Interface

Before attempting to install the Pen Tablet on your computer, please check that the [system requirements](#) are all met, and that all items listed in [Pen Tablet Packing List](#) are present. This section describes the installation procedure for Pen Tablet with RS232C Interface. If you have a Pen Device with USB interface, please see [Installing Pen Device with USB Interface](#).

You attach the Pen Tablet to the computer by inserting the Pen Tablet's Keyboard Connectors between the keyboard and the computer, and by connecting the Pen Tablet's RS232C Connector to an available COM (serial) port. The procedure is described below.

1. Shut down Windows and turn off the power of your PC.
2. Examine the connecting parts of the Pen Tablet.

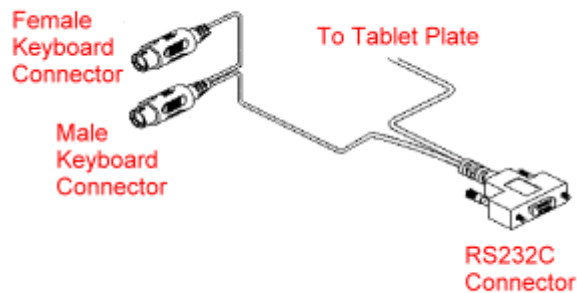

*Figure 3 Parts of the Pen Tablet for connecting to the PC*

3. Locate where the Original Keyboard Connector attaches to the computer. In the figure 4 below, we assume it is in the back of a desktop PC. Examine the size of the keyboard connector (see figure 5 below).

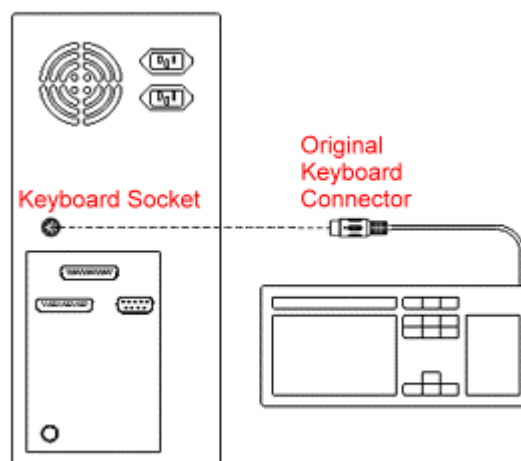

*Figure 4 Connection of the keyboard to a desktop PC before installing the Pen Tablet*

Detach the Original Keyboard Connector from the Keyboard Socket, and remember the location of the Keyboard Socket so you can find it later. Examine the connector and try to match

one of the pictures in the figure below. If it matches Small Connector, go to the next step. Otherwise, you need to find two Keyboard Adaptors (not included) so the connectors will match.

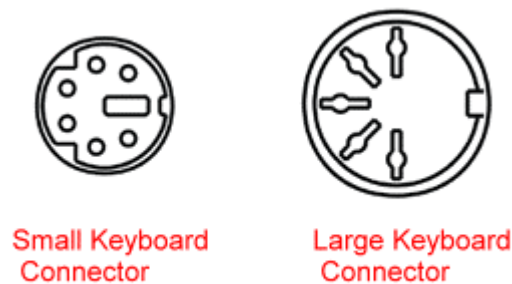

*Figure 5 Identifying the Keyboard Connector*

4. If your keyboard has a small (PS/2) connector (see figure above), connect the Original Keyboard Connector to the Female Keyboard Connector (the one connected with a single data cable). Then, connect the Male Keyboard Connector (the one with a split data cable) to the PC at the Keyboard Socket to which the keyboard was originally attached. Go to [Step 6](#).

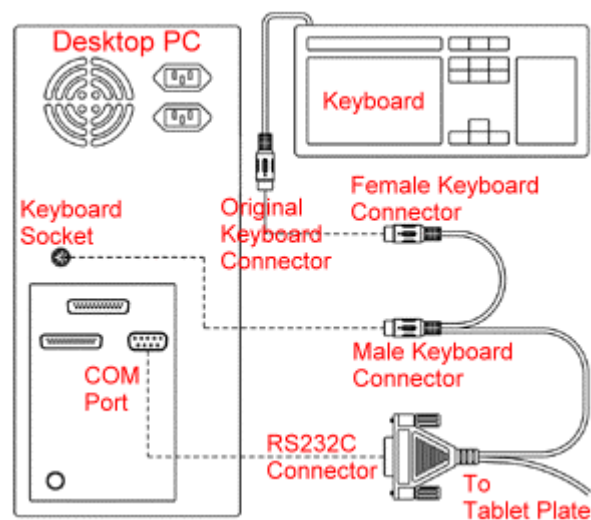

*Figure 6 How the Pen Tablet is attached to a desktop PC with a PS/2 keyboard*

5. If you have a notebook PC, connect the Male Keyboard Connector (the one with a split data cable) to the PS/2 Port. If there is an external keyboard (assuming it uses a PS/2 connector), and you wish to keep it, you should then attach the Original Keyboard Connector to the Female Keyboard Connector

(the one with a single data cable). See figure below. Go to [Step 6](#).

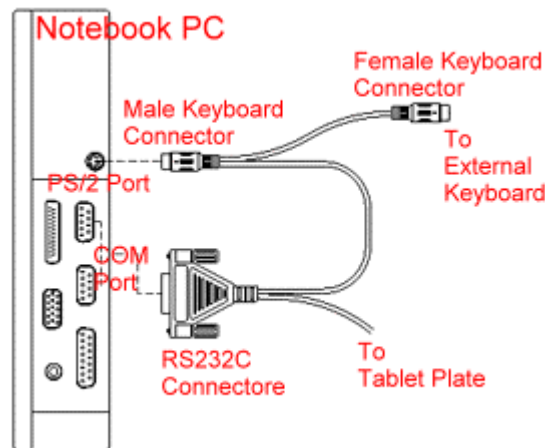

*Figure 7 How the Pen Tablet is attached to a notebook PC*

6. Take the 9-pin RS-232C Connector running from Tablet Plate and insert it into COM1 port of the computer. If COM1 is in use, for example, by a mouse, you may plug into COM2 port instead. In this case, since many COM2 ports require a 25-pin connector, you will need to find a 9-pin-to-25-pin adaptor (not included). Also, if your computer has a built-in modem using one of COM1, COM2, COM3, and COM4 ports, please seek help from a professional to ensure that the Pen Tablet can indeed use an apparently unused serial port. A built-in modem may use up a COM port which is shared by an outside COM port socket. The Pen Tablet requires a free COM port to operate, and it can co-exist with a mouse and/or a modem connected to a different COM port not in conflict with the port used by the Pen Tablet. If the mouse uses a PS/2 port, it will not conflict with any COM port.
7. Turn power on and wait for Windows to start up.
8. [Verify](#) that the Pen Tablet hardware functions properly.

The hardware installation is now complete. Please proceed to [install the Driver and Pen Utilities](#) that provides pointing device function and Pressure Sensitivity (through a Wintab-compatible interface), plus additional pen functions with Pen Utilities such as [Annotate All](#), [Annotate for Word](#), [PenSigner](#), [PenMail](#), and [PenCommander](#).

## Installing Tablet Keyboard with RS232C Interface

Before attempting to install the Tablet Keyboard on your computer, please check that the [System Requirements](#) are all met, and that all items listed in [Tablet Keyboard Packing List](#) are present.

You attach the Tablet Keyboard to the computer by connecting the RS-232C Connector to an available COM (serial) port and connecting the Keyboard Connector to the Keyboard Socket on your computer. The procedure is described below.

1. Shut down Windows and turn off the power of your PC.
2. Remove the original keyboard, if any, from your PC, and note where the Keyboard Socket is.
3. Examine the parts of the Tablet Keyboard, as shown in Figure below.

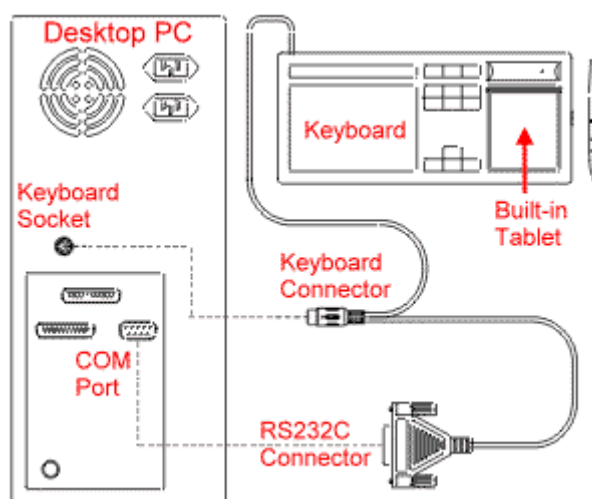

*Figure 8 Attaching the Tablet Keyboard to the PC*

4. Connect the Keyboard Connector to the Keyboard Socket. You will need to find an adaptor (not included) if the size of the Keyboard Connector does not fit that of the Keyboard Socket, similar to what is shown in [Figure 5](#).
5. Take the 9-pin RS-232C Connector running from Tablet Plate and insert it into COM1 port of the computer. If COM1 is in use, for example, by a mouse, you may plug into COM2 port instead. In this case, since most COM2 ports require a 25-pin connector, you will need to find a 9-pin-to-25-pin adaptor (not included). Also, if your computer has a built-in modem using one of COM1, COM2, COM3, and COM4 ports, please seek help from a professional to ensure that the Tablet Keyboard can indeed use an apparently unused serial port. A built-in modem may use up a COM port which is shared by an outside COM port socket. The Tablet Keyboard requires a free COM port to operate, and it can co-exist with a mouse and/or

a modem connected to a different COM port not in conflict with the port used by the Tablet Keyboard. If the mouse uses a PS/2 port, it will not conflict with any COM port.

6. Turn power on and wait for Windows to start up.
7. [Verify](#) that the Tablet Keyboard hardware functions properly.

The hardware installation is now complete. Please proceed to [installing Driver and Pen Utilities](#) that provides pointing device function and Pressure Sensitivity (through a Wintab-compatible interface), plus additional pen functions with Pen Utilities such as [Annotate All](#), [Annotate for Word](#), [PenSigner](#), [PenMail](#), and [PenCommander](#).

## Installing Driver and Pen Utilities

To install Driver and Pen Utilities on Windows system other than Windows 3.1, we recommend that you follow the procedure below, and do not rely on the Plug and Play feature. For Windows 3.1 system, please refer to the section [Installing Driver Program on Windows 3.1](#). For DOS system, please refer to the section [Installing Driver Program on DOS](#).

### Installing Driver and Pen Utilities on Windows

#### 95/98/ME/NT/2000/XP

1. Attach the Pen Device to your computer as [described before](#) and turn on power if it was turned off. When Windows starts, it may display a New Hardware Found dialog. If so, choose Cancel to get out of it.
2. Insert the Driver Disc into the CD-ROM drive. Assume this drive to be "E".
3. Select "Start" at the lower left corner of the screen and select "Run".
4. Type in "E:\setup", and press Enter key to initiate the Setup Program.
5. You will be offered a chance to change the directory where the Driver and Pen Utilities will be copied. You may also select or deselect the installation of some of Pen Utilities and/or online User's Manual. Change it if you wish and select OK to continue.

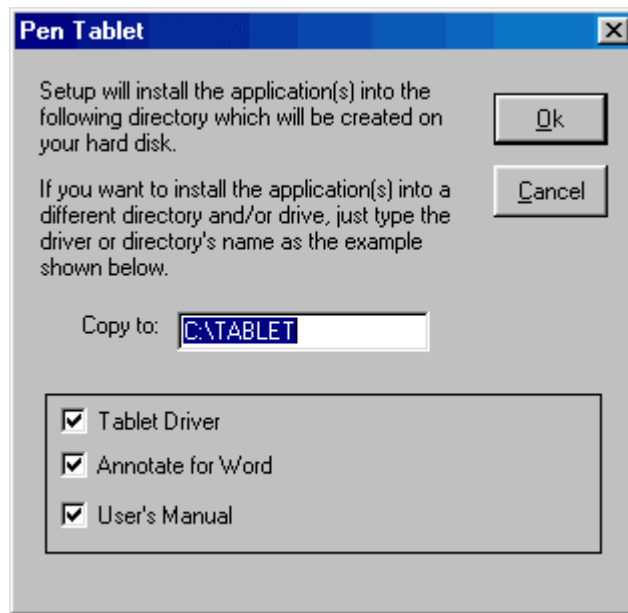

*Figure 9 Driver Setup dialog*

**Note:** Annotate for Word will function only if Microsoft Word is properly installed. If you do not have Word installed when you install the Driver and Pen Utilities, you may install Pen Utilities later, selecting only Annotate for Word, after you install Word.

6. The Setup Program will then install the Driver and Pen Utilities per your instruction. **Note:** Certain Pen Utilities may not function properly in DOS window.
7. When the installation is complete, you will see a dialog box indicating it is about to restart the system. Choose "OK" to continue.
8. After the system is restarted, please check to ensure that both the hardware and Tablet Driver are functioning properly by following the procedure described in [Verifying Overall Installation](#).

When both the hardware and software are installed properly, moving the Pen over Tablet Plate will cause the cursor to move on the screen correspondingly. The position of Pen Tip on Tablet Plate corresponds directly with the position of the cursor on the screen. For example, if Pen Tip is at the center of Pen Area, the cursor will also be at the center of the screen.

You may use the Pen Device as a pointing device, and, with application support, you may also use it to draw pictures in a way similar to using a soft-tipped pen such as a brush, or a hard-tipped pen such as a ballpoint pen.

# Automatic Driver Installation on Windows

## 95/98/ME/2000/XP

The Pen Device is a Plug & Play device. That is, after the Pen Device is attached to the PC properly for the first time, it would be detected automatically as new hardware by Windows 95/98/ME/2000/XP when Windows becomes active. Windows 95/98/ME/2000/XP will then seek the Tablet Driver, and, when found, will install the Tablet Driver automatically upon your confirmation. However, due to the way Plug & Play is implemented in Windows, many people find this process troublesome on some versions of Windows and certain brands of PC. In addition, the Plug & Play process will install only the Tablet Driver, and you still need to run the Setup program if you want to install Pen Utilities.

Therefore, we recommend that you choose “Cancel” at the “New Hardware Found” dialog, so as NOT to use this feature.

## Installing Driver Program on Windows 3.1

To install the Driver Program on Windows 3.1, follow the procedure below. **Note:** Only mouse functions are supported on Windows 3.1. Specifically, neither Pressure Sensitivity nor any of the Pen Utilities are supported.

1. Attach the Pen Device to your computer [as described](#) before and turn on power if necessary. Make sure that the Program Manager is displayed.
2. Insert the Driver Disc into the CD-ROM drive. Assume this drive to be “E”.
3. Go to the File menu in the Program Manager, choose the Run command, and then press the Enter key.
4. Type in "E:\setup", and press Enter key to initiate the Setup Program.
5. You will be offered a chance to change the directory where the Driver Program will be copied. Change it if you wish and select OK to continue. See [Figure 9](#).
6. The Setup Program will then install the Tablet Driver.
7. When the installation is complete, you will see a dialog box indicating it is about to restart the system. Choose "OK" to continue.
8. After the system is restarted, please check to ensure that both the hardware and Tablet Driver are functioning properly by following the procedure described in [Verifying Overall Installation](#).



9. The installation of Driver Program is now complete. Start your favorite graphic or word-processing application and begin to enjoy your Pen Device.

When both the hardware and software are installed properly, moving the Pen over Tablet Plate will cause the cursor to move on the screen correspondingly. The position of Pen Tip on Tablet Plate corresponds directly with the position of the cursor on the screen. For example, if Pen Tip is at the center of Pen Area, the cursor will also be at the center of the screen.

You may use the Pen Device as a pointing device, and, with application support, you may also use it to draw pictures in a way similar to using a hard-tipped pen such as a ballpoint pen.

## Installing Driver Program on DOS

Please copy the file UCTABLET.EXE found on the Driver Disc to your hard disk drive, and run this program to start using the Pen Device on your system. You may also add this command to AUTOEXEC.BAT so the Tablet Driver is automatically started every time you start the system. Make sure the Pen Device hardware has been attached to your computer properly by following the procedure described in the section [Verifying Hardware Installation](#).

**Note:** Only mouse functions are supported on DOS. Specifically, neither pressure sensitivity nor any of the Pen Utilities are supported.

When both the hardware and software are installed properly, moving the Pen over Tablet Plate will cause the cursor to move on the screen correspondingly. The position of Pen Tip on Tablet Plate corresponds directly with the position of the cursor on the screen. For example, if Pen Tip is at the center of Pen Area, the cursor will also be at the center of the screen.

You may use the Pen Device as a pointing device, and, with application support, you may also use it to draw pictures in a way similar to using a hard-tipped pen such as a ballpoint pen.

**Note:** Do not run UCTABLET.EXE on Windows systems. Mouse functions are supported in DOS mode running under Windows without running UCTABLET.EXE.

# Verifying Hardware Installation

Verify that the Pen Device hardware functions properly by following the procedure described in this section.

The green LED light is the key indicator for hardware verification. Watch it as you go through the test procedure. If the light does not come on at all, see the following table for suggested action to take.

## If the LED light does not come on...

Possible Cause	Suggested Corrective Action
Cable connections are loose or incorrect, so that the Pen device does not get power.	Go through the installation procedure again and correct the connections.
The Cordless Pen or Mouse has gone to "sleep" to conserve its battery power.	Tap the Pen on any surface or press the Left Button to "wake it up".
The battery in the Cordless Pen or Mouse is out.	Change the battery.
The LED light or some other part of the Pen Device is defective.	Go to the place where you bought your Pen Device and seek help there.

## Hardware Verification Procedure

1. The green LED light on Tablet Plate will come on briefly as soon as Tablet Plate receives power, and will stay off as long as Pen Tip or Mouse is not above Pen Area in Tablet Plate, or it is too high above the Plate.
2. Tap the Cordless Pen on any surface or press the Left Button of the Mouse to "wake it up". You need not do this for a Corded Pen.
3. The LED light will flash slowly when Pen Tip is directly above Pen Area of Tablet Plate and is low enough to be detected by Tablet Plate, or when the Cordless Mouse rests in the Pen Area.
4. For as long as you press a Barrel Button on the body of the Pen or any of the Mouse Buttons, the LED light will be on.
5. When you press Pen Tip against Tablet Plate anywhere in Pen Area, or press the Left Mouse Button while the Mouse is in Pen Area, the light will also be on as long as the Tip or the Button remains

pressed. Note that the position and size of Pen Area may vary if you have modified it on [The Scope Configuration Page](#).

6. However, before Tablet Driver is properly installed, moving Pen Tip or the Mouse over Tablet Plate will not cause the cursor on the screen to move.

## Changing the Battery

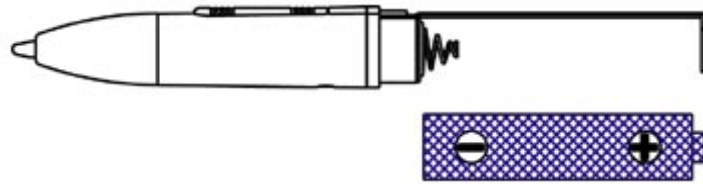

After you have used the Pen Device normally for a while, and the Device begins to work sluggishly, or does not work at all, the battery may be running low or out. You may follow the steps below to change the battery in the Pen.

1. Gently slide off the end cap of the Pen. Do not turn, as there are no threads.
2. Insert a new battery (1.5V, size AAA) with the end marked with minus (-) sign facing Pen Tip.
3. Slide the end cap back in.

## Verifying Overall Installation

After both hardware and Driver and Pen Utilities are installed, you may follow the procedures in this section to verify that both the Tablet hardware and Tablet Driver are functioning properly. You may also follow these procedures at any time when you suspect the system may be malfunctioning.

## Verifying General Functionality

1. When you move Pen Tip or Mouse over Tablet Plate, the cursor will move over the screen accordingly. However, the Pen and the Mouse behave differently. The Pen acts in what is known as Absolute Mode. That is, when you put the Pen at the upper left corner of the Plate, the cursor will be at the upper left corner of the screen; when you move the Pen to the center of

Tablet Plate, the cursor will also move to the center of the screen.

On the other hand, the Mouse acts in a way similar to a regular mouse, also known as Relative Mode. That is, when you move the mouse in Pen Area, the cursor on the screen moves relative to its position when the current movement started. You may lift the mouse off the Tablet Plate, put it down to a different position, and move it again, while the cursor will move accordingly from its position when the mouse was lifted

2. You should see a small Tablet Icon () in the system Task Bar, usually located at the lower right corner of the screen.

## Verifying Pressure Sensitivity

These are tips to verify that pressure sensitivity functions properly. In most cases, an application program such as PhotoImpact or Painter controls the exact behavior of the Pen. Sometimes the pressure sensitivity might even be turned off inadvertently by the application program. The steps described below help ensure that the Pen Device functions according to specifications.

1. You know that pressure sensitivity is supported if [the Pressure Configuration Page](#) is present after you tap on the Tablet Icon () on the system Task Bar, usually located at the lower right corner of the screen (See the section [Configuring the Pen Device](#)).
2. To verify the function further, select [the Pressure Configuration Page](#) and try to draw a few lines in the Pressure Test area. Pressing harder at Pen Tip should draw thicker lines, and pressing lightly would leave thinner trace in the area. If this is not so, there might be a problem with the Pen, and you should seek help from the store you bought the Tablet from. In addition, both a number and a barometer will indicate the pressure level when you press the Pen Tip. (Depending on the speed of your computer, drawing very fast may leave a series of dots (filled circles) in the Test Area instead of a solid line. This is normal).
3. Writing a few strokes on the *PenSigner* Program will also indicate clearly whether pressure sensitivity functions properly. However, you need to set the Trace Width to 6 pixels or more to make clear variation in the thickness of trace. See description of [Width Adjustment Slide](#).

If a particular application does not seem to provide pressure sensitivity when the above tests indicate otherwise, please verify also that the application has been installed and set properly, and that the application does support Wintab interface. Some applications may require you to explicitly turn on pressure sensitivity support, or it may limit the number of pressure levels supported.

**Note:** The Cordless Mouse does not support pressure sensitivity.

## Usage Tips

### 1. Tapping before You Use the Pen

Before you use a Cordless Pen, after you have not used it for several minutes, tap the Pen on any surface to "wake" up the Cordless Pen. Or, whenever the Pen seems not responding, tap it on any surface. This is because a Cordless Pen would turn itself off to save energy after it has not been used for several minutes. This action is not necessary for a Corded Pen.

Similarly, for a Cordless Mouse to be used with a Pen Device, always press the Left Mouse Button before attempting to use it.

### 2. Focusing on the Screen

When you write or draw with a Pen Device, try not to look at Tablet Plate. Focus your eyes on the screen instead. After a little practice, you will get more fun and higher efficiency because, with a pen, it is easier to concentrate on the text or picture you are working on.

### 3. Double Tapping

For best results, when you double tap with a Pen (equivalent to double click on a mouse), try to keep Pen Tip on the surface of Tablet Plate, or at least try to lift Pen Tip as little as possible before the second tap. This would reduce the deviation between the positions of the two taps.

### 4. Storing a Cordless Pen Properly

To store a Cordless Pen, make sure that the Tip does not touch anything. Especially do not stand the Pen on a surface with the tip

down. A constant, though small, pressure applied to the Pen Tip will cause a constant drain on the battery inside. We recommend that you put the Pen in the Pen Holder specially designed for this purpose, or store it with the Pen Tip pointing upward, or lie it horizontally with the Pen Tip free of any other objects.

Similarly for the Cordless Mouse, avoid pressing on ANY of the buttons when it is not in use.

## **5. Scrolling and Panning with a Pen**

When you are browsing a document or a Web page, it is especially convenient to use a Pen. All you do is press and hold Barrel Button 1, and hover the Pen over Pen Area, or move the Cordless Mouse while pressing the Middle Mouse Button. With Microsoft Internet Explorer, for instance, the Web page will scroll up and down, and left and right, corresponding to your Pen or Mouse movement. The exact behavior of Pen Scrolling function varies with the application program. Notably, Microsoft Word supports only vertical scrolling, and NetScape Navigator 4.5 does not support Pen Scrolling. See the section [Pen Scrolling](#) for more details.

After you use Pen Scrolling without tapping or pressing the Left Mouse Button for a few minutes, you may find the Cordless Pen or Mouse stop functioning all in a sudden. Just tap on any surface or press the Left Mouse Button to “wake up” the Pen or the Mouse.

## **6. Holding the Pen Vertically**

When drawing pictures or signing your name, try to hold the pen vertically for best results.

## **7. Using both a Pen and a Regular Mouse**

In general, you may have both a Pen Tablet and a regular mouse installed on the same computer, and you may switch between the two devices at will. However, for a Pen Tablet with serial port interface, you have to make sure that the two devices are not in conflict in the COM port or IRQ they use. The easiest way to avoid this problem is to connect the mouse to a PS/2 port, and the Pen Tablet to a COM port.

Certain mouse drivers, notably those that come with certain Logitech mouse models, would render a properly installed Pen Tablet with serial port interface inoperative. If you wish to have both such a mouse and the Pen Tablet operable at the same time, remove the non-standard mouse driver and replace it with a standard mouse driver, such as one that comes with Windows system.

A Pen Tablet with USB interface does not conflict with another mouse in these ways.

You may freely choose to use any one of the Pen, the Cordless Mouse that comes with the Pen Device, and a regular mouse.

#### **8. Using a Pen without a Regular Mouse**

You may work with the Pen Device only, without a regular mouse at all. When you remove a regular mouse with Com (serial) port interface, make sure you also remove its driver completely. You remove the mouse driver by selecting Start /Settings /Control Panel /Device Manager, press the "+" sign to reveal the mouse driver, select and remove it, and restart the computer. Be careful not to remove the USB mouse driver that may exist with some models of Pen Devices with USB interface. If you start with a computer not equipped with a regular mouse, you should learn how to use the keyboard for setup, using TAB, Enter, Escape, and other keys.

## **Pen Scrolling**

*Pen Scrolling* is a special function provided by the Tablet Driver to let you scroll through a document or an image by simply hovering the Pen over Tablet Plate without using the scroll bar. Thus, scrolling becomes especially convenient for activities such as browsing HTML documents on the Internet, examining images larger than the screen, panning a spreadsheet on the computer, and so on. An example of *Pen Scrolling* follows.

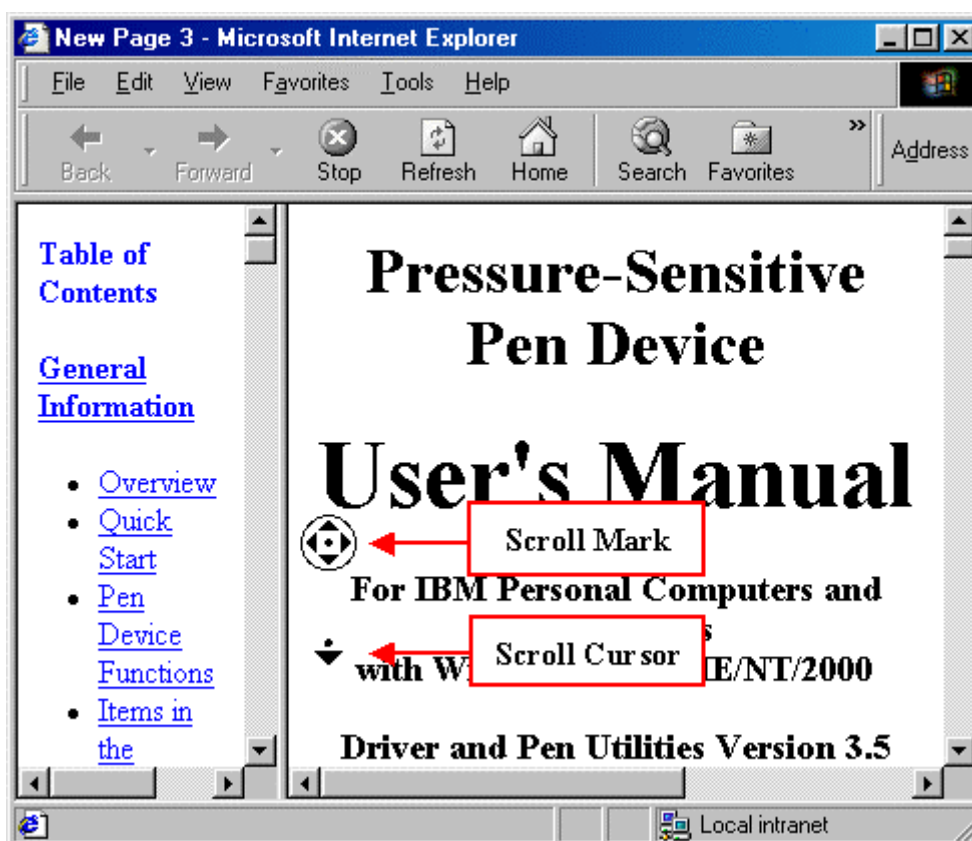

Figure 10 An example of Pen Scrolling







## Enabling Pen Scrolling

To enable *Pen Scrolling*, make sure one of Barrel Buttons has been set to trigger the mouse command Middle Click. Let us call this button Scroll Button. We recommend using Barrel Button 1, the button closer to Pen Tip, as Scroll Button. You may verify or change this setting by calling out [the Button Configuration Page](#) of the Tablet Driver through tapping on the Tablet Icon (🖊️) in the system Task Bar, usually located at the lower right corner of the screen, or through the Control Panel.

Pen Scrolling requires Windows 95 OSR2 Edition or up, and also requires the support of the application controlling the scrolling window. To find out if Pen Scrolling is supported, try using it after making sure both the Tablet hardware and Tablet Driver have been installed properly, and also Pen Scrolling has been enabled as described above.

## Using Pen Scrolling



To use *Pen Scrolling*, simply press and hold Scroll Button while moving the Pen over Pen Area without touching the Plate surface. As soon as you press Scroll Button, a Scroll Mark such as , , or , will appear. Also, the cursor changes to Scroll Cursor, looking something like . When you move Scroll Cursor away from the Scroll Mark, the window showing the document will scroll in that direction, and the shape of Scroll Cursor may also change to point to the direction it is moving, such as  or . To scroll faster, increase the distance between Scroll Cursor and Scroll Mark; to scroll at a lower speed, decrease this distance. When you release Scroll Button, Scroll Mark disappears and *Pen Scrolling* stops also.

You may also *Pen Scroll* without holding Scroll Button if you press Scroll Button and release it immediately. You will find that Scroll Mark will remain on the screen after Scroll Button is released. Moving the Pen over Pen Area will cause the document to scroll. Pressing Scroll Button again removes Scroll Mark and stops *Pen Scrolling*.

## Variations in the Pen Scrolling Function



*Pen Scrolling* works for most Microsoft applications, including Internet Explorer, WordPad on windows 98, Word, Excel, PowerPoint, and Access. Many other applications also support Pen Scrolling, for example, Ulead PhotoImpact. You will find that the behavior of *Pen Scrolling* varies somewhat from application to application, even among Microsoft applications.

Some applications will allow you to scroll in all directions, while others will scroll only up and down; still others will scroll smoothly, while some tend to be "jumpy". You may also find that some applications do not support *Pen Scrolling* at all, for example, Netscape Navigator 4.5. Also, within an application, *Pen Scrolling* may not work in all contexts. For example, *Pen Scrolling* does not work with Help texts shown under Microsoft Word.

Given all the variations in *Pen Scrolling* implementations, please experiment with it for each application to get a better feel for this very useful function.

## Configuring the Pen Device

You may configure the Pen Device by modifying the functions of Pen Tip and Barrel Buttons, defining the application to launch when tapping on a hot cell, adjusting the size and position of Pen Area, adjusting the feel of the Pen to heavier or lighter, and obtaining other information about the device. You may also use these functions to verify that the Pen Device is functioning properly.

You invoke the Configuration function by tapping with Pen Tip on the Tablet Icon () on the system Task Bar, usually located at the lower right corner of the screen. You may also invoke it by first tapping on Start Button at the lower left corner of the screen, and selecting Settings then Control Panel, and finally double tapping on the Tablet Icon ().

**Note:** For best results, when you double tap with the Pen, try to keep Pen Tip close to the surface of Tablet Plate, that is, try to lift Pen Tip as little as possible for the second tap. This helps you tap on the same spot.

When you invoke the Configuration function, you will be presented with a dialog with a number of configuration pages, as described below.

## The Info Configuration Page

The Info Configuration Page displays version and other information about the product.

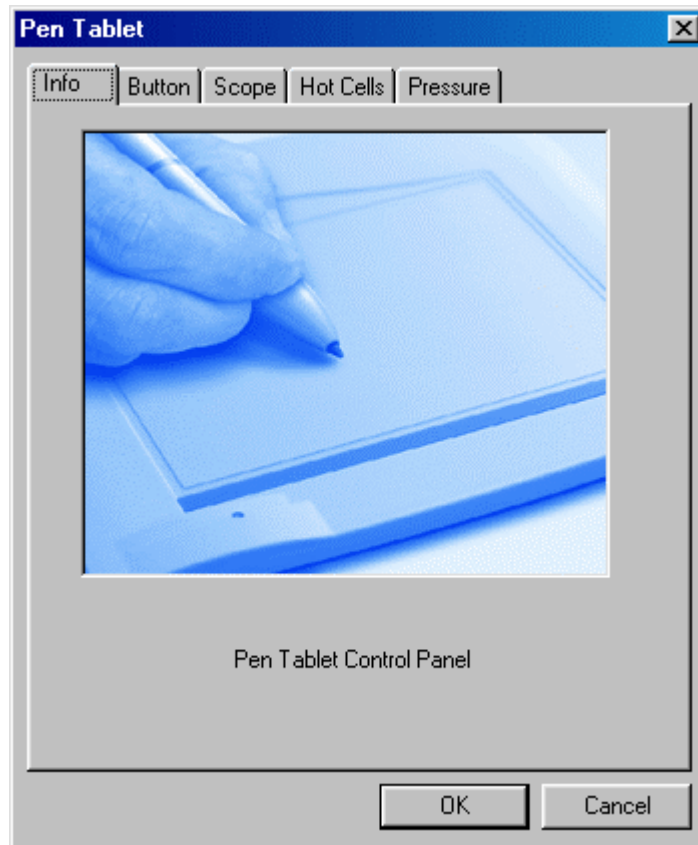

*Figure 11 A Sample Info Configuration Page*

## The Button Configuration Page

You use [the Button Configuration Page](#) to change the functions of Pen Tip and Barrel Buttons, to set the speed of double tap with Pen Tip, and so on. This Page looks as follows:

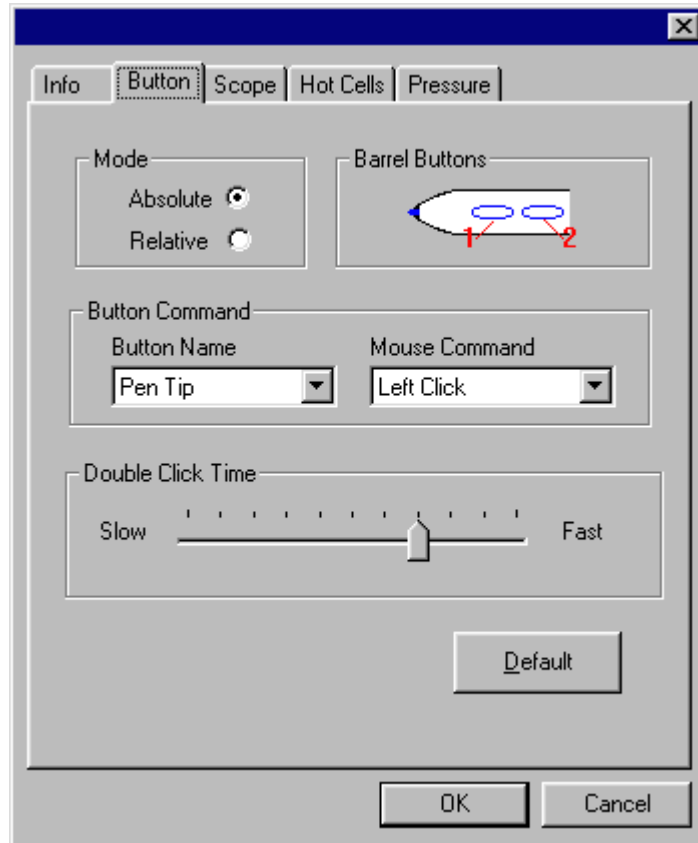

*Figure 12 The Button Configuration Page*

**Note:** When you configure the Pen Tip and Barrel Buttons, the buttons of the Cordless Mouse are also automatically configured. Namely, the Left Mouse Button will take up the definition for the Pen Tip, the Middle Mouse Button for Barrel Button 1, and the Right Mouse Button for Barrel Button 2.

- **Mode**

**Absolute:** When you move the Pen over Pen Area on Tablet Plate, the cursor on the screen moves instantly with it. In the Absolute Mode, the points in Pen Area on Tablet Plate correspond directly in position to the points on the screen. Most people prefer this mode when using a Pen Device.

**Relative:** In this rarely used mode, when you move the Pen over Tablet Plate, the cursor moves relatively to the starting position when the moving stroke started, in a way similar to using a mouse. To complete a stroke, either move the Pen upward until the Plate no longer detects the Pen or take the Pen out of Pen Area.

**This setting is not recommended for normal use.**

- **Barrel Buttons**

The numerals 1 and 2 indicate where Barrel Button 1 and Barrel Button 2 are, respectively, on the body (barrel) of the Pen.

- **Button Command**

You may choose one of Pen Tip, Barrel Button 1, and Barrel Button 2, and set it to one of the Mouse Commands on a three-button mouse.

- **Double Click Time**

Move the Speed Slider toward "Slow" if you wish to allow yourself more time in double tapping with Pen Tip; move the Speed Slider toward "Fast" if you wish the reverse. This setting is the same as Double-click Speed on the page displayed by selecting Start, Settings, Control Panel, Mouse, and Buttons. Changing the speed in one place changes the other at the same time.

- **Default**





You choose this option to restore all the settings on this Page to their respective values when the Tablet Driver was first installed.

## The Scope Configuration Page

You use the Scope Configuration Page to set the size and position of Pen Area on Tablet Plate. Pen Area is the area on Tablet Plate where the Pen can be used to point and tap, and to draw and write.

The cursor changes its shape when it is moved over the image indicating Pen Area on this

Page. When the cursor looks like a cross with arrowheads on each end (  ), you may drag the entire area (press and hold while moving) to the desired position. You may also drag the cursor to change the size of Pen Area when it looks like a double-headed arrow

( , , , or  ). The other choices on the Page are as follows:

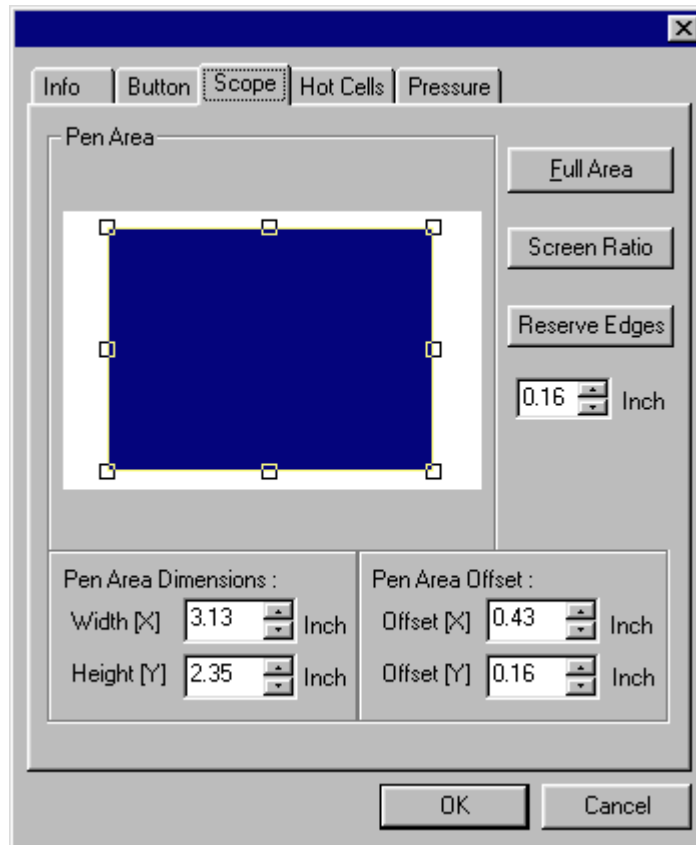

*Figure 13 The Scope Configuration Page*



- **Full Area**  
Sets Pen Area to the largest possible size.
- **Screen Ratio**  
Sets Pen Area to be proportional to the screen size by reducing either the current width or height of Pen Area.
- **Reserve Edges**  
Reduce Pen Area by reserving edges on the four sides with the indicated width.
- **Pen Area Dimensions**  
Indicates the current height and width of Pen Area. You may also type in new values here to change them.
- **Pen Area Offset**

Indicates the horizontal and vertical distances of the upper left corner of Pen Area from the upper left corner of the maximum Pen Area. You may also set their values by typing in the numerical values here.

## The Hot Cells Configuration Page

You use the Hot Cells Page to define a number of Hot Cells on Tablet Plate so that you can trigger a pre-defined action by tapping on a Hot Cell. The Hot Cells are small areas around Pen Area. You first reserve up to four Hot Edges surrounding Pen Area, and in each Hot Edge you can assign actions to Hot Cells in it. In the figure below, the gray area in Hot Pad Layout indicates the maximum Pen Area.

**Note:** If the protective cover over Tablet Plate has preprinted Hot Cell definitions, such as

 and , the printed sheet with your modified definitions of Hot Cells may not show clearly through the original preprinted protective sheet.

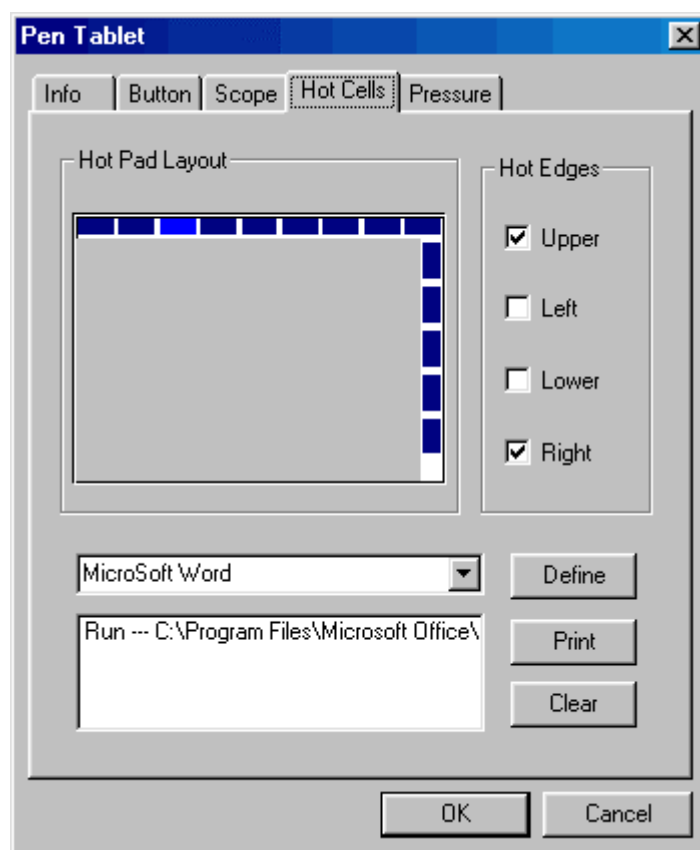

*Figure 14 The Hot Cells Configuration Page*

- **Hot Pad Layout**

This area indicates the current size of Pen Area, and each blue rectangle indicates a Hot Cell. You can view and modify the contents of each Hot Cell by first tapping on a rectangle.

- **Hot Edges**

You can choose up to four Hot Edges around Pen Area to use Hot Cells. When a Hot Edge is selected, the size of current Pen Area is reduced accordingly. If you choose no Hot Edge at all, Hot Cells function is turned off.

- **Hot Cell Contents**

The area beneath Hot Pad Layout shows the Label of the currently selected Hot Cell and its Associated Action. In the figure above, the selected Hot Cell is the left-most one in the top Hot Edge, its Label is "PenLauncher", and its Associated Action is to run the indicated program. After you exit configuration mode, tapping on the left-most Hot Cell in upper Hot Edge will start the PenLauncher program.

- **Define**

You tap on this button to define the action to be taken when the selected Hot Cell is tapped. The Define Hot Cell pages are explained later.

**Note:** Some Hot Cells may be locked from modification when installed. The Label and Associated Action of such Hot Cells cannot be changed, as indicated by gray Define Button and gray Label.

- **Print**

Tapping on this button will cause a picture of the currently defined Hot Pad Layout to be printed on the system default printer. The printout is designed to be inserted underneath the cover sheet over Tablet Plate to remind you of the actions defined for the Hot Cells.

- **Clear**

Tapping on this button will clear the definition of the selected Hot Cell, so that no action will be taken when the Hot Cell is tapped later.

## Define Hot Cell - Run



On this page, you specify a program or a document to run when you tap on the Hot Cell.

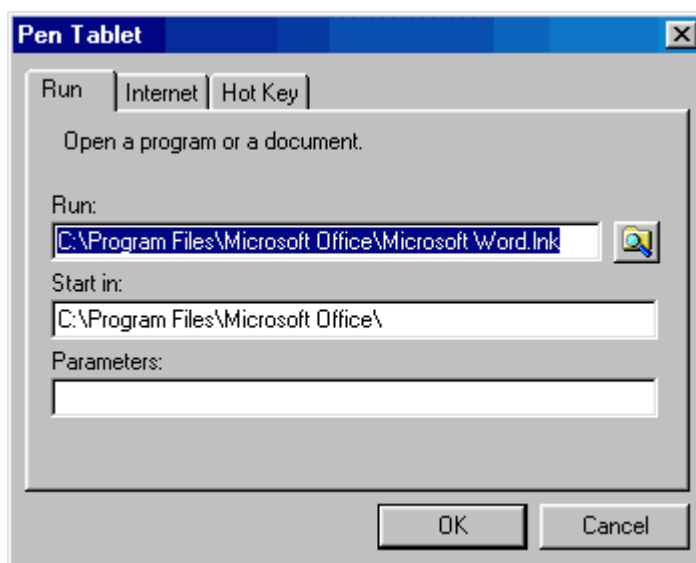

*Figure 15 Define Hot Cell - Run*

- **Run**

You may use the browse button on the right to select a file to run, or you may type in a file name with complete path. The effect of tapping on Hot Cell will be as if you double tap on the selected file when it is in the Explorer window. That is, for a program, it will be executed, and, for a document, the associated application will be started. If you select a folder, Explorer will be started with the selected folder in the window.

- **Start in**

This is the initial folder when the program starts execution.

- **Parameters**

The string typed in here will be passed to the program as parameters. For example, you may type in a document name here and pass it to a word processing program specified in the Run line above.

### **Define Hot Cell - Internet**

On this page, you specify an Internet service to start when you tap on the Hot Cell.

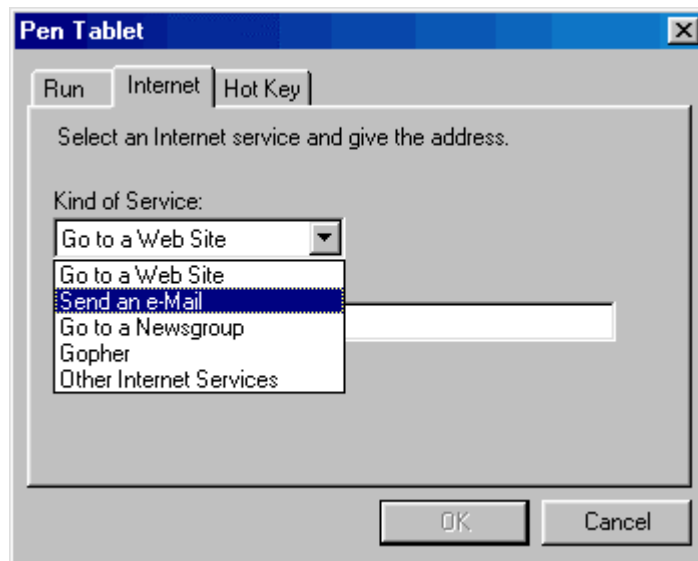

*Figure 16 Define Hot Cell - Internet*

- **Kind of Service**

You select the kind of Internet service to start. For example, go to a Web site, or send an E-mail message. The exact program initiated (for example, which browser program) depends on system settings.

- **Address**

The URL address for the selected service. For example, the Web site address, or the e-mail address.

### **Define Hot Cell - Hot Key**

On this page, you specify a key or key combination to press when the Hot Cell is tapped. For example, in the figure below, the combination of ALT key and F4 key will be simulated when the Hot Cell is tapped. This usually results in closing the current application.

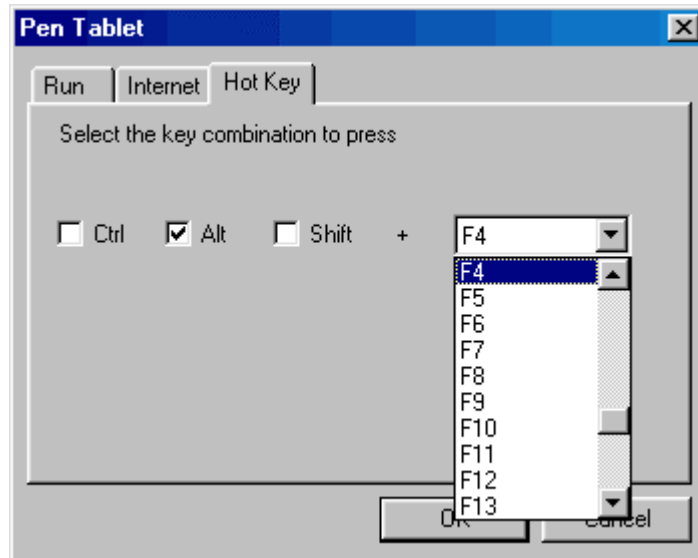

*Figure 17 Define Hot Cell - Hot Key*

- **Select the key combination to press**

You may select any key such as alphanumeric key or cursor control key, combined with Shift, Ctrl and/or ALT key.

## The Pressure Configuration Page

You use the Pressure Configuration Page to verify that Pressure Sensitivity works properly, and to make adjustments. The Pressure-Sensitive Pen can be used to draw heavier lines or darker colors when more force is applied to Pen Tip. This requires that the drawing application supports a Wintab-compatible interface and the Wintab-compatible driver is properly installed by installing the Tablet Driver as described before. The Pressure Configuration Page looks as follows:

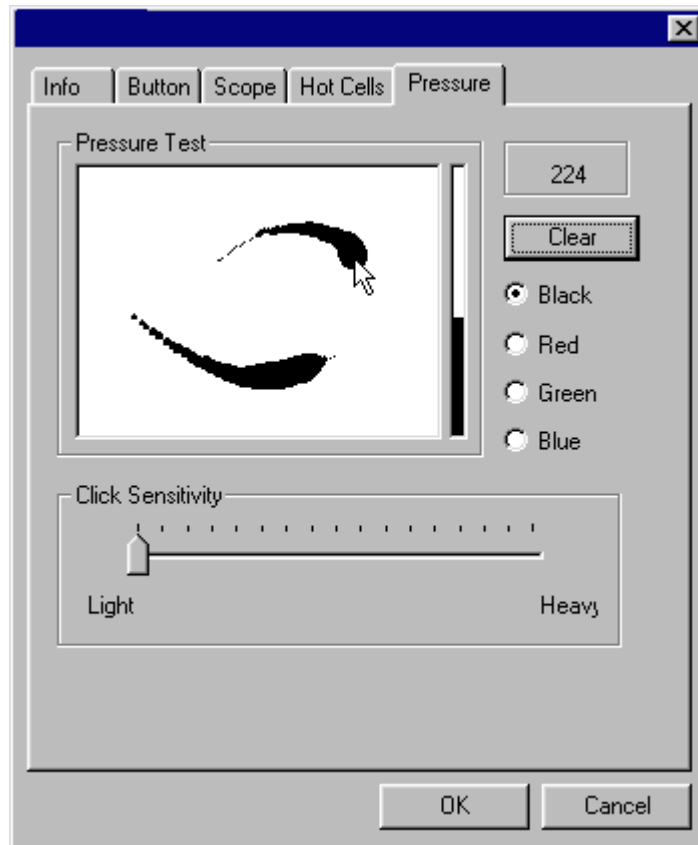

*Figure 18 The Pressure Configuration Page*

- **Pressure Test**

You may test the "feel" of the Pen in this area. When you draw with a lighter force pressing down on Tablet Plate, you will see a narrower line in this area; when you draw with more force, you will see that the Pen leaves a wider trace in the area. You may also choose a color for the test to get a better feel.

While you draw, the barometer on the right side of the drawing area indicates the pressure level you are applying to Pen Tip. At the same time, the numerical value of the pressure level is also shown on the right above the Clear Button.

When you draw fast, the trace it leaves may become a series of unconnected dots (filled circles), instead of a solid line. This gives an indication of the speed of your computer.

- **Clear**

You press Clear Button to clear the drawing from Pressure Test area.

- **Click Sensitivity**

This controls the feel when you tap with the Pen to cause an action such as “select”. Tapping with Pen Tip is equivalent to “clicking” on the left button of a mouse unless you have changed it on the Button Configuration Page or you have changed the mouse setting on the Control Panel to “left-handed”. You move the Sensitivity Bar closer to “low” if you wish to get a “click” action with smaller force; you move it closer to “high” for a heavier pointing device. *Note that this has nothing to do with how heavy you draw to get a thick line. Your application program controls the latter, not the Tablet Driver.*

**. FCC Statement:**

*This equipment has been tested and found to comply with the limits for a class B digital device, pursuant to part 15 of the FCC Rules. These limits are designed to provide reasonable protection against harmful interference in a residential installation.*

*This equipment generates, uses and can radiate radio frequency energy and, if not installed and used in accordance with the instructions, may cause harmful interference to radio communications. However, there is no guarantee that interference will not occur in a particular installation. If this equipment does cause harmful interference to radio or television reception, which can be determined by turning the equipment off and on, the user is encouraged to try to correct the interference by one or more of the following measures:*

- Reorient or relocate the receiving antenna.*
- Increase the separation between the equipment and receiver.*
- Connect the equipment into an outlet on a circuit different from that to which the receiver is connected.*
- Consult the dealer or an experienced radio/TV technician for help.*

*This device complies with Part 15 of the FCC Rules. Operation is subject to the following two conditions:*

- (1) This device may not cause harmful interference.*
- (2) This device must accept any interference received, including interference that may cause undesired operation.*

*Changes or modifications not expressly approved by the party responsible for compliance could void the user's authority to operate the equipment.*