

# eNBioAccess-T1 User Guide

---

Version Eng-1.6



© Copyright 2013, NITGEN Co., Ltd.  
All rights reserved

- It is strictly prohibited to compile, duplicate or publish part or whole of this manual prior written consent of NITGEN.
- The specification of this product may be changed without prior notice to improve its functionality.
- The logo of NITGEN&COMPANY is a registered trademark of NITGEN Co., Ltd.
- Other names or trademarks are registered trademarks of their respective owners.

---

(05836) (Munjeong-dong, Daemyung VALEON) 12<sup>th</sup> Floor, 127, Beobwon-ro,  
Songpa-gu, Seoul, Korea  
Tel : 82-2-6488-3232 , Fax : 82-2-6488-3099,  
E-Mail: [customer@nitgen.com](mailto:customer@nitgen.com); <http://www.nitgen.com>



## &lt;Revision History&gt;

Version	Date	Description	Firmware Version
1.0	2016-3-30	Initial Release	2_000_0014
1.1	2016-4-08	Change Wordings and Add Notes	2_000_0015
1.2	2016-7-08	Add RS485 function	2_000_0023
1.4	2016-7-15	Change Door Open interval	2_000_0025
1.5	2016-9-12	Change Door Open interval	2_000_0026
1.6	2016-10-17	Add scope of RS485 ID	2_000_0027

## <Product Descriptions>

The NITGEN access control system of **eNBioAccess-T1** is the optimized product by organically combining the globally recognized core technologies of NITGEN, such as a fingerprint recognition algorithm, optical sensors, embedded design technology, and software application technology.

This product is designed with maximum consideration for the efficiency of operation so that stand-alone terminals can be monitored and managed comprehensively and systematically from a remote place via a network.

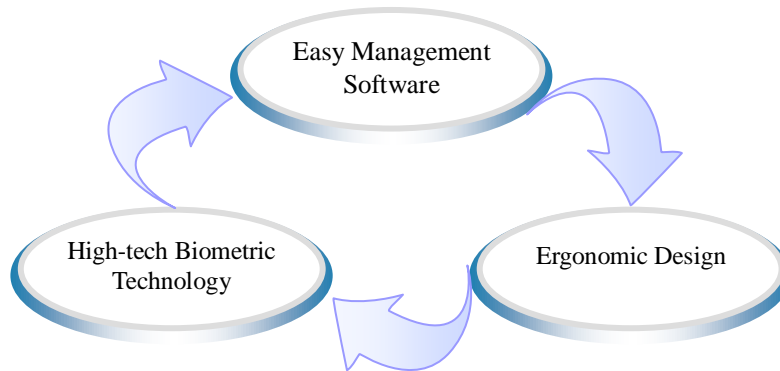

## <Glossaries>

- Administrator (Admin)
  - The administrator can access to the terminal menu mode. He/she has the authority to add/modify/delete terminal users and to change the operating environment by changing settings.
  - If there is no registered administrator in the terminal, anybody can access to the terminal menu and change settings. **It is recommended that more than one administrator will be necessarily registered in the terminal.**
  - The administrator has the authority to change critical environmental settings of the fingerprint reader. So, special attention is required to its registration and operation.
  
- 1:1 Authentication
  - The user fingerprint is verified after entering User ID or Card.
  - Only User ID or the user fingerprint registered to the card is compared. This is called One-to-One Authentication.
  
- 1:N Identification
  - The user is searched only by the fingerprint.
  - The same fingerprint as the input fingerprint is identified among the registered fingerprints without User ID or Card entered. This is called One-to-N Identification.
  
- Authentication Level
  - As a level used for fingerprint authentication, it is displayed in Step 1 to 9. Authentication cannot be allowed before the degree of match between two fingerprints is higher than the set authorization level.
  - The higher authentication level may ensure the higher security. But it requires the relatively high concordance rate. When authenticating User ID, it high likely to deny authentication.
  - 1:1 Level: Authentication level applied when 1:1 authentication
  - 1:N Level: Authentication level applied when 1:n authentication
  
- LFD (Live Finger Detection): Fake fingerprint prevention function
  - The LFD allows only actual fingerprints to be entered, except for any fake fingerprints made of rubber, paper, film, and silicon and the like.

## Table of Contents

<Revision History> .....	2
<Product Descriptions> .....	3
<Glossaries>.....	4
Table of Contents.....	5
<b>1. Before Getting Started.....</b>	<b>7</b>
1.1. Safety Notes .....	7
1.2. Product Details .....	8
1.3. LED signals displayed during operation .....	9
1.4. Buzzer guide announced during operation .....	9
1.5. How to register and enter correct fingerprint .....	9
<b>2. Product Descriptions .....</b>	<b>11</b>
2.1. Product Features.....	11
2.2. Configuration Diagram .....	12
2.2.1. Standalone Use (Access) .....	12
2.2.2. Connecting to the PC server (Access, T&A) .....	12
2.3. Product Specification.....	13
<b>3. Environment Setting.....</b>	<b>14</b>
3.1. Checkpoints before environment setting.....	14
3.1.1. To run iAccess Plus (Mobile App) .....	14
3.1.2. To enter the administrator menu.....	14
3.2. User Management.....	15
3.2.1. Add User.....	15
3.2.2. Delete .....	15
3.3.3. Change.....	16
3.3. Terminal Setting.....	17
3.3.1. Setting via “iAccess Plus” .....	17
3.3.2. To set the terminal IP via Access Manager .....	20
<b>4. How to Use Terminal .....</b>	<b>23</b>
4.1. Authentication.....	23
4.1.1. Fingerprint Authentication.....	23
4.1.2. Card Authentication .....	23
4.1.3. Multi Authentication .....	23
<b>5. Troubleshooting .....</b>	<b>24</b>



---

5.1. When the fingerprint authentication time is too long or fails .....	24
5.2. When the fingerprint is not entered well.....	24
5.3. When the RF card authentication fails.....	24
5.4. When the network is not connected.....	24
5.5. When the authentication is successful but the door does not open .....	25
5.5. When the user is not registered .....	25
5.6. When the product is unstable or does not work .....	25

# 1. Before Getting Started



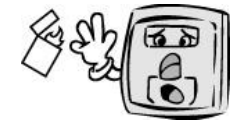



## 1.1. Safety Notes

### ● Warning

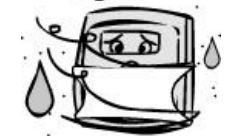
<p>Do not operate the terminal with wet hands, and pay attention not to let any liquid such as water enter inside the terminal. → Otherwise, malfunction or electric shock may be caused.</p>		<p>Keep the terminal away from inflammables. → Otherwise, it may cause a fire.</p>	
<p>Do not disassemble, repair or remodel the terminal at your disposal. → Otherwise, it may cause malfunction, electric shock, or a fire.</p>		<p>Do not allow children to touch the terminal carelessly. → Otherwise, it may cause safety accidents of children or malfunction.</p>	

- Non-compliance of safety notes may cause death or serious injury for users.

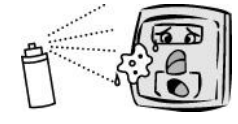
### ● Cautions

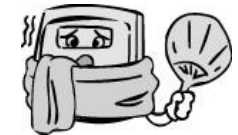
<p>Do not install the terminal in a place exposed to direct sunlight. → Otherwise, it may cause malfunction, deformation and discoloration.</p>		<p>Do not install the terminal in humid or dusty places. → Otherwise, it may cause malfunction.</p>	
<p>Do not clean this terminal by sprinkling water, nor wipe it with benzene, thinner, and alcohol. → Otherwise, it may cause electric shock or a fire.</p>		<p>Keep the terminal away from magnets. → Otherwise, it may cause failure and malfunction.</p>	
<p>Keep the fingerprint input section clean. → Otherwise, the fingerprint cannot be recognized correctly.</p>		<p>Do not spray insecticides or inflammables on the terminal. → Otherwise, it may cause deformation and discoloration.</p>	
<p>Keep the terminal away from shock or sharp objects. → Otherwise, it may damage the terminal and result in malfunction.</p>		<p>Do not install the terminal in a place where there is a severe change in temperature. → Otherwise, it may cause malfunction.</p>	

- Non-compliance of safety notes may cause personal injury or property damage for users.

※ We are not responsible for any accidents and damage that may arise from non-compliance of the information in this manual.

1.2. Product Details





1.3. LED signals displayed during operation

●	Lighting	: Normal status
	Flickering	: When the input of fingerprint and card user is on standby
●	Lighting	: Light up for 1 second upon successful authentication.
	Flickering	: Flicker at one second interval when FW is downloaded and when an administrator application is entered.
●	Lights-out	: Normal status
	Lighting	: Light up for one second when authentication fails.
	Flickering	: Flicker for one second upon the warning status (forced opening, non-connection of server, etc.).

1.4. Buzzer guide announced during operation

Ppik	When fingerprint or card is read	When the card is read, When the FP is entered in the FP window
Ppibik	When failure	If authentication fails or the user's input is wrong, If the control and setting of the terminal fail
Ppiriririk	When input standby	When it is notified that the input of fingerprint and card user is on standby
Ppiririk	When success	If authentication is successful, If the terminal is successfully booted, If the control and setting of the terminal and successfully completed

1.5. How to register and enter correct fingerprint

- Correct fingerprint input method

Enter your fingerprint as if you take a thumbprint by using your forefinger if possible.  
The fingerprint cannot be correctly registered and entered only by your fingertips.  
The center of the fingerprint should be touched with the fingerprint input section.

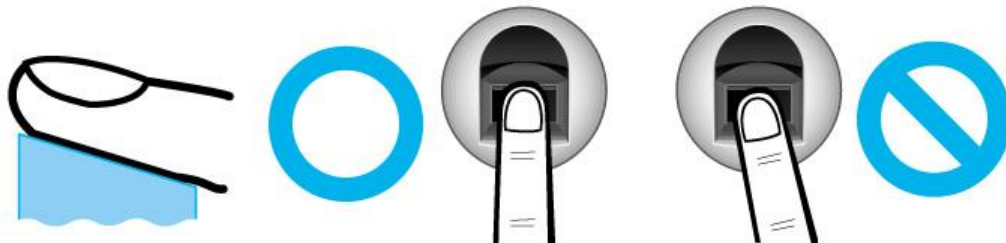

- Enter the fingerprint of your forefinger if possible.

When using your forefinger, you can enter your fingerprint correctly and safely.

- Make sure that the fingerprint is unclear or wounded.  
Too dry, wet, blurry or wounded fingerprints are difficult to recognize. In this case, the fingerprint of another finger should be registered.



- Precautions subject to your fingerprint status

The availability of the fingerprint may vary subject to your fingerprint status.

- This product consists of a fingerprint recognition system and cannot recognize the damaged or unclear fingerprints. The fingerprint should be registered using the RF card.
- **If your hands are dry, you can blow your breath on the system** to operate it more smoothly.
- For children, too small or unclear fingerprints may be difficult or impossible to use. They need to register a new fingerprint every six months.
- For seniors, the fingerprint with too many lines may not be registered.
- It is recommended that you will register more than two fingerprints if possible.
- In order to increase the fingerprint authentication rate, it is recommended to use six of the ten fingers as illustrated below (both thumbs, forefingers, middle fingers).

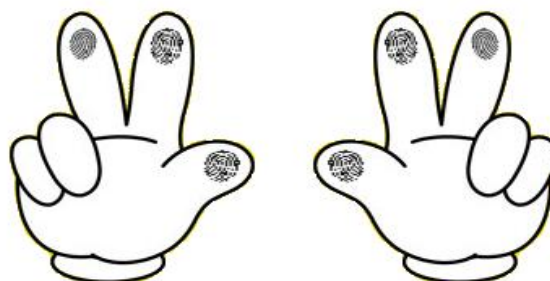

## 2. Product Descriptions

### 2.1. Product Features

- Easy to verify your ID via fingerprint
  - The use of the fingerprint recognition technology (Biometrics) can prevent forgetting your password, losing your card or key, or avoid the risk of their theft. The use of personal fingerprints enhances the security of authentication.
- Waterproof and dustproof functions
  - Acquired the IP65 level of waterproof and dustproof certification.
- Various card options
  - 13.56MHz-based Mifare and HID iClass cards are supported optionally.
- Access control system using the local area network (LAN)
  - The fingerprint reader communicates with the authentication server using a TCP/IP protocol. Therefore, this terminal can be applied to the existing LAN and has easy expandability. It ensures a fast speed by **10/100 Mbps Auto Detect** and facilitates management and monitoring via the network.
- **Mobile interlocking function**
  - By using Smartphone Bluetooth, the terminal can be set to Admin App (iAccess Plus).

## 2.2. Configuration Diagram

### 2.2.1. Standalone Use (Access)

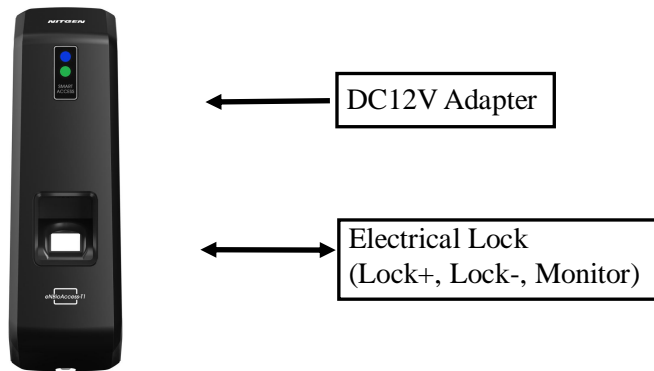

### 2.2.2. Connecting to the PC server (Access, T&A)

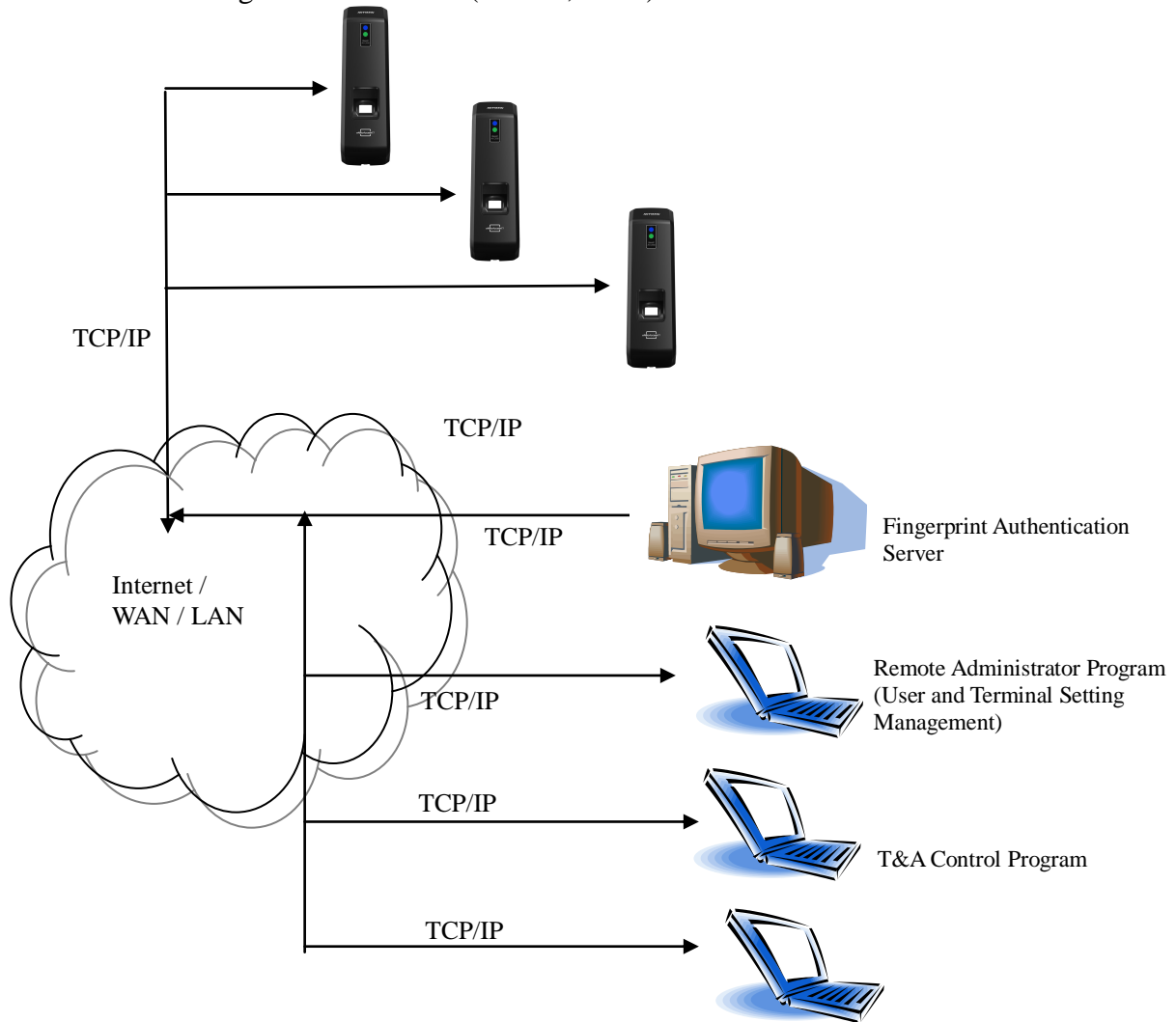

## 2.3. Product Specification

ITEM	SPEC	REMARKS
CPU	400MHz 32Bit RISC CPU	
MEMORY	4MB Nor Flash + 256MB Nand Flash	
	64MB RAM	
Authentication Speed	1:1 < Within 0.2 second 1:N < Within 1 second (Based on 2,000 fingerprints)	
Number of Users	10,000 User / 10,000 Card 10,000 Finger 100,000 Log	
Fingerprint Sensor	Optical	
Scan Area / Resolution	16 * 18mm / 500 DPI	
Temperature / Humidity	-20 ~ 60 °C / Lower than 90% RH	
AC / DC Adapter	INPUT : Universal AC100 ~ 250V	
	OUTPUT : DC 12V (Option : DC 24V)	
	UL, CSA, CE Approved	
Lock Control	EM, Strike, Motor Lock, Auto Door	
I/O	3 In (1 Exit, 2 Monitor)	
Communication Port	TCP/IP (10/100Mbps)	Authentication Server Communication
	RS-485	Controller Communication
	Wiegand In/Out	Card Reader or Controller Communication
Card Reader	High Frequency(13.56MHz) – Mifare, HID iClass	Optional
Foreign Authentication	KC, CE, FCC	
SIZE	75.0mm(W) * 182.5mm(H) * 39.2mm(D)	

### 3. Environment Setting

#### 3.1. Checkpoints before environment setting

##### 3.1.1. To run iAccess Plus (Mobile App)

Search “iAccess Plus” at the smartphone app store to install a mobile app. Press “iAccess Plus” icon installed on your smartphone to run the program. The initial screen will appear. After 2-3 seconds, it will automatically go to the Intro menu.

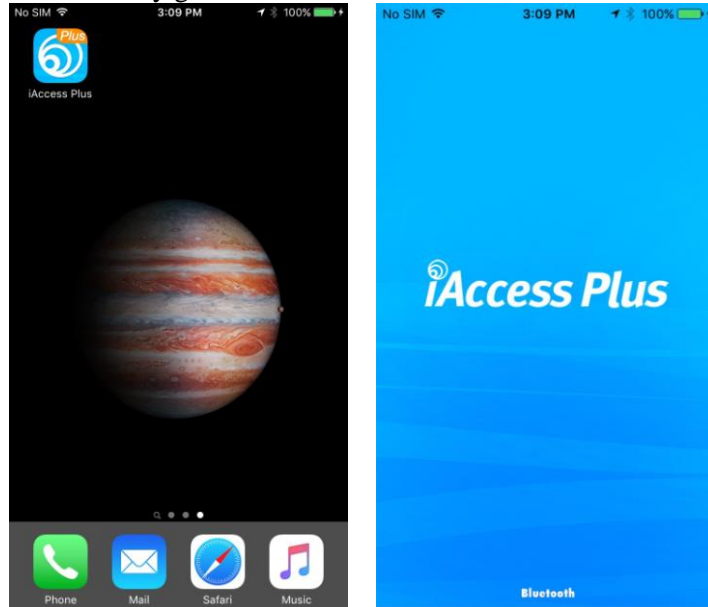

##### 3.1.2. To enter the administrator menu

Select [View] button on the [Terminal List] screen, and the connection window will appear.

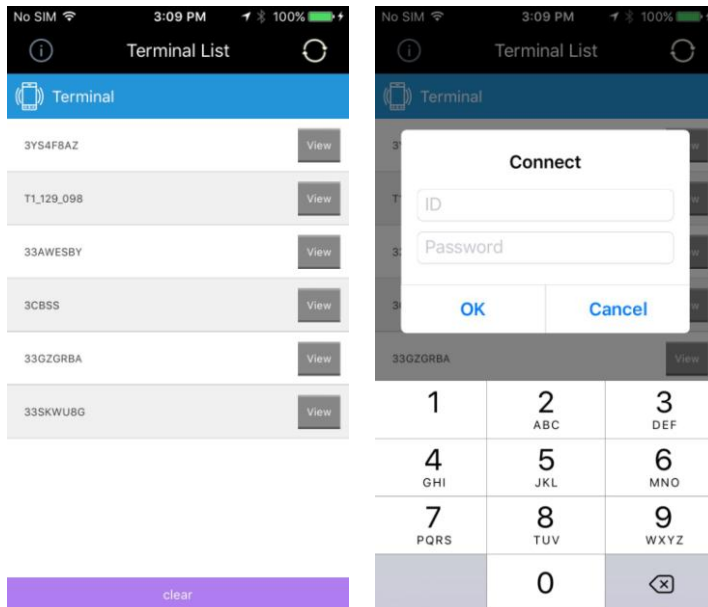

If no administrator is registered, you can access the terminal without entering your ID and password on the login window.

If any administrator has been registered, you can access the terminal using the proper administrator authentication scheme.

If your ID is entered, attempt 1:1 Authentication. If your ID is not entered, attempt 1:N Authentication. If you have successfully logged in the terminal, the screen goes to the User Management screen.

## 3.2. User Management

### 3.2.1. Add User

Select [Add] on the [User Management] screen, and the following screen will appear.

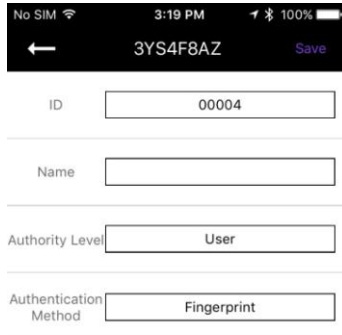

The screenshot shows the 'Add User' screen with the following fields:

- ID: 00004
- Name: (empty)
- Authority Level: User
- Authentication Method: Fingerprint

Enter your registration information on the Add User screen.

When the information is completely entered, select the [Save] button in the top right of the screen.

Once the user information has been correctly entered, the fingerprint is ready to be entered in either the terminal or the card.

If the set authentication scheme is completely registered, the screen returns to the User Management screen.

### 3.2.2. Delete

Select [Edit] on the [User Management] screen, and the following screen will appear.

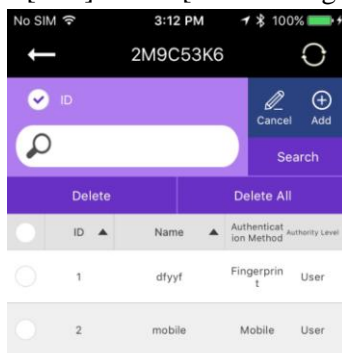

The screenshot shows the 'User Management' screen with the following elements:

- Header: 2M9C53K6
- Search bar with a magnifying glass icon.
- Buttons: Delete, Delete All, Cancel, Add.
- Table of users:

ID	Name	Authentication Method	Authority Level
1	dfyyf	Fingerprint	User
2	mobile	Mobile	User

To delete all users, press the [Delete All] button. To delete part of users, select any delete target users, and press the [Delete] button. (When the network mode is set, the [Delete All] button is disabled.)

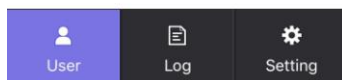

The screenshot shows the bottom navigation bar with three buttons: User, Log, and Setting.

### 3.3.3. Change

Click the user to change on the [User Management] screen, the screen will go to the [User Details] screen.

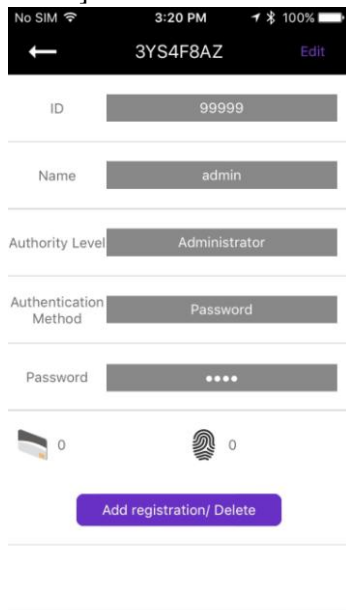

The screenshot shows a mobile application interface for user management. At the top, the status bar displays 'No SIM', signal strength, time '3:20 PM', Bluetooth, and 100% battery. Below the status bar is a header with a back arrow, the user ID '3YS4F8AZ', and an 'Edit' button. The main content area consists of several rows, each with a label and a text input field: 'ID' with '99999', 'Name' with 'admin', 'Authority Level' with 'Administrator', 'Authentication Method' with 'Password', and 'Password' with four dots. Below these fields are two icons: a card icon and a fingerprint icon, both with a '0' next to them. At the bottom, there is a purple button labeled 'Add registration/ Delete'.

When you select the [Save] button after modifying the items except the ID, if there is any additional authentication means, the terminal becomes the input standby status and carries out additional registration.

When the change is completed, the screen returns to the User Management screen.



### 3.3. Terminal Setting

#### 3.3.1. Setting via “iAccess Plus”

Select [Setting] on the bottom right, and the following screen will appear.

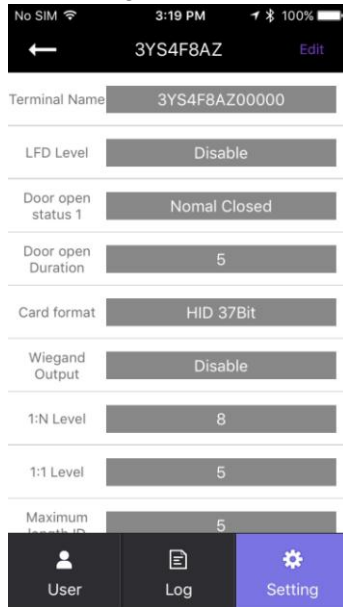

To change the terminal settings, press the [Edit] button on the top right to switch to the edit mode.

When the terminal settings are finished, press the [Save] button to save the changes and exit the setting.

Terminal Name

The name of the terminal will be displayed.

LFD Level

The fake fingerprint is likely to be recognized. Therefore, the higher level of security application may be used. The higher security level may need the longer time to verify the fingerprints of some registered users. The security level for the stage of 0-3 is supported.

Door Open Status 1

Set when connecting external contacts.

Settings	Display Method
No Use	No external lock is used.
Normal open	When the power is applied, the lock is open.
Normal close	When the power is applied, the lock is closed.

Door Open Interval

The unlock time can be set from 0.1 to 20 seconds.

Card Format

The type of card to be used can be set.

Settings	Display Method
No Use	Do not use the card authentication
EM	Use a low-frequency (125KHz) EM card
MIFARE	Use a high-frequency (13.56MHz) MIFARE card
HID 26bit	Use a low-frequency (125KHz) HID 26 Bit card
HID 35Bit	Use a low-frequency (125KHz) HID 35 Bit card
HID 37Bit	Use a low-frequency (125KHz) HID 37 Bit card
iClass 26Bit	Use a HID iClass 26 Bit card
iClass 35Bit	Use a HID iClass 35 Bit card
iClass 37Bit	Use a HID iClass 37 Bit card

Wiegand Output

This mode is available if the terminal is equipped with a separate controller operated by Wiegand input.

Settings	Display Method
No Use	Do not use the Wiegand communication
26Bit	Perform the Wiegand communication by a format of 26Bit
34Bit	Perform the Wiegand communication by a format of 34Bit

Device Mode

If reader mode is selected, wiegand output is Card Number when authentication is Success.

If access control is selected, wiegand output is User's ID when authentication is Success.

Sitecode

Set the value of Sitecode to transfer upon Wiegand output.

If Wiegand output is 26bit, a value of 0 to 255 can be set. If Wiegand output is 34Bit, a value of 0 to 32767 can be set.

Ext 485

Can select external RS 485 device.

If is select CP040, CP040 process authentication and lock control, log data.

485 ID

Can assign ID of External RS 485 device to 0-7.

1:N Level

When 1:N authentication, set the verification level to 5-9.

1:1 Level

When 1:1 authentication, set the verification level to 1-9.

Max ID Length

This indicates the length of ID which can be entered to the maximum.

Network Mode

Set whether the terminal is used to either a stand-alone mode or a network mode.

- Node ID  
Set the terminal ID to add to ACM Pro in the range of 1 to 2000.
- Use DHCP  
Set whether to use a static IP.
- Terminal IP  
Set the terminal IP.
- Server IP  
When the terminal is used in conjunction with Access Manager, set the server IP.
- Subnet Mask  
Set the subnet mask value of the terminal.
- Gateway  
Set the gateway value of the terminal.
- Port No.  
Set the Access Manager Server port to 2000-65535. (Default: 7332)
- Network Timeout  
Set the communication cycle time between the Access Manager server and the terminal to the range of 2-20.
- Time Synchronization  
Set time of device to time of smart phone.
- Firmware Version  
The terminal firmware version and the BLE firmware version are displayed.
- Initialize  
All data except logs and user information are initialized.
- Factory Initialization  
Initialize the settings of the terminal as set at a factory.

※ The terminal is rebooted after saving the settings. Therefore, it is recommended to access the terminal after the lapse of 30 to 60 seconds.

3.3.2. To set the terminal IP via Access Manager

By running terminal search items in the terminal management menu of Access Manager Professional, perform the setting of terminal IP.

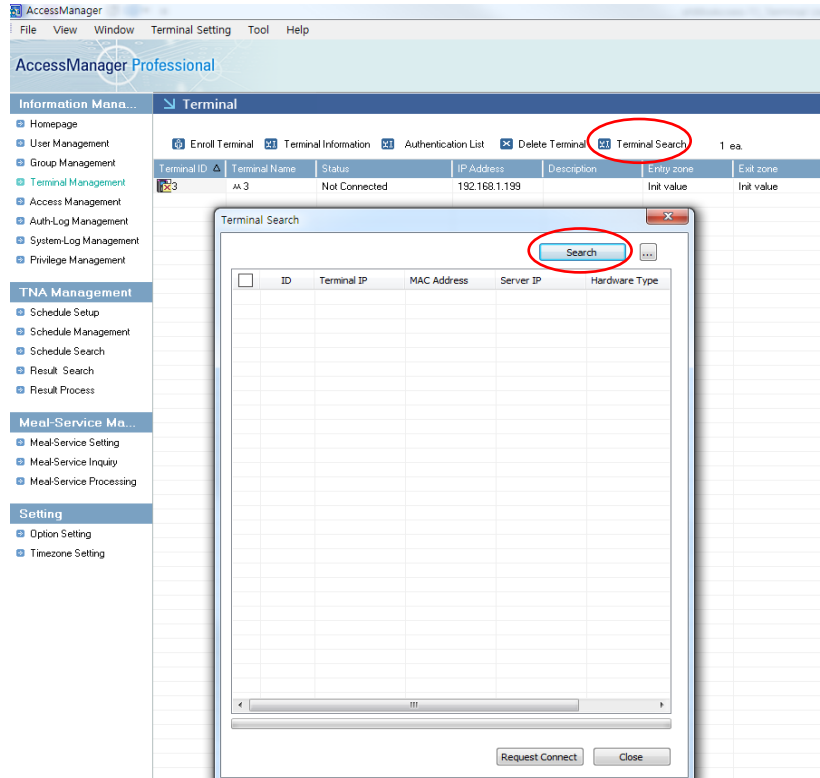

When clicking the Search button on the above screen, the unregistered terminals in Access Manager Professional will appear as shown below.

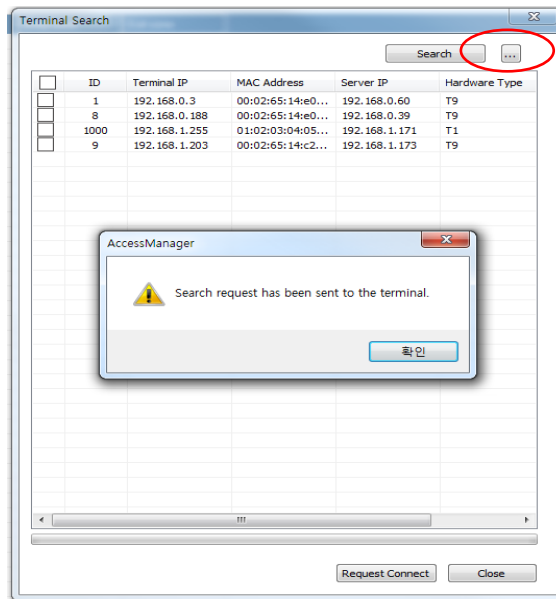

When clicking the “...” button, the detailed setting screen will appear as shown below.

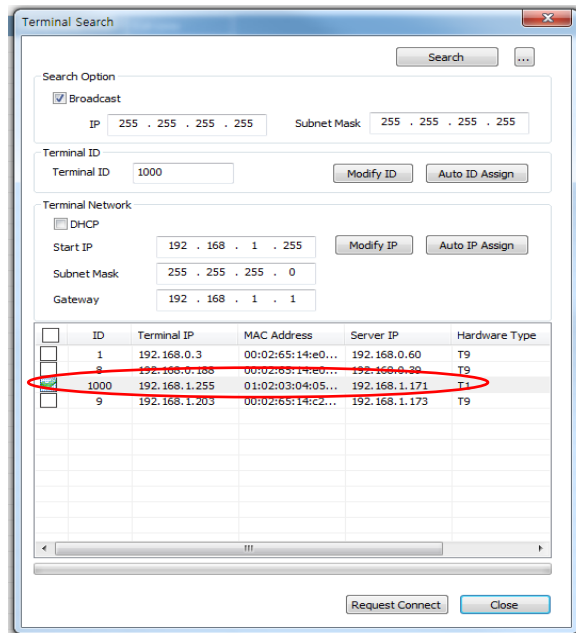

To change the terminal ID and network settings, select the terminal to set, enter the change value, and click the “ID Change” or “IP Change” button. Then, you can check that the terminal value is changed.

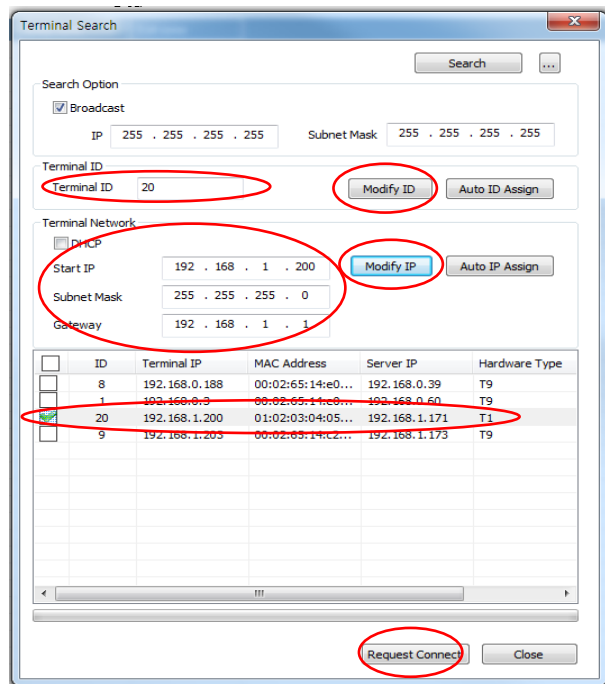

Set Terminal ID and Terminal Network and then click the “Request Connect” button at the bottom, and the terminal will appear as the unregistered status on the Access Manager Professional screen and the settings will be finished.

Terminal ID	Terminal Name	Status	IP Address	Description	Entry zone	Exit zone
1000	AA 3	Not Enrolled	192.168.1.255		Init value	Init value
20	AA 3	Not Enrolled	192.168.1.200		Init value	Init value

※ For more details, please refer to the Access Manager Professional Manual.

## 4. How to Use Terminal

### 4.1. Authentication

#### 4.1.1. Fingerprint Authentication

Place your finger on the fingerprint sensor. Then, the fingerprint sensor will light on and receive fingerprint input. Keep your finger on the fingerprint sensor until the light turns off completely.

#### 4.1.2. Card Authentication

Place the card on the card sensor of the terminal.

#### 4.1.3. Multi Authentication

For users who have to be authenticated by the combination authentication methods such as “Card and Fingerprint”, if the first input authentication method is successful, the remaining authentication method is performed.

## 5. Troubleshooting

### 5.1. When the fingerprint authentication time is too long or fails

- When the terminal operates by the 1:N (Server) authentication in the network mode, if the server is used for personal or business use, a server load may reduce the fingerprint recognition rate and require the long fingerprint authentication time. It is recommended to build a dedicated server.
- Check that there are any scratches or foreign matters in your finger or FP sensor. If there are foreign matters, wipe them with a dry cloth. If there is a large scratch, re-register another fingerprint through the administrator.
- If the fingerprint status is bad, lower the individual security level in the user information and attempt 1:1 Authentication.
- If the RF card registered by the user's ID has been authenticated, when the fingerprint authentication fails, whether the user exists or not is verified. Check that the user is a registered user.

### 5.2. When the fingerprint is not entered well

Very dry or wet fingerprints may not be normally entered.

If the fingerprint is wet, wipe it with a dry towel. If the fingerprint is dry, blow your breath or apply oil on your hands. Then, try to enter the fingerprint again.

### 5.3. When the RF card authentication fails

Check that the card possessed by users conforms to the card type set in the "RF Card Type" in the "Option Setting" of the Access Manager program.

### 5.4. When the network is not connected

- Check that the terminal is registered in the terminal management item in the information management menu of Access Manager Professional.
- If the terminal is not registered, check that it is set in the terminal search of Access Manager Professional.
  - Server IP of which Access Manager Professional is installed
  - Check that the terminal ID is set up correctly.
  - If DHCP is not used, check the relevant information.



#### 5.5. When the authentication is successful but the door does not open

Check that the access is controlled by the time zone.

#### 5.5. When the user is not registered

This product is set by default to operate as a network mode.

If the connection is abnormal in the network mode, the user cannot be registered.

Check the network connection status.

#### 5.6. When the product is unstable or does not work

- Select the terminal in the terminal management menu of Access Manager Professional, click the right mouse button, and select the [terminal Restart] item. Then, the terminal will restart.
- If the server management program is being used, try to run the server again.
- If the terminal does not normally work after checking all of the above, please contact our Customer Support Team.

## FCC Information

This device complies with part 15 of the FCC Rules. Operation is subject to the following two conditions :

- (1) This Device may not cause harmful interface, and
- (2) This device must accept any interference received, including interference that may cause undesired operation.

Note: This equipment has been tested and found to comply with the limits for CLASS B digital device, pursuant to Part 15 of FCC Rules. These limits are designed to provide reasonable protection against harmful interference when the equipment is operated in a commercial environment This equipment generates, uses and can radiate radio frequency energy and, if not installed and used in accordance with the instructions, may cause harmful interference to radio communications. However, there is no guarantee that interference will not occur in a particular installation. If this equipment does cause harmful interference to radio or television reception, which can be determined by turning the equipment off and on, the user is encouraged to try correct the interference by one or more of the following measures:

- 1.1. Reorient or relocate the receiving antenna.
- 1.2. Increase the separation between the equipment and receiver.
- 1.3. Connect the equipment into an outlet on a circuit different from that to which receiver is connected.
- 1.4. Consult the dealer or experienced radio/TV technician for help.

## WARNING

Changes or modifications not expressly approved by the manufacturer could void the user's authority to operate the equipment.

“CAUTION : Exposure to Radio Frequency Radiation.

This equipment should be installed and operated with a minimum distance of 20 cm between the radiator and your body.