Copyright Statement: “© 2005 UTStarcom, Inc. All rights reserved. No part of this publication may be reproduced in any form or by any means without the prior written permission of UTStarcom, Inc.”

Warranty Language: “The contents of this guide, whether in whole or in part, do not constitute any express or implied warranty with respect to any products of UTStarcom, Inc., or its affiliates.”

Doc. Code:

Table of Contents

SAFETY PRECAUTIONS	1
FCC RF EXPOSURE COMPLIANCE	1
HANDLING THE PHONE, BATTERY AND CHARGER	2
HANDLING THE PHONE	3
HANDLING THE BATTERY	5
HANDLING THE CHARGER	6
1. GETTING STARTED	7
1.1 PACKAGE CONTENTS	7
1.2 PHONE SPECIFICATIONS	8
1.3 HANDSET DESCRIPTION	9
1.4 DISPLAY INDICATORS	11
1.5 CHARGE THE BATTERY	12
1.6 REPLACE THE BATTERY	13
1.7 CONVENTIONS USED IN THIS GUIDE	14
1.8 ACCESS MENU/LIST OPTIONS	15
2. BASIC OPERATIONS	16
2.1 SWITCH THE PHONE ON/OFF	16
2.2 MAKE A CALL.....	16
2.3 USE SPEED DIAL	17
2.4 ANSWER A CALL	17
2.5 REJECT A CALL.....	18
2.6 IN CALL OPERATIONS.....	18
2.6.1 Hold a Call	18
2.6.2 Call Waiting.....	19
2.6.3 Make a New Call.....	19
2.6.4 Conference Call	20
2.6.5 Transfer a Call	21
2.6.6 Mute the Microphone Volume	21
2.6.7 Access the Phonebook	21
2.6.8 Adjust the Listening Volume	22

2.7 STORE A PHONE NUMBER	22
2.8 CALL LOG SHORTCUT	23
2.9 CUSTOM FUNCTIONS SHORTCUT	23
2.10 PROFILES SHORTCUT	24
2.11 VIBRATION SHORTCUT	24
3. PHONEBOOK (NAMES)	25
3.1 SEARCH	25
3.1.1 Edit	26
3.1.2 Del Contact	27
3.1.3 Group Members	27
3.1.4 Call	27
3.1.5 Send Message	27
3.1.6 Send Email	27
3.2 ADD ENTRY	27
3.3 DELETE	29
3.3.1 One by One	29
3.3.2 All	29
3.4 GROUP INFO	30
3.4.1 Ring Tone	30
3.4.2 Browse	30
3.5 SPEED DIAL	31
3.6 MEMORY	32
4. MENU	33
4.1 MESSAGES	33
4.1.1 Text Message	33
4.1.2 Email	40
4.2 CALL LOG	50
4.2.1 Missed Log	50
4.2.2 Received Log	53
4.2.3 Dialed log	56
4.2.4 Duration	59
4.3 PROFILES	60
4.3.1 Standard	60
4.3.2 Meeting	64

4.3.3 Outdoor.....	64
4.3.4 User Define.....	64
4.4 SETTINGS	65
4.4.1 Date/Time	65
4.4.2 Display.....	66
4.4.3 Set Handset.....	68
4.4.4 Set Security	69
4.5 TOOLS	73
4.5.1 Alarm	73
4.5.2 Calendar.....	75
4.5.3 Calculator	77
4.5.4 Time Zone.....	78
4.6 GAMES	79
4.6.1 Sand Volleyball	79
4.6.2 Gobang.....	80
4.7 WiFi	81
4.7.1 Net Search.....	81
4.7.2 WiFi Config	82
4.7.3 Network Parameter.....	84
4.7.4 Signal Protocol.....	87
4.8 NETWORK	92
4.8.1 Call Waiting.....	92
4.8.2 Call Transfer	92
4.8.3 Three Way Call	93
4.8.4 Register Interval Time	93
4.8.5 Caller-ID Block.....	93
4.8.6 Repeat Dial on Busy	94
4.8.7 Reject Anonymous Incoming Call	94
4.8.8 Personal Information.....	94
4.8.9 Personal Information.....	94
4.9 MISC.....	95
4.9.1 Vendor Information.....	95
4.9.2 PC Config	95
4.9.3 Remote TFTP Update	95
4.9.4 Remote TFTP Server	96
4.9.5 Local TFTP Update.....	96
4.9.6 Local Log.....	96

4.9.7 Web Authentication	97
5. INPUT METHOD.....	98
5.1 SWITCH INPUT METHOD	98
5.2 PINYIN AND STROKE.....	98
5.3 ENGLISH	98
5.4 LETTER.....	100
5.5 DIGIT	101
5.6 SYMBOLS	101
6. TROUBLESHOOTING.....	102

SAFETY PRECAUTIONS

FCC RF Exposure Compliance

This PCS phone has been tested and complies with the Federal Communications Commission (FCC) RF exposure limits for the General Population/Uncontrolled exposure environment. In addition, it complies with the following Standards and Guidelines:

- FCC 96-326, Guidelines for Evaluating the Environmental Effects of Radio-Frequency Radiation
- FCC OET Bulletin 65 Edition 01-01 (2001) Supplement C, Evaluating Compliance with FCC Guidelines for Human Exposure to Radio Frequency Electromagnetic Fields
- ANSI/IEEE C95.1-1992, IEEE Standard for Safety Levels with Respect to Human Exposure to Radio Frequency Electromagnetic Fields, 3 kHz to 300 GHz
- ANSI/IEEE C95.3-1992, IEEE Recommended Practice for the Measurement of Potentially Hazardous Electromagnetic Fields - RF and Microwave



Note: *For body-worn operation, this phone has been tested and meets FCC RF exposure guidelines when used with an accessory that contains no metal and when the back of the phone faces your body*



Use of other accessories may not ensure compliance with FCC RF exposure guidelines



The antenna used for this transmitter must not be co-located or must not operate in conjunction with any other antenna

Handling the Phone, Battery and Charger



DANGER

 Compulsory	Only use the battery and charger specified for the phone. Failure to do so can result in damage to the phone, electric shock or fire
---	--

CAUTION

 Prohibited	Do not store or operate the phone or charger in hot, damp, or dusty areas, which can damage electrical and mechanical components. Avoid prolonged exposure to temperatures below 5°C or in excess of 35°C
---	---

DANGER

 Prohibited	Do not drop, shake or throw the phone or charger. Rough handling can damage internal circuit boards and the battery pack
 Prohibited	Do not use the phone in the vicinity of volatile gases. Leave the area before using the phone. Failure to leave the area can result in the risk of fire or an explosion
 Disassembly prohibited	Do not disassemble or modify the phone, charger, or battery. Incorrect modifications, reassembly, or tampering may result in malfunction or personal injury

Handling the Phone

This device complies with Part 15 of the FCC Rules. Operation is subject to the following two conditions:

- This device may not cause harmful interference
- This device must accept any interference received, including interference that may cause undesired operation

DANGER



Compulsory

This phone has been tested and found to comply with the limits for a Class B digital device, pursuant to Part 15 of the FCC Rules. These limits are designed to provide reasonable protection against harmful interference in a residential installation. This phone generates, uses and can radiate radio frequency energy and, if not installed and used in accordance with the instructions, may cause harmful interference to radio communications. However, there is no guarantee that interference will not occur in a particular installation. If this phone does cause harmful interference to radio or television reception, which can be determined by turning the phone off and on, the user is encouraged to try to correct the interference by one or more of the following measures:

Reorient or relocate the receiving antenna

Increase the separation between the phone and receiver

Connect the phone into an outlet on a circuit different from that to which the receiver is connected

Consult the dealer or an experienced radio/TV technician for help



Compulsory

Observe local regulations for specialized areas (hospital, aircraft, etc) when using the phone

Safety Precautions



Prohibited

Do not use the phone while operating a vehicle



CAUTION



Compulsory

Changes or modifications not expressly approved by UTStarcom, Inc. could void the user's authority to operate the phone



Prohibited

Keep all storage media (magnetic cards, floppy disks, credit cards, etc.) away from the phone. Close encounters or contact can erase or damage the storage media



Prohibited

Keep all sharp metal objects (pins, nails, hairpins etc.) away from the phone handset. The handset earpiece contains a strong magnet that can attract and hold metal objects. Remove any objects from the handset earpiece before using, to avoid personal injury









Compulsory



In case of emergency, key in the emergency number (911 for example in US), then press the Talk key and let the operator know your specific location. Don't hang up until you are told to do so

Handling the Battery

DANGER





 Prohibited	Do not dispose of the battery pack in a fire. It may explode. Check with local waste management codes for disposal instructions
 Prohibited	Do not force the battery pack into the phone. Improper installation can cause malfunctions or damage the battery pack. This may result in fire or personal injury
 Prohibited	Use caution in handling batteries in order not to short the battery on conductive materials such as rings, bracelets, and keys. The battery and/or conductor may overheat and cause burns
 Disassembly prohibited	If the battery becomes too hot while recharging, it should be removed immediately from the charger
 Compulsory	When clothes or skin are exposed to battery leakage, rinse with clean water at once to prevent skin irritation
 Compulsory	Do not use a cracked, leaking or odor-emitting battery pack near an open flame or high temperatures

CAUTION



 Compulsory	If a fully discharged battery is stored for a long period of time, it may not be possible to recharge the battery
 Prohibited	Observe local waste management codes for proper battery disposal instructions

Handling the Charger

DANGER

 Compulsory	Only use a power source that provides the appropriate voltage (AC100~240 V) for the charger. An unsuitable power source can result in damage to the charger, fire or electric shock
 Compulsory	Do not use the charger if the power supply cord or plug is damaged or frayed (exposed or broken wires, etc). This can result in the risk of fire or electric shock
 Prohibited	Do not short circuit the charger connector jack. This may result in fire or electric shock
 Remove power plug	Immediately unplug the charger from the wall outlet in the event that liquid is spilled into the unit to prevent fire or electric shock

CAUTION

 Compulsory	Always unplug the charger from the wall outlet before cleaning to avoid the risk of electric shock
 Prohibited	Do not place heavy objects on the cord to avoid damage
 Compulsory	Always grip the power plug when removing the charger from the wall outlet. Do not pull on the power supply cord to avoid damage and the risk of electric shock

1. GETTING STARTED

1.1 Package Contents

Please check the package contents by comparing them with the following list. If you find anything missing or if the documentation set is incomplete, contact your local phone dealer immediately.

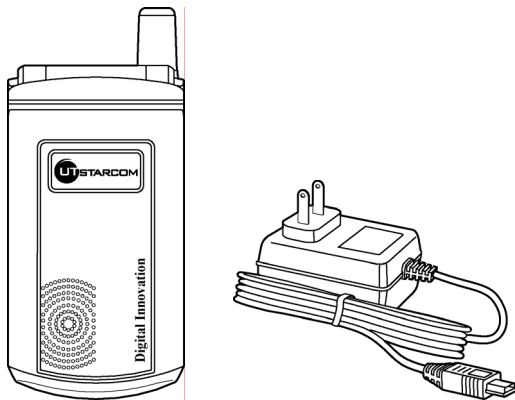

- Model F3000 (with one battery)
- Charger (one)
- User Guide (one)
- Quick Start Guide (one)
- Certificate of quality

1.2 Phone Specifications

Dimensions	About 85 x 43 x 22 (L×W×H) mm
Weight	Approximately 90g
Battery	DC 3.7V 1100mAh Li-ion battery
Charger	Input: 100~240V AC, 50~60Hz Output: 5.2V DC, 600mA
Charger Weight	Approximately 80g
Charging Time	Approximately 5 hours
Standby Time	Approximately 75 hours
Talking Time	Approximately 3 hours

- Standby time refers to the state in which the phone is on continuously without being used for calls, or moved to different service areas
- The standby time depends on the network conditions, phone usage and surrounding area. The phone consumes more battery power under the following conditions:
 - In areas with weak signals, with high or low temperatures, or when used outside the service coverage area
 - When the phone frequently searches for network signal due to location changes
 - When you talk on the phone for long periods of time
 - The Alarm, Backlight or Vibration function is active
 - Ring or listening volume is set to maximum

1.3 Handset Description

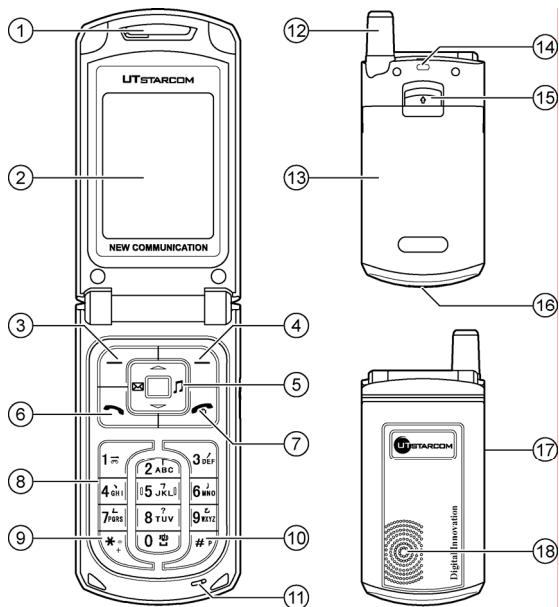

1. Earpiece
2. LCD Screen
3.  Left Soft Key:

This key is used to perform the function indicated on the screen above it.

Getting Started

4.  Right Soft Key:

This key is used to perform the function indicated on the screen above it.

5.  Navigation Key:



This key is used to scroll up and down through menu lists.

6.  Talk Key:

This key is used to make or receive a call. It can also be used to access outgoing call logs in standby mode.

7.  Power Key:

This key is used to switch the phone on and off, to end a call, or to return to standby mode.

8.  ~  Number Keypad:

These keys are used to enter numbers and characters.

9.  * Key/Switch Key:

This key is used to key in “*” or “+” (by pressing and holding the key), or to change the text input method.

10.  # Key:

This key is used to key in “#” or pause symbol “P” (by pressing and holding the key).

11. Microphone

12. Fixed Antenna

13. Battery

14. Slot for Hand Strap

15. Battery Release Button

16. Charging Socket

17. Earphone Socket

18. Speaker



 **Note:** This is only a brief introduction to the keypad functions. Please refer to the contents of this user guide for detailed descriptions and operations.

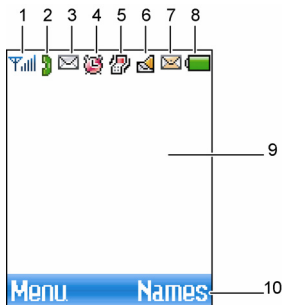





1.4 Display Indicators





1.  Shows the current signal strength. The higher the bar, the stronger the signal.



2.  Refers to the calling or connecting mode.
3.  Indicates a new text message has been received.
4.  Indicates the Alarm function is active.





5.  Means the Ring Mode is set to **Vibration**; if the Ring Mode is set to **Vibration And Ring** or **Ring After Vibration**,  will be displayed; if the Ring Mode is set to **Mute**,  will be displayed. If the **No Disturb** function is active,  will be displayed.
6.  Indicates a new voice mail has been received.
7.  Indicates a new email has been received.
8.  Indicates the battery charge level. The higher the bar, the greater the battery power.



9. Content Display Area: Shows phone numbers, characters, etc.
10. Soft key function display area: Shows the functions of the left soft key  and the right soft key .

1.5 Charge the Battery

When the battery power is low and needs recharging, the battery indicator  will flash continuously, and the phone will sound a low battery alarm (if the Ring Mode is set to neither **Vibration** nor **Mute**), reminding you that the battery is running low and the phone will be switched off automatically. To charge the battery, follow the steps below:

1. Connect the charger to an AC wall outlet (100~240V).
2. Connect the lead from the charger to the charging socket of the phone. The battery indicator bar starts to scroll ( →  →  → ). If the phone is off, the text "**Charging...**" is also displayed on the LCD screen.

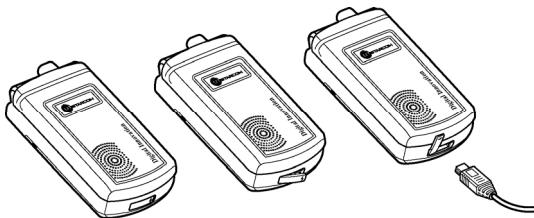

3. When the battery indicator bar stops scrolling, charging is complete. The text **"Fully Charged!"** is also displayed on the LCD screen, if the phone is off.
 - The phone takes about **5 (?)** hours to charge and the exact time may vary depending on the circumstances
 - With your phone turned off, charge your new battery for **6 (?)** hours before its first use
 - When the battery is being charged, it is normal that your charger and phone become warm to the touch
 - If the phone is turned on while charging, you can still make and receive calls as usual, but this will consume battery power, thus extending the charging time

1.6 Replace the Battery

Since battery power is easily consumed, if you find the battery power diminishes quickly after full charging, please replace your battery. After replacing the battery, you will need to reset the date and time.

1. In standby mode, switch the phone off by pressing and holding . (Otherwise, some user settings will be lost.)

Getting Started

2. Remove the battery.

With the back of the phone facing you, press the release button and lift the battery off.

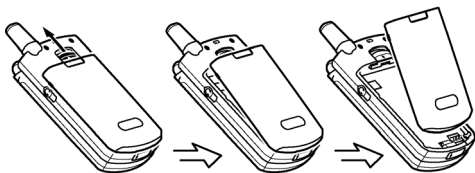

3. Install the new battery.



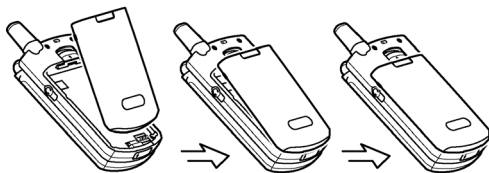



Slide the new battery as illustrated until it locks into place.



1.7 Conventions Used in this Guide

- In this guide, “press the key” means to release the key after you press it; “press and hold the key” means to press the key for over 2 seconds before releasing it
- The text displayed on the screen is indicated in bold in this guide, for example **Menu**
- Most operations need to be performed in standby mode. When the left soft key function is **Menu**, the phone is in standby mode





- Navigation key  operations follow:

	Press the “Up”, “Down”, “Left”, and “Right” directions on the Navigation key to execute operations such as browsing, selecting, adjusting and setup; key directions are as follows:				
					
Up	Down	Up or Down	Left	Right	Left or Right



1.8 Access Menu/List Options

A variety of options are available for the menus and lists, such as: **Menu** and **Names**.

For example, to access **Menu**→**Tools**→**Alarm**, follow the steps below:

- In standby mode, press the left soft key  (**Menu**).
- Press  to reach **Tools**, and then press the left soft key  (**Ok**).
- Press  to highlight **Alarm**, and then press the left soft key  (**Ok**).

If there is a number in front of the intended option, you can access the option by directly pressing the corresponding number key.

-  **Note:** To return to the previous menu level, press the right soft key  (**Back**). To return to standby mode without changing the menu settings, press .

2. BASIC OPERATIONS

2.1 Switch the Phone On/Off

Press and hold the power key . The phone will display the power-on/off animation.



If the PowerOn Code function is active, after switching on the phone, enter the security code (with each input displayed as *) and press the left soft key  (**Ok**). If correct, the power-on animation will be displayed; otherwise **Code Error** will be displayed.

2.2 Make a Call





Note: Prior to making or receiving calls, the phone must be connected to a wireless Access Point (AP) and registered with the network. See "WiFi" on page 81 for detailed instructions.



1. Key in the phone number.

Press  to move the cursor. Press the right soft key  (**Clear**) to delete the character or digit to the left of the cursor. To delete all the numbers or characters, press and hold the right soft key  (**Clear**).

2. Press  to call the number. "**Connect...**" will be displayed.

To cancel the call attempt, press the right soft key  (**Cancel**); a time display of **00:00:00** will appear. You can also press the  key to cancel the call; the phone will return to standby mode.



3. When the call is connected, the call timer is displayed.

4. To end the call, press the right soft key  (**Hangup**) or the  key, or close the flip cover.



Note: If the Repeat Dial on Busy function is active, the phone will enable you to automatically redial the last busy number that you tried to dial. After you dial a busy number, **“Unconnected! Redial?”** will be displayed. Press the left soft key  (**OK**); the phone will make a maximum of 60 automatic attempts to dial this number until it can be reached

2.3 Use Speed Dial

If you have assigned a phone number to one of the speed dial keys  ~ , you can quickly call that phone number:







1. In standby mode, press and hold the corresponding speed dial key to automatically display the phone number.
2. Press  to call the number.



For details of speed dial settings, refer to “Speed Dial” on page 31







Note: Pressing and holding  in standby mode will call the voice mail access number. (Refer to “Voice Mail” on page 91.)

2.4 Answer a Call

- In the case of Answer Mode set to **Flip Key**, if the flip cover is closed, you may answer an incoming call by opening the flip cover; if the flip cover is opened, press the left soft key  (**Answer**) or the  key to answer the call
- If the Answer Mode is set to **Talk Key**, press the left soft key  (**Answer**) or the  key to answer an incoming call
- If the Answer Mode is set to **Any Key**, press any key to answer an incoming call except the right soft key , the  key or the  key

- When there is an incoming call, you may press  to stop the vibration or ring alert without picking up the call
- To end an ongoing call, press the right soft key  (**Hangup**) or the  key, or close the flip cover

2.5 Reject a Call



- When there is an incoming call, press the right soft key  (**Hangup**) or the  key to reject the call
- If you press the right soft key  (**Hangup**) to reject an incoming call, the call duration **00:00:00** will be displayed
- When there are missed calls (excluding rejected calls), the phone will prompt you. In this case, press the left soft key  (**View**) to enter the missed call log (**Missed Log**)





2.6 In Call Operations

While on a call, you can perform the following operations:

2.6.1 Hold a Call



You can place an ongoing call temporarily on hold.

During a call, press the left soft key  (**Option**), and then press the left soft key  (**Ok**) to select **Hold**.













- To take the call off hold, press the left soft key  (**Option**), and then press the left soft key  (**Ok**) to select **Unhold**
- To end the held call, press the right soft key  (**Hangup**) or the  key, or close the flip cover

2.6.2 Call Waiting



If the Call Waiting function is activated (refer to “Call Waiting” on page 92), when another call comes in during a call, the earpiece will sound a waiting tone.



- To reject the incoming third party call and continue the current call, press the right soft key  (**Hangup**)
- To hold the current call and answer the incoming third party call, press the left soft key  (**Answer**) or the  key

After answering the third party call, you can perform the following operations:













- Press the left soft key  (**Option**). Press  to highlight **Swap (Switch?)** and press the left soft key  (**Ok**) to switch between the current call and the held call
- Press the left soft key  (**Option**). Press  to highlight **Mute** and press the left soft key  (**Ok**) to mute the microphone volume
- Press the right soft key  (**Hangup**). Press  to highlight **Phonebook** and press the left soft key  (**Ok**) to access the phonebook entry list
- Press  to highlight the desired call, and then press the right soft key  (**Hangup**) to end the selected call
- Press the  key or **close the flip cover** to end both calls

2.6.3 Make a New Call



While on a call, if you need to connect to a third party, press the left soft key  (**Option**). Press  to highlight **New Call (Call Another?)**



and press the left soft key  (**Ok**). Key in the third party's phone number or find the number from the phonebook, and then press the left soft key  (**Call**) or the  key. When the connection succeeds, you can start the call with the third party. The original call will be placed on hold.

The following operations are available:

- Press the left soft key  (**Option**). Press  to highlight **Conference** and press the left soft key  (**Ok**) to initiate the conference call (Refer to “Conference Call” on page 20)
- Press the left soft key  (**Option**). Press  to highlight **Mute** and press the left soft key  (**Ok**) to mute the microphone volume
- Press the right soft key  (**Hangup**). Press  to highlight **Phonebook** and press the left soft key  (**Ok**) to access the phonebook entry list
- Press  to highlight the desired call, and then press the right soft key  (**Hangup**) to end the selected call
- Press the  key or **close the flip cover** to end both calls

2.6.4 Conference Call





If the Three Way Call function is active, after making a new call with the original call on hold (refer to “Make a New Call” on page 19), you can make a conference call with both parties. Press the left soft key  (**Option**). Press  to highlight **Conference** and press the left soft key  (**Ok**) to initiate the conference call.

- Press  to highlight the desired call, and then press the right soft key  (**Hangup**) to end the selected call

- Press the  key or close the flip cover to end both calls



2.6.5 Transfer a Call



If the Call Transfer function is activated (refer to “Call Transfer” on page 92), you can transfer an ongoing received call to another phone number:

After answering a call, press the left soft key  (**Option**). Press  to highlight **Call Transfer** and press the left soft key  (**Ok**). Key in the transfer number and press the left soft key  (**Ok**).



- If the Call Transfer function is set to **Blind**, the call will be directly transferred to the dialed phone number after the connection succeeds
- If the Call Transfer function is set to **Consult**, after the transferred-to party answers the call, announce the transfer. Then, press the left soft key  (**Transfer**) to transfer the intended call





2.6.6 Mute the Microphone Volume



During a call, press the left soft key  (**Option**). Press  to highlight **Mute** and press the left soft key  (**Ok**). The microphone volume will be set to mute.

- To resume the volume, press the left soft key  (**Option**). Press  to highlight **Unmute (Cancel Mute?)** and press the left soft key  (**Ok**)







2.6.7 Access the Phonebook

While on a call, press the left soft key  (**Option**). Press  to highlight **Phonebook** and press the left soft key  (**Ok**). The phonebook entry list will be displayed.

- After entering the phonebook, press  to scroll through the entries. Press the left soft key  (**Detail**) to check the details (name, phone numbers, group category and email address) for the highlighted entry
- In the phonebook entry list, Press  ~  to enter the first letter(s)/digit(s) of the desired entry (name). All names starting with these letter(s)/digit(s) will be displayed (refer to “Search” under the **Phonebook** menu on page 25 for details)

 **Note:** If there are no entries in the phonebook, when you press , the error tone will sound.



2.6.8 Adjust the Listening Volume

1. During a call, press  to access the listening volume adjustment screen.
2. There are five volume levels. Press  to increase or  to decrease the volume.
If the volume is at the highest level, the volume level will not change when  is pressed; if the volume is at the lowest level, the volume level will not change when  is pressed.
3. After completing the volume selection, press the right soft key  (**Back**) or wait for **one second** to return to the call timer mode. The phone will save the adjusted volume level.

2.7 Store a Phone Number

In standby mode, a phone number added to the phonebook.

1. Enter the desired phone number and press the left soft key  (**Option**).







2. Select **Save**.
3. Select **New Contact** or **Update Contact**.
 - **New Contact**: Select this option to add a new entry with the entered phone number. Follow the prompts to edit phone numbers, the name, group category or email address
 - **Update Contact**: Select this option to modify an existing entry with the entered phone number. The phonebook entry list will be displayed. Enter the first letter(s)/digit(s) of the intended entry (name). Press  to highlight the entry, and then press the left soft key  (**Ok**). Follow the prompts to modify the entry



Note: For details of operations, see “Add Entry” on page 27.

2.8 Call Log Shortcut



In standby mode, you can quickly view the call logs: outgoing call log (Dialed Log), received call log (Received Log) and missed call log (Missed Log).

- Press  to display the outgoing call list. Press  to scroll through other outgoing call records
- Press  to display the received call list. Press  to scroll through other received call records
- Press  to display the missed call list. Press  to scroll through missed call records

For detailed operations, refer to “Call Log” on page 50.



2.9 Custom Functions Shortcut

1. In standby mode, press  to access the custom functions menu.

2. Press  to highlight the desired option: **Scheme** (1), **Inbox** (2), **WiFi** (3), **Games** (4), **Edit Message** (5), **Network** (6), **Calculator** (7), **Calendar** (8) or **Misc** (9), and then press the left soft key  (**Ok**) to access the option.



You can also access an option by pressing its corresponding number key.

2.10 Profiles Shortcut

In standby mode, press  to access the **Profiles** menu. Press  to highlight the desired option, and then press the left soft key  (**Ok**) to access the option.

For details of profile setup, refer to “Profiles” on page 60.

2.11 Vibration Shortcut





In standby mode, press and hold  to set the ring mode for incoming calls, messages, memos and alarms to vibration, and set the keypad tone and flip tone to “Off”.  will be displayed.

- Press and hold  again to resume ring mode, keypad tone and alert tone in the current profile
- For detailed operations, refer to “Ring Mode” on page 61

3. PHONEBOOK (NAMES)

You can store frequently used phone numbers and names in the phone memory (phonebook). The phonebook can store up to 200 entries. Each entry may contain a name, a group category, three phone numbers and an email address.

You can enter the phonebook in either of the following ways:

- In standby mode, press the right soft key  (**Names**)
- In standby mode, press the left soft key  (**Menu**), press  to scroll to **Phonebook** and press the left soft key  (**Ok**)





From the phonebook menu, you can select from the following options:

3.1 Search

Names → Search

After you access this option, the phonebook entry list will be displayed. Key in the first letter(s) or digit(s) of the name you are searching for. A maximum of six letters/digits can be entered. All names starting with these letter(s)/digit(s) will be displayed, including Chinese names starting with corresponding PinYin letters.

Enter letters or digits as follows:



1. Press  ~  to enter the corresponding letter or digit labeled on the respective key. For keys  ~ , press the corresponding key repeatedly until the intended letter/digit appears. For example: if you press  repeatedly, the following letters and digit appear in turn:









a → b → c → 2



Phonebook (Names)

2. The letter/digit just entered will be underlined. After you have entered the intended letter/digit, press the appropriate number key to input the next letter/digit. If the next letter/digit and current letter/digit share the same key, wait for one second to input the letter/digit again.

To delete the last entered letter/digit, press the right soft key  (**Clear**); to delete all letters/digits, press and hold the right soft key  (**Clear**).

- When a matched name (entry) is highlighted, you can press  to call this entry's phone number
 - If the entry contains only one phone number, the phone number will be dialed immediately
 - If the entry contains more than one phone number, phone numbers will be listed. Press  to highlight the desired number and press the left soft key  (**Call**) or the  key to call the number
 - If the entry contains no phone number, pressing  will have no response
- When an entry is highlighted, press the left soft key  (**Detail**) to see the detailed information: name, group category, phone number(s) and email address. Press  to select the desired item
- When the a phone number is highlighted, you can press  to call the phone number

After selecting the desired item, you can press the left soft key  (**Option**) to select from some of following options:

3.1.1 Edit

Change the name, group category, phone numbers and email address by following the screen prompts.

3.1.2 Del Contact

After this option is selected, “Delete?” will be displayed. Press the left soft key  (Ok) to confirm the deletion.

3.1.3 Group Members

This option is available only when the selected item is the group category. Select this option to view the list of entries in this group category.

3.1.4 Call

This option is available only when the selected item is a phone number. Select this option to call the selected phone number.

3.1.5 Send Message

This option is available only when the selected item is a phone number. Select this option to send a message to the selected phone number.

3.1.6 Send Email



This option is available only when the selected item is the email address. Select this option to send an email to the selected email address.

3.2 Add Entry

Names→Add Entry





















Select this option to add new entries into the phonebook.

If the most recently edited record was not saved, this unsaved record will be displayed after you access this option.

1. Edit Name: With the  item highlighted, press the left soft key  (Ok). Key in the name and press the left soft key  (Ok).

Phonebook (Names)

You can enter a maximum of 20 English letters or 10 Chinese characters (refer to “Input Method” on page 98).

2. Select group category: Press  to highlight the item next to the name, and then press the left soft key  (Ok). Press  to highlight the desired group category: **Common**, **Business**, **Family**, **Friend**, **Others** or **Blacklist**, and press the left soft key  (Ok).
3. Edit phone number(s): Press  to highlight the  or  or  item, and then press the left soft key  (Ok). Enter the phone number (40 digits maximum), and press the left soft key  (Ok). To add more phone number(s), repeat this step.
 - : Indicates mobile phone number
 - : Indicates home phone number
 - : Indicates office phone number
4. Edit email address: Press  to highlight the  icon, and then press the left soft key  (Ok). Enter the email address (50 letters/digits maximum) and press the left soft key  (Ok).
5. Press  to highlight the **Save** item, and then press the left soft key  (Ok) to complete the operation.
 - Either one phone number or the email address needs to be filled in. Otherwise **Save Error** will be displayed when you press the left soft key  (Ok) in step 5
 - If the name is not filled in, the phone will use the first 20 digits/letters of the first phone number or the email address (when all phone numbers are left blank) as the name

- Details of the newly added record cannot be identical to those of an existing record. Otherwise, the text **Exists** will be displayed when you press the left soft key  (**Ok**) in step 5
- The phone will automatically reject any incoming caller whose number is on the **Blacklist**. No response will be displayed.
- No more entries can be added if the phonebook memory is full. When **Add Entry** is selected, the phone will remind you that the phonebook memory is full



3.3 Delete

Names→Delete

You can select from the following options to delete entries one by one or all at once.



3.3.1 One by One

Names→Delete→One by one

When you access this option, the phonebook entry list will be displayed. Enter the first letter(s)/digit(s) of the intended entry (name). Press  to highlight the entry, and then press the left soft key  (**Delete**). When “**Delete?**” is displayed, press the left soft key  (**Ok**) to confirm the deletion.



3.3.2 All

Names→Delete→All

When you access this option, “**Delete?**” will be displayed, press the left soft key  (**Ok**). The prompt **Enter Code** will be displayed. Enter the security code, and press the left soft key  (**Ok**). If the code is correct, all phonebook entries will be deleted; otherwise **Code Error** will be displayed.

3.4 Group Info





Names → Group Info

After accessing this option, press  to highlight the desired group category: **Common**, **Business**, **Family**, **Friend**, **Others** or **Blacklist**, and press the left soft key  (**Ok**). Then, you can select from the following options:

3.4.1 Ring Tone

Select this option to specify a ring tone for the particular group category.



After accessing this option, you can select:

- **Local Rings:** To select from built-in melodies. Press  to scroll through the melodies and listen to a sample of each. After highlighting the desired melody, press the left soft key  (**Ok**) to complete the operation
- **Downloading Rings:** To select from downloaded melodies. (If there are no downloaded melodies, **No Ring** will be displayed when you select this option.) Press  to scroll through the melodies and listen to a sample of each. After highlighting the desired melody, press the left soft key  (**Option**). Select **Set as Ring Tone** to select the downloaded melody for the group category; select **Delete** to delete the downloaded melody

 **Note:** The **Blacklist** only has a **Browse** function because the phone will automatically reject any call from this group. Thus, it is not necessary to set a ring tone for the **Blacklist** group.



3.4.2 Browse

When you access this option, the list of entries in the selected group category will be displayed.

Enter the first letter(s)/digit(s) of the desired entry (name). Press  to highlight the entry, and press the left soft key  (**Detail**) to view the details for the entry. For detailed operations, see "Search". The only difference is that, when you select the group category and press the left soft key  (**Option**), the **Group Members** option will not be available.







3.5 Speed Dial

Names→Speed Dial

Select this option to assign a phone number in the phonebook to one of the speed dial keys  ~  for greater convenience when dialing (refer to "Use Speed Dial" on page 17).

After you access this option, the setting status for each key will be listed.

Press  to browse through the speed dial key settings.

- If no phone number is assigned to the key, **Unset** will be displayed. Press  to highlight the entry for the key and then press the left soft key  (**Ok**); the phonebook entry list will be displayed. Enter the first letter(s)/digit(s) of the desired entry (name). Press  to highlight the entry, and press the left soft key  (**Ok**) to assign the entry's phone number to the key
 - If the entry contains only one phone number, the phone number will be assigned to the key immediately
 - If the entry contains more than one phone number, phone numbers will be listed. Press  to highlight the desired number and press the left soft key  (**Ok**) to assign the number to the key
 - If the entry contains no phone number, **No Record** will be displayed
- If a phone number has been assigned to the key, the corresponding name or phone number (if the name contains more than one phone

number) will be displayed. To change or cancel the setting for this key, press the left soft key  (**Ok**), and then select **Edit** or **Cancel**



Note: *If the record for a speed dial key is modified in the phonebook, it will automatically be updated for the speed dial key function.*





If the record for a speed dial key is deleted from the phonebook, it will also be cancelled for the speed dial key function.

3.6 Memory

Names→Memory

Select this option to view the phonebook capacity, including the number of stored records.

4. MENU

In standby mode, press the left soft key  (**Menu**) to access the menu. Press  to reach the desired submenu, and press the left soft key  (**Ok**) to access the submenu.

4.1 Messages

Menu→Message

From this submenu, you can read, edit, save and send text messages and emails.



4.1.1 Text Message

Menu→Messages→Text Message

Select this option to read, edit, save and send text messages.

4.1.1.1 Edit Message







Menu→Messages→Text Message→Edit Message

After you access this option, the last edited message will be displayed (blank message will be displayed if the phone has been restarted). You can modify that message or delete it by pressing and holding the right soft key  (**Clear**) and re-enter a new message (up to 140 English letters or 70 Chinese characters, refer to “Input Method” on page 98). Then, press the left soft key  (**Option**), and select **Send**, **Insert Contact** or **Save**.

- The message cannot be empty; otherwise **Empty** will be displayed when you press the left soft key  (**Option**)

Send





After selecting this option, you can send the message in either of the following ways:

- Key in the receiver's phone number, and press the left soft key  (**Send**) to send the message
- Press the left soft key  (**Contact**) to access the phonebook entry list. Enter the first letter(s)/digit(s) of the intended entry (name). Press  to highlight the entry and press the left soft key  (**Detail**). If the entry contains only one phone number, the corresponding phone number will be displayed. Otherwise the entry details will be displayed. Press  to highlight the desired number and press the left soft key  (**Ok**). When the desired phone number is displayed, press the left soft key  (**Send**) to send the message

Insert Contact

Select this option to insert a phonebook entry's phone number or email address into the message contents.

After you access this option, the phonebook entry list will be displayed.

Enter the first letter(s)/digit(s) of the intended entry (name). Press  to highlight the entry and press the left soft key  (**Detail**) to display entry details. Press  to highlight the desired phone number or email address, and then press the left soft key  (**Ok**) to insert the selected phone number or email address.

Save

After you access this option, the message will be saved in Draft.

Draft can store a maximum of 10 messages. If it is full, when you select **Save** to store a newly edited message, "Drafts full! Update?" will be



displayed. You can press the left soft key  (**Ok**) to overwrite the oldest message









Note: In standby mode, you can send a text message by entering the phone number, pressing the left soft key  (**Option**) and selecting **Send Message**. Then, follow the prompts to edit the message.

4.1.1.2 Inbox

Menu→Messages→Text Message→Inbox

When a new message is received, the message tone will sound, and the  indicator will be displayed. After a new message is received, in standby mode, press the left soft key  (**Read**) to access the Inbox message list.

- The Inbox can store up to 100 messages. If the Inbox is full, when a new message is received, the phone will replace the oldest message with the newly received message. To avoid losing important messages in the Inbox, periodically erase some existing messages
- After you access this option, the message list will be displayed, which shows the message senders' phone numbers or names (if stored in the phonebook). There is an icon in front of each message:  (which icon?) indicates the message has not yet been read;  (which icon?) indicates the message has been read
- If there are no messages in the Inbox, when you select **Inbox**, **Empty** will be displayed
- Press  to scroll to the intended message, and then press the left soft key  (**Read**). Press  to view the message contents and details (the sender and received time). Press  to view other messages. Press the left soft key  (**Option**) to select from the following options:

Reply

Select this option to reply to the message. The steps to reply to a text message are similar to those for “Edit Message” on page 33.

The only difference is that, when you select **Send**, the sender’s phone number will be displayed automatically. You can edit the phone number, and press the left soft key  (**Send**) to send the reply.

Forward

After accessing this option, you can edit and forward the message. The steps to forward a message are the same to those for “Edit Message” on page 33.

Delete

Select this option to delete the message.

When you access this option, “**Delete?**” will be displayed. Press the left soft key  (**Ok**) to complete the deletion.

Delete All From The Sender

Select this option to delete all text messages from the sender.

When you access this option, “**Delete All From The Sender?**” will be displayed. Press the left soft key  (**Ok**) to complete the deletion.

Delete All

Select this option to delete all text messages in the Inbox.

When you access this option, “**Delete All?**” will be displayed. Press the left soft key  (**Ok**) to complete the deletion.





Call Back

Select this option to call the sender's phone number.



Pick Up

This option is available only when the message contains numbers or email addresses.

After you access this option, the numbers and/or email addresses will be extracted from the message contents and listed.

Press  to highlight the desired phone number or email address, and then press the left soft key  (**Ok**). You can edit the phone number or email address. (While editing a phone number, you can press  to call the number.) Then, press the left soft key  (**Option**) and select:

- **Call:** To call the phone number. This option is available only when the edited item is a phone number
- **Update Contact:** To modify an existing phonebook entry with the phone number or email address. The phonebook entry list will be displayed. Enter the first letter(s)/digit(s) of the intended entry (name).

Press  to highlight the entry, and then press the left soft key  (**Ok**). Follow the prompts to modify the entry

- **New Contact:** To add a new phonebook entry with the phone number or email address. Follow the prompts to edit the entry





4.1.1.3 Outbox

Menu→Messages→Text Message→Outbox

The last 100 messages you have sent are stored in the Outbox.

When **Outbox** is selected, the sent message list will be displayed (if there are no messages in the Outbox, **Empty** will be displayed). The list shows the receivers' phone numbers or names (if stored in the phonebook). Messages are listed chronologically; the most recent message sent is

highlighted at the top of the list.

Press  to reach the desired message and press the left soft key  (**Read**). Press  to view the message contents and details (the receiver and sending time). Press  to view other messages. Press the left soft key  (**Option**) to select from the following options:

Delete

Select this option to delete the message.

When you access this option, "**Delete?**" will be displayed. Press the left soft key  (**Ok**) to complete the deletion.

Forward

After accessing this option, you can edit and forward the message. The steps to forward a message are the same as those for "Edit Message" on page 33.

Delete All



Select this option to delete all text messages in the Outbox.



When you access this option, "**Delete All?**" will be displayed. Press the left soft key  (**Ok**) to complete the deletion.

4.1.1.4 Draft

Menu→Messages→Text Message→Draft

Up to 10 edited messages can be stored in Draft.

When you access the **Draft** option, the draft message list will be displayed (if there are no messages in Draft, **Empty** will be displayed). Press  to highlight the desired draft message and press the left soft key 

(Read) to read it. Press  to view the message contents. Press  to view other draft messages.

While reading the message, you can press the left soft key  (**Option**) and select from the following options:

Edit

Select this option to edit the draft message. Refer to “Edit Message” on page 33 for details.

Send

Select this option to send the draft message. Refer to “Send” under the **Edit Message** option on page 34 for details.

Delete

Select this option to delete the draft message.

When you access this option, “**Delete?**” will be displayed. Press the left soft key  (**Ok**) to complete the deletion.

Delete All

Select this option to delete all text messages in the Draft.

When you access this option, “**Delete All?**” will be displayed. Press the left soft key  (**Ok**) to complete the deletion.

4.1.1.5 Config

Menu→Messages→Text Message→Config

This option enables you to perform the following text message settings:

Valid Period

If the message service center cannot send a text message temporarily,

the message service center will store the message. You can set the duration of time that sent text messages can be stored in the message service center.

After accessing this option, select **12 Hours**, **One Day**, **One Week** or **Max Period**.

SMS Report

If the SMS Report function is active, when a text message has been successfully sent, the phone will receive a notification.

After accessing this option, select **On** or **Off** to activate or deactivate this function.

4.1.1.6 Status

Menu→Messages→Text Message→Status

Select this option to view the Inbox/Outbox/Draft capacity, including the number of stored text messages.

4.1.2 Email



Menu→Messages→Email





Select this option to read, edit, save and send emails.

4.1.2.1 Edit Email



Menu→Messages→Email→Edit Email

Select this option to edit and send an email by observing the following operations:







1. Edit receivers: Press  to highlight the desired receiver type: **Receivers**, **Cc** (Carbon Copy) or **Bcc** (Blind Carbon Copy), and then press the left soft key  (**Edit**). Enter the receiver's email address in either of the following ways:
 - Key in the receiver's email address

- Press the left soft key  (**Contact**) to access the phonebook entry list. Enter the first letter(s)/digit(s) of the intended entry (name). Press  to highlight the entry and press the left soft key  (**Detail**) to display the entry details, with the email address highlighted. Press the left soft key  (**Ok**) to confirm the email address

When the desired email address is entered, press the left soft key  (**Ok**) and select



- **Add New:** To add another email address
- **Finish:** To complete email addresses editing for the receiver type. Each receiver type can contain a maximum of 10 email addresses
- To delete an email address, press  to highlight the email address and press the left soft key  (**Delete**). "Delete?" will be displayed. Press the left soft key  (**Ok**) to complete the deletion



Repeat this step until all intended receivers for each receiver type are entered.

2. Edit subject: Press  to highlight the **Subject** item and press the left soft key  (**Edit**). Enter the email subject (50 English letters or 25 Chinese characters maximum, refer to "Input Method" on page 98), and then press the left soft key  (**Ok**).
3. Add attachment (50Kb maximum): Press  to highlight the **Attachment** item and press the left soft key  (**Edit**). Select **Picture** or **Ring Tone** to display the downloaded picture or melody list
 - **Picture:** Press  to highlight the desired picture option, and then press the left soft key  (**Ok**) to view the picture. Press





to view other pictures. When the desired picture is displayed, press the left soft key  (**Ok**) to confirm

- **Ring Tone:** Press  to scroll through the melodies and listen to a sample of each. After highlighting the desired melody, press the left soft key  (**Ok**) to confirm



4. Edit contents: Press  to highlight the **Content** item and press the left soft key  (**Edit**). Enter the email contents (900 English letters or 450 Chinese characters maximum, refer to “Input Method” on page 98), and then press the left soft key  (**Ok**).





5. Press the left soft key (**Option**), and then select **Send** to send the email.

- To save the edited email in Draft, press the left soft key (**Option**), and then select **Save**
- Emails' attachments cannot be saved. When you select **Save** to store an email containing an attachment, “**The Attachment Cannot Be Saved**” will be displayed. You can press the left soft key  (**Ok**) to save the email except for the attachment
- To modify an already edited item: press  to highlight the item; press the left soft key (**Option**), and then select **Edit**

4.1.2.2 Inbox

Menu→Messages→Email→Inbox

The Inbox can store up to 30 received emails. After you access this option, the email list will be displayed, which shows the email senders' email addresses or names (if stored in the phonebook). There is an icon in front of each email:  (which icon?) indicates the email has not yet been read;  (which icon?) indicates the email has been read

- If there are no emails in the Inbox, when you select **Inbox**, **Empty** will be displayed
- Press  to scroll to the intended email, and then press the left soft key  (**Read**). Press  to view the email contents and details. Press  to view other emails. Press the left soft key  (**Option**) to select from the following options:

Reply

Select this option to reply to the email to the sender. The operations are similar to those for “Edit Email” on page 40.

The only difference is that, the sender’s email address will be automatically added to the **Receivers** item.

Reply All

Select this option to reply to the email to the sender and all receivers. The operations are similar to those for “Edit Email” on page 40.

The only difference is that, email addresses of the sender and receivers will be automatically added for the corresponding receiver type.

Forward

After accessing this option, you can edit and forward the email. The steps to forward an email are the same to those for “Edit Email” on page 40.

- The attachment of the email cannot be forwarded

Delete

Select this option to delete the email.

When you access this option, “**Delete?**” will be displayed. Press the left soft key  (**Ok**) to complete the deletion.



Delete All



Menu -> Messages

Select this option to delete all email in the Inbox.

When you access this option, "**Delete All?**" will be displayed. Press the left soft key  (**Ok**) to complete the deletion.

View Receivers

After you access this option, all receivers' email addresses or names (if stored in the phonebook) will be listed. Press  to highlight the desired email address or name, and then press the left soft key  (**Option**) to select:

- **Send Email:** To send an email to the email address. Refer to "Edit Email" on page 40 for detailed operations
- **Update Contact:** To modify an existing phonebook entry with the email address. The phonebook entry list will be displayed. Enter the first letter(s)/digit(s) of the intended entry (name). Press  to highlight the entry, and then press the left soft key  (**Ok**). Follow the prompts to modify the entry
- **New Contact:** To add a new phonebook entry with the email address. Follow the prompts to edit the entry

View Attachment

This option is available only when the email contains an attachment.

After you select this option, the phone will start to acquire the attachment.

When the reception is complete, you can press the left soft key  (**Save**) to store the attachment.





4.1.2.3 Outbox

Menu→Messages→Email→Outbox

The last 10 emails you have sent are stored in the Outbox.

When **Outbox** is selected, the sent email list will be displayed (if there are

no emails in the Outbox, **Empty** will be displayed). The list shows the receivers' email addresses or names (if stored in the phonebook).

Press  to reach the desired email and press the left soft key  (**Read**). Press  to view the email contents and details. Press  to view other emails. Press the left soft key  (**Option**) to select from the following options:

Delete

Select this option to delete the email.

When you access this option, "**Delete?**" will be displayed. Press the left soft key  (**Ok**) to complete the deletion.

Forward



After accessing this option, you can edit and forward the email. The steps to forward an email are the same to those for "Edit Email" on page 40.

Delete All



Select this option to delete all emails in the Outbox.

When you access this option, "**Delete All?**" will be displayed. Press the left soft key  (**Ok**) to complete the deletion.

View Receivers

After you access this option, all receivers' email addresses or names (if stored in the phonebook) will be listed. Press  to highlight the desired email address or name, and then press the left soft key  (**Option**) to select:

- **Send Email:** To send an email to the email address. Refer to "Edit Email" on page 40 for detailed operations

- **Update Contact:** To modify an existing phonebook entry with the email address. The phonebook entry list will be displayed. Enter the first letter(s)/digit(s) of the intended entry (name). Press  to highlight the entry, and then press the left soft key  (**Ok**). Follow the prompts to modify the entry
- **New Contact:** To add a new phonebook entry with the email address. Follow the prompts to edit the entry

4.1.2.4 Receive New

Menu→Messages→Email→Receive New



Select this option to initiate the reception of new emails.

When the operation is complete, the phone will prompt you and display the Inbox email list.

4.1.2.5 Draft

Menu→Messages→Email→Draft

Up to five edited emails can be stored in Draft.

When you access the **Draft** option, the draft email list will be displayed (if there are no emails in Draft, **Empty** will be displayed). Press  to highlight the desired draft email and press the left soft key  (**Edit**). Then, you can edit the draft email. Refer to “Edit Email” on page 40.

While highlighting an already edited item, press the left soft key (**Option**), and then you can select:

Send

Select this option to send the email.

Edit

Select this option to edit the selected item.

Delete

Select this option to delete the draft email.

When you access this option, “**Delete?**” will be displayed. Press the left soft key  (**Ok**) to complete the deletion.

Delete All



Select this option to delete all emails in the Draft.

When you access this option, “**Delete All?**” will be displayed. Press the left soft key  (**Ok**) to complete the deletion.

4.1.2.6 Config



Menu→Messages→Email→Config

This option enables you to configure up to four email boxes.

After you access this option, the email box list will be displayed. Press  to highlight the desired email box and press the left soft key  (**Ok**). The following will be available:

Box Name

Select this option to set the name for the email box.

After accessing this option, press the left soft key  (**Edit**). Edit the box name and press the left soft key  (**Ok**) to complete the operation.

Email Address

Select this option to set the email address for the email box.



If no email address has been specified for the email box, the email address editing screen will be displayed after you select this option.

Otherwise, the original email address will be displayed. You need to press the left soft key  (**Edit**) to access the email address editing screen.

Edit the email address and press the left soft key  (**Ok**) to complete the operation.



Server Account

Select this option to store the email account's username and password:

1. After accessing this option, follow the prompts to edit the username and press the left soft key  (**Ok**).
2. If no password has been stored, the password editing screen will be displayed. Otherwise, the original password will be displayed (with each letter/digit displayed as *). You need to press the left soft key  (**Edit**) to access the password editing screen.
3. Edit the password and press the left soft key  (**Ok**) to complete the operation.

Outgoing Server

Select this option to set the outgoing mail server (SMTP) for the email box.

After accessing this option, follow the prompts to edit the SMTP server address and press the left soft key  (**Ok**). Edit the SMTP server port number and press the left soft key  (**Ok**) to complete the operation.

Incoming Server

Select this option to set the incoming mail server (POP3) for the email box.

After accessing this option, follow the prompts to edit the POP3 server address and press the left soft key  (**Ok**). Edit the POP3 server port

number and press the left soft key  (**Ok**) to complete the operation.

Enable/Stop

Select **Enable** or **Stop** to activate or deactivate the email box.

Only one of the four email boxes can be activated. Prior to activating an email box, you need to deactivate the email box in use.

4.1.2.7 Status

Menu→Messages→Email→Status

Select this option to view the Inbox/Outbox/Draft capacity, including the number of stored emails.

4.2 Call Log

Menu→Call Log

Your phone records missed, received and dialed calls as well as their call durations.

In standby mode, you can press ,  or  to quickly access **Missed Log**, **Received Log** or **Dialed Log** (refer to page 23 “Call Log Shortcut”).

4.2.1 Missed Log

Menu→Call Log→Missed Log

This option enables you to view the last 20 missed calls.



After you access this option, the phone will display the missed call list, with each log displaying the caller's phone number or name (if the number is stored in the phonebook). **If a caller has called your phone repeatedly, the corresponding log will also display the number of times the caller has called.** Press  to browse through the missed call logs.

 **Note:** This function only works in networks that support the Caller ID service; otherwise **No Caller ID** will be displayed in the missed log. If the caller's phone is set to block the caller's number, **No Caller ID** will also be displayed.

 If there are missed calls from phone numbers stored under the same phonebook name, these calls will be recorded in one missed call log.

When highlighting the desired log, you can dial the caller's phone number by pressing .



- If the call log contains only one phone number, the phone number will be dialed immediately

- If the call log contains more than one phone number, phone numbers will be listed. Press  to highlight the desired number and press the left soft key  (**Call**) or the  key to call the number

After reaching the desired log, press the left soft key  (**Option**). The following options will be available:

4.2.1.1 View

Select this option to view details of the selected call log, including the caller's number and **calling date/time of each missed call from this caller**.

- If the call log contains only one phone number, details of the call log will be displayed immediately
- If the call log contains more than one phone number, phone numbers will be listed. Press  to highlight the desired number and press the left soft key  (**Ok**) to view details of missed call(s) from this number.

When a call log's details are displayed, you can press  to view other missed call logs.

When a call log's details are displayed, you can press the left soft key  (**Option**) and then select **Pick Up Number**, **Send Message**, **Delete** or **Call** (call the number).

4.2.1.2 Pick Up Number

After you access this option, the caller's phone number(s) will be displayed:

- If the call log contains only one phone number, the phone will access this phone number's editing mode
- If the call log contains more than one phone number, phone numbers will be listed. Press  to highlight the desired number and press



the left soft key  (**Ok**) to access the selected number's editing mode

You can edit the phone number, and then save or dial the edited number:

Save Number

After editing the number, press the left soft key  (**Save**). Select **New Contact** or **Update Contact**.

- **New Contact:** Select this option to add a new phonebook entry with the phone number. Follow the prompts to edit phone numbers, the name, group category or email address
- **Update Contact:** Select this option to modify an existing phonebook entry with the phone number. The phonebook entry list will be displayed. Enter the first letter(s)/digit(s) of the intended entry (name).



Press  to highlight the entry, and then press the left soft key  (**Ok**). Follow the prompts to modify the entry

Dial Number

After editing the number, press  to call the displayed number.

4.2.1.3 Send Message

Select this option to send a text message to the caller. For detailed operations, refer to "Edit Message" on page 33.

- If the call log contains only one phone number, the phone will access message content editing mode
- If the call log contains more than one phone number, phone numbers will be listed. Press  to highlight the desired number and press the left soft key  (**Ok**) to access message content editing mode

4.2.1.4 Delete

Select this option to delete the selected call log. When you access this option, “Delete?” will be displayed. Press the left soft key  (Ok) to complete the deletion.

4.2.1.5 Delete All

Select this option to delete all missed call logs. Follow the prompts to enter the security code and press the left soft key  (Ok) to complete the deletion.

4.2.2 Received Log

Menu→Call Log→Received Log

This option enables you to view the last 20 received calls.

After you access this option, the phone will display the received call list, with each log displaying the caller's phone number or name (if the number is stored in the phonebook). Press  to browse through the received call logs.



Note: This function only works in networks that support the Caller ID service; otherwise **No Caller ID** will be displayed in the received log. If the caller's phone is set to block the caller's number, **No Caller ID** will also be displayed.







If there are received calls from phone numbers stored under the same phonebook name, these calls will be recorded in one received call log.

When highlighting the desired log, you can dial the caller's phone number by pressing .

- If the call log contains only one phone number, the phone number will be dialed immediately



Menu -> Call Log

- If the call log contains more than one phone number, phone numbers will be listed. Press  to highlight the desired number and press the left soft key  (**Call**) or the  key to call the number

After reaching the desired log, press the left soft key  (**Option**). The following options will be available:

4.2.2.1 View

Select this option to view details of the selected call log, including the caller's number, **calling date/time of each received call from this caller** and duration of each call.

- If the call log contains only one phone number, details of the call log will be displayed immediately
- If the call log contains more than one phone number, phone numbers will be listed. Press  to highlight the desired number and press the left soft key  (**Ok**) to view details of received call(s) from this number.

When a call log's details are displayed, you can press  to view other received call logs.

When a call log's details are displayed, you can press the left soft key  (**Option**) and then select **Pick Up Number**, **Send Message**, **Delete** or **Call** (call the number).

4.2.2.2 Pick Up Number

After selecting this option, the caller's phone number(s) will be displayed.

- If the call log contains only one phone number, the phone will access this phone number's editing mode
- If the call log contains more than one phone number, phone numbers will be listed. Press  to highlight the desired number and press



the left soft key  (**Ok**) to access the selected number's editing mode

You can edit the phone number, and then save or dial the edited number:

Save Number

After editing the number, press the left soft key  (**Save**). Select **New Contact** or **Update Contact**.

- **New Contact:** Select this option to add a new phonebook entry with the phone number. Follow the prompts to edit phone numbers, the name, group category or email address
- **Update Contact:** Select this option to modify an existing phonebook entry with the phone number. The phonebook entry list will be displayed. Enter the first letter(s)/digit(s) of the intended entry (name).



Press  to highlight the entry, and then press the left soft key  (**Ok**). Follow the prompts to modify the entry

Dial Number

After editing the number, press  to call the displayed number.

4.2.2.3 Send Message

Select this option to send a text message to the caller. For detailed operations, refer to "Edit Message" on page 33.

- If the call log contains only one phone number, the phone will access message content-editing mode
- If the call log contains more than one phone number, phone numbers will be listed. Press  to highlight the desired number and press the left soft key  (**Ok**) to access message content editing mode

4.2.2.4 Delete

Select this option to delete the selected call log. When you access this option, "Delete?" will be displayed. Press the left soft key  (Ok) to complete the deletion.

4.2.2.5 Delete All

Select this option to delete all received call logs. Follow the prompts to enter the security code and press the left soft key  (Ok) to complete the deletion.

4.2.3 Dialed log



Menu→Call Log→Dialed Log

This option enables you to view the last 20 dialed calls.

After you access this option, the phone will display the dialed call list, with each log displaying the caller's phone number or name (if the number is stored in the phonebook). Press  to browse through the dialed call logs.

 **Note:** *If you dialed phone numbers stored under the same phonebook name, these calls will be recorded in one dialed call log.*

When highlighting the desired log, you can dial the caller's phone number by pressing .



- If the call log contains only one phone number, the phone number will be dialed immediately
- If the call log contains more than one phone number, phone numbers will be listed. Press  to highlight the desired number and press the left soft key  (Call) or the  key to call the number

After reaching the desired log, press the left soft key  (Option). The

following options will be available:

4.2.3.1 View

Select this option to view details of the selected call log, including the dialed number, calling date/time of each call and duration of each call.



- If the call log contains only one phone number, details of the call log will be displayed immediately
- If the call log contains more than one phone number, phone numbers will be listed. Press  to highlight the desired number and press the left soft key  (**Ok**) to view details of dialed call(s) for this number

When a call log's details are displayed, you can press  to view other dialed call logs.

When a call log's details are displayed, you can press the left soft key  (**Option**) and then select **Pick Up Number, Send Message, Delete** or **Call** (call the number).

4.2.3.2 Pick Up Number

After selecting this option, the caller's phone number will be displayed.



- If the call log contains only one phone number, the phone will access this phone number's editing mode
- If the call log contains more than one phone number, phone numbers will be listed. Press  to highlight the desired number and press the left soft key  (**Ok**) to access the selected number's editing mode

You can edit the phone number, and then save or dial the edited number:

Save Number

After editing the number, press the left soft key  (**Save**). Select **New Contact** or **Update Contact**.

- **New Contact:** Select this option to add a new phonebook entry with the phone number. Follow the prompts to edit phone numbers, the name, group category or email address
- **Update Contact:** Select this option to modify an existing phonebook entry with the phone number. The phonebook entry list will be displayed. Enter the first letter(s)/digit(s) of the intended entry (name).



Press  to highlight the entry, and then press the left soft key  (**Ok**). Follow the prompts to modify the entry

Dial Number

After editing the number, press  to call the displayed number.

4.2.3.3 Send Message

Select this option to send a text message to the caller. For detailed operations, refer to “Edit Message” on page 33.

- If the call log contains only one phone number, the phone will access message content editing mode
- If the call log contains more than one phone number, phone numbers will be listed. Press  to highlight the desired number and press the left soft key  (**Ok**) to access message content editing mode

4.2.3.4 Delete

Select this option to delete the selected call log. When you access this option, “**Delete?**” will be displayed. Press the left soft key  (**Ok**) to complete the deletion.

4.2.3.5 Delete All



Select this option to delete all dialed call logs. Follow the prompts to enter the security code and press the left soft key  (**Ok**) to complete the deletion.

4.2.4 Duration

Menu→Call Log→Duration

This option enables you to view the approximate duration of the last call, all received calls, all dialed calls, or the duration of all calls.

After accessing this option, press  to view the duration of the last call (**Last Call**), received calls (**Received**), dialed calls (**Dialed**), as well as the duration of all calls (**Total Time**). The time will be displayed in “hh:mm:ss” format.

To clear the timer, press the left soft key  (**Clear**). Follow the prompts to enter the security code and then press the left soft key  (**Ok**) to complete the operation.

4.3 Profiles

Menu→Profiles

This submenu enables you to customize the phone alert settings to suit a variety of environments.

When you access this submenu, the profile list will be displayed; the current profile will be highlighted. You can customize each profile, and activate the one that suits your environment. The phone will utilize all the current profile's settings.

In standby mode, you can press  to quickly access the **Profiles** submenu.

Standard is the factory-preset profile.

4.3.1 Standard

Menu→Profiles→Standard

4.3.1.1 Enable

Menu→Profiles→Standard→Enable

Select this option to activate the selected profile.





4.3.1.2 Set

Menu→Profiles→Standard→Set

This option enables you to change the selected profile's settings, including:

Ring Volume

Select this option to adjust the ring volume level for incoming calls, new messages, memo alert and the alarm clock.

Press  or  to increase the volume; press  or  to decrease the volume. As you scroll through the volume levels, a sample of each will sound. After reaching the desired volume level, press the left soft key  (Ok) to complete the operation.

Ring Mode





This function enables you to define how the phone will notify you of incoming calls, new messages, memo alert and the alarm clock. The available options include: **Ascending, Ringing, Ring Once, Vibration, Vibration And Ring, Ring After Vibration** and **Mute**.

- If the Ring Mode is set to **Vibration** or **Mute**, the low battery alarm function, keypad tone and flip tone will be deactivated. If the Ring Mode is set to any other option, the low battery warning function will be active, and the Keypad Tone and Flip Tone settings will take effect



Ring Tone

This option enables you to select a special ring tone for incoming calls.

After accessing this option, you can select:

- **Local Rings:** To set a built-in melody as incoming call ring tone. Press  to scroll through the melodies and listen to a sample of each. After highlighting the desired melody, press the left soft key  (Ok) to complete the operation
- **Downloading Rings:** To set a downloaded melody as incoming call ring tone. (If there are no downloaded melodies, **No Ring** will be displayed when you select this option.) Press  to scroll through the melodies and listen to a sample of each. After highlighting the desired melody, press the left soft key  (Option). Select **Set as Ring Tone** to specify the downloaded melody for incoming calls; select **Delete** to delete the downloaded melody





Message Tone

Select this option to specify the incoming message alert tone. Press  to scroll through the message tones and listen to a sample of each. After highlighting the desired message tone, press the left soft key  (**Ok**) to complete the operation.

Alarm Tone

This option enables you to select an alarm tone for the alarm clock.



After accessing this option, you can select:



- **Local Rings:** To set a built-in melody as alarm tone. Press  to scroll through the melodies and listen to a sample of each. After highlighting the desired melody, press the left soft key  (**Ok**) to complete the operation
- **Downloading Rings:** To set a downloaded melody as alarm tone. Press  to scroll through the melodies and listen to a sample of each. After highlighting the desired melody, press the left soft key  (**Option**). Select **Set as Ring Tone** to specify the downloaded melody; select **Delete** to delete the downloaded melody

Memo Alert

This option enables you to specify the memo alert tone.

After accessing this option, you can select:

- **Local Rings:** To set a built-in melody as memo alert tone. Press  to scroll through the melodies and listen to a sample of each. After highlighting the desired melody, press the left soft key  (**Ok**) to complete the operation

- **Downloading Rings:** To set a downloaded melody as memo alert tone. Press  to scroll through the melodies and listen to a sample of each. After highlighting the desired melody, press the left soft key  (Option). Select **Set as Ring Tone** to specify the downloaded melody; select **Delete** to delete the downloaded melody

Keypad Tone

Select this option to set the tone the phone sounds when you press the phone's keys. Three options are available: **Standard Keytone**, **Key Music** and **Off**.

- If the Keypad Tone is not set to **Off**, when the phone is switched on/off, the power-on/off melody will sound; when an operation on the phone is completed or fails, the success/failure tone will sound
- If the Ring Mode is set to **Vibration** or **Mute**, the keypad tone will be deactivated regardless of the Keypad Tone settings

Alert Tone

If this function is activated, a warning tone will sound when the phone is outside of the service area range or a network handover occurs during a call.

Select **On** or **Off** to activate or deactivate this function.

Flip Tone

If this function is activated, a tone will sound when the flip cover is opened or closed. Select **On** or **Off** to activate or deactivate this function.

- If the Ring Mode is set to **Vibration** or **Mute**, the flip tone will be deactivated regardless of the Flip Tone settings

4.3.2 Meeting

Menu→Profiles→Meeting

This profile is suitable for meeting environments. You can preset this option to meet your needs by following the same steps specified in “Standard”.

4.3.3 Outdoor

Menu→Profiles→Outdoor

This profile is suitable for outdoor environments. You can preset this option to meet your needs by following the same steps specified in “Standard”.

4.3.4 User Define

Menu→Profiles→User Define

This profile can be tailored for other environments. You can preset this option to meet your needs by following the same steps specified in “Standard”.

4.4 Settings

Menu→Settings

From this submenu, you can perform various phone settings.

4.4.1 Date/Time



Menu→Settings→Date/Time

This option enables you to perform date and time settings for the phone.

4.4.1.1 Date/Time

Menu→Settings→Date/Time→Date/Time

Select this option to set the phone's date and time.

After accessing the option, enter a date from 2004-01-01 to 2019-12-31, and then enter the time in the corresponding time format. If the time format is set to **12 Hour**, press  to select **AM** or **PM** at the AM/PM selection zone. Press the left soft key  (**Ok**) to complete the operation.

- When you key in the date or time, you can press  to move the cursor and modify the number
- The cursor will advance if the number entered is valid; otherwise, the phone will sound an error tone (if the Keypad Tone is not set to **Off**)

4.4.1.2 Time Format

Menu→Settings→Date/Time→Time Format

This option enables you to set the time format.

After accessing this option, select **12 Hour** or **24 Hour**.

4.4.1.3 Date Format

Menu→Settings→Date/Time→Date Format

This option enables you to set the date format.

After accessing this option, select **Day/Month/Year**, **Month/Day/Year** or **Year/Month/Day**.

4.4.2 Display

Menu→Settings→Display







You may set the display for the LCD screen as follows:

4.4.2.1 Scheme

Menu→Settings→Display→Scheme

This option enables you to select the picture display in standby mode.

After accessing this option, you can select:

- **Local Pictures:** To set a built-in picture as standby display. Press  (**Ok**) to preview the highlighted picture. When viewing a picture, you can press  to browse through other pictures. When the desired picture is displayed, press the left soft key  (**Ok**) to complete the operation
- **Download Pictures:** To set a downloaded picture as standby display. (If there are no downloaded pictures, **No Pictures** will be displayed when you select this option.) Press  (**Ok**) to preview the highlighted picture. When viewing a picture, you can press  to browse through other pictures. When the desired picture is displayed, press the left soft key  (**Option**). Select **Set as Wallpaper** to set this downloaded picture as standby display; select **Delete** to delete this downloaded picture

4.4.2.2 Greetings

Menu→Settings→Display→Greetings

This option enables you to set the phone's greetings, which will be briefly displayed each time the phone is switched on.

After accessing this option, edit the greetings (16 English letters or 8 Chinese characters) and then press the left soft key  (Ok) to complete the operation.

4.4.2.3 Backlight

Menu→Settings→Display→Backlight

The LCD screen and keypad will light when you press keys or the phone receives a call or message. This option enables you to set the backlight:

Battery Saving

In this mode, the backlight will last for **5 seconds** after the last keystroke.





Normal

In this mode, the backlight will last for **15 seconds** after the last keystroke.

4.4.2.4 Contrast

Menu→Settings→Display→Contrast



This option enables you to specify the contrast level for the LCD screen.

There are six contrast levels. Press  or  to increase the contrast; press  or  to decrease the contrast. The screen display will reflect the contrast setting. After reaching the desired contrast level, press the left soft key  (Ok) to complete the operation.

4.4.2.5 On/Off Animation

Menu→Settings→Display→On/Off Animation

This option enables you to select the power-on/off animation.

Press  to highlight the desired option, and then press the left soft key  (Ok) to complete the operation.

4.4.3 Set Handset

Menu→Settings→Set Handset

You can set the phone as follows:



4.4.3.1 Answer Mode

Menu→Settings→Set Handset→Answer Mode



This option enables you to select how to answer an incoming call.

After you access this option, the following will be available:

Talk Key



Press the left soft key  (Answer) or the  key to answer an incoming call.

Any Key

Press any key to answer an incoming call except the right soft key , the  key and the  key.

Flip Key

Flip open the phone to answer an incoming call.

- If the flip cover is open when there is an incoming call, press the left soft key  (**Answer**) or the  key to answer the call

4.4.3.2 Language

Menu→Settings→Set Handset→Language

This option enables you to select the language of the phone's text display.

You can select **English** or **简体中文** (Simplified Chinese).

4.4.3.3 Earphone Auto Answer

Menu→Settings→Set Handset→Earphone Auto Answer

If the Earphone Auto Answer function is active and an earphone is connected to the phone, the phone will automatically answer incoming calls.

After accessing this option, select **Enable** or **Disable** to activate or deactivate.

4.4.4 Set Security

Menu→Settings→Set Security

This option enables you to set the security level to protect your phone.

After accessing this option, you will be prompted to enter the user definable security code (i.e. password). Key in the security code and press the left soft key  (**Ok**). If correct, the following options will be available (otherwise **Code Error (Failed?)** will be displayed).



Note: The initial default security code is "888888".



4.4.4.1 PowerOn Code

If this function is active, the security code will need to be entered each time you switch on the phone.

After accessing this option, select **Disable** or **Enable** to deactivate or activate.

4.4.4.2 Change Code

Select this option to change the security code. Observe the following steps:

1. At the **New Code** column, enter a new security code (0~8 digits long, using numbers 0~9).
 2. Press  to move the cursor to the **Confirm Code** column.
 3. Enter the new security code again and press the left soft key  (**Ok**) to complete the operation.
- The security code is "888888" by default
 - If the new security code entered in step 3 is different from that entered in step 1, when you press the left soft key  (**Ok**), **Not Matched** will be displayed
 - To avoid any inconvenience, please remember the new security code

4.4.4.3 Reset All

Select this option to restore your phone's default settings.

When you access this option, "**Reset All?**" will be displayed. Press the left soft key  (**Ok**) to complete the operation.

This operation will not delete the phonebook entries or call logs. It cannot change the phone's date and time either.

Phone Default Settings

Functions	Default Settings
Profiles	Standard
Listening Volume	3

Functions	Default Settings
Call Log (Duration)	00:00:00
Speed Dial Setting	No
Phonebook Group (Ring Tone)	Ring Tone 1
Security Code	888888
PowerOn Code	Disable
Earphone Auto Answer	Disable
Greetings	(Blank)
Backlight	Battery Saving
Contrast	3
On/Off Animation	
Scheme	Picture 2
Answer Mode	Talk Key
Language	English
Time Format	12 Hour
Date Format	Year/Month/Day
Alarm (On/Off)	Off
Alarm (Set Time)	08:00
Alarm (Snooze)	Off
Alarm (Set Cycle)	Once

Profiles Default Settings

Profile Options	Standard	Meeting	Outdoor	User Define
Ring Volume	4	0	4	4
Ring Mode	Ringing	Vibration	Ringing	Ringing

Profile Options	Standard	Meeting	Outdoor	User Define
Ring Tone	Ring Tone 1	Ring Tone 1	Ring Tone 1	Ring Tone 1
Message Tone	Ring Tone 3	Ring Tone 3	Ring Tone 3	Ring Tone 3
Alarm Tone	Ring Tone 4	Ring Tone 4	Ring Tone 4	Ring Tone 1 (4?)
Memo Alert	Ring Tone 3	Ring Tone 3	Ring Tone 3	Ring Tone 3
Keypad Tone	Standard Keytone	Off	Standard Keytone	Standard Keytone
Alert Tone	Off	Off	Off	Off
Flip Tone	On	On	On	On

4.5 Tools

Menu→Tools

From this submenu, you can set the Alarm, view the Calendar, set memos, use the Calculator or change the current Time Zone.

4.5.1 Alarm

Menu→Tools→Alarm

This function enables you to set the alarm for a specified time. Once activated, the alarm indicator  will be displayed.

- When the preset alarm time expires, the phone will sound the alarm; an alarm icon and the current time will be displayed. The alarm will sound for 30 seconds unless dismissed
- To dismiss the alarm and return to standby mode, press any key or close or open the flip cover
- If the alarm time expires during a call, the alarm will not sound

Set the alarm function by observing the following operations:

4.5.1.1 On/Off

Menu→Tools→Alarm→On/Off

After accessing this option, select **On** or **Off** to activate or deactivate the alarm function.

4.5.1.2 Set Time

Menu→Tools→Alarm→Set Time

Select this option to set the alarm time. Enter the time in **24-hour format**, and then press the left soft key  (**OK**) to complete the operation.

- When you key in the time, you can press  to move the cursor and modify the number

- The cursor will advance if the number entered is valid; otherwise, the phone will sound an error tone (if the Keypad Tone is not set to **Off**)

4.5.1.3 Snooze

Menu→Tools→Alarm→Snooze

If this function is activated, the alarm will repeat 3 times at 5-minute intervals after the original alarm time expires.

You can select **On** or **Off** to activate or deactivate this function.

4.5.1.4 Set Cycle

Menu→Tools→Alarm→Set Cycle

This option enables you to set the alarm cycle period.

Once

The alarm sounds only once. The setting will only be valid for 24 hours after the alarm function has been activated and the alarm time has been set.

After the alarm stops, the alarm function will be deactivated; the  indicator will disappear.

Everyday

The alarm sounds every day at the preset time.

Mon. ~ Fri.

The alarm sounds at the preset time on weekdays.

Mon. ~ Sat.

The alarm sounds at the preset time from Monday to Saturday.



4.5.2 Calendar

Menu→Tools→Calendar

This function enables you to view the calendar and set up to 10 memos.

In standby mode, if the memo time expires, the memo details will be displayed; the memo alert will sound (if the memo alert tone is activated). Press any key to return to standby mode.

After you access this option, the calendar will be displayed with the current date highlighted. The dates marked red indicates there are memos specified for these days.

You can press  to select the desired date. Press the left soft key  (Option); the following options will be available:

4.5.2.1 Choose Date

When you access this option, you can enter a date from 1900-01-01 to 2099-12-31, and then press the left soft key  (Ok) to view the calendar with the specified date highlighted.

4.5.2.2 Edit Memo

Select this option to set a memo.



Note: The selected date cannot be earlier than the phone's current date. Otherwise, **Over Time Limit** will be displayed when you select this option.







If the memo memory is full, when you select this option, **Memo Full** will be displayed.

Observe the following steps to set a memo:

1. Enter the memo contents (up to 32 English letters or 16 Chinese characters), and then press the left soft key  (Ok). **Awake Time**

will be displayed. The default date is the selected date; the default time is "08:00".

- The memo content cannot be empty; otherwise **Empty** will be displayed when you press the left soft key  (**Ok**)
2. Enter a date from **2004-01-01 to 2019-12-31**, and then enter the time in 24-hour format. Press the left soft key  (**Ok**).
- The date and time of the newly added memo cannot be identical to those of an existing memo. Otherwise, **Time Overlap** will be displayed when you press the left soft key  (**Ok**)
 - If the memo is set for the phone's current date, the entered time cannot be earlier than the phone's current time. Otherwise, **Time Passed** will be displayed when you press the left soft key  (**Ok**)
3. Select **Enable** or **Disable** to activate or deactivate the memo alert tone (awake sound).

4.5.2.3 View Memo

This option enables you to view the memos for the currently highlighted date (**Today's Memo**) or all memos (**All Memos**).



After you select **Today's Memo** or **All Memos**, press  to browse through the memos.

To modify or delete the currently displayed memo, press the left soft key  (**Option**), and then select **Modify** or **Delete**.

4.5.2.4 Delete Memo

You can select from the following options to delete memos one by one or all at once.

One By One

After accessing this function, press  to display the intended memo, and then press the left soft key  (**Delete**). “Delete?” will be displayed; press the left soft key  (**Ok**) to complete the deletion.











All



When you access this option, the prompt **Enter Code** will be displayed. Enter the security code, and press the left soft key  (**Ok**). If the code is correct, all memos will be deleted; otherwise **Code Error** will be displayed.

4.5.3 Calculator

Menu→Tools→Calculator

This function enables you to add, subtract, multiply and divide.



- The screen will initially display the number “0”. Enter the first number to be calculated.
 - To enter a minus sign, press  (only the first number can be made negative); to enter a decimal point, press 
- Press , ,  or  to enter the plus, minus, multiplication or division signs respectively.
- Enter the second number.
 - To enter “0”, press  and ; “0.0” will be displayed
- Press  to display the calculation result.
 - To conduct further calculations from this result, repeat steps 2~4
- When starting a new calculation, if the result from the last calculation is not “0”, press the right soft key  (**Clear**) to initialize.

- To delete the character you just entered, press the right soft key  (**Clear**); to erase all entered characters, press and hold the right soft key  (**Clear**)
- A maximum of 9 digits (including minus sign and decimal point) can be entered at one time
- If the formula violates mathematical principles (for example, 5/0), **Error** will be displayed
- If the absolute value of the calculation result exceeds 999,999,999, **Overflow** will be displayed

4.5.4 Time Zone

Menu→Tools→Time Zone

This option enables you to view the time of some cities in different time zones in the world.

After you access this option, the phone's current time zone and city will be displayed, as well as the current date and time. Press  to view other time zones; press  to browse through the cities in the currently displayed time zone.

When viewing a time zone, you can press the left soft key  (**Option**), and then perform the following operations:

4.5.4.1 Set to Local Time

Select this option to set this time zone as the phone's current time zone. The phone's time will change accordingly.

4.5.4.2 Enable/Disable DST

Select this option to change the phone's Daylight Saving Time (DST) setting. The phone's time will change accordingly.

4.6 Games

















Menu→Games

There are two games available: Sand Volleyball and Gobang.

4.6.1 Sand Volleyball

Menu→Games→Sand Volleyball

Every time the ball drops into the opponent's side, one point is won. The player with seven points wins one bout. The player who wins three bouts is the winner.

To jump, press , , ,  or . To move leftwards, press , ,  or . To move rightwards, press , ,  or . To pause or continue, press  or . To quit the game, press the right soft key  (**Exit**).

4.6.1.1 Begin Game

If you exited the last game before it was over, **Continue Play** or **New Game** will be displayed when you select this option. Otherwise, a new game will start.

Continue Play

Select this option to continue the unfinished game.

New Game

Select this option to start a new game.

4.6.1.2 Game Level

Select **Beginner** or **Expert** to set the play level of the game.







4.6.1.3 Game Rule

Select this option to view the rules of the game. Press  to scroll through the rules.

4.6.2 Gobang

Menu→Games→Gobang

The object of the game is to line up five of your chess pieces horizontally, vertically or diagonally, and to block your opponent. The player lining up five pieces first is the winner.

To move upwards, downwards, leftwards or rightwards, press , ,  or . To place a piece, press the left soft key . To retract your last move, press the left soft key  (**Clear**). To quit the game, press the right soft key  (**Exit**).

4.6.2.1 Begin Game

Select this option to start a new game.

4.6.2.2 Continue Play

Select this option to continue the last game.

If the last game was over, **No Record** will be displayed after you select this option.

4.6.2.3 Game Mode

Select **White Chess** or **Black Chess** to determine who goes first with black pieces.

4.7 WiFi

Menu→WiFi

From this submenu, you can perform the following WiFi settings.





Note: After completing WiFi settings, switch the phone off and then on, to apply the changed WiFi settings.



4.7.1 Net Search

Menu→WiFi→Net Search

This option enables you to search available APs (10 maximum) for the phone. APs can be defined and saved using the Net Search feature if APs have broadcast turned on and the phone is within their ranges.

After selecting this option, the phone will start to search for APs. Available APs will be listed according to the signal strength. The strongest AP's SSID will be highlighted at the top of the list.

Those with the  icon in front of the name are open APs; those with the  or  (which icon?) icon are protected APs and you will need to supply their WEP keys or WPA-PSKs to access them.

Press  to highlight the desired SSID, and press the left soft key  (**Save**). Press  to highlight the desired AP profile, and press the left soft key (**Save**) to save the SSID to the AP profile.

You can then follow the prompt to set the security mode and/or the encryption code (WEP key or WPA-PSK) and activate the AP profile. For detailed operations, refer to "AP Profile" on page 82.



Note: When the phone is connecting to an AP, you can press the right soft key  (**Search**) to start the search for available APs.



If the desired AP has broadcast turned off, the AP can be entered directly through a series of keystrokes on your handset. (Refer to "AP Profile" on page 82)

4.7.2 WiFi Config



Menu→WiFi→WiFi Config



From this option, you can perform the following WiFi configuration:

4.7.2.1 AP Profile

Menu→WiFi →WiFi Config→AP Profile

This option enables you to set up to four AP (Access Point) profiles. Each time you switch on the phone, the phone will try to connect to one of these APs according to their respective profile settings.

After you select this option, the AP profile list will be displayed. If the security mode of an AP profile is set to **WEP Key**, the  icon will be displayed in front of the AP profile. If the security mode is set to **WPA-PSK**, the  icon will be displayed in front of the AP profile. If the security mode is set to **Open AP**, no icon will be displayed in front of the AP profile.

Press  to highlight the desired AP profile, and then press the left soft key  (**Ok**). The following options will be available:

SSID

This option enables you to save an AP's SSID to the AP profile.

After accessing this option, enter the SSID (32 alphanumeric characters maximum), and then press the left soft key  (**Ok**) to complete the operation.

Security Mode

This option enables you to set the security mode for the AP profile.



After accessing this option, select **Open AP**, **WEP Key** or **WPA-PSK**:

- If **WEP Key** is selected, the phone will then display the options of **WEP Key Info** (refer to "WEP Key Info")

- If **WPA-PSK** is selected, the phone will then display the PSK-editing screen (refer to “WPA-PSK Info”)

WEP Key Info

If the AP profile's security mode is set to **WEP Key**, select this option to set the WEP key. After accessing this option, observe the following operations:

1. Select **Auth Method**, and then select the authentication method: **Open Key** or **Shared Key**.
2. Select **64bit** or **128bit** according to the AP's WEP key setting. Enter the WEP key that the AP used, and press the left soft key  (**Ok**).
 - If **64bit** is selected, ensure that the WEP key consists of five ASCII characters or ten hexadecimal characters
 - If **128bit** is selected, ensure that the WEP key consists of 13 ASCII characters or 26 hexadecimal characters
3. Select **WEP Key Index**. Enter the WEP key index (1-4), and then press the left soft key  (**Ok**).



Note: The WEP key setting may be different due to AP settings.

If an AP supports only a fixed hexadecimal WEP key, you should enter the same WEP key in the phone.

If an AP supports both ASCII and hexadecimal WEP keys, you can enter either the ASCII WEP key or the hexadecimal WEP key in the phone.

WPA-PSK Info

If the AP profile's security mode is set to **WPA-PSK**, select this option to set the WPA-PSK key.

After accessing this option, enter the WPA-PSK key and press the left soft key  (**Ok**) to complete the operation.

- Ensure that the WPA-PSK key consists of 8-63 ASCII characters or 64 hexadecimal characters

Activate

Select this option to connect to the AP according to the AP profile setting. If the connection fails, the phone will try to connect to other AP profiles' APs. If the phone fails to connect to all these APs and the Auto Scan function is active, the phone will try to search and connect to another available open AP. (Refer to "Auto Scan" on page 84)

4.7.2.2 Auto Scan

Menu→WiFi→WiFi Config→Auto Scan

If the Auto Scan function is active, when the phone is switched on and fails to connect to the APs specified in "AP Profile", the phone will do a scan for available APs and try to connect to one open AP of these scanned APs.

After accessing this option, select **Enable** or **Disable** to activate or deactivate the Auto Scan function.



Note: If the phone fails to connect to all the specified and scanned APs, the phone will periodically retry AP connections.



If the phone fails to register with the Vonage network after the AP connection, the phone will prompt you to try another AP.

4.7.3 Network Parameter

Menu→WiFi→Network Parameter

This option enables you to set network parameters:

4.7.3.1 DHCP

Menu→WiFi→Network Parameter→DHCP

If the DHCP function is active, the phone will obtain an IP address

automatically from the DHCP server.

After accessing this option, select **Disable** or **Enable** to disable or enable DHCP.

4.7.3.2 IP

Menu→WiFi→Network Parameter→IP

This option enables you to perform IP settings.



Note: Only when DHCP is disabled, can the **IP** option be available. Otherwise, when you select this option, **Please Disable DHCP** will be displayed.

IP Address

Select this option to set the phone's IP address.

After accessing this option, key in the IP address, and press the left soft key  (**Ok**) to complete the operation.

Subnet Mask

Select this option to set the subnet mask.

After accessing this option, key in the subnet mask, and press the left soft key  (**Ok**) to complete the operation.

Gateway IP Address

Select this option to set the gateway IP address.

After accessing this option, key in the gateway IP address, and press the left soft key  (**Ok**) to complete the operation.

4.7.3.3 DNS

Menu→WiFi→Network Parameter→DNS

This option enables you to perform DNS settings.

Primary DNS Server IP Address

Select this option to set the IP address of the local primary DNS server.

After accessing this option, key in the IP address, and press the left soft key  (Ok) to complete the operation.

Secondary DNS Server IP Address

Select this option to set the IP address of the local secondary DNS server.

After accessing this option, key in the IP address, and press the left soft key  (Ok) to complete the operation.

Priority

Select this option to set the priority.

You can select **DHCP First** or **Local First**

4.7.3.4 Network Information

Menu→WiFi→Network Parameter→Network Information

Select this option to view the phone's network information. Press  to browse through the phone's **IP Address**, **Subnet Mask**, **Gateway IP Address**, **MAC Address**, **Connected SSID** and **DNS Address**.

4.7.4 Signal Protocol

Menu→WiFi→Signal Protocol

From this option, you can set signal protocols:

4.7.4.1 SIP

Menu→WiFi→Signal Protocol→SIP

This option enables you to set the SIP protocol. The following options are available.

SIP Register Server Mode

Select this option to set the SIP register server mode.

After accessing this option, you can select **IP** or **DNS**.

SIP Register Server Domain Name

Select this option to set the SIP register server domain name.

After accessing this option, enter the domain name, and press the left soft key  (**Ok**) to complete the operation.

SIP Register Server IP Address

Select this option to set the SIP register server IP address.

After accessing this option, key in the IP address, and press the left soft key  (**Ok**) to complete the operation.

SIP Register Server Port

Select this option to set the SIP register server port.

After accessing this option, key in the port number, and press the left soft

key  (**Ok**) to complete the operation.

SIP Outbound Proxy

Select this option to set the SIP outbound proxy.

After accessing this option, you can select **IP** or **DNS**.

SIP Outbound Server Domain Name

Select this option to set the SIP outbound server domain name.

After accessing this option, enter the domain name, and press the left soft key  (**Ok**) to complete the operation.

SIP Outbound Server IP Address

Select this option to set the SIP outbound server IP address.

After accessing this option, key in the IP address, and press the left soft key  (**Ok**) to complete the operation.

SIP Outbound Server Port

Select this option to set the SIP outbound server port.

After accessing this option, key in the port number, and press the left soft key  (**Ok**) to complete the operation.

SIP User Name

Select this option to set the SIP user name.

After accessing this option, enter the user name (1~32 alphanumeric characters), and press the left soft key  (**Ok**) to complete the operation.



SIP Authentication String

Select this option to set the SIP authentication string.

After accessing this option, enter the authentication string, and press the left soft key  (**Ok**) to complete the operation.

SIP Password

Select this option to set the SIP password.

After accessing this option, follow the prompt to enter the security code and press the left soft key  (**Ok**). Enter the SIP password (0~32 alphanumeric characters), and press the left soft key  (**Ok**) to complete the operation.

SIP Service Operator

Select this option to set the SIP service operator. When the phone is connected to an AP and registered with the network, the preset operator name will be displayed in standby mode.

After accessing this option, enter the SIP operator name, and press the left soft key  (**Ok**) to complete the operation.

4.7.4.2 RTP

Menu→WiFi→Signal Protocol→RTP

Select this option to set the RTP protocol.

After you access this option, the **RTP Port** option will be displayed:

RTP Port

This option enables you to set the RTP port.

After accessing this option, key in the RTP port number (10000~20000),

and press the left soft key  (**Ok**) to complete the operation.

- The port number should range from 10000 to 20000; otherwise **Illegal input (Failed?)** will be displayed

4.7.4.3 NAT

Menu→WiFi→Signal Protocol→NAT

Select this option to set the NAT protocol.

After you access this option, the **STUN Mode** option will be displayed:

STUN Mode

This option enables you to set the STUN protocol:

Server Name

Select this option to set the STUN server name.

After accessing this option, key in the STUN server name, and press the left soft key  (**Ok**) to complete the operation.

Server Port

Select this option to set the STUN server port.

After accessing this option, key in the STUN server port number, and press the left soft key  (**Ok**) to complete the operation.

On/Off

Select **Disable** or **Enable** to deactivate or activate the STUN function.

4.7.4.4 Voice Mail

Menu→WiFi→Signal Protocol→Voice Mail

This option enables you to perform voice mail settings.

After you access this option, the **Voice Mail Access Number** option will

be displayed:

Voice Mail Access Number

Select this option to set the voice mail access number.

After accessing this option, key in the access number, and press the left soft key  (**Ok**) to complete the operation.



Note: Pressing and holding  in standby mode will call the voice mail access number.

4.8 Network

Menu→Network

From this submenu, you can set the following network services:

4.8.1 Call Waiting

Menu→Network→Call Waiting

This option enables you to set the Call Waiting function.

4.8.1.1 Per Call Basis

Menu→Network→Call Waiting→Per Call Basis

Select **Enable** or **Disable** to activate or deactivate the per call basis Call Waiting function.

4.8.2 Call Transfer

Menu→Network→Call Transfer

If the call transfer function is active, you can transfer an **ongoing received** call to another phone number.

After you access this option, the following will be available:

4.8.2.1 Disable

Menu→Network→Call Transfer→Disable

Select this option to disable the call transfer function.

4.8.2.2 Blind

Menu→Network→Call Transfer→Blind

If this option is selected, you can directly transfer an ongoing received call to another phone number after the connection succeeds.

4.8.2.3 Consult

Menu→Network→Call Transfer→Consult

If this option is selected, you need to announce the transfer after the transferred-to party answers your call. Then, press the left soft key  (Transfer) to transfer the intended call.

4.8.3 Three Way Call

Menu→Network→Three Way Call

If the Three Way Call function is active, you can make a conference call with two parties (refer to page 20 “Conference Call”).

After accessing this option, select **Enable** or **Disable** to activate or deactivate the Three Way Call function.

4.8.4 Register Interval Time

Menu→Network→Register Interval Time

This option enables you to set the register interval time.

After accessing this option, enter the interval time (0~86400 seconds), and then press the left soft key  (Ok) to complete the operation.

4.8.5 Caller-ID Block

Menu→Network→Caller-ID Block

If this function is active, when you dial a call, your phone number will not be displayed on the called party's phone.

After accessing this option, select **On** or **Off** to activate or deactivate this function.

4.8.6 Repeat Dial on Busy

Menu→Network→Repeat Dial on Busy

If this function is active, the phone will enable you to automatically redial the last busy number that you tried to dial.

After accessing this option, select **On** or **Off** to activate or deactivate this function.

4.8.7 Reject Anonymous Incoming Call

Menu→Network→ Reject Anonymous Incoming Call

If this function is active, the phone will automatically reject anonymous incoming calls.

After accessing this option, elect **On** or **Off** to activate or deactivate this function.

4.8.8 Personal Information

Menu→Network→Personal Information

If this function is active, the phone will automatically reject all incoming calls.

After accessing this option, elect **Enable** or **Disable** to activate or deactivate this function.

4.8.9 Personal Information

Menu→Network→Personal Information

To set a caller ID name for the phone. After accessing this option, enter the caller ID and press the left soft key  (**Ok**) to complete the operation.

4.9 Misc

Menu→Misc

From this submenu, you can perform the following operations:

4.9.1 Vendor Information

Menu→Misc→Vendor Information

Select this option to view the vendor information. Press  to browse through the information: Vendor Name, Enterprise Code, Model Name and Version.

4.9.2 PC Config

Menu→Misc→PC Config



This option enables you to download WiFi setting parameters from a PC to the phone.

- When the operation is complete, restart the phone

4.9.3 Remote TFTP Update

Menu→Misc→Remote TFTP Update

This option enables you to perform remote TFTP update.

After you select this option, the phone will display a notice for the remote TFTP update. Press  to browse through the information. Press the left soft key  (**Update**) to initiate the remote TFTP update process.

 **Note:** The phone will spend a long time completing the remote TFTP update. Please do not unplug the battery. When the update operation is complete, restart the phone.

4.9.4 Remote TFTP Server

Menu→Misc→Remote TFTP Server



This option enables you to set the remote TFTP server.

After accessing this option, key in the domain name of the remote TFTP server, and press the left soft key  (**Ok**) to complete the operation.

4.9.5 Local TFTP Update

Menu→Misc→Local TFTP Update

This option enables you to perform local TFTP update.

After accessing this option, follow the prompt to **enter the security code and press the left soft key**  (**Ok**). The phone will display a notice for the local TFTP update. Press  to browse through the information. Press the left soft key  (**Update**) to initiate the local TFTP update process.



Note: The phone will spend a long time completing the local TFTP update. Please do not unplug the battery. When the update operation is complete, restart the phone.

4.9.6 Local Log

Menu→Misc→Local Log

Select this option to view the phone's status information (for example, network connection, SIP messages). Press the **left soft key**  (**Next**) to browse through items. This information will be useful when troubleshooting a problem.

4.9.7 Web Authentication

Menu→Misc→Web Authentication

This option enables you to perform web authentication.

After you access this option, the following will be available:

4.9.7.1 Set Address

Select this option to set the URL for http request.

After accessing this option, key in the URL, and press the left soft key

 (Ok) to complete the operation.

4.9.7.2 Log In





Select this option to log in and follow the prompt to perform web authentication.

5. INPUT METHOD

This phone supports five input methods, including PinYin, Stroke, English, Letter and Digit in order to provide easy input for letters and digits in text editing mode.

5.1 Switch Input Method

When you enter text-editing mode, the **last active input method is displayed**. Press  to switch between the input methods. The current input method indicator will be displayed at the upper right side of the screen and include:

Input Method	Indicator
PinYin	
Stroke	
English	
Letter	
Digit	

5.2 PinYin and Stroke















These two input methods are only used for inputting Chinese characters.

5.3 English

The phone supports intelligent English input and word association, speeding up the input process.



Switch the input method to English;  will be displayed at the upper

right corner of the screen.

- To enter letters, press  ~  one time for the letters labeled on the respective key; a word matching the input letters will be displayed automatically.
 - When you enter the first letter of any English word, “*” will be displayed (except  and ). As you input letters, the phone will automatically associate the matched English words
 - If the letter input does not correspond with any English word in the phone’s dictionary, this key press will have no response
 - Press the right soft key  (**Clear**) repeatedly to delete letters from right to left
- Select a word and change upper/lower case: If the word displayed is not desired, press  to scroll through other word alternatives. Press  to switch between upper and lower cases; press once to capitalize the initial letter; press twice to capitalize all letters; press three times to return letters to lower case.
- Enter the selected word: Press the left soft key  (**Ok**) or  to confirm the selected word and to remove the underline; or press  to confirm the word and to add a space.
 - When no word is underlined, press  to enter a space; press  to switch input methods; press  to move the cursor; press the right soft key  (**Clear**) to delete the character to the left of the cursor; press and hold the right soft key  (**Clear**) to delete all characters

5.4 Letter









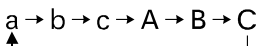

Switch to Letter input method;  will be displayed at the upper right corner of the screen.

1. Press  ~  to enter the corresponding letter labeled on the respective key. To input a letter, press the corresponding key repeatedly until the letter appears.

For example: if you press  repeatedly, the following letters appear in turn:



a → b → c → A → B → C



- The letter just entered will be underlined. When the letter is underlined, press  to switch between upper and lower cases; press the right soft key  (**Clear**) to delete the letter
2. After you have entered the intended letter, press any other key on the keypad to input the next letter. If the next letter and current letter share the same key, press the left soft key  (**Ok**) or  to remove the underline, and then enter the next letter; or simply wait for one second to input again. Press  to confirm the current letter input and enter a space.
 3. When no letter is underlined, press  to enter a space; press  to move the cursor; press the right soft key  (**Clear**) to delete the character to the left of the cursor; press and hold the right soft key  (**Clear**) to delete all characters; press  to switch input methods.



5.5 Digit



Switch to digit input method;  will be displayed in the upper right corner of the screen.

To enter digits, press the corresponding number keys  ~ . Press  to switch input methods.

5.6 Symbols





In text-editing mode, if the current input method is not Digit, you can enter symbols by observing the following steps:

1. When the word selection column is empty or when no letter is underlined, press  to display the symbol list.
2. Press  to display the intended symbol. Press the corresponding number key to enter the desired symbol.

 **Note:** If the current input method is neither Stroke nor Digit, when the word selection column is empty, you can also press  repeatedly to enter the desired symbol.

6. TROUBLESHOOTING

When using this phone, if you run into malfunctions, please refer to the following troubleshooting techniques before requesting help:

Symptom	Diagnosis	Solution
The phone cannot be switched on	Have you pressed  and held it for more than 2 seconds?	Press and hold  for more than 2 seconds.
	Is the battery low?	Charge the battery.
Cannot make calls	Is the phone connected to an AP and registered with the service network?	Ensure the phone's WiFi settings are correct.
	Is the phone outside of the AP's range? Is there sufficient signal strength?	Move closer to the AP for better signal strength.
	Is the phone number correct?	Enter the correct number to make the call.
No ring	Is the ring mode of the current profile set to Vibration or Mute ?	Select different ring mode or different profile.
	Have you pressed and held  in standby mode, displaying  ?	In standby mode, press and hold  again.
Strong interference noise during call; or call	Is there an obstacle nearby that is preventing signals from passing?	Move to another area.

Symptom	Diagnosis	Solution
interrupted	Is there data download via the AP, which affects your phone's signal quality?	Connect to another AP or stop the data download.
The battery cannot be charged (The battery indicator bar does not scroll)	Is the charger properly connected to the phone?	Connect the charger and phone correctly.
	Is the charger connected to a 100-240V AC wall outlet?	Connect the charger to a 100-240V AC wall outlet correctly.
How to know the F3000 phone's IP address and MAC Address?	Have you accessed the Network Information option?	Refer to "Network Information" on page 86.
Net Search didn't find my AP	Is SSID broadcasting disabled on your AP?	Enable your AP's SSID broadcasting.
	Is the phone within range of your AP?	Move to your AP's range.

If the malfunction symptoms are not listed in the above table, or the corresponding solution is invalid, please contact your local service provider.

For Technical Support and Assistance please visit the website at:

<http://www.utstar.com>