

**UTStarcom**



**UTS 801 (FSU)  
User Manual**

User Manual

**Trademark Statement:** “‘UTStarcom,’ ‘AN2000,’ and the UTStarcom logo are trademarks of UTStarcom, Inc.”

**Copyright Statement:** “©UTStarcom, Inc. 2000. All rights reserved. No part of this publication may be reproduced in any form or by any means without the prior written permission of UTStarcom, Inc.”

**Warranty Language:** “The contents of this manual, whether in whole or in part, do not constitute any express or implied warranty with respect to any products of UTStarcom, Inc., or its subsidiaries.”

# Safety Precautions

## Introduction

- Thank you for purchasing your new UTS801 FSU phone.
- Please read this instruction manual thoroughly.
- The display screens, illustrations, etc., used in this document are created for instructional purposes and may differ slightly with the actual phone.

## How to Use This Instruction Manual

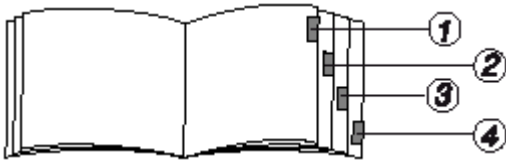



1. Before using your phone  
Includes facts you should know before using your new phone.
2. Basic phone operation
3. Explains the basic operation of making and receiving calls. More Essential function  
Explains useful convenience functions.
4. Reference  
Explains phone maintenance and troubleshooting procedures.

### Conventions with the manual:





- “press” means to press a key and then release;
- “press and hold down” means to press a key for 2 sec or more and then release.
- .“service area” refers to a service coverage area where a handset can receive signals effectively.

## Explanation of Alarm Symbols

- Before using your phone, please read the “Safety Precautions” thoroughly.
- The cautions included here are provided to prevent danger to persons and property.
- The following explain the degree of danger and damage that could occur if these safety precautions are not observed.

 <b>DANGER</b>	This symbol indicates that erroneous operations may directly result in personal serious injury or death.
 <b>WARNING</b>	This symbol indicates that erroneous operations may result in the possibility of death or serious injury.
 <b>CAUTION</b>	This symbol indicates that erroneous operations may result in the possibility of injury or physical damage.

- Explanations of other symbols used in the manual:



 <b>Prohibited</b>	This symbol indicates a prohibited action.
 <b>Compulsory</b>	This symbol indicates an action that must always be performed.
 <b>Disassembly prohibited</b>	This symbol indicates that disassembly is prohibited.
 <b>Remove power plug</b>	This symbol indicates that the power cord must be removed from the outlet.

## Handling the Phone and AC Adapter





### **DANGER**

<p>Use only the battery and AC Adapter approved for the UTS801FSU phone. The use of any other types can result in damage to the phone, electric shock or the risk of fire.</p>	
--	---

### **CAUTION**





<p>Do not store the phone or AC adaptor in hot, wet, or dusty areas. High temperatures, humidity and dust can damage electrical and mechanical components. This can cause the phone or AC adaptor to malfunction.</p>	
<p>Keep the phone, battery and the AC adaptor dry. Exposure to precipitation, humidity and liquids can damage electronic components and circuit boards.</p>	

### **WARNING**



<p>Do not drop, shake or throw the phone or AC adapter. Rough handling can break internal circuit boards and damage the battery pack.</p>	
<p>Do not use a microwave oven or any other type of heating equipment to dry the phone, battery pack or AC adapter. High temperature can shorten the life of electronic devices, damage the battery pack, and warp or melt plastic parts.</p>	
<p>Do not install or use the phone in the vicinity of volatile gases. Leave the area before installing or using the phone. Failure to leave the area can result in the risk of fire or an explosion.</p>	
<p>Do not disassemble or modify the phone or AC adapter. Incorrect modifications or reassembly can cause malfunctions or personal injury when the phone or AC adaptor is used.</p>	

## Handling the Phone

### **WARNING**







<p>Do not use the phone while driving. Park the vehicle before using the phone. Traffic safety first.</p>	
<p>Observe any special regulations in effect in any area (hospital, aircraft, etc) when you have to use the phone. Always disconnect the AC adapter and remove the battery of your phone whenever it is forbidden to use it, or when it may cause interference or danger.</p>	
<p>Keep a minimum 20 cm separation distance between the device and the user.</p>	
<p>Do not use the phone near electronic equipment prone to interference. . Radio frequency interference may result in malfunction of the electronic equipment. The following are such electronic equipment: Hearing aids, pacemakers and other clinical electronic devices, fire detectors, automatic doors and other automatically controlled devices. If you have to use phone near electronic medical devices such as pacemakers, please consult device manufacturer or local dealers.</p>	

### **CAUTION**



<p>In rare cases, using the phone inside certain models of vehicles can adversely affect the electronic equipment inside the vehicle. Do not use the phone in such cases, because it is dangerous for personal security.</p>	
<p>Keep all storage media (magnetic cards, floppy disks, credit cards, etc.,) away from the phone. Close encounters or contact can erase or damage the storage media.</p>	
<p>Keep all sharp metal objects (Pins, Nails, Hairpins etc.) away from the handset of the phone. The earpiece of the handset contains a strong magnet that can attract and hold metal objects. Remove any objects from the handset earpiece before using to avoid personal injury.</p>	

## Handling the Battery



### **DANGER**

Do not dispose of the battery pack in a fire. They may explode. Check with local waste management codes for disposal instructions.	 Prohibited
Do not force the battery pack into the phone. Improper installation can cause malfunctions or damage the battery pack. This may result in the risk of fire or personal injury.	 Prohibited
Use caution in handling batteries in order not to short the battery to conductive materials such as rings, bracelets, and keys. The battery and/or conductor may overheat and cause burns.	 Prohibited
Do not solder the battery terminals together. This may result in a cracked or leaking battery pack or the risk of fire.	 Prohibited
Do not open or mutilate the battery pack. Battery acid is corrosive and may cause burns or injury to eyes. If battery acid gets into the eyes, DO NOT RUB. Immediately flush the eyes with clean water and call a physician.	 Mandatory
Do not leave or store the battery pack in hot areas (Near fire, a heater, etc). High temperature can damage and shorten the life of the battery pack. This may result in a cracked or leaking battery pack or the risk of fire.	 Prohibited

### **WARNING**









Do not use a discolored, deformed or damaged battery pack in the phone. This may result in personal injury or the risk of fire.	 Mandatory
Do not open or mutilate the battery pack. Battery acid is corrosive and may cause burns or injury to skin or clothing. If battery acid is spilled, immediately flush the area with clean water to prevent injury.	 Mandatory
Do not use a cracked, leaking or odor emitting battery pack near an open flame.	 Mandatory

### **CAUTION**



Do not leave or store the phone in areas where temperatures are more than 45 (degree c) for a long period of time. High temperature can shorten the life of electronic devices, damage the battery pack, and warp or melt plastic parts.	 Prohibited
The battery cord is color-coded, the red line is positive (anode), the black line is negative (cathode) and the yellow line is a sensor output.	 Mandatory

## Handling the AC Adapter

### **DANGER**

Use only a power source that provides the appropriate voltage (AC220V±10% or AC110V±10%) for the AC adapter. An unsuitable power source can result in damaging the AC adapter, electric shock or the risk of fire.	 Mandatory
Do not short circuit the AC adapter connector jack. This may result in the risk of fire or electric shock.	 Prohibited
Do not use the AC adapter if the power supply cord or plug is damaged or frayed (exposed or broken wires, etc). This can result in the risk of fire or electric shock	 Prohibited
Unplug the AC adapter from the outlet before cleaning. Do not use liquid or aerosols cleaners. Use a damp cloth for cleaning to wipe off any accumulated dust to prevent any chance of fire.	 Mandatory
Never spill any liquid on the AC adapter. This may result in the risk of fire or electric shock.	 Prohibited
Unplug the AC adapter immediately from the wall outlet if liquid has been spilled into the unit to prevent the risk of fire or electric shock.	 Remove power plug
Do not use the AC adapter in areas with high humidity, such as bathrooms or the like. This may result in malfunction, electric shock or the risk of fire.	 Prohibited
Do not touch the AC adapter power cord or wall outlet with wet hands. This may result in the risk of fire or electric shock.	 Prohibited

### **CAUTION**

Always unplug the AC adapter from the wall outlet before cleaning to avoid the risk of electric shock.	 Mandatory
Do not place objects on the power cord. Install the AC adapter where no one can step or trip on the power cord.	 Prohibited



## Phone Information

Avoid extremely high or low temperatures.

Always use the phone in an environment with a temperature range of 10°C~40°C and humidity range of 45%~95%.

For maximum signal strength and noise free operation, use away from electrical appliances such as TV, radio or personal computer.

## Battery Information

Store the battery in a cool, well-ventilated area. Do not store in direct sunlight.

If left unused a fully charged battery will discharge itself over time. If a fully discharge battery is stored for a long period of time, it may not be possible to recharge the battery.

Do not discard old batteries with household trash. Where regulated, check with local waste management codes for disposal instructions.



# Table of Contents

<b>1.</b>	<b>BEFORE USING YOUR PHONE.....</b>	<b>1-1</b>
1.1	CHECK PACKAGE CONTENTS .....	1-1
1.2	PHONE SPEC .....	1-2
1.2.1	<i>Phone Spec</i> .....	1-2
1.3	PHONE COMPONENTS AND CORRESPONDING FUNCTIONS .....	1-3
1.3.1	<i>UTS801 FSU (Fixed Subscriber Unit) components</i> .....	1-3
1.3.2	<i>LCD (Liquid Crystal Display)</i> .....	1-5
1.4	TELEPHONE POWER SUPPLY .....	1-6
1.4.1	<i>AC Adapter Connection Connecting the AC Adapter:</i> .....	1-6
1.4.2	<i>Battery Installation</i> .....	1-6
1.5	STANDBY MODE.....	1-8
<b>2.</b>	<b>BASIC OPERATIONS.....</b>	<b>2-1</b>
2.1	MAKING CALLS .....	2-1
2.1.1	<i>Making IP Calls</i> .....	2-2
2.1.2	<i>“Pause” Function</i> .....	2-3
2.2	ANSWERING CALLS .....	2-5
2.3	VIEWING THE LAST NUMBER DIALED LIST .....	2-6
2.3.1	<i>Using the Last Number Dialed List to Make a Call</i> .....	2-6
2.3.2	<i>To Erased a Stored Number</i> .....	2-8
2.4	VIEWING THE CALLER LIST .....	2-9
2.4.1	<i>Using the Caller List to make a call</i> .....	2-9
2.4.2	<i>To Erase a Stored Number</i> .....	2-11
2.5	CALL WAITING (NETWORK SUPPORT).....	2-12
2.5.1	<i>Call Waiting Service Users</i> .....	2-12
2.6	ADJUSTING THE EARPIECE VOLUME .....	2-13
<b>3.</b>	<b>OTHER ESSENTIAL FUNCTIONS .....</b>	<b>3-1</b>
3.1	TABLE OF ESSENTIAL FUNCTIONS .....	3-1
3.2	OWN PHONE NUMBER DISPLAY.....	3-2
3.3	SELECTING A RINGING VOLUME.....	3-3
3.3.1	<i>Ringling Volume Setting</i> .....	3-3
3.4	SELECTING A RINGING TONE .....	3-5
3.5	SETTING THE ALARM CLOCK.....	3-6
3.5.1	<i>When the alarm sounds</i> .....	3-7
3.6	SETTING THE DATE AND TIME .....	3-8
3.7	ENTERING AN IP CARD NUMBER AND PASSWORD.....	3-10
3.8	RESTRICTING YOUR CALLING INFORMATION (PHONE NUMBER).....	3-12
<b>4.</b>	<b>REFERENCE.....</b>	<b>4-1</b>
4.1	<i>PHONE MAINTENANCE</i> .....	4-1
4.2	<i>TROUBLESHOOTING</i> .....	4-1
	<b>SAFETY PRECAUTIONS.....</b>	<b>III</b>
	<i>Introduction</i> .....	<i>iii</i>
	<i>How to Use This Instruction Manual</i> .....	<i>iii</i>
	<i>Explanation of Alarm Symbols</i> .....	<i>iv</i>
	<i>Handling the Phone and AC Adapter</i> .....	<i>v</i>
	<i>Handling the Phone</i> .....	<i>vi</i>
	<i>Handling the Battery</i> .....	<i>vii</i>

*Handling the AC Adapter* ..... *viii*  
*Phone Information*..... *ix*  
*Battery Information*..... *ix*

## 1. Before Using Your Phone

### 1.1 Check Package Contents

Check to make sure that all of the specified items are included. If anything is missing, please contact your local phone dealer.

- Phone (FSU) UTS801 and Ni-MH battery



- AC adapter

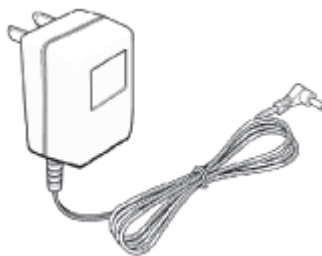

- Instruction manual

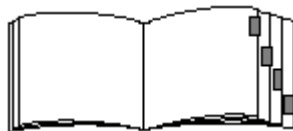

- After service guide
- Warranty Card

## 1.2 Phone Spec

### 1.2.1 Phone Spec

Transmission power	Approximately 10mW on average
AC Adapter	Input: AC 220V±10%, 50Hz or 110VAC ±10%, 60Hz Output: DC 4V, 225mA 6.1V, 10mA Power consumption: about 2W
External dimensions	22×18 (including antenna) ×7cm (L×W×H)
Weight	Approximately 805g (including battery pack)
Battery	DC 3.6V Ni-MH battery, at least 500mAh
Continuous standby-by time when using only a battery during a power failure	Approximately 50 hours

- K Note:** In case of a power failure, the battery will supply power to the telephone. The length of time the battery can supply power is determined by the telephone usage. (Stand-by vs. talk time)

## 1.3 Phone components and corresponding functions

### 1.3.1 UTS801 FSU (Fixed Subscriber Unit) components

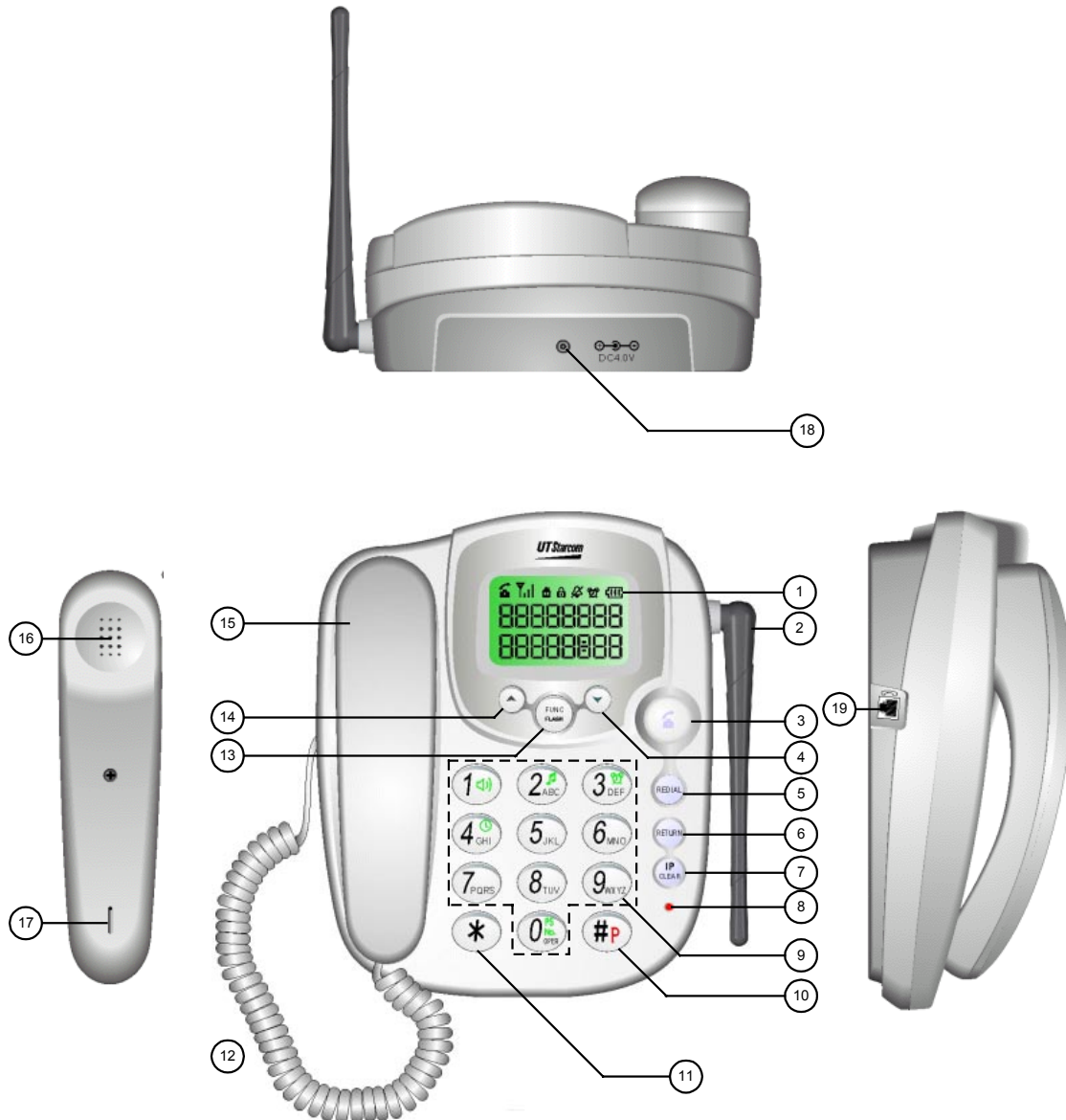









1. LCD (Liquid Crystal Display)

2. Antenna

3.  Talk key: Dials stored digits.

4.  Down key: To scroll down log or menu selections or move the cursor from left to right across the LCD.

5.  Redial key: To redial the last number dialed on the telephone.
6.  Return key: To return the phone to stand-by mode.
7.  Clear/IP key: clear input characters, delete outgoing/incoming calls log or perform IP call
8.  Handset indicator light: Indicates handset off/on hook status.
9.  Numeric keys: used to input telephone numbers or choose options
10.  # Key/pause key: input “#” or pause symbol
11. :  \* Key
12. Handset wire coiling Handset cord
13.  Function/confirm key: select functions, confirm switch for call waiting
14.  Up key: To scroll up log or menu selections or move the cursor from right to left across the LCD.
15. Handset
16. Telephone receiver Handset earpiece
17. Telephone transmitter Handset mouthpiece
18. Adapter jack
19. Handset wire coiling jack Handset Jack

**K** **Note:** Functions of the keypad are only roughly described here; details are depicted in latter part.



### 1.3.2 LCD (Liquid Crystal Display)

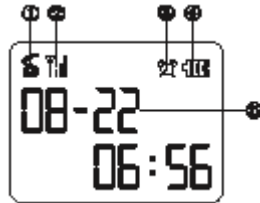

1. Appears in hook-off status. Appears when the handset has been removed from the base station cradle signifying off-hook.
2. Indicates the strength of signal reception. If the phone is in service area, it will display to indicate the signal strength; otherwise, it will not appear. Signal strength is denoted as follows:



3. Appears when the alarm is set on. Appears when the alarm has been turned ON.
4. : The battery icon appears on the LCD when a power failure occurs or the AC adaptor has been disconnected from the phone. The icon displays the power level of the battery.
  - Fully charged
  - Fair
  - Low, not much power left
  - No battery power. AC adapter should be used to supply power and recharge the battery.
5. Display area, where date, time, phone number or other information may appear.

**K Note:** During a power failure the battery powers the phone. When the battery is running out of power and only a few minutes of talk time remain, the battery icon blinks as a warning. After the AC power has been restored by the local utility the phone recharges the battery.

## 1.4 Telephone Power Supply

Before the telephone can be used, the AC adapter must be connected to the telephone and the battery properly installed. The AC adapter must remain connected at all times to the telephone. In case of a power failure, the battery will supply power to the telephone. The length of time the battery can supply power is determined by the telephone usage. (Stand-by vs. talk time)

### 1.4.1 AC Adapter Connection Connecting the AC Adapter:

1. Insert the AC adapter plug into the adapter jack into the base of the telephone.

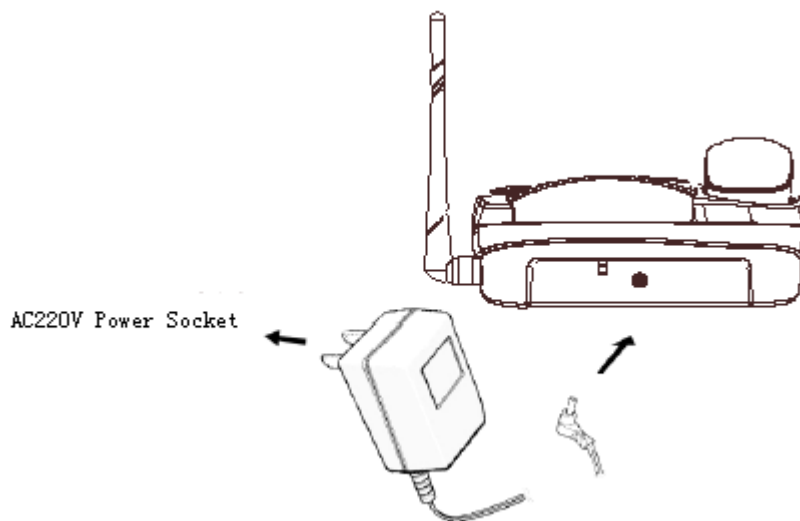

2. Plug the AC adapter into an AC wall outlet.

### 1.4.2 Battery Installation

1. Remove battery cover by pressing tab and then lifting.

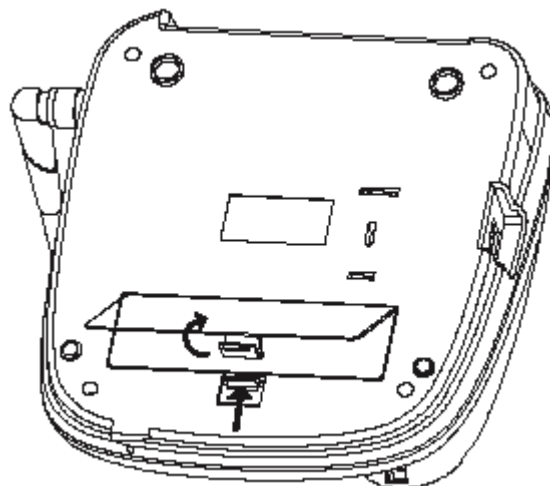

2. Firmly insert the plug of the battery into the connector on the base of the telephone as shown in the diagram below. Be sure that the positive connector of the plug connects to the positive terminal and the negative connector connects to the negative terminal of the base station. Snap the battery into place on the left side and insert the cord into the battery compartment.

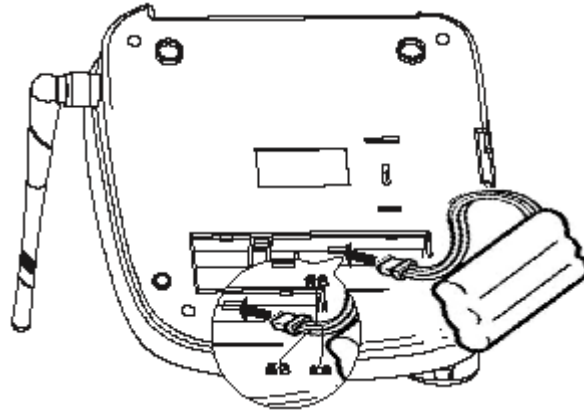

3. Replace the battery cover and then press firmly until a click is heard.

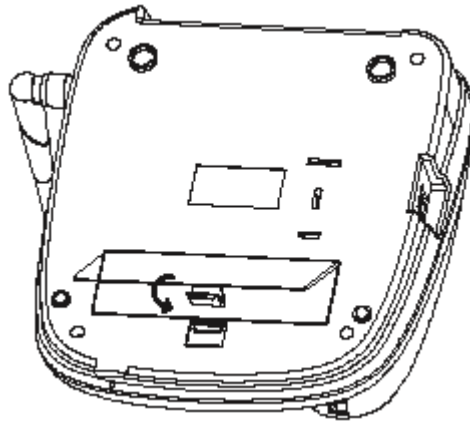

**K** **Note:** The battery cord is color-coded, the red line is positive (anode), the black line is negative (cathode) and the yellow line is a sensor output.

## 1.5 Standby mode

After the battery and AC adaptor have been properly installed and connected the phone briefly displays all the icons and letters. When the display shows default factory setting for date and time the phone is ready.

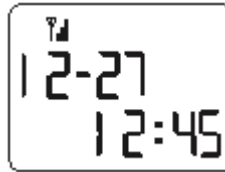

- K Note:** Calls are transmitted between the phone and the service providers network using radio waves. For maximum signal strength and noise free operation, the recommend phone location is near a window and away from electrical appliances such as TV, radio or personal computer.
- K Note:** The phone has an omni-directional antenna capable of transmitting and receiving signals in all directions. Changing the direction the antenna is pointing could improve signal reception.
- K Note:** The antenna cannot to be extended. Any attempt to extend the antenna may damage the phone.
- K Note:** When a power failure occurs or the AC adaptor has been disconnected the battery powers the phone. The battery icon appears on the LCD as shown in the figure below signifying the lost of AC power to the phone.



- During a power failure the battery icon displays the power level of the battery. The battery power level should be used to gauge the amount stand-by power available to the phone.
- During a power failure the battery icon indicates the power level of the battery. When the battery is running out of power and only a few minutes of talk time remains, the battery icon blinks as a warning.

## 2. Basic Operations

### 2.1 Making Calls

Before dialing a telephone number, make sure the signal strength is sufficient. The signal strength icon on the LCD of the phone should be at least .

1. Pick up the handset (off-hook).





2. Dial a phone number.

- The phone can display a maximum of 16 dialed digits at once. If the phone number dialed exceeds 16 digits, only the last 16 dialed digits entered are shown in the LCD display.



- Correct misdialed digits by one of the following methods.

Press  to delete the last digit dialed. Press and hold down  for two seconds to delete all dialed digits.

3. Press  to send dialed digits (or wait 3 seconds) and wait for an answer.

- The phone number will scroll from right to left across the LCD display indicating that the number has been sent out to the network.
  - The LCD on the phone will display a call timer in the lower right hand corner if the call is successfully completed as shown in the figure below.
-

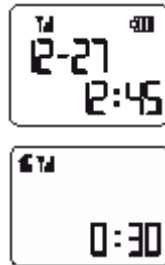

4. To end a call or cancel the call attempt, hang up the handset. The LCD on the phone will display the date and time as shown in the figure below.

- K Note:** When the handset is off-hook, the handset indicator light will be lit on the base station.
- K Note:** When the handset is off-hook, an audio tone can be heard from the earpiece. If the phone is located in an area without adequate signal strength no tone will be present.
- K Note:** When a phone call is unsuccessful due to inadequate signal strength or network related problems a warning tone (“pi-pi-pi”) will be heard in the earpiece of the handset.
- K Note:** The call timer is for reference only and should not be used in calculating the cost of a call.
- K Note:** After you finish a call, return the handset to the cradle on the base station.

### 2.1.1 Making IP Calls

Prior to making an IP, 200, 300 call using the  key make sure the correct number and password have been entered into the memory of the phone.

1. Pick up the Handset (off-hook)
2. Input the service number, e.g. 17908. Dial the service number, e.g. 17980

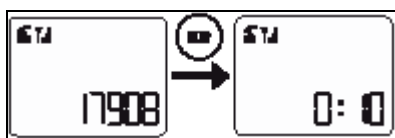

3. Select the appropriate language. When you are asked to enter the IP card number and password press the  key. The phone will automatically send the IP card number and password stored in memory. The numbers will scroll from right to left across the LCD display as shown in the figure above.
4. If the call is successfully completed, follow the instructions from your service provider.
5. To end a call, hang up the handset.



**K Note:** The IP card number and password must be entered into the phone prior to using the  key.



**K Note:** Refer to setting IP card number and password. Refer to “Entering an IP number and Password.”

### 2.1.2 “Pause” Function

This function allows you to add a delay between the digits of a phone number when the phone dials it.

1. Pick up the handset (off-hook).
2. Dial the first part of the phone number. Press and hold down  for 2 seconds, the pause symbol “P” will displayed as shown in the figure below.
3. Dial the second part of the phone number.
4. Press  or wait three seconds for the first part of the phone number to sent out to the network. Wait for the call to be answered then press  to send the second part of the phone number.

**K Note:** Pause “P” cannot be the first characters of the dialing string (phone number).

**K Note:** Using Pause more than once increases the length of delay between the numbers. The number following the second pause “P” will be automatically dialed.

- K **Note:** Two or more pauses may be required to access a long distance service or other network equipment.
- K **Note:**The Pause function is not available on all terminals.



## 2.2 Answering Calls

1. When a call is being received, the phone rings.
  - If you subscribe to a Caller ID service, the calling party information will be displayed as shown in the figure below after the second ring.



- If you subscribe to a Caller ID service and the calling party has blocked the calling information from being sent, "CALL" will be displayed as shown in the figure below.



2. Remove the handset from the cradle of the base.
  - The LCD on the phone will display a call timer in the lower right hand corner as shown in the figure below.



3. To end a call, hang up the handset.

- Missed call

If there is a missed call, "call not ans" will be displayed on the LCD. Press any key to clear the display on the phone. To check who called

press the search  key to enter the Caller list.

- K Note:** If the caller's phone number has more than 16 digits, only the last 16 digits will be displayed.







## 2.3 Viewing the Last Number Dialed list

The last ten phone numbers (maximum of 24 digits each) dialed on the phone are stored in memory. You can search the last number dialed list for a phone number to be redialed by following the steps below.

### 2.3.1 Using the Last Number Dialed List to Make a Call



1. Press  to enter the last number dialed list.
  - “H1” and the last phone number dialed are displayed as shown in the figure below.
  - If the LCD display does not change as shown in the figure below, the last number dialed list is empty.

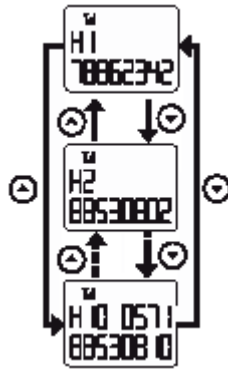

2. To scroll between the phone numbers, press the search  or  key.
  - H1 designates the most recent or last phone number dialed; H2 designates a phone number dialed prior to H1, etc.
  - To search from the most recent dialed phone number, press search .
  - To search from the oldest dialed phone number, press search .
  - The phone can display a maximum of 16 dialed digits at once. If the phone number dialed is 16 digits, only the first 12 dialed digits entered are shown in the LCD display. Pressing the  key will display the 16 digits of the phone number on the LCD of the phone. If the phone number dialed exceeds 16 digits, the phone will automatically display the remaining digits after a two second delay. Press the  key to return to the previous display.





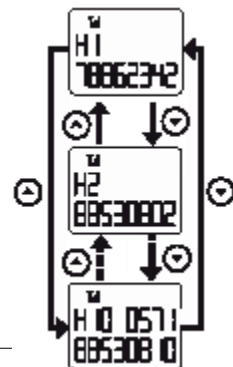

3. Removing the handset from the cradle of the base station will dial the displayed phone number automatically.





- K** **Note:** To exit the Last number dialed list and return to standby mode press . If you do not press any keys for 15 seconds the phone automatically returns to stand-by mode.
- K** **Note:** To redial the last dialed telephone number, remove the handset from the cradle of the base station and then press .

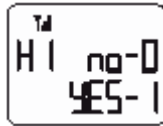

### 2.3.2 To Erased a Stored Number

1. Press  to enter the last number dialed list
2. Press  or  to find the phone number you want to erase from the Last number dialed list.
3. Press  to select the phone number to be erased. The options NO-0 or YES-1 are displayed in the LCD as shown in figure below.



4. Press  or  to delete the phone number. The phone erases the information, sounds a beep and returns to stand-by mode.
  - Press  or  to cancel operation. To return to stand-by mode, press . If you do not press any keys for 15 seconds the phone automatically returns to stand-by mode.

**K Note:** If a phone number is dialed more than one time, the phone number is entered only once into the Last number dialed list.

**K Note:** The Last number dialed list can store a maximum of ten phone numbers. When the 11<sup>th</sup> phone number is dialed the oldest phone number is deleted.







## 2.4 Viewing the Caller List

The last ten phone numbers (maximum of 24 digits each) received by the phone are stored in memory. To check who has called follow the steps below.

### 2.4.1 Using the Caller List to make a call

1. Press  to enter the caller list.
  - “C1” and the last phone number received are displayed as shown in the figure below.
  - If the LCD display does not change as shown in the figure below, the caller list is empty.





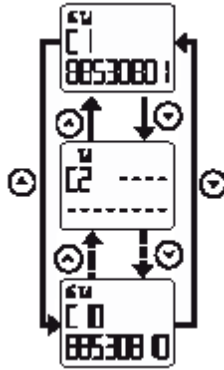

2. To scroll between the phone numbers, press search  or .
  - C1 designates the most recent or last phone number received; C2 designates a phone number received prior to C1, etc.
  - If the off-hook  icon is displayed the call is not a missed call.
  - To search from the most recently received phone number, press search .
  - To search from the oldest received phone number, press search .
  - If you do not subscribe to a Caller ID service, the calling party information will be displayed as “---” on the LCD of the phone.
  - The phone can display a maximum of 16 received digits at once. If the phone number received is 16 digits, only the first 12 dialed digits entered are shown in the LCD display. Pressing the  key will display the 16 digits of the phone number on the LCD of the phone. If the phone number received exceeds 16 digits, the phone will automatically display the remaining digits after a two second delay. Press the  key to return to the previous display.







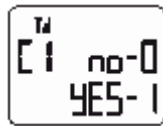

3. Removing the handset from the cradle of the base station will dial the displayed phone number automatically.

**K** **Note:** To exit the Caller list and return to standby mode press . If you do not press any keys for 15 seconds the phone automatically returns to stand-by mode.

## 2.4.2 To Erase a Stored Number

1. Press  to enter the last number dialed list
2. Press  or  to find the phone number you want to erase from the Caller list.
3. Press  to select the phone number to be erased, the options NO-0 or YES-1 are displayed in the LCD as shown in figure below.





4. Press  or  to delete the phone number. The phone erases the information, sounds a beep and returns to stand-by mode.
  - Press  or  to cancel operation. To return to stand-by mode, press . If you do not press any keys for 15 seconds the phone automatically returns to stand-by mode.

- K Note:** You must subscribe to a Caller ID service for the calling party information to be displayed on the LCD of the phone.
- K Note:** If the same caller calls more than one time, the callers phone number is entered only once into the Caller list.
- K Note:** The Caller list can store a maximum of ten phone numbers. When the 11<sup>th</sup> phone number is received the oldest phone number is deleted.

## 2.5 Call Waiting (Network Support)

### 2.5.1 Call Waiting Service Users

If you hear a call-waiting tone while talking on the phone use the procedure described below:

1. Press  to put the first call on hold and answer the second call.
2. To return to the first caller, press  again.

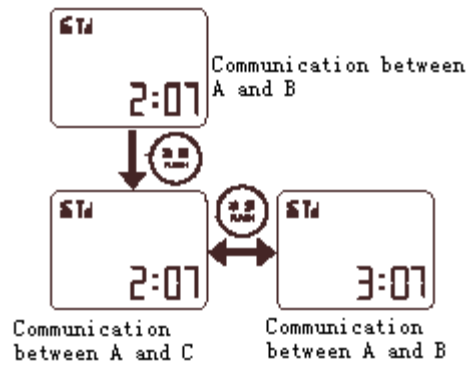



- K Note:** The above description is for reference only. If this function does not operate properly, consult with your service provider for details.





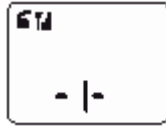

## 2.6 Adjusting the Earpiece Volume

You can adjust the earpiece volume of the phone while on a call.

1. Press  or  while talking to display the current earpiece volume as shown in the figure below.



2. Press  to increase and  to decrease the volume.
  - If the earpiece volume is at the maximum level 4, the volume level will not change when  is pressed.
  - If the earpiece volume is at the minimum level 1, the volume level will not change when  is pressed.

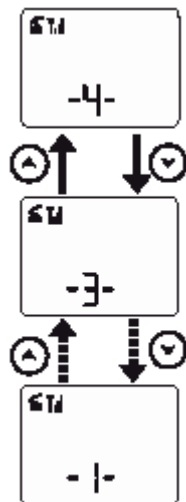

3. To exit and return to call timer mode press  or wait 3 seconds.

**K Note:** There are 4 volume levels.







- 1: Low
- 2: Medium
- 3: High
- 4: Higher

BLANK PAGE

---

## 3. Other Essential Functions



### 3.1 Table of Essential Functions

Operation Keys	Function	Default setting
	Own phone number display	_____
	Selecting a Ringing Volume	2 (loud)
	Selecting a Ringing tone	1 (ring No.1)
	Setting the Alarm Clock	OFF
	Setting the Date and Time	2001-01-01 00:00
	IP card number and password setting Entering an IP Card Number and Password	_____
	Caller number notification (caller ID) setting	



- To exit a function without changing the setting and return to stand-by mode press  on the phone.
- If you do not press any keys for 15 seconds the phone automatically returns to stand-by mode without changing any function setting.

## 3.2 Own Phone Number Display

This function allows you to the display your telephone number.

1. Press  and then  to display the telephone number on the LCD of the phone as shown in the figures below.



- To scroll between the functions, press the search  or  key.
2. To exit and return to standby mode press .
    - If you do not press any keys for 15 seconds the phone automatically returns to stand-by mode.

## 3.3 Selecting a Ringing Volume

### 3.3.1 Ringing Volume Setting





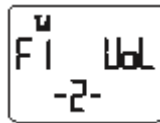

A ringing tone is heard when there is an incoming call. This function allows you to select one of the two ringing volume levels (1 - low and 2 - loud) available. The default volume level setting is 2 – loud.

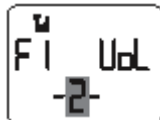
1. Press  and then  to display the current ringing volume on the LCD of the phone as shown in the figure below.



2. Press  to enter the edit mode, the volume level number will flash on the LCD of the phone as shown in the figure below.





3. To scroll between the volume levels, press the search  or  key. You can also change the volume level by pressing the keys 1 or 2 on the dial pad.
  - If the volume level is at the maximum level 2, the volume level will not change when the search  key is pressed.
  - If the volume level is at the minimum level 1, the volume level will not change when the search  key is pressed.
  - When changing volume levels, the phone automatically rings. To stop the ringing, press the  key.
4. To save the volume level, press the  key. The phone sounds a beep and the new volume level is displayed.
5. To exit and return to standby mode press .
  - If you do not press any keys for 15 seconds the phone automatically returns to stand-by mode.

- K** **Note:** In step1, if you press  or do not press any keys for 15 seconds the phone automatically returns to stand-by mode.
- K** **Note:** In step 3, if you do not press any keys for 15 seconds the phone automatically returns to stand-by mode.

### 3.4 Selecting a Ringing tone

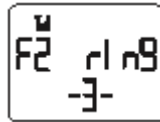

A ringing tone is heard when there is an incoming call. This function allows you to select one of the six different types (1 to 6) of ringing tones. The default ringing tone setting is 1.

1. Press  and then  to display the current ringing tone on the LCD of the phone as shown in the figure below.

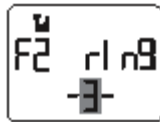

2. Press  to enter the edit mode, the ringing tone number will flash on the LCD of the phone as shown in the figure below.



3. To scroll between the ringing tone types, press the search  or  key. You can also change the ringing tone type by pressing the keys 1 to 6 on the dial pad.
  - When changing the ringing tone types, the phone automatically rings. To stop the ringing, press the  key.

To save the ringing tone, press the  key. The phone sounds a beep and the new ringing tone is displayed.



4. To exit and return to standby mode press .
  - If you do not press any keys for 15 seconds the phone automatically returns to stand-by mode.

**K Note:** In step3, only keys 1 to 6 can be pressed to select a ringing tone type.

**K Note:** In step3, if you do not press any key for 30 seconds the phone automatically returns to stand-by mode.

### 3.5 Setting the Alarm Clock

This function allows you to set the alarm clock built into the phone for a specific time. You can set the alarm time or select ON to change the alarm time or OFF to turn off the alarm. The alarm uses the 24 hours format to set the alarm. The alarm provides a 30 second burst of tone when the timer expires to alert you. The volume of the alerting tone is factory set and cannot be changed.



1. Press  and then  to display the current alarm status (on/off) on the LCD of the phone as shown in the figure below.
  - If the alarm has been set the LCD will display the current alarm setting.



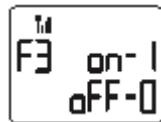

e. g. OFF=Alarm set off

2. Press  to change the status of the alarm, the options OFF-0 or ON-1 are displayed in the LCD as shown in figure below.



3. Press  or  to turn the alarm ON or OFF.
  - If the alarm is turned OFF, the phone sounds a beep. To exit and return to stand-by mode press  on the phone.
  - If the alarm is turned ON, the hour digit of the clock will flash on the LCD of the phone as shown in the figure below.

To move the cursor between the fields, press the search  or  key. To change the value of a field press a valid numeric key on the dial pad.



e. g. The alarm time is set to 7:30

4. To save the alarm setting, press the  key. The phone sounds a beep and the new alarm setting is displayed.



5. To exit and return to standby mode press .

- If you do not press any keys for 15 seconds the phone automatically returns to stand-by mode.

**K Note:** If the alarm has been turned ON, the alarm icon  as shown in the figure below will be displayed on the LCD.

**K Note:** The default alarm setting is “OFF”.

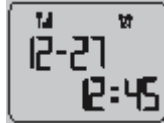

### 3.5.1 When the alarm sounds...

1. When the timer expires the alert tone will sound for up to 30 seconds and the alarm icon will flash on the LCD as shown in the figure below.



e. g. The alarm sounds when the time is half past seven.

2. Press any key to stop the alarm or remove the handset from the base station cradle.



**K Note:** If the handset is off-hook and the timer expires the alarm will not sound until 10 to 30 seconds after the handset has been returned to the cradle in the base station.

**K Note:** If you are changing phone settings and the timer expires the alarm will sound. Pressing any key or removing the handset from the cradle in the base station can stop the alarm.

**K Note:** The alerting tone and volume level are set at the factory and cannot be changed.

### 3.6 Setting the Date and Time



The phone has a real time clock that displays the data and time on the LCD. This function allows you to set the clock for a specific date and time.

- The date can be set from 2000-1-1 to 2099-12-31.
  - The clock uses the 24-hour format and cannot be changed to a 12-hour format.
1. Press  and then  to display the date on the LCD of the phone as shown in the figure below.





2. Press  to enter the edit mode, the first digit of the year will flash on the LCD of the phone as shown in the figure below.

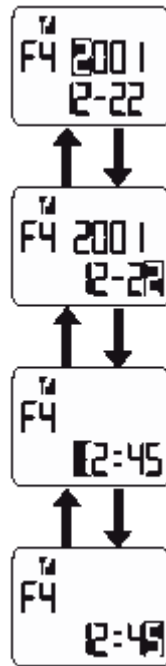

3. To move the cursor between the fields, press the search  or  key. To change the value of a field press a valid numeric key on the dial pad.
  - After the date is set, the time will be displayed as shown in the figure below.





4. To save the Date and Time setting, press the  key. The phone sounds a beep and the new setting is displayed
5. To exit and return to standby mode press .

- K Note:** If you do not press any keys for 15 seconds the phone automatically returns to stand-by mode.
- K Note:** In step3, the cursor automatically moves to the next field when a valid entry has been made.
- K Note:** The clock uses a 24-hour format only. The format of the clock cannot be changed.
- K Note:** Even though the phone has AC power and battery backup. You may need to set time again if the phone's battery as been removed and the AC power has been interrupted.

### 3.7 Entering an IP Card Number and Password





This function allows you to enter an IP/200/300 card number and password in the memory of the phone, which can be dialed via the  key

1. Press  and then  to display the current IP card number and password on the LCD of the phone as shown in the figure below.

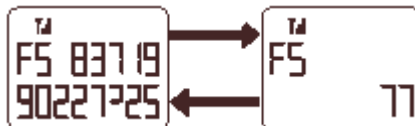



- If no IP card number and password have been entered then “FS IP no” will be displayed on the LCD.
2. Press  to enter the edit mode.
    - If the IP card and password exceeds 13 digits, only the first 13 digits are shown in the LCD display. The phone will automatically flash the remaining digits every one-second.





3. Press key  to  on the dial pad to enter the IP card number and Password (Maximum of 24 digits).
  - When the first digit is entered, the current IP card number password will be erased.
  - If the IP card number and password entered is more than 16 digits, only the last 16 digits will be displayed.
  - To cancel and exit, press  to return to the previous screen.
4. To save the IP card number and password, press the  key. The phone sounds a beep and the new IP card number and password is displayed.
5. To exit and return to standby mode press .

**K Note:** The settings of IP card number and password may be different due to different service terminals. Therefore, the card number and password must be set accordingly.

**K**    **Note:** If “#” is needed by the service network, press . And then symbol “” will be displayed.

### 3.8 Restricting your calling information (phone number)

This function allows you to select whether your phone number is hidden or displayed to the person you are calling. Support is required from your local service provider for this function to operate. Any individuals whom you call that subscribe to a Caller ID service and have a compatible phone will be notified of your phone number since the default setting is ON.



1. Press  and then  to display the caller number status on the LCD of the phone as shown in the figure below.

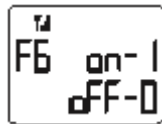

Example: ON=Notification

2. Press  to change the status of the caller number, the options ON-0 or OFF-1 are displayed in the LCD as shown in figure below.



3. Press  or  to turn the caller number ON or OFF.
  - The phone sounds a beep and the new caller number setting is displayed.

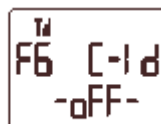

Example: OFF=no notification

4. To exit and return to standby mode press .
  - If you do not press any keys for 15 seconds the phone automatically returns to stand-by mode.

**K Note:** : OFF (no notification)  
: ON (notification)

## 4. Reference

### 4.1 Phone Maintenance

- Use a soft dry cloth for cleaning to wipe off any accumulated dust or fingerprints.
- Use a soft cloth dampened in water for cleaning to wipe off any heavily accumulated dust and dirt.
- Do not use harsh chemicals, cleaning solvents or strong detergents to clean the phone.

### 4.2 Troubleshooting

- Before requesting help please check the following.

Symptom	Diagnosis	Solution
The Unit does not work	AC adapter connected to the phone?	Connect the AC adapter to the Phone.
	AC adapter plugged into the wall outlet?	Plug in the AC adaptor.
	Battery connected?	Install the battery properly
	Dead Battery?	Connect the AC adapter to the Phone. Plug in the AC adaptor.
Cannot make calls	Sufficient Signal Strength?	Move to a place with stronger signal.
	Is the pause symbol "⏸" input among the number by error?	Input the correct number to place the call.
The call reception is bad (Static, sound cuts in/out, fades etc.)	Is there an obstacle surrounding you that is preventing signals to pass?	Change your location.

If the malfunction is beyond this table, or the corresponding solution is invalid, please contact UTStarcom PAS Customer Service Center.

**ADD: Building 2, Yile Industry Park No.129, Wenyi Road, Hangzhou 310012, PRC**

**Hot line: 800-8571082, 0571-8892345**

**FAX: 0571-88914678**

**E-mail: xiaolingtong@utstar.com**

BLANK PAGE