



JadeOS

User Manual

This device complies with Part 15 of the FCC Rules. Operation is subject to the following two conditions: (1) this device may not cause harmful interference, and (2) this device must accept any interference received, including interference that may cause undesired operation.

This equipment has been tested and found to comply with the limits for a Class B digital device, pursuant to part 15 of the FCC Rules. These limits are designed to provide reasonable protection against harmful interference in a residential installation. This equipment generates, uses and can radiate radio frequency energy and, if not installed and used in accordance with the instructions, may cause harmful interference to radio communications. However, there is no guarantee that interference will not occur in a particular installation. If this equipment does cause harmful interference to radio or television reception, which can be determined by turning the equipment off and on, the user is encouraged to try to correct the interference by one or more of the following measures:

- Reorient or relocate the receiving antenna.
- Increase the separation between the equipment and receiver.
- Connect the equipment into an outlet on a circuit different from that to which the receiver is connected.
- Consult the dealer or an experienced radio/TV technician for help.

FCC Caution: Changes or modifications not expressly approved by the party responsible for compliance could void the user's authority to operate the equipment.

Content

Content	1
Chapter 1 Preface	1
1.1 Intended Audience	1
1.2 Structure of this Document	1
1.3 Symbols and Conventions.....	1
1.3.1 Symbols Used	2
1.3.2 Conventions Used	2
1.4 History of Changes	2
Chapter 2 System Overview	3
2.1 System Introductions	3
2.2 Functions.....	3
2.3 Feature Highlights.....	4
2.4 Application.....	5
Chapter 3 CLI and System Management	7
3.1 CLI Access.....	7
3.1.1 CLI Access via the Local Console.....	7
3.1.2 CLI Access via a Remote Console.....	8
3.2 CLI Features.....	8
3.2.1 Command mode	9
3.2.2 Command Help	9
3.2.3 Command Completion.....	10
3.2.4 Deleting Configuration Settings	11
3.2.5 Profile Command.....	11
3.3 Configuring the Management Port.....	11
3.3.1 Configuring IP	11
3.3.2 Configuring Routing	11
3.4 Configuring Management	12
3.4.1 Inquire Configuration	12
3.4.2 Saving Configuration Changes	12

3.4.3 Reset JadeOS	12
3.4.4 Files Import/Export.....	12
3.5 System Update	13
3.6 File Operations.....	14
3.6.1 Basic Operations	14
3.6.2 Files Transfer by FTP and TFTP Command.....	14
3.6.3 JadeOS Image Image Files Transfer	15
3.6.5 Log Files Storage	15
3.7 User Management	15
3.8 Configuring System Settings	16
3.8.1 Setting Hostname	16
3.8.2 Setting Country Code.....	16
3.8.3 Setting Administrator Password.....	16
3.8.4 Setting System Clock.....	16
3.8.5 Clock Synchronization.....	17
3.8.6 Configuring NTP Authentication	17
3.9 Ping and Traceroute	18
3.10 License Management	18
Chapter 4 Interface Configuration.....	19
4.1 Naming Ethernet Port	19
4.2 Configuring VLAN	19
4.2.1 Creating VLAN.....	19
4.3 Adding Ethernet Port into VLAN	20
4.4 Configuring VLAN Interface.....	21
4.5 Configuring Port Channel	21
4.6 Configuring QinQ	23
4.6.1 Configuring QinQ	23
4.7 Inquiring Interface Status and Statistics.....	24
Chapter 5 Layer-2 Network Service	26
5.1 Bridge Forwarding	26
5.1.1 Bridge Description.....	26

5.1.2 Configuring Bridge	26
5.1.3 Dynamic Table	26
5.1.4 Bridge Aging	27
5.1.5 Static Table	27
5.2 Port Mirror	27
Chapter 6 Layer-3 Network Service	28
6.1 Configuring IP Address	28
6.1.1 Configuring IP Address	28
6.1.2 Configuring Loopback	28
6.2 Configuring Static Routing Table	28
6.2.2 Configuring Static Routing	28
6.2.2 Inquiring Routing Table	28
6.3 Configuring ARP	29
6.3.1 Configuring Static ARP Table	29
6.3.2 Inquiring ARP Table	29
6.3.2 Configuring ARP Proxy	30
6.4 Configuring MTU and TCP MSS	30
6.5 Configuring GRE Tunnel	31
6.6 Configuring DHCP	31
6.6.1 Configuring DHCP Server	32
6.6.2 Inquiring DHCP Server Status	32
6.6.3 Configuring DHCP Relay	34
6.6.4 DHCP Snooping	35
6.6.5 ARP With DHCP	36
6.7 Configuring OSPF	37
6.7.1 OSPF Implementation	37
6.7.2 Enabling OSPF	37
6.7.3 Configuring OSPF Interface Parameters	38
6.7.4 Configuring OSPF Area	39
6.7.5 Configuring OSPF Network Type	40

6.7.6 OSPF Point-to-point Configuration Example.....	40
6.8 Configuring IPv6	42
6.8.1 Address Configuration	42
6.8.2 Routing Configuration	42
6.8.3 Ping6	43
Chapter 7 Network Security	44
7.1 Access Control List (ACL)	44
7.1.1 Standard ACL.....	44
7.1.2 Extended ACL.....	44
7.1.3 Session ACL	45
7.2 Session	45
7.3 Configuring NAT	46
7.3.1 Configuring SNAT	47
7.3.2 Configuring DNAT	48
7.4 Configuring DoS Anti-attack	49
7.4.1 System Pre-defined Configuration.....	49
7.4.2 Configuring Anti-attack	49
7.5 Configuring Lawful Intercept	50
Chapter 8 Configuring HQoS	52
8.1 Configuring Rate Limitation on Port	52
8.2 Configuring Rate Limitation on VLAN.....	52
8.3 Configuring Rate Limitation on User	52
Chapter 9 Configuring AAA.....	54
9.1 The Attribute of Trust and Untrust.....	54
9.2 User and User Role	54
9.2.1 User.....	54
9.2.2 User Role and ACL.....	55
9.2.3 Access Policy Based on User Role	55
9.3 Connections among User, VLAN and User Role	56
9.4 Configuring AAA Profile.....	56
9.4.1 Configuring ACL	56

9.4.2 Configuring role.....	56
9.4.3 Configuring Radius Server Group	57
9.4.4 Configuring Authentication Way	57
9.4.5 Configuring AAA Profile.....	58
9.4.6 Binding VLAN.....	59
9.5 MAC Authentication	59
9.6 802.1X Authentication	60
9.7 WEB Portal Authentication.....	60
9.7.1 Web Authentication Process.....	60
9.7.2 DNAT Redirect	61
9.7.3 HTTP 302 Redirect	61
9.7.4 Configuring Portal Server	61
9.7.5 Configuring CoA Disconnect Message.....	61
9.7.6 Configuring Captive-portal Authentication	62
9.7.7 Customize Logout Domain.....	62
9.7.8 Configuring White-list and Black-list.....	62
9.8 Radius Proxy.....	63
9.8.1 Configuring Radius Proxy	63
9.8.2 Configuring EAP-SIM.....	64
9.9 Rate Limit Based on User	65
9.10 User Accounting.....	65
9.11 Example of WEB-Portal Authentication	66
9.12 Trouble Shooting.....	68
Chapter 10 WLAN Management	70
10.1 Wireless Network Architecture	70
10.1.1 CAPWAP Description.....	70
10.1.2 CAPWAP Control Channel.....	70
10.1.3 CAPWAP Data Channel.....	71
10.1.4 Mirror Upgrade and Configuration Management.....	71
10.1.5 Forwarding Mode	71

10.1.6 Authentication Mode.....	71
10.1.7 STATION Management	71
10.2 Forwarding Mode.....	71
10.3 Configuring Power.....	72
10.4 Configuring Radio	72
10.5 DTLS and CA	72
10.6 Special SSID and SSID Control	73
10.7 ACL.....	73
10.8 Authentication Exemption	75
10.9 Anti-fake and Rogue AP detect.....	75
10.10 Anti-DoS	75
Chapter 11 WEBUI.....	77
11.1 WEBUI Description.....	77
11.2 WEBUI Login	77
Chapter 12 Configuring SNMP	78
12.1 Configuring SNMP	78
Chapter 13 Maintenance and Diagnosis	79
13.1 Log System	79
13.2 System Management.....	79
13.3 Sniffer Tool	81
Abbrviations	82

Chapter 1 Preface

This preface describes the audience, structure, conventions and history of changes of JadeOS User Manual. It also provides important information about safety instructions for the JadeOS.

1.1 Intended Audience

This document is intended to the experienced network administrators who need to configure and maintain JadeOS Multi-Service Gateway.

1.2 Structure of this Document

Chapter	Title	Subject
Chapter 1	Preface	This chapter provides an introduction to this document.
Chapter 2	System Overview	This chapter gives a general introduction to the JadeOS functionality.
Chapter 3	CLI and System Management	This chapter describes CLI and system operations.
Chapter 4	Interface Configuration	This chapter will describe how to configure interface.
Chapter 5	Layer-2 Network Service	This chapter describes how to configure Layer-2 network service.
Chapter 6	Layer-3 network service	This chapter describes how to configure Layer-3 network service.
Chapter 7	Network Security	This chapter will describe JadeOS network security function and how to configure it.
Chapter 8	Configuring HQoS	This chapter describes how to configure HQoS.
Chapter 9	Configuring AAA	This chapter describes how to configure AAA.
Chapter 10	WLAN Management	This chapter gives a general introduction to the WLAN Management.
Chapter 11	WEBUI	This chapter gives a general introduction to the WEBUI.
Chapter 12	Configuring SNMP	This chapter describes how to configure SNMP.
Chapter 13	Maintenance and Diagnosis	This chapter gives a general introduction to the Maintenance and Diagnosis.

Table 1-1 Chapters in this Document

1.3 Symbols and Conventions

The following symbols and conventions are used in this document:

1.3.1 Symbols Used

 **CAUTION:** Means that the reader should be careful. In this situation, you might do something that could result in equipment damage or loss of data.

 **WARNING:** This warning symbol means danger. You are in a situation that could cause bodily injury. Before you work on any equipment, be aware of the hazards involved with electrical circuitry and be familiar with standard practices for preventing accidents.

1.3.2 Conventions Used

Representation	Meaning
Bold	The CLI commands are in bold .
<i>Italic</i>	Level 2 titles are in <i>Italic</i> .
Courier New	Terminal display is in Courier New. Example: # ping -t 10.10.10.1

Table 1- 2 Conventions Used in this Document

1.4 History of Changes

Version	Issue date	Remarks
Draft	2013.10.11	Draft Version
01	2013.11.15	New functions added, upgraded to 01 Version
02	2013.11.30	New functions added, upgraded to 02 Version
03	2014.01.15	New functions added, upgraded to 03 Version

Table 1- 3 Histories of Changes for this Document

Chapter 2 System Overview

2.1 System Introductions

MSG10000 is a gateway equipment of telecommunication level that integrated with the functions of routing, switching and WLAN controller and so on.

Based on the multi-core and multi-thread processor and designed with telecom grade ATCA standard, MSG10000 is with powerful and extensible performance. With centralized management and configuration, it gives the ability of deployment for a large network with hundreds of gateways. At the same time, it can be operated in day and night with high availability and help the SP to meet the huge challenge brought by rapid development of wireless service.

Based on the advanced and extensible software architecture, JadeOS:

- Adopt distributed architecture with data plane and control plane separated
- Provide WLAN solutions that are flexible, easy management and easy deployed
- Manage large scale APs without configuration
- Strictly control user internet access and bandwidth strategy with various access authentication
- Support 700 users/s per line card
- Provide forwarding rate of high performance
- Support multi-level redundancy backup for system level, service module level etc.

2.2 Functions

Layer-2

- Bridge Forwarding
- VLAN/Super VLAN
- QinQ
- Port Channel

Layer-3

- Route Forwarding
- Dynamic Routing Protocol (OSPF)
- NAT
- GRE/EtherIP Tunnel
- DHCP Server, DHCP Relay, DHCP SNOOPING
- Broadcast Suppression
- Virtual Routing Redundancy Protocol(VRRP)
- Fragmentation and Reassembly
- IPv4/IPv6

Security and AAA (Authentication, Authorization, Accounting)

- Access Control List (Interface/Standard/Session ACL)
- Role-Based User Policy
- Web Portal/802.1x/PSK/MAC Authentication
- RADIUS Accounting
- RADIUS Proxy
- Black-list and whit- list authentication
- DoS anti-attacks
- Lawful Interception

QoS functionality

- Rated Limit based on interface/user/ssid (HQoS)

WLAN Controller

- CAPWAP Control Tunnel and Data Tunnel
- AP Centralized Management and Configuration
- AP Discovery AC
 - Broadcast discovery mode
 - DNS discovery mode
 - DHCP discovery mode
- Local Forwarding, Centralized Forwarding
- Intelligent Radio /Frequency Management
- Certificate Management
- User Access Control
- L2 Roaming
- Station Anti-fake, WLAN Anti-DoS
- Performance Monitor and Data Statistics

Network Management

- Configuration based on CLI (Support console, SSH, Telnet)
- Support WebUI configuration
- SNMP v1, v2c,
- System configuration, service module monitor
- Trap alarm
- Chassis management
- Trouble shooting
- Port Mirror, Sniffer

2.3 Feature Highlights

Extensible DHCP Server

DHCP server offers 700 pps users per thread that can meet carrier-grade scenarios that requires high performance and high availability.

-
- Scalable performance and throughout
 - Optimized database
By keeping lease information in a memory-resident database, DHCP server offers fast response times for lease assignments and renewals.
 - Multi-threaded architecture
JadeOS uses a multi-threaded architecture to deliver consistent throughput.
 - Carrier level big address pool
JadeOS supports up to 1,320,000 addresses per chassis.

Broadcast Suppression

JadeOS provides broadcast suppression function to reduce the number of broadcast packets by enabling broadcast suppression policy.

- Broadcast suppression function to greatly ease the number of broadcast messages
- DHCP snooping to suppress the DHCP broadcast packets.
- Enable DHCP unicast reply function. JadeOS reply the DHCP offer and ACK datagram with unicast messages instead of broadcast messages to effectively reduce the broadcast flooding.

2.4 Application

JadeOS can be deployed in the core network or access network to achieve the AP centralized management and configuration. Figure 2-3 illustrates one of the application scenarios of

JadeOS.

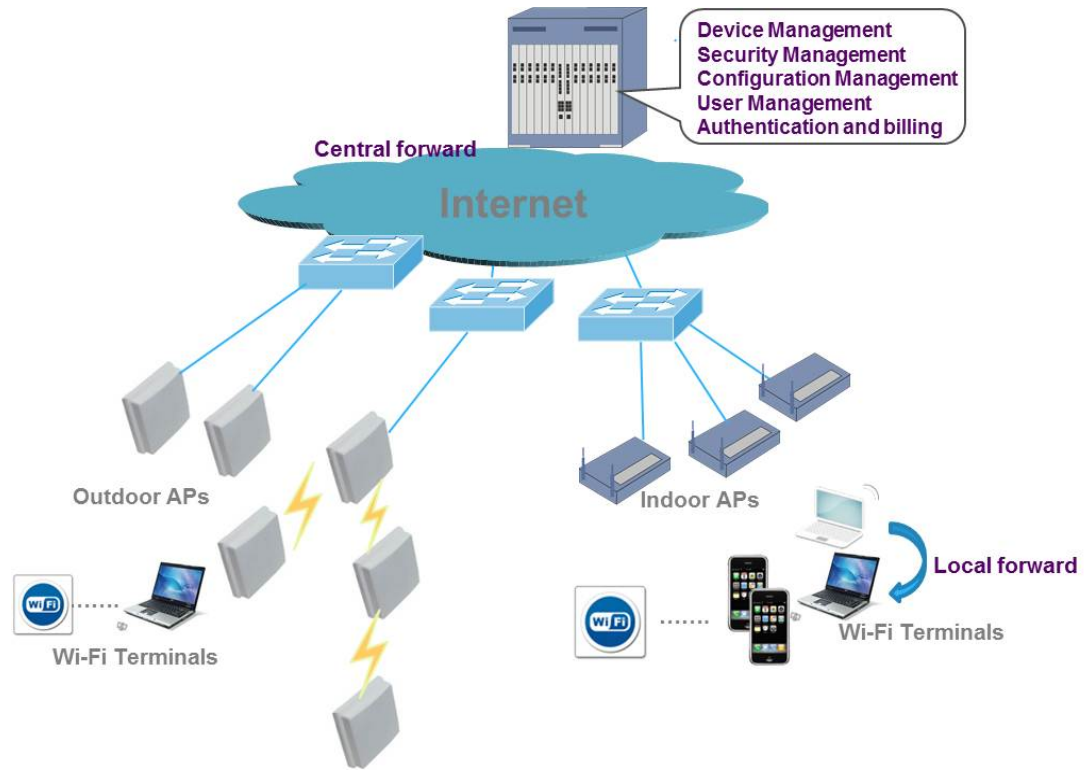

Figure 2-1 Application scenario of JadeOS

Chapter 3 CLI and System Management

JadeOS uses the command Line Interface (CLI) to implement the interaction between users and the operating system. Users can complete a range of system configuration and realize the management functions through the CLI.

This chapter describes CLI and system operations.

3.1 CLI Access

The console port on the equipment is Rj45 interface and located on the front panel of each line card. You can connect to the CLI via the local console or SSH/TELNET to obtain a remote console.

3.1.1 CLI Access via the Local Console

To connect to the CLI via the local console port, complete the following steps:

Step 1 Connect to the console port using the Rj45 cable and serial port cable.

Step 2 Configure your terminal emulation program (for example: SecureCRT) is configured as shown in figure 3-1:

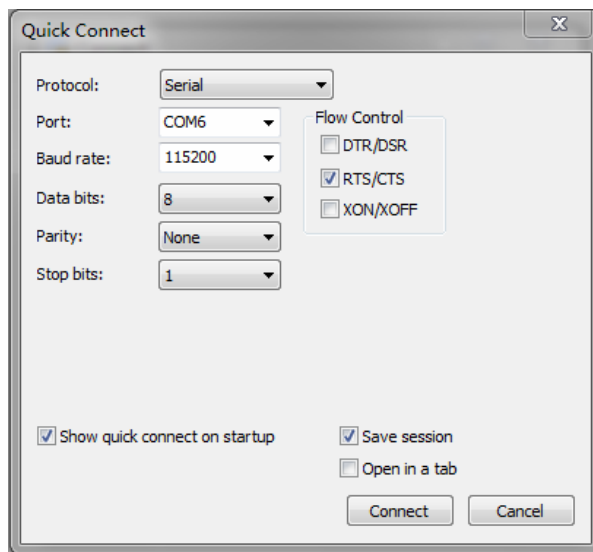

Figure 3-1 Console port connection settings

Step 3 Enter the user name and password:

(JadeOS)

User: admin

Password: admins.

The prompt will be displayed as follows after logging in successfully.

(JadeOS) >

Step 4 Enter the global mode using the following command:

```
(JadeOS) > enable
```

```
Password: enable
```

When you are in enable mode, the > prompt changes to a pound sign (#):

```
(JadeOS) #
```

Step 5 Enter the configuration mode using the following command:

```
(JadeOS) # configure terminal
```

When you are in the configuration mode, 'config' appears before the # prompt:

```
(JadeOS) (config) #
```

3.1.2 CLI Access via a Remote Console

Users can access JadeOS remotely using TELNET from a TCP/IP network.

To access JadeOS via telnet you need to enable telnet sessions using **telnet cli** command.

To connect to the CLI using TELNET, complete the following steps:

Step 1 Verify that your terminal emulation program or DOS shell interface (for example: SecureCRT) is configured as shown in figure 3-2:

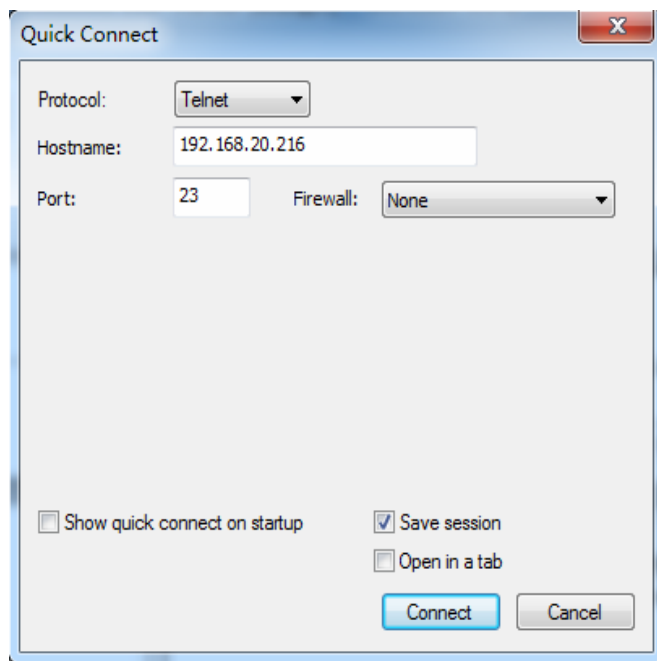

Figure 3-2 Telnet connection settings

Step 2 Enter a valid username and password as prompt.

3.2 CLI Features

This chapter will give a general introduction about the CLI commands.

3.2.1 Command mode

The CLI is divided into many different modes. The commands available to you at any given time depend on the mode that you are currently in. Entering a question mark (?) at the CLI prompt allows you to obtain a list of commands available for each command mode.

When you log in to the CLI, you are in user mode. User mode contains only a limited subset of commands.

To have access to all commands, you must enter enable mode normally by using a password. From enable mode, you can issue any enable mode command.

You can enter global configuration mode by entering **configure terminal** command.

Configuration modes allow you to make changes to the running configuration. If you later save the running configuration to the startup configuration, these changed commands are stored when the software is rebooted. To enter specific configuration modes, you must start at global configuration mode. From global configuration mode, you can enter interface configuration mode and a variety of other modes.

Table 3-1 describes how to access and exit various common command modes on JadeOS. It also shows examples of the prompts displayed for each mode.

Command Mode	Access Method	Prompt	Exit Method
User Mode	Log in	(JadeOS)>	Use the exit command
Enable Mode	Enter enable and password	(JadeOS)#	To return to User Mode use exit command
Global Configuration Mode	Enter configure terminal	(JadeOS)(config)#	To return to Enable Mode from global configuration mode, use exit command
Interface Configuration Mode	Specify an interface using interface command	(JadeOS)(config-if)#	To return to the global configuration mode, use exit command.

Table 3- 1 Command Modes on JadeOS

3.2.2 Command Help

You can use the question mark (?) to view various types of command help.

When typed at the beginning of a line, the question mark lists all the commands available in your current mode or sub-mode. A brief explanation follows each com-

mand. For example:

```
(JadeOS) > ?
enable          Turn on Privileged commands
exit            Exit this session. Any unsaved changes are lost.
help            Help on CLI command line processing and a
                Description of the interactive help system
logout          Exit this session. Any unsaved changes are lost.
ping            Send ICMP echo packets to specified ip address.
traceroute      Trace route to the specified ip address.
```

When typed at the end of a possible command or abbreviation, the question mark lists the commands that match (if any). For example:

```
(JadeOS) #a?
aaa             Authentication commands
ap             Instruct AP
ap-leds        Control AP LED behavior (11n APs only)
ap-regroup     Move AP into a group
ap-rename      Change an AP's name
apboot        Instruct AP to reboot itself
apconnect      Instruct Mesh-Point to connect new parent
apdisconnect   Instruct Mesh-Point to disconnect from its parent
apflash       Instruct AP to reflash itself
```

If more than one item is shown, type more of the keyword characters to distinguish your choice.

However, if only one item is listed, the keyword or abbreviation is valid and you can press tab or the spacebar to advance to the next keyword.

When typed in place of a parameter, the question mark lists the available options. For example:

```
(JadeOS) #write ?
erase  erase configuration from NV memory
file   Write to file
memory Write to NV memory
<cr>
```

3.2.3 Command Completion

To make command input easier, as you type, you can press the spacebar or tab to move to the next keyword. The system then attempts to expand the abbreviation for you. If there is only one command keyword that matches the abbreviation, it is filled

in for you automatically. If the abbreviation is too vague (too few characters), the cursor does not advance and you must type more characters or use the help feature to list the matching commands.

3.2.4 Deleting Configuration Settings

Use the **no** command to delete or negate previously-entered configurations or parameters. To view a list of **no** commands, type **no** at the enable or 'config' prompt followed by the question mark.

```
(JadeOS) (config) # no?
```

3.2.5 Profile Command

JadeOS uses Profile to design some complex commands. JadeOS encapsulates a set of configurations in Profile, and then apply the Profile to other configured object. This will make configuration more logical.

3.3 Configuring the Management Port

3.3.1 Configuring IP

Management port is used for the network administrator to operate the equipment in remote. To configure management port, you need to configure IP address first so that to access the equipment in remote:

Step 1 Access management port mode:

```
interface mgmt <id>
```

step 2 Configuring Ip address:

```
ip address A.B.C.D/MASK-Length
```

Parameter	Description
id	Range: 1-2

Table 3-2 parameter description

Example as follows:

```
(JadeOS)(config)#interface mgmt 1
```

```
(JadeOS)(config)#ip address 192.168.1.254/24
```

3.3.2 Configuring Routing

You need to configure a static routing to access local PC of remote administrator. To Configure static routing table, use the following command in **Config** mode:

```
ip route <dest-subnet> <gateway>
```

For example, we configure a route to administrator subnet 192.168.0.0/24 through next hop 192.168.1.1.

```
(JadeOS)(config)#ip route 192.168.0.0/24 192.168.1.1
```

3.4 Configuring Management

3.4.1 Inquire Configuration

To view present configuration, use the command:

```
(JadeOS) # show running-config
```

3.4.2 Saving Configuration Changes

When you make configuration changes via the CLI, those changes affect the current running configuration only. If the changes are not saved, they will be lost after the MSG10000 reboots. To save your configuration changes, use the following command in enable mode:

```
(JadeOS) # write memory
```

After performing the command **write memory**, two configuration files will be saved in the flash:

- **startup-config**: Containing the startup configuration options
- **running-config**: Containing the configuration options during system running.

3.4.3 Reset JadeOS

You can return JadeOS to its original configuration by resetting the JadeOS to factory-default settings.

Step 1 Enter the **write erase** command. A prompt ‘Do you really want to delete all the configuration(y/n):’, write erase successful’ will be displayed.

```
(JadeOS) (config) #write erase
Do you really want to delete all the configuration(y/n):
Write Erase successful
```

Step 2 Reload the JadeOS by entering **reload** command. The prompt ‘do you really want to restart the system (y/n)’ will be displayed. Enter ‘y’, the JadeOS will reboot.

```
(JadeOS) (config) #reload
Do you really want to restart the system(y/n): n
```

3.4.4 Files Import/Export

You can save configuration files into JadeOS and copy to an external server.

```
copy startup-config flash: <filename>
copy startup-config tftp: <tftphost> <filename>
copy running-config flash: <filename>
copy running-config ftp: <ftphost> <user> <password> <filename>    [<remote-dir>]
copy running-config startup-config
copy running-config tftp: <tftphost> <filename>
```

3.5 System Update

The system image file is stored in the Compact Flash (CF) on each line card. Every time you start the system, bootloader will automatically download the image to system RAM. The CF card is divided into two partitions which both contain the system image files. At the factory default setting, bootloader will download image files from partition 0. After system updating, JadeOS will automatically start from the partition which contains the updated image files. You can also specify which partition to start from manually. To update the system image file, complete the following steps:

Step 1 Input the user name and password after connecting the JadeOS through SSH, telnet or console.

Step 2 Turn into the global configuration mode by entering the command **configure terminal**.

Step 3 Turn into the interface configuration mode by entering the command **interface mgmt**.

Step 4 Set mgmt interface IP address and make sure the tftp or ftp server is ok.

Step 5 Copy the image file to partition 0/1 on CF card.

The system will reboot after the update complete.

Note: It's recommended that you update the system image files from the partition which the system is not working on to avoid that the current image files are erased. For example: if the system is working on partition 0, please update the system image files from partition 1.

To change boot partition, use following command in Config mode:

```
(JadeOS) (config)#boot system partition 0
```

To view image information about boot partition, use following command in enable mode:

```
(JadeOS) #show image version
```

```
-----  
Partition          : 0:0 (/dev/sda1)  
Software Version   : JadeOS 2.3.2.0  
Built on           : SMP Thu Dec 19 18:01:40 CST 2013  
-----  
Partition          : 0:1 (/dev/sda2)  
Software Version   : JadeOS 2.2.6.0  
Built on           : SMP Mon Nov 18 14:58:24 CST 2013
```

3.6 File Operations

3.6.1 Basic Operations

JadeOS provide basic operations about files such as dir、copy、rename、delete and so on, the command is as following:

Dir files:

```
(JadeOS) #dir
```

Copy files:

```
(JadeOS) #copy  
flash: <srcfilename> {flash: <destfilename> | tftp: <tftpghost> <destfilename> | ftp:<ftphost> <user>  
<filename>} |  
ftp: <ftphost> <user> <filename> {system: partition {0|1} |flash: <filename> }|  
running-config {flash: <filename> | ftp: <ftphost> <user> <password> <filename> | tftp: <tftpghost>  
<filename>} |  
startup-config {flash: <filename> | tftp: <tftpghost> <filename>} |  
system: partition {<srcpartition> 0|1}|  
tftp: <tftpghost> <filename> {flash: <destfilename>}|
```

Rename files:

```
(JadeOS) #rename <old> <new>
```

Delete files:

```
(JadeOS) #delete filename <file>
```

3.6.2 Files Transfer by FTP and TFTP Command

You can transfer the following files between JadeOS and an external server or host:

- JadeOS image files
- A specified file in JadeOS flash file system, or a compressed archive that contains the flash file
- Configuration file, either the running configuration or a startup configuration

- Log files

You can use the following protocols to transfer files between JadeOS and external server or host:

- File Transfer Protocol (FTP)
- Trivial File Transfer Protocol (TFTP)

Sever Type	Configuration
Trivial File Transfer Protocol(TFTP)	IP address of the server Filename
File Transfer Protocol(FTP)	IP address of the server Username and password to log into server Filename

Table 3- 3 Parameters of TFTP and FTP Configuration

3.6.3 JadeOS Image Image Files Transfer

You can copy JadeOS image files to JadeOS or equipment by TFTP or FTP server.

When you transfer a JadeOS image file to equipment, you must specify the partition which the file is copied to. You have the option of rebooting JadeOS with the transferred image file.

```
copy tftp: <tftphost> <filename> system: partition {0|1}
copy ftp: <ftphost> <user> <filename> system: partition {0|1}
copy scp: <scphost> <username> <filename> system: partition [0|1]
```

3.6.5 Log Files Storage

You can save log files into a compressed archive and copy to an external TFTP server.

```
tar logs
copy flash: logs.tar tftp: <tftphost> <destfilename>
copy flash: logs.tar scp: <scphost> <username> <destfilename>
```

3.7 User Management

To create users, you can use the command:

```
mgmt-user <user> <password>
```

For example, create a user account “test” and password “123456”:

```
(JadeOS) (config)#mgmt-user test 123456
```

To inquire users in the system, you can use the command:

```
(JadeOS) #who
vty[0] connected from 192.168.16.21
vty[1] connected from 192.168.16.22
vty[2] connected from 192.168.16.19
vty[3] connected from 192.168.16.19
```

3.8 Configuring System Settings

3.8.1 Setting Hostname

The factory default hostname is JadeOS. You can change the hostname using the following command:

```
hostname <hostname>
```

For example:

```
(JadeOS) (config) #hostname Gate
(Gate) (config) #
```

3.8.2 Setting Country Code

JadeOS are designed to manage the access points which are located in many countries with different requirements. The radios within the access points are assigned to a specific regulatory domain at the factory. You can specify a particular country code for each country (such as FR for France or ES for Spain). Configuring a country code ensures that each radio's broadcast frequency bands, interfaces, channels, and transmit power levels which are compliant with country-specific regulations.

When the JadeOS start for the first time, the system will prompt you to enter the country code which country the JadeOS is located and you need to confirm the country code by entering 'yes'.

3.8.3 Setting Administrator Password

To log in JadeOS, you must enter the administrator user account and password. The factory default user account is 'admin' and the password is "admins".

A prompt 'Enter password for admin login' will be displayed after you enter the administrator user account 'admin'. You can enter the password that you want to set and retype it to confirm. Except for the administrator user, you can set 9 users.

3.8.4 Setting System Clock

You can set the JadeOS system date and time manually using the configuration wizard when you start the JadeOS system for the first time. Greenwich Mean Time (GMT) is used as the standard for setting the time zone.

➤ **Setting the System Clock Manually**

To set the date and time, enter the following command in privileged mode:

```
clock set <year><month><date><hour><minutes><seconds>
```

To set the time zone and daylight savings time adjustment, enter the following commands in configure mode:

```
clock timezone<WORD><-23 - 23>
clock summer-time <zone> [recurring]
<1-4><start day><start month><hh:mm>
first<start day><start month><hh:mm>
last<start day><start month><hh:mm>
<1-4><end day><end month><hh:mm>
first<end day><end month><hh:mm>
last<end day><end month><hh:mm>
[<-23 - 23>]
```

➤ **Setting the System Clock with NTP**

You can use NTP (Network Time Protocol) to synchronize JadeOS to a central time source.

3.8.5 Clock Synchronization

For each NTP server, you can optionally specify the NTP iburst mode for faster clock synchronization. The iburst mode sends up ten queries within the first minute to the NTP server. (When iburst mode is not enabled, only one query is sent within the first minute to the NTP server.) After the first minute, the iburst mode typically synchronizes the clock so that queries need to be sent at intervals of 64 seconds or more.

You can add a NTP server using the following command:

```
ntp server <ipaddr> [iburst]
```

3.8.6 Configuring NTP Authentication

The NTP adds security to an NTP client by authenticating the server before synchronizing the local clock. NTP authentication works by using a symmetric key which is configured by the user. The secret key is shared by both JadeOS and an external NTP server. This helps identify secure servers from fraudulent servers.

This example enables NTP authentication, add authentication secret keys into the database, and specifies a subset of keys which are trusted. It also enables the iburst option.

```
(JadeOS)(config)#ntp authenticate
```

```
(JadeOS)(config)#ntp authentication-key <key-id> md5 <key-secret>
```

```
(JadeOS)(config)#ntp trusted-key <key-id>
(JadeOS)(config)#ntp server <IP> iburst
```

Example of configuring NTP authentication:

```
(JadeOS)(config)#ntp authenticate
(JadeOS)(config)#ntp authentication-key 1 md5 123
(JadeOS)(config)#ntp trusted-key 1
(JadeOS)(config)#ntp server 1.1.1.1 iburst
```

3.9 Ping and Traceroute

Command ping and traceroute can help to diagnose network connection status.

Command format:

```
ping A.B.C.D
traceroute A.B.C.D
```

For example, use command **ping** in enable mode to judge whether the internet connection to IP address '192.168.20.1' or not.

```
(JadeOS) #ping 192.168.20.1
Sending..., 100-byte ICMP Echos to 192.168.20.1, press 'q' or ESC to exit:
!!!!
Success rate is 100 percent (5/5), round-trip min/avg/max = 0.686/0.7134/0.808 ms
```

3.10 License Management

License is mainly used to protect the lawful rights of authorized users. You can obtain the authorization by input License Activation Key.

Note: please contact the vendors if you need to add APs after license is in effective.

To add License key, you can use following command in config mode:

```
license add <key>
```

Note: Key is provided by vendors, and the length is 192 characters.

After license key is in effective, you can inquiry the limit number of AP and station by the following command:

```
show license limit
```

To display license key, you can use following command:

```
show license
```

Chapter 4 Interface Configuration

This chapter will describe how to configure interface.

4.1 Naming Ethernet Port

GigabitEthernet <word> is GE port, and parameter ‘word’ format is <slot/port>. ‘slot’ means slot number, ‘port’ means port number. Both start with value 0 and range depends on the real number of Ethernet.

For example, gigabitEthernet 1/0, gigabitEthernet 1/1 and gigabitEthernet 1/2 means the first Ethernet port, the second Ethernet port and the third Ethernet port of the first slot.

Ten gigabitEthernet<word> is 10G port, and parameter ‘word’ format is the same as GE port.

To inquiry present slot number, use **show slot** command:

```
(JadeOS) #show slot
Slot12
```

‘slot 12’ means present slot number is 12.

4.2 Configuring VLAN

JadeOS operates as a layer-2 switch that uses a VLAN as a broadcast domain. As a layer-2 switch, JadeOS requires a layer-3 router to route traffic between VLANs.

4.2.1 Creating VLAN

You can configure Vlan in vlan mode:

Step 1 Enter vlan mode by using following command in config mode:

```
vlan database
```

Step 2 Creating vlan

```
vlan <id>
```

Note: Delete vlan by using **no vlan <id>** command.

For example:

```
(JadeOS)(config)#vlan database
(JadeOS)(config-vlan)#vlan 2
(JadeOS)(config-vlan)#vlan 3 name "VLAN3"
(JadeOS)(config-vlan)#no vlan 2
```

Command	Description
Vlan 2	Create vlan 2
vlan 3 name "VLAN3"	Create vlan 3, and name as“vlan 3”
No vlan 2	delete vlan 2

Table 4-1 command descriptions

4.3 Adding Ethernet Port into VLAN

The Ethernet port can be set in access mode or trunk mode, and then added into a VLAN. The Ethernet port is in access mode by default. If it is set in trunk mode, the port can carry data of multi VLAN Tag.

The port channel can be set in access mode or trunk mode. By default, a port channel is in access mode and carries traffic only for the VLAN that is assigned. In trunk mode, a port channel can carry traffic for multiple VLANs.

➤ Configure Port in access mode

Step 1 Enter physical interface mode

```
interface gigabitEthernet <slot/port>
```

step 2 Configure layer-2 interface mode

```
switchport mode access
```

step 3 Add into the corresponding vlan

```
switch access vlan <vlan-id>
```

For example, add gigabitEthernet 1/2 into access vlan 2

```
(JadeOS)(config) #interface gigabitEthernet 1/2
```

```
(JadeOS)(config-if)#switchport mode access
```

```
(JadeOS)(config-if)#switchport access vlan 2
```

➤ Configure Port in Trunk Mode

Step 1 Entering physical interface mode

```
Interface gigabitEthernet 1/0
```

Step 2 Configure layer-2 interface mode

```
switchport mode trunk
```

Step 3 Specify the native vlan id and available vlan tag number respectively

```
switch trunk native vlan <vlan-id>
```

```
switchport trunk allowed vlan add <vlan-id-list>
```

Parameter	Description
Vlan-id	Specify native vlan id
Vlan-id-list	Specify available vlan tag

Table 4-2 parameter Descriptions

For example, add gigabitethernet 1/2 into access vlan 2

```
(JadeOS)(config)#interface gigabitethernet 1/2
(JadeOS)(config-if)#switchport mode trunk
(JadeOS)(config-if)#switchport trunk native vlan 4
(JadeOS)(config-if)#switchport trunk allowed vlan add 5-10,11,12
```

4.4 Configuring VLAN Interface

Command to configure VLAN Interface:

```
interface vlan <1-4094>
```

Note: you need to create VLAN first before configuring Vlan Interface.

For example:

```
(JadeOS) (config)#interface vlan 2
(JadeOS) (config-if)#ip address 10.0.0.1/24
```

4.5 Configuring Port Channel

Link aggregation provides higher total bandwidth, auto-negotiation, and recovery by combining parallel network links between devices as a single link.

Port-Channels provide a mechanism for aggregating multiple physical Ethernet links to a single logical Ethernet link. Port-Channels are typically used to increase availability and bandwidth, while simplifying the network topology.

Step 1 Configure port-channel in config mode:

```
Interface port-channel <id>
```

Step 2 Add Ethernet port into aggregation group in port-channel interface mode:

```
add [gigabitethernet <slot>/<port> | tengigabitethernet <slot>/<port>]
```

Note: To delete one port, use following command:

```
del [gigabitethernet <slot>/<port> | tengigabitethernet <slot>/<port>]
```

Step 3 Configure balance arithmetic, now it supports arithmetic of active-standby and load-balance:

```
(JadeOS)(config-if)#balance arithmetic active-standby
(JadeOS)(config-if)#balance arithmetic load-balance
```

Examples :

```
(JadeOS)(config)#interface port-channel 1
(JadeOS)(config-if)#add gigabitethernet 2/1
(JadeOS)(config-if)#balance arithmetic active-standby
(JadeOS)(config-if)#balance arithmetic load-balance
```

Inquire LAG by using **show Interface port-channel <id>** command:

```
(JadeOS)#show interface port-channel 2
Port-Channel 2 is administratively up
Hardware is Port-Channel, address is 04:8B:42:10:0D:0B (bia 04:8B:42:10:0D:0B)
Description: Link Aggregate (LACP)
Spanning Tree is disabled
VLAN membership:    190
Switchport priority: 0
Member port:
    GE 4/3, Admin is up, line protocol is up
    GE 4/4, Admin is up, line protocol is up
link status last changed 0 day 0 hr 16 min 46 sec
106198 packets input, 21374111 bytes
Received 124 broadcasts, 0 runts, 7483 giants, 0 throttles
11936475 input error bytes, 545 CRC, 0 frame
82048 multicast, 24026 unicast
14148 packets output, 432640 bytes
0 output errors bytes, 0 deferred
0 collisions, 0 late collisions, 0 throttles
Port-Channel 2 is TRUSTED
```

Delete LAG by using **no interface port-channel <id> command:**

```
(JadeOS)(config)# no interface port-channel 0
```

The port channel can be set in access mode or trunk mode. By default, a port channel is in access mode and carries traffic only for the VLAN that is assigned. In trunk mode, a port channel can carry traffic for multiple VLANs.

➤ **Configure Port Channel in access mode**

```
(JadeOS)(config)#interface port-channel 1
(JadeOS)(config-if)#switchport mode access
(JadeOS)(config-if)#switchport access vlan 2
```

➤ **Configure Port channel in trunk mode**

```
(JadeOS)(config) #interface port-channel 2
(JadeOS)(config-if)#description Portchannel2
(JadeOS)(config-if)#switchport mode trunk
(JadeOS)(config-if)#switchport trunk native vlan 5
(JadeOS)(config-if)#switchport trunk allowed vlan 6-9,10
```

4.6 Configuring QinQ

4.6.1 Configuring QinQ

Defined in IEEE802.1Q, VLAN Tag domain only uses 12 bytes to indicate VLAN ID, so equipment can support up to 4094 VLANs. Some scenarios, especially in metropolitan area network, require a separate VLAN for customers. Therefore, 4094 VLAN cannot meet the requirement. The 802.1QinQ expands VLAN space by using a VLAN-in-VLAN hierarchy and tagging the tagged packets. At the same time, QinQ makes SP use one VLAN supports the entire customer's VLANs. SP provides different service for different customers by decapsulating inner and outer vlan tag of users' message.

Configuring QinQ by using following command:

Step 1 Create QinQ sub-interface in physical interface:

```
interface gigabitethernet/tengigabitethernet <slot>/<port>.<subif>
```

parameter	description
slot	Slot number, range: 1-13
port	Port number
subif	Sub interface, range: 1-16760836

table 4-3 Parameter Description

For example, create QinQ sub-interface gigabitethernet 1/0.1 in Ethernet interface gigabitethernet 1/0:

```
interface gigabitethernet 1/0.1
```

step 2 Specify QinQ inner and outer tag

```
encapsulation dot1q <outer-vlan-id> second-dot1q <vlan-id[[begin-end]]>
```

Parameter	Description
out-vlan-id	Single tag number, range: 1-4094
vlan-id[[begin-end]]	Single tag number, range: 1-4094; or range, for example: 100-200

table 4-4 Parameter Description

For example: create a QinQ interface that outer tag is 1000 and inner tag range is 100-200, and configure IP address as a layer-3 interface.

```
(JadeOS)(config)#interface gigabitethernet 10/0.1  
(JadeOS)(config-subif)# encapsulation dot1q 1000 second-dot1q 100-200  
(JadeOS)(config-subif)#ip address 1.1.1.1/32
```

The sub-interface can be used as a layer-3 routing sub-interface. You can configure IP address and routing in it. 2 QinQ Tag will be peeled when receiving data, and 2 QinQ

Tag will be encapsulated when sending data.

You can configure different services (for example, different authentication policies or bandwidth control policies) on different inner tag when data received in QinQ sub-interface.

4.7 Inquiring Interface Status and Statistics

To view interface information, use **show interface gigabitethernet <Slot/Port>** command:

```
(JadeOS) #show interface gigabitethernet 12/0
Interface gigabitethernet 12/0
  Hardware is Ethernet
  Current HW addr: 04:8b:42:10:5c:00
  Physical:04:8b:42:10:0c:18
  index 23 metric 1 mtu 1500 duplex-half arp ageing timeout 300
  tcp4mss disable tcp6mss disable
  proxy_arp disable local_proxy_arp disable
  (UP,BROADCAST,RUNNING,MULTICAST,TRUST)
  VRF Binding: Not bound
  inet 119.6.100.5/24 broadcast 119.6.100.255
  inet6 fe80::68b:42ff:fe10:5c00/64
  input packets 1779, bytes 117400, dropped 0, multicast packets 0
  input errors 0, length 0, overrun 0, CRC 0, frame 0, fifo 0, missed 0
  output packets 8, bytes 837, dropped 0
  output errors 0, aborted 0, carrier 0, fifo 0, heartbeat 0, window 0
  collisions 0
```

To view all interfaces information, use **show ip interface brief** command:

```
(JadeOS) #show ip interface brief
```

Interface	IP-Address / IP-Netmask	Status	Protocol
loopback 0	unassigned / unassigned	up	down
Te 12/0	unassigned / unassigned	up	down
vlan 1	unassigned / unassigned	up	down
mgmt 1	192.168.20.95 / 255.255.255.0	up	up
Gi 12/0	119.6.100.5 / 255.255.255.0	up	up
Gi 12/2	172.50.3.1 / 255.255.255.0	up	up
Gi 12/4	unassigned / unassigned	down	down
Gi 12/6	unassigned / unassigned	down	down
Gi 12/8	unassigned / unassigned	up	up
Gi 12/10	unassigned / unassigned	down	down
Gi 12/12	unassigned / unassigned	down	down

Gi 12/14	unassigned / unassigned	down	down
Gi 12/16	unassigned / unassigned	down	down
Gi 12/18	unassigned / unassigned	down	down

Chapter 5 Layer-2 Network Service

JadeOS provides layer-2 network service. This chapter will describe bridge forwarding and port mirror.

5.1 Bridge Forwarding

5.1.1 Bridge Description

Bridge is used for the interconnection among two or more Layer-2 network and data frame forwarding based on MAC address of Layer-2 network.

Bridge supports MAC address learning. Bridge will create one bridge table based on source MAC address when one data frame from one MAC address first going through bridge. Bridge table is indexed by MAC address, and it will record the physical interface connected to this host. Thereafter, when data frame from the same MAC address come to this host again, it will be sent to this physical interface so that to avoid sending broadcast message to all interfaces.

Bridge forwarding is based on bridge table, each MAC address is corresponding to one table. Bridge table will be automatically deleted if there is no data frame from the same MAC address going through this bridge table for a while. When there is data frame coming to this bridge after a while, bridge will learn MAC address again. Besides dynamic learning, bridge table supports static configuration, which is called static table.

5.1.2 Configuring Bridge

Bridge configuration is to add several physical interfaces to the same VLAN. In the same VLAN, several interfaces form a bridge, the communication among the interfaces is bridge forwarding.

Please refer to chapter 4.2 and chapter 4.3 for more information.

5.1.3 Dynamic Table

Dynamic table is generated by system learning. System will look up bridge table when receiving message. If no bridge table is available, system will automatically generate a bridge table based on the source MAC address, VLAN ID, and the interface of message.

To inquiry bridge table, use **show datapath bridge table** command.

For example:

```
(JadeOS) #show datapath bridge table
```

Datapath Bridge Table Entries

Flags: P - Permanent, D - Deny, M - Mobile, L - Local

MAC	VLAN	Assigned VLAN	Destination	Flags	Aging-time
04:8B:42:12:00:81	5	5	Local	PL	
04:8B:42:12:0A:81	85	85	Local	PL	
04:8B:42:12:0A:A1	86	86	Local	PL	
04:8B:42:12:0A:C1	87	87	Local	PL	
04:8B:42:12:0A:E1	88	88	Local	PL	

5.1.4 Bridge Aging

The bridge aging time is 15 minutes by default. If no traffic in 15 minutes, bridge table will be aging.

5.1.5 Static Table

Static bridge table will not be aging.

To configure static table, use following command in config mode:

```
mac-address-table static <mac address> [discard/forward] gigabitethernet <slot/port> Vlan <vlan-id>
```

For example:

```
(JadeOS)(config)#mac-address-table static 04:8b:42:22:05:6f discard gigabitethernet 1/0 vlan 2
```

Note: To delete bridge table, use following command in config mode:

```
no mac-address-table static <mac address> <discard/forward> <gigabitethernet> <vlan>
```

5.2 Port Mirror

Mirror mode enables you to duplicate to another port all of the traffic originating from or terminating at a single client device or access point. It is useful in diagnosing specific network problems. Mirror mode should be enabled only on an unused port as any connections to this port become unresponsive.

You can configure port mirroring using the following commands:

```
(config)#interface {tengigabitethernet|gigabitethernet} <slot>/<port>  
(config-if)#mirror interface vlan <VLAN ID> direction {both | receive | transmit}
```

Chapter 6 Layer-3 Network Service

JadeOS provides layer-3 network service. This chapter will describe how to configure IP address, static routing, GRE tunnel, DHCP, OSPF, and IPv6 and so on.

6.1 Configuring IP Address

6.1.1 Configuring IP Address

Use the following commands to assign a static IP address to a port on JadeOS:

```
interface gigabitethernet <slot>/<port>
no switchport
ip address <address><netmask>
```

6.1.2 Configuring Loopback

The loopback IP address is a logical IP interface that is used by JadeOS to communicate with APs. The loopback address is used as JadeOS's IP address for terminating VPN and GRE tunnels, originating requests to RADIUS servers and accepting administrative communications. You configure the loopback address as a host address with a 32-bit netmask. The loopback address is not bound to any specific interface and is operational at all times. To use this interface, ensure that the IP address is reachable through one of the VLAN interfaces. It should be routable from all external networks.

To configure the loopback IP address, use the following commands:

```
interface loopback <id>
ip address <address><mask>
```

6.2 Configuring Static Routing Table

6.2.2 Configuring Static Routing

To configure static routing, use following command:

```
ip route <subnet>/<prefix-length> <gateway>
```

For example:

```
(JadeOS) (config)#ip route 10.0.0.0/24 192.168.10.1
```

6.2.2 Inquiring Routing Table

To inquiry system routing table, including direct routing and static configuring routing, use **show ip route** command.

```
(JadeOS) #show ip route
```

```
Codes: K - kernel, C - connected, S - static, R - RIP, B - BGP
```

```
O - OSPF, IA - OSPF inter area
```

```
N1 - OSPF NSSA external type 1, N2 - OSPF NSSA external type 2
```

```
E1 - OSPF external type 1, E2 - OSPF external type 2
```

```
i - IS-IS, L1 - IS-IS level-1, L2 - IS-IS level-2, ia - IS-IS inter area
```

```
* - candidate default
```

```
S      10.2.20.0/24 [1/0] via 192.168.20.1, mgmt 1
S      18.0.0.0/8 [1/0] via 192.168.20.1, mgmt 1
C      80.1.0.0/16 is directly connected, vlan 80
C      119.6.100.0/24 is directly connected, Gi 12/0
S      119.6.200.0/24 [1/0] via 119.6.100.1, Gi 12/0
C      172.50.3.0/24 is directly connected, Gi 12/2
S      192.168.0.0/16 [1/0] via 192.168.20.1, mgmt 1
C      192.168.20.0/24 is directly connected, mgmt 1
```

6.3 Configuring ARP

JadeOS supports configuring static ARP table.

Address Resolution Protocol (ARP) is a TCP/IP protocol used for resolution of network layer IP address into link layer MAC address, a critical function in multiple-access networks. ARP was defined by RFC 826 in 1982.

Besides the basic ARP function, JadeOS also support local proxy ARP and DHCP authorized ARP. It is effectively avoided ARP cheat and attack by DHCP Snooping, which enhances the security of public wireless LANs communication.

6.3.1 Configuring Static ARP Table

Dynamic ARP learning is enabling in JadeOS port by default.

To add static ARP table, use following command:

```
arp <ipaddr> <macaddr>
```

To delete ARP cache entry, use **no arp** command:

```
no arp <ipaddr> <macaddr>
```

For example:

```
(JadeOS) (config) #arp 10.1.2.23 00:19:87:0D:5C:2C
```

6.3.2 Inquiring ARP Table

To view ARP table, use **show arp** command:

```
(JadeOS) #show arp
```

Address	HWaddress	Interface	Type
192.168.20.1	00:13:1A:A5:CC:80	mgmt 1	Dynamic
192.168.20.15	00:15:C5:F3:35:B2	mgmt 1	Dynamic
192.168.20.152	00:14:22:19:FC:C4	mgmt 1	Dynamic
119.6.100.1	C4:64:13:D1:9A:EA	Gi 12/0	Dynamic
192.168.20.226	04:8B:42:10:6C:1C	mgmt 1	Dynamic
172.50.3.2	04:8B:42:20:00:F5	Gi 12/2	Dynamic

6.3.2 Configuring ARP Proxy

Proxy ARP includes local proxy ARP and proxy ARP. They both reply ARP request with interface MAC address, no matter the request address is in existence or not. But they have differences too. Proxy ARP will reply ARP request no matter the request address is in the same network segment with interface or not. Local proxy ARP will reply when ARP request's original address, destination address and interface address are in the same network segment.

In case of the TUNNEL broadcast message suppression and DHCP snooping is open, client need to communicate with another client that in the same network segment but different tunnel, so we need to continuously broadcast ARP message to look up another client. In the above situation, we can open the local proxy ARP function in JadeOS. In this way, JadeOS will act as ARP proxy to ensure the client's data communication in different tunnel, and the same time, avoid a lot of useless broadcast message caused by repeat broadcast.

6.4 Configuring MTU and TCP MSS

Mtu and tcp mss is the attribute of interface.

When the data packet is larger than mtu value, system will fragment data packet according to mtu value. Fragmentation will affect data performance, so you should try to avoid fragmentation.

If the interface is the attribute of tcp mss and the tcp mss option of syn message is larger than the tcp mss value of interface, system will modify the tcp mss option of this syn message and update tcp checksum when tcp syn message goes through inside interface and outside interface. You should try to avoid fragmentation for fragmentation will affect data performance

To configure mtu, use **mtu <68-9216>** command in config mode:

To configure tcp mss, use **tcp4mss <4-65535>** command in interface mode:

For example, configure the mtu and tcp4mss of interface gigaehternet 1/0 is 1460 and

1440 respectively:

```
(JadeOS) (config)#interface gigabitethernet 10/1
(JadeOS) (config-if)#mtu 1460
(JadeOS) (config-if)#tcp4mss 1440
```

6.5 Configuring GRE Tunnel

GRE (Generic Routing Encapsulation) specifies a protocol for encapsulation of an arbitrary protocol over another arbitrary network layer protocol.

GRE defined in RFC 2784 and updated by RFC 2890.

To create a GRE tunnel interface and enter interface configuration mode on JadeOS, use the following command:

```
interface tunnel <id>
tunnel mode gre
```



Figure 6-3 GRE tunnel

To create a GRE tunnel on JadeOS, use the following steps:

```
(JadeOS)(config) #interface tunnel 1
(JadeOS)(config-if) #tunnel mode gre
(JadeOS)(config-if) #ip address x.x.x.x/x
(JadeOS)(config-if) #tunnel source x.x.x.x
(JadeOS)(config-if) #tunnel destination x.x.x.x
(JadeOS)(config-if) #tunnel key <0-4294967295>
(JadeOS)(config-if) #tunnel checksum
```

6.6 Configuring DHCP

The Dynamic Host Configuration Protocol (DHCP) is a network configuration protocol for hosts on Internet Protocol (IP) networks. UDP protocol mainly has two usages:

- Reduce client's configuration burden, used in the change of office.
- Reduce network administrator's configuration burden. UDP achieves address unified distribution, centralized management and DHCP Snooping rational using, which is good for avoiding network attack and ensuring resource rationally in use.

Because of the terminal mobility, wireless network architecture has a high standard on

DHCP protocol. It still has high standard on the scale of address pool and address distribution rate in SP environment.

6.6.1 Configuring DHCP Server

To configure DHCP server, use following command:

Step 1 Create one or more DHCP address pool:

```
ip dhcp pool <pool-name>
```

Step 2 Specify the gateway of DHCP client

```
default-router A.B.C.D
```

Step 3 Specify the DNS server of DHCP client

```
dns-server A.B.C.D
```

Step 4 Specify the lease time

```
Lease <days> <hours> <minites> <seconds>
```

Step 5 Specify the range of address pool

```
network <subnet> <mask>
```

Step 6 (optional) DHCP issue ARP table that combined with IP and MAC address of client to the system.

```
update arp
```

Step 7 (optional) Specify the reserved IP address or IP range, which is the IP address not assigned to the client.

```
ip dhcp excluded-address <start-address> [<end-address>]
```

Step 8 Enable DHCP service

```
service dhcp
```

6.6.2 Inquiring DHCP Server Status

1 Inquire DHCP Configuration

```
(JadeOS) #show ip dhcp database
```

```
DHCP enabled
```

```
ping-check false;
```

```
broadcast;
```

```
# vlan409
```

```
subnet 172.40.9.0 netmask 255.255.255.0 {
```

```
    lease-time 1 days,0 hours, 0 minutes, 0 seconds;
```

```
    option routers 172.40.9.1;
```

```
    range 172.40.9.2 172.40.9.254;
```

```
}
```

2 Inquire DHCP lease statistics

```
(JadeOS) #show ip dhcp statistics
```

Network Name	13.0.0.0/16
Total leases	65533
Free leases	64532
Active leases	1001
Abandoned leases	0
Reserved leases	0

3 Inquire DHCP lease information

(JadeOS) #show ip dhcp binding

```
lease 13.0.6.202 {
  starts Mon Dec 23 10:41:30 2013
  ends Mon Dec 23 10:42:30 2013
  binding state active;
  next binding state free;
  hardware ethernet 00:50:ba:50:73:2b;
  uid "\001\000P\272Ps+";
}
lease 13.0.6.238 {
  starts Mon Dec 23 10:41:33 2013
  ends Mon Dec 23 10:42:33 2013
  binding state active;
  next binding state free;
  hardware ethernet 00:50:ba:50:75:2b;
  uid "\001\000P\272Pu+";
}
lease 13.0.7.19 {
  starts Mon Dec 23 10:41:28 2013
  ends Mon Dec 23 10:42:28 2013
  binding state active;
  next binding state free;
  hardware ethernet 00:50:ba:50:74:e9;
  uid "\001\000P\272Pt\351";
}
lease 13.0.7.61 {
  starts Mon Dec 23 10:41:33 2013
  ends Mon Dec 23 10:42:33 2013
  binding state active;
  next binding state free;
  hardware ethernet 00:50:ba:50:76:5c;
  uid "\001\000P\272Pv\\";
}
```

4 Inquire DHCP Server running status

(JadeOS) #show ip dhcp server statistics

Dhcp Server Packet Statistics:

Receive packet:

Discover	0
Request	0
Release	0
Decline	0
Inform	0
Leasequery	0
Unkown	0

Send packet:

Offer	0
Ack	0
Nak	0

Other packet:

Bootp	0
Boopreply	0

Speed:

Offer Speed	0 client/sec
-------------	--------------

6.6.3 Configuring DHCP Relay

JadeOS provides DHCP Relay function that enhances the DHCP function. A DHCP relay agent is any host that forwards DHCP packets between clients and servers. Relay agents are used to forward requests and replies between clients and servers when they are not on the same physical subnet. Relay agent forwarding is distinct from the normal forwarding of an IP router, where IP datagram are switched between networks somewhat transparently. By contrast, relay agents receive DHCP messages and then generate a new DHCP message to send on another interface.

DHCP Relay configuration as below:

Step 1 Enter “ip dhcp relay”

```
(JadeOS)(config)# ip dhcp relay
```

Step 2 Specify the interface of DHCP Client

```
(JadeOS)(config-dhcp-relay)# client-interface <interface-name>
```

Step 3 Specify the IP address of DHCP Server

```
(JadeOS)(config-dhcp-relay)# server address A.B.C.D
```

Step 4 Specify the interface of DHCP Server

```
(JadeOS)(config-dhcp-relay)# server-interface <interface-name>
```

Step 5 Enable Relay

```
(JadeOS)(config-dhcp-relay)# enable
```

6.6.4 DHCP Snooping

DHCP Snooping acts as the firewall between untrust host and DHCP server, which avoid interfere and attack to the legal user. Through DHCP snooping, you can view the filtered illegal DHCP message.

Because DHCP message carries MAC address and IP address of user terminal, you can obtain and record DHCP message through continuously track, which can be used to indentify other illegal DHCP message.

Through building and maintaining DHCP snooping table (IP-MAC binding), system can detect whether the followed communication is legal, and then reject the unmatched data between IP and MAC.

To enable DHCP snooping, use the following command:

```
ip dhcp snooping enable
```

To display DHCP snooping binding table, use the following command:

```
(JadeOS) #show ip dhcp snooping binding counter
```

```
Datapath Bind Table Statistics
```

```
-----
```

```
Current Entries 1001
```

```
High Water Mark 1001
```

```
Maximum Entries 262144
```

```
Total Entries 4001
```

```
Allocation Failures 0
```

```
(JadeOS) #show ip dhcp snooping binding
```

```
DHCP Snooping State is disable
```

```
DHCP Snooping verify MAC State is disable
```

```
Datapath Binding Table Entries
```

```
-----
```

```
Type: D - Dynamic, S - Statically-configured
```

```
MacAddress      IpAddress      Lease(sec)    Type          Interface
```

```
-----
```

00:50:ba:50:77:06	13.0.7.20	300	D	Gi 6/10
00:50:ba:50:76:DA	13.0.6.242	300	D	Gi 6/10
00:50:ba:50:76:D8	13.0.6.237	300	D	Gi 6/10
00:50:ba:50:76:D4	13.0.6.227	300	D	Gi 6/10

Security Check

Through binding table, DHCP snooping module determine whether the DHCP message sent by user is legal or not, and then reject illegal DHCP request if illegal.

Enabling MAC address detection, DHCP snooping can avoid attack by checking whether the MAC address of DHCP protocol match with the source MAC address of Ethernet.

To enable MAC address detection of DHCP snooping, use the following command in config mode:

```
ip dhcp snooping verify mac-address enable
```

Broadcast Suppression

JadeOS can automatically record DHCP request information into DHCP snooping session table by enabling DHCP snooping. When received broadcast message from DHCP server, JadeOS can look up the corresponding host and exit port in the DHCP snooping table, then change the broadcast into unicast. Therefore, JadeOS achieves broadcast suppression.

To configure the broadcast suppression in QinQ interface, use the following command:

```
ip dhcp snooping enable
```

To display the DHCP snooping session table, use the following command:

```
show ip dhcp snooping session
```

6.6.5 ARP With DHCP

Enabling ARP with DHCP, DHCP will issue ARP table that combined distributed IP address and MAC address in client to the system, at the same time, disable the function of ARP learning in the specified interface. Therefore, ARP table is strictly checked by DHCP snooping, which ensures the legality and avoid the ARP cheat and interfere to the user online and communication.

For example:

➤ Enable ARP with DHCP function:

Step 1 Configure update arp in address pool

```
(JadeOS) (config)#ip dhcp pool ABC
```

```
(JadeOS) (config-dhcp)#update arp
```

Step 2 Configure ARP authorized in the interface of distributed IP, disable ARP learning function:

```
(JadeOS) (config)#interface vlan 6
```

```
(JadeOS) (config-if)#arp authorized
```

Note: ARP learning will be disabled after enabling ARP with DHCP.

➤ **Disable ARP with DHCP function:**

Step 1 To save client ARP information, use **no update arp** command to disable ARP function:

```
(JadeOS) (config)#ip dhcp pool ABC
```

```
(JadeOS) (config-dhcp)#no update arp
```

Step 2 Enable ARP learning function

```
(JadeOS) (config)#interface vlan 6
```

```
(JadeOS) (config-if)#no arp authorized
```

You can inquiry client ARP information by **show arp** command.

6.7 Configuring OSPF

Open Shortest Path First (OSPF) is an adaptive routing protocol for Internet Protocol (IP) networks. It uses a link state routing algorithm and falls into the group of interior routing protocols, operating within a single autonomous system (AS). This allows the JadeOS to deploy effectively in a Layer 3 topology. The JadeOS can act as default gateway for all clients and forward user packets to the upstream router.

6.7.1 OSPF Implementation

JadeOS OSPF implementation conforms to the OSPF Version 2 specifications detailed in the Internet RFC 2328. The list that follows outlines key OSPF features supported on JadeOS:

- NSSA areas (RFC3101) supported.
- Route redistribution—Routes learned via any IP protocol can be redistributed in to any other IP routing protocol.
- Authentication—Plain text authentication among neighboring routers within an area is supported.
- Routing interface parameters—Configurable parameters supported include interface output cost, retransmission interval, interface transmit delay, router priority, router “dead” and “hello” intervals, and message digest key.

6.7.2 Enabling OSPF

OSPF is disabled by default. To enable the OSPF function on JadeOS, use the following command in the configuration mode:

```
(JadeOS)(config)# router ospf
```

Enabling OSPF requires that you create an OSPF router ID which is the only identifier in an AS system and area ID which specify the range of routing process.

If the router ID is not configured, the loopback interface IP will be taken as router ID. If there is no loopback interface, system will select a maximum IP address from all of interface IPs.

To configure a router ID, complete the following command:

```
(JadeOS) (config)#router ospf
(JadeOS) (config-router)#ospf router-id <IP>
```

To configure a area ID, use the following command:

```
(JadeOS) (config)# router ospf
(JadeOS) (config-router)# area <area id> <parameter>
```

Note: Please refer to *JadeOS Command Manual* for more area configuration parameter.

6.7.3 Configuring OSPF Interface Parameters

JadeOS allows you to alter certain interface-specific OSPF parameters as needed. You are not required to alter any of these parameters, but some interface parameters must be consistent across all routers in an attached network. Therefore, be sure that if you do configure any of these parameters, the configurations for all routers on your network have compatible values.

To specify interface parameters as needed for your network, use the any of the commands listed in table 6-1:

Command	Purpose
ip ospf cost <value>	Explicitly specify the cost of sending a packet on an OSPF interface.
ip ospf dead-interval<value>	Set the number of seconds that a device's hello packets must not have been seen before its neighbors declare the OSPF router down.
ip ospf hello-interval<value>	Specify the length of time between the hello packets that the Cisco IOS software sends on an OSPF interface.
ip ospf message-digest-key <value> <passwd>	Enable OSPF MD5 authentication.
ip ospf priority <value>	Set priority to help determine the OSPF designated router for a network.
ip ospf retransmit-interval <value>	Specify the number of seconds between link state advertisement retransmissions for adjacencies belonging to an OSPF interface.
ip ospf transmit-delay<value>	Set the estimated number of seconds it takes to

	transmit a link state update packet on an OSPF interface.
--	---

Table 6-1 OSPF Interface Parameter

6.7.4 Configuring OSPF Area

JadeOS OSPF supports the following types of area:

- Stub area

Stub areas are areas in to which information on external routes is not sent. Instead, there is a default external route generated by the area border router, into the stub area for destinations outside the autonomous system. To take advantage of the OSPF stub area support, default routing must be in the stub area, you can configure **no-summary** on the ABR to prevent it from sending summary link advertisement into the stub area.

To configure a stub area on JadeOS, use the following command:

```
area <area-id> stub [no-summary]
```

For example, configure area 1.1.1.1 as stub area on JadeOS:

```
(JadeOS) (config) #router ospf
```

```
(JadeOS) (config-router) # area 2 stub no-summary
```

- NSSA(Not So Stubby Area) area

NSSA area is similar to OSPF stub area. NSSA does not flood Type 5 (External Link State Advertisements)LSA form the core into the area, but it has the ability of importing AS external routes in a limited fashion within the area. NSSA allows importing of Type 7 AS external routes within NSSA area by redistribution. These Type 7 LSAs are translated into Type 5 LSAs by NSSA ABR which are flooded throughout the whole routing domain.

To configure a NSSA area on JadeOS, use the following command:

```
area <area-id> nssa [ no-redistribution ] [no-summary ] [default-information-originate]
```

Example 1, configure area 1.1.1.1 as totally NSSA area on JadeOS:

```
(JadeOS)(config)# router ospf
```

```
(JadeOS) (config-router) # area 1 nssa no-summary
```

Example 2, configure area 1.1.1.1 as non-totally NSSA area, not importing type-7 external routes to the area:

```
(JadeOS)(config)# router ospf area 1.1.1.1
```

```
(JadeOS)(config-router) # nssa no-redistribution
```

Example 3, configure area 1.1.1.1 as non-totally NSSA area, importing a default route to the area:

```
(JadeOS)(config)# router ospf
```

```
(JadeOS)(config-router) # area 1 nssa default-information-originate
```

6.7.5 Configuring OSPF Network Type

JadeOS supports the following types of OSPF network:

- Point-to-point networks(HDLC, Token Ring, FDDI)

One point-to-point links such as HDLC and PPP, OSPF runs as a point-to-point network type.

To configure an OSPF point-to-point network on JadeOS, use the following command:

```
(JadeOS)(config-if)#ip ospf network point-to-point
```

- Broadcast networks (Ethernet, Token Ring, FDDI)

On the broadcast medium such as Ethernet and Token Ring, OSPF runs as a broadcast network type.

To configure an OSPF broadcast network on JadeOS, use the following command:

```
(JadeOS)(config-if)#ip ospf network broadcast
```

Note: The network type is broadcast by default in factory.

6.7.6 OSPF Point-to-point Configuration Example

In the following OSPF network, the autonomous system is divided into 3 areas. JadeOS A and JadeOS B is the ABR which is responsible to announce the routes between OSPF areas.

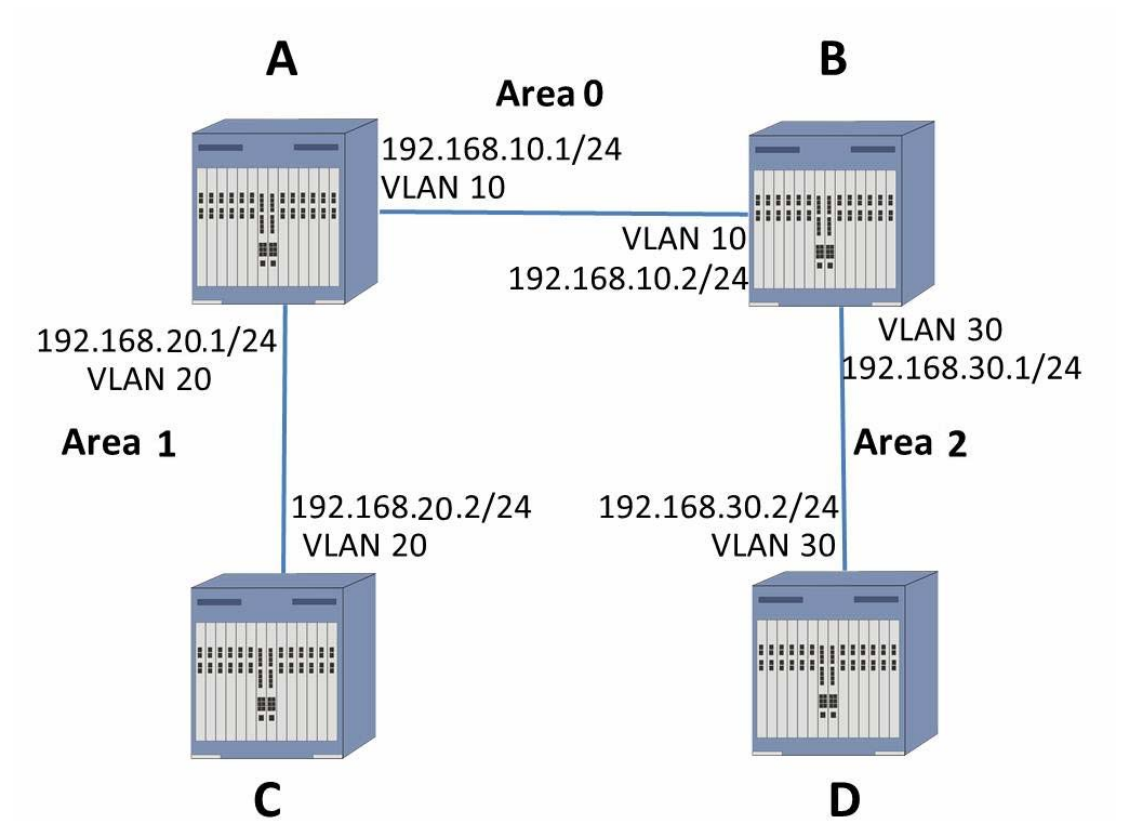

Figure 6-1 OSPF configuration example

Step 1 Create VLAN and add interfaces to VLAN (Refer to chapter 4 for VLAN configuration)

Step 2 Configure OSPF on JadeOS A

```
(JadeOS-A) (config) #router ospf
(JadeOS-A) (config-router) #ospf router-id 1.1.1.1
(JadeOS-A) (config-router) #network 192.168.10.0/24 area 0
(JadeOS-A) (config-router) #network 192.168.20.0/24 area 1
(JadeOS-A) (config) #interface vlan 10
(JadeOS-A) (config-if) #ip address 192.168.10.1/24
(JadeOS-A) (config-if) #ip ospf network point-to-point
(JadeOS-A) (config) #interface vlan 20
(JadeOS-A) (config-if) #ip address 192.168.20.1/24
(JadeOS-A) (config-if) #ip ospf network point-to-point
```

Step 3 Configure OSPF on JadeOS B

```
(JadeOS-B) (config) #router ospf
(JadeOS-B) (config-router) #ospf router-id 1.1.1.2
(JadeOS-B) (config-router) #network 192.168.10.0/24 area 0
(JadeOS-B) (config-router) #network 192.168.30.0/24 area 2
(JadeOS-B) (config) #interface vlan 10
```

```
(JadeOS-B) (config-if) #ip address 192.168.10.2/24
(JadeOS-A) (config-if) #ip ospf network point-to-point
(JadeOS-B) (config) #interface vlan 30
(JadeOS-B) (config-if) #ip address 192.168.30.1/24
(JadeOS-A) (config-if) #ip ospf network point-to-point
```

Step 4 Configure OSPF on JadeOS C

```
(JadeOS-C) (config) #router ospf
(JadeOS-C) (config-router) #ospf router-id 1.1.1.3
(JadeOS-C) (config-router) #network 192.168.20.0/24 area 1
(JadeOS-C) (config) #interface vlan 20
(JadeOS-A) (config-if) #ip ospf network point-to-point
(JadeOS-C) (config-subif) #ip address 192.168.20.2/24
```

Step 5 Configure OSPF on JadeOS D

```
(JadeOS-D) (config) #router ospf
(JadeOS-D) (config-router) #ospf router-id 1.1.1.4
(JadeOS-D) (config-router) #network 192.168.30.0/24 area 2
(JadeOS-D) (config) #interface vlan 30
(JadeOS-D) (config-subif) #ip ospf network point-to-point
(JadeOS-D) (config-subif) #ip address 192.168.30.2/24
```

Note: Routing management supports OSPF dynamic routing management and static routing management.

To add static routing, use **ip route A.B.C.D/<destmask>** command.

To delete routing, use **no ip route A.B.C.D/<destmask>** command.

To display routing, use **show ip route** command.

6.8 Configuring IPv6

JadeOS supports IPv4/IPv6 configuration and IPv6 forwarding. IPv6 address and routing configuration is similar to IPv4.

6.8.1 Address Configuration

To configure IPv6 address, use following command in interface mode:

```
(JadeOS) (config)#interface vlan 333
(JadeOS) (config-if)#ipv6 address 2011::6:31/64
```

6.8.2 Routing Configuration

To configure IPv6 routing, use following command:

```
ipv6 route <subnet>/<prefix-length> <gateway>
```

6.8.3 Ping6

To configure ping6, use following command:

```
ping6 <ipv6-address>
```

Chapter 7 Network Security

JadeOS is always deployed in gateway, which much data goes through it. The network environment of equipment is very complex and faces network security threat. This chapter will describe JadeOS network security and how to configure it.

7.1 Access Control List (ACL)

Access Control List (ACL) defines the network access. ACL is the combination of rules; each rule can specify one matched rule and one operation. Matched rule is based on IP address or port number; operation is 'permit' or 'deny'. The ACL is to match rules in sequence.

JadeOS have an implicit rule of 'deny' for each ACL, so you should add the corresponding rule and specify the operation is 'permit' if you want to allow one type of traffic go through it. Through ACL, we can control users' traffic exactly so that to ensure network security.

7.1.1 Standard ACL

Standard ACL rule can specify the operation is 'deny' or 'permit'; the matched rule is any, ip address and network segment.

Step 1 Create a standard ACL named test-standard

```
(JadeOS) (config)#ip access-list standard test-standard
```

Step 2 Deny all the traffic in network segment 192.168.1.0/255.255.255.0

```
(JadeOS) (config-std-test-standard)#deny 192.168.1.0 255.255.255.0
```

Step 3 Allow all the traffic in network segment 192.168.0.0/255.255.0.0

```
(JadeOS) (config-std-test-standard)#permit 192.168.0.0 255.255.0.0
```

Step 4 Deny all the other traffic.

```
(JadeOS) (config-std-test-standard)#deny any
```

7.1.2 Extended ACL

Extended ACL can specify the operation is 'deny' or 'permit'; the matched rule can specify the protocol number(any, tcp, udp, icmp, igmp), source IP address or network segment, destination IP address or network segment, range of port number.

Step 1 Create extended ACL named test-extended

```
(JadeOS) (config)#ip access-list standard test-extended
```

Step 2 Deny tcp traffic from 60.0.0.0/255.255.255.0 to 192.168.10.0/255.255.255.0 with port range 1-1023.

```
(JadeOS) (config-std-test-extended)# deny tcp 60.0.0.0 255.255.255.0 192.168.10.0
255.255.255.0 range 1 1023
```

Step 3 Permit all the tcp port 80 traffic to 192.168.10.0/255.255.255.0.

```
(JadeOS) (config-std-test-extended)# permit tcp any 192.168.10.0 255.255.255.0 eq
```

7.1.3 Session ACL

Session ACL can specify the operation is ‘deny’ or ‘drop’; the matched rule are protocol number, source IP address or network segment, destination IP address or network segment and range of port number. Based on five elements (protocol, source IP address, source port number, destination IP address), session ACL can track all the data of this session to achieve the complex function, such as SNAT, DNAT.

Session ACL is used to control user authentication. Please refer to Chapter 9 for more information.

Step 1 Create a session ACL named test-session

```
(JadeOS) (config)#ip access-list standard test-session
```

Step 2 All the traffic from 192.168.20.0/255.255.255.0 will be translated by SNAT function. NAT-POOL is used by NAT pool. (Please refer to chapter 7.3 for how to create NAT pool)

```
(JadeOS) (config-std-test-extended)# network 192.168.20.0 255.255.255.0 any any src-nat pool
NAT_POOL
```

Step 3: All the traffic from 192.168.30.0/255.255.255.0 will be translated to address 10.10.10.134 by DNAT function.

```
(JadeOS) (config-std-test-extended)# network 192.168.30.0 255.255.255.0 any any dst-nat ip
10.10.10.134
```

7.2 Session

JadeOS will maintain a session table for each session. The session table is based on five elements (protocol, source IP address, source port number, destination IP address). When the system receives the first data packet of the session, it will create a session table for the session. Based on this session, the following data packet will be uniformly handled by JadeOS, for example, SNAT will be transferred to the same address by NAT function. When the session is terminated (for example, monitor tcp fin message) or timeout (no traffic for a long time), session table will be deleted.

To inquire the number of present session, use **show datapath session counters** command.

```
(JadeOS) #show datapath session counters
```

```
Datapath Session Table Statistics
```

```
-----
```

```
Current Entries: 2
High Water Mark: 10
Maximum Entries: 524287
Total Entries: 185
Duplicate Entries: 0
Cross linked Entries: 0
Max link Length: 1
```

To view present session table, use **show datapath session table** command:

```
(JadeOS) #show datapath session table
```

```
Datapath Session Table Entries
```

```
-----
```

```
Flags: F - fast age, S - src NAT, N - dest NAT
       D - deny, R - redirect, Y - no syn
       H - high prio, P - set prio, T - set ToS
       C - client, M - mirror, V - VOIP
       Q - Real-Time Quality analysis
       I - Deep inspect, U - Locally destined
       E - Media Deep Inspect, G - media signal
```

Source IP	Destination IP	Prot	SPort	DPort	Cntr	Prio	ToS	Age	Destination	TAge
172.50.3.2	172.50.3.1	17	49419	5246	0/0	0	0	0	0	0
FC										
172.50.3.1	172.50.3.2	17	5246	49419	0/0	0	0	1	0	0
F										

7.3 Configuring NAT

Network Address Translation (NAT) is designed for IP address conservation. It enables private IP networks that use unregistered IP addresses to connect to the Internet. NAT operates on a router, usually connecting two networks together, and translates the private (not globally unique) addresses in the internal network into legal addresses,

before packets are forwarded to another network.

As part of this capability, NAT can be configured to advertise only one address for the entire network to the outside world. This provides additional security by effectively hiding the entire internal network behind that address. NAT offers the dual functions of security and address conservation and is typically implemented in remote-access environments.

Basically, NAT allows a single device, such as a router, to act as an agent between the Internet (or public network) and a local network (or private network), which means that only a single unique IP address is required to represent an entire group of computers to anything outside their network.

7.3.1 Configuring SNAT

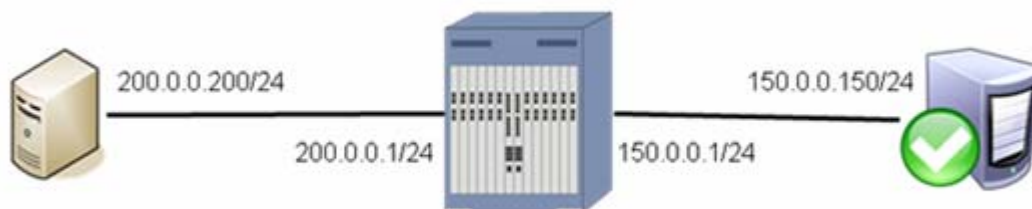

Figure 7-1 source address transfer

To create NAT pool, use the following command in config mode:

```
ip nat pool <pool-name> <start-ip> <end-ip> <dest-ip>
```

To create SNAT rule in session ACL, use the following command:

```
network <subnet> <mask> any any src-nat pool <pool-name>
```

Using figure 7-1 as an example, step 1 and step 2 show how to specify the user policy in VLAN 100. Let the traffic from users on 200.0.0.0/24 subnet be SNATed when they access public internet server 155.0.0.150.

Step 1 Create NAT address pool

```
(JadeOS)(config)# ip nat pool nat_pool 150.0.0.1 150.0.0.1 160.0.0.1
```

Step 2 Configure session ACL, add a SNAT rules specifying what traffic is to be translated and NAT pool

```
(JadeOS)(config)#ip access-list session tacl
```

```
(JadeOS)(config-sess-tacl)# network 200.0.0.0 255.255.255.0 any any src-nat pool nat_pool
```

Step 3 and Step 4 show how to apply ACL to VLAN 100, please refer to chapter 9.4 for more information.

Step 3 Configure user role and apply ACL

```
(JadeOS)(config)#user-role trole  
(JadeOS)(config-trole)#access-list session tacl
```

Step 4 Configure AAA Profile, and specify user role

```
(JadeOS)(config)#aaa profile test  
(JadeOS)(AAA profile "test")#initial-role trole
```

Step 5 Apply AAA profile to VLAN 100

```
(JadeOS)(config)#vlan 100 aaa profile test
```

7.3.2 Configuring DNAT

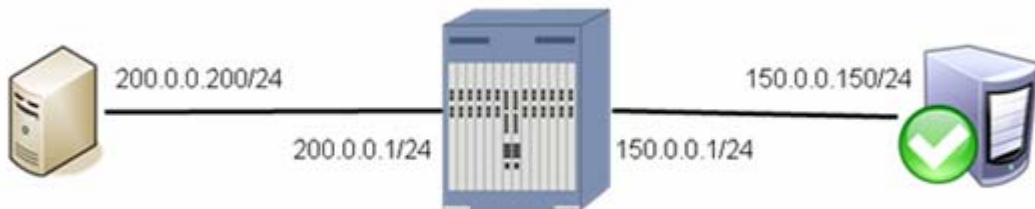

Figure 7-2 Destination address transfer

To configure DNAT address transfer in session ACL, use following command:

```
<src-subnet> <dest-subnet> <protocol> dst-nat ip <ip-address>
```

Using figure 7-2 as an example, JadeOS achieves to make user that failed authentication redirect to portal server (150.0.0.150) by DNAT function. Please refer to chapter 9.4 for more information.

Step 1 To create session ACL and specify DNAT IP address and DNAT destination IP address, use the following command:

```
(JadeOS) (config) #ip access-list session tacl  
(JadeOS) (config-sess-tacl) # any host 150.0.0.1 any dst-nat ip 200.0.0.200
```

Step 2 To create user role and apply it to ACL, use the following command:

```
(JadeOS) (config) #user-role trole  
(JadeOS) (config-trole) #access-list session tacl
```

Step 3 To create AAA profile and apply it to user role and authentication group, use the following command:

```
(JadeOS) (config) #aaa profile test  
(JadeOS) (AAA profile "test") #http-redirection enable  
(JadeOS) (AAA profile "test") #initial-role trole
```

Step 4 Apply AAA profile to VLAN 100
(JadeOS) (config) #vlan 100 aaa profile test

7.4 Configuring DoS Anti-attack

The main function of DoS anti-attack is to protect the operation system of control plane, which can make JadeOS work normally in malicious attack.

DoS anti-attack will classify based on protocol first, and then limit the rate of each protocol according to the configuration. JadeOS configure different rate limit policy for each protocol; rate limit policy is based on traffic per second or the number of data packet.

7.4.1 System Pre-defined Configuration

Pre-defined configuration is the best deployment configuration of JadeOS, which is based on the hardware performance and design specification of the product. To view system predefined configuration, use **show firewall** command.

(JadeOS) #show firewall

Firewall bandwidth-contract:

Firewall Rate limit	Enable/Disable	Rate
Rate limit CP Capwap traffic	Disable	2MBps0KBps
Rate limit CP Dhep traffic	Disable	8MBps0KBps
Rate limit CP Hostapd traffic	Disable	20MBps0KBps
Rate limit CP Ospf traffic	Disable	2MBps0KBps
Rate limit CP trusted-mcast packet traffic	Disable	20MBps0KBps
Rate limit CP trusted-ucast packet traffic	Disable	40MBps0KBps
Rate limit CP untrusted-mcast packet traffic	Disable	10MBps0KBps
Rate limit CP untrusted-ucast packet traffic	Disable	10MBps0KBps
Rate limit CP VRRP packet traffic	Disable	2MBps0KBps
Rate limit SP session miss packet traffic	Disable	50000pps
Rate limit SP user miss packet traffic	Disable	1000pps
Rate limit SP other exception packet traffic	Disable	2MBps0KBps

7.4.2 Configuring Anti-attack

JadeOS supports anti-attack configuration, which is convenient for configuration adjustment in various network scenarios.

Two configuration commands in config mode:

```
firewall cp-bandwidth-contract <service type> <pps number | traffic limit>  
firewall sp-bandwidth-contract <service type> <pps number | traffic limit>
```

For example:

To configure the rate limit of session creation is 50000 per second:

```
(JadeOS) (config)#firewall sp-bandwidth-contract session pps 50000
```

To configure the rate limit of new online user is 700 per second:

```
(JadeOS) (config)#firewall sp-bandwidth-contract user pps 700
```

To configure the rate of receiving DHCP message is 2000 per second:

```
(JadeOS) (config)#firewall cp-bandwidth-contract dhcp pps 2000
```

To configure the rate of receiving ARP message is 2000 per second:

```
(JadeOS) (config)#firewall cp-bandwidth-contract arp pps 2000
```

To configure the rate of receiving unicast message that failed authentication is 10Mbps:

```
(JadeOS) (config)#firewall cp-bandwidth-contract untrusted-ucast 10 0
```

7.5 Configuring Lawful Intercept

Lawful intercept is a process that enables a Law Enforcement Agency (LEA) to perform electronic surveillance on an individual (a target) as authorized by a judicial or administrative order. To facilitate the lawful intercept process, certain legislation and regulations require service providers (SPs) and Internet service providers (ISPs) to implement their networks to explicitly support authorized electronic surveillance.

The surveillance is performed through the use of wiretaps on traditional telecommunications and Internet services in voice, data, and multiservice networks. The LEA delivers a request for a wiretap to the target's service provider, who is responsible for intercepting data communication to and from the individual. The service provider uses the target's IP address or session to determine which of its edge routers handles the target's traffic (data communication). The service provider then intercepts the target's traffic as it passes through the router, and sends a copy of the intercepted traffic to the LEA without the target's knowledge.

Configuration Steps:

Step 1 To create LIG (LI gateway), and specify the encapsulation way of traffic sent to LIG, use the following command in LI mode:

```
lig add <li-gateway-name> [mirror|udp][interface|id]
```

Step 2 To add LI rule, and specify LI name (based on ACL, IP, MAC, network segment) and LIG which receives the LI traffic, use the following command:

```
rule [acl-filter | host-filter | mac-filter | net-filter] send <lig-name>
```

```
acl-filter    add lawful intercept rule, intercept data streams
```

```
host-filter   add lawful intercept rule, intercept host data streams
```

```
mac-filter    add lawful intercept rule, intercept ethernet data streams
```

```
net-filter    add lawful intercept rule, intercept host data streams
```

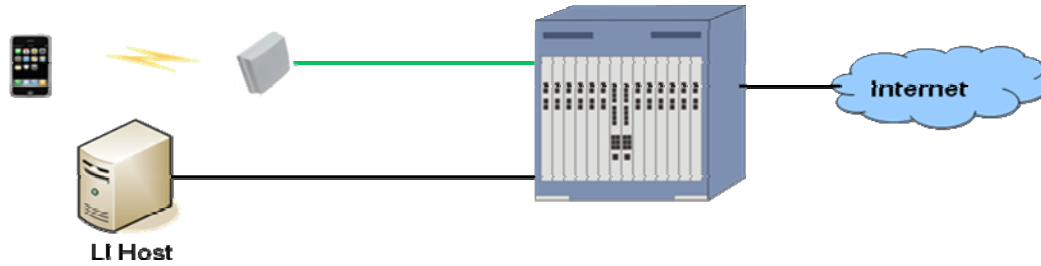

Figure 6-4 Lawful interception

To create Lawful interception gateway interface and rules on JadeOS, complete the following steps:

Step 1 Enter the LI configuration mode.

```
(JadeOS)(config) #li
```

Step 2 Configure the LI gateway on JadeOS.

```
(JadeOS)(config-li) #lig add test123 mirror gigabitethernet 2/1
```

Step 3 Configure the LI rule and enable the lawful intercept on JadeOS.

```
(JadeOS)(config-li) #rule host-filter 1 gigabitethernet 2/1 10.1.10.2 send test123
```

```
(JadeOS)(config-li) #li enable
```

Chapter 8 Configuring HQoS

With the rapid development of the computer network, services such as bandwidth, delay, jitter sensitive voice and video are transferred through IP network tunnel.

JadeOS support HQoS (hierarchical QoS) technology which can classify the type of service traffic; it can also uniformly manage and hierarchically schedule the transfer objects, such as several users, multi-service, and several types of traffic and so on, which ensure the quality for different data service.

To enable or disable HQoS function in JadeOS, use following command in config mode:

```
hqos-switch [on|off]
```

8.1 Configuring Rate Limitation on Port

To configure the rate limitation for port on JadeOS, using following command:

```
rate-limit [down|up] (0-10240) [bps|kbps|mbps]
```

For example, to configure the rate limit of in direction is 200 Mbps and the rate of out direction is 300 Mbps:

```
(JadeOS)(config)#interface gigabitethernet 1/0
(JadeOS)(config-if)#rate-limit up 200 mbps
(JadeOS)(config-if)#rate-limit down 300 mbps
```

8.2 Configuring Rate Limitation on VLAN

To configure the rate limitation for VLAN on JadeOS, using following command:

```
(JadeOS)(config)#interface vlan 100
(JadeOS)(config-if)#rate-limit up 200 mbps
(JadeOS)(config-if)#rate-limit down 1 mbps
```

8.3 Configuring Rate Limitation on User

To configure the rate limitation for user on JadeOS, using following steps:

Step 1 To configure bandwidth named 'BW-8M' and 'BW-2M', using following command:

```
(JadeOS) (config)#aaa bandwidth-contract BW-8M mbits 8
(JadeOS) (config)#aaa bandwidth-contract BW-2M mbits 2
```

Step 2 To configure the downstream bandwidth named 'BW-8M' and the upstream bandwidth named 'BW-2M' in user role, using following command:

```
(JadeOS) (config)#user-role postauth
```

(JadeOS) (config-role)#bandwidth-contract BW-8M downstream

(JadeOS) (config-role)#bandwidth-contract BW-2M upstream

Chapter 9 Configuring AAA

This chapter describes AAA configuration, including user network access, bandwidth control policy and so on.

9.1 The Attribute of Trust and Untrust

Interface means the inside interface of data packet; when the interface is the attribute of trust, JadeOS will disable authentication function in this interface; when the interface is the attribute of untrust, JadeOS will enable authentication function in this interface.

To configure the attribute of trust and untrust in the interface, use the following steps:

Step 1 Enter interface config mode:

```
(JadeOS) (config)#interface gigabitethernet 10/1
```

Step 2 Configure the interface is the attribute of trust

```
(JadeOS) (config-if)#trusted
```

Step 3 Configure the interface is the attribute of untrust

```
(JadeOS) (config-if)#no trusted
```

All the layer-2 interface and layer-3 interface is with the attribute of trust and untrust; when the data packet goes through several interfaces, JadeOS will decide whether to authenticate according to the last interface's attribute. For example, add the interface gigaethernet 1/0 into vlan 10; gigaethernet 1/0 is the attribute of trust, interface vlan 10 is the attribute of untrust; data packet will authenticate according to the attribute of the last interface vlan 10 based on the above rule.

9.2 User and User Role

9.2.1 User

In order to flexibly control the network access and traffic bandwidth in different IP address, JadeOS will create a user table for each IP address that goes through untrust interface. User table has its own life cycle.

Create User: when traffic of one IP address goes into system from untrust interface, JadeOS will look up the IP address in the system; if it is not in existence, JadeOS will trigger the authentication process and generate a user table; user table is indexed by IP address.

Delete User: when user offline or no traffic for a long time, JadeOS will delete this

user table.

9.2.2 User Role and ACL

User role defines the network access. JadeOS specifies the network access of user by ACL. To create a user role in JadeOS, you need to create a session ACL, and then apply the ACL to the user role.

To create user role, use the following steps:

Step 1 Configure a session ACL named pre-auth-acl

```
(JadeOS) (config) #ip access-list session pre-auth-acl
```

Step 2 Configure network access.

```
(JadeOS) (config-sess-pre-auth-acl)#any any udp 53 permit
```

```
(JadeOS) (config-sess-pre-auth-acl)#any any tcp 0 65535 dst-nat ip 10.0.0.2 443
```

```
(JadeOS) (config-sess-pre-auth-acl)#any any ucp 0 65535 dst-nat ip 10.0.0.2 443
```

Step 3 Create a user role named 'pre-auth'

```
(JadeOS) (config) #user-role preauth
```

Step 4 Apply user rule to ACL

```
(JadeOS) (config-role) #session-acl pre-auth-acl
```

Attribute	Description
access-list	Apply access list to user role
bandwidth-contract	Set the maximum bandwidth
max-sessions	Set the datapath session limit, 64k by default
reauthentication-interval	Config the intervals of re-authentication
session-acl	Apply session ACL
vlan	Distribute VLAN

The attribute list supported by user role

9.2.3 Access Policy Based on User Role

Before a user successfully authenticate, JadeOS specifies an initial role to user (role before authentication); after the user is successfully authenticate, JadeOS will specify a new role to the user (role after authentication). Network administrators can flexibly control network access through configuring ACL.

For example, configure a user role named pre-auth that permit DNS traffic, but redirect all other traffic to port 443 to perform authentications by DNAT; configure a user role named post-auth that allow all the traffic; use the following steps:

```

(JadeOS) (config) #ip access-list session pre-auth-acl
(JadeOS) (config-sess-pre-auth-acl)#any any udp 53 permit
(JadeOS) (config-sess-pre-auth-acl)#any any tcp 0 65535  dst-nat ip 10.0.0.2 443
(JadeOS) (config-sess-pre-auth-acl)#any any ucp 0 65535  dst-nat ip 10.0.0.2 443
(JadeOS) (config-sess-pre-auth-acl)#exit
(JadeOS) (config) #ip access-list session post-auth-acl
(JadeOS) (config-sess-post-auth-acl)#any any any permit
(JadeOS) (config-sess-pre-auth-acl)#exit
(JadeOS) (config)#user-role preauth
(JadeOS) (config-role)#access-list session pre-auth-acl
(JadeOS) (config)#user-role postauth
(JadeOS) (config-role)#access-list session post-auth-acl

```

9.3 Connections among User, VLAN and User Role

Each user has its own VLAN ID in JadeOS.

Several ways to specify VLAN for each user, for example:

- If a user access from one VLAN interface, user's VLAN is the interface's VLAN ID;
- Specify a VLAN for SSID; if a user access from this SSID, user's VLAN is the specified VLAN;

Each VLAN has an AAA policy; please refer to chapter 9.4 for more information.

Each AAA policy defines the user role before authentication and after authentication (including network access and bandwidth control). User will switch user role after authentication.

9.4 Configuring AAA Profile

AAA profile is a profile about authentication configuration. Profile specifies the authentication ways (web portal, 802.1x, and MAC authentication), initial role (role before authentication), default role (role after authentication), Radius Server and so on.

Apply AAA profile to one VLAN, and then all the user in the VLAN can use AAA profile. Before configuration, you need to configure ACL, Role, Radius server group, authentication ways, and then apply them to the AAA profile.

9.4.1 Configuring ACL

ACL is used to specify user's network access. Please refer to chapter 9.2 and 9.3 for more information.

9.4.2 Configuring role

Configuring AAA profile need to configure user role before authentication and after authentication. Please refer to chapter 9.3 for more information.

9.4.3 Configuring Radius Server Group

Step 1 Configure Radius server RS1, including IP address of radius server, authentication key and local IP address:

```
(JadeOS) (config)#aaa authentication-server radius RS1
(JadeOS) (RADIUS Server "RS1")#host 119.6.200.245
(JadeOS) (RADIUS Server "RS1")#key 123456
(JadeOS) (RADIUS Server "RS1")#ip 119.6.200.33
(JadeOS) (RADIUS Server "RS1")#exit
```

Step2 Configure Radius server group SG1, including several Radius Server.

```
(JadeOS) (config)#aaa server-group SG1
(JadeOS) (Server Group "SG1")#auth-server RS1
```

Commands supported by Radius Server

Attribute	Description
acctport	port number using to accounting; range: 1-65535; default value: 1813
authport	Port number using to authentication; range: 1-65535; default value: 1812
host	IP address and host name of Radius server
ip	Source address of radius request
key	Pre-shared key
nas-identifier	nas-identifier used in RADIUS data packet
nas-ip	nas-ip of RADIUS data packet
retransmit	Maximum number of request; range: 0-3; default value: 3
timeout	Request timeout; range: 1-30s; default value: 5s
use-md5	Encryption using MD5s

Commands supported by Radius Server Group

Attribute	Description
allow-fail-through	Allow traffic that failed authentication
auth-server	Distribute authentication server
set	Set Role/Vlan rule

9.4.4 Configuring Authentication Way

Authentications supported by JadeOS are captive-portal, dot1x, mac, open, psk, wep,

and radius-proxy; usually the authentication way will specify default-role, which is the user role after successfully authentication. This chapter will describe the configuration for authentication way by using web portal as an example.

In portal authentication, you need to define a rfc-3576-client, then a profile that at least include radius server group、 default-role、 rfc-3576-client. Please refer to chapter 9.7 for more information.

For example:

```
(JadeOS) (config)#aaa rfc-3576-client 119.6.200.203
(JadeOS) (RFC 3576 Client "119.6.200.203")#key 1234
(JadeOS) (RFC 3576 Client "119.6.200.203")#exit
(JadeOS) (config)#aaa authentication captive-portal web-portal
(JadeOS) (Portal Authentication Profile "web-portal")#server-group SG1
(JadeOS) (Portal Authentication Profile "web-portal")#default-role postauth
(JadeOS) (Portal Authentication Profile "web-portal")#rfc-3576-client 119.6.200.203
```

Commands supported by Portal:

Attribute	Description
default-role	Distribute default role
rfc-3576-client	RFC-3576 client
server-group	web radius server group name
welcome-page-url-id	The url ID of welcome page

9.4.5 Configuring AAA Profile

To configure AAA profile, use the following steps:

Step 1 Create a aaa profile named ‘aaa’

```
(JadeOS) (config)#aaa profile aaa
```

Step 2 Specify the authentication way

```
(JadeOS) (AAA profile "aaa")#authentication-portal web-portal
```

Step 3 Specify use role before authentication

```
(JadeOS) (AAA profile "aaa")#initial-role preauth
```

Step 4 Specify the Radius Server Group, and enable accounting function

```
(JadeOS) (AAA profile "aaa")#radius-accounting SG1
```

```
(JadeOS) (AAA profile "aaa")#radius-accounting enable
```

Commands supported by AAA profile

Attribute	Description
authentication-dot1x	Configure 802.1X authentication profile
authentication-mac	Configure MAC authentication profile
authentication-open	Configure open authentication profile

authentication-portal	Configure Portal authentication profile
authentication-psk	Configure PSK authentication profile
authentication-radius-proxy	Configure radius proxy profile
authentication-wep	Configure WEP authentication profile
disconnect-message-client	Configure disconnect message client
http-redir-url-id	Configure http redirection url ID
http-redirection	Configure http-redirection
initial-role	Role that is assigned to a user before authentication takes place
post-auth	Post-auth Timer
pre-auth	Pre-auth Timer
radius-accounting	Configure radius accounting

9.4.6 Binding VLAN

Bind the AAA profile to VLAN 100, all the user in VLAN 100 will use this AAA profile. Configuration commands as follows:

```
(JadeOS) (config)#vlan 100 aaa-profile aaa
```

9.5 MAC Authentication

Authentication Description

MAC address authentication is an authentication way to control user network access based on MAC address; it need not to install any client software.

MAC authentication encapsulates the MAC address into RADIUS message according to configuration, and then authenticate in the specified RADIUS server. Therefore, MAC authentication will be used together with other authentication ways (WPA, web-auth) in usual, also it can be used independently. After detecting MAC address in the first time, JadeOS will enable authentication for this user.

Configuration Management

To configure MAC address, use the following steps:

Step 1: Configure MAC authentication profile

```
(JadeOS) (config)#aaa authentication mac mac1
```

```
(JadeOS) (MAC Authentication Profile "mac1")#server-group sg
```

```
(JadeOS) (MAC Authentication Profile "mac1")#default-role post-auth
```

```
(JadeOS) (MAC Authentication Profile "mac1")#exit
```

Step 2: Apply MAC authentication in AAA profile

```
(JadeOS) (MAC Authentication Profile "mac1")#aaa profile aaa
```

```
(JadeOS) (AAA profile "aaa")#authentication-mac mac1
```

9.6 802.1X Authentication

Authentication Description

802.1 x authentication is an authentication policy based on port. The purpose of 802.1x authentication is to decide whether a port is available; if successfully authenticate, the port will allow all the message; if unsuccessfully authenticate, the port only allow 802.1x message.

Configuring Steps

802.1x authentication need to specify radius server and default-role, examples as follows:

Step 1 Configure radius server

```
(JadeOS) (config)#aaa authentication dot1x dot1x1
```

```
(JadeOS) (802.1X Authentication Profile "dot1x1")#default-role post-auth
```

```
(JadeOS) (802.1X Authentication Profile "dot1x1")#server-group SG1
```

```
(JadeOS) (802.1X Authentication Profile "dot1x")#server-group SG1
```

```
(JadeOS) (802.1X Authentication Profile "dot1x")#default-role postauth
```

Step 2 Apply 802.1x authentication in AAA profile

```
(JadeOS) (MAC Authentication Profile "mac1")#aaa profile aaa
```

```
(JadeOS) (AAA profile "aaa")#authentication-dot1x dot1x1
```

9.7 WEB Portal Authentication

Web authentication is an authentication scheme based on browser. User that failed authentication will redirect to a login page, and require to input user name and password; user can access the network only after successfully authentication. WEB redirect supports DNAT redirect and HTTP 302 redirect.

9.7.1 Web Authentication Process

Web authentication is based on HTTP protocol; authentication will not pop up forcibly unless user send HTTP request.

The authentication process of WEB authentication is as follows:

- A user that unauthenticated begin to browser network page and send HTTP request
- HTTP request is redirect to an external portal server
- Port server send an authentication page for secure login

-
- User input user name and password; browser will transfer it to the web portal (authentication module in JadeOS), and then web portal send authentication request to the radius server
 - JadeOS will decide whether authenticate successfully through user database in radius server; if successfully authenticate, radius server will inform JadeOS, at the same time, JadeOS inform portal server
 - Portal server pops up welcome page; the user authentication is over

9.7.2 DNAT Redirect

The redirect operation of JadeOS is based on DNAT by default.

Before authentication, session ACL will redirect HTTP request to portal server.

The configuration command is as follows:

```
(JadeOS) (config) #ip access-list session pre-auth-acl
(JadeOS) (config-sess-pre-auth-acl)#any any tcp 0 65535  dst-nat ip 10.0.0.2 443
(JadeOS) (config-sess-pre-auth-acl)#any any ucp 0 65535  dst-nat ip 10.0.0.2 443
```

9.7.3 HTTP 302 Redirect

To configure HTTP 302 redirect, use the following steps:

Step 1 Configure URL list in config mode:

```
(JadeOS) (config)# aaa http-redirection-url 1 ip 10.0.0.1 url http://10.0.0.1/wlan/index.php
```

Step 2 Specify URL ID

```
(JadeOS) (AAA profile "aaa")#http-redir-url-id 1
```

Step 3 Enable http 302 redirect

```
(JadeOS) (AAA profile "aaa")#http-redirection enable
```

9.7.4 Configuring Portal Server

JadeOS web authentication will customize the login page through external portal server. Portal server will configure a client according to RFC3576 definition; the client is used for sending users' disconnection and authorization change information to JadeOS.

To configure RFC client, use the following command:

```
(JadeOS) (config)#aaa rfc-3576-client 119.6.200.203
(JadeOS) (RFC 3576 Client "119.6.200.203")#key 1234
```

TO configure the source port according to RFC3576 server, use the following command:

```
ip rfc-3576-server ip <IP> port <1-65535>
```

9.7.5 Configuring CoA Disconnect Message

Disconnect message (DM) is user disconnect message. The AAA Service Framework uses CoA messages to dynamically modify active subscriber sessions. For example RADIUS attributes in CoA messages might instruct the framework to create modify or terminate a subscriber service.

CoA Messages

Dynamic request support enables the router to receive and process unsolicited CoA messages from external RADIUS servers. RADIUS-initiated CoA messages use the following codes in request and response messages:

■ CoA-Request (43)

■ CoA-ACK (44)

■ CoA-NAK (45)

To configure CoA DM server, use the following command:

```
ip disconnect-message-server <IP> port <1~65535>
```

To configure CoA DM client, use the following command:

```
(JadeOS) (config) #aaa profile aaa  
(JadeOS) (AAA profile "aaa") #disconnect-message-client <IP>
```

9.7.6 Configuring Captive-portal Authentication

Step 1 Configure authentication way

```
(JadeOS) (config)#aaa authentication captive-portal web-portal  
(JadeOS) (Portal Authentication Profile "web-portal")#server-group SG1  
(JadeOS) (Portal Authentication Profile "web-portal")#default-role postauth  
(JadeOS) (Portal Authentication Profile "web-portal")#rfc-3576-client 119.6.200.203
```

Step 2 Apply captive-portal authentication in AAA profile

```
(JadeOS) (AAA profile "aaa")#authentication-portal web-portal
```

9.7.7 Customize Logout Domain

User can use customized logout domain, such as logout.wifi; user can input logout.wifi in the browser, and then login logout page.

To configure logout.wifi in JadeOS, use the following command:

```
(JadeOS) (config)#ip domain-name logout.wifi http-redirect-url <word>
```

9.7.8 Configuring White-list and Black-list

White-list and black-list authentication is a group of URL.

Three cases about white-list and black-list authentication as follows:

- User can access white-list URL and no need to authenticate
- User can not access black-list URL, even though successfully authenticate
- User can access URL that neither white-list nor black-list after successfully authenticate

To configure domain in JadeOS, use the following command:

```
(JadeOS) (config) # netdestination black-list|white-list name WORD
```

Configuring White-list

To configure white-list in JadeOS, use the following command:

```
(JadeOS) (config) #netdestination white-list name www.sina.com
(JadeOS) (config) # ip access-list session pre
(JadeOS) (config-sess-pre) # any host <DNS> any permit position 1
(JadeOS) (config-sess-pre) #any alias 123 any permit position 2
```

Configuring Black-list

To configure black-list in JadeOS, use the following command:

```
(JadeOS) (config) #netdestination black-list name www.sina.com
(JadeOS) (config) # ip access-list session post
(JadeOS)(config-sess-post) #any alias 123 any deny send-deny-response
position 2
```

9.8 Radius Proxy

JadeOS supports radius proxy. With proxy RADIUS, one RADIUS server receives an authentication (or accounting) request from a RADIUS client (such as a NAS), forwards the request to a remote RADIUS server, receives the reply from the remote server, and sends that reply to the client, possibly with changes to reflect local administrative policy. A common use for proxy RADIUS is roaming. Roaming permits two or more administrative entities to allow each other's users to dial in to either entity's network for service.

9.8.1 Configuring Radius Proxy

Step 1 Create aaa authentication radius-proxy RP

```
(JadeOS) (config)#aaa authentication radius-proxy RP
(JadeOS) (Radius Proxy Profile "RP")#default-role postauth
(JadeOS) (Radius Proxy Profile "RP")#server-group SG1
```

Step 2 Config aaa profile AAA, and specify the authentication way of Radius Proxy

is RP

```
(JadeOS) (AAA profile "AAA")#authentication-radius-proxy RP
```

Step 3 Specify the aaa profile in config mode

```
(JadeOS) (AAA profile "AAA")#aaa radius-proxy aaa profile AAA
```

Step 4 Enable Radius proxy in config mode

```
(JadeOS) (AAA profile "AAA")#aaa radius-proxy enable
```

9.8.2 Configuring EAP-SIM

EAP-SIM is one of the EAP authentication protocol based on 2G SIM card through which users access to WLAN network.

Differed from other authentication protocol, EAM-SIM takes use of the user data and original authentication message be stored in SIM card to authenticate user and generate session key to access WLAN. At the same time the data will be stored in the ISP's HLR to avoid the authentication message transfer on Internet to prevent user data from network attack.

EAP-SIM is the authentication protocol applied in 2G networks and EAP-AKA is applied in 3G network. EAP-SIM authentication is performed when users use SIM card and EAP-AKA authentication is performed when users use USIM card. EAP-SIM and EAP-AKA is specified in RFC 4186 and RFC 4187 respectively.

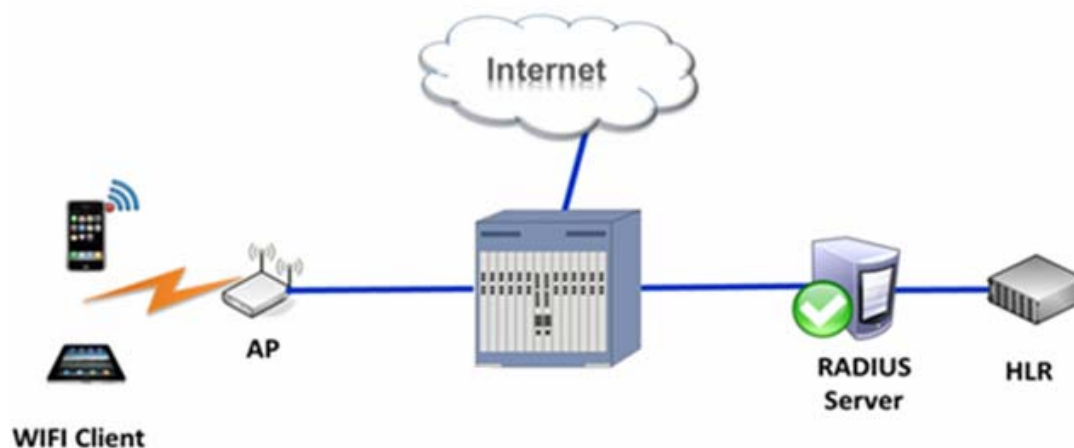

Figure 9-1 EAP-SIM authentication

To configure EAP-SIM authentication on JadeOS, following the steps:

Step 1 Configure Radius Server and Server Group

```
(JadeOS) (config) # aaa authentication-server radius r1
```

```
(JadeOS) (RADIUS Server "r1") #host 1.1.1.1
```

```
(JadeOS) (RADIUS Server "r1") #key 123
```

```
(JadeOS) (RADIUS Server "r1") #ip 10.1.1.10
(JadeOS) (config) #aaa server-group sg
(JadeOS) (Server Group "sg")#auth-server r1
```

Step 2 Configure 802.1x authentication profile

```
(JadeOS) (config)#aaa authentication dot1x dot1x
(JadeOS) (802.1X Authentication Profile "dot1x")#default-role postauth
(JadeOS) (802.1X Authentication Profile "dot1x")#server-group g1
```

Step 3 Configure AAA Profile

```
(JadeOS) (config)#aaa profile default
(JadeOS) (AAA profile "default")#authentication-dot1x dot1x
(JadeOS) (AAA profile "default")#radius-accounting sg
(JadeOS) (AAA profile "default")#initial-role preauth
```

Step 4 Configure ssid-profile

```
(JadeOS) (config)#wlan ssid-profile default
(JadeOS) (SSID Profile "default")#auth-mode wpa-aes
```

Step 5 Configure vap-profile

```
(JadeOS) (config)#wlan vap-profile default
(JadeOS) (VAP Profile "default")#aaa-profile default
(JadeOS) (VAP Profile "default")#ssid-profile default
```

Step 6 Configure ap-template

```
(JadeOS) (config)#ap-template default
(JadeOS) (AP template "default")#vap-profile default
```

9.9 Rate Limit Based on User

Step 1 Configure bandwidth named "BW-8M" and "BW-2M" in config mode

```
(JadeOS) (config)#aaa bandwidth-contract BW-8M mbits 8
(JadeOS) (config)#aaa bandwidth-contract BW-2M mbits 2
```

Step 2 Specify the downstream is BW-8M and the upstream is BW-2M

```
(JadeOS) (config)#user-role postauth
(JadeOS) (config-role)#bandwidth-contract BW-8M downstream
(JadeOS) (config-role)#bandwidth-contract BW-2M upstream
```

9.10 User Accounting

To configure user accounting, you need to configure a radius server group first, and enable radius accounting in AAA profile. To enable user accounting, use the **Radius-accounting <server-group>** command. For example:

```
(JadeOS) (AAA profile "aaa")#radius-accounting SG1
```

9.11 Example of WEB-Portal Authentication

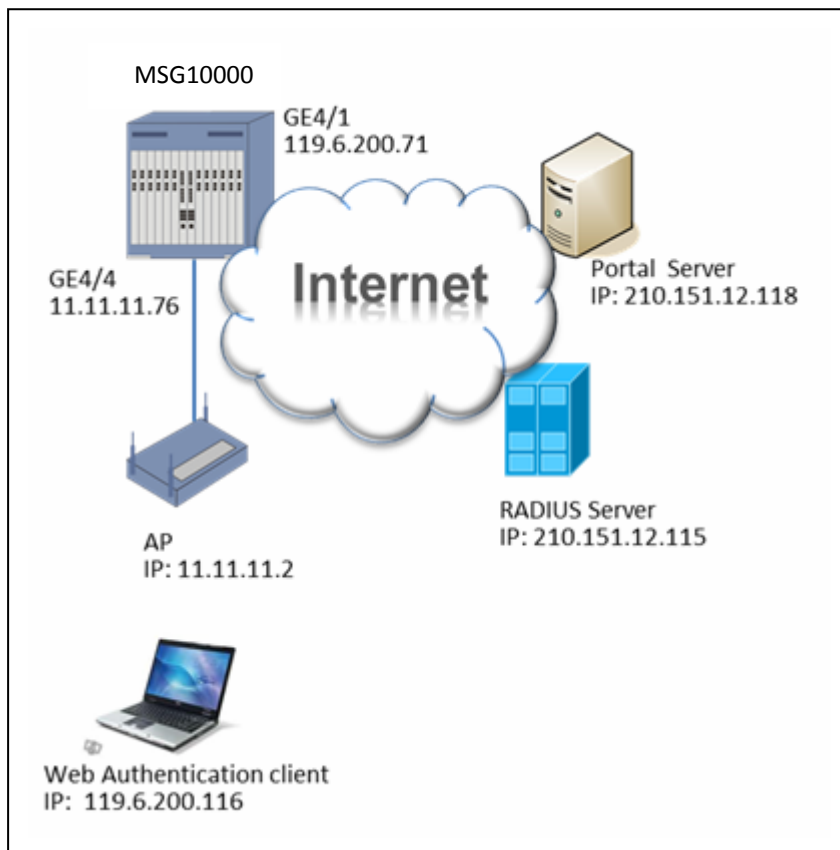

The following topology is taken for a web authentication configuration example:

Figure 9-2 Web authentication configuration example

Step 1 Configure VLAN and IP

```
(JadeOS)
(config) #vlan database
(JadeOS)
(config-vlan) #vlan
range 11,30
(JadeOS)
```

```
(config) #interface gigabitethernet 4/1
(JadeOS) (config-if)#switchport access vlan 30
(JadeOS) (config-if)#exit
(JadeOS) (config) #interface gigabitethernet 4/4
(JadeOS) (config-if)#switchport access vlan 11
(JadeOS) (config-if)#exit
(JadeOS) (config) #interface vlan 30
(JadeOS) (config-subif)#ip address 119.6.200.71/24
(JadeOS) (config-subif)#exit
(JadeOS) (config) #interface vlan 11
(JadeOS) (config-subif)#ip address 11.11.11.76/24
(JadeOS) (config-subif)#exit
(JadeOS) (config) # ip route 0.0.0.0 0.0.0.0 119.6.200.1
(JadeOS) (config-subif)#end
```

Step 2 Create DHCP Server

```
(JadeOS) (config) #ip dhcp pool 119
```

```
(JadeOS) (config-dhcp)#network 119.6.200.0 255.255.255.0
(JadeOS) (config-dhcp)#default-router 119.6.200.1
(JadeOS) (config-dhcp)#dns-server 119.6.6.6
(JadeOS) (config-dhcp)#exit
(JadeOS) (config) #ip dhcp excluded-address 119.6.200.1 119.6.200.115
(JadeOS) (config) #ip dhcp excluded-address 119.6.200.117 119.6.200.254
(JadeOS) (config) #service dhcp
```

Step 3 Configure ACL session

```
(JadeOS) (config) #ip access-list session pre-auth-ctrl
(JadeOS) (config-sess-pre-auth-ctrl)# host 119.6.200.116 any tcp 80 dst-nat 8189 ip 210.151.12.118
(JadeOS) (config-sess-pre-auth-ctrl)#any any svc-dhcp permit
(JadeOS) (config-sess-pre-auth-ctrl)#any any udp 53 permit
(JadeOS) (config-sess-pre-auth-ctrl)#any host 210.151.12.118 tcp 443 permit
(JadeOS) (config-sess-pre-auth-ctrl)#exit
(JadeOS) (config) #ip access-list session post-auth-ctrl
(JadeOS) (config-sess-post-auth-ctrl)#any any any permit
(JadeOS) (config-sess-post-auth-ctrl)#exit
```

Step 4 Configure user role

```
(JadeOS) (config) #user-role pre-auth
(JadeOS) (config-role) #session-acl pre-auth-ctrl
(JadeOS) (config-role) #exit
(JadeOS) (config) #user-role role
(JadeOS) (config-role) #session-acl post-auth-ctrl
(JadeOS) (config-role) #exit
```

Step 5 Configure timers

```
(JadeOS) (config) # aaa timers dead-time 10
```

Step 6 Configure RFC-35756 server and RFC-3576 client

```
(JadeOS) (config) #ip rfc-3576-server source-interface vlan 30 port 1700 (JadeOS) (config) #aaa
rfc-3576-client 210.151.12.118
(JadeOS) (RFC 3576 Client "210.151.12.118") #key *****
```

Step 7 Configure radius server and add it to server group

```
(JadeOS) (config) #aaa authentication-server radius r1
(JadeOS) (RADIUS Server "r1") #host 210.151.12.115
(JadeOS) (RADIUS Server "r1") #key *****
(JadeOS) (RADIUS Server "r1") #nas-ip 119.6.200.71
(JadeOS) (RADIUS Server "r1") #source-interface vlan 30
(JadeOS) (config) #aaa server-group g1
(JadeOS) (Server Group "g1") #auth-server r1
```

Step 8 Configure aaa profile

```
(JadeOS) (config) #aaa profile ABC
(JadeOS) (AAA Profile "ABC") #web-auth-server-group g1
(JadeOS) (AAA Profile "ABC") #rfc-3576-client 210.151.12.118
(JadeOS) (AAA Profile "ABC") #initial-role pre-auth
(JadeOS) (AAA Profile "ABC") #web-auth-default-role post-auth
(JadeOS) (AAA Profile "ABC") #post-auth idle-time 300
(JadeOS) (AAA Profile "ABC") #post-auth lifetime 300
(JadeOS) (AAA Profile "ABC") #pre-auth idle-time 300
(JadeOS) (AAA Profile "ABC") #pre-auth lifetime 300
```

Step 9 Apply profile to VLAN

```
(JadeOS) (config) #vlan 30 aaa-profile ABC
```

9.12 Trouble Shooting

When JadeOS is in trouble, user can locate problem by viewing user list. To view user list, use **show user-table** command. For example:

```
(JadeOS) #show user-table
```

```
Auth User Table Entries
```

```
-----
```

```
Flags: O - Post-auth, E - Pre-auth, W - Web-auth, P - RADIUS proxy,
```

```
       C - Accounting, m - Pre-MAC-auth, M - Post-MAC-auth, R - L3 roaming,
```

```
       o - Open, w - WEP, c - CCMP, t - TKIP, a - WPA, n - RSN, x - 802.1X, L - Station leave
```

No.	IP-addr	MAC-addr	Type	Flags	Age(d:h:m)
User-name					
---	-----	-----	----	----	-----

```
-----
```

```
(JadeOS) #show user-table
```

```
(JadeOS) #show datapath user table
```

```
Datapath User Table Entries
```

```
-----
```

```
Flags: P - Permanent, W - WEP, T- TKIP, A - AESCCM, G - AESGCM, V - ProxyArp to/for MN(Visitor),
```

```
       N - VPN, L - local, Y - Any IP user, R - Routed user, M - Media Capable,
```

```
       S - Src NAT with VLAN IP, E - L2 Enforced, F - IPIP Force Delete, O - VOIP user
```

IP	MAC	ACLs	Contract	Location	Sessions	Flags
----	-----	------	----------	----------	----------	-------

(JadeOS) #show datapath user coun

(JadeOS) #show datapath user counters

Datapath User Table Count is: 0

JadeOS provides solutions of wireless controller and FIT AP.

Wireless controller uniformly configure, manage and maintain a large quantity of APs, which greatly reduces the maintenance of wireless network. JadeOS supports AP without configuration, which is convenient to expand FIT AP and wireless network.

JadeOS also supports centralized authentication, which is convenient to uniformly access and authenticate. At the same time, it is better to do the function of wireless roaming, RF management and load balance of AP access for AP centralized management.

With the standard CAPWAP protocol, AC manages and controls AP through CAPWAP control channel; the data forwarding between AP and AC is through CAPWAP data channel. For CAPWAP is transferred based on Layer-3 network, it supports flexible network deployment in multi network; with the standard protocol, it raises the possibility of interconnection between different products from different manufacturers. Forwarding mode supports AC centralized forwarding and AP local forwarding. Authentication mode supports AC centralized authentication and AP local authentication.

10.1 Wireless Network Architecture

10.1.1 CAPWAP Description

Control and provisioning of wireless access points (CAPWAP) protocol is belonging to IETF. It rules the interconnection between WTP and AC, which achieve the management and data forwarding for all the WTPs controlled by AC. Now CAPWAP is classified into two types:

- CAPWAP control channel
- CAPWAP data channel

10.1.2 CAPWAP Control Channel

CAPWAP control channel is classified into two types:

Static discovery: specify the IP address of AC in AP

Dynamic discovery: configure broadcast discovery, DHCP discovery and DNS discovery and so on in AP

More, AP will actively require update version and configuration, which reduce the maintenance.

10.1.3 CAPWAP Data Channel

After configuration request by AP, AC will consult with AP to enable data channel. In centralized forwarding mode, up-link message will be encapsulated with CAPWAP in AP, decapsulated in AC, and then forwarding; down-link message will be encapsulated with CAPWAP in AC, and then arrive AP through CAPWAP tunnel; the down-link message will be decapsulated in AP, and then arrive user terminals through 802.11 protocols.

10.1.4 Mirror Upgrade and Configuration Management

AP will automatically check for version upgrade. You just need to configure in AC for configuration management, no need to configure a large quantity of APs. The configuration will be in effective when AC receives AP request. The configuration command is as below:

```
copy ap-image primary-image ftp 192.168.50.222 admin AmOS-1.4.1.2 41724 WIA3200-10 A1
AmOS-1.4.1.2
```

10.1.5 Forwarding Mode

JadeOS achieve AC centralized forwarding and AP local forwarding in CAPWAP standard. You can specify the forwarding mode through configuration.

10.1.6 Authentication Mode

JadeOS achieve AP centralized authentication and AP local authentication. Each SSID can specify a VLAN, and then look for AAA profile according to VLAN; please refer to chapter 9.3 for more information.

10.1.7 STATION Management

The authentication of Station will be handled in AC. AC will record the authentication process of AP and the information connected AP, which is the basis of choosing CAPWAP data channel and roaming. Station management includes 802.11 management, STA information inquiry, log backup and recovery.

10.2 Forwarding Mode

Forwarding mode is classified into 802.11 tunnel centralized forwarding, 802.3 tunnel centralized forwarding, AC authentication local forwarding and local authentication local forwarding.

10.3 Configuring Power

You can configure to automatically choose the power of AP and station in AC, the configuring command is as follows:

```
transmit-power 0
```

Configuring Radio Frequency

You can manually configure radio frequency of AP, at the same time, AP can keep the original radio frequency information when AP online again after AP offline normally.

For example:

```
(JadeOS) (config)#radio dot11g-profile default
(JadeOS) (802.11g radio Profile "default")#channel 149
```

Configuring Radio Power

- JadeOS supports manually power regulation. For example

```
(JadeOS) (config)#radio dot11a-profile default
(JadeOS) (802.11a radio Profile "default")#transmit-power 10
(JadeOS) (802.11a radio Profile "default")#transmit-power 20
```

- JadeOS supports automatically power regulation.

```
(JadeOS) (802.11a radio Profile "default")#transmit-power 0
```

10.4 Configuring Radio

You can automatically choose the working channel of AP and station. For example:

```
channel 0
```

10.5 DTLS and CA

Datagram Transport Layer Security (DTLS) is based on the standard IETF protocol in TLS. CAPWAP control message and part of CAPWAP data message are using DTLS encryption mechanism of UDP layer. The configuration command is as follows:

```
dtls
```

Import CA

Import CA in server into AC, which means transferring the CA format into another format that can be recognized by DTLS control channel and remove the password.

For example:

```
(JadeOS) #copy ftp 1.2.3.4 user cert_file flash sc-file-1
```

```
(JadeOS) #Cert import pem serverCert sc-1 sc-file-1
```

10.6 Special SSID and SSID Control

In EDU mode, in order to avoid AP disables all the SSIDs when AP disconnects with AC, AC will specify a special SSID when AP connects with AC; when CAPWAP is disconnected, AP will enable this SSID to ensure the normal service. The configuring command is as follows:

```
(JadeOS) (config)#wlan ssid-profile SSID
(JadeOS) (SSID Profile "SSID")#special-ssid
```

Timing Shutdown

Timing shutdown supports the following functions:

- Support AC timing shutdown the function of radio frequency in specified AP
- Support AC timing shutdown the specified functions of SSID

The configuring command:

```
time-range default
```

Example:

```
(JadeOS) (config)#time-range-profile default
(JadeOS) (Time Range Profile "default")#range weekday 17:00 18:00
(JadeOS) (Time Range Profile "default")#range weekend 17:00 18:00
(JadeOS) (Time Range Profile "default")#range daily 17:00 18:00
(JadeOS) (Time Range Profile "default")#exit
(JadeOS) (config)#wlan vap default
(JadeOS) (Virtual AP Profile "default")#time-range default
(JadeOS) (Virtual AP Profile "default")#exit
(JadeOS) (config)#radio dot11a-profile default
(JadeOS) (802.11a radio Profile "default")#time-range default
(JadeOS) (802.11a radio Profile "default")#exit
```

Note: Shutdown the frequency will make the whole radio disable; shutdown SSID just disable one SSID in radio.

10.7 ACL

User access is mainly to issue ACL based on SSID, MAC, flow threshold, bandwidth control. ACL is important in building secure network, and mainly supports the following functions:

- ACL based on MAC address
Configure ACL based on MAC address in AC, which achieve the black-list and white-list based on MAC address.

For example:

Add *mac 11:22:33:44:55:6* into black-list:

```
(JadeOS) (AP MAC ACL Profile "mac-acl-prof-1")#list-type deny
```

```
(JadeOS) (AP MAC ACL Profile "mac-acl-prof-1")#mac 11:22:33:44:55:66
```

Add *mac 11:22:33:44:55:6* into white-list:

```
(JadeOS) (AP MAC ACL Profile "mac-acl-prof-1")#list-type accept
```

```
(JadeOS) (AP MAC ACL Profile "mac-acl-prof-1")#mac 11:22:33:44:55:66
```

- Support to disconnect network automatically based on idle traffic monitor; you can configure time and the default value is 300s. the configuring command is as follows:

```
idle-timeout <300-15300>
```

- Support ACL based on traffic threshold and the default value is 1KB:

```
idle-threshold <0-1048576>
```

Configuring ACL

Configuring ACL based on IP address in AC achieves user access control. Configuring different ACLs in AC can control different user access, for example: you can make user in the specified IP segment access the specified network segment. For ACL based on IP address is according to SSID, you can configure different ACLs in different SSID.

Functions supported by ACL:

- Match source IP address and network segment
- Match destination IP address and network segment
- Match specified IP protocol and range
- Match source port and destination port of UDP/TCP protocol
- Support the operation of 'permit' and 'deny' according to the above rules

Configuration command:

```
any any any deny/permit
```

For example:

```
(JadeOS) (config)#ip access-list session acl1
```

```
(JadeOS) (config-sess-acl1)#host 1.1.1.1 any tcp 1 100 deny
```

```
(JadeOS) (config-sess-acl1)#exit
```

```
(JadeOS) (config)#user-role role1
```

```
(JadeOS) (config-role)#access-list session acl1
```

```
(JadeOS) (config-role)#exit
```

```
(JadeOS) (config)#aaa profile aaa1
```

```
(JadeOS) (AAA profile "aaa1")#initial-role role1
(JadeOS) (AAA profile "aaa1")#exit
(JadeOS) (config)#wlan virtual-ap default
(JadeOS) (Virtual AP Profile "default")#aaa-profile aaa1
(JadeOS) (Virtual AP Profile "default")#exit
```

10.8 Authentication Exemption

For the special user that accounting exemption such as administrator and so on, JadeOS supports authentication exemption, for example:

Step 1 Configure AAA profile, disable radius-accounting

```
(JadeOS) (config)#aaa profile a1
(JadeOS) (AAA profile "a1")#no radius-accounting enable
(JadeOS) (AAA profile "a1")#exit
```

Step 2 Apply AAA profile to the VLAN

```
(JadeOS) (config)#vlan 10 aaa profile a1
```

10.9 Anti-fake and Rogue AP detect

Anti-fake

To enable anti-fake function, use the following command:

```
validate-sta-enable
```

To disable anti-fake function, use the following command:

```
no validate-sta-enable
```

Rogue AP Detect

AC will configure detect rule according to the message sent by AP, that is to make a detect policy for rogue equipment; then AC will classify the APs according to the detect rule.

For example:

```
(JadeOS) (config)#wids ap-classification-rule
(JadeOS) (IDS AP Classification Rule )# enable
(JadeOS) (IDS AP Classification Rule )# ssid test encryption open
(JadeOS) (IDS AP Classification Rule )# ap-oui 11:22:33
```

Note: To display rogue ap, use **show rogue-ap** command.

10.10 Anti-DoS

The function of WLAN Dos is to prevent DoS attack.

For example:

```
(JadeOS) (config)#wids dos-profile default
(JadeOS) (IDS DOS-Profile "default")#dos-prevention
(JadeOS) (IDS DOS-Profile "default")#mgmt-frame-throttle-interval 10
(JadeOS) (IDS DOS-Profile "default")#mgmt-frame-throttle-limit 100
```

To display the attack in all the Aps, use **show wlan dos** command.

To display the attack in specified MAC, use **show wlan dos ap <ap_ip>** command.

Chapter 10 WEBUI

11.1 WEBUI Description

JadeOS supports WEBUI configuration.

11.2 WEBUI Login

Step 1 Open IE browser and input IP address, then JadeOS will pop up the following dialog box:

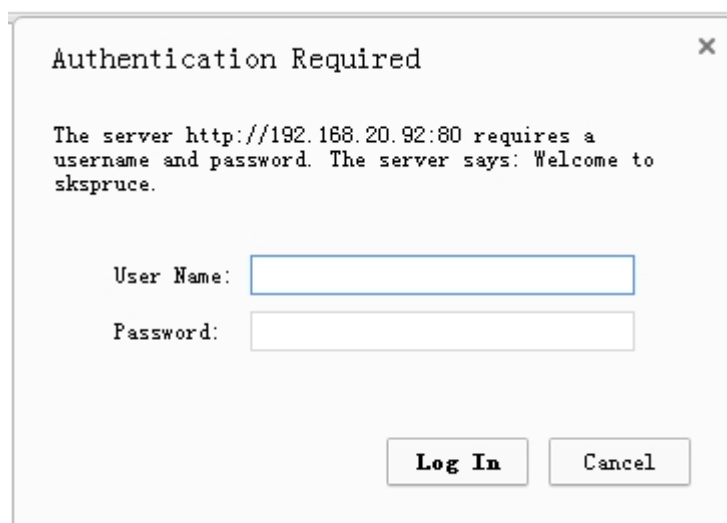

The dialog box titled "Authentication Required" contains the following text: "The server http://192.168.20.92:80 requires a username and password. The server says: Welcome to skspruce." Below the text are two input fields: "User Name:" and "Password:". At the bottom of the dialog are two buttons: "Log In" and "Cancel".

Figure 12-1 Login Dialog Box

Step 2 Input user account 'admin' and password 'admins' and click **Login** button, then JadeOS will redirect to the following login page:

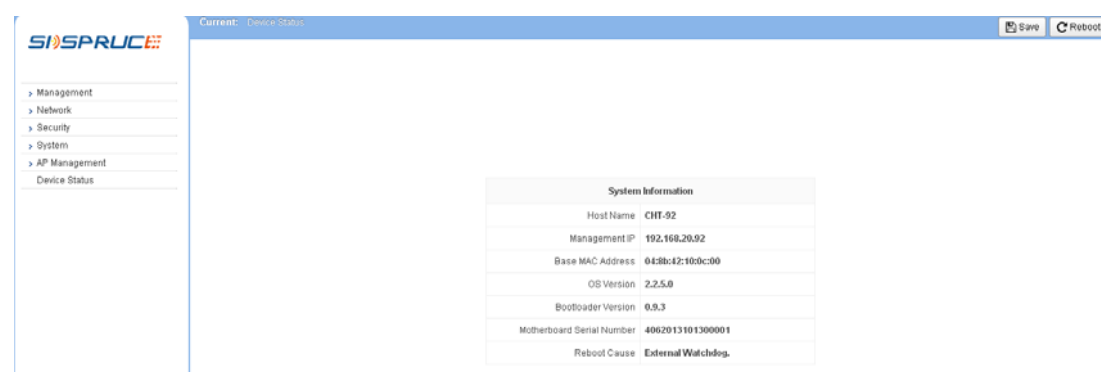

The screenshot shows the JadeOS webUI interface. The top navigation bar includes the "SI SPRUCE" logo, the text "Current: Device Status", and "Save" and "Reboot" buttons. A left sidebar menu lists: Management, Network, Security, System, AP Management, and Device Status. The main content area displays a "System Information" table with the following data:

System Information	
Host Name	CHT-92
Management IP	192.168.20.92
Base MAC Address	0438b4210dc00
OS Version	2.2.5.0
Bootloader Version	0.9.3
Motherboard Serial Number	4062013101300001
Reboot Cause	External Watchdog

Figure 12-2 webUI page

Chapter 11 Configuring SNMP

12.1 Configuring SNMP

Simple Network Management Protocol (SNMP) is an Internet-standard protocol for managing devices on IP networks. It is used mostly in network management systems to monitor network-attached devices for conditions that warrant administrative attention. JadeOS support versions 1, 2c, and 3 of SNMP. You can configure SNMP using the following commands:

```
snmp-server community rw|ro <WORD>
snmp-server traphost <IP> <WORD> {udp-port portno}
```

Parameter	Description
WORD	Name of Community
udp-port port no	(optional) port number, default value: 162
IP	IP address

Table 13- 1 Basic Parameters of SNMP

For example:

```
(JadeOS)#configure terminal
(JadeOS)(config)#snmp-server community ro ww 1.1.1.1
```

Chapter 12 Maintenance and Diagnosis

13.1 Log System

Log system is used to record system running status, which can be saved in local or remote log server. Log is classified to 8 levels from emerg to debug, and the default level is error.

To set log level, use the following command in config mode:

```
logging level <level> <all|category> [process app]
logging <IP> [severity level] [type category]
```

Note: log level: emerg , alert, crit, err, warning, notice, info, debug.

To set the log size in local server, use the command in config mode:

```
log size <100-102400> (unit:KB)
```

To recovery the log level in local to the default, use the command in config mode:

```
no logging level <level> <all|category> [process app]
no logging <IP> [severity level] [type category]
```

For example:

```
(JadeOS)(config)#logging level err all
(JadeOS)(config)#logging 192.168.16.84
(JadeOS)(config)#log size 102400
(JadeOS)(config)#end
```

To inquiry the local log, use the command in enable mode:

```
show log <all|category [app]> [line]
(JadeOS) #show log all
```

13.2 System Management

JadeOS is a unified multi-level scalable technology. It uses the active-standby mode in control plane and active-active mode in data plane to achieve the high performance and high availability. The distributed architecture has been extended to meet requirements of high performance equipment.

You can have a general view for the system management and telecommunications among all modules in figure 14-1.

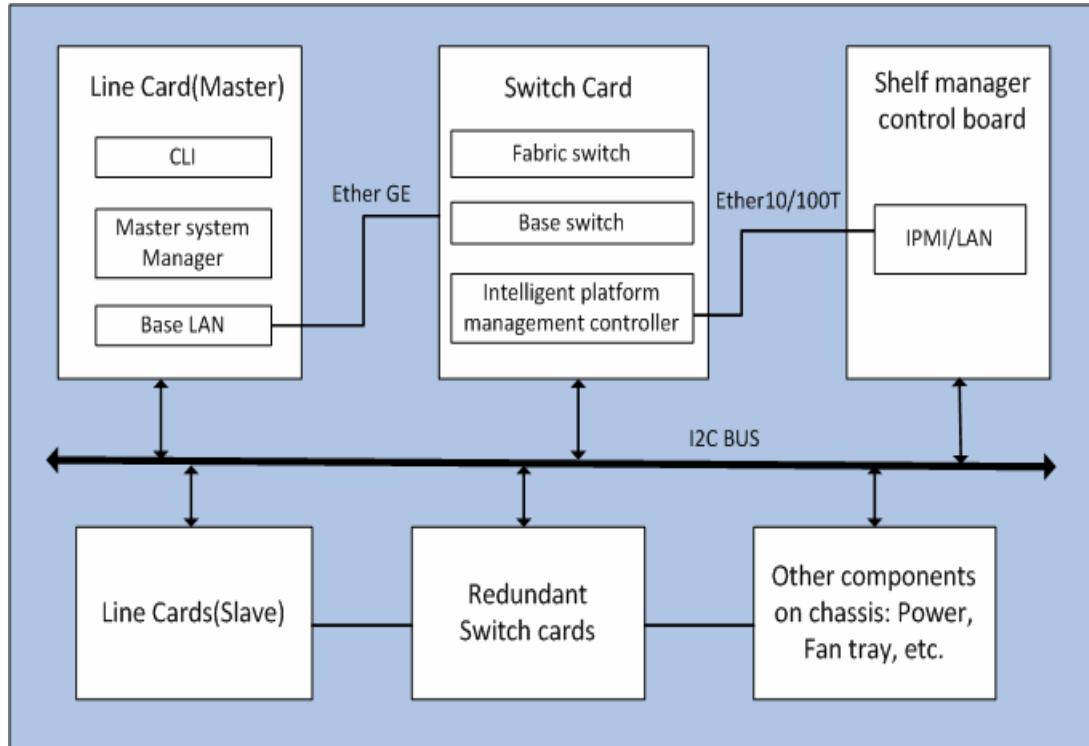

Figure 14- 1 Modules Diagram for the System Management

When system powering up, a “master” system manager will be elected among all line cards existing in the chassis to control the whole equipment. The shelf manager control board sends/receives messages from the cards and modules over I²C bus. The elected “master” system manager on the line card get information from the shelf manager control board across the switch board by TCP/IP to control and monitor the whole system.

Information Inquire

To restart the system when JadeOS is in trouble, use the following command:

```
reload
```

To inquire the system information such as JadeOS version, gateway uptime, and so on, use the following command:

```
show version
```

To inquire chassis components status such as power module connection status, fan speed, line card temperature and so on, use the following command:

```
show inventory
```

To inquire the factory default information about chassis, use the following command:

```
show chassis_info
```

To inquire the environment temperature about the chassis, use the following command:

```
show temperature chassis
```

To inquire the CPU usage percentage, use the following command:

```
show cpuload
```

To inquire the CPU memory usage information, use the following command:

```
show memory
```

To inquire system log, use the following command:

```
show log all
```

To inquire the process status, use the following command:

```
show process monitor statistics
```

Alarm

The hardware running status on JadeOS can be monitored and reported to system manager. If the working state on each card or module, for example temperature, is beyond the threshold, the alarms will arise and the LEDs on the card or module will turn on.

The thresholds can be set manually using the following command:

```
alarmthreshold
```

NOTE: The alarm LED on SAD card will not turn off automatically when the alarm is relieved until you clear the alarm manually. To clear the alarm LED on SAD card, use the following command on the master line card:

```
turn-off-led
```

13.3 Sniffer Tool

JadeOS provides the sniffer tools for network diagnosis; it can capture the data packet in network interface and filter based on interface, IP address and tcp/udp port number. The operation steps are as following:

Step 1 Configure filter conditions, and specify the capture traffic is 10M in maximum.

```
(JadeOS) #packet capture interface gigaethernet 1/0 datatype all maxsize 10
```

Step 2 Start capture

```
(JadeOS) #packet capture start
```

Step 3 Stop capture

```
(JadeOS) #packet capture stop
```

Step 4 Display the packet capture

```
(JadeOS) # show packet capture
```

Abbreviations

A

AC	Alternating Current
ACC	Automatic Current Control
ACL	Access Control List
AS	Autonomous System
ATCA	Advanced Telecom Computing Architecture
AP	Access Point

B

BCMC	Broadcast and Multicast
-------------	-------------------------

C

CAPWAP	Control And Provisioning of Wireless Access Points
CDP	Cisco Discovery Protocol
CE	Communication Edge
CLI	Command Line Interface

D

DES	Data Encryption Standard
DHCP	Dynamic Host Configuration Protocol
DNS	Domain Name Server
DOS	Disk Operating System

E

EAP	Enterprise Application Platform
EAPOL	Extensible Authentication Protocol
ECN	Engineering Change Notice

F

FRU	Field Replaceable Unit
FTP	File Transfer Protocol

G

GRE	Generic Routing Encapsulation
GMT	Greenwich Mean Time

I

IDS	Intrusion Detection System
IDPS	Intrusion Detection and Prevention System

IETF	Internet Engineering Task Force
IGP	Interior Gateway Protocol
IP	Internet Protocol
IPMB	Intelligent Platform Management Bus
IPMC	Intelligent Platform Management Controller
IPMI	Intelligent Platform Management Interface
IPS	Intrusion Prevention System
L	
LACP	Link Aggregation Control Protocol
LAG	Link Aggregation Group
LDAP	Lightweight Directory Access Protocol
LED	Light Emitting Diode
M	
MAC	Multi-Access Computer
MLVDS	Multipoint Low-Voltage Differential Signaling
N	
NAT	Network Address Translation
NTP	Network Time Protocol
O	
OSPF	Open Shortest Path First
P	
PCB	Printed Circuit Board
PEM	Power Entry Module
PPC	
PVST	Per Vlan Spanning Tree
O	
OS	Operation Software
OSPF	Open Shortest Path First
OUI	Organizationally unique identifier
Q	
QOS	Quality Of Service
R	
RAM	Random Access Memory

RFC	Request For Comments
RSTP	Rapid Spanning Tree Protocol
RTC	Real Time Clock
RTM	Rear Transmission Module
S	
SAD	Shelf Alarm Display
SAP	Shelf Alarm Panel
SHA	Secure Hash Algorithm
SNMP	Simple Network Management Protocol
SSID	Service Set Identifier
SSL	Secure Sockets Layer
SSH	Secure Shell
STP	Spanning Tree Protocol
T	
TCA	Telecommunications Computing Architecture
TCP/IP	Transmission Control Protocol / Internet Protocol
TFTP	Trivial File Transfer Protocol
TKIP	Temporal Key Integrity Protocol
U	
UDP	User Datagram Protocol
V	
VCCI	Voluntary Control Council for Interference
VLAN	Virtual Local Area Network
VPN	Virtual Private Network
VRID	Virtual Router ID
VRRP	Virtual Router Redundancy Protocol
VTP	Virtual Trunk Protocol
W	
WEP	Wired Equivalent Privacy
WPA	Wi-Fi Protected Access