

10. Configure the *Wireless Security*:

- a. Select the AES *Key Type*, **HEX** or **ASCII**.
- b. For the *Key* field:
  - **HEX** Enter 16 bytes (eight, 16-bit HEX values: 0-9, A-F, or a-f). You can omit zeroes and use colons, similar to the IPv6 format.



**Note:** The airFiber Configuration Interface supports IPv6 formats excluding dotted quad and "::" (double-colon) notation.

- **ASCII** Enter a combination of alphanumeric characters (0-9, A-Z, or a-z).

11. Click **Change** and then click **Apply**.

12. *In-Band Management* is enabled by default, so each airFiber X radio must have a unique *IP Address*. (If the airFiber X radios use the same *IP Address*, you may lose access to the airFiber X radios via the *DATA* ports.) Click the **Network** tab.

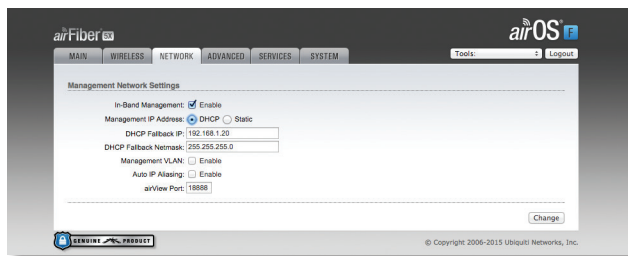

- a. For the *Management IP Address* option:
  - **DHCP** Keep the default, *DHCP*, to use DHCP reservation on your router to assign a unique *IP Address*.
  - **Static** Change the *IP Address*, *Netmask*, and other settings to make them compatible with your network.
- b. Click **Change** and then click **Apply**.

Repeat the instructions in the *airFiber Configuration* section on your other airFiber X radio. After you have configured the airFiber X radios, disconnect them and move them to your installation site.

## Hardware Installation

### Install a Ground Wire

1. Remove the nut from the *Ground Bonding Point* located on the back of the airFiber X radio.

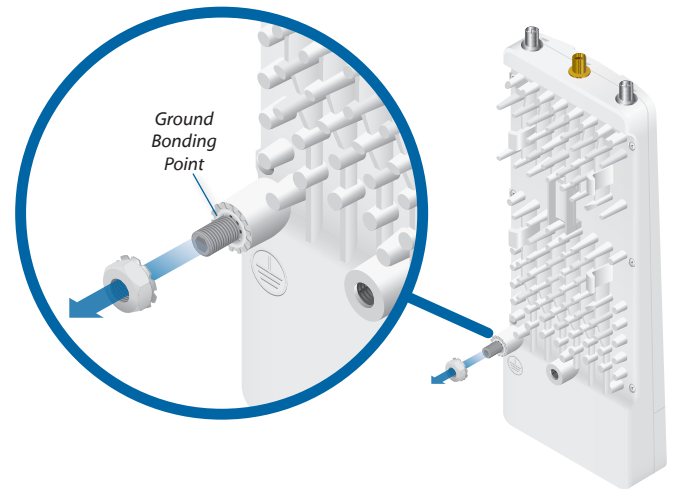

2. Attach a ground wire (min. 10 AWG or 5 mm<sup>2</sup>) to the lug and replace the nut to secure the wire.



3. At the installation site, secure the other end of the ground wire to a grounded mast, pole, tower, or grounding bar.



**WARNING:** Failure to properly ground your airFiber X radio will void your warranty.



**Note:** The ground wire should be as short as possible and no longer than one meter in length.

## Mount to an Antenna

The airFiber X radio can be mounted to the antenna(s) listed in **“Installation Requirements” on page 3**. The airFiber X Antenna (AF-5G30-S45) is shown in the following steps:

1. Attach the airFiber X radio to the mounting bracket.
  - a. Align the mounting tabs on the back of the airFiber X radio with the mounting bracket.
  - b. Slide the airFiber X radio down to lock it into place.

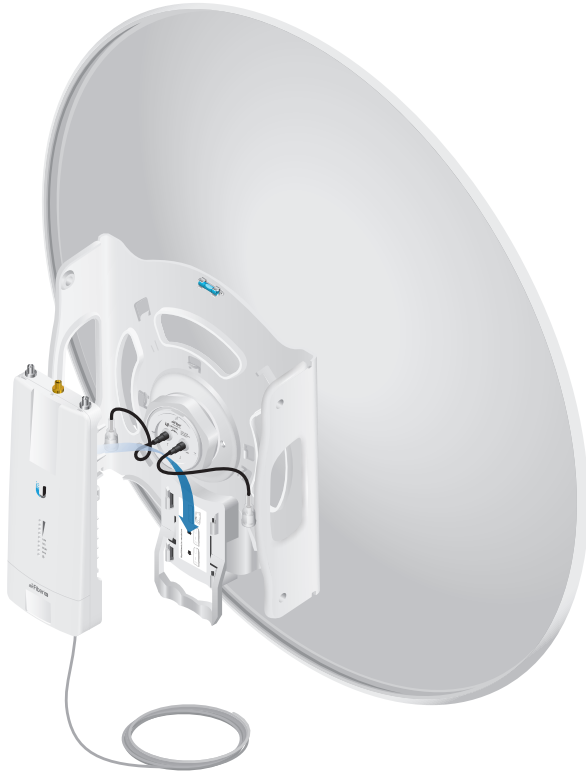

2. Attach the RF cables from the antenna feed to the RF connectors on the airFiber X radio in this combination: +45° to Chain 0 and -45° to Chain 1.



3. Attach the *External GPS Antenna* to the RF connector labeled *GPS*. Then, place the magnetic *External GPS Antenna* on the bracket (this is temporary; you will mount the *External GPS Antenna* on the *GPS Antenna Mount* at the site).



4. Attach the protective shroud.
  - a. Align the hash mark on the top of the shroud with the notch on the dish antenna.
  - b. Rotate the shroud clockwise until it locks into place.



## Mount the External GPS Antenna

Locate a mounting point that has a clear view to the sky, and is above and as far away as possible from the AirFiber X radio.

1. Attach the *GPS Antenna Mount* to the pole using the metal strap, or attach it to a wall using the appropriate fasteners (not included).

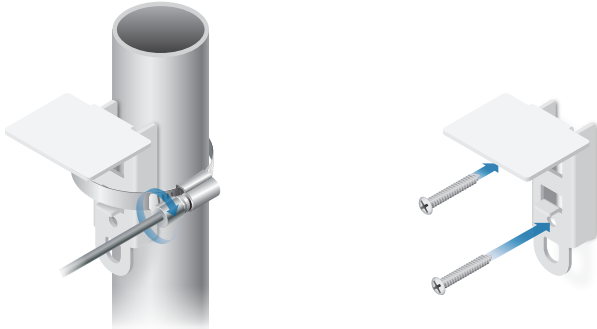

2. Place the *External GPS Antenna* on the mount.

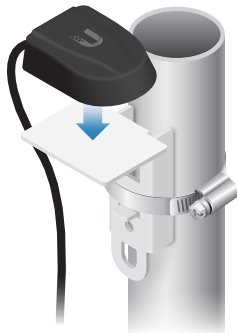

3. Secure the cable of the *External GPS Antenna* to the mount with a *Cable Tie*.



## Connecting Power over Ethernet

1. Lift the release latch on the bottom of the airFiber X radio and slide the *Port Cover* off.

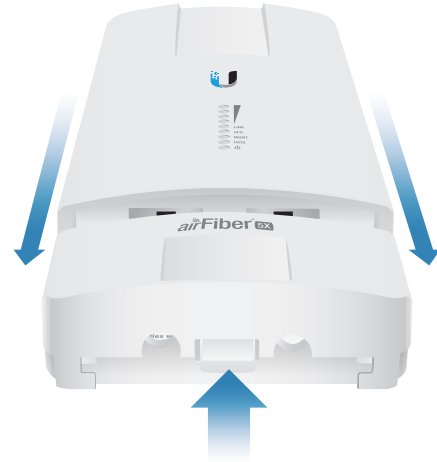

2. Connect an outdoor, shielded Ethernet cable to the *DATA* port.



3. Connect the other end of the cable from the *DATA* port to the Ethernet port labeled **POE** on the *airFiber PoE Adapter*.

**!** **WARNING:** Use only the included *airFiber PoE Adapter*, Model: **GP-H240-100G-4**. Failure to do so can damage the unit and void the product warranty.

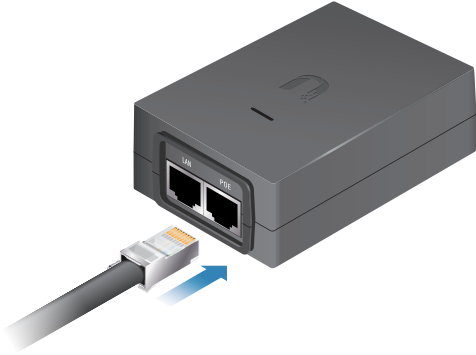

4. Connect an Ethernet cable from your network to the Ethernet port labeled **LAN** on the *airFiber PoE Adapter*.

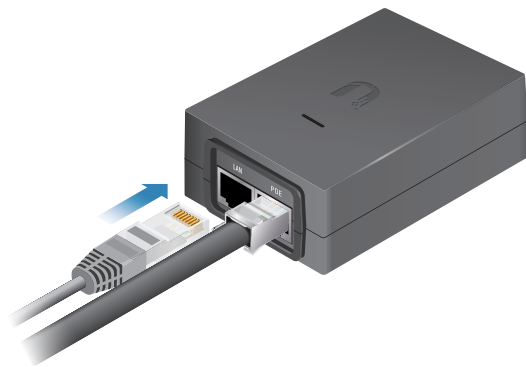

5. Connect the *Power Cord* to the power port on the *airFiber PoE Adapter*. Connect the other end of the *Power Cord* to a power source.

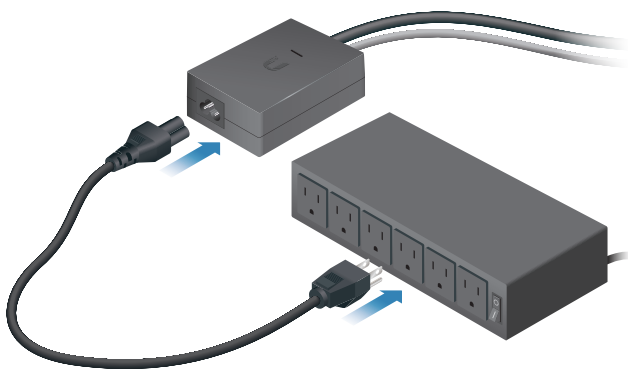

## Mount the PoE Adapter (Optional)

1. Remove the *Mounting Bracket* from the adapter by sliding the bracket downward.



2. Place the *Mounting Bracket* at the desired location and mark the holes for the fasteners. Pre-drill the holes if necessary, then secure the bracket to the wall using two fasteners (not included).

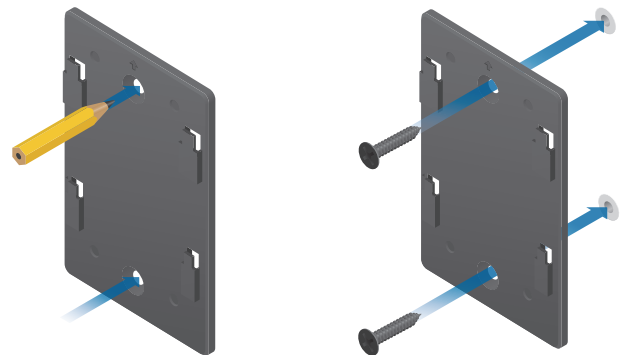

3. Attach the *airFiber PoE Adapter* to the bracket by aligning the four slots and tabs, and then slide the adapter downward.

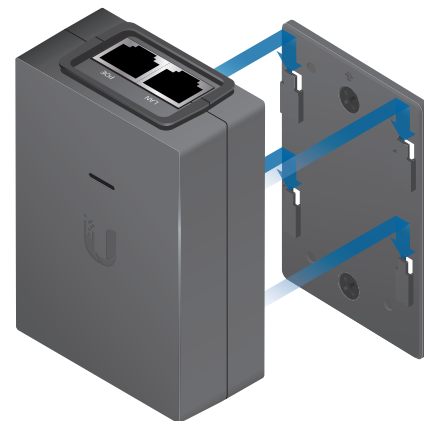

## Surge Protection

For added protection, install two surge suppressors, such as the Ubiquiti Ethernet Surge Protector, model ETH-SP, at the end of each link. Install the first surge protector within one meter of the airFiber DATA port, and install the second surge protector at the ingress point of the location housing the wired network equipment.

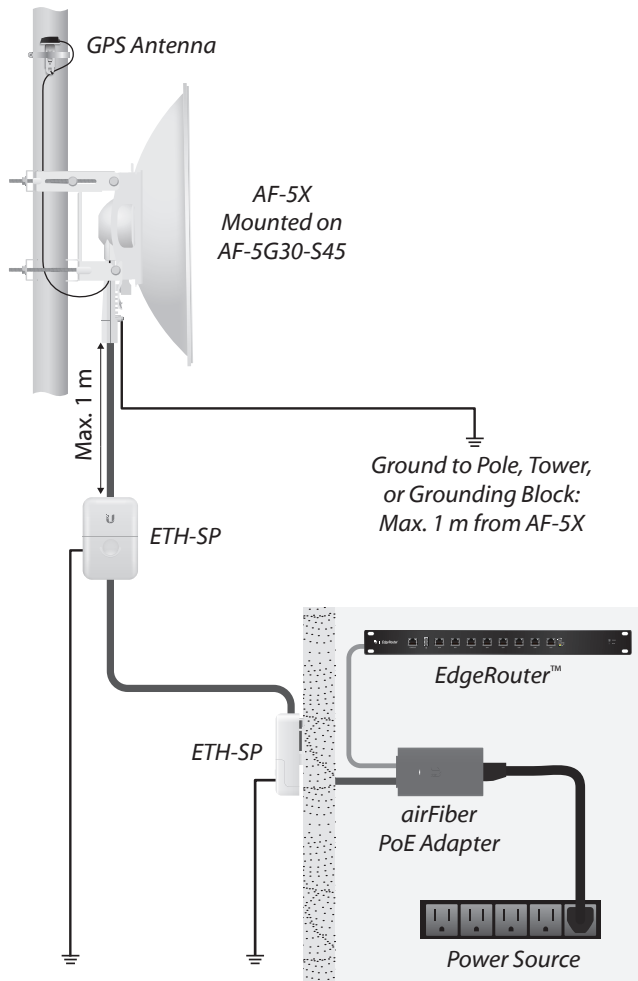

## Alignment

### Tips

- To accurately align the airFiber X radios for best performance, you MUST align only one end of the link at a time.
- You may need to use additional hardware to compensate for issues such as the improper orientation of a mounting pole or significant elevation differences between airFiber X radios.

## Establishing a Link

Adjust the positions of the *Master* and the *Slave* to establish a link.

**Note:** The *Master* must be aimed first at the *Slave* because the *Slave* does not transmit any RF signal until it detects transmissions from the *Master*.

1. **Master** Visually aim the *Master* at the *Slave*. To adjust the *Master's* position:
  - a. Loosen the four pole clamp nuts, and rotate the airFiber antenna on the pole to align the azimuth.

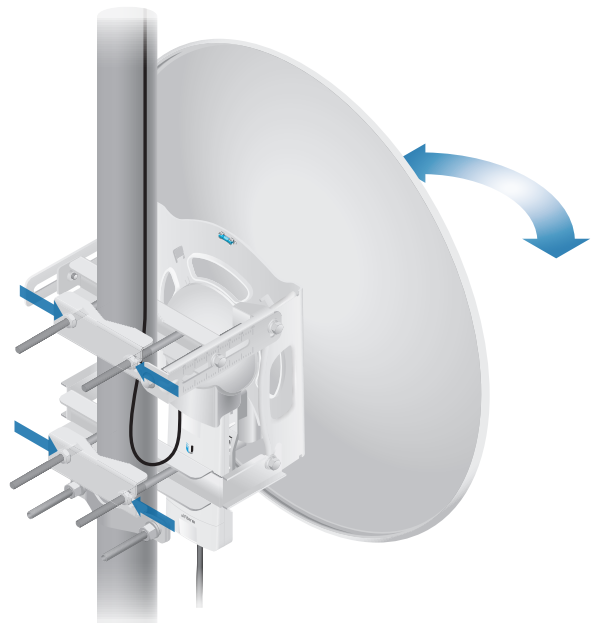

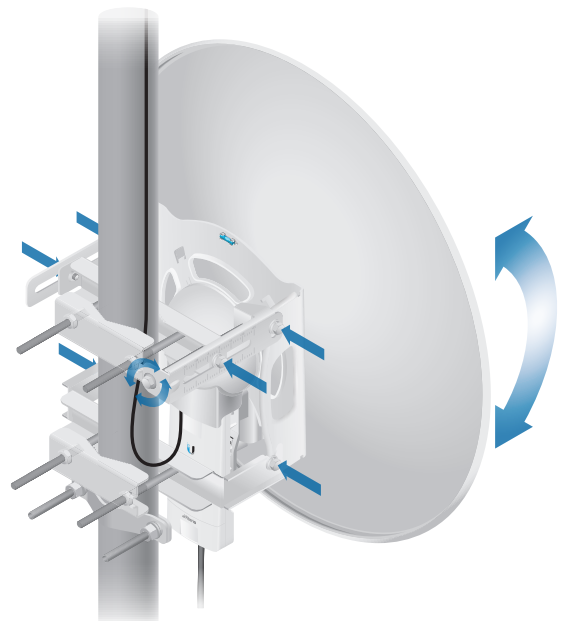

- b. Loosen the six elevation bolts, and use the hex nut on the elevation rod to adjust the elevation.



**Note:** Do NOT make simultaneous adjustments on the *Master* and *Slave*.

2. **Slave** Visually aim the *Slave* at the *Master*. To adjust the *Slave*'s position:
  - a. Loosen the four pole clamp nuts, and rotate the airFiber antenna on the pole to align the azimuth.
  - b. Loosen the six elevation bolts, and use the hex nut on the elevation rod to adjust the elevation.
3. Check to see if a link is established. Ensure that the *LINK* LED is solidly lit green and the *Signal* LEDs of the *Slave* are displaying signal levels.



4. **Slave** Aim the *Slave* at the *Master* to achieve the strongest signal level on the *Master*.
  -  **Note:** Refer to **“Signal LEDs” on page 2** for details on the signal values.
  -  **Note:** Maximum signal strength can best be achieved by iteratively sweeping through both azimuth and elevation.
5. **Master** Aim the *Master* at the *Slave* to achieve the strongest signal level on the *Slave*.
6. Repeat steps 4 and 5 until you achieve an optimal link, with all four *Signal* LEDs solidly lit. This ensures the best possible data rate between the airFiber X radios.
7. Lock the alignment on both airFiber antennas by tightening all the nuts and bolts.
8. Observe the *Signal* LEDs of each airFiber X radio to ensure that the values remain constant while tightening the nuts and bolts. If any LED value changes during the locking process, loosen the nuts and bolts, finalize the alignment of each airFiber antenna again, and retighten the nuts and bolts.

Refer to the following chapters of this User Guide for details on the airFiber Configuration Interface:

- **“Main Tab” on page 13**
- **“Wireless Tab” on page 17**
- **“Network Tab” on page 20**
- **“Advanced Tab” on page 22**
- **“Services Tab” on page 25**
- **“System Tab” on page 29**
- **“Tools” on page 32**

## Installer Compliance Responsibility

Devices must be professionally installed and it is the professional installer’s responsibility to make sure the device is operated within local country regulatory requirements.

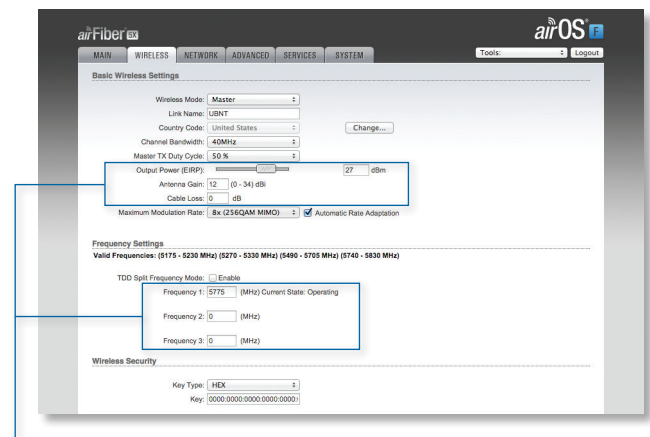

The *Output Power*, *Antenna Gain*, *Cable Loss*, and *Frequency* fields are provided to the professional installer to assist in meeting regulatory requirements.

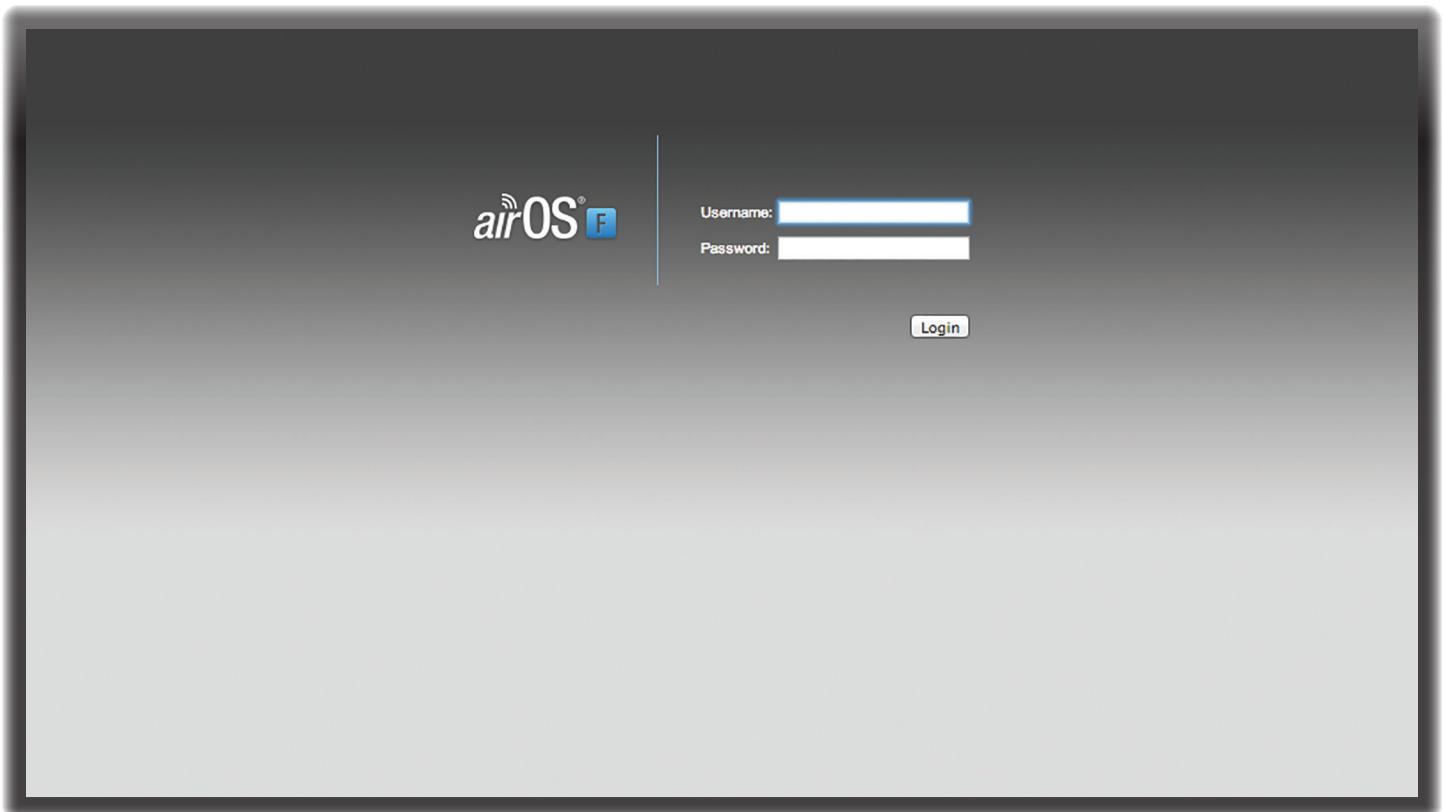

## Chapter 3: Navigation

The airFiber Configuration Interface is an advanced operating system capable of powerful wireless and routing features, built upon a simple and intuitive user interface foundation.

The airFiber X radio uses the airFiber Configuration Interface for easy configuration and management via a web browser.

There are two ways to access the airFiber Configuration Interface:

- **Management Port** Enabled by default. Use a direct connection to the *Management* port for out-of-band management.
- **In-Band Management** Enabled by default. In-band management is available through the local *Data* port or the *Data* port at the other end of the link. You can disable it on the *Network* tab. (See **“Management Network Settings”** on page 20 for more details.)

### Accessing the airFiber Configuration Interface

Connect to the airFiber Configuration Interface.

1. Make sure that your host machine is connected to the LAN that is connected to the *Management* port on the airFiber X radio.
2. Configure the Ethernet adapter on your host system with a static IP address on the 192.168.1.x subnet (for example, 192.168.1.100).

3. Launch your web browser. Type **http://192.168.1.20** in the address field and press **enter** (PC) or **return** (Mac).



4. Upon initial login, the *Terms of Use* appear on the login screen. Enter **ubnt** in the *Username* and *Password* fields, and select the appropriate choices from the *Country* and *Language* drop-down lists. Check the box next to *I agree to these terms of use*, and click **Login**.



**Note:** U.S. product versions are locked to the U.S. Country Code to ensure compliance with FCC regulations.

5. The airFiber Configuration Interface will appear, allowing you to customize your settings as needed.

## Product Verification

The airFiber Configuration Interface will verify whether a product is genuine or counterfeit.

For a genuine airFiber airFiber X radio, the airFiber Configuration Interface will display a Genuine Product logo in the lower left corner of the screen.



For any product that is not an official Ubiquiti product, the airFiber Configuration Interface will display a counterfeit warning. Please contact Ubiquiti at [support@ubnt.com](mailto:support@ubnt.com) regarding this product.



 **Note:** For product models introduced prior to 2012, the airFiber Configuration Interface will NOT display any logo in the lower left corner of the screen.

## Interface Tabs

The airFiber Configuration Interface contains six main tabs, each of which provides a web-based management page to configure a specific aspect of the airFiber X radio. This User Guide covers each tab with a chapter. For details on a specific tab, refer to the appropriate chapter.

- **Main** The **“Main Tab” on page 13** displays device status, statistics, and network monitoring links.
- **Wireless** The **“Wireless Tab” on page 17** configures basic wireless settings, including the wireless mode, link name, frequency, output power, speed, and wireless security.
- **Network** The **“Network Tab” on page 20** configures the management network settings, Internet Protocol (IP) settings, management VLAN, and automatic IP aliasing.
- **Advanced** The **“Advanced Tab” on page 22** provides more precise wireless interface controls, including advanced wireless settings and advanced Ethernet settings.
- **Services** The **“Services Tab” on page 25** configures system management services: Ping Watchdog, Simple Network Management Protocol (SNMP), servers (web, SSH, telnet), Network Time Protocol (NTP) client, Dynamic Domain Name System (DDNS) client, system log, and device discovery.
- **System** The **“System Tab” on page 29** controls system maintenance routines, administrator account management, location management, device customization, firmware update, and configuration backup. You can also change the language of the web management interface.

Each page also contains network administration and monitoring tools:

- **“Align Antenna” on page 32**
- **“Discovery” on page 33**
- **“Ping” on page 33**
- **“Traceroute” on page 33**
- **“airView” on page 33**