

# Contents

## 900MHz Wireless Headphone

HP5990A, HP5990, HP5990J, HP5990AJ



!!!Please ensure you read the user manual  
thoroughly before use!!!

English

!!!Please refer to our website: [www.geemarc.com](http://www.geemarc.com)  
for an up to date user guide, as there may be  
important updates and changes you need to be  
aware of!!!

<b>INTRODUCTION</b>	<b>3</b>
 <b>SAFETY &amp; CARE ADVICE</b>	<b>4</b>
<b>PACK COMPONENTS</b>	<b>5</b>
<b>FUNCTION IDENTIFICATION</b>	<b>6</b>
• Function Identification: Headset Receiver	6
• Function Identification: Charging Cradle	7
<b>INSTALLATION</b>	<b>8</b>
• Transmitter	8
• Headset	9
<b>OPERATION</b>	<b>10</b>
• Initial Operation	10
• Routine Operation	11
• Improving Sound by Switching Channels	12
• Controlling the Tone (Bass & Treble)	13
• Adjusting the Sound Balance (left-right)	14
• Using the Mute Button and Microphone for Conversation	14
• Charging the Battery	15
<b>TECHNICAL SPECIFICATIONS</b>	<b>17</b>

# INTRODUCTION

 <b>TROUBLESHOOTING</b> .....	<b>18</b>
• No Sound .....	18
• Distortion .....	18
<b>Cleaning &amp; Maintenance</b> .....	<b>19</b>
<b>Spare/replacement parts</b> .....	<b>19</b>
<b>Customer support</b> .....	<b>19</b>
<b>GUARANTEE</b> .....	<b>20</b>
<b>CE DECLARATION</b> .....	<b>20</b>
 <b>BATTERY WARNINGS</b> .....	<b>21</b>
<b>DISPOSAL INFORMATION</b> .....	<b>21</b>

The Geemarc Wireless Audio Listener is an audio amplification system specifically designed for people with hearing difficulties.

The Geemarc Audio Listener can be used with all kinds of audio systems for interference-free listening enjoyment – **TV set, Smartphone, DVD player, CD player, Hi-Fi system, iPod or other.**

Audio output from a TV or audio device is transmitted by the Charging Cradle, the wireless Headset receives the signal and amplifies the audio sound for the listener.

- The listener's comfort and long-term enjoyment has been built into every feature of the Geemarc Wireless Audio Listener:
- Lightweight wireless headset fitted with soft silicone ear buds for prolonged listening comfort;
- Rich, adjustable audio quality:
  - Broad audio bandwidth;
  - Adjustable bass, treble and balance to compensate for hearing loss.
- Up to 60 meters transmit-receive range keeps you within hearing distance all over the house and garden;
- Auto-tune button on your headset – tune in for the best sound exactly where you are;
- Listen but keep in touch with your surroundings:
  - Multiple Headsets can be paired with one Charging Cradle;
  - Single-touch Mute function switches the Audio Listener into a conversation assistant enabling you to talk with and listen to the people around you with the Headset on, taking advantage of its built-in audio amplifier to hear everything better.
- Up to 6 hours of rechargeable battery life per full charge – never lose the soundtrack in mid-program;
- Only 3 hours to fully recharge the Headset simply by replacing the Headset in its Charging Cradle.

# SAFETY & CARE ADVICE



## SAFETY & CARE ADVICE

---

To make the best use of this product and to use it safely, please read these instructions thoroughly before use and keep safe for future reference.

**Warning:** This product can be very loud. Take care to prevent others from using this product, if they do not have the same level of hearing loss. Excessive sound pressure from earphones and headphones can cause hearing loss.

**Caution: Electric shock. DO NOT** insert unattached plug heads in to mains power sockets. Plug heads **MUST** be fitted to the power adaptor.

**Electrical connection:** The unit is designed to operate from a 100-240VAC - 50/60Hz supply. (Classified as 'hazardous voltage' according to EN 60650 standard).

**Caution: Batteries should only be replaced by Geemarc or authorised Vendor. Please refer to the chapter: <Spare / replacement parts> for more information.**



Keep the unit away from heat sources.

**DO NOT** expose the unit to direct sunlight.

Do not expose the Headset, which contains batteries, to excessive heat such as sunshine, fire etc.

Clean the Headset and ear pads regularly. For details on cleaning, please refer to the chapter: **<Cleaning & Maintenance>**.

**DO NOT** modify the unit in any way.

**Please note:** The unit may be subject to interference from appliances that generate strong electrical or magnetic fields e.g. wireless Internet routers, microwaves, mobile phones, lighting transformers etc. To avoid this interference, place the Charging Cradle unit away from such sources.

# PACK COMPONENTS

## PACK COMPONENTS

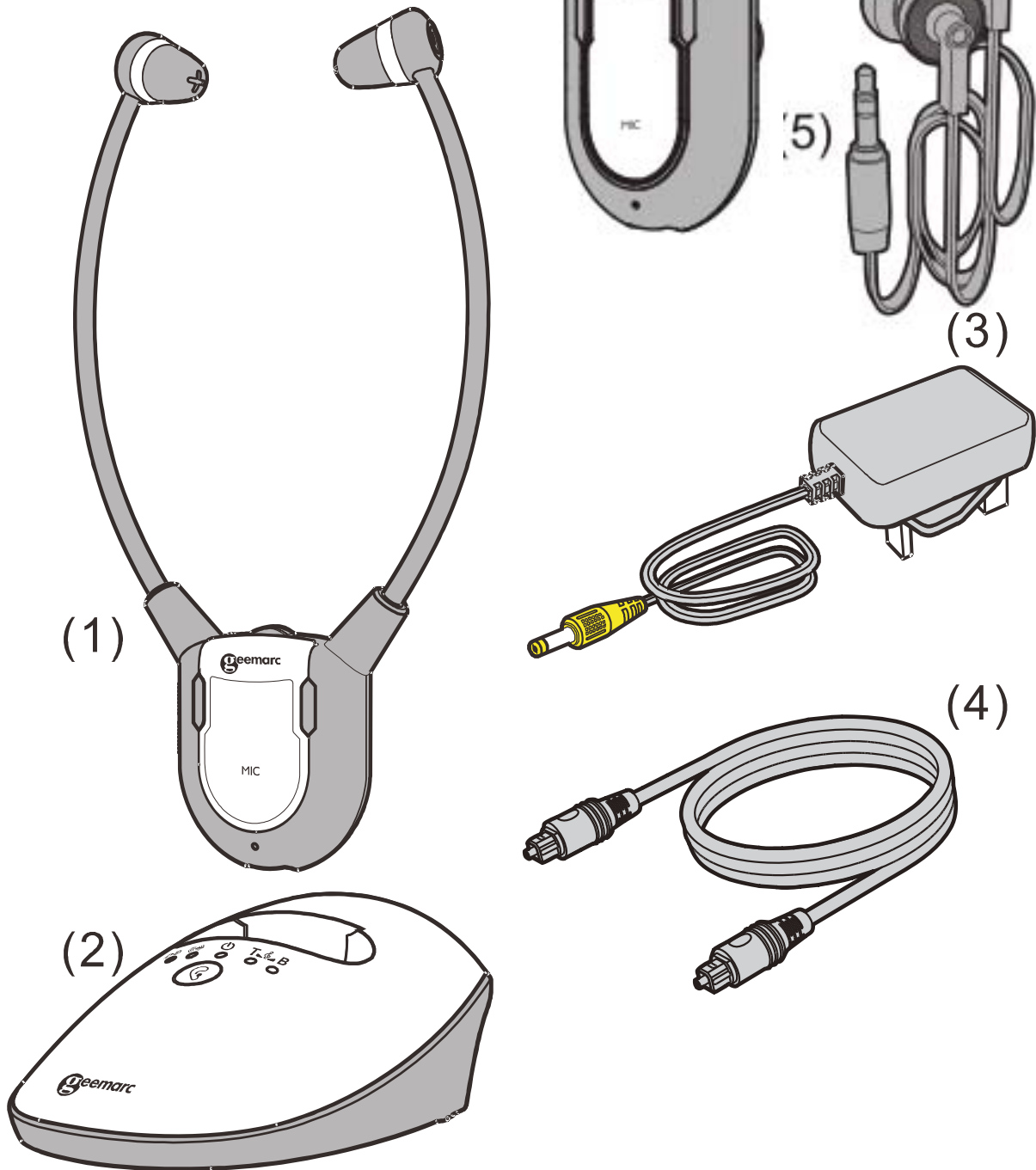

- (1) Headset Receiver/TV Receiver(with Belt Clip)
- (2) Charging Cradle and Transmitter
- (3) Power Supply
- (4) Optical Cable
- (5) Ear Phone

# FUNCTION IDENTIFICATION

## FUNCTION IDENTIFICATION

### Function Identification: Headset Receiver

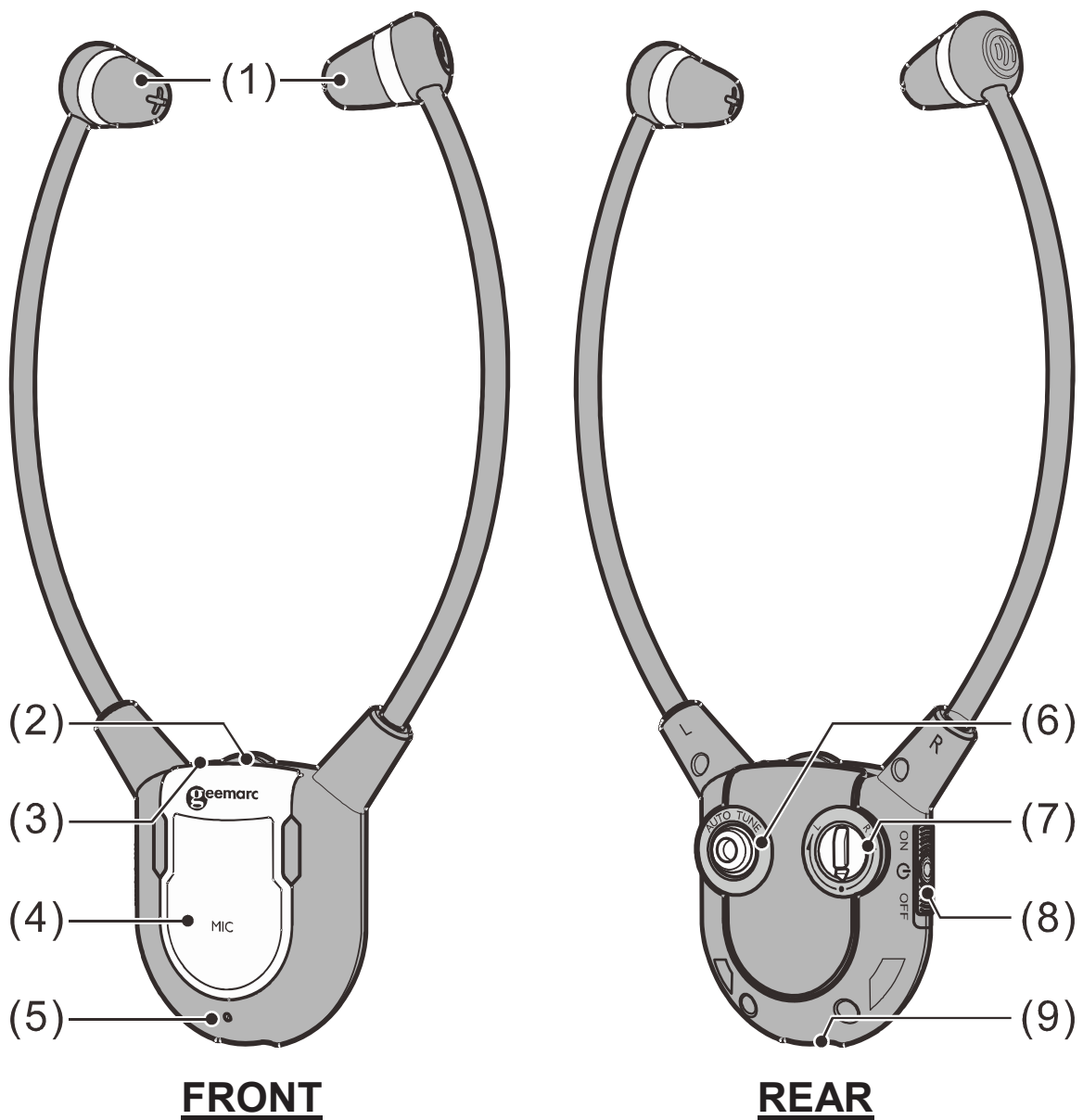

- (1) Earbuds
- (2) Volume Control
- (3) Power/Signal LED Indicator

# FUNCTION IDENTIFICATION

- (4) Mute Button for Verbal Communications
- (5) Microphone
- (6) Auto Tune Button for Frequency Channel
- (7) Sound Balance Control
- (8) Power On/Off Switch
- (9) Battery Contact

## FUNCTION IDENTIFICATION

### Function Identification: TV Receiver

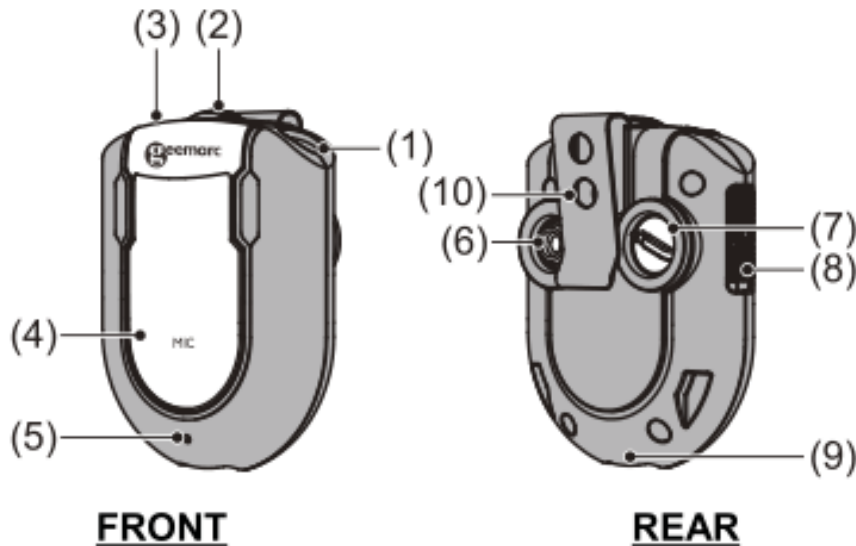

- (1) 3.5mm Audio Line In
- (2) Volume Control
- (3) Power/Signal LED Indicator
- (4) Mute Button for Verbal Communications
- (5) Microphone
- (6) Auto Tune Button for Frequency Channel
- (7) Sound Balance Control
- (8) Power On/Off Switch
- (9) Battery Contact

### Function Identification: Charging Cradle



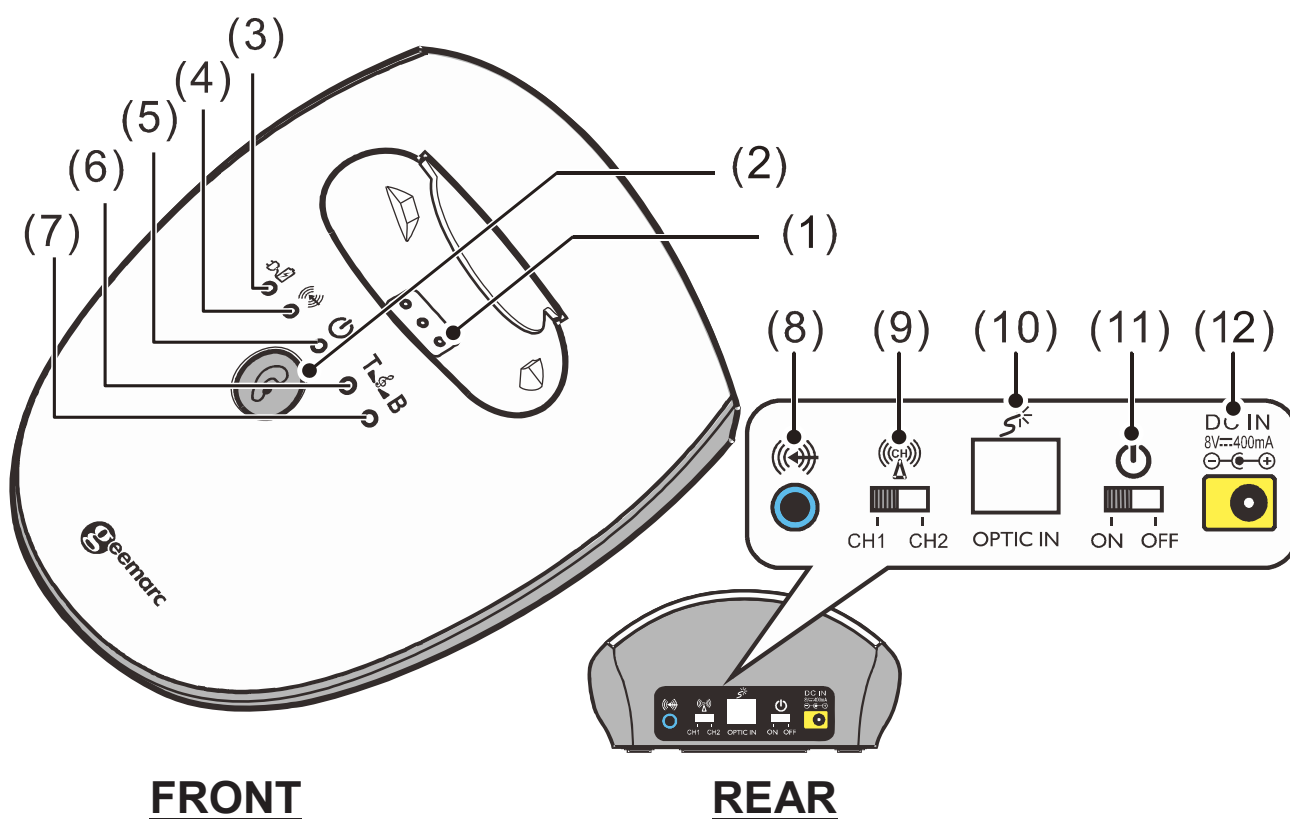

- (1) Charging Pins
- (2) Tone Adjustment
- (3) LED Indicator: Battery Charge (Red = charging, Green = fully charged)
- (4) LED Indicator (Green): Audio Signal
- (5) LED Indicator (Green): Power
- (6) LED Indicator (Yellow): Treble enhanced
- (7) LED Indicator (Blue): Bass enhanced
- (8) Audio In
- (9) Frequency Channel Selector (CH1 or CH2)
- (10) Optical In Socket
- (11) Power ON/OFF
- (12) DC In Socket

## **INSTALLATION**

# INSTALLATION

## Transmitter

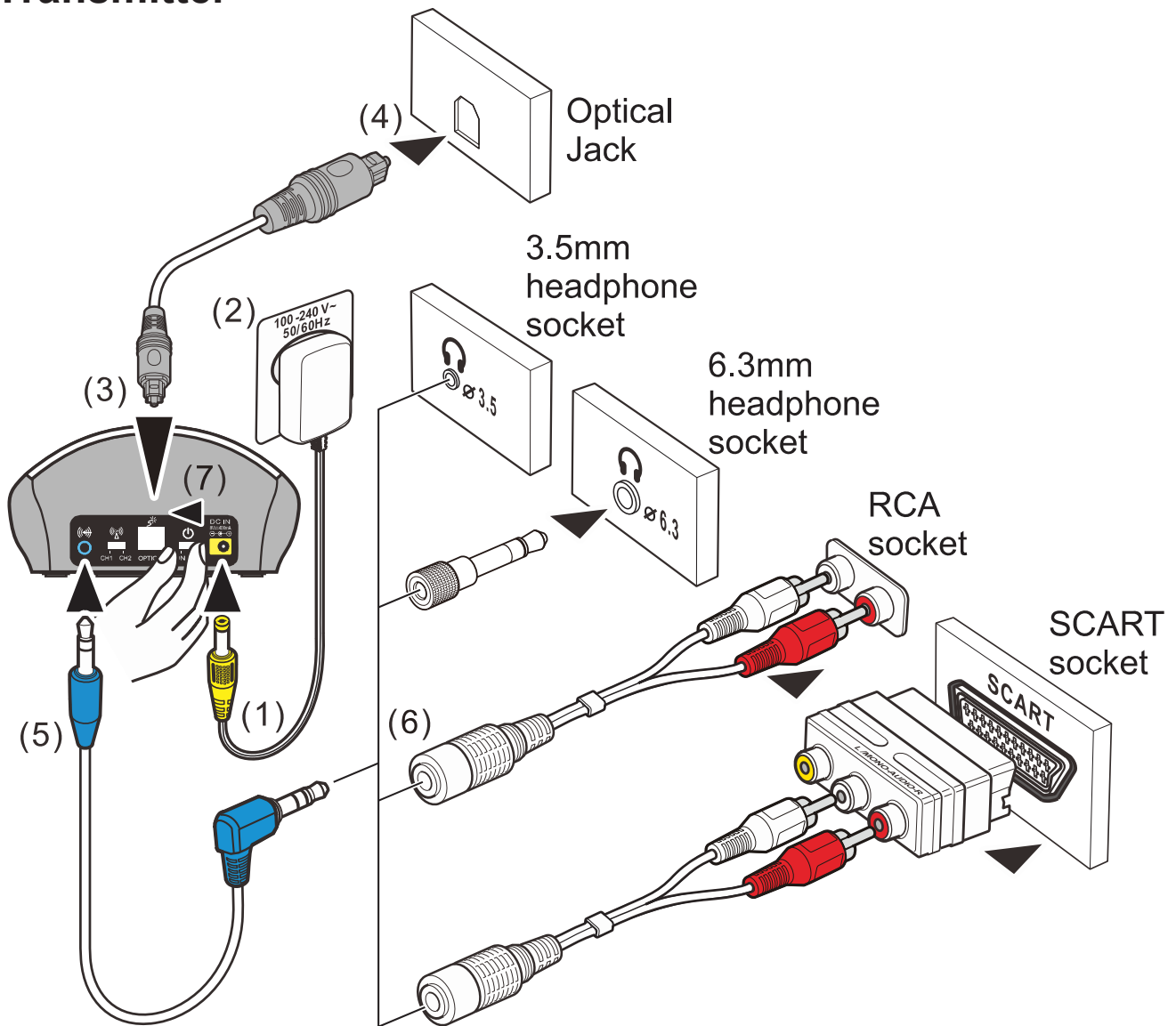

- (1) Connect the Power Supply to the DC IN Socket located on the Charge Cradle rear panel.
- (2) Connect the Power Supply to an electricity socket (100-240V ~ 50/60Hz).  
The green Power Indicator LED will glow immediately.
- (3) Connect one end of the Optical Cable to the rear panel of the Charge Cradle.
- (4) Connect the other end of the Optical Cable to your Audio Source (e.g. TV set, Hi-Fi system) with Optical Output.
- (5) Accessories for items (5) and (6) in above drawing are not provided in the pack components.
- (6) If your Audio Source does not have an optical socket, then use one of the following Adapters(not provided in the pack

components) that connects to the Audio In of the Transmitter.

- 3.5mm to 3.5mm Audio Cable
- 3.5mm to 6.3mm Adapter Plug
- RCA Adapter Cable
- SCART Adapter

(7) On the rear panel of the Charging Cradle, switch the Power ON/OFF Switch to ON.

When the audio signal is detected from the Audio Source, the Green LED Signal Indicator will glow constantly.

## Headset

Make sure the built-in Battery inside the Headset is fully charged for the first use – see Initial Operation below.

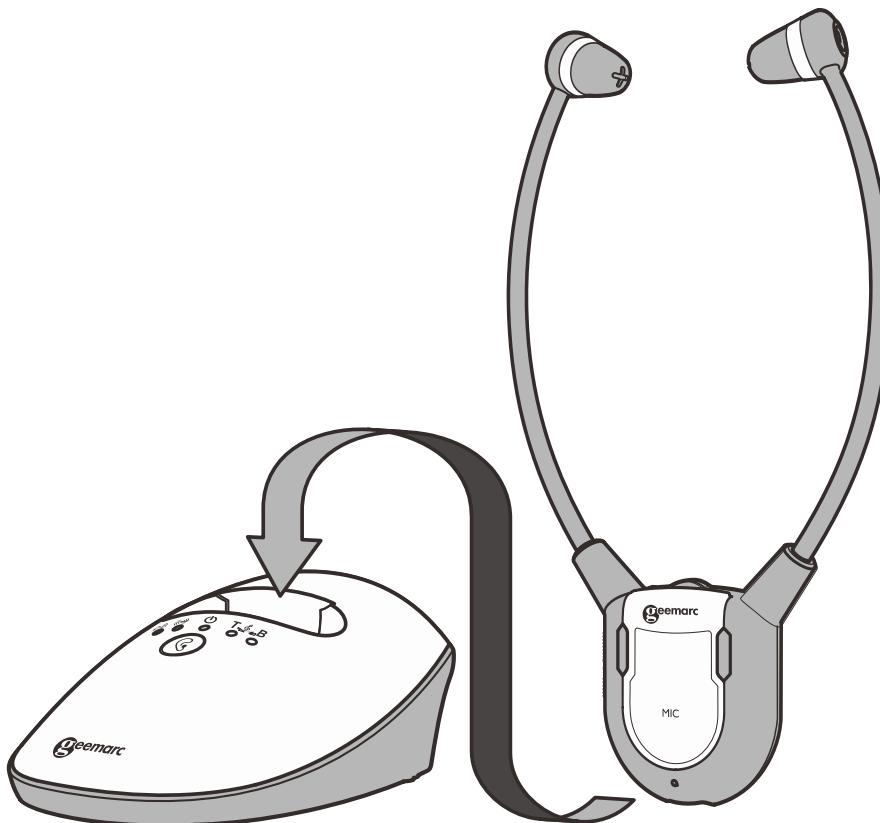

## Initial Operation

1. Make sure the CL7350 is plugged into the electricity.

2. Switch ON the CL7350 – on the rear of the Charging Cradle (see figure (1) at right).

3. Place the Headset in the Charging Cradle for at least three hours to allow it to fully charge.

- Make sure the Headset is switched OFF (see figure (2) at right).
- The LED Indicator glows red during charging.
- It will glow in green after the battery is fully charged (see figure (3) at right).

4. After the three hours have passed and the charging LED has turned green, you can proceed to the Routine Operation.

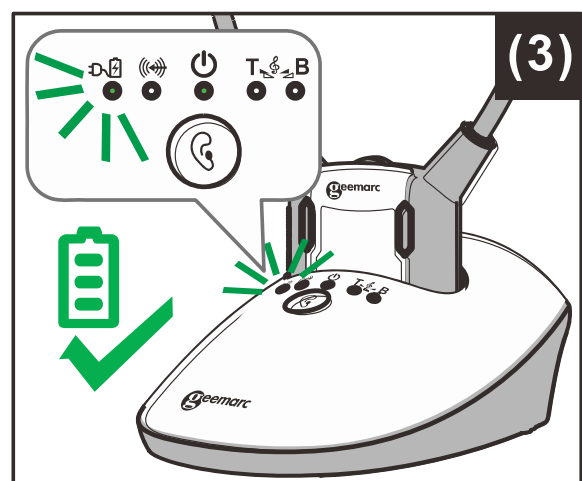
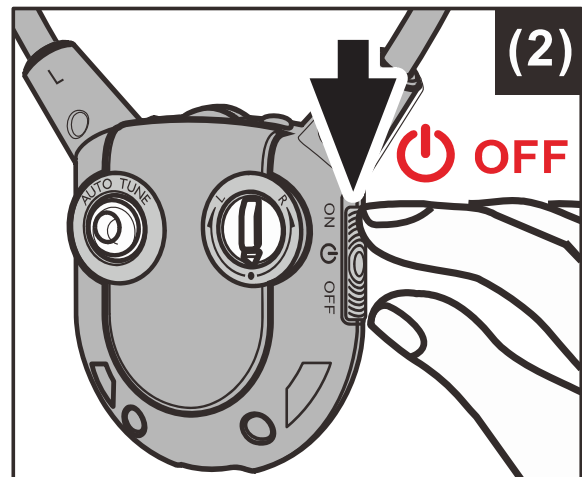
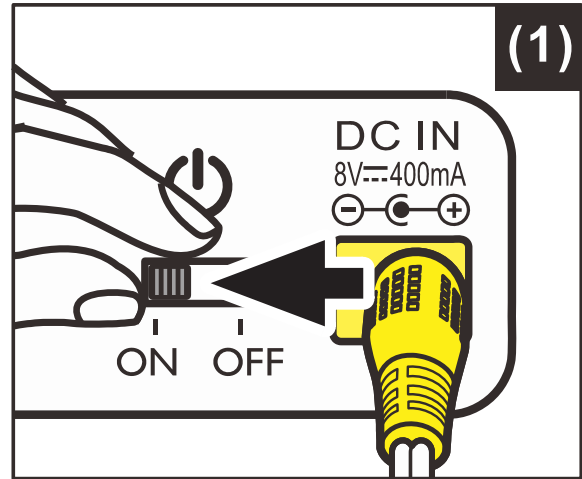

## Routine Operation

1. Switch on the Audio Source (TV set or audio device) that the Transmitter is connected to. The Signal LED Indicator will glow continuously (see figure (4) at right).
2. On the Headset Receiver, switch the ON the On/Off Switch (see figure (5) at right). The green signal LED Indicator will glow continuously.
3. Adjust the Volume to the desired sound level (see figure (6) at right), then fit the Earbuds in your ears.

**NOTE:** Make sure the volume on your Audio Source (TV set or other audio device) is turned up to at least half of its full volume to get good sound quality in your Earbuds.

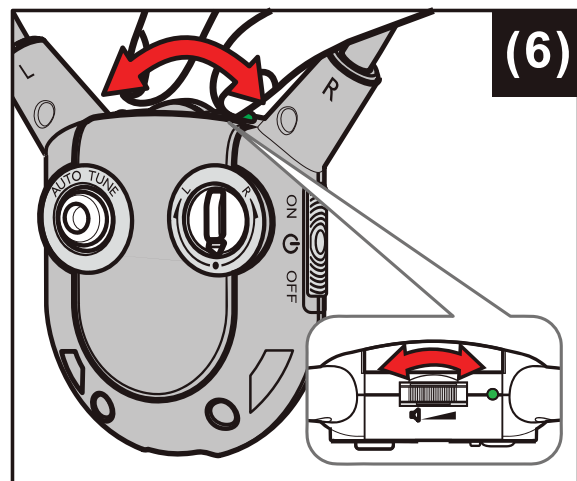
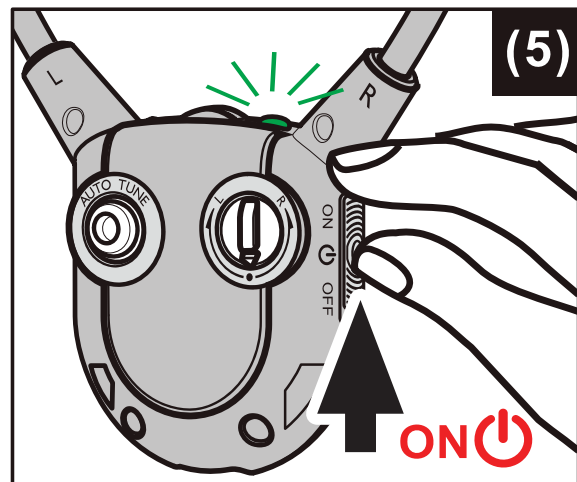
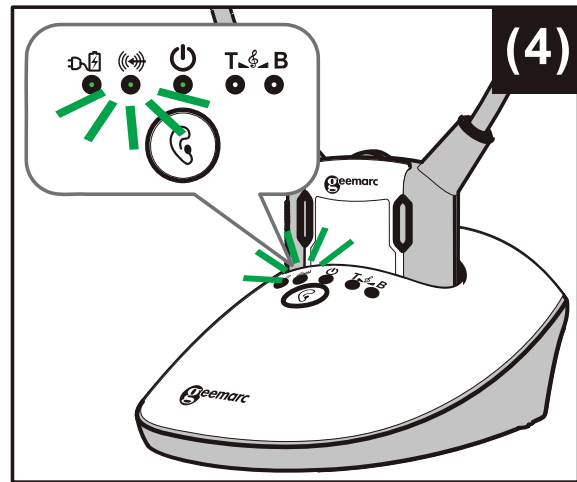

## Improving Sound by Switching Channels

# OPERATION

The CL7350 can transmit on either of two built-in frequency channels. You can select the channel that will produce better audio quality.

1. If the audio sound is distorted or unclear, press the Auto Tune Button on the Headset Receiver (see figure (7) at right), to match the frequency of Channel 1 or Channel 2 set at the back of Transmitter. Allow a few seconds for the audio to resume.

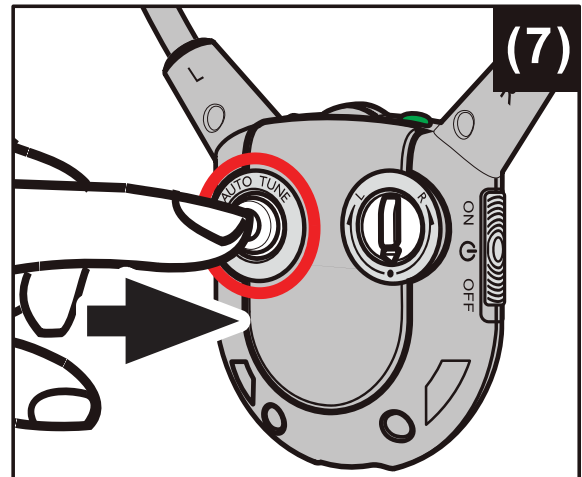

2. If this does not help, switch the channel selector on the rear of the Charging Cradle (see figure (8) at right) and see if the audio quality has improved.

3. Press the Auto Tune button again to improve the quality still further.

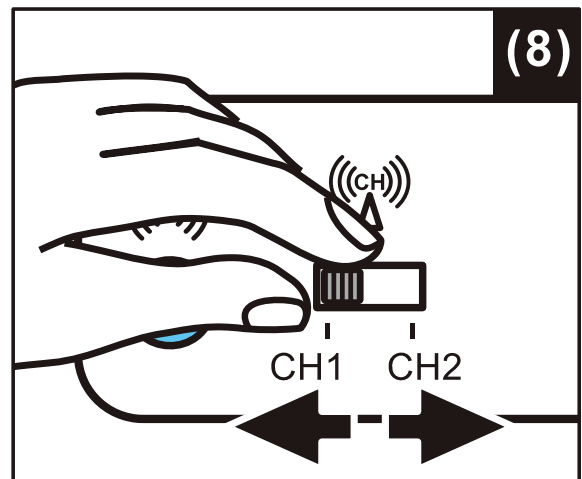







**NOTE:** The Transmitter will turn off automatically about 5 minutes if there is no audio signal from the audio source (TV set, etc.), or the signal from the audio source is too weak for proper reception. However, if the audio signal returns to an acceptable level, the transmission will automatically restart.

## Controlling the Tone (Bass & Treble)

You can adjust the tone of the audio you are listening to and enhance your listening pleasure by amplifying either the Treble or the Bass in the Headset Receiver.

Press the Tone Clarity Button  to switch cyclically between :

1. Enhanced treble (yellow LED glows   ),
2. Enhanced bass (blue LED glows   ), or
3. Flat tone (bass and treble equally enhanced, no LEDs glowing   ).

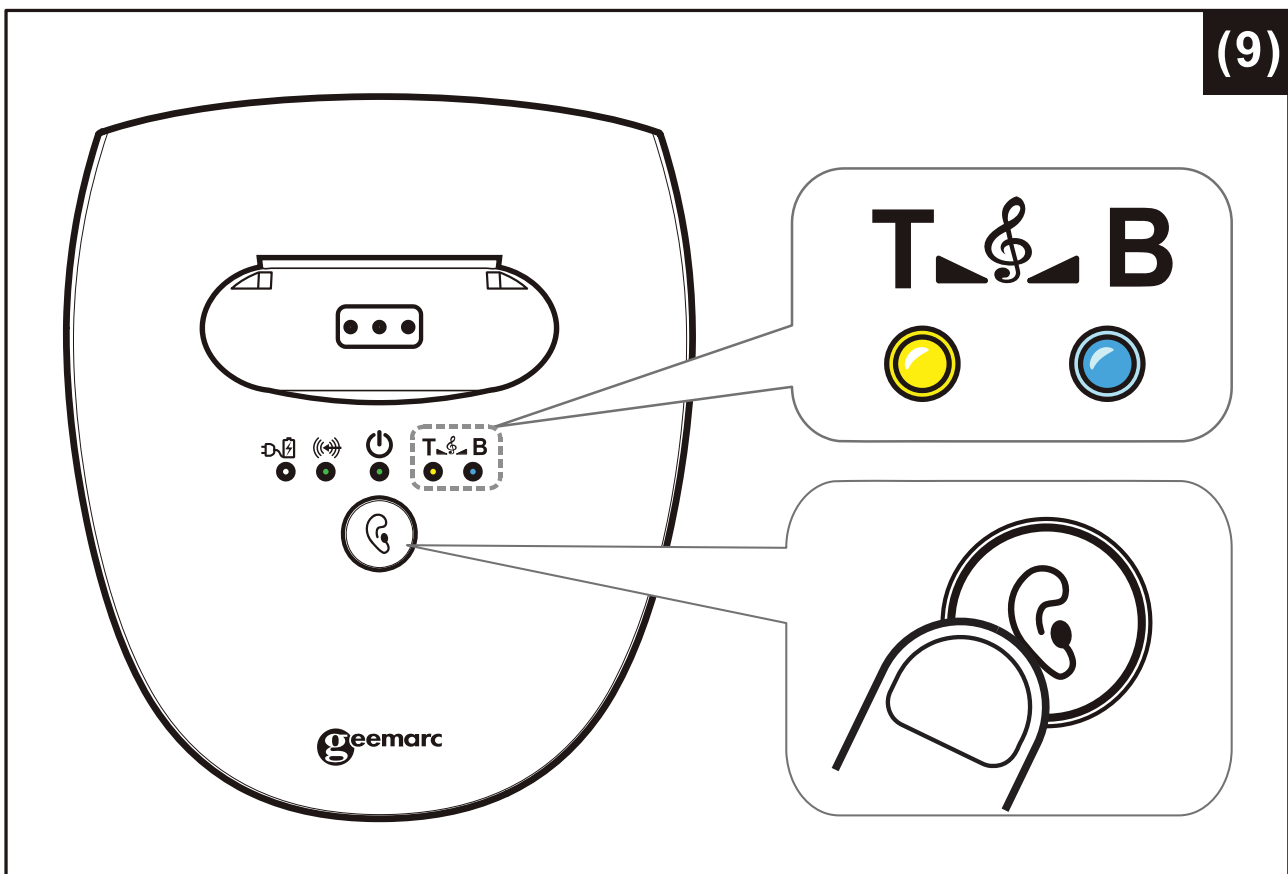

(9)

**Adjusting the Sound Balance (left-right)**

# OPERATION

You can adjust the sound to suit your hearing in each ear.

With the Headset on, rotate the Sound Balance button (see figure (10) at right) to adjust the sound – you will notice that the sound seems to “drift” from one side to the other. Play with this button until you find your most pleasant sound balance.

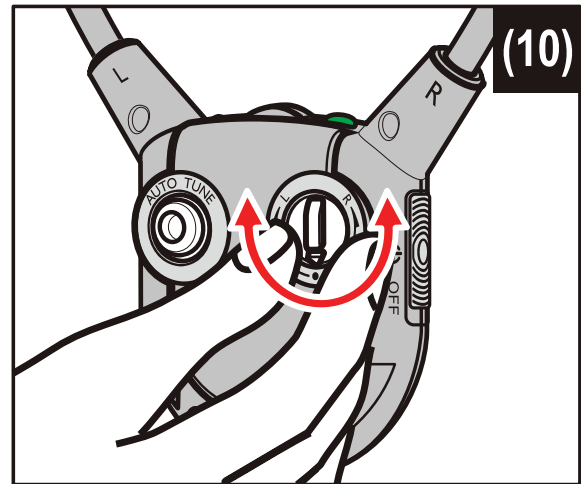

## Using the Mute Button and Microphone for Conversation

You can switch from Listening mode to Conversation mode without having to take off the Headset.

To talk or listen to someone :

1. Press the Mute button (see figure (11) at right). This will shut off the Audio Source and the Headset will become an amplifier by activating the Microphone.
2. To resume listening to your audio device, press the Mute button again. The microphone will be shut off and the audio will resume.

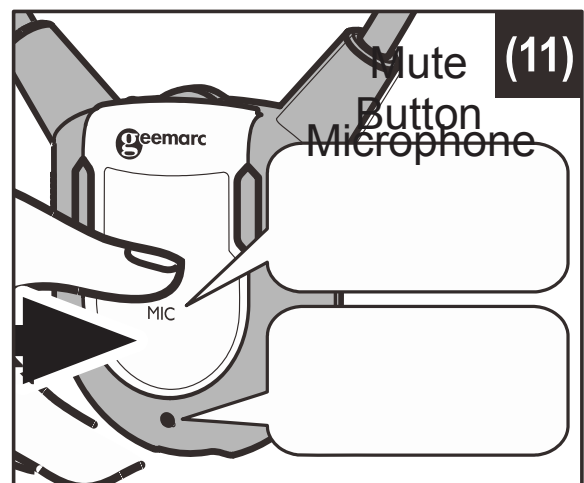

## Charging the Battery



1. The signal LED Indicator on the Headset Receiver will blink slowly when the battery level is low. At this stage there are about 20 minutes of operating time before the Headset will switch off. Recharge the battery.

2. Switch OFF the On/Off Switch on the Headset (see figure (12) at right). The green LED on the Headset should turn off.

3. Place the Headphone on the Charging Cradle (see figure (13) at right), make sure the charge contact touches the charge pins on the Charging Cradle.

4. The Charging process starts automatically.

- The LED Indicator glows red during charging.
- It will glow in green after the battery is fully charged.

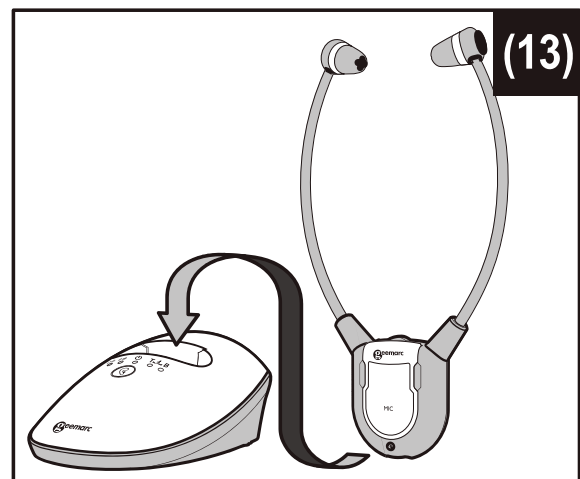
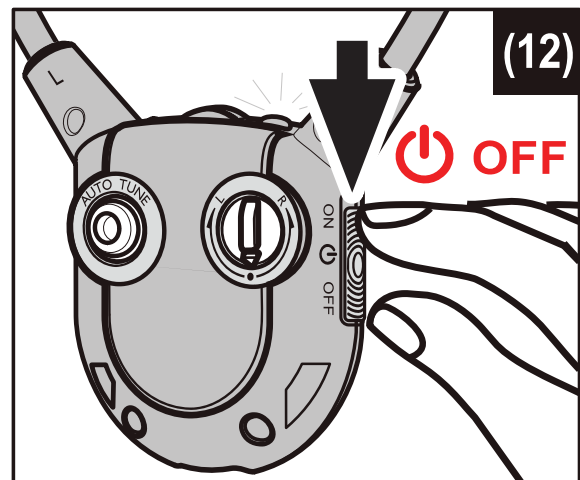

## **WARNING:**

The battery must not be exposed to excessive heat such as sunshine, fire etc.

Do not attempt to replace the original rechargeable battery.

When the headphones are not in use, move the switch to the OFF position to avoid damaging the batteries.

The battery must always be fully charged before first use. An initial 3 hours charge is required to guarantee an

# TECHNICAL SPECIFICATIONS

acceptable service life for the rechargeable battery. Always ensure that the Headphone Receiver is switched to OFF position while the battery are charging.

Excessive sound pressure from earphones and headphones can cause hearing loss.

## **IMPORTANT:**

This unit should be operated with built-in rechargeable battery only. When replacing the battery or when disposing of the unit, always comply with applicable laws relating to the disposal of battery. Please place them in a proper disposal container to ensure that they are eliminated safely and in an environmentally friendly way.

## **TECHNICAL SPECIFICATIONS**

---

# TROUBLESHOOTING

Battery operating Time	: Up to 6 Hours
Range	: Up to 60 meters (CL7350_VDE) : Up to 30 meters (CL7350_US)
Frequency response	: 30 Hz – 10K Hz
Signal-to-noise ratio	: >65 dB
Distortion	: <2%
Headset weight	: 58 grams
Operating voltage	: Charging Cradle: 8V, 400mA : Headset: 3.7V, 350mA Lithium Polymer Battery
Transmission mode	: <b>UHF Stereo</b>
Carrier frequency	: 863MHz (CL7350_VDE) : 900MHz (CL7350_US)

## No Sound

- Ensure the power supply is properly plugged into the electricity socket and that its cable is properly connected to the DC IN connector on the Charge Cradle.
- Ensure that the Headset Power ON/OFF switch is switched ON.
- Check the state of the Battery charging in the Headset – place it in the Charge Cradle and recharge the battery until the Battery Charge LED turns green.
- Ensure that the TV set, Hi-Fi system or audio component is switched ON and set to a channel that broadcasts an audio signal.
- Ensure that the volume on the connected audio component is turned up to at least half its full volume.
- The connected audio/video equipment may not be in playback mode. Start playback on by the equipment.
- Use the Volume Control on the Headset to turn up the volume.
- Check whether the Headset volume level is set too low. Adjust the volume to a suitable level.
- If the sound is not clear and distorted, change the frequency Channel selection on the back of the Charge Cradle, and then press the Auto Tune Button on the Headset Receiver for better reception.

## Distortion

- The battery inside Headset may need charging. Recharge the battery.
- The Headset may be too far away from the transmitter inside the Charge Cradle. Bring them closer together.
- The audio signal input level from the audio source is too low. Increase the volume at the audio source.
- If the sound is not clear and distorted, change the frequency Channel on the back of the Charge Cradle, and then press the Auto Tune Button on the Headset for better reception.

## Cleaning & Maintenance

---

**Note: DO NOT** use alcohol, chemical or spirit based cleaning agents.

Wipe Base and Headset clean with a damp cloth.

Regularly remove (see figure (14) at right) and clean 'Ear pads' with warm soapy water.

Two types of ear pad are supplied, select the most suited to yourself.

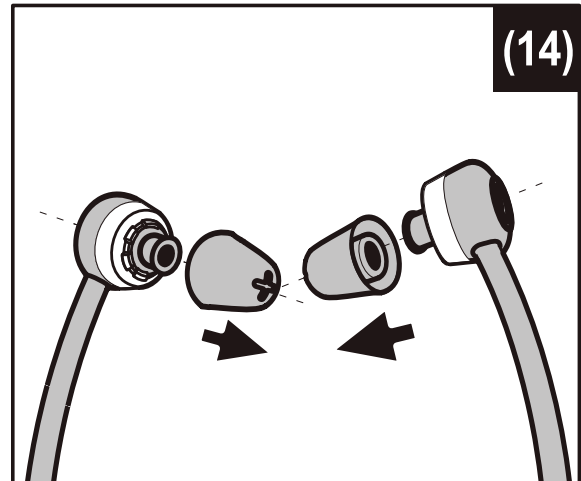

## **Spare/replacement parts**

---

Spare parts are available from either the original place of purchase or by calling the Customer Helpline Telephone:

**01707 387602**

1. Additional Headsets
2. Ear pads

To replace the Headset battery, please contact Customer Support.

## **Customer support**

---

For product support and help, visit our website at [\*\*www.geemarc.com\*\*](http://www.geemarc.com)

For our Customer Helpline Telephone: **01707 387602**

Fax: 01707 832529

## **GUARANTEE**

---

# BATTERY WARNINGS . DISPOSAL INFORMATION

From the moment your Geemarc product is purchased, Geemarc guarantee it for the period of two years. During this time, all repairs or replacements (at our discretion) are free of charge. Should you experience a problem then contact our Helpline or visit our website at [www.geemarc.com](http://www.geemarc.com).

The guarantee does not cover accidents, negligence or breakage to any parts.

The product must not be tampered with or taken apart by anyone who is not an authorised Geemarc representative.

The Geemarc guarantee in no way limits your legal rights.

**Important:** YOUR RECEIPT IS PART OF YOUR GUARANTEE AND MUST BE RETAINED AND PRODUCED IN THE EVENT OF A WARRANTY CLAIM.

**Please note:** The guarantee applies to the United Kingdom only.

## CE DECLARATION

---

Geemarc Telecom SA hereby declares that this product is in compliance with the essential requirements and other relevant provisions of the Radio and Telecommunications Terminal Equipment Directive 2014/53/UE and in particular article 3 section 1a, 1b and section 2.

*The declaration of conformity may be consulted at [www.geemarc.com](http://www.geemarc.com)*



## FCC NOTICE

This device complies with part 15 of the FCC Rules. Operation is subject to the following two conditions:

1. This device may not cause harmful interference, and
2. This device must accept any interference received, including interference that may cause undesired operation.

## FCC CAUTION

Any changes or modifications not expressly approved by the party responsible for compliance could void the user's authority to operate this equipment. This device and its antenna(s) must not be co-located or operating in conjunction with any other antenna or transmitter.



## BATTERY WARNINGS

---

- **DO NOT** attempt to dismantle.
- **DO NOT** dispose of in fire.
- **DO NOT** swallow.
- Keep away from children.
- **DO NOT** short-circuit the Battery Contact terminals.
- Exhausted batteries are to be replaced only by a certified Geemarc service technician.
- **Caution:** Risk of explosion if battery is replaced incorrectly or if the wrong type of battery is used. Dispose of used batteries according to the instructions.



## DISPOSAL INFORMATION

---

### Disposal of old electrical & electronic equipment (applicable in the European Union and other European countries with separate collection systems)



The symbol on the product or its packaging indicates that this product may not be treated as household waste. Instead it should be handed over to the applicable collection point for the recycling of electrical and electronic equipment.

By ensuring this product is disposed of correctly, you will help prevent potential negative consequences for the environment and human health, which could otherwise be caused by inappropriate waste handling of this product.

For more detailed information about recycling this product, please contact your local council office, your household waste disposal service or the shop where the product was purchased.

## IC

This device complies with Industry Canada license - exempt RSS standard(s). Operation is subject to the following two conditions: (1) this device may not cause interference, and (2) this device must accept any interference, including interference that may cause undesired operation of the device.

Le présent appareil est conforme aux CNR d'Industrie Canada applicables aux appareils radio exempts de licence. L'exploitation est autorisée aux deux conditions suivantes: (1) l'appareil ne doit pas produire de brouillage, et (2) l'utilisateur de l'appareil doit accepter tout brouillage radioélectrique subi, même si le brouillage est susceptible d'en compromettre le fonctionnement.

### FCC Statement

NOTE: This equipment has been tested and found to comply with the limits for a Class B digital device, pursuant to part 15 of the FCC Rules. These limits are designed to provide reasonable protection against harmful interference in a residential installation. This equipment generates uses and can radiate radio frequency energy and, if not installed and used in accordance with the instructions, may cause harmful interference to radio communications. However, there is no guarantee that interference will not occur in a particular installation. If this equipment does cause harmful interference to radio or television reception, which can be determined by turning the equipment off and on, the user is encouraged to try to correct the interference by one or more of the following measures:

- Reorient or relocate the receiving antenna.
- Reorient or relocate the receiving antenna.
- Reorient or relocate the receiving antenna.
- Consult the dealer or an experienced radio/TV technician for help important announcement

Important Note:





For product support and help visit our website at

**[www.geemarc.com](http://www.geemarc.com)**

telephone **01707 387602**

or fax **01707 832529**

UGCL7350\_En\_v1.1