

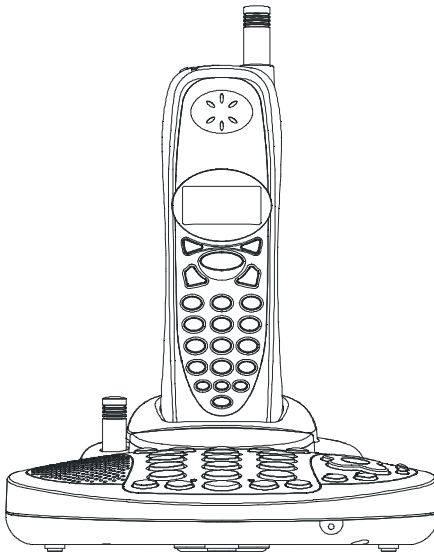

**BELL<sup>®</sup> Phones**  
**BY NORTHWESTERN BELL PHONES**

*Excursion<sup>®</sup> 35828A*

---



Congratulations on your selection of the **Excursion<sup>®</sup> 35828A** model from Northwestern Bell Phones. This quality 5.8GHz 2 lines digital speakerphone cordless telephone with Caller ID on Call Waiting and digital answerer, like all Genuine BELL<sup>®</sup> products, has been designed to give you many years of continuous service and represents the best value for your money. This phone is built on the state-of-the-art Frequency Hopping Digital Spread Spectrum radio communication technology for high quality voice communication and high level of conversation privacy. It requires little maintenance and is easy to setup and operate.

# **IMPORTANT SERVICE INFORMATION**

Read this manual before attempting to setup or use this instrument. It contains important information regarding safe installation and use. Keep this manual for future reference. Also save the carton, packing and proof of purchase to simplify and accelerate any needed action. If you need assistance or service, call (800) 888-8990 between 8:00a.m. and 4:30p.m. Pacific Standard Time, Monday through Friday. You can also visit our web site at: <http://www.nwbphones.com> for technical support and information on our other products.



## **WARNING**

To prevent fire or shock hazard, do not expose this product to rain or any type of excess moisture. If accidentally dropped into water, the adapter should immediately be unplugged from the wall along with the telephone line cord.



## **CAUTION**

To maintain compliance with the FCC' s RF exposure guidelines, place the base unit at least 20cm from nearby persons.

Before you can use your cordless telephone, the handset must be charged for at least 12 hours.



**THIS SYMBOL IS INTENDED TO ALERT THE USER OF THE PRESENCE OF IMPORTANT OPERATING AND MAINTENANCE (SERVICING) INSTRUCTIONS IN THE OWNER' S MANUAL.**



**This device complies with Part 15 of the FCC Rules. Operation is subject to the following two conditions: (1) this device may not cause harmful interference, and (2) this device must accept any interference received, including interference that may cause undesired operation.**

# CARTON CONTENTS

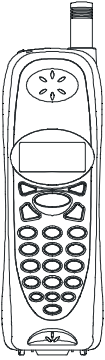

HANDSET x1

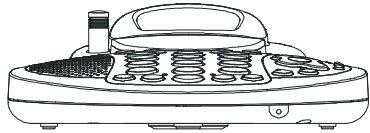

BASE UNIT



RECHARGEABLE  
Ni-MH BATTERY PACK x1



BELT CLIP x1



ADAPTER  
(DC9V, 850mA)



4CONDUCTORS LONG  
LINE CORD x 2



USER' S MANUAL



WARRANTY CARD



ACCESSORY ORDER FORM



## SAVE THESE INSTRUCTIONS

# **IMPORTANT SAFETY INSTRUCTIONS**

When using your telephone equipment, basic safety precautions should always be followed to reduce the risk of fire, electric shock, and injury to persons, including the following:

1. Read and understand all instructions.
2. Keep base unit at least 20cm distance apart from nearby person.
3. Follow all warnings and instructions marked on the product.
4. Unplug this product from the wall outlet before cleaning. Do not use liquid cleaners or aerosol cleaners. Use a damp cloth for cleaning.
5. Do not use this product near water, for example, near a bathtub, washbowl, kitchen sink, laundry tub, in a wet basement or near a swimming pool.
6. Do not place this product on an unstable cart, stand, or table. The product may fall, causing serious damage to the product.
7. Slots and openings in the cabinet at the back or bottom are provided for ventilation, to protect it from overheating. These openings should never be blocked or covered. The openings should never be blocked by placing the product on the bed, sofa, rug, or other similar surface. This product should never be placed near or over a radiator or heat register. This product should not be placed in a built-in installation unless proper ventilation is provided.
8. This product should be operated only from the type of power source indicated on the marking label. If you are not sure of the type of power supply to your home, consult your dealer or local power company.
9. Do not allow anything to rest on the power cord. Do not locate this product where the cord will be abused by persons walking on it.
10. Do not overload wall outlets and extension cords as this can result in the risk of fire or electric shock.
11. Never push objects of any kind into this product through cabinet slots as they may touch dangerous voltage points or short out parts that could result in a risk of fire or electric shock. Never spill liquid of any kind on the product.
12. To reduce the risk of electric shock, do not disassemble this product, but take it to a qualified service contractor when some service or repair work is required. Opening or removing covers may expose you to dangerous voltages or other risks. Incorrect reassembly can cause electric shock when the appliance is subsequently used.
13. Unplug this product from the wall outlet and refer servicing to qualified service personnel under the following conditions:
  - A. When the power supply cord or plug is damaged or frayed.
  - B. If liquid has been spilled into the product.
  - C. If the product has been exposed to rain or water.
  - D. If the product does not operate normally by following the operating instructions. Adjust only those controls that are covered by the operating instructions. Improper adjustments of other controls may result in damage and will often require extensive work by a qualified technician to restore the product to normal operation.
  - E. If the product has been dropped or the cabinet has been damaged.
  - F. If the product exhibits a distinctive change in performance.
14. Avoid using a telephone (other than a cordless type) during an electrical storm. There maybe a remote risk of electric shock from lightning.
15. Do not use the telephone to report a gas leak in the vicinity of the leak.



## **SAVE THESE INSTRUCTIONS** **BATTERY SAFETY INSTRUCTIONS**

### **CAUTION:**

To reduce the risk of fire or injury to persons, read and follow these instructions:

1. Use only the following type and size of handset battery pack:  
Cordless Telephone Battery Pack: DC3.6V, 850mAh, Ni-MH Battery Pack
2. Do not dispose of the battery in a fire. The cell may explode. Check with local codes for possible special disposal instructions.
3. Do not open or mutilate the battery. Released electrolyte is corrosive and may cause damage to the eyes or skin. It may be toxic if swallowed.
4. Exercise care in handling the battery in order not to short the battery with conducting material such as rings, bracelets and keys. The battery or conductor may overheat and cause burns.
5. Recharge only the battery provided with or identified for use with this product. The battery may leak corrosive electrolyte or explode if it is not the correct type.
6. Do not attempt to rejuvenate the battery provided with or identified for use with this product by heating them. Sudden release of the battery electrolyte may occur causing burns or irritation to eyes or skin.
7. When inserting the batteries into this product, the proper polarity or direction must be observed. Reverse insertion of batteries can cause charging that may result in leakage or explosion.
8. Remove the batteries from this product if the product will not be used for a long period of time (several months or more) since during this time the battery could leak in the product.
9. Discard “ dead” batteries as soon as possible since “ dead” batteries are more likely to leak in a product.
10. Do not store this product, or the battery provided with or identified for use with this product, in high-temperature areas. Batteries that are stored in a freezer or refrigerator for the purpose of extending shelf life should be stabilized at room temperature prior to use after cold storage.
11. Disconnect telephone lines before installing batteries.



## **SAVE THESE INSTRUCTIONS** **INSTALLATION PRECAUTIONS**

1. Never install telephone wiring during a lightning storm.
2. Never install telephone jacks in wet locations unless the jack is specifically designed for wet locations.
3. Never touch uninsulated telephone wires or terminals unless the telephone line has been disconnected at the network interface.
4. Use caution when installing or modifying telephone lines.



## FCC NOTICE

The FCC requires that you be advised of certain requirements involving the use of this telephone.

1. This telephone is Hearing Aid Compatible.
2. On the bottom of this equipment is a label that contains, among other information, a product identifier in the form US:AAAEQ##TXXXX. You must, upon request, provide this information to your telephone company. The digits represented by ## in the product identifier indicate the Ringer Equivalency Number (REN) for this equipment. The REN is useful in determining the number of devices you may connect to your telephone line and still have all of these devices ring when your telephone number is called. In most (but not all) areas, the sum of the RENs of all devices connected to one line should not exceed 5. To be certain of the number of devices you may connect to your line as determined by the REN, contact your local telephone company.
3. This equipment complies with 47C FR Part 68 of the FCC rules. On the bottom of this equipment is a label that contains, among other information, the FCC registration number and Ringer Equivalence Number (REN) for this equipment. If requested, provide this information to your telephone company.
4. The REN is useful to determine the quantity of devices you may connect to your telephone line and still have all of those devices ring when your number is called. In most, but not all areas, the sum of the RENs of all devices should not exceed five (5.0). To be certain of the number of devices that you may connect to your line, as determined by the REN, you should call your local telephone company to determine the maximum REN for your calling area.
5. Privacy of communications may not be ensured when using this phone.
6. If your telephone causes harm to the telephone network, the telephone company may discontinue your service temporarily. If possible, they will notify you in advance. But if advance notice is not practical, you will be notified as soon as possible. You will be advised of your right to file a complaint with the FCC.
7. Your telephone company may make changes to its facilities, equipment, operations or procedures that could affect the proper operation of your equipment. If they do, you will be given advance notice so as to give you an opportunity to maintain uninterrupted service.
8. If you experience trouble with the telephone, please contact VTC Service & Manufacturing Co., Inc. at (800) 888-8990 or write to: VTC Customer Service, 16988 Gale Ave., City of Industry, CA 91745 for repair/warranty information. The telephone company may ask you to disconnect this equipment from the network until the problem has been corrected or you are sure that the equipment is not malfunctioning.
9. This equipment may not be used on coin service provided by the telephone company. Connection to party line service is subject to state tariffs. (Contact your state public utility commission or corporation commission for information).
10. **WARNING:** Changes or modifications to this unit not expressly approved by the party responsible for compliance could void the user's authority to operate the equipment.  
**NOTE:** This equipment has been tested and found, complies with the limits for a class B digital device, pursuant to Part 15 of the FCC Rules. These limits are designed to provide reasonable protection against harmful interference in residential installation. This equipment generates, uses and can radiate radio frequency energy. If not installed and used in accordance with the instruction, may cause harmful interference to radio communications. However, there is no guarantee that interference will not occur in a particular installation. If this equipment does cause harmful interference to radio or television reception, which can be determined by turning the equipment off and on, the user is encouraged to try to correct the interference by one or more of the following measure:
  - Increase the separation between the equipment and receiver.
  - Connect the equipment into an outlet on a circuit different from that to which the receiver needed.
  - Consult the dealer of an experienced radio / TV technician for help.
11. USOC jack type is RJ11C, RJ14C and the compatible jack is Part 68 compliance.
12. If your home has specially wired alarm equipment connected to the telephone line, ensure the installation of this cordless phone does not disable your alarm equipment. If you have questions about what will disable alarm equipment, consult your telephone company or a qualified installer.

# TABLE OF CONTENTS

IMPORTANT SERVICE INFORMATION.....	1
CARTON CONTENTS.....	2
IMPORTANT SAFETY INSTRUCTIONS.....	3
BATTERY SAFETY INSTRUCTIONS.....	4
INSTALLATION PRECAUTIONS.....	4
FCC NOTICE.....	5
DESCRIPTION.....	7
MOUNTING POSITION.....	9
BELT CLIP INSTRUCTION.....	10
CONNECTING THE HEADSET.....	10
POWER INSTALLATION.....	11
INITIAL SETUP.....	12
PHONE SETUP OPERATION.....	12
MENU LANGUAGE.....	12
RINGER VOLUME.....	12
RINGER TONE.....	13
AREA CODE.....	13
REGISTERING A HANDSET (handset only).....	13
DEREGISTERING A HANDSET (base only).....	13
TONE/PULSE (base only).....	14
EDIT USERNAME (handset only).....	14
TAD RING COUNT (base only).....	14
TAD DAY/TIME (base only).....	14
TAD PIN SETUP (base only).....	15
DELETE VMWI (base only).....	15
LOAD DEFAULT.....	15
TELEPHONE OPERATION.....	15
CALL STATUS DISPLAY.....	16
TO PLACE A CALL.....	16
TO PLACE ANOTHER CALL DURING A CALL.....	16
TO RECEIVE A CALL.....	16
TO RECEIVE A CALL ON ANOTHER LINE DURING A CALL.....	16
LAST NUMBER REDIAL.....	17
PAGING BETWEEN EXTENSIONS.....	17
INTERCOM WITH OTHER EXTENSION.....	17
RING ON INTERCOM.....	17
QUICK TRANSFER CALL TO OTHER EXTENSION.....	17
TRANSFER CALL AFTER INTERCOM.....	17
CONFERENCE WITH TWO LINE.....	18
TWO EXTENSIONS CONFERENCE WITH ONE LINE.....	18
MIXED MODE DIALING (Temporary Pulse to Tone Dialing).....	18
PAUSE FUNCTION.....	18
FLASH FUNCTION.....	19
OUT OF RANGE WARNING.....	19
LOW BATTERY WARNING.....	19
TELEPHONE KEYPAD CHARACTERS.....	19
PHONEBOOK OPERATION.....	19
SAVING IN THE PHONEBOOK.....	19
VIEWING THE PHONEBOOK.....	20
EDITING NAME AND NUMBER IN THE PHONEBOOK.....	20
PLACING CALLS FROM THE PHONEBOOK.....	20
DELETING A STORED NUMBER IN THE PHONEBOOK.....	20
CALLER ID OPERATION.....	21
INTRODUCTION TO CALLER ID ON CALL WAITING.....	21
RECEIVING NEW CALL.....	22
VIEWING THE CALLER ID LIST.....	22
CALLER ID DISPLAY.....	22
CALL WAITING.....	23
MESSAGE WAITING.....	24
PLACING A CALL FROM THE CALLER LIST.....	24
SAVING NUMBER FROM CALLER LIST TO PHONEBOOK.....	24
SELECTIVE DELETING IN THE CALLER LIST.....	25
DELETING ALL RECORDS IN THE CALLER LIST.....	25
ANSWERER OPERATION.....	25
SETTING THE DAY/TIME STAMP.....	25
RECORDING YOUR OUTGOING MESSAGE.....	25
CHECKING YOUR OUTGOING MESSAGE.....	26
RESTORE TO DEFAULT OGM.....	26
TURNING THE ANSWERER ON/OFF.....	26
SETTING THE RING COUNT.....	26
SETTING REMOTE PIN CODE.....	27
RECORDING A MEMO.....	27
PLAYING OF MESSAGE/MEMO.....	27
HANDSET REMOTE MODE.....	27
LINE REMOTE MODE.....	28
INCOMING CALL SCREENING.....	28
WHEN THE MEMORY IS FULL.....	29
IMPROVING CORDLESS RECEPTION.....	29
MAINTENANCE.....	29
TROUBLESHOOTING.....	29
TECHNICAL INFORMATION.....	31

# DESCRIPTION

## LOCATION OF CONTROLS AND FUNCTION

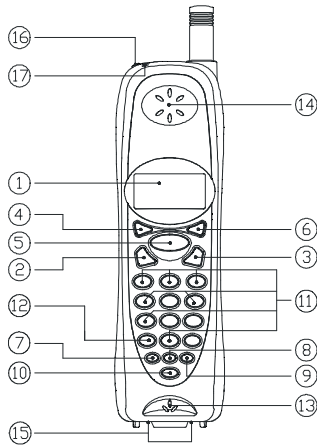

(Figure 1)

### **HANDSET CONTROLS**

1. **LCD Display:** Shows call and line information, phone status, prompts and Phonebook items.
2. **L1 Button/L1-In-Use LED Indicator:** Press this button to answer a line1 incoming call, place a line1 call or end a line1 call; Under this button, there is a dual color LED indicator, the Red LED blinks when you have new line1 CID message(s) or during line1 ringing/paging/on hold, and turn on steadily for line1 Talk mode; the Green LED blinks to indicate message waiting in line1 voice mailbox.
3. **L2 Button/L2-In-Use LED Indicator:** Press this button to answer a line2 incoming call, place a line2 call or end a line2 call; Under this button, there is a dual color LED indicator, the Red LED blinks when you have new line2 CID message(s) or during line2 ringing/paging/on hold, and turn on steadily for line2 Talk mode; the Green LED blinks to indicate message waiting in line2 voice mailbox.
4. **Int./Format Button:** Press this button to page other handset or change caller ID (CID) number format on screen.
5. **Up/Down Button:** Press this button for menu/ caller ID list/ phonebook navigation, or change receiver volume.
6. **Menu/Hold Button:** Press this button to access phone setup options menu or hold the line.
7. **Mute/Del.:** Press this button to temporarily disable the microphone during Talk / Intercom / Conference mode or to delete record/character.
8. **Redial/Pause:** Press this button to redial the last number you have dialed, or to insert pause while dialing.
9. **Mem./Back:** Press this button to go into phonebook mode or to go back to previous menu during menu mode.
10. **Flash/Remote:** Press this button during off hook mode to send a timed line break to phone line to access custom calling features such as Call Waiting or three-way calling provided by your local phone company, or to remote telephone answering device (TAD) during Standby mode, or to perform call screen when TAD is taking message.
11. **TAD Remote Buttons:** Used during TAD remote mode, to playback message, skip to next, back to previous, erase message, turn line1 or line2 TAD off on, and play the voice menu.



12. **Ring Off Button:** Press this button during ringing to temporarily disable the ringer, or set both line1 and line2 ringer to off if pressed during Standby mode.
13. **Microphone:** Used for speaking with callers.
14. **Receiver:** Allows you to hear calls.
15. **Charge Contacts:** Used for charging the handset battery.
16. **Headset Jack:** A jack located on the top of the handset used for connecting your headset to enjoy a hands-free communication.
17. **Ring LED Indicator:** It blinks during line1 or line2 ringing.

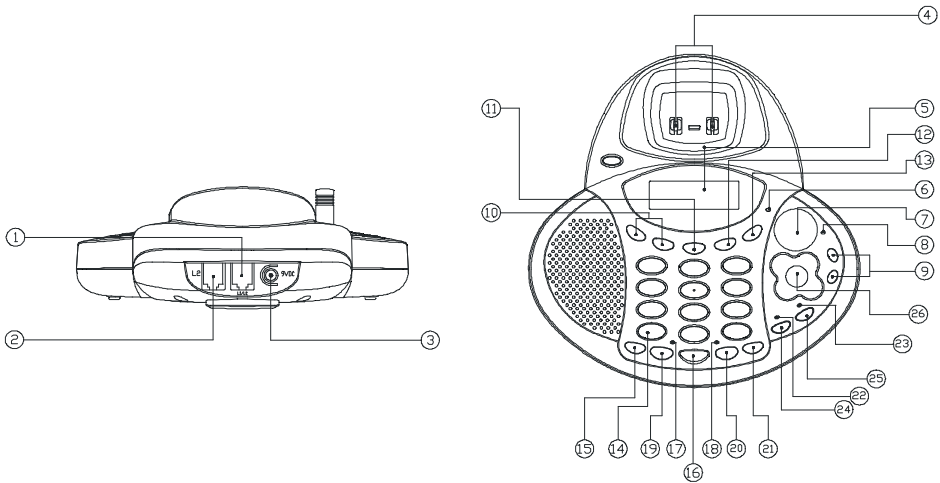

(Figure 2)

### **BASE UNIT CONTROLS**

1. **L1/L2 Telephone Line Jack:** Accepts 4conductors 2lines line cord to make connection with 4conductors 2lines modular type telephone outlet for both lines, or ordinary 2conductors 1line modular type telephone outlet for line1 only.
2. **L2 Telephone Line Jack:** Accepts 2conductors 1lines line cord to make connection with 2conductors 1lines modular type telephone outlet for line2.
3. **9VDC Adapter Jack:** A jack located on the bottom of the base unit used for connecting the adapter to the base unit.
4. **Charge Terminals:** Used for charging the handset battery.
5. **LCD Display:** Shows call information, phone status, prompts and Phonebook items.
6. **Charge LED Indicator:** Light up steadily when the handset is being charged on the base.
7. **Dual 7segment LED Indicator:** Shows the number of new message(s) and/or total message(s) stored for both lines.
8. **New TAD Msg LED Indicator:** It blinks to indicate there is new message(s) stored in the TAD for both lines.
9. **Vol.+/- Buttons:** Allows you to increase or decrease the speaker volume during TAD mode, Talk / Intercom / Conference mode.
10. **Up/Down Button:** Press this button for menu/ caller ID list/ phonebook navigation, or change speaker volume.

11. **Int./Format/Prog. Button:** Press this button to page handset or change CID number format on screen, or when you are registering a new handset to the base.
12. **Mem./Back:** Press this button to go into phonebook mode or to go back to previous menu during menu mode.
13. **Mute/Del.:** Press this button to temporarily disable the microphone during Talk / Intercom / Conference mode or to delete record/character.
14. **Ring Off Button:** Press this button during ringing to temporarily disable the ringer, or set line1 and line2 ringer to off if pressed during Standby mode.
15. **Redial/Pause:** Press this button to redial the last number you have dialed, or to insert pause while dialing.
16. **Menu/Hold Button:** Press this button to access phone setup options menu or hold the line.
17. **L1-In-Use LED Indicator:** This is a dual color LED indicator, the Red LED blinks when you have new line1 CID message(s) or during line1 ringing/paging/on hold/branch phone in use, and turn on steadily for line1 Talk mode; the Green LED blinks to indicate message waiting in line1 voice mailbox.
18. **L2-In-Use LED Indicator:** This is a dual color LED indicator, the Red LED blinks when you have new line2 CID message(s) or during line2 ringing/paging/on hold/branch phone in use, and turn on steadily for line2 Talk mode; the Green LED blinks to indicate message waiting in line2 voice mailbox.
19. **L1 Button:** Press this button to answer a line1 incoming call, place a line1 call or end a line1 call.
20. **L2 Button:** Press this button to answer a line2 incoming call, place a line2 call or end a line2 call.
21. **Flash Button:** Press this button during off hook mode to send a timed line break to phone line to access custom calling features such as Call Waiting or three-way calling provided by your local phone company.
22. **L1 Ans. On/Off LED Indicator:** It turn on steadily during line1 TAD answer on mode.
23. **L2 Ans. On/Off LED Indicator:** It turn on steadily during line2 TAD answer on mode.
24. **L1 Ans. On/Off Button:** Press this button to switch the line1 TAD to answer on/off mode.
25. **L2 Ans. On/Off Button:** Press this button to switch the line2 TAD to answer on/off mode.
26. **TAD Operation Buttons:** Press these buttons to operate the answerer to playback message, skip to next message, repeat current message, back to previous message, erase current message, erase all old message(s), record line1 or line2 welcome message and record memo. message.

## MOUNTING POSITION

### DESKTOP USE:

If you have a 4 conductors dual line telephone wall jack, use the bundled telephone line to connect the L1/L2 line jack to the dual line wall jack, the 2lines connection is completed.

If you have 2 seperated single line telephone wall jack, use the bundled telephone lines to connect the corresponding L1/L2 line jack and L2 line jack to the 2 seperated wall jacks, then the 2lines connection is completed.

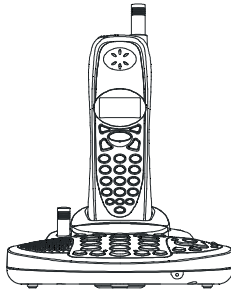

(Figure 3)

## **BELT CLIP INSTRUCTION**

Remove the belt clip cover and clamp the belt clip to the back of the handset as shown in Figure 4.

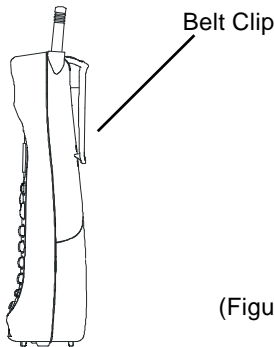

(Figure 4)

## **CONNECTING THE HEADSET**

For hands free conversation, a headset (not included) is connected to the headset jack as shown in Figure 5. The handset receiver and microphone are disabled when the headset is connected.

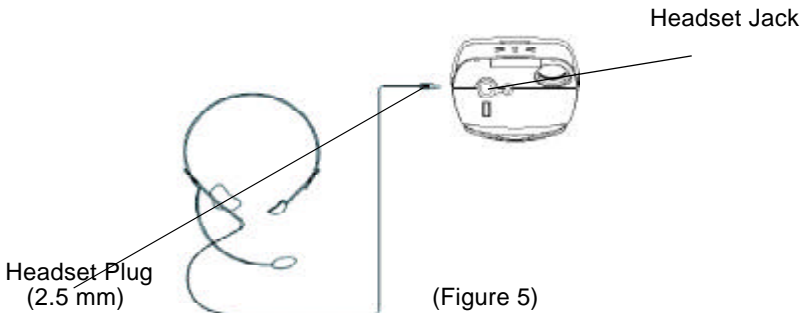

(Figure 5)

Press the L1 or L2 button to answer or place a call of corresponding line using the headset. Refer to the manufacturer's headset manual for more details.

**Consult your service center or authorized local distributor for purchase an suitable headset which authorized to use with this telephone by UL is required. For servicing or replacement, please contact us for suitable headset.**

# **POWER INSTALLATION**

## **BASE UNIT POWER CONNECTION**



### **CAUTION:**

You must use a Class 2 Power Source 9VDC 850mA. The plug must correctly fit the base unit's adapter jack.

1. Plug the adapter into a standard AC outlet.
2. Insert the small plug into the adapter jack on the rear of the base as shown in Figure 6.

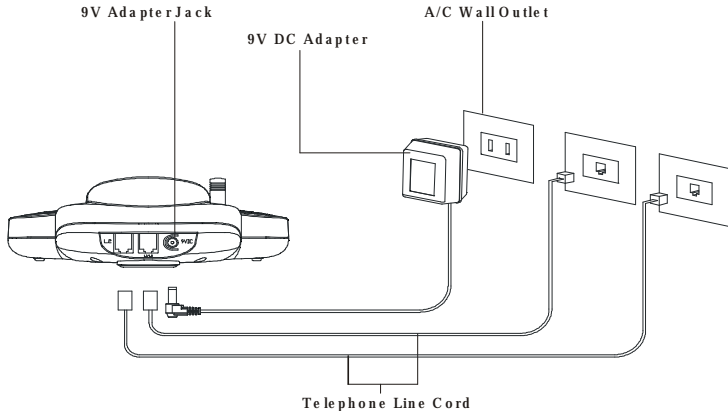

(Figure 6)

## **HANDSET BATTERY INSTALLATION**



### **CAUTION:**

Use only the Nickel Metal Hydride (Ni-MH) battery type included with this unit. Use of other battery types may cause injuries or damage. Ensure to insert the correct battery polarity as shown on the battery compartment during the battery installation.

1. Remove the battery compartment cover of the handset by pressing the top of the cover and sliding it down.
2. Connect the rechargeable Ni-MH battery as shown on Figure 7.

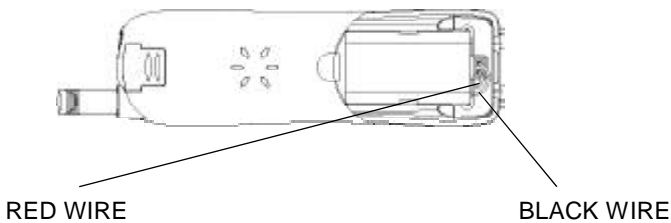

(Figure 7)

3. Insert the Ni-MH battery into the battery compartment of the handset.
4. Slide the battery compartment cover firmly in its closed position

# **INITIAL SETUP**

Before you can use your cordless telephone, the handset must be charged for at least 12 hours.

## **PHONE SETUP OPERATION**

This unit contains the following special setup options in the setup menu, which is brought up by pressing the MENU button during Standby mode. Most of the setup options in handset and base are the same while only some of them are different as they only appear in handset or in base setup menu:

**MENU LANGUAGE**  
**RINGER VOLUME**  
**RINGER TONE**  
**AREA CODE**  
**REGISTRATION (handset only)**  
**EDIT USERNAME (handset only)**  
**tone/PULSE (base only)**  
**TAD RING COUNT (base only)**  
**TAD DAY/TIME (base only)**  
**TAD PIN SETUP (base only)**  
**DELETE VMWI (base only)**  
**DEREGISTRATION (base only)**  
**LOAD DEFAULT**

### **MENU LANGUAGE**

This telephone offers English, Spanish and French languages for your convenience.

1. During Standby mode, press MENU button;
2. Press MENU button;
3. Press UP or DOWN button to select the language you desire (English is the preset language);
4. Press MENU button to save the setting;
5. Press BACK button to go back to Standby mode.

### **RINGER VOLUME**

This telephone offers each line 4 ringer options for user to select, they are level high, medium, low, off.

1. During Standby mode, press MENU button;
2. Press DOWN button until “ RINGER VOLUME” option is pointed by the pointer;
3. Press MENU button;
4. Press UP or DOWN button to select the line1 ringer volume level you desire;
5. Press MENU button to advance to line2 setting;
6. Press UP or DOWN button to select the line2 ringer volume level you desire;
7. Press MENU button to save the setting;
8. Press BACK button to go back to Standby mode.

**NOTE:** When ringer off is selected, all incoming call alert will be silent. You can also engage line1 and line2 ringer off by one touch, press and hold the \*/Ring off button during Standby mode, screen will prompt “ L1 , L2 RINGER ARE OFF! ” . You can also turn ringer off temporarily during ringing, press once the \*/Ring Off button to turn ringer silent.

## RINGER TONE

This telephone offers each line 5 ringer tones for user to select.

1. During Standby mode, press MENU button;
2. Press DOWN button until “ RINGER TONE” option is pointed by the pointer;
3. Press MENU button;
4. Press UP or DOWN button to select the line1 ringer tone (1-5) you desire;
5. Press MENU button to advance to line2 setting;
6. Press UP or DOWN button to select the line2 ringer tone (1-5) you desire;
7. Press MENU button to save the setting;
8. Press BACK button to go back to Standby mode.

**NOTE:** once a ringer tone (1~5) is selected on either of the lines, the same ringer tone will be skipped automatically on another line during selection.

## AREA CODE

This telephone allows you to input your local area code of each line, during CID list review mode, LAC will be hidden in default display mode of the matched LAC case.

1. During Standby mode, press MENU button;
2. Press DOWN button until “ AREA CODE” option is pointed by the pointer;
3. Press MENU button;
4. Press 3 digits local area code;
5. Press MENU button to advance to line2 setting;
6. Press 3 digits local area code;
7. Press MENU button to save the setting;
8. Press BACK button to go back to Standby mode.

## REGISTERING A HANDSET *(applicable to handset only)*

If your handset is not registered to a base unit, or you found problem when making communication with the base unit, you can register the handset to your base once more unconditionally.

1. During Standby mode, press MENU button on the handset;
2. Press DOWN button until “ REGISTRATION” option is pointed by the pointer;
3. Press MENU button to select registration option;
4. Press MENU button to select registration of own handset;
5. Press MENU button to confirm;
6. Press and hold base unit PROG button until handset beeps;
7. Press numeric keypad to enter username by multi-tap input (max. 15characters);
8. Press MENU button to save the input.

**NOTE:** for the operation of multi-tap input, please refer to Telephone Keypad Characters section for more detail.

**NOTE:** if you found communication problem with the base in more than one handset, please try to deregister all handsets using the following procedures and register those handsets one by one using the procedure described in **REGISTERING A HANDSE** section above.

## DEREGISTERING ALL HANDSETS

1. Press and hold the PROG button until Charge LED blinks slowly (like registration);
2. Release button and then press and hold the PROG button again until Charge LED blinks quickly;
3. Release button and press once quickly the PROG button again, when all deregistration procedures are completed, base will show “ ALL HANDSETS DEREGISTERED” and handsets will show “ REGISTER HANDSET?” .

## DEREGISTERING A HANDSET *(applicable to base unit only)*

If you want to move a handset to work with another 35828A base, you can deregister the handset from current base and then register to another base unit.

1. During Standby mode, press MENU button on the base unit;
2. Press DOWN button until “ DEREGISTRATION” option is pointed by the pointer;
3. Press MENU button;
4. Press UP or DOWN button to select the target deregistration handset you desire;
5. Press MENU button to select deregistration option;
6. Press MENU button again to confirm;
7. When deregistration is completed, handset will show “ REGISTER HANDSET?”

**TONE/PULSE** *(applicable to base unit only)*

This telephone allows you to dial digits using the tone signaling mode or the old pulse signaling mode.

1. During Standby mode, press MENU button on the base unit;
2. Press DOWN button until “ TONE / PULSE” option is pointed by the pointer;
3. Press MENU button;
4. Press UP or DOWN button to select the dial signaling mode you desire (Tone is the preset mode);
5. Press MENU button to save the setting;
6. Press BACK button to go back to Standby mode.

**EDIT USERNAME** *(applicable to handset only)*

This telephone allows you to input your username which to be displayed during Standby mode and paging.

1. During Standby mode, press MENU button;
2. Press DOWN button until “ EDIT USERNAME” option is pointed by the pointer;
3. Press MENU button;
4. Press numeric keypad to enter username by multi-tap input (max. 15characters);
5. Press MENU button to save the input;
6. Press BACK button to go back to Standby mode.

**NOTE:** for the operation of multi-tap input, please refer to Telephone Keypad Characters section for more detail.

**TAD RING COUNT** *(applicable to base unit only)*

This TAD offers each line 3 ring count options for user to select, they are 3 rings, 5 rings, TS (TOLL SAVE).

1. During Standby mode, press MENU button on the base unit;
2. Press DOWN button until “ TAD RING COUNT” option is pointed by the pointer;
3. Press MENU button;
4. Press UP or DOWN button to select your desired line1 no. of rings to answer call by TAD (TOLL SAVE is the preset option);
5. Press MENU button to advance to line2 setting;
6. Press UP or DOWN button to select your desired line2 no. of rings to answer call by TAD (TOLL SAVE is the preset option);
5. Press MENU button to save the setting;
6. Press BACK button to go back to Standby mode.

**NOTE:** When TOLL SAVE option is selected, the TAD will answer the call after 3 rings if there is new message(s) stored while it will answer the call after 5 rings if there is no new message stored.

**TAD DAY/TIME** *(applicable to base unit only)*

This TAD allows you to set the day and time running in the unit and this information is stamp to the voice message recorded.

1. During Standby mode, press MENU button on the base unit;
2. Press DOWN button until “ TAD DAY / TIME” option is pointed by the pointer;

3. Press MENU button;
4. Press UP or DOWN button to select the day of week and then press MENU to confirm;
5. Press numeric keypad to enter time in 12hour format;
6. Press UP or DOWN button to select AM/PM;
7. Press MENU button to save the setting;
8. Press BACK button to go back to Standby mode.

**NOTE:** if day/time is not set, the LCD lower row will blink and dual 7segment LED digit will show “ CL” , and no day/time stamp for those message(s) recorded during day/time is not set. You must input the day/time again if A/C power interruption is occurred.

#### **TAD PIN SETUP** *(applicable to base unit only)*

This TAD allows you to input your desired TAD remote PIN code. This PIN code is used when call in to operate the TAD from a remote phone.

1. During Standby mode, press MENU button on the base unit;
2. Press DOWN button until “ TAD PIN SETUP” option is pointed by the pointer;
3. Press MENU button;
4. Press 3 digits new PIN code (Preset PIN code is 777);
5. Press MENU button to save the setting;
6. Press BACK button to go back to Standby mode.

#### **DELETE VMWI** *(applicable to base unit only)*

This telephone allows you to force the both lines’ VMWI indicator to off (stop blinking only, not to turn off VMWI feature) if desired.

1. During Standby mode, press MENU button on the base unit;
2. Press DOWN button until “ DELETE VMWI” option is pointed by the pointer;
3. Press MENU button to confirm;
4. The screen show “ LINE1 & LINE2 VMWI DELETED!” and the VMWI indicators will stop blinking immediately;
5. Press BACK button to go back to Standby mode.

#### **LOAD DEFAULT**

This telephone allows you to restore the phone setup options back to factory default. The Load Default action will cause Menu Language back to English, both lines’ Ringer Volume back to Medium, Line1 Ringer Tone back to Tone 1, Line2 Ringer Tone back to Tone 2, both lines’ Area Code erased, handset ear piece volume back to Vol.2, base speakerphone volume back to Vol.4, Tone/Pulse mode back to Tone, both lines’ TAD ring count back to Toll Save, TAD PIN back to 777, both lines’ TAD status back to Answer On.

1. During Standby mode, press MENU button;
2. Press UP button;
3. Press MENU button;
4. Press UP button to select YES;
5. Press MENU button to confirm Load Default;
6. Press BACK button to go back to Standby mode.

## **TELEPHONE OPERATION**

*This telephone is having a general display timeout of 60 seconds, information like menu items, caller ID, phonebook items, caller log, etc. will be displayed for this period, one can press the BACK button to cancel the display before this timeout.*

**NOTE:** same procedure about call handling is applicable to both handset and base unless specified.



## CALL STATUS DISPLAY

At the LCD lower row, the call duration timer is shown at the left while the volume is shown at the right, the call status of both lines are displayed at the middle of the lower row.

- “ L1” indicates line1 is in normal conversation mode;
- “ L2” indicates line2 is in normal conversation mode;
- “ H1” indicates line1 is on hold;
- “ H2” indicates line2 is on hold;
- “ M1” indicates line1 conversation is in mute mode;
- “ M2” indicates line2 conversation is in mute mode;
- “ C1C2” indicates line1 and line2 are connected to 2 lines conference mode;

## TO PLACE A CALL

1. To make line1 call, press the L1 button. The call timer starts to count. “ L1” is shown on the LCD to indicate the call status. Base unit L1-IN-USE LED indicator will light up.
2. Listen for a dial tone and dial the telephone number.
3. When finished with your call, press the L1 button again (or place the handset on the base/charge cradle to engage auto-standby feature).

## TO PLACE ANOTHER CALL DURING A CALL

1. When having a conversation on line1, you may make a call on line2, press the HOLD button to put line1 call on hold, “ H1” is shown on the LCD to indicate the call status. L1-IN-USE LED indicator will blink to indicate hold status. Press the L2 button to get line2 dial tone, “ H1L2” is shown on the LCD to indicate the call status.
2. Dial the telephone number and make your conversation on line2 while keeping line1 on hold.
3. Now you can switch between lines, press the HOLD button to put line2 on hold, then press L1 button to back to line1 conversation, “ L1H2” is shown on the LCD. (to switch line, one may press HOLD to put the current line on hold then the opposite line button to connect to that conversation)
4. When finished with your current call, say line1 is currently connected, press the L1 button to end line1. To end the line2 call, press HOLD or L2 button to back to line2 conversation, then you can press L2 button to end line2.

## TO RECEIVE A CALL

1. When line1 rings, press the L1 button to answer the call (or you can pick up the handset from the base/charge cradle to let auto-answer feature works for you) and start your conversation. “ L1” is shown on the LCD to indicate the call status.
2. To end your conversation, press the L1 button again. The L1-IN-USE LED indicator will turn off.

**NOTE:** If you are expecting incoming calls, you will hear the ring tone on handset or base only if their respective ringer volume setting of that line is NOT set to OFF mode. There is always fast blinking at the L1-IN-USE/L2-IN-USE LED respectively indicating the ringing.

## TO RECEIVE A CALL ON ANOTHER LINE DURING A CALL

1. During line1 conversation, if a line2 call comes in, short beep alert will be heard at receiver, you may press HOLD button to put line1 call on hold and then press L2 button to answer the line2 call. “ H1L2” is shown on the LCD to indicate the call status.
2. To switch between lines or end your conversation(s), please refer to step 3 and 4 of “ **TO PLACE ANOTHER CALL DURING A CALL**” section for details respectively.

## **LAST NUMBER REDIAL**

1. If you get a busy tone on line1, press L1 button to hang up.
2. Press the L1 button again and listen for a dial tone.
3. Press the REDIAL button. This will automatically redial the last telephone number you called (Redial can store up to 32 digits).
4. When finished with your call, press the L1 button on handset or place the handset on the base/charge cradle (or the L1 button again for base unit case). The L1-IN-USE LED indicator will turn off.

## **PAGING BETWEEN EXTENSIONS**

1. Press INT button on the extension unit.
2. Press digit button 0~8 to input destination extension number (extension 0 is the base unit, extension 1~8 is the handsets).
3. Destination extension unit beeps, and will show the paging source extension information like name or extension number. The page signal will last for 2minutes and then stops.

**NOTE:** Paging can be done during Standby mode or Call is on hold. But page to a busy handset will fail.

## **INTERCOM WITH OTHER EXTENSION**

1. Perform the step 1 and 2 of “ **PAGING BETWEEN EXTENSIONS**” section to start paging. Destination extension unit beeps.
2. If user, on the destination extension, presses the INT button during paging, it will bring both units into Intercom mode.
3. When finish with the Intercom, press INT button on either source or destination extension will end the Intercom mode.

## **RING ON INTERCOM**

1. During Intercom mode, if there comes an incoming call on line1, caller ID will display on the screen (top right corner of the LCD shows the line of call).
2. Short beep alert will be heard.
3. User on either source or destination extension can press the L1 button to end the Intercom mode and take the call on line1. (If either source or destination extension is replaced onto cradle, the Intercom mode will be ended and the unit starts ringing)

## **QUICK TRANSFER CALL TO OTHER EXTENSION**

1. During one line is in conversation while another line is on hold, you can quick transfer any line to other extension by press the INT button followed by destination extension number and then the target line button (L1 for transferring line1, L2 for transferring line2)
2. If destination extension user press the corresponding line button, the call will be transferred to this extension. Otherwise after 30seconds it will ring back the source handset for 30seconds.
3. During 1extension 2lines conference mode, you can quick transfer both lines conference to other extension by using step 1 and 2, either L1 or L2 key will result in transferring the conference call to the destination extension.

## **TRANSFER CALL AFTER INTERCOM**

1. During one line is in conversation while another line is on hold, you can establish intercom mode by pressing the INT button followed by destination extension number. Press the INT button on the destination extension to answer the Intercom call and start the intercom conversation.
2. After the intercom, press the target line button on the source extension (L1 for transferring line1, L2 for transferring line2) to transfer the target line to this intercom connected extension.

3. During 1extension 2lines conference mode, you establish the intercom with a destination extension using step 1 and 2, after the intercom, either L1 or L2 key will result in transferring the conference call to the destination extension.

### **CONFERENCE WITH TWO LINE**

1. During line1 conversation, press the HOLD button to put line1 on hold, then press L2 button to get line2, “ H1L2” is shown on the LCD to indicate the call status. Dial your telephone number on line2, and starts your line2 conversation.
2. Press the HOLD button to put line2 on hold too, “ H1H2” is shown on the LCD. Now both lines are on hold, other than pressing L1 or L2 button to back to desired line conversation, you may press CONF button to join both lines to conference mode, “ C1C2” is shown on the LCD to indicate the 2lines conference.
3. During 1extension 2lines conference mode, you can press HOLD to put both lines on hold, then press L1 button to go back to line1 conversation while keeping line2 on hold; Or you can press L1 button directly to go back to line1 conversation while dropping line2.
4. During 1extension 2lines conference mode, you can invite one more extension to join the conference. Press INT button and then the destination extension number, when the destination extension answers the page then Intercom mode is engaged, you may press the CONF button on the source extension to engage the 2extensions 2lines conference mode, the extensions information is shown on upper row of the LCD while the lines’ information is shown on the lower row.
5. During 2extensions 2lines conference mode, any extension can quit the conference by pressing the L1 or L2 button, the conference then reduced to 1extension 2lines conference mode.

### **TWO EXTENSIONS CONFERENCE WITH ONE LINE**

1. During a call, you establish the Intercom mode to another extension, while keeping the call on hold, using the procedure described in “ **INTERCOM WITH OTHER EXTENSION**” section.
2. During the Intercom mode, you can press the CONF button on the source extension to join conference the source, destination extension and the line, the extension information is shown on upper row of the LCD while the line information is shown on the lower row.
3. Either source or destination extension can quit this conference by pressing corresponding L1 or L2 button.
4. During 2extensions 1line conference, you can invite one more external line to form the 2extensions 2lines conference. If you are using line1 in your conference, press the HOLD button to put line1 on hold and then L2 button to get line2, dial your telephone number in line2, press the HOLD button to put line2 on hold, and then press CONF button to form the 2extensions 2lines conference mode.

### **MIXED MODE DIALING (Temporary Pulse to Tone Dialing)**

- If you only have pulse (rotary dialing) service in your area and want to access Tone services (Phone banking service, etc.), ensure that the signaling mode setting in the base unit phone setup menu is set to Pulse mode.
- Press the \*/TONE button once to switch from Pulse to Tone dialing temporarily, Pulse dialing mode resumes when the call is ended.

### **PAUSE FUNCTION**

- In some cases, such as PBX or long distance service, a pause may be needed in the dialing sequence. Pressing the PAUSE button inserts a three-second delay between dialed numbers.

## FLASH FUNCTION

- Used to access custom calling features such as Call Waiting or Three-Way Calling provided by your local phone company. Flash can also be used to restore a dial tone to make a new call.

## OUT OF RANGE WARNING

- The handset and base unit communicate up to a certain maximum range. The distance can be affected by weather, power lines, or even other cordless telephones.
- If you far away from the base unit, the handset will show “ OUT OF RANGE” on the LCD display to warn you that bit error rate is too high for proper communication between the handset and the base unit.
- When you hear no voice and see the“ OUT OF RANGE” display, you should move closer to the base unit. Otherwise, the call will automatically cut off after 30 seconds.

## LOW BATTERY WARNING

- When the handset battery voltage level is low, the handset LCD display shows “ BATTERY LOW!” .
- Return the handset on the base cradle or charge cradle for charging.

## TELEPHONE KEYPAD CHARACTERS

The TELEPHONE KEYPAD buttons (0~9) are used to enter characters using multi-tap input when entering names. Press the appropriate KEYPAD button consecutively to get the following characters.

Keypad Button	M u l t i - t a p C h a r a c t e r s
1	S p c _ * !
2	A B C (
3	D E F )
4	G H I \$
5	J K L /
6	M N O ;
7	P Q R S
8	T U V ?
9	W X Y Z

**Multi-tap example:** If you want to enter the character “ C” , press the KEYPAD button ②, the first character displayed will be “ A” . Press the button ② again within 1 second to display “ B” , and press again within 1 second to display the letter “ C” . To enter the next character, press the appropriate button. If, however, the next character is on the same button as the previous character, you will need to wait for 2 second until the cursor shifts. If you want to change any character, you can go backward by pressing DEL button to erase the inputted characters one by one.

## PHONEBOOK OPERATION

### SAVING IN THE PHONEBOOK

*All phonebook operation is the same on handset and base unit, the phonebook memories are independently stored in their own non-volatile memories.*

1. Press the MEM button.
2. Press UP/DOWN button to select location, or enter 2 numeric digits to select location directly (01~20 on base unit, 01~30 on handset).

3. Press MENU to confirm editing in the current location.
4. Use the TELEPHONE KEYPAD buttons (0-9) to enter the name by multi-tap input. You can store up to 15 characters.
5. Press MENU button once.
6. Enter the telephone number using the TELEPHONE KEYPAD buttons (0-9). You can store up to 24 digits.
7. Press MENU button to save into current memory location and goes back to Standby mode.

**NOTE:** The above procedure will overwrite current location if it is not empty. If no active buttons are pressed for 60 seconds, the LCD display will automatically return to Standby mode.

**NOTE:** for the operation of multi-tap input, please refer to Telephone Keypad Characters section for more detail.

### **VIEWING THE PHONEBOOK**

On the base unit there is 20 memories Phonebook while on the handset there is 30 memories phonebook, each record stores 15character names and 24digits number, it is a location dependent phonebook and you can scroll through the list by arrow buttons.

1. Press the MEM button.
2. Press the UP or DOWN button to find the one you need, If number is more than 1 page, it will show 2 pages alternatively.

**NOTE:** To exit the Phonebook at anytime, press the BACK button.

### **EDITING NAME AND NUMBER IN THE PHONEBOOK**

1. Press the MEM button.
2. Press the UP or DOWN button to find the one you want to edit.
3. Press MENU button to edit the name.
4. Use DEL button to erase existing characters one by one and use the TELEPHONE KEYPAD buttons (0-9) to re-enter the name by multi-tap input. (up to 15 characters)
5. Press the MENU button once.
6. Use DEL button to erase existing digits one by one and use the TELEPHONE KEYPAD buttons (0-9) to re-enter the number. (up to 24 digits)
7. Press the MENU button to confirm and save the change.

**IMPORTANT:** It is not advisable to save a telephone number without the corresponding name in the Phonebook.

**NOTE:** When no active buttons are pressed for 60 seconds, the LCD display will automatically return to Standby mode.

### **PLACING CALLS FROM THE PHONEBOOK**

1. Press the MEM button.
2. Press the UP or DOWN button to find the one you want to call.
3. Press the L1 or L2 button on handset (or L1/L2 button for base unit case) to dial out the telephone number.
4. Start your conversation when call is connected.
5. To end your conversation, either press the corresponding L1 or L2 button on handset or place the handset on the base unit (or press the corresponding L1 or L2 button for base unit case).

**NOTE:** Be sure to check that the line is not being in use by another parallel phone.

### **DELETING A STORED NUMBER IN THE PHONEBOOK**

1. Press the MEM button.

2. Press the UP or DOWN button to find the one you want to delete.
3. Press the DEL button. The unit will prompt you the deletion of the current phonebook entry and the LCD display will show “ DELETE RECORD?”
4. Press again the DEL button to delete. The LCD display will show “ DELETED!” and return to Standby mode.

## **CALLER ID OPERATION**

**IMPORTANT:** Subscription to Caller ID on Call Waiting services from your local phone company is required for using the Caller ID on Call Waiting features of the 35828A. Your new 35828A telephone gives you the ultimate in cordless telephone sound quality with the luxury of Caller ID on Call Waiting.

If this is your first cordless telephone, you will soon discover that your cordless is similar to regular telephones, except without the cord. If you have owned a cordless in the past, you will discover that the 35828A telephone is the most powerful and full-functioned Caller ID on Call Waiting cordless telephone on the market, some key features are:

- 40 name and number Caller ID on Call Waiting memories (Caller List)
- 20 name and number phonebook on base, 30 on handset
- Hearing aid compatibility
- Frequency Hopping Digital Spread Spectrum radio communication technology

Unlike regular telephones, your cordless telephone does not work during power failures. We do not recommend you to use a cordless telephone as the only phone in your residence.

## **INTRODUCTION TO CALLER ID ON CALL WAITING**

The 35828A Caller ID on Call Waiting devices allow you to take advantage of the Caller Identification Delivery service offered by your local telephone company. For more information, you can refer to the following Question and Answer table:

<b>QUESTIONS</b>	<b>ANSWERS</b>
What is Caller ID?	Caller ID is a device that identifies the calling party before you answer a call. This device can be used to screen unwanted calls and eliminate harassment from annoying calls.
What is CID on Call Waiting?	CID on Call Waiting is a device that can also identifies call waiting party before you answer a call.
How Does Caller ID on Call Waiting work?	When used with Caller ID on Call Waiting service, the Caller ID on Call Waiting device displays the name (if available) and the telephone number (if available) of the person calling before you answer your telephone.
Who provides Caller ID services?	Your local telephone company. However, not all local telephone companies provide Caller ID service. Please call your local phone company to confirm that the service is available before you install the device.
How Can I activate my Caller ID?	For your Caller ID unit to function, you must first arrange with your local telephone company to have Caller ID on Call Waiting service installed on your line. There is an extra charge added to your monthly telephone bill for this service. Before using this unit, please read this instruction manual carefully.

## RECEIVING NEW CALL

- When you receive a new call, the call information is stored under CALLER ID List. The “NEW” segment of LCD display will turn on and Red new call(s) LED will blink slowly if there is unread new call(s) in the caller list (the line1 new call is indicated by the red LED under the L1 button while the line2 new call is indicated by that under L2 button).
- When you receive a call, the system displays the caller information sent by the telephone company, called a Call Record. The Call Record consists of the following information.
  - a. The caller’s name (if available)
  - b. The caller’s telephone number
  - c. The time and date of a call
  - d. The line of a call

## VIEWING THE CALLER ID LIST

- In Standby mode, press UP/DOWN button to enter Caller ID list. If there is new call(s), the “NEW CALL 03” prompt will be displayed at first where “03” is indicating number of unread Caller ID record in the caller list.
- Press UP or DOWN button to scroll to the next call. The DOWN button will go through the calls from the last call received to the first. The UP button will allow you to view the calls from the first call received to the last. When viewing the caller records, their line of call information is indicated by the red LED under the L1 and L2 button.
- Press BACK button to finish review.

**NOTE:** If no active buttons are pressed for 60 seconds, the display will automatically return to Standby. If you press the UP/DOWN button within 60seconds after back to Standby, it will resume to the previous record in the Caller list, this will ease the “slow” user to go through the caller list without scrolling back to previous record by too many key strokes.

## CALLER ID DISPLAY

12:35AM	11/30	L1
123-845-3892		
JOHN SMITH		

LCD display shows name and number, time and date of the call.

12:35AM	11/30	L1
123-845-3892		

LCD display shows number-only service.

12:35AM	11/30	L2
UNKNOWN CALLER		

“UNKNOWN CALLER” will be displayed when Caller ID information is not available. This

call was made from a telephone company that does not offer Caller ID services (including international calls).

12:35AM	11/30	L1
BLOCKED CALL		

“BLOCKED CALL” will be shown when a call is received from a blocked number. For privacy reasons, some states allow callers the option to prevent their telephone data from being displayed on the other party’s Caller ID display.

		L2
INCOMPLETE DATA		

Display shows when the Caller ID information was received incorrectly or only part of the data was received.

**NOTE:** When an incomplete data CID is received, none of the data from this call is saved in memory.

		L2
MESSAGE WAITING		

Display shows when a voice mail message has been received and is stored by message waiting service provided by the phone company.

12:35AM	11/30	L1
123-845-3892		
JOHN SMITH		

Display shows when the incoming call ringing.

NO RECORD!		
------------	--	--

This is displayed when UP/DOWN button is pressed and there is no Caller ID data stored.

### CALL WAITING

When you subscribe to Call Waiting service from your local telephone Company, this telephone will display the name and number of the second caller while you are having a conversation.

When a second call comes in while you are having a conversation, you will hear a notification tone and volume is momentarily muted. The LCD will automatically show the name and



number of the second caller, press the FLASH button to answer the second caller while putting the first caller on hold. When you have finished, press the FLASH button to continue with your conversation with the first caller. (You may press the FLASH button again to switch between callers, there will no display indication for which caller you are connecting to on the screen)

### MESSAGE WAITING

If you have subscribed to Voice Mail message service and if you have requested Visual Message Indication from your local telephone company, the corresponding VMWI LED indicators under the L1/L2 button on handset and on base unit will blink and the LCD will show “ MESSAGE WAITING” when there is voice message(s) for you from your telephone company.

### PLACING A CALL FROM THE CALLER LIST

Press the UP/DOWN button.

Press the UP button or DOWN button to select the call record you wish to call back.

If the number displayed is not correct (needing 7, 8, 10, 11, 12 digits), press the FORMAT button to select call number.

12:35AM	11/30	CALL#07
555-555-1212		
JOHN SMITH		

Press FORMAT button.

12:35AM	11/30	CALL#07
1-555-555-1212		
JOHN SMITH		

Press FORMAT button.

12:35AM	11/30	CALL#07
555-1212		
JOHN SMITH		

During showing CID record on LCD, user can press L1 or L2 button on handset (or L1/L2 button for base unit case) to dial out the display number, or press BACK button to cancel dialing.

To end your conversation, either press the corresponding L1 or L2 button on handset or place the handset on the base unit (or press the L1/L2 button for base unit case).

### SAVING NUMBER FROM CALLER LIST TO PHONEBOOK

1. Press the UP/DOWN button.
2. Press the UP or DOWN button to scroll to the call record you wish to store into the phonebook.
3. Press MENU button. The LCD display shows “ SELECT LOCATION” .

4. Press 2 digits numeric buttons to select location (01~30 for handset while 01~20 for base unit).
  5. Screen will back to Standby mode.
- NOTE:** If you press the FORMAT button to change the display format before saving to phonebook, the final displayed number on screen will be stored to the phonebook location.

### **SELECTIVE DELETING IN THE CALLER LIST**

1. Press the UP/DOWN button.
2. Press the UP or DOWN button to scroll to the call record you wish to delete.
3. Press DEL button. The LCD display will show “DELETE RECORD?” .
4. To delete the selected call record, press DEL button again to confirm.
5. Screen will show “DELETED!” .

### **DELETING ALL RECORDS IN THE CALLER LIST**

1. Press the UP/DOWN button.
2. Press the UP or DOWN button to scroll to the call record you wish to delete.
3. Press and hold DEL button. The LCD display will show “DELETE ALL?” .
4. To delete all call records, press DEL button again to confirm.
5. Screen will shows “NO RECORD!” if all records are read, or “UNREAD RECORD, CANNOT DELETE” if some call records are unread.

## **ANSWERER OPERATION**

This is a sophisticated 2 Lines Digital Answerer incorporated in this 2 lines cordless system. All incoming messages (ICMs), outgoing messages (OGMs) and Memo messages (MEMO) are stored digitally into non-volatile memory. Messages are accessed instantly and arranged compactly in this memory. The answerer can store 13 minutes of messages or 59 messages at most (ICMs, OGMs and MEMOs combined).

### **SETTING THE DAY/TIME STAMP**

You need to set the day/time at every power up of the base unit, otherwise there will be no day/time stamp announcement for message playback. Please refer to the **TAD DAY/TIME** section of the **PHONE SETUP OPERATION** chapter for setup details.

The base unit LCD day/time row will blink slowly and dual 7 segment LED digit will show “CL” if user had not completed this setup.

### **RECORDING YOUR OUTGOING MESSAGES**

Before using your Answerer, it is suggested that you record your own Outgoing Message (OGM) for each line. This is the announcement callers will hear when the system answers a call on each line.

1. During Standby mode, press and hold the L1-OGM button to record your own line1 OGM, the answerer will prompts “Please record mailbox 1 announcement after the tone” ;
2. Then release the button and start speak to the microphone when a beep tone is heard. The 7-segment LEDs will show the countdown time of the OGM recording, 29,28,27,...;
3. Press the STOP button when line 1OGM recording is completed. The updated line1 OGM will be played back from the speaker immediately for your approval.

4. To record the line2 OGM, repeat from step1 to 3 but using L2-OGM button to start the line2 OGM recording, the answerer will prompts “ Please record mailbox 2 announcement after the tone” .

**NOTE:** Maximum OGM recording time is 30seconds.

**NOTE:** To obtain a better sound quality for locally recorded messages, speak directly into the microphone from a distance of 9 to 12 inches.

## **CHECKING YOUR OUTGOING MESSAGE**

To check and playback your current outgoing messages.

1. During Standby mode, press the L1-OGM button to check the current line1 OGM in use, or press the L2-OGM button to check the current line2 OGM in use;
2. The current OGM will be played back from the speaker immediately.

## **RESTORE TO DEFAULT OGM**

To restore the current OGM to pre-recorded system announcement.

1. During Standby mode, press the L1-OGM button to play the current line1 custom OGM;
2. During playback, press the ERASE button to erase the line1 custom OGM thus the default line1 OGM is restored and played back to you immediately “ Hello, Please leave a message after the tone” .
3. To restore line2 custom OGM back to default, repeat from step1 to 2 but this time use L2-OGM button to start the line2 OGM playback.

## **TURNING THE ANSWERER ON/OFF**

You may turn the both lines’ answerer on/off by pressing buttons on base unit, issue command during line remote mode or handset remote mode. For operations during remote modes, please refer to remote section for detail operation.

1. During Standby mode, press the L1 ANS ON/OFF button on the base unit to turn on the line1 answerer, you will hear “ Mailbox 1 answer on” from the speaker as indication;
2. Press the L1 ANS ON/OFF button again to turn off the answerer, you will hear “ Mailbox 1 answer off” from the speaker as indication.
3. To turn line2 answer on/off, press the L2 ANS ON/OFF button, you will hear “ Mailbox 2 answer on” or “ Mailbox 2 answer off” from the speaker as indication.

**NOTE:** Once turned off, the answerer will answer only after the 10<sup>th</sup> ring, allowing you to turn the answerer on or listen to the message stored from a remote location.

**NOTE:** The 2lines answerer cannot answer to incoming calls at the same time. When speakerphone is in use, the answerer cannot answer to call on another line, and also no handset can remote access to the answerer during this period.

## **SETTING THE RING COUNT**

During answer on mode, the answerer on both lines will answer the call on each line after the number of rings set in the ring count option menu by the user. Please refer to the **TAD RING COUNT** section of the **PHONE SETUP OPERATION** chapter for setup details.

If “ 3” is selected, the answerer will answer the call after 3 rings;

If “ 5” is selected, the answerer will answer the call after 5 rings;

If “ TS” is selected, the answerer will answer the call after 3 rings if there is new message(s) in the memory or after 5 rings if there is no new message in the memory, this will save money for making call from a remote location pay phone because you can hang up the call

at the 4<sup>th</sup> ring in case no new message to listen to.

**NOTE:** The new message(s) in the memory can be taken from either line1 or line2.

### **SETTING REMOTE PIN CODE**

There is a remote access PIN code, a 3 digits code, which is required for taking remote to the answerer when calling from remote telephone. This PIN code is set on the base unit. Please refer to the **TAD PIN SETUP** section of the **PHONE SETUP OPERATION** chapter for setup details. The default PIN code is 777.

### **RECORDING A MEMO**

You can leave a message to your family member(s) by recording a MEMO message locally.

1. During Standby mode, press and hold the MEMO button to record MEMO message, the answerer will prompts “ Please record message after the tone” ;
2. Then release the button and start speaking to the microphone when a beep tone is heard;
3. Press the STOP button when MEMO recording is completed, the message counter (7-segment LEDs) will be increased by one.

**NOTE:** The MEMO message(s) is stored in the same message memory as the ICMs, and is/are played back together with the ICMs during playback mode.

**NOTE:** The maximum MEMO recording time per message is 2 minutes.

### **PLAYING OF MESSAGE/MEMO**

During Standby mode, press the PLAY button on base unit to start playback the message(s). The messages means all ICMs from both lines, MEMO messages. If there is new message in memory, all new messages will be played back during this round. If there is no new message in memory, all messages will be played back during this round. Oldest message will be played first.

1. During Standby mode, press the PLAY button on base unit to start playback of the message(s);
2. To repeat the current message, press the PREV. button on base unit to go the beginning of the current message; Press the PREV. button quickly again will skip to the previous message;
3. To skip to next message, press the SKIP button on base unit;
4. To erase the current message, press the ERASE button on the base unit;
5. To erase all old message(s), press and hold the ERASE button on the base unit;
6. To stop the message playback, press the STOP button on base unit.
7. To change volume of playback, press the VOL.UP or VOL.DOWN button to change the volume to desired level, the 7-segment LEDs shows “ L1” , “ L2” ,... “ L8” as speaker volume indication.

**NOTE:** TAD local operation is not allowed during base or handset(s) line in use state.

**NOTE:** TAD local operation could be interrupted by talk on request from handset(s).

### **HANDSET REMOTE MODE**

You can listen to the message and turn answerer on/off using handset by entering the handset remote mode.

1. During Standby mode, press the REMOTE button on handset to enter the remote mode, the LCD shows “ ANSWERER REMOTE ACCESS MODE” ;
2. You can press ② to playback the message as operating the base unit;
3. During playback, press ① will goes to beginning of current message and quickly press again will goes to previous message, or press ③ to goes to next message, or press ④ to erase current message;
4. At the beginning of the remote mode or after the stop of message playback, you will hear the voice menu “ For help menu, press 7; To turn mailbox 1 answer off on, press 4; To turn mailbox 2 answer off on, press 6; To playback, press 2; To stop, press 2 again; During playback, to skip to next, press 3; To skip to the previous, press 1; To delete, press 0” .
5. During remote mode, you can press ④ to turn line1 answer on/off and hear the voice prompt “ Mailbox 1 answer on” or “ Mailbox 1 answer off” for indication. You can press ⑥ to turn line2 answer on/off and hear the voice prompt “ Mailbox 2 answer on” or “ Mailbox 2 answer off” for indication;
6. During remote mode, you can press ⑦ to hear the voice menu again.

**NOTE:** Handset remote TAD operation is not allowed during base line in use state.

**NOTE:** Handset remote TAD operation could be interrupted by talk on request from base.

### LINE REMOTE MODE

You can call to your answerer from a remote tone telephone. Answerer will answer the call after the preset ring count. (either 3, 5, or 10 rings)

1. When the answerer answering the call, enter your 3 digits PIN code to engage the line remote mode. If the answerer does not prompts you the voice menu, that mean some DTMF tone code cannot be correctly received, please re-enter the PIN code again within 8seconds timeout period, you may need to enter \* before the PIN to force the answerer to start over the reception of PIN code sequence.
2. At the beginning of the remote mode, you will hear the voice menu, same voice menu as in handset remote mode, please refer to the tone command described in HANDSET REMOTE MODE section for detail. (you may turn any lines’ answerer on/off, playback message, erase message)
3. If the answerer cannot receive your next command within 8 seconds timeout counting from the end of completion of previous command, it will disconnect your call.
4. If you disconnect the call, the answerer will disconnect after 8 seconds.

### INCOMING CALL SCREENING

When there comes an incoming call, you can let the answerer take the call for you. On the other hand you press the REMOTE button on handset to enter call screening mode 3 seconds after the answerer answers the call, screen will show “ SCREENING L1” or “ SCREENING L2” for line1 and line2 case respectively, and you can listen to the caller from the handset receiver while the caller don’ t known that the call is being screened.

If you want to talk to the caller directly, press L1 button (or L2 button if for line2) to interrupt the ICM recording and talk with the caller immediately.

## WHEN THE MEMORY IS FULL

The answerer can record 13 minutes or 59 messages at most. When memory is full, you will hear the voice prompt “ MEMORY IS FULL” if you are trying to record new OGM/MEMO/ICM or when you enter the line/handset remote mode.

You must delete some old messages in order to make room for new messages.

## IMPROVING CORDLESS RECEPTION

Follow these guidelines to improve cordless sound quality:

- Select an area to install the 35828A where it is closest to the center of your home or office. This will improve the operating range of the unit.
- Keep the 35828A base unit away from electrical equipment. Radio Frequency Interference (RFI) is sometimes generated by these appliances, which can cause degradation in cordless reception.
- Keep the handset batteries charged as much as possible. Weak handset batteries can limit the range of cordless operation.

## MAINTENANCE

1. Your phone should be situated away from heat sources such as radiators, heaters, stoves or any other appliance that produces heat.
2. Use a slightly damp cloth to clean the plastic cabinet. A mild soap will help to remove grease or oil. Never use polish, solvents, abrasives or strong detergents since these can damage the finish.

## TROUBLESHOOTING

### A. CALLER ID SYSTEM TROUBLESHOOTING TABLE

Symptoms	Possible Solution / Cause
The Caller ID panel is blank	<ul style="list-style-type: none"><li>• Check the power connection.</li><li>• Check the telephone line cord connections.</li><li>• Check the batteries for proper installation.</li></ul>
The Caller ID panel does not show the caller's name and/or phone number.	<ul style="list-style-type: none"><li>• The Caller ID unit will not function until you have Caller ID service provided by your local phone company. Call your local phone company to have Caller ID installed on your telephone line.</li><li>• Check your telephone line connections. Make sure all connections are secure and connected.</li><li>• If you pick up the phone before the second ring, the caller information will not be correctly received. If you have telephone answering device (TAD) connected with the unit, set the TAD to answer after two rings or more.</li><li>• If it is a blocked call or an out-of-area call, the caller's name and / or phone number will not appear on the display.</li><li>• If only the caller's phone number appears on the display, it may be a Single Data Message Format (SDMF) call, as opposed to a Multiple Data Message Format (MDMF) call. Please call your local phone company to see which service you have.</li></ul>
Random characters and / or "NO DATA" / or "INCOMPLETE DATA" appear on the LCD display.	<ul style="list-style-type: none"><li>• On rare occasions, the Caller ID information sent by the telephone company may have an error in the transmission. This is not the fault of your Caller ID unit. It can only capture and store the data that was received.</li></ul>
Cannot get Call Waiting identification on the LCD panel.	<ul style="list-style-type: none"><li>• Subscription to Caller ID on Call Waiting (CIDCW) is required from your local phone company for the CIDCW function to operate properly. Call your local phone company for details.</li></ul>

## B. TELEPHONE UNIT TROUBLESHOOTING TABLE

Symptoms	Possible Solution / Cause
No dial tone	<ul style="list-style-type: none"> <li>Check that the telephone line cord connectors at both ends are pushed in firmly until they click.</li> </ul>
Does not ring	<ul style="list-style-type: none"> <li>Check the ringer volume mode on the handset. Set to ringer hi/med/lo mode to enable the handset ringer.</li> <li>Check that the telephone line cord connectors at both ends are pushed in firmly until they click.</li> <li>You may have exceeded the Ringer Equivalence Number (REN) limit of how many phones can be connected to the same line. The REN total of all devices (printed on the bottom label of each unit) should not exceed five (5). Disconnect the appropriate units to lower the REN total.</li> </ul>
No power on the handset unit	<ul style="list-style-type: none"> <li>Check the Ni-MH battery pack for proper connection inside the battery compartment on the handset.</li> <li>The handset rechargeable Ni-MH battery pack may need charging.</li> </ul>
Does not charge	<ul style="list-style-type: none"> <li>Check the Ni-MH battery pack for proper connection inside the battery compartment on the handset.</li> <li>Make sure the charging contacts on both the base unit and the handset are in contact during charging.</li> <li>The charging contacts and terminals may need cleaning with an alcohol-dampened swab.</li> </ul>
Range is limited	<ul style="list-style-type: none"> <li>Move the base unit so that it is centrally located in your residence or office and make sure that the base unit is not located near appliances.</li> <li>The handset Ni-MH battery may be weak. Recharge the Ni-MH battery.</li> <li>Refer to the section "Improving Cordless Reception".</li> </ul>
Calls received flutters or fades	<ul style="list-style-type: none"> <li>The handset rechargeable Ni-MH battery pack may need charging.</li> </ul>
Interference on reception	<ul style="list-style-type: none"> <li>Refer to the section "Improving Cordless Reception".</li> </ul>
Excessive static	<ul style="list-style-type: none"> <li>Refer to the section "Improving Cordless Reception".</li> </ul>

## C. ANSWERER SYSTEM TROUBLESHOOTING TABLE

Symptoms	Possible Solution / Cause
Incoming calls / MEMO messages are cut off	<ul style="list-style-type: none"> <li>The Excursion will stop recording after 8 seconds of continuous silence or 8 seconds after the caller hangs up.</li> <li>Each incoming message recording is limited to two minutes.</li> </ul>
Callers cannot leave messages	<ul style="list-style-type: none"> <li>The Excursion memory may be full. Erase old messages to make room for new messages.</li> <li>Check to see if the Answer mode is not set in the Answer Off mode.</li> </ul>
Announces "Memory is full"	<ul style="list-style-type: none"> <li>The 13 minutes recording limit may have been reached or 59 messages are stored in memory. Erase old messages to make room for new messages.</li> </ul>
Cannot access Remotes Operation	<ul style="list-style-type: none"> <li>The remote PIN code you entered may be incorrect. Enter the correct PIN code during OGM playback or ICM recording status, you must finish the second and third digit input within 8seconds of inputting the first digit.</li> <li>Use Touch Tone (DTMF tone) telephone only to access Remote Operation. Ensure that you press and hold each key press for at least 2 seconds for each digit.</li> </ul>

## TECHNICAL INFORMATION

This cordless phone uses radio frequencies to allow mobility. There are certain difficulties in using radio frequencies with a cordless telephone. While these are normal, the following could affect the operation of your system.

**NOISE:** Electric pulse noise is present in most homes at one time or another. This noise is most intense during electrical storms. Certain kinds of electric equipment such as light dimmers, fluorescent bulbs, motors, and fans also generate noise pulses. Because radio frequencies are susceptible to these noise pulses, you may occasionally hear them in your handset. Generally, they are minor annoyances and should not be interpreted as defects in your system.

**RANGE:** Because radio frequencies are used, location of the base unit can affect operating range. Try several locations in your home or business and pick the one that gives you the clearest signal.

**INTERFERENCE:** Some electronic devices operate in and/or generate interference near the operating frequencies of your cordless telephone. While several protection circuits are used to prevent unwanted signals, there may be periods when these unwanted signals cause interference. If interference occurs frequently, it can be minimized or eliminated by relocating the base unit. You can check for interference before selecting the final base unit location by plugging in the phone.



**ADAPTER: Use Only Class 2 Power Source 9VDC 850mA.**



**BELL<sup>®</sup> Phones**  
**BY NORTHWESTERN BELL PHONES**

**Distributed Exclusively Worldwide by Unical  
Enterprises, Inc., City of Industry, California, USA  
35828A/06-CPV7 <http://www.nwbphones.com>**