



www.unication.com



VOICE PAGING ACK-BACK SYSTEM



G1 VOICE PAGER USER'S MANUAL



INDEX

PART I. NOTES	1
1. THANKS NOTES	1
2. WARNING AND IMPORTANT NOTES	2
2-1. WARNING	2
2-2. IMPORTANT NOTES	3
PART II. PAGING SYSTEM INTRODUCTION	4
1. SYSTEM DIAGRAM	4
2. INTRODUCTION	6
PART III. PACKAGE INTRODUCTION	7
1. STANDARD PACKAGE INTRODUCTION	7
2. OPTIONAL ACCESSORIES INTRODUCTION	9
PART IV. PAGER INTRODUCTION	10
1. PAGER APPEARANCE	10
1-1. FRONT VIEW	10
1-2. TOP VIEW	11
1-3. BOTTOM VIEW	11
1-4. SIDE VIEW	12
1-5. REAR VIEW	13
2. KEY INTRODUCTION	14
2-1. ENTITY KEY	15
2-2. HOT KEY	16
3. LCD DISPLAY	17
4. LED INTRODUCTION	17
4-1. POWER LED	18
4-2. MESSAGE LED	19
5. ICON INTRODUCTION	20
5-1. STATUS BAR ICONS	20
5-2. TOOL BAR ICONS	22
5-3. TEXT AREA ICONS	22
PART V. DEVICE INSTALLATION	23
PART VI. FEATURE INTRODUCTION	28
1. FEATURE LIST & DESCRIPTIONS	28
1-1. FEATURE LIST	28
1-2. FEATURE DESCRIPTIONS	36
2. FEATURE INTRODUCTION	54
2-1. POWER ON	54
2-2. RECEIVING MODE	56

INDEX

2-3. RESET MODE	62
2-4. MENU OPERATION	64
2-5. TODAY	64
2-6. FUNCTION STATUS	67
2-7. SETTINGS	70
2-8. RECEIVING MESSAGE	84
2-9. ACKNOWLEDGMENT	94
2-10. REMINDER	97
2-11. EMERGENCY CALL (ONLY FOR GSM MODEL)	102
2-12. OTAP (Over The Air Programming)	103
2-13. OTAC (Over The Air Command)	104
PART VII OTHERS	106
1. CLEAN THE DEVICE	106
2. COPYRIGHT NOTICE	106



PART I . NOTES

1. THANKS NOTES

Thank you of choosing the multiple functions, smart G1 Voice Pager from Unication. G1 can provide multiple functions and a friendly interface which has passed "reliability and quality" certification. This device will meet all your demand whether or not you are on duty to resolve your voice/text communication and any emergency issues.

G1 GSM Model is a two-way voice pager, it has an unique and patented GSM Ack. function. A manual or automatic GSM response has been built in the device to the Voice Pager Console in order to serve two-way communication purpose.

G1 GSM Model can request manually or automatically the Uni Voice Pager Console to resend a message using GSM/GPRS if the signal was received weakly in the first place. G1 can also detect automatically if you are out of range.

G1 has the highest current voice pager certification for safety which includes US UL Class 1, Division 1 certification and the regulations for water-proof and dust-proof. A super rubber protection is implemented for anti-impact and anti-drop.

G1 can use any compatible rechargeable battery or any AAA battery. One doesn't have to worry battery and its recharging issues.

G1 provides the market's best receiving regulation and a function for cell phone anti-interference. Please spend a few minutes to go over this manual.

Thank you!

PART I . NOTES

2. WARNING AND IMPORTANT NOTES

2-1. WARNING

G1 has been tested and found to comply with the limits for a Class B digital device, pursuant to Part 15 of the FCC Rules. These limits are designed to provide reasonable protection against harmful interference in a residential installation.

Please be aware of below important information:

- Do not operate this product in a hazardous atmosphere.
- Do not replace or charge batteries in hazardous atmosphere.
- Do not disassemble this unit.

Le présent appareil est conforme aux CNR d'Industrie Canada applicables aux appareils radio exempts de licence. L'exploitation est autorisée aux deux conditions suivantes : (1) l'appareil ne doit pas produire de brouillage, et (2) l'utilisateur de l'appareil doit accepter tout brouillage radioélectrique subi, même si le brouillage est susceptible d'en compromettre le fonctionnement.



WARNING : Substitution of Components May Impair Intrinsic Safety. To reduce the Risk of ignition of flammable or explosive atmosphere, batteries must be changed only in a location known to be non-hazardous. To prevent ignition of flammable or combustible atmospheres, disconnect power before servicing.

To reduce the risk of explosion, recharge the batteries outside of the hazardous location.

PART I . NOTES

2-2.IMPORTANT NOTES

- ⚠ The changes or modifications not expressly approved by the party responsible for compliance could void the user's authority to operate the equipment.

- ⚠ To comply with the FCC RF exposure compliance requirements, no change to the antenna or the device is permitted. Any change to the antenna or the device could result in the device exceeding the RF exposure requirements and void user's authority to operate the device.

- ⚠ This device complies with part 15 of the FCC Rules. Operation is subject to the following two conditions:
(1) This device may not cause harmful interference, and (2) This device must accept any interference received, including interference that may cause undesired operation.

- ⚠ Based on US UL regulation:
 - An issue can arise if the original part is replaced which has caused the regulation cannot be met.
 - To avoid to replace the battery under a combustible and explosive environments.
 - To reduce an explosion risk, please cut down the power source before any repair.
 - When recharging, stay away from the combustible or explosive environments.

- ⚠ To prevent from damage, remove the battery when not being used for a long time.

PART II. PAGING SYSTEM INTRODUCTION

1. SYSTEM DIAGRAM

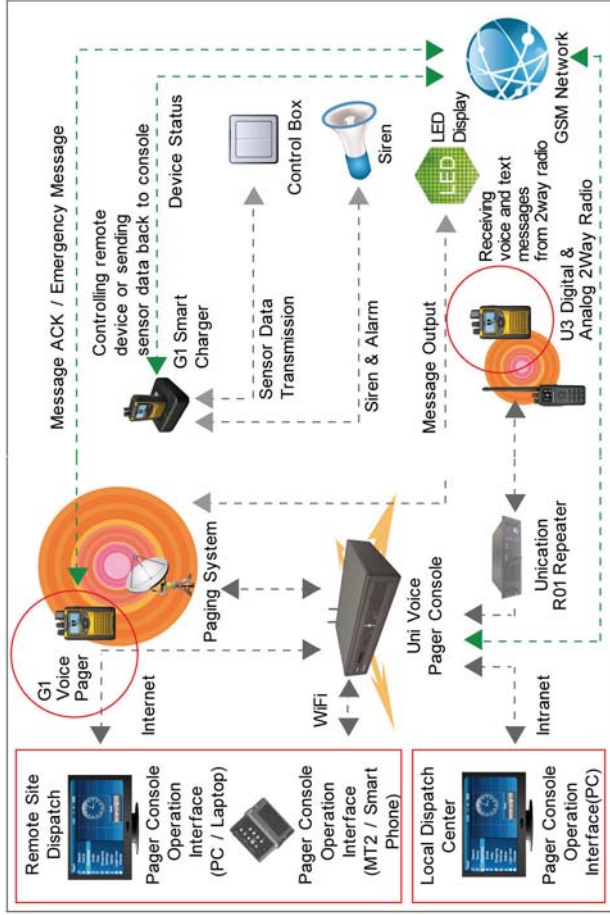



PART II . PAGING SYSTEM INTRODUCTION

2. INTRODUCTION OF SYSTEM DIAGRAM

Integrated 2 tone with MDC 1200, CTCSS / CDCSS, and 5/6 tone, Unication voice pager, G1, can receive voice messages from not only a dispatch center but also from a 2 way radio at the scene. This capability allows firefighters who are inside the fire ground to capture the further instructions from a scene commander who is outside and would have the most understanding about any changes and overall situation. With the new updates, the firefighters will be able to make the critical moves when the fire is out of control. In the meanwhile, alphanumeric pagers are helpless to this scenario.

By having message acknowledgement function, Emergency Dispatch Operators who have Uni Voice Pager Console will now be able to determine the effectiveness of the response to an emergency. Besides, Uni Voice Pager Console integrates with existing Paging and Cellular Systems and provides a complete Messaging Dispatch solution.

PART III . PACKAGE INTRODUCTION



1. STANDARD PACKAGE INTRODUCTION

The standard package of the G1 product will be included below items:

No.		
Item	Basic Model & Basic+Bluetooth Model	GSM Model & GSM+Bluetooth Model
Legend		
No.	1	2
Item	SU Charger	Belt Clip
Legend		

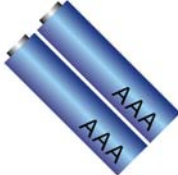
PART III . PACKAGE INTRODUCTION

No.	3	4
Item	User's Manual	2 AAA NiMH Rechargeable Battery
Legend		

No.	5	6
Item	AC Power Adapter	Li-battery (Only for GSM Model & GSM Bluetooth Model)
Legend		

PART III . PACKAGE INTRODUCTION

No.	3
Item	User Name Label
Legend	

2. OPTIONAL ACCESSORIES INTRODUCTION

The optional accessories of the G1 product will be included below items:

No.	1	2
Item	Programmer	Charger Amplifier
Legend		

PART IV. PAGER INTRODUCTION

1. PAGER APPEARANCE
1-1. FRONT VIEW



No.	Description	Remark
①	GSM Antenna	(Only for GSM Model & GSM Bluetooth Model)
②	GSM Receiver	
③	LCD	
④	Key Pad	
⑤	Speaker	
⑥	Microphone	

PART IV. PAGER INTRODUCTION

1-2. TOP VIEW



No.	Description
⑦	Power LED
⑧	Message LED

1-3. BOTTOM VIEW



No.	Description
⑨	Pinouts

PART IV. PAGER INTRODUCTION

1-4. SIDE VIEW



No.	Description
⑩	User Name Label
⑪	Reset Key

Steps to paste on the user name label :

Step1 & 2:

Take out the User Name Label and write down your name on the User Name Label with permanent marker.

Step3 & 4:

Remove the User Name Label and paste it on the G1

PART IV. PAGER INTRODUCTION

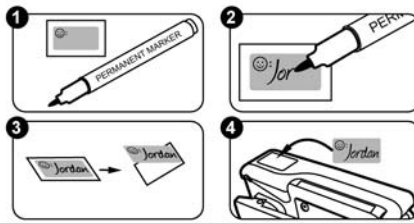

1-5. REAR VIEW



No.	Description
12	Belt Clip
13	Battery Cover

PART IV. PAGER INTRODUCTION

2. KEY INTRODCUTION



No.	Description
①	Function Switch Knob
②	Play Key
③	Power Switch / Volume Knob
④	Reset Key
⑤	Menu Key
⑥	Read Key
⑦	1Function Status Key 2.Emergency Key (Only for GSM Model & GSM+Bluetooth Model)
⑧	Record Key
⑨	Navigation Key

PART IV. PAGER INTRODUCTION

2-1. ENTITY KEY

No.	Entity key	Description
①	Function Switch Knob	The 8-position Function Switch allows the user to select the following modes: a. Selective Call Monitor c. Select Single Channel Monitor d. Select Single Frequency Monitor e. Priority Scan f. Normal Scan g. Silent Scan h. Dual Channel Scan
②	Play Key	Allows for the playback, on a last in first out basis, of all stored voice messages. During playback, one can skip to the next messages by pressing the Play Key. Pressing the Reset Key will stop the playback.
③	Volume Knob	The Volume Knob is a dual function switch that adjusts the audio volume level and is the Power Switch on/off control.
④	Reset Key	Pressing the Reset key: 1. Stops stored voice playback. 2. Activates Monitor features. 3. Returns the G1 to the Standby Mode.

PART IV. PAGER INTRODUCTION

2-2. HOT KEY

No.	Hot key	Description
①	Menu Key	Press the Menu key to display the list of features supported.
②	Function Status Key	Function Status Key allows the enabling or disabling of the following features: 1. Alert Mode Switch 2. Alarm 3. AUTO ON/OFF Enable / Disable 4. Duty ON/OFF Enable / Disable 5. Zone
③	Emergency Key (Only for GSM Model & GSM+ Bluetooth Model)	Depending on the default setting in the PPS, this emergency key is to an emergency call. Press and hold the emergency key for 2 seconds to make an Emergency Call and talk to the Uni Voice Pager Console.
④	Record Key	To record the voice memo press the REC. key.
⑤	Read Key	Press the Read key to read the text message
⑥	Navigation Key	
	OK Key	Press the OK key to confirm the selected features.
	Up Key	Moves the cursor on the main menu to the last item.
	Down Key	Moves the cursor on the main menu to the next item.
	Left Key	Moves the cursor on the tool bar left.
	Right Key	Moves the cursor on the tool bar right.

PART IV. PAGER INTRODUCTION

3. LCD DISPLAY



4. LED INTRODUCTION

Please refer to below charts for LED indications:



PART IV. PAGER INTRODUCTION

4-1. POWER LED

No.	Entity key	Description
①	Flashes Red 2 times/per second	1. Self-Testing failed when the G1 is initially powered on. 2. Self-Testing failed when Auto On. 3. Battery fails while charging.
②	Flashes Red 1 time/per second	Low Battery
③	Flashes Green 1 time /per second	Power supply stable
④	Light in Orange	Charging

PART IV. PAGER INTRODUCTION











4-2. MESSAGE LED

No.	Entity key	Description
①	Flashes Green 1 time/per second	Normal Standby Receiving Mode
②	Flashes Green 2 time/per second	Scan Standby Receiving Mode
③	Flashes Green 4 time/per second	GSM Mode
④	Flashes Orange 1 time/per second	GSM Voice Calling
⑤	Flashes Orange 2 times/per second	Recording Voice Memo
⑥	Flashes Orange 4 times/per second	GSM connection failed
⑦	Flashes Red 1time/per second	Alarm timed out
⑧	Flashes Red 2times/per second	1. Unchecked Voice Message 2. Unread Text Message
⑨	Flashes Red 4 times/per second	Receiving text and voice messages







PART IV. PAGER INTRODUCTION

5. ICON INTRODUCTION

5-1. STATUS BAR ICONS

No.	Entity key	ICONS	Description
①	Remaining Battery Gauge		The battery gauge indicator is located on the status screen and keeps you informed of the battery energy level. The five indicators range from full to low. 100%-75%-50%-25%-0% (battery icon flash)
②	Numbers of unread messages		Unread message icon and quantity indication. Includes voice and text messages.
③	OFF Duty Status		Off Duty Status
④	Universal Alert Status	    	Audible Alert Vibration and Alert Vibration then Alert Vibration (No alert except for priority call) Silent (No alert either vibration except for priority call)
⑤	Message Alarm		Message Alarm is activated
⑥	Clock Alarm		Clock Alarm is activated
⑦	Auto On/Off		Auto On / Off feature is activated.

PART IV. PAGER INTRODUCTION

No.	Entity key	ICONS	Description
⑧	RF Strength		RF signal strength
⑨	GSM Strength		GSM signal strength. (※This signal displays when GSM module is activated.)
⑩	Scan		Scan mode is activated
⑪	Bluetooth		Bluetooth is activated
⑫	Bluetooth Earphone Connection		Bluetooth earphone is connected
⑬	Charging		Battery charging
⑭	Data Link		Data linked

PART IV. PAGER INTRODUCTION

5-2. TOOL BAR ICONS

ICONS			
	Return		Enter
	Save		Toggle
	Yes		No
	Next Message		Previous Message
	Message ACK		Lock Message
	Unlock Message		Message Alarm
	Delete		Mute
	Speaker On		Play
	Record		Pause
	Unlock Mode		End the call
	Move Cursor		Lock Mode
	Resend Message		Return to default

5-3. TEXT AREA ICONS

ICONS			
	Unread Message		Non-ACK Message
	ACK Message		ACK Fail
	ACK Timeout		Read Message
	Lock Message		Alarm Message
	Select		Message Resending

PART V. DEVICE INSTALLATION

Please refer to below operation for belt clip installation, battery installation and how to turn on G1:

- a. Release the belt clip by pressing the latch.



- b. Slide the belt clips upwards.



PART V. DEVICE INSTALLATION

c. Loosen the two screws clockwise by using a coin.



d. Follow the arrow on the battery cover and slide it out.



PART V. DEVICE INSTALLATION

- e. Insert the AAA batteries.
 - e-1. Place the two AAA batteries in the battery component.
 - ⌘ Observe the battery polarity.
 - ⌘ To prevent from damage, remove the battery when not being used for a long time.
 - ⌘ The G1 Voice Pager supports both rechargeable AAA.
 - ⌘ Batteries and Alkaline AAA Batteries.



- f. SIM Card Installation. (Only for GSM Model)
 - Before using the GSM model, you have to insert the GSM SIM card.
 - f-1. Lift the GSM SIM card holder.
 - f-2. Insert the GSM SIM card then place the holder back.
 - f-3. Slide the holder to lock the SIM card.



PART V. DEVICE INSTALLATION

- g. Place the Li-Ion battery. (Only for GSM Model)
After insert the GSM SIM card, please insert the Li-Ion battery.
- g-1. Plug the battery connector to the Li battery jack.



- g-2. Place the Li battery in the battery component.
※ To prevent from damage, remove the battery when not being used for a long time.
- h. After the batteries and SIM card installations. Please place back the battery cover.
- i. Turn the two screws tight counterclockwise by using a coin.
- j-1. After inserting batteries, rotate the volume knob in a clockwise direction to turn on the pager.
- j-2. An audible voice prompt will be generated and the Power LED will illuminate.
- ※ Regarding to how to program the G1 Voice pager, please refer to the G1 Programming Software Manual.

PART V. DEVICE INSTALLATION

Note :

PART VI. FEATURE INTRODUCTION

1. FEATURE LIST & DESCRIPTIONS

1-1. FEATURE LIST

Here are the feature lists in different models of Gt

Feature List	Model	Gt(B) Basic
① Programming setting in Signaling table	1-1 Protocol	V
	1-2 Tone Table Programming Setting in Signaling Table	V
	1-3 Editing in Function Switch and Zone	V
② Switching on pager	2-1 Power on	V
	2-2 Auto Self test	V
	2-3 Pager Test (Manual Self Test)	V
③ Receiving Model (Function Switch)	3-1 Selective Call	V
	3-2 Monitor Mode	V
	3-3 Normal Scan Mode	V
	3-4 Priority Scan Mode	V
	3-5 Silent Scan Mode	V
	3-6 Dual Channel Scan Mode	V
	3-7 Select Single Channel Monitor	V
	3-8 Select Single Frequency Monitor	V

Gt(BT) Basic+Bluetooth	Gt(G) GSM	Gt(BG) Bluetooth+GSM	Page
V	V	V	
V	V	V	
V	V	V	
V	V	V	
V	V	V	
V	V	V	
V	V	V	
V	V	V	
V	V	V	
V	V	V	
V	V	V	
V	V	V	
V	V	V	
V	V	V	
V	V	V	

PART VI. FEATURE INTRODUCTION

Feature List	Model	G1(B) Basic
④ Reset Model	4-1 Auto Reset	V
	4-2 Delay N Auto Reset	V
	4-3 Revert	V
	4-4 Manual Reset	V
	4-5 Timeout Reset	V
	4-6 Delay N Revert	V
⑤ Menu Operation		V
⑥ Today		V
⑦ Function Status		V
⑧ Pager Setting	8-1 Alert Mode	V
	8-2 Date and Time	V
	8-3 Duty On/Off	V
	8-4 Auto On/Off	V
	8-5 Zoom Mode	V
	8-6 Clock Alarm	V
	8-7 Zone Setting	V
	8-8 Squeich Level	V
	8-9 Display Contrast	V
	8-10 Information	V
	8-11 Bluetooth	V
	8-12 Clear Memory	V

G1(BT) Basic+Bluetooth	G1(G) GSM	G1(BG) Bluetooth+GSM	Page
V	V	V	
V	V	V	
V	V	V	
V	V	V	
V	V	V	
V	V	V	
V	V	V	
V	V	V	
V	V	V	
V	V	V	
V	V	V	
V	V	V	
V	V	V	
V	V	V	
V	V	V	
V	V	V	
V	V	V	
V	V	V	
V	V	V	

PART VI. FEATURE INTRODUCTION

Feature List	Model	G1(B) Basic
⑨ Message Box	9-1 Voice Message	V
	9-2 Text Message	V
	9-3 Auto and Manual Resend	
	9-4 OOR Receiving Message	
	10-1 Message ACK	
⑩ ACK	10-2 Power On/Off Status ACK	
	10-3 Duty On/Off ACK	
	10-4 Out of Range ACK	
	10-5 OTA ACK	
	11-1 Voice Memo	V
⑪ Reminder	11-2 Unread Message Reminder	V
	11-3 Key Alert	V
	11-4 Low Battery Reminder	V
	11-5 OOR Reminder	
	11-6 ACK Fail Reminder (GSM Time Out)	
	11-7 Message Alert	V
	11-8 Message Backlight	V
	11-9 Empty Channel Reminder	V

PART VI. FEATURE INTRODUCTION

G1(BT) Basic+Bluetooth	G1(G) GSM	G1(BG) Bluetooth+GSM	Page
V	V	V	
V	V	V	
	V	V	
	V	V	
	V	V	
	V	V	
	V	V	
	V	V	
	V	V	
V	V	V	
V	V	V	
V	V	V	
V	V	V	
	V	V	
V	V	V	
V	V	V	
V	V	V	

PART VI. FEATURE INTRODUCTION

Feature List	Model	G1(B) Basic
12 Emergency Call		V
13 OTAP	13-1 Change Receiving Channels	V
	13-2 Enable/ Disable GSM ACK	V
	13-3 Change GSM ACK Phone No (GPRS IP /Port)	V
	13-4 Change Emergency Call Phone No.	V
	13-5 Change Pager Time	V
14 OTAC	14-1 Pager Disable/ Enable	V
	14-2 Pager Check	V
	14-3 Switch Off Duty to On Duty	V

PART VI. FEATURE INTRODUCTION

G1(BT) Basic+Bluetooth	G1(G) GSM	G1(BG) Bluetooth+GSM	Page
V	V	V	
V	V	V	
		V	
		V	
		V	
V	V	V	
V	V	V	
V	V	V	
V	V	V	

PART VI. FEATURE INTRODUCTION

1-2. FEATURE DESCRIPTIONS

Following the Chapter 1-1 of PART VI, here are the detailed descriptions for each feature:

Feature List	Descriptions for each feature
1-1 Protocol	G1 Voice Pager provides users with ability of decoding on 5 protocols. User can set up protocol on each channel according to system requirement and each channel can support one protocol from one of the following three groups: A group: 2 Tone, 5/6 Tone B group: MDC C group: CTCSS, CDCSS
1-2 Tone Table Programming setting in signaling table	G1 Voice Pager provides 8 Tone Table and 8 MSK Table with users who can assign a table to each channel according to individual requirement. Tone Table : User can set the Tone Table up to 12 2-Tone and 4 Long Tone, or 16 5/6 Tone. MSK Table : User can set the MSK Table up to 16 MDC.

PART VI. FEATURE INTRODUCTION

Feature List	Descriptions for each feature
1-3	Editing in function switch and zone
2-1	Power on
2-2	Auto Self test

G1 Voice Pager provides users with 8 function switch and 8 zones which mean G1 can offer each user up to 64 channels. Each channel can be individually set frequency and reference signaling table for user to program based on different demand of environments and circumstances. Also, if user's system can share with 2 way radio, user with repeaters can add setting of CTCSS or CDCSS in the channel so that the system can receive FM signal which is through repeater.

G1 provides user with different ways to turn on according to their requirement. (Please refer to PART VI. Chapter 2-1-2 "Auto On")

In order to make sure that G1 can work normally after turning on. G1 will process self test right away after being turn on. The test checks functions of each hardware. G1 will make a warning alert to remind user that the test find abnormal item.

PART VI. FEATURE INTRODUCTION

Feature List	Descriptions for each feature
2-3 Pager Test (Manual Self Test)	Auto self test in general voice pagers can only confirm with electronic signals on hardware functions but not be able to be checked directly by user's sense. For example, LCD backlight can't be seen, or buzzer can't be heard when it's tested. However, G1 provides users with the function of Manual Self Test which can be operated directly and check each function one by one. Here are the list of testing items: A. LED TEST B. BACKLIGHT TEST C. LCD TEST D. ALERT TEST E. VIBRATOR TEST F. RF TEST G. KEY TEST H. GSM TEST I. BLUETOOTH TEST
3-1 Selective Call	If user only wants to receive messages contains your ID. We would suggest you to switch to Selective call Mode. In a general situation, this mode is preferred. In this mode, G1 will only monitor one single frequency and detect paging IDs transmitted by protocols such as 2 tone, 5/6 tone. When G1 detects programmed ID (Individual ID or Group ID), G1 will generate a Page Alert and perform voice storage. When the message is over, G1 will turn off speaker and back to monitor the channel.

PART VI. FEATURE INTRODUCTION

Feature List	Descriptions for each feature
3-2 Monitor Mode	If user want to monitor all messages in one frequency, we suggest switching G1 to Monitor Mode. In this mode, user can monitor a certain frequency. When G1 detects pages, G1 will play the message and perform voice storage. When the message is over, G1 will turn off speaker and back to monitoring the channel.
3-3 Normal Scan Mode	If user wants to monitor multi channels, we suggest switching G1 to Normal Scan Mode. In this mode, G1 will scan 2~8 channels in turns which were programmed in PPS setting. If detecting pages in one of the channels, G1 will pause scanning and turn on the speaker to play the message. After the message is played, G1 will turn off speaker and back to scanning the channels.

PART VI. FEATURE INTRODUCTION

Feature List	Descriptions for each feature
3-5 Silent Scan Mode	If user wants to receive pages that contains your ID from multi channels, we suggest switching G1 to Silent Scan Mode. In this mode, G1 will scan if there is any paging that contains the correspond ID in the pre-programmed channels in the PPS. If G1 detects paging IDs transmitted by protocols such as 2 tone, 5/6 tone corresponds to the ID list contains G1 programmed ID (Individual ID or Group ID), G1 will generate a Page Alert and perform voice storage. When the message is over, G1 will turn off speaker and back to monitor the channel.
3-6 Dual Channel Scan Mode	If user wants to monitor pages from two channels at the same time, we suggest switching to Dual Channel Scan Mode. In this mode, G1 will scan one priority channel and one secondary channel. The secondary channel can be chosen manually from the pre-programmed channels. When detected pages, G1 will pause scanning and play the message. When the message is over, G1 will turn off the speaker and back to scanning.

PART VI. FEATURE INTRODUCTION

Feature List	Descriptions for each feature
3-7 Select Single Channel Monitor	If user wants to select one channel to monitor from designate channels, we suggest switching G1 to Select Single Channel Monitor. In this mode, user can decide to manually choose one channel to monitor, or let G1 automatically monitor the channels that has been set in PPS. When detected pages, G1 will pause scanning and play the message. When the message is over, G1 will turn off the speaker and back to scanning.
3-8 Select Single Frequency Monitor	If user wants to monitor one frequency that is not in their channel list of PPS, or want to use G1 as scanner, we suggest switching G1 to Select Single Frequency Monitor. In this mode, G1 can automatically scan within the range of frequency which is set in PPS. When detected pages, G1 will pause scanning and play the message. When the message is over, G1 will turn off the speaker and back to scanning. Also, G1 provides users for entering specific frequency to monitor accordingly.
4-1 Auto Reset	If users want G1 automatically to return to default receiving mode, we suggest set G1 as Auto Reset. In this mode, G1 will go back to the default receiving mode for the next incoming message after ends receiving messages.

PART VI. FEATURE INTRODUCTION

Feature List	Descriptions for each feature
4-2 Delay N Auto Reset	If users' systems have to send individual calls or group calls once, we suggest set G1 as Delay N Auto Reset. G1 will stay receiving messages for N seconds after finished receiving the previous messages. If there are still messages, G1 will keep receiving the message. If there is no message detected, G1 will go back to the default receiving mode for the next incoming message. (There might be noises when G1 is waiting for incoming messages)
4-3 Revert	If users want to keep monitoring all messages in the same frequency after message ends, we suggest set G1 as Revert. In this mode, G1 will automatically change to Monitor Mode after receiving messages. G1 will not go back to default receiving mode until you press "Reset Key".
4-4 Manual Reset	If users want to keep monitoring all messages in the same frequency and letting speaker continuously turning on after message ends, we suggest set G1 as Revert. In this mode, G1 will keep your speaker on automatically after receiving messages. G1 will not go back to default receiving mode until you press "Reset Key".

PART VI. FEATURE INTRODUCTION

Feature List	Descriptions for each feature
4-5 Timeout Reset	In this mode, when G1 receives a message, it will keep receiving the message for N seconds, once the time is up, G1 will stop recording and go back to the default receiving mode. (There might be noises when G1 is waiting for incoming messages.) (In this mode, if the time setting is less than the message total time, then the message might be incomplete.)
4-6 Delay N Revert	If users' systems have to send individual calls or group calls once, and also user wants to keep monitoring all messages in the same frequency after message ends, we suggest set G1 as Delay N Revert . In this mode, after the signal disappeared, G1 will keep receiving signal for N seconds. After N seconds, G1 will detect signals again until finished receiving messages, G1 will switch to Monitor Mode until you press " Reset Key." (There might be noises when G1 is waiting for incoming messages.)
5 Menu Operation	Under the "Menu list", user can find each function and setting of G1, then able to adjust settings according their requirement.

PART VI. FEATURE INTRODUCTION

Feature List		Descriptions for each feature
6	Today	G1 helps the user managing all the unread messages and the alarmed messages received today. Therefore, there are 4 sub-folders under this feature: A. UNCHECKED VOICE MESSAGE B. UNREAD TEXT MESSAGE C. UNACK MESSAGE D. MESSAGE ALARM
7	Function Status	G1 Voice Pager provides "Function Status" for user to quickly check the status of important functions. Also, user can directly modify below features by entering the page of "Function Status": A. ALERT MODE B. ALARM C. AUTO ON/OFF D. DUTY ON/OFF E. ZONE
8-1	Alert Mode	G1 provides users with 5 different alert modes which are shown as below. User can adjust the alert mode in "Function Status" or "Settings". User can also set different alert mode in each "Zone": A. TONE ONLY B. TONE AND VIBRATE C. VIBRATE THEN TONE D. VIBRATE E. SILENT
8-2	Date and Time	G1 provides user with display of date and time. User can set date and time in the "Setting" and all file names of messages will be recorded according to these information.

PART VI. FEATURE INTRODUCTION

Feature List	Descriptions for each feature
8-3 Duty On/Off	If user wants to be not disturbed by message alert tone and also not miss all messages, we suggest to select "Duty on/off" mode to solve the situation. The default factory setting for the function is "Duty On". When it's set "Duty On", all receiving messages will ring with alert tone to remind users. On the other hand, when it's set "Duty Off", G1 will save incoming voice messages but won't make alert tone.
8-4 Auto On/Off	When users want to be not disturbed by messages after their work, even forget turning on pager next day to miss important messages, we suggest users to adopt "Auto on/off" function to solve the situation. The "Auto on/off" function can be set different time of turning on or off based on users' requirement- set G1 "Auto Off" time while they are off duty, then set G1 "Auto on" time while they ready to work.
8-5 Zoom Mode	In the "Zoom Mode", G1 provides user with a better reading display by two different sizes of words, so that they can select the proper size to read according to their requirement.
8-6 Clock Alarm	G1 provides user with 5 different alarmed time. After enabling the function, user can set alarmed time individually in the "Clock Alarm" according to their requirement.

PART VI. FEATURE INTRODUCTION

Feature List	Descriptions for each feature
8-7 Zone Setting	If available 8-Position Function Switch cannot meet the demand of cross area or multi-people use, or users want to categorize receiving channels into different areas, G1 provides user with the "Zone" function to solve this situation. First, users have 8 zones and edit each content in PPS. Each zone can be added up to 8 channels which are referred to 8 positions of the Function Switch.
8-8 SQUELCH LEVEL	The G1 provides users to set the sensitivity of voice broadcasting. The default setting is "Normal" which means user can hear clear voice messages when the strength of signal is normal. However, sometimes it happens that user is located in weak paging signal area and only hear alert but can't hear following voice message. At the moment, G1 can be adjusted Squelch Level based on the environment. Higher Squelch Level represents for better voice quality and less receiving sensitivity. Lower Squelch Level brings better receiving sensitivity and less voice quality relatively. G1 provides 3 squelch levels to be selected: A. Good RF Sensitivity B. Normal C. Good Voice Quality

PART VI. FEATURE INTRODUCTION

Feature List	Descriptions for each feature
8-9 Display Contrast	G1 provides users with adjustable Display Contrast setting by 10 levels. Users adjust the level can according to the brightness in their locations.
8-10 Information	G1 provides "Pager Information." function with users for them to review the critical information in G1: A. Inventory No. : The serial number that is set by customer for controlling the usage of pager. B. User Name : The title set by user. C. Group Name : The group name set by user for managing codeplug. D. S/N: Manufacturing serial number E. Version: Pager software version F. Voice Message Memory: The memory usage of voice messages. G. Voice Memo Memory: The memory usage of voice memos. H. Text Message Memory: The memory usage of text messages. I. IMEI no.: International Mobile Equipment Identity (IMEI) number.

PART VI. FEATURE INTRODUCTION

Feature List	Descriptions for each feature
8-11 Bluetooth	G1 is built in Bluetooth module which can enables the functions of pairing with Bluetooth headset. In this way, users can still hear clear voice messages when they need a quiet environment or even they are located in a noisy surrounding.
8-12 Clear Memory	G1 provides users with the following items to clear memory: A. ERASE VOICE MESSAGE B. ERASE TEXT MESSAGE C. ERASE VOICE MEMO
9-2 Text Message	To read or to respond to a message, you can do the followings with the "Text Message" function: A. PLAY B. LOCK MESSAGE C. DELETE MESSAGE D. VOICE MESSAGE ALARM E. DELETE ALL MESSAGE
9-3 Auto and manual resend send message	If you are in an area where the signal can be weak and you can hear only the ring not the message, or the message is not clear, the Auto and manual resend message function can be implemented asking the message to be resent via GPRS.
9-4 OOR Receiving Message	If you are out of range, OOR Receiving Message will be implemented asking a message to be sent via GPRS.

PART VI. FEATURE INTRODUCTION

Feature List	Descriptions for each feature
10-1 Message ACK	In order that the dispatch center can expedite the message management and the responses from the field personnels, G1 has provided the following functions: A. AUTO ACK(G1 will automatically response acknowledgement when G1 receives message.) B. MANUAL ACK(When G1 receives messages, user can response acknowledgement by select one of replying messages which is displayed on screen. The replying messages are created by PPS.)
10-2 Power On/Off Status ACK	In order that the dispatch center can expedite the message management and the responses from the field personnels, G1 has provided "Power On/Off Status ACK "function to automatically ack the center when the device has been turned on or off.
10-3 Duty On/Off ACK	In order that the dispatch center can expedite the message management and the responses from the field personnels, G1 has provided "Duty On/Off ACK "function to automatically ack the center when the Duty status has been changed.

PART VI. FEATURE INTRODUCTION

Feature List	Descriptions for each feature
10-4 Out of range ACK	In order that the dispatch center can expedite the message management and the responses from the field personnels, G1 has provided "Out of Range ACK" function to automatically ack the center whether or not it is out of range.
10-5 OTA ACK	If the dispatch center needs to execute OTA on an unit or multiple units, G1's OTA ACK function will be implemented. G1 will respond automatically to the Console after an OTA command has been received and executed.
11-1 Voice Memo	G1 provides recording function which is like your own secretary. Under certain circumstance, recording can be activated immediately. Below functions can be executed under "Voice Memo": A. RECORD B. PLAY C. LOCK MESSAGE D. DELETE MESSAGE E. VOICE MESSAGE ALARM F. DELETE ALL MESSAGE
11-2 Unread Message Reminder	G1 provides alert tone when there is any unread message.
11-3 Key Alert	A sound will go off whenever a key is pressed.
11-4 Low Battery Reminder	An alert sound will go off when the battery is running low.

PART VI. FEATURE INTRODUCTION

Feature List	Descriptions for each feature
11-5 OOR Reminder	An alert sound will go off when you are out of range. This sound will stop when you are back in the range or when it has timed out.
11-6 ACK Fail Reminder (GSM Time Out)	An alert sound will go off when you have failed in sending an Ack.
11-7 Message Alert	G1 provides 12 tones (4 are standard while 8 groups are self-edited). Depending on the need, it can be preset via PPS. Different tones are with different Capcodes. The receivers can tell the source of the Capcodes by different alert tones.
11-8 Message Backlight	G1 provides 7 different backlights. Depending on the need, it can be preset via PPS. The receivers can tell the source of the Capcodes by different backlights.
11-9 Empty Channel Reminder	An alert sound will go off when you have turned the "Function Switch" to an unset channel.
12 N/A	For emergency, press and hold the [Function status] key for 2 seconds, G1 will immediately issue a call via PPS setting to the Console.
13-1 Change Receiving Channels	If the dispatch center needs to execute OTA on a unit or multiple units, the Center can use the Console to send an OTA command asking G1 to make a change.

PART VI. FEATURE INTRODUCTION

Feature List	Descriptions for each feature
13-2 Enable/Disable GSM ACK	If the dispatch center needs to execute OTA on a unit or multiple units, the Center can use the Console to send an OTA command asking G1 to make a change.
13-3 Change GSM ACK Phone No (GPRS IP /Port)	If the dispatch center needs to execute OTA on a unit or multiple units, the Center can use the Console to send an OTA "GSM ACK Phone No" command asking G1 to make a change. Also, the Console can send an OTA "GSM ACK GPRS IP/Port" command asking G1 to make a change.
13-4 Change Emergency Call Phone No.	If the dispatch center needs to execute OTA on a unit or multiple units, the Center can use the Console to send an OTA "Emergency call Phone No" command asking G1 to make a change.
13-5 Change Pager Time	If the dispatch center needs to execute OTA on a unit or multiple units, the Center can use the Console to send an OTA "Pager time" command asking G1 to make a change.
14-1 Pager Disable/Enable	If G1 has been lost, the dispatch center can send an OTC to disable the pager via Console, another "enable" OTC command can be sent to activate the unit when the lost G1 has been recovered.

PART VI. FEATURE INTRODUCTION

Feature List	Descriptions for each feature
14-2 Pager Check	The dispatch center can assist you to inspect your communication status via the Console, a 'pager check' command will be sent. G1. After this message is received so that you and the center will know if you are in the range.
14-3 Switch Off Duty to On Duty	When the response signal is weak or more help is needed, the dispatch center use this function to change the status to 'On Duty', then resend messages which will allow you to receive any rescue related information.

PART VI. FEATURE INTRODUCTION

2. FEATURE INTRODUCTION

2-1. POWER ON

Here we introduce you how to power on G1. There are two different ways to turn G1 on, you could program the pager according to your preference.

2-1-1 Manual On

Here we introduce you how to power on G1. There are two different ways to turn G1 on, you could program the pager according to your preference.

Initial Installation:

- a. After you installed the battery, turn the volume knob clockwise to power on G1. You will hear "click" sound between on/off status. Once powering on, the knob will be volume adjustment knob.



- b. G1 will perform self test after powering on. When self test completes, the power led will illuminate. Meanwhile, G1 will display it's welcome page and play voice prompt.
- c. G1 will play the Voice Prompt according to your setting of Function Switch, then proceed to stand-by mode.

Normal Use:

- a. Turn the volume knob clockwise to turn on G1, a "click" sound will prompt between on/off status. Once powering on, the knob will be volume adjustment knob only. LED will illuminate once powering on.
- b. Meanwhile, G1 will display it's welcome page and play a voice prompt.

PART VI. FEATURE INTRODUCTION

2-1-2. Auto On

AUTO ON provides you to set up the time and status you want to have G1 power on automatically according to your preferred time.



- a. G1 will power on automatically when the preset off time is expired while the volume knob is at "Power On".
 - b. Then G1 will display it's welcome page play the voice prompt.
 - c. G1 will proceed to stand-by mode after playing the voice prompt of Function Status you pre-programmed.
- ※ AUTO ON setting please refer to Chapter 2-7-5 of the Part VI.
 - ※ Voice prompt will be varied according to different settings of function mode. You can find the settings in the "Zone" section of PPS.

2-1-3. Self Test

After turning on the pager, the pager will automatically perform a SELF TEST. If the pager works normally, it will proceed to stand-by mode.



PART VI. FEATURE INTRODUCTION

2-2. RECEIVING MODE

2-2-1. Selective Call

If you only want to receive messages contains your ID. We would suggest you to switch to Selective call Mode. In a general situation, this mode is preferred.



In this mode, G1 will only monitor one single frequency and detect paging IDs transmitted by protocols such as 2 tone, 5/6 tone contains G1 programmed ID (Individual IS or Group ID), G1 will generate a Page Alert and perform voice storage. When the message is over, G1 will turn off speaker and back to monitoring the channel.

2-2-2. Monitor Mode

If you want to monitor all messages in the frequency, we suggest switching G1 to Monitor Mode.

You can monitor a certain frequency. When G1 detects pages, G1 will play the message and perform voice storage. When the message is over, G1 will turn off speaker and back to monitoring the channel.

If G1 detects paging IDs transmitted by protocols such as 2 tone, 5/6 tone corresponds to the ID list contains G1 programmed ID (Individual ID or Group ID), G1 will generate a Page Alert and perform voice storage. When the message is over, G1 will turn off speaker and back to monitoring the channel.

PART VI. FEATURE INTRODUCTION

2-2-3. Normal Scan Mode

If you want to monitor multi-frequencies, we suggest switching G1 to Normal Scan Mode. G1 will scanning 2~8 channels in turns which were programmed in PPS setting. If detecting pages in one of the channels, G1 will pause scanning and turn on the speaker to play the message. After the message is played, G1 will turn off speaker and back to scanning the channels.

If G1 detects paging IDs transmitted by protocols such as 2 tone, 5/6 tone corresponds to the ID list contains G1 programmed ID (Individual ID or Group ID), G1 will generate a Page Alert and perform voice storage. When the message is over, G1 will turn off speaker and back to monitoring the channel.

2-2-4. Priority Scan Mode

In Priority Scan, one of the channels will be set as priority channel, the other channels will be regarded as non priority channel. When scanning, G1 will scan the priority channel first then search one of the non- priority channels until a page is detected. When detected pages, G1 will pause scanning and play the message. When the message is over, G1 will turn off the speaker and back to scanning.

If G1 detects paging IDs transmitted by protocols such as 2 tone, 5/6 tone corresponds to the ID list contains G1 programmed ID (Individual ID or Group ID), G1 will generate a Page Alert and perform voice storage. When the message is over, G1 will turn off speaker and back to monitoring the channel.

PART VI. FEATURE INTRODUCTION

2-2-5. Silent Scan Mode

If you want to receive pages contains your ID from multi channels, we suggest switching G1 to Silent Scan Mode.



G1 will scan is there is any paging contains the correspond ID in the pre-programmed channels in the PPS.

If G1 detects paging IDs transmitted by protocols such as 2 tone, 5/6 tone corresponds to the ID list contains G1 programmed ID (Individual ID or Group ID), G1 will generate a Page Alert and perform voice storage. When the message is over, G1 will turn off speaker and back to monitoring the channel.

2-2-6. Dual Channel Scan Mode

If you want to monitor pages from two channels at the same time, we suggest switching to Dual Channel Scan Mode.

G1 will scan one priority channel and one secondary channel. The secondary channel can be chosen manually from the pre programmed channels.

When detected pages, G1 will pause scanning and play the message. When the message is over, G1 will turn off the speaker and back to scanning.

If G1 detects paging IDs transmitted by protocols such as 2 tone, 5/6 tone corresponds to the ID list contains G1 programmed ID (Individual ID or Group ID), G1 will generate a Page Alert and

PART VI. FEATURE INTRODUCTION

perform voice storage. When the message is over, G1 will turn off speaker and back to monitoring the channel.

- A. Unlock the secondary channel
When in Stand- by mode, the cursor will stay channel lock.



- Press OK to unlock secondary channel.
 - Press OK again to lock secondary channel.
- B. Select secondary channel manually
After unlocking secondary channel, press ▲▼ to view the preprogrammed channels.



- Press▲ ▼ channel the cursor will move up/down to select the preprogrammed channel.
 - Press ▲ ▼ for 3 seconds:G1 will scang the secondary automatically.
 - Press ▲ ▼ again to stop scanning.
- C. Set the secondary channel as the Default secondary channe
After choosing the preferred secondary channel, press ◀▶ select SAVE(),the press OK to save the chosen channel.
- D. Change back to the original default secondary channel

PART VI. FEATURE INTRODUCTION

- i. After choosing secondary channel manually, you can still choose to go back to your default channel.
- ii. Press ◀▶ to Toggle(↔) then press OK to go back to default

2-2-7. Select Single Channel Monitor

When detected pages, G1 will pause scanning and play the message. When the message is over, G1 will turn off the speaker and back to scanning. G1 provides auto scan and manual scan:

A. Auto Scan Frequency.

- i. Press OK to unlock the current frequency.







- ii. Press ▲ to increase frequency, press and hold ▲ for 2 seconds to keep scanning frequency upwards. Press ▲ again to stop scanning.
- iii. Press ▼ to decrease the frequencies. Press and hold ▼ for 2 seconds to keep scanning frequencies downwards. Press ▼ again to stop scanning.
- iv. Press Save (⏏) to save the frequency stopped at. When stop on different channels, press Toggle (↔) to return to previously saved frequency.



PART VI. FEATURE INTRODUCTION

B. Manual Scan.



- i. Press OK to unlock the current frequency.
- ii. Move the cursor horizontally and press Enter () to enter the paging for entering frequency.
- iii. Press   to increase or decrease frequency. Press Move Cursor () to move to next digit.
- iv. Press Return () after entering the frequency and back to scanning screen.

2-2-8. Select Single Frequency Monitor



You can monitor a certain frequency. When G1 detects pages, G1 will play the message and perform voice storage. When the message is over, G1 will turn off speaker and back to monitoring the channel. G1 provides auto scan and manual scan:

- i. Press OK to unlock the current frequency.





- ii. Press  to increase frequency, press and hold  for 2 seconds to keep scanning frequency upwards. Press  again to stop scanning.



- iii. Press  to decrease the frequencies. Press and hold  for 2 seconds to keep scanning

PART VI. FEATURE INTRODUCTION

frequencies downwards. Press ▼ again to stop scanning.

- iv. Press Save () to save the frequency stopped at. When stop on different channels, press Toggle () to return to previously saved frequency.

B. Manual Scan

- i. Press OK to unlock the current frequency.
- ii. Move the cursor horizontally and press Enter () to enter the paging for entering frequency.



- iii. Press ▲ ▼ to increase or decrease frequency. Press Move Cursor () to move to next digit.

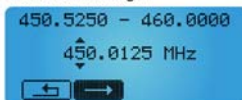

- iv. Press Return () after entering the frequency and back to scanning screen.

2-3. RESET MODE

After receiving messages, message ending mode can be pre-programmed in the PPS as following:

- AUTO RESET
- DELAY N AUTO RESET
- REVERT
- MANUAL RESET
- TIMEOUT RESET
- DELAY N REVERT

PART VI. FEATURE INTRODUCTION

2-3-1. Auto Reset

In this mode, G1 will go back to the default receiving mode for the next incoming message after receiving messages.

2-3-2. Delay N Auto Reset

G1 will stay receiving messages for N seconds after finished receiving the previous messages. If there are still messages, G1 will keep receiving the message. If there is no message detected, G1 will go back to the default receiving mode for the next incoming message.

⊛ There might be noises when G1 is waiting for incoming messages.

2-3-3. Revert

G1 will automatically change to Monitor Mode after receiving messages. G1 will not go back to default receiving mode until you press "Reset Key".

2-3-4. Manual Reset

G1 will keep your speaker on automatically after receiving messages. G1 will not go back to default receiving mode until you press "Reset Key".

2-3-5. Timeout Reset

G1 will keep receiving messages for N seconds, once time is up, G1 will stop recording and go back to the default receiving mode.

⊛ There might be noises when G1 is waiting for incoming messages.

⊛ In this mode, if the time setting is less than the message total time, then the message might be incomplete.

PART VI. FEATURE INTRODUCTION

2-3-6 . Delay N Revert

After the signal disappeared, G1 will keep receiving signal for N seconds. After N seconds, G1 will detecting signals again until finished receiving messages, G1 will switch to Monitor Mode until you press "Reset Key."

※ There might be noises when G1 is waiting for incoming messages.

2-4 . MENU OPERATION

G1 provides many functions for you. Press Menu key to enter Menu List. You can operate below 9 functions:

- TODAY
- FUNCTION STATUS
- VOICE MESSAGE
- TEXT MESSAGE
- VOICE MEMO
- SETTINGS
- EMERGENCY CALL
- BLUETOOTH

2-5 . TODAY

G1 helps the user managing all the unread messages and the alarmed messages received today. Therefore, there are 4 sub-folders under this feature:

- UNCHECKED VOICE MESSAGE
- UNREAD TEXT MESSAGE
- UNACK MESSAGE
- MESSAGE ALARM

2-5-1 . Entering Today

- a. Press Menu key to display the main menu list.
- b. After entering the main menu list, the cursor will stay on "TODAY".

PART VI. FEATURE INTRODUCTION

c. Press OK to enter "TODAY".

2-5-2. Today's Un-checked Voice Message

a. In Today function, the cursor will stay at "Today Un-checked Voice Message".

b. Press OK to enter "Today Un-checked Voice Message".



c. All the voice messages that are received today but not listened yet will be listed in chronological order.

d. Depress ▲▼ to select the desired voice message.

※ Please refer to the introduction of chapter 2-8-1 Voice Message for the operation to listen to the voice message.

2-5-3. Today's Un-read Text Message

a. In Today screen, the cursor will stay at "Today Un-read Text Message".



b. Press OK to enter " Today Un-read Text Message ".

c. All the text messages that are received today but not listened yet will be listed in chronological order.

※ When there is an un-checked text message a reminder alert will be played regularly to

PART VI. FEATURE INTRODUCTION

remind user to check (The function is programmed by PPS.)

2-5-4. Today's Un-ACK Message

- a. In Today screen, press "▲▼" and "OK" to enter the Un-ACK Message folder.
- b. Un-ACK message folder will be displayed on the screen.



- ※ In this folder, you are not allowed to send the acknowledgement message back after a certain period of time, you can only review and check the message content.
- ※ If the user would like to listen to all voice messages or to read text messages, please refer to the introduction of chapter 2-8-1 Voice Message and 2-8-2 Text Message.

2-5-5. Alarmed Message

- a. Press ▲▼ "Today" screen, and check the message box. Alarmed Voice message and alarmed text message alarms will be listed.
- b. Press "Today" to enter the Alarmed Message.
- c. Today's Alarmed Message will be displayed.



- d. Operate "▲▼" to select the message, press "OK" to listen to the selected voice message.

PART VI. FEATURE INTRODUCTION

- ※ The messages include both text message and the voice message.
- ※ Please refer to introduction chapter 2-8-1 and 2-8-2 to set alarm to voice and text message.

2-6. FUNCTION STATUS

G1 Voice Pager also have "Function Status" for the user to check the status of important features, also, the user can modify below features:

- ALARM MODE
- ALARM ON/OFF
- DUTY ON/OFF F
- AUTO ON/OFF
- ZONE

2-6-1. Entering Function Status

There are 2 approaches to enter Function Status: <Approach 1> Entering from "FUNCTION STATUS"(Basic Model):

- a. Press Function Status to enter the Function Status function page.



- b. The cursor will stay on the first item-Alert Mode.

<Approach 2> Entering by Menu

- a. Press "Menu", the main menu will be displayed.
- b. Operate "▲ ▼" and move the cursor to Function Status.

PART VI. FEATURE INTRODUCTION

- c. Press "OK" to enter Function Status, the cursor will stay on the first item-Alert Mode.

2-6-2. Alert Mode

After entering Function Status, the cursor will stay on Alert Mode.

Press "OK" to switch the setting items under Alert Mode. There are 5 options:



- TONE
- TONE&VIBRATE
- VIBRATE THEN TONE
- VIBRATE
- SILENT

2-6-3. Alarm

In Function Status, press ▲▼ to move the cursor to Alarm.

- a. Press "OK" to enable or disable the selected Clock Alarm.



PART VI. FEATURE INTRODUCTION

2-6-4. Duty On/Off

- Operate "▲▼" in Function Status, and move the cursor to DUTY ON/OFF.
- Press "OK" to enable or disable the function.



2-6-5. Auto On/Off

- Operate "▲▼" and move the cursor to AUTO ON/OFF.
- Press "OK" to enable or disable this function.



2-6-6. Zone

- Operate "▲▼" and move the cursor to ZONE. There are 8 feature options in each ZONE for GT's message receiving.



- Press "OK" to enable or disable this function.
- Press "◀▶" to move the cursor to, click "OK" to select the desired ZONE.
- Move the cursor to SAVE(), press "OK" to save the operation.

PART VI. FEATURE INTRODUCTION

e. After the ZONE selection, the 8 positions of the function switch will be followed by the pre-programmed settings.

f. Press "OK" for entering the selected zone.

2-7. SETTINGS

In setting function, users are allowed to make personal feature settings as below:



- ALERT MODE
- DATE & TIME
- DUTY ON/OFF
- AUTO ON/OFF
- ZOOM MODE
- CLOCK ALARM
- ZONE
- SQUELCH LEVEL
- DISPLAY CONTRAST
- INFORMATION
- PAGER TEST
- CLEAR MEMORY

2-7-1. Entering Settings

1. Press Menu to enter the MAIN MENU.
2. Operate "▲▼" to move the cursor to "SETTINGS"
3. Press "OK" to enter the Pager Settings.



PART VI. FEATURE INTRODUCTION

2-7-2. Alert Mode

This feature allows to user to make different alarm settings by different operation mode, which also avoids unnecessary trouble while a silent environment is required.

- a. The cursor will stay on ALERT MODE after enter the Pager Setting.
- b. Press "OK" to enter ALERT MODE.
- c. There are 5 options for the user after entering ALERT MODE.



The options are:

- TONE
- TONE&VIBRATE
- VIBRATE THEN TONE
- VIBRATE
- SILENT

- a. Operate "▲▼" to move the cursor to select the desired ALERT MODE.
- b. Press OK, the G1 will automatically save the setting; Press "OK" again to go back to SETTINGS.



※ The icon of ALERT MODE will be displayed in the stand by screen.

PART VI. FEATURE INTRODUCTION

2-7-3. Date & Time

This function allows the user to check time and date when stand by. Please Operate "▲▼" to move the cursor to DATE & TIME in Pager Setting. Press "OK" to enter DATE & TIME. 4 settings (A~D) will be needed in DATE & TIME page:



- A. Date Format
 - 3 options are provided:
 - i. Press "OK" to adjust date format.
 - ii. Operate "▲▼" to move the cursor to DATE FORMAT.
- B. Date
 - i. The cursor will stay on "YEAR" in DATE & TIME page, press "OK" to adjust the year.
 - ii. Operate "▲▼" to move the cursor to next item-MONTH, press "OK" to adjust the month.
 - iii. Operate "▲▼" to move the cursor to TIME.
- C. Time
 - i. Operate "▲▼" to move the cursor to next item-Time-Hour, press "OK" to adjust the Time-Hour.
 - ii. Operate "▲▼" to move the cursor to next item-Time-Hour, press "OK" to adjust the Time-Minute.
 - iii. Operate "▲▼" to move the cursor to next item-Time Format

PART VI. FEATURE INTRODUCTION

D. Time Format

- 2 options are provided, 12-hour and 24-hour:
- Press "OK" to adjust time format.
 - Operate "▲▼" to move the cursor the SAVE (⏪⏩).
 - Press "OK" for save the setting, click "OK" again to go back to SETTINGS.

2-7-4. Duty On/off

The user will not be informed when receiving messages in Off Duty; In contrary, the user will be informed by message alarm when they set On Duty. The G1 will activate speaker while receiving messages from specific selective call. However, the G1 will record all the received messages while Off Duty is activated.

- Operate "▲▼" to move the cursor to DUTY ON/OFF in Pager Setting.
- Press "OK" to enter DUTY ON/OFF.



- The cursor will stay on FUNCTION STATUS-ON DUTY after entering this function.
- Operate "▲▼" to select ON DUTY or OFF DUTY.
- Press "OK" to save the settings.
- Press "OK" to go back to SETTING.

※ When OFF DUTY is activated, the OFF DUTY icon will be displayed in status bar.

PART VI. FEATURE INTRODUCTION

2-7-5. Auto On/Off

The G1 Voice Pager allows the user to set the auto on / off time. The G1 will automatically turn on while on duty, and turned off while off duty.

a. Operate "OK" to move the cursor to AUTO ON/OFF in Pager Setting page.



b. Press "OK" to enter AUTO ON/OFF, the cursor will stay on Function Status.

c. Press "OK" to enable or disable this function.

d. Operate "OK" to move the cursor to ON TIME.

e. Press "OK" to adjust the time.

f. Operate "▲▼" to move the cursor to OFF TIME.

g. Press "OK" to adjust the time.

h. Operate "◀▶" to move the cursor to SAVE ()

i. Press "OK" to save the setting.

j. Press "OK" to go back to Setting.

* The icon of Auto On/Off will be displayed in status bar when Auto On / Off is activated.

PART VI. FEATURE INTRODUCTION

2-7-6. Zoom Mode

The function can enlarge the screen for the user to have a better reading status.

- Operate "▲▼" to move the cursor to ZOOM Mode in Pager Setting.
- Press "OK" to enter ZOOM IN/OUT.
- The cursor will stay in ZOOM IN/OUT.



- Operate "▲▼" to move the cursor to ZOOM IN/OUT.
- Press "OK" for confirmation.
- The information will be displayed as enlarged font.
- Press "OK" to go back to Setting.

2-7-7. Clock Alarm

The user are allowed to set the cycle alarm on G1. 5 alarms settings are provided:

- Operate "▲▼" to move the cursor to ALARM in Pager Setting.
- Press "OK" to enter ALARM, there are 5 alarms for the user to select.
- The cursor will stay on the first alarm, operate "▲▼" to select desired ALARM.
- Press "OK" to enter selected ALARM.

After entering the selected ALARM, there are 3 items need to be set:

- ALARM STATUS
- ALARM CYCLE
- ALARM TIME

PART VI. FEATURE INTRODUCTION

A. Alarm Status

- i. The cursor will stay on ALARM STATUS in ALARM.
- ii. Press "OK" to enable or disable the alarm status.
- iii. Operate "▲▼" to move the cursor to ALARM TIME-Hour Settings.



B. Alarm Time



- i. Press "OK" to adjust the time.
Operate "▲▼" to move the cursor to ALARM.



- ii. TIME-Minute Settings.
- iii. Press "OK" to adjust the time.
- iv. Operate "▲▼" to move the cursor to ALARM CYCLE after time setting.

C. Alarm Cycle

2 options are provided in ALARM CYCLE page:
Once or Dairy

- i. Press "OK" to adjust ALARM CYCLE.
 - ii. Operate "◀▶" to move the cursor to SAVE ().
 - iii. Press "OK" to confirm the setting and go back to SETTING.
- ⊗ The Clock icon () will be displayed in status bar after the alarm function is activated.

PART VI. FEATURE INTRODUCTION

2-7-8. Zone

If available 8-Position Function Switch cannot meet the demand of cross area or multi-people use, you can use Zone setting to add a new zone for the 8-Position Function Switch. The G1 allows multiple Zone Settings for customizing how the G1 responds to receive messages:

- a. In Pager Settings, operate ▲▼ to move the cursor to ZONE. G1 provides 8 zones can be programmed by PPS. For each zone, there are 8 programmed functions can be selected by rotating the "Function Switch Knob". The functions determine how the pager responds to received messages.



- b. Press "OK" to enter ZONE.

The pre-programmed zone will list on the screen.

- c. Operate ▲▼ to select a desired zone.
- d. Press "OK" to save the selection.
- e. Press "OK" again to return to SETTINGS list.

After a period of time, the display reverts to stand-by mode.

2-7-9. Squelch Level

The G1 provides users to set the sensitivity of voice broadcasting. You can adjust Squelch Level based on the environment. Higher Squelch Level is for better voice quality, and

PART VI. FEATURE INTRODUCTION

lower Squelch Level is for better receiving sensitivity.

G1 provides 3 squelch levels Settings to be selected:

- a. In "Pager Settings", operate ▲▼ to move the cursor to "SQ LEVEL".
- b. Press "OK" to enter "SQ LEVEL".

There are 3 options:

- GOOD SENSITIVITY
- NORMAL
- GOOD VOICE QUALITY

- c. Operate "▲▼" to select the option.



- d. Press "OK" to save the selection.
- e. Press "OK" to again to return to SETTINGS list.

2-7-10. Display Contrast

- a. In "Pager Settings", operate ▲▼ to move the cursor to "DISPLAY CONTRAST".
- b. Press "OK" to enter "DISPLAY CONTRAST".
- c. After entering "DISPLAY CONTRAST", the cursor stays on "Contrast Level".
- d. Operate ▲▼ to adjust the "Contrast Level", the display contrast changes by the Settings.

PART VI. FEATURE INTRODUCTION



- e. Press "OK" to save the Settings.
- f. Press "OK" to again to return to SETTINGS list.

2-7-11. Information

You can review the information of the G1 and memory usage by this function. G1 provide Pager Info. function to review the critical information about G1.

- a. In SETTINGS screen, operate ▲▼ to move the cursor to "INFORMATION".
- b. Press "OK" to enter INFORMATION screen.

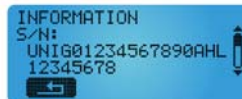

There are 8 types of information on the page:

- INVENTORY NO. :
The serial number that is set by customer for controlling the usage of pager.
- USER NAME :
The title set by user.
- GROUP NAME :
The group name set by user for managing codeplug.
- S/N:
Manufacture serial number

PART VI. FEATURE INTRODUCTION

- VERSION:
Pager software version
- VOICE MESSAGE MEMORY:
The memory usage of voice messages.
- VOICE MEMO MEMORY:
The memory usage of voice memos.
- TEXT MESSAGE MEMORY:
The memory usage of text messages.

2-7-12. Pager Test

You can use the "Pager Test" function to test the G1 hardware functions. In SETTINGS screen, operate ▲▼ to move the cursor to "PAGER TEST". Please press "OK" to enter the PAGER TEST. There are 9 functions can be tested:

- LED TEST
- BACKLIGHT TEST
- LCD TEST
- ALERT TEST
- VIBRATOR TEST
- RF TEST
- KEY TEST
- GSM TEST
- BLUETOOTH TEST

A. LED Test

3 options are provided:

- In PAGER TEST page, the cursor stays on LED TEST.
- Press "OK" to enter LED TEST.



PART VI. FEATURE INTRODUCTION

- iii. Operate "▲▼" to adjust the LED color.
- iv. 2-LEDs change with the selection.
- v. Press "OK" to return to PAGER TEST list.



B. Backlight Test

- i. In PAGER TEST page, operate ▲▼ to move the cursor to BACKLIGHT TEST.
- ii. Press "OK" to enter BACKLIGHT TEST.
- iii. Operate "▲▼" to adjust the color of BACKLIGHT.



- iv. The backlight changes with the selection.
- v. Press "OK" to return to PAGER TEST list.

C. LCD Test

- i. In PAGER TEST page, operate ▲▼ to move the cursor to LCD TEST.
- ii. Press "OK" to enter LCD TEST.
- iii. Operate "▲▼" to switch between NORMAL and REVERSE.



PART VI. FEATURE INTRODUCTION

- iv. In PAGER TEST page, operate ▲▼ to
- v. move the cursor to LCD TEST.
Press "OK" to enter LCD TEST.
Operate ▲▼ to switch between NORMAL and REVERSE.

E. Alert Test

- i. In PAGER TEST page, operate ▲▼ to move the cursor to ALERT TEST.
- ii. Press "OK" to enter ALERT TEST.
- iii. Press "OK" again to activate the ALERT TEST. The pager turns on the speaker and generates an alert tone to test if the alert function is working normally.
- iv. When "FIX ALERT" is selected, press "OK" to activate the test. The pager will play the alert tone with the highest volume.



- v. When "ADJUSTABLE ALERT" is selected, press "OK" to activate the test.
You might rotate the "Volume Knob" to adjust the volume level.
- ### F. Vibrator Test
- i. In PAGER TEST page, operate ▲▼ to move the cursor to VIBRATOR TEST .
 - ii. Press "OK" to enter VIBRATOR TEST.
 - iii. Operate ▲▼ to switch ON or OFF the VIBRATOR TEST. When switch on the test, the pager starts to vibrate.

PART VI. FEATURE INTRODUCTION



iv. Press "OK" to return to PAGER TEST list.

G. RF Test

- i. In PAGER TEST page, operate ▲▼ to move the cursor to RF TEST.
- ii. Press "OK" to enter RF TEST.
- iii. Operate ▲▼ to switch ON or OFF the RF TEST. When switch on the test, G1 activates the speaker and broadcasts the signal transmitting over the air.





iv. Press "OK" to return to PAGER TEST list.

H. Key Test

- i. In PAGER TEST page, operate ▲▼ to move the cursor to KEY TEST.
- ii. Press "OK" to enter KEY TEST.
- iii. When any buttons are pressed, the button illustration is marked on the display.



- iv.  indicates the selected Function Switch.
- v. Operate "◀▶" to move the cursor to BACK ().
- vi. Press "OK" to return to PAGER TEST list.

PART VI. FEATURE INTRODUCTION



- ERASE VOICE MESSAGE
 - ERASE TEXT MESSAGE
 - ERASE VOICE MEMO
- c. Operate "▲▼" to move the cursor to the desired item.
Press "OK" to erase the memory.
- d. Confirmation pops up on the screen. Press "OK" again to confirm selection.



- e. Operate "◀▶" to move the cursor to BACK (◀). Press "OK" to return to Setting page.

2-8. RECEIVING MESSAGE

G1 has multiple modes for receiving messages to meet the demand of the environment. You can select appropriate message mode base on the Protocol and environment.

2-8-1. Voice Message

When the G1 receives the voice message, it broadcasts and stores the received voice message automatically. The followings items are the functions that G1 provides for the Voice Message:

PART VI. FEATURE INTRODUCTION



- A. Broadcasting Voice Message
- When a voice message is received, the Message LED flashes with RED. The receiving Voice Message is broadcasted.
 - Press "OK" to turn off the speaker. The Silent Receiving Mode is activated.
 - After broadcasting the voice message, the G1 returns to stand-by mode depending on the pre-programmed RESET MODE.
 - ※ The auto broadcast voice message is considered as Un-checked voice message until it is listened manually.
 - ※ The voice message is displayed with the time stamp and source prompt.
 - ※ As certain Call ID is paged, Alert tone of the voice message will be played based on pre-programmed call ID set by PPS.
- B. Play Back Voice Message
- There are two methods to listen to a stored voice message:
- B.1 Listen to the voice message directly
- There are two methods to listen to a stored voice message:
- Press the "Play Key" on the top of the "FUNCTION SWITCH knob".
 - The G1 starts to broadcast from the last stored voice message. The G1 generates a chirp to indicate voice message broadcasting is finished. Two chirps indicate all messages broadcasting are finished.

PART VI. FEATURE INTRODUCTION

B.2. Lock Voice Message

The G1 allows messages to be locked to protect them from being deleted automatically when the message memory is full:

- c. Press "OK" to enter voice message. The screen displays the Voice messages, listed from the newest one.
- d. Operate "▲▼" to select voice message. Press "OK" to listen.
- e. When you are listening to the Voice message, the screen displays the source prompt, time stamp, and message length of the message.
- f. The cursor of the Toolbar stays on "PLAY". Press "OK" to listen to the selected voice message. The broadcasting time (hours / minutes) begins to count.



- g. Press "OK" again to pause the voice message.



- C. Listen to Next Stored Voice Message
 - i. Operate "▲▼" to enter next voice message.
 - ※ The screen displays the time stamp, source prompt and voice message length.
- D. Stop Broadcasting Stored Voice Message
 - i. Press ◀ move the cursor to stop (▶■).
 - ii. Press "OK" to stop the broadcasting.

PART VI. FEATURE INTRODUCTION

E. Lock Voice Message

The G1 allows messages to be locked to protect them from being deleted automatically when the message memory is full:

- i. Press **◀▶** to move the cursor on the tool bar to LOCK ().
- ii. Press OK key to lock the selected voice message.
※ A "locked" icon will be displayed in the message list indicating the selected message is locked, and cannot be deleted from message memory.

F. Unlock Voice Message

If you are going to unlock messages, please refer to the following steps:

- i. Select the voice message that you would like to unlock. Press **◀▶** to move the cursor to the tool bar "UNLOCK" ().
- ii. Press "OK" to unlock the selected message.

G. Voice Message Alarm

After listening to the stored message, if you would like to listen to the stored message again at a certain time, you may set a message alarm:

- i. Depress **◀▶** to move the cursor on the tool bar to ALARM ().
- ii. Depress OK key to enter message alarm Settings.

There are 2 settings in Alarm Settings screen:

- MESSAGE ALARM STATUS
- ALARM TIME SETTINGS

G.1 Message Alarm Status

In Message Alarm screen, the cursor will stay on "Message Alarm Status". Depress OK Key to switch the Status On or Off.

PART VI. FEATURE INTRODUCTION





G.2. Alarm Time Settings

- a. Press ▲▼ to move the cursor to "Alarm Time".
- b. Press OK Key to adjust the Message Alarm Time-HOUR.
- c. Press ▲▼ to move the cursor to "Alarm Time"-MINUTE.
- d. Press OK Key to adjust the Message Alarm Time- MINUTE.
- e. Press ◀▶ to move the cursor on the tool bar to SAVE (), then press OK to confirm and save the Settings.
 - * An "alarm" icon will display in the message list to indicate the selected message is set with an alarm. When the alarm time expires, the G1 will activate a message alarm reminding the user to listen the message again.



H. Delete Voice Message

After listening to the stored message, you may delete the message:

- i. Press ◀▶ to move the cursor on the tool bar to ().
- ii. Press OK key to delete the selected voice message.
- iii. A "confirmation" will pop-up, operate ◀▶ to move the cursor on the tool bar to YES (), then press OK to confirm the deletion.

PART VI. FEATURE INTRODUCTION



- ※ If the voice message is set as "Locked message" or "Alarmed message", the display won't show the icon () for delete message.
- ※ If G1 has saved other voice messages, the display will show next saved message when delete one message.
- ※ If there's no voice message in G1, the screen will display "No Voice Message" and return to main menu page.
- ※ If user wants to delete all voice messages, please back to the screen of voice message list and press the icon () to delete.

2-8-2. Text Message

When the G1 receives a text message, the message LED flashes RED. As certain Call ID is paged, alert tone of the text message will be played based on programmed call ID setting which is set by PPS:

A. Read Text Message

You have 2 ways to read messages:

A.1. Read Message by pressing "READ KEY".

When receiving a text message, the Message LED flashes RED.

- a. When there is unread message, press "READ Key" to display the last unread message. When there is no unread message, press "READ Key" to enter the message list. The cursor will then stay

PART VI. FEATURE INTRODUCTION

- a. When there is unread message, press "READ Key" to display the last unread message. When there is no unread message, press "READ Key" to enter the message list. The cursor will then stay on the first message. Press "OK Key" to enter the selected message.
 - ⊛ The time stamp and source prompt will display with messages.
- b. Press "Down KEY" to read the next page of the message.
- c. Press **◀▶** to move the cursor on the tool bar to NEXT MESSAGE (**Ⓜ↓**) or PREVIOUS MESSAGE (**Ⓜ↑**) to read the previous or next text message.





- A.2. Read Message from "MENU KEY"
- a. Press "MENU KEY" to display the main menu list.
 - b. Press **▼** to move cursor and press "OK" to enter the selected text message.





- c. The message list will display in chronological order.
 - ⊛ The time stamp and source prompt will display with messages.

PART VI. FEATURE INTRODUCTION

- d. Press  to move the cursor on the tool bar to NEXT MESSAGE () or PREVIOUS MESSAGE () to read the previous or next text message.



- B. Other Features For Text Message
After reading text messages, depending on the importance of the messages, the following actions are allowed:
- LOCK/UNLOCK TEXT MESSAGE
 - TEXT MESSAGE ALARM
 - DELETE MESSAGE
- B.1. Lock/Unlock Text Message
A message can be locked to protect it from being deleted when memory is full.
- a. Depress  to move the cursor on the tool bar to LOCK ().



- b. Depress OK key to lock the selected text message.
- ※ A "locked" () icon will display in the message list indicating which message is locked and cannot be deleted.
- If you are going to unlock messages, please refer to the following steps:

PART VI. FEATURE INTRODUCTION

- a. Select the voice message that you would like to unlock. Press "◀▶" to move the cursor to the tool bar "UNLOCK" ().
- b. Press "OK" to unlock the selected message.

B.2. Text Message Alarm

After reading the stored message, if you would like to read the message again at a certain time, you may set the message alarm:

- a. Depress "◀▶" to move the cursor on the tool bar to ALARM ().
- b. Depress OK key to proceed to the Settings of message alarm.

There are 2 Settings in Alarm Settings screen:

- Message Alarm Status
- Alarm Time Settings

B.2.1. Message Alarm Status

In the Message Alarm screen, the cursor will stay on "Message Alarm Status". Press OK Key to switch the Status On or Off.

B.2.2. Alarm Time Settings

- a. Press ▲▼ to move the cursor to "Alarm Time".
- b. Press OK Key to adjust the Message Alarm Time-HOUR.
- c. Press ▲▼ to move the cursor to "Alarm Time" -MINUTE.
- d. Press OK Key to adjust the Message Alarm Time- MINUTE.
- e. Press "◀▶" to move the cursor on the tool bar to SAVE (), then press OK to confirm and save the Settings.





※ An "alarm" icon will display in the message list to indicate the selected message is set with an alarm. When the alarm time expires, the G1 will activate a message alarm

PART VI. FEATURE INTRODUCTION



reminding the user to listen the message again.

C. Delete Text Message

After listening to the stored message, you may delete the message:

- i. Press  to move the cursor on the tool bar to ().
- ii. Press OK key to delete the selected voice message.
- iii. A "confirmation" will pop-up, operate  to move the cursor on the tool bar to YES (), then press OK to confirm the deletion.



- * If the text message is set as "Locked message" or "Alarmed message", the display won't show the icon () for delete message.
- * If G1 has saved other text messages, the display will show next saved message when delete one message.
- * If user wants to delete all text messages, please back to the screen of text message list and press the icon () to delete.

2-8-3. Auto and Manual Resending Messages

G1's Auto and Manual Resending Messages function provide users to resend message when receiving paging but finds no voice message or receiving an unclear message. This keeps G1 users remain clear communication and don't lose important messages:

PART VI. FEATURE INTRODUCTION

- a. When G1 receives paging but finds no voice messages, G1 will automatically acknowledge to the Uni Voice Pager Console and request it to resend the message through GPRS network.
- b. Also, G1 is capable of letting user manually acknowledge to the Uni Voice Pager Console and request it to resend the message through GPRS network. As the voice message is received, the "Resend" icon, , will show on the toolbar and then you can press the icon to resend the message.

2-9 . ACKNOWLEDGMENT

2-9-1. Message ACK



When dispatcher center send messages to G1 pager, the message will request for ACK from G1 pager. This feature helps the commander to understand your receiving message status and participation status.

A. Auto ACK

When G1 receives message , G1 will automatically send Received ACK to Uni voice pager console. The dispatcher center will note the message has been received.

B. Manual ACK

If this message is required to send the acknowledgement back control center, the ACK icon () will be displayed on the tool bar:

- i. After reading the message, press  to move the cursor on the tool bar to MESSAGE ACK () , the assigned SMS will display the text message content.

PART VI. FEATURE INTRODUCTION



- ii. Depress ▲▼ to select the canned message to be sent back to the console.



- iii. Press ◀▶ to move the cursor on the tool bar to YES (✓), then press OK to send the selected message out.



- iv. Depress OK to return back to the message list.
- ※ The status of message ACK will display on message list. When the pager is sending ACK messages, The "ACK MESSAGE (☑→)" icon will be displayed on the screen.
 - ※ The screen will display ACK FAIL (☑✗) when the pager fails to send ACK message. The ACK message can only be sent within the allowed ACK time. If the screen displays ACK TIMEOUT (☑⌚), this means the ACK transmit time expires and the ACK function cannot be attempted again.

PART VI. FEATURE INTRODUCTION

2-9-2. Power On/Off Status ACK

G1's Power On/Off Status ACK is capable of making an acknowledgment to Uni Voice Pager Console to notice its status which helps dispatchers to manage assignments in a more efficient way. Each time user turn on or off G1, G1 will automatically inform the status of G1 to Uni Voice Pager Console.

Here are two situations which will enable G1 to process an acknowledgment to Uni Voice Pager Console:

- a. User turns on or off G1 manually.
- b. User has set Auto On & Off function and the time is up.
※ This function is programmed by PPS.

2-9-3. Duty On/Off ACK

G1 pager will detect the current Duty on/off status and send the ACK to Uni Voice Pager Console. The dispatcher center will note the message has been received.

※ This function is programmed by PPS.

2-9-4. Out of Range ACK

G1's Out of Range Acknowledgement function regularly checks the status of paging signal coverage, while G1 sends Acknowledgement to inform G1's Voice Pager Console. At the same time, G1's GSM/GPRS function will be enabled. The Voice Pager Console will then be able to send messages to G1 through GSM/GPRS network.



PART VI. FEATURE INTRODUCTION

- ※ When G1 is out of paging signal coverage, the icon "P" will disappear. It will appear again when it's in range of paging signal coverage.
- ※ When G1 pager is out of paging signal coverage, the reminder alert and window will pop out.
- ※ Pattern of reminder alert can be set in G1 PPS.

2-9-5. OTA ACK

- When G1 receives OTA messages, G1 will send OTA ACK automatically to Uri Voice Pager Console when OTA command is complete.
- ※ This function is programmed by PPS.

2-10. REMINDER

G1 pager provides various reminder alerts for different status and display the text reminder on the screen. Below are different statuses of reminder alert.

2-10-1. Voice Memo



The G1 provides "Voice Recorder" as your personal assistant:

- A. Record the voice memo
- a. Press RECORD Key to direct recording a voice memo. A confirmation window will pop-up.
 - b. Operate "◀▶" to move the cursor to YES (✓).



- c. Press "OK" to confirm voice recording. The timer will display the recording length. It shows MM (minutes): SS (seconds) as the indication.

PART VI. FEATURE INTRODUCTION

- B. To PAUSE the voice recording
- When the pager is recording voice, press "▶" to PAUSE ().
 - Press OK to "PAUSE" recording.
 - To continue the recording press "▶" to PLAY () and press "OK" to keep recording.
- C. To STOP & SAVE the voice recording
- While recording voice, the cursor stays on STOP & SAVE ().



- Depress OK to stop the recording, the recording voice will be saved and named with recording date, time and the length of the voice memo.
- D. To PLAY the recorded voice memo
- When the voice recording is saved, users are allowed to play the recorded voice memo by following below operations:
- Press "Menu key" to display the main menu list. The recorded voice memo list will display.
 - Press ▲▼ to move the cursor to the desired voice memo.



- Press OK to enter voice memo information, and the screen will display recording information of voice memo.

PART VI. FEATURE INTRODUCTION

- d. Press OK to play () the selected voice memo. The voice memo will start playing, and the timer will start.







E. To Set Voice Memo Alarm

When the voice recording is saved, the file name of the voice memo will display on the voice memo list. You may also set the saved voice memo as an alarm. The operations are exactly the same as the "VOICE MESSAGE ALARM". Please refer to the chapter 2-8-1.

F. To DELETE the recorded voice memo

When the voice recording is saved, the file name of the voice memo will display on the voice memo list. You can delete the saved voice memo on the list.

- a. Press "" to move the cursor to DELETE ().
- b. Press OK to delete the recorded voice memo, a delete confirmation will pop-up.
- c. Press "" to move the cursor to YES (), and press "OK" to confirm the deletion.



* If user wants to delete all recorded voice memo, please back to the screen of recorded voice memo list and press the icon () to delete.

PART VI. FEATURE INTRODUCTION

2-10-2. Unread Message Reminder

When there's unread voice message or text message, G1 pager will alert unread message reminder to remind you read the message.

2-10-3. Key Alert

When user is operating the key, G1 pager will playback the key tone to remind user if operation is correct (function) or incorrect (non function).

2-10-4. Low Battery Reminder

When battery gauge is lower than 25%, G1 pager will activate low battery reminder. Display reminder message or playback the alert of low battery reminder every 5 minute. It will remind you to charge the battery or replace the battery.

2-10-5. Out Of Range (OOR) Reminder

When G1 pager is out of signal coverage, G1 will playback the reminder alert and display out of range status reminder until you press confirmation or time out to close the reminder.



When G1 come back to the signal coverage , G1 will playback reminder alert and display in range status reminder until you press confirmation or time out to close the reminder.

2-10-6. ACK Fail Reminder (GSM Time Out)

When your ACK is not success, it will playback the reminder alert and displays the GSM timeout.

PART VI. FEATURE INTRODUCTION

2-10-7. Message Alert

G1 pager provides different reminder alert for different capcode. It helps you to recognize which capcode is receiving message by alert .

※ Different message alert is programmed by PPS.

A. Voice Message Alert

- i. When receiving 2 tone voice messages, pager alert will follow the Alert Tone Pattern of Tone Call ID in PPS and alert mode you set.
- ii. When receiving 5 tone voice messages, pager alert will follow the Alert Tone Pattern of Tone Call ID in PPS and alert mode you set.
- iii. When receiving MDC voice messages, pager alert will follow the Alert Tone Pattern of MDC Call ID in PPS and alert mode you set.
- iv. When the Call ID without Alert Tone setting, it will follow voice message Alert setting of Zone Setting to playback the voice message Alert.
- v. When Call ID is set as Priority is PPS, if your setting is Vibrate or Silent Mode, it will enforce to playback the Alert Tone when receiving the voice message.

B. Text Message Alert

- i. When receiving text messages, pager alert will follow the Alert Tone Pattern of MDC Call ID in PPS and alert mode you set.
- ii. When receiving text message, if the text message Header is without Priority Alert flag, pager alert will follow the Alert Tone Pattern of MDC Call ID in PPS and alert mode you set.
- iii. When Call ID is set as Priority is PPS, if your setting is Vibrate or Silent Mode, it will enforce to playback the Alert Tone when receiving the text message. Pager alert will follow the Alert Tone Pattern of MDC Call ID in PPS and alert mode you set.

PART VI. FEATURE INTRODUCTION

- iv. When receiving text message, if the text message Header is with Priority Alert flag, it will enforce to playback the Alert Tone when receiving the text message. Pager alert will follow the Alert Tone Pattern of MDC Call ID in PPS and alert mode you set.

2-10-8. Message Backlight

G1 pager provides 7 backlight displays. Backlight displays when receiving message or operating the device. Backlight color is programmed in PPS. Colors can be set as below.

- GREEN
- BLUE
- CYAN
- RED
- YELLOW
- MAGENTA
- WHITE

When receiving voice message, G1 can display different backlight color as indication of message type until you change the color in PPS or close backlight when Backlight Timeout.

2-10-9. Empty Channel Reminder

When G1 pager current Function Switch is not set receiving Channel in PPS, G1 pager will playback the Channel Error Alert periodically. This reminds you the current status is not capable to receive. Please select your Channel which is programmed by PPS or check the setting is correct.

2-11. EMERGENCY CALL (ONLY FOR GSM MODEL)

The "EMERGENCY CALL" allows you to call to specific destination (such as Dispatcher Center) by the GSM function.

When Emergency call is programmed, G1 can dial the Emergency phone number set in PPS.

PART VI. FEATURE INTRODUCTION

There are 2 methods to activate the Emergency call.

Press and hold the Function Status Key to enable Emergency Call.

In main menu, operate "▲▼" to move the cursor to Emergency Call. Press "OK" to enable Emergency Call. You will see the screen as below:



Press OK again to cancel the connection.



※ GSM Module is activated only when users enable the Emergency Call

2-12. OTAP (Over The Air Programming)

The G1 provides a function to remotely set the pager. By using the OTAP function, you can program the outside G1s quickly. It can reduce the cost of sending back the G1 to the Dispatcher Center.

2-12-1. Change the receiving Channel (Frequency, Bandwidth)

If the G1 does not support on-site Channel, the Dispatcher center can send change Channel command via Uni Voice Pager Console to adjust the setting in the G1. Then the G1 can receive the on-site messages.

PART VI. FEATURE INTRODUCTION

2-12-2.Enable/Disable GSM ACK Function

The Dispatcher center can enable/disable the GSM ACK function of one or multiple G1 device. The Dispatcher center can send OTA command to G1 devices via Uni Voice Pager Console to make the GSM ACK function of G1 automatically enable/disable.

2-12-3.Change GSM ACK Phone No. (GPRS IP / Port)

The Dispatcher center can change the GSM ACK Phone No. or GPRS IP/Port of one or multiple G1 devices. The Dispatcher center can send OTA command via Uni Voice Pager Console to ask G1 change the setting of GSM ACK Phone No. or GPRS IP/Port automatically.

2-12-4.Change Emergency Call Phone No.

The Dispatcher center can change the Emergency Call Phone No. of one or multiple G1 devices. The Dispatcher center can send OTA command via Uni Voice Pager Console to change the setting of Emergency Call Phone No. automatically.

2-12-5.Change Pager Time

The OTAP function can change the Pager Time to synchronize with system time. The Dispatcher center can send OTA command via Uni Voice Pager Console to make the Pager Time synchronized with the system time automatically.

2-13. OTAC (Over The Air Command)

G1 provides a function to remotely control the device. The Dispatcher center can send command via OTAC.

2-13-1. Pager Disable/Enable

If the G1 device is lost or in other condition, you can inform the Dispatcher center to disable the G1. The dispatcher center can send Pager



PART VI. FEATURE INTRODUCTION

Disable OTAC command via Uni Voice Pager Console to disable the operation functions and stay on specific Channel. The Dispatcher center can send Pager Enable OTAC command to enable the operation functions when you get the G1 again.

2-13-2. Pager Check

The Dispatcher center can help you to check the connection status of G1 to know if the G1 can connect or not. The Dispatcher center can send Pager Check OTAC command. If the G1 receives the command, the G1 sends the ACK message back. The Dispatcher center and you will know if the G1 is in the paging coverage.

2-13-3. Switch Off Duty to On Duty

If the Dispatcher center needs more rescuers to involve an event, it can send Switch Off Duty to On Duty OTAC command to change the status to "On Duty". Therefore, the Dispatcher center can send messages to the rescuers again to recruit more people to join the event.



PART VII. OTHERS

1. CLEAN THE DEVICE

To clean smudges from surface of the pager, please use a soft cloth moistened in clean water to wipe the exterior. Do not use alcohol or other solutions.

2. COPYRIGHT NOTICE

©2012 Unication Co., Ltd. All rights reserved. No part of this publication may be reproduced, stored in a retrieval system, or transmitted, in any form or by any means (electronic, mechanical, photocopying, recording, or otherwise), without the prior written permission of the publisher.



www.unication.com

*For more information, North America area, please
contact us at : sales@unication.com .
Other areas please contact us at :
salesenquiry@uni.com.tw .*

Corporate Headquarter :
Unication Co., Ltd.
Tel. : +886-2-22999678
Address: 5F, No.6, Wu-Kung 5Rd.,
Hsinchuang City, New Taipei, Taiwan.
E-mail: salesenquiry@uni.com.tw
URL: www.uni.com.tw

North America Branch Office :
Unication USA Inc.,
Tel. : +817-303-9320
Address: 1901 E. Lamar Blvd.,
Arlington, TX 76006, U.S.A.
E-mail: sales@unication.com
URL: www.unication.com

UM-G1-001

T82G10001A-R