

REFERENCE GUIDE

ATLANTIS



Uniden®

Three-Year Limited Warranty

Important: Evidence of original purchase is required for warranty service.

WARRANTOR: UNIDEN AMERICA CORPORATION (Uniden)

ELEMENTS OF WARRANTY: Uniden warrants for three years, to the original retail owner, this Product excluding the NiMH battery pack to be free from defects in materials and craftsmanship with only the limitations or exclusions set out below. Uniden warrants for 12 months, to the original retail owner, the NiMH battery pack to be free from defects in material and craftsmanship with only the limitations or exclusions set out below.

WARRANTY DURATION: This warranty to the original user shall terminate and be of no further effect 36 months (12 months for the NiMH battery pack) after the date of original retail sale. The warranty is invalid if the Product is (A) damaged or not maintained as reasonable or necessary, (B) modified, altered, or used as part of any conversion kits, subassemblies, or any configurations not sold by Uniden, (C) improperly installed, (D) serviced or repaired by someone other than an authorized Uniden service center for a defect or malfunction covered by this warranty, (E) used in any conjunction with equipment or parts or as part of any system not manufactured by Uniden, or (F) installed or programmed by anyone other than as detailed by the Owner's Manual for this product.

STATEMENT OF REMEDY: In the event that the product does not conform to this warranty at any time while this warranty is in effect, warrantor will either, at its option, repair or replace the defective unit and return it to you without charge for parts, service, or any other cost (except shipping and handling) incurred by warrantor or its representatives in connection with the performance of this warranty. Warrantor, at its option, may replace the unit with a new or refurbished unit. THE LIMITED WARRANTY SET FORTH ABOVE IS THE SOLE AND ENTIRE WARRANTY PERTAINING TO THE PRODUCT AND IS IN LIEU OF AND EXCLUDES ALL OTHER WARRANTIES OF ANY NATURE WHATSOEVER, WHETHER EXPRESS, IMPLIED OR ARISING BY OPERATION OF LAW, INCLUDING, BUT NOT LIMITED TO ANY IMPLIED WARRANTIES OF MERCHANTABILITY OR FITNESS FOR A PARTICULAR PURPOSE. THIS WARRANTY DOES NOT COVER OR PROVIDE FOR THE REIMBURSEMENT OR PAYMENT OF INCIDENTAL OR CONSEQUENTIAL DAMAGES. Some states do not allow this exclusion or limitation of incidental or consequential damages so the above limitation or exclusion may not apply to you.

LEGAL REMEDIES: This warranty gives you specific legal rights, and you may also have other rights which vary from state to state. This warranty is void outside the United States of America.

PROCEDURE FOR OBTAINING PERFORMANCE OF WARRANTY:

If, after following the instructions in the Owner's Manual you are certain that the Product is defective, pack the Product carefully (preferably in its original packaging). The Product should include all parts and accessories originally packaged with the Product. Include evidence of original purchase and a note describing the defect that has caused you to return it. The Product should be shipped freight prepaid, by traceable means, to warrantor at:

Uniden America Corporation
Parts and Service Division
4700 Amon Carter Boulevard
Fort Worth, TX 76155
(800) 554-3988, 7AM to 5PM Central Time
Monday through Friday

Controls and Indicators

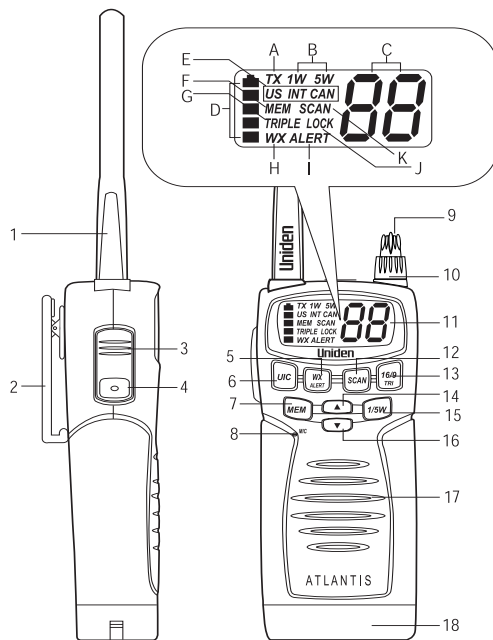

- | | |
|---|---|
| 1. Antenna | 16. Channel Down Button (▼) |
| 2. Belt Clip | 17. Speaker |
| 3. PTT (Push to Talk) Key | 18. Battery Pack |
| 4. Light/Lock Key | A. TX Indicator |
| 5. WX Mode/Weather Alert Button (<i>WX ALERT</i>) | B. TX Power Indicator |
| 6. USA/International/Canadian Button (<i>UIC</i>) | C. Channel Number Display |
| 7. Memory Button (<i>MEM</i>) | D. Battery Indicator |
| 8. Microphone | E. USA/International/Canadian (<i>US/INT/CAN</i>) Channel Indicator |
| 9. Volume/Power Knob | F. Memory Indicator |
| 10. Squelch Knob | G. Triple Watch Indicator |
| 11. LCD Display | H. Weather Mode Indicator |
| 12. Scan Button (<i>Scan</i>) | I. Weather Alert Indicator |
| 13. 16/9-Triple Watch Button (<i>16/9 TRI</i>) | J. Lock Indicator |
| 14. Channel Up Button (▲) | K. Scan Indicator |
| 15. TX Power Button (<i>1/5W</i>)
Invert Display | |

Warning!

- ☞ The ATLANTIS is watertight only when both the antenna and the battery are properly attached.
- ☞ Do not operate the transmitter of any radio equipment near electrical blasting caps or in an explosive atmosphere.
- ☞ Do not let children operate any transmitter-equipped radio equipment without proper supervision.
- ☞ Have your radio equipment serviced by a qualified technician.
- ☞ Do not operate the transmitter of any radio equipment with the antenna touching or close to the eyes, face, or exposed body parts.

NiMH Battery Pack Warning

- ☞ This equipment contains a NiMH Battery Pack.
- ☞ The NiMH Battery Pack contained in this equipment may explode if disposed of in a fire.
- ☞ Do not short-circuit the Battery Pack.
- ☞ Do not charge the NiMH Battery Pack used in this equipment with any charger other than the one designed to charge this Battery Pack. Using another charger may damage the Battery Pack or cause the Battery Pack to explode.
- ☞ NiMH batteries must be disposed of properly.

Contents

FCC Notice	2
Introduction	3
Features	3
Technical Support and Service	4
Maritime Radio Service Operation ..	4
Parts and Accessories	5
Getting Started	6
Mounting the cradle holder	6
Attaching the Antenna	6
Attaching the Battery Pack	7
Attaching the Spacer	8
Charging the Battery Pack	9
Operation	10
Turning on the Unit and Setting Squelch	10
Selecting a Channel	11
One-touch Channel 16/9	11
Triple Watch	12
Monitoring Weather Channels	13
Weather Alert	14
USA, International and Canadian Channels	15
Programming a Channel into Memory	15
Deleting a Channel from Memory	15
Scanning	16
Transmitting	17
Lighted Keys and Display	18
Battery Indicator	18
Reversible Channel Display	18
Key Lock	19
Marine Channels - USA	20
Marine Channels - International ..	21
Marine Channels - Canada	22
Parts and Accessories	23
Specifications	24
Troubleshooting	25

FCC NOTICE

Unauthorized changes or modifications to this equipment may void compliance with FCC Rules. Any change or modification must be approved in writing by Uniden.

This equipment has been tested and found to comply with the limits for a Class B digital device, pursuant to Part 15 of the FCC Rules. These limits are designed to provide reasonable protection against harmful interference in a marine installation. This equipment generates, uses and can radiate radio frequency energy and, if not installed and used in accordance with the instructions, may cause harmful interference to radio communications.

However, there is no guarantee that interference will not occur in a particular installation. If this equipment does cause harmful interference to radio or television reception, which can be determined by turning the equipment off and on, the user is encouraged to try to correct the interference by one or the following measures:

Consult the dealer or an experienced marine electronics technician for help.

Introduction

The ATLANTIS is a watertight, portable two-way VHF transceiver. It is compact, lightweight, rugged and fits easily in your hand. This handheld VHF marine radio will give you consistent, outstanding performance in virtually all conditions and situations. To insure that you get the most from the ATLANTIS' features, please read this operating guide carefully before using the unit.

Features

- ▶ Waterproof (JIS Level 4/CFR46)
- ▶ Triple Watch Mode
- ▶ Priority Channel Startup (Channel 16)
- ▶ Programmable Memory
- ▶ One-Touch Channel 16/9
- ▶ 10 Weather Channels
- ▶ N.O.A.A. Weather Alert
- ▶ Memory Scan
- ▶ USA, International and Canadian Channels
- ▶ The Cradle Holder
- ▶ Rechargeable NiMH Battery Pack
- ▶ Alkaline Battery Pack (Batteries not included)
- ▶ Key Lock
- ▶ Backlit LCD and Keypad
- ▶ Reversible Channel Display
- ▶ Belt Clip
- ▶ Wrist Strap
- ▶ TX Power 1W/5W
- ▶ Cigarette Lighter Adapter

Technical Support and Service

Your Uniden dealer can provide you with sales assistance and information. If your marine radio does not perform properly, follow the troubleshooting tips in the back of this reference guide. For technical support contact Uniden Repair/Service department at 1-800-235-3874. The radio contains no user-serviceable parts. Unauthorized adjustment will void the warranty and may cause illegal radio operation. Be sure that a qualified technician service your radio equipment.

Caution : Changes or modifications to this Product not expressly approved by Uniden, or operation of this product In any other than as detailed by this Operating Guide, can void your Authority to operate this product.

Maritime Radio Service Operation

This transmitter will operate on channels/frequencies that have restricted use in the United States. The channel assignments include frequencies assigned for exclusive use of the U.S. Coast Guard, use in Canada, and international waters. Operation in these frequencies without proper authorization is strictly forbidden. For frequencies/channels that are currently for use in the world see page 19 thru 21. Please contact the FCC Call Center at 1-888-CALL-FCC for any additional channel information.

Included in this Package



ATLANTIS

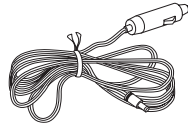

Cigarette Lighter Adapter
(PCATL)

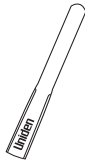

Flexible Antenna
(HHATL08)



Wrist Strap

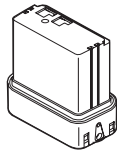

NiMH Battery
(BPATL)

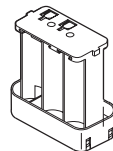

Alkaline Battery Holder

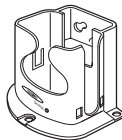

Cradle Holder
(HHATL85)

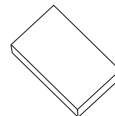

Spacer
(To be used with optional
Speaker/Microphone)



Reference Guide

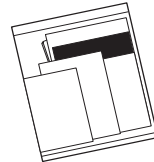

Printed Material

Getting Started

Mounting the Cradle Holder

1. Mount the cradle holder to either a counter or wall.

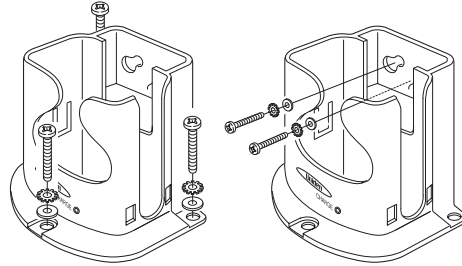

2. Plug one end of the cigarette lighter adapter into the cigarette lighter jack and the other end into the charging jack on the battery pack of the radio in cradle holder.

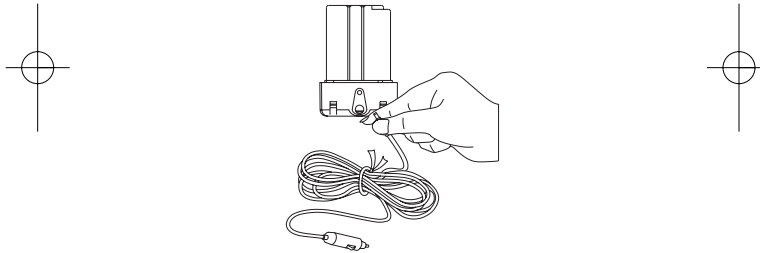

Attaching the Antenna

Attach the antenna to the ATLANTIS. Be sure the antenna is firmly seated.

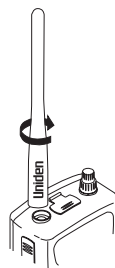

Attaching the Battery Pack

1. Slide the battery pack onto the bottom of the radio



2. Use a coin or screwdriver to turn the screw that connects the battery pack to the ATLANTIS. Be sure the battery pack fits tightly against the ATLANTIS' body.

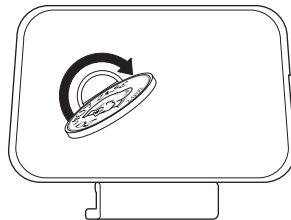

Attaching the spacer to the beltclip

A spacer is included to be used with the optional Speaker/Microphone. The spacer must be affixed to the beltclip of your ATLANTIS radio.

Remove the backing from the spacer and attach it to the upper part of the beltclip.

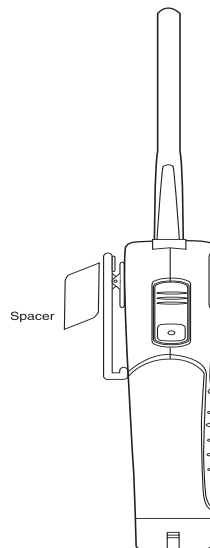

Do not operate your ATLANTIS radio when using the optional Speaker/Microphone unless the spacer is properly affixed behind the beltclip.

In order to reduce the likelihood of excessive radio frequency exposure, the spacer is provided for you to increase the distance between the radio antenna and the human body when operating the radio while attached to your belt. Additional steps should be taken to maintain a separation distance of at least 1 inch between the antenna and the human body.

Charging the Battery Pack

Your marine radio is powered by a specially designed NiMH battery pack or an Alkaline battery pack. (Alkaline batteries are not included.) Before operating the ATLANTIS, charge the NiMH battery pack for 15 hours without interruption the first time.

1. Place the ATLANTIS in the cradle holder.



- ☞ You can monitor incoming calls while the ATLANTIS is in the cradle holder.
- ☞ You can charge the battery pack alone or connected to the ATLANTIS.
- ☞ Periodically, the NiMH battery should be fully drained prior to recharging.

Operation

- ☞ When you press any key (except PTT), a short tone sounds.
- ☞ When you turn on your ATLANTIS, it is automatically tuned to channel 16, the United States Coast Guard frequency for distress, safety, and calling.
- ☞ See the foldout in the front of the operating guide for button, knob, and key positions.

Turning on the Unit and Setting Squelch

1. Before you turn on the unit, turn the **Squelch** knob fully counter clockwise.

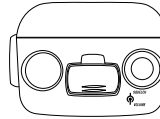

2. Then, turn on the Unit by turning the **Volume/Power** knob clockwise until you hear a hissing sound.

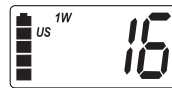

3. Turn the **Squelch** knob clockwise, just until the hissing sound stops. Use the knob to adjust to the desired squelch level. Think of the squelch control as a frequency gate which controls access to weak or strong signals depending on its setting.

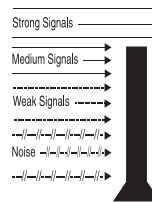

- ☞ To listen to a weak or distant station, turn the knob counterclockwise.
 - ☞ If the tracking squelch control is adjusted so you continually hear a hissing sound, the unit will not scan properly.
4. To turn off the unit, turn the **Volume/Power** knob counterclockwise.

Selecting a Channel

1. Turn on your ATLANTIS.



2. To select a higher channel, press the ▲ arrow key.

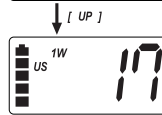

3. To select a lower channel, press the ▼ arrow key.

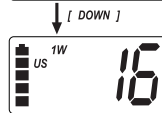

☞ To change the channel continuously, press and hold the ▲ or ▼ key.

One-touch Channel 16/9

Example: While you are monitoring channel 20, you want to check channel 16 or 9.

1. You are now on channel 20.

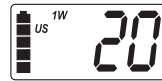

2. To monitor channel 16, press the **16/9/TRI** button.

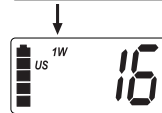

3. To monitor channel 9, press the **16/9/TRI** button again.



4. To return to channel 20, press the **16/9/tri** button again.

Triple Watch

Triple Watch mode monitors channels 16 and 9 for a signal while you listen to the currently selected channel. The marine radio checks channel 16 and 9 for activity every 2 seconds.

1. To select Triple Watch mode, press and hold the **16/9/TRI** button for 2 seconds. A confirmation tone sounds.

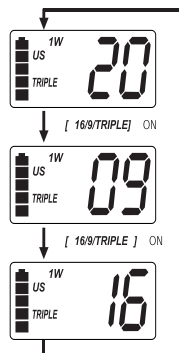

2. To exit from Triple Watch, press and hold **16/9/TRI** for 2 seconds. A confirmation tone sounds.

- ☞ While in Triple Watch mode, you can change the currently selected channel using the ▲ or ▼ arrow key.
- ☞ A momentary press of the **16/9/TRI** button interrupts Triple Watch mode and remains on 16. Press **16/9/TRI** again to monitor channel 9. A third press will return to the main channel and resume the Triple Watch mode. At anytime you may press and hold the **16/9/Tri** button for 2 seconds to return to the previous Triple Watch mode.

Monitoring Weather Channels

The ATLANTIS has 10 preprogrammed weather channel frequencies, represented by 1 through 10.

1. To listen to the weather channels in your area, press **WX/ALERT. WX** appears on the display.

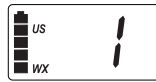

↓ [UP]

2. To move up, press the ▲ arrow key.



↓ [UP]

3. To move down, press the ▼ arrow key.

4. To exit, press **WX/ALERT. WX** disappears from the display.

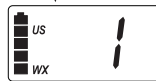

- ☞ To change the channel continuously, press and hold the ▲ or ▼ arrow button for more than 1 second.

Weather Alert

Weather Alert allows your ATLANTIS to function as a severe weather radio. If NOAA issues a severe weather warning while the Weather Alert is turned on, the ATLANTIS sounds an alert tone. You will then hear the emergency weather broadcast.

1. To use Weather Alert, select the weather Channel in your area

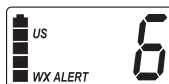

2. Press and hold **WX/ALERT** for 2 seconds. A confirmation tone sounds.

3. When the unit receives a warning signal, it beeps for 5 seconds.

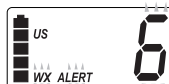



WX, ALERT, and the channel number blink to receive the emergency weather broadcast.

4. To turn off Weather Alert, press and hold **WX/ALERT** for 2 seconds. A confirmation tone sounds.

☞ When Weather Alert is activated, the highest priority is given to this function. If the unit is in scan, Triple Watch, or any other marine channels, it checks for the weather alert signals every 7 seconds and switches to the Weather Channel automatically.

*NOTE: Be sure the volume is set to a high level when using the Weather Alert mode. This will insure that you will hear the Alert tone even in a noisy environment.

USA, International and Canada Channels

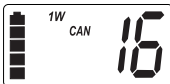
1. The ATLANTIS is initially set for USA marine channels. When you turn on your radio. 
2. To receive and transmit on international marine channels, press **U/I/C**. 
3. To receive and transmit on Canadian marine channels, press **U/I/C** again. 
4. The radio will keep the last mode setting that was selected when turned back on.

☞ For USA, international and Canadian marine channels and functions, refer to the tables starting on page 20.

Programming Channel into Memory

Before using the scanning feature, you have to program channels into memory.

1. Select the channel to enter into memory by pressing the ▲ or ▼ arrow key.
2. Press the **MEM** button to store the channel. **MEM** appears on the display. 

Deleting a channel from memory

1. Select the channel to delete from memory by pressing the ▲ or ▼ arrow key.
2. Press the **MEM** button. **MEM** disappears from the display.

Scanning

1. To begin scanning the programmed channels, press the **SCAN** button.

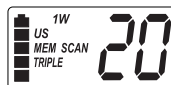

MEM, **SCAN** and **TRIPLE** appear on the display.

2. To stop scanning, press the **SCAN** button once more. **SCAN** and **TRIPLE** disappear from the display.

- ☞ Scanning starts from the lowest to highest channel and stops when it finds an active channel. It remains on that channel until the transmission ends, then resumes scanning after a 3 second delay period.
- ☞ When in the scan mode, the unit automatically activates the Triple Watch feature. To deactivate Triple Watch from the scanning mode, press and hold the **16/9/TRI** button for 2 seconds. **TRIPLE** disappears from the display.

Transmitting

1. Transmission power can be set to either 5W or 1W. Press the **1/5W** button to make the change, then the **5W** or the **1W** indicator on the display changes accordingly.

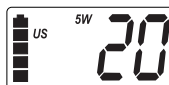

2. To transmit, press and hold the **PTT** key. **TX** appears on the display.
3. To return to receive, release the **PTT** key. **TX** disappears from the display.

☞ If the battery indicator drops to the 1-mark level blinking on the display, when the **PTT** key is pressed, the radio will not transmit and the **TX** icon starts blinking. (Refer to the description of the Battery Indicator on the next page.)

*NOTE: Channels 13 and 67 are ONLY to be used in the 1W mode. For emergency cases only the user may override to 5W mode by pressing the PTT key and then hold down the 1/5W key for 2 seconds. After the transmission is made the radio will automatically revert back to the 1W mode for these channels.

*NOTE: For maximum battery life, the default transmit power setting is 1W for each individual channel.

Lighted Keys and Display

To light the display and keypad for about 5 seconds, press the **Light/Lock** key.

- ☞ If you press any button other than the **Light/Lock** or transmit key while the display and key pad are lit, remains in the lit status for another 5 seconds.

Battery Indicator

When the unit is on, battery power is always indicated on the display.

When the battery is fully charged, the battery indicator appears as follows:



When the battery is nearly discharged, the battery indicator appears as follows:

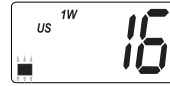

- ☞ When the battery indicator drops to the 1-mark level blinking on the display, the radio will receive but will not transmit.

Reversible Channel Display

The channel indicator can be displayed upside down on the display. This feature makes viewing the display more convenient when on the user's belt.

1. To invert, press and hold the **1/5W** key for 2 seconds.
2. To return, press and hold the **1/5W** key for 2 seconds again.



Key Lock

To prevent accidental entries, you can lock the keypad.

1. Press and hold the **Light/Lock** key for 2 seconds. The unit will sound a confirmation tone to confirm that the keypad is locked with **LOCK** indication on the display.
2. To unlock the keypad, press and hold the **Light/Lock** key again for 2 seconds. The unit will sound a confirmation tone to confirm that the keypad is unlocked, and **LOCK** will disappear.

☞ You can also unlock the keypad by turning the radio off and then on again.

Marine Channels - USA

CH	U.S.	INT.	CAN.	S/D	TX	RX
01A	X			S	156.050	
01		X	X	D	156.050	160.650
02		X	X	D	156.100	160.700
03A	X			S	156.150	
03		X	X	D	156.150	160.750
04A			X	S	156.200	
04		X		D	156.200	160.800
05A	X		X	S	156.250	
05		X		D	156.250	160.850
06	X	X	X	S	156.300	
07A	X		X	S	156.350	
07		X		D	156.350	160.950
08	X	X	X	S	156.400	
09	X	X	X	S	156.450	
10	X	X	X	S	156.500	
11	X	X	X	S	156.550	
12	X	X	X	S	156.600	
13	X	X	X	S	156.650	
14	X	X	X	S	156.700	
15	X			S	---	156.750
15		X	X	S	156.750	
16	X	X	X	S	156.800	
17	X	X	X	S	156.850	
18A	X		X	S	156.900	
18		X		D	156.900	161.500
19A	X		X	S	156.950	
19		X		D	156.950	161.550
20A	X			S	157.000	
20		X	X	D	157.000	161.600
21A	X		X	S	157.050	
21		X		D	157.050	161.650
22A	X		X	S	157.100	

Marine Channels - International

22		X		D	157.100	161.700
23A	X			S	157.150	
23		X	X	D	157.150	161.750
24	X	X	X	D	157.200	161.800
25	X	X	X	D	157.250	161.850
26	X	X	X	D	157.300	161.900
27	X	X	X	D	157.350	161.950
28	X	X	X	D	157.400	162.000
60		X	X	D	156.025	160.625
61A	X		X	S	156.075	
61		X		D	156.075	160.675
62A			X	S	156.125	
62		X		D	156.125	160.725
63A	X			S	156.175	
63		X		D	156.175	160.775
64A	X		X	S	156.225	
64		X		D	156.225	160.825
65A	X		X	S	156.275	
65		X		D	156.275	160.875
66A	X		X	S	156.325	
66		X		D	156.325	160.925
67	X	X	X	S	156.375	
68	X	X	X	S	156.425	
69	X	X	X	S	156.475	
70	X	X	X	S, RX Only	156.525	
71	X	X	X	S	156.575	
72	X	X	X	S	156.625	
73	X	X	X	S	156.675	
74	X	X	X	S	156.725	
77	X	X	X	S	156.875	
78A	X		X	S	156.925	
78		X		D	156.925	161.525
79A	X		X	S	156.975	
79		X		D	156.975	161.575
80A	X		X	S	157.025	

Marine Channels - Canada

80		X		D	157.025	161.625
81A	X		X	S	157.075	
81		X		D	157.075	161.675
82A	X		X	S	157.125	
82		X		D	157.125	161.725
83A	X		X	S	157.175	
83		X		D	157.175	161.775
84	X	X	X	D	157.225	161.825
85	X	X	X	D	157.275	161.875
86	X	X	X	D	157.325	161.925
87	X	X	X	D	157.375	161.975
88A	X			S	157.425	
88		X	X	D	157.425	162.025
WX01	X	X	X		---	162.550
WX02	X	X	X		---	162.400
WX03	X	X	X		---	162.475
WX04	X	X	X		---	162.425
WX05	X	X	X		---	162.450
WX06	X	X	X		---	162.500
WX07	X	X	X		---	162.525
WX08	X	X	X		---	161.650
WX09	X	X	X		---	161.775
WX10	X	X	X		---	163.275

***NOTE:** Please note that the "A" for the channels will not be displayed in the LCD screen. This designation is just for the channel/frequency chart.

Optional Parts and Replacement Accessories



AC Adapter
(ACATL)



Flexible Antenna
(HHATL08)



Car DC Adapter
(PCATL)



Alkaline Battery Pack
(BPATL)



Cradle Holder
(HHATL85)



External Speaker/Microphone
(HHATL07)

See your local dealer or contact
Uniden Parts Department
(800)-554-3988
Hours: M-F 7:00AM to 5:00PM CST
We can also be reached on the web at
www.uniden.com

Product Specifications

GENERAL

Channels:	All current USA, International, Canadian, and Weather Channels
Controls:	Volume & power on/off knob, Squelch knob, Ch. up/down, Ch. 16/Ch. 9 or Triple watch, 1 or 5 Watt, Light or Keypad lock, Push to talk, UIC, Mem Scan, Weather Alert, All N.O.A.A WX Channels.
Status Indicators:	Channel readout, Battery Strength Indicator, Lock, 1W/5W, US/INT/CAN, Triple Watch, TX, Mem, Scan, WX Alert, WX
Channel Display:	Backlit LCD
Channel Selector:	Up/down
Antenna Connector:	SMA type (female)
Size:	150 mm (H) x 57 mm (W) x 37 mm (D) 5 7/8" (H) x 2 1/4" (W) x 1 1/2" (D)
Weight:	13.1 ounces (Batteries installed)
Charge Power Source:	12V DC Plug (included) (optional) AC Adapter ACATL
Antenna Impedance:	50 Ω
Speaker:	4 Ω 1.0W
Operating Temperature Range:	-20°C ~ +50°C
Power Source:	NiMH rechargeable battery/ 1350 mAh or 6 AA Alkaline batteries (batteries not included)
Battery Input Voltage:	9v Alk./7.2v NiMH

TRANSMITTER

Frequency Range:	156 ~ 158 MHz
Frequency Stability:	\pm 500Hz
Power Output:	5 watt, 1 Watt - selectable
Spurious Emissions:	5W, -70 dBc
Current Drain:	High - 1.3 Amps Low - 600 Milliamps
Modulation:	FM \pm 5 KHz deviation (FCC designator F3E)

RECEIVER

Receiver Type:	Dual conversion superheterodyne
Signal-To-Noise:	40 dB Nominal
Frequency Range:	156 ~ 164 MHz
Receiver Sensitivity:	0.25 μ v AT 12 dB SINAD
Audio Output Power:	1 Watt

Troubleshooting

■ Not enough range

Cause: Line of sight blocked

- Switch to 5W mode (if available).

■ Will not transmit on 5 watt range but will transmit on the 1 watt range.

Cause: Low voltage.

- Recharge or replace the batteries.

(Use high quality alkaline batteries).

■ Battery will not hold a charge.

Cause: Battery has developed a memory.

- Periodically, drain the NiMH battery before recharging. (This can be done by listening to the weather channel until the battery drains).

■ Strange Display

Cause: Inverted display has been activated.

- Press and hold the **1/5W** key for 2 seconds.

FCC Safety Precautions

When operating your portable marine VHF radio transceiver, you should know that the antenna radiates radio frequency energy. This radio was designed to meet the FCC's rules and regulations for the maximum permissible exposure to radio frequency energy. This design was tested and found to be compliant to the strict requirements established by the FCC.

The belt clip is provided for the purpose of carrying the radio ONLY. Do not attempt to activate the transmitter from this position unless you have installed the proper Uniden speaker/microphone accessory.

WARNING: It is up to the user to properly operate this radio transmitter to insure safe operation. Please adhere to the following:

- Never allow children to operate the radio without adult supervision and the knowledge of the following safety guidelines.
- Hold the radio transceiver to your face, but always maintain at least a 1 inch separation distance between your body (including the face and eyes) and any surface of the radio.
- Never allow the antenna to touch the human body or to come within 1 inch when the transmitter is active.
- When using an external speaker or microphone, USE ONLY THE UNIDEN MODEL HHATL07. This accessory is designed to be used with a spacer that keeps the radiating parts of the portable marine VHF radio away from the human body at a distance where the radiated energy is below the maximum permissible level. Use of any other accessory for this purpose may invalidate your authority to operate this device!

THANK YOU
FOR PURCHASING A UNIDEN PRODUCT!

A World Without Wires | **Uniden**[®]
© 2001 Uniden America Corporation
All rights reserved Printed in South Korea