

Uniden®

EXAI5580

SERIES

OWNER'S

MANUAL

OWNER'S MANUAL

Contents

Welcome/Features	3	Using the Speed Dial Memory	20
Controls and Functions	4	Storing Names and Numbers in Speed Dial Memory	20
Terms Used in this Manual	5	Storing Caller ID messages in Speed Dial Memory	23
Accessibility	6	Making Calls from Speed Dial Memory	24
Installing the Phone	7	Caller ID and CIDCW (Caller ID on Call Waiting)	25
A. Choose the best location	7	Viewing the Caller ID Message List	26
B. Install the rechargeable battery pack into the handset	8	Deleting Information from the Caller ID List	27
C. Connect the Base Unit and Charge the Handset	9	Making a Call from the Caller ID List	28
D. Mount the Base Unit on a Wall	10	Caller ID on Call Waiting (CIDCW)	28
Installing the Beltclip	11	The Integrated Answering Device	29
Headset Installation	12	Setting Up Your Answering System	30
Basic Setup	13	Turning the Answering System On/Off	38
Activating AutoTalk	13	Using Your Answering System	39
Activating Caller ID on Call Waiting	13	Handset Operation	44
Entering Your Area Code	14	Remote Operation	45
Choosing the Dialing Mode	14	Changing the Digital Security Code	48
Setting the language	15	Note on Power Sources	49
Selecting the Ring Tone and Volume	15	General Information	51
Using Your Phone	16	Troubleshooting	52
Making and Receiving Calls	16	Liquid Damage	54
Redialing the last dialed number	17	Precautions & Warranty	55
Adjust the Earpiece Volume	17	I.C. Notice	57
Tone Dialing Switch-over	18	Index	58
Traveling Out-of-Range	18	Remote Operation Card	
Selecting a Different Channel	18		
Find Handset	19		
Using Call Waiting	19		

Welcome

Congratulations on your purchase of the Uniden cordless phone. This cordless phone is designed and engineered to exacting standards for reliability, long life, and outstanding performance.

Note: Illustrations in this manual are used for explanation purposes. Some illustrations in this manual may differ from the actual unit. The color of your cordless telephone may vary.



As an ENERGY STAR® Partner, Uniden has determined that this product or product models meet the ENERGY STAR® guidelines for energy efficiency. ENERGY STAR® is a U.S. registered mark.

Features

- 5.8GHz Extended Range Technology
- Integrated Answering Device
- Caller ID/Caller ID on Call Waiting
- 3-Line Backlit LCD
- Access Messages with Handset Remote Key
- Trilingual Menu Displays/Voice Prompts
- 30 Caller ID Memory
- 10 Number Memory Dialing
- Last Number Redial
- Tone/Pulse Dialing
- Page/Find Handset Key
- Earpiece/Ringer Volume Controls
- Mute or Turn Ringer Off
- Hearing Aid Compatible
- 20 Channel Auto Scan
- Desk or Wall Mountable

If you have any trouble with your phone, call our Customer Hotline at 1- 800-297-1023, Mon-Fri 7 am to 7 pm, Sat/Sun 9 am to 5 pm, CST. (Phone support is closed on holidays.) For more information on Uniden products and accessories, be sure to visit our web site: www.uniden.com

Uniden® is a registered trademark of Uniden America Corporation. AutoTalk, AutoStandby, UltraClear Plus, Random Code and AutoSecure are trademarks of Uniden America Corporation.

Controls and Functions

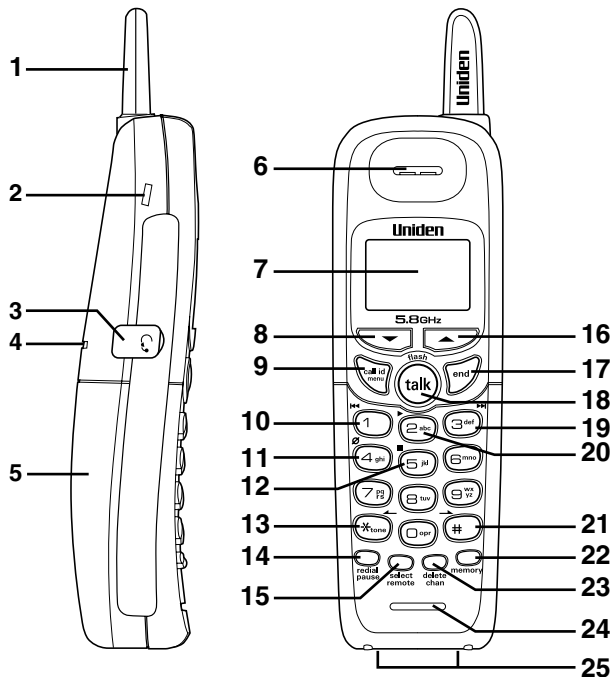

1. Handset antenna
2. Beltclip hole
3. Optional headset jack
4. Handset ringer speaker
5. Handset battery compartment
6. Handset earpiece
7. LCD display
8. ▼ (volume & scroll down) key
9. Call id (Caller ID)/menu key
10. ◀◀ (repeat/rewind) key
11. ∅ (delete) key
12. ■ (stop) key
13. ✖ /tone/← (left cursor) key
14. Redial/pause key
15. Select/remote key
16. ▲ (volume & scroll up) key
17. End key
18. Talk/flash key
19. ▶▶ (skip/fast forward) key
20. ▶ (play) key
21. #/→ (right cursor) key
22. Memory key
23. Delete/chan key
24. Handset microphone
25. Handset charging contacts

[4] CONTROLS AND FUNCTIONS

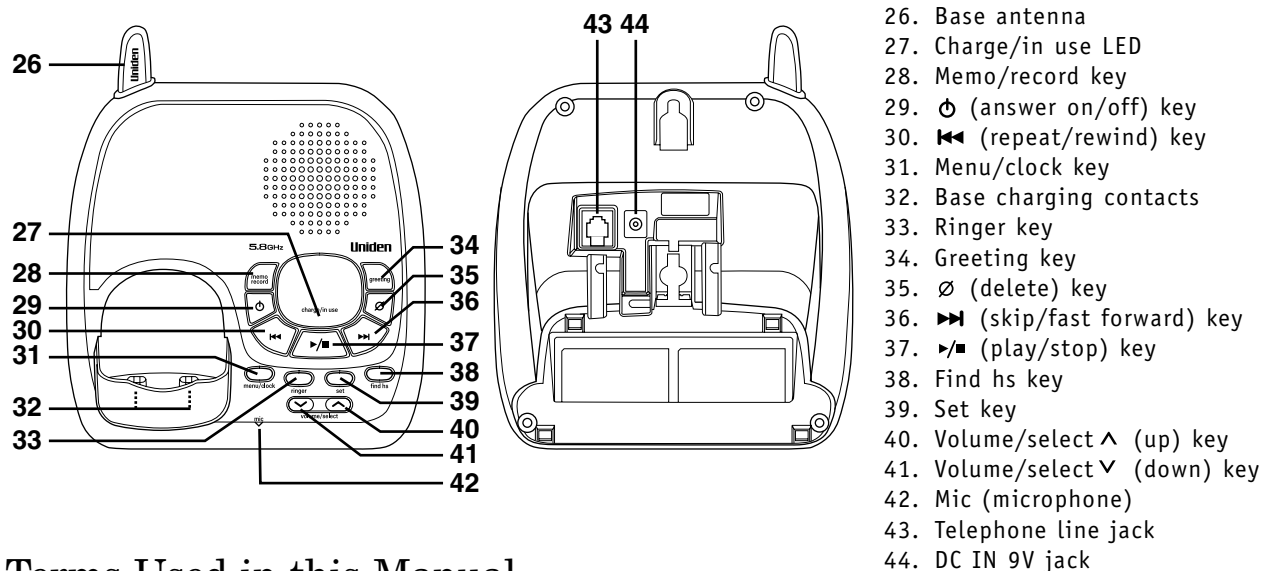

Terms Used in this Manual

- Standby Mode - The handset may be sitting in or off the base, but is NOT in use. The **talk/flash** key has not been pressed and there is no dial tone.
- Talk Mode - The handset is off the base and the **talk/flash** key has been pressed, enabling a dial tone.
- CID - Caller ID
- CIDCW - Caller ID on Call Waiting

Accessibility

Uniden provides a customer service hotline for accessibility questions. If you have a disability and need customer service assistance or if you have any questions about how Uniden's products accommodate persons with disabilities, please call the accessibility voice/TTY line:
1-800-874-9314

A representative is available to talk to you M-F, 8:00 am to 5:00 pm, CST. After hours, you can leave a message, and we will call you back. Information is also available on our web site, www.uniden.com, under the "Accessibility" link.

Installing the Phone

Do the following steps:

- A. Choose the Best Location
- B. Install the Rechargeable Battery Pack into the Handset
- C. Connect the Base Unit and Charge the Handset
- D. Mount the Base Unit on a Wall

A. Choose the best location

Before choosing a location for your new phone. Here are some important guidelines you should consider:

Avoid heat sources, such as radiators, air ducts, and sunlight

Avoid television sets and other electronic equipment

Avoid noise sources such as a window by a street with heavy traffic

Avoid microwave ovens

Avoid excessive moisture, extremely low temperatures, dust, mechanical vibration, or shock

Choose a central location

Avoid personal computers

Avoid other cordless telephones

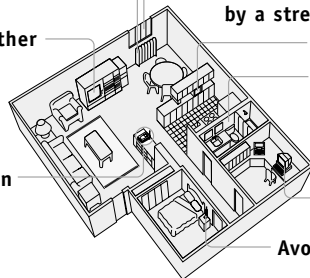

- The location should be close to both a phone jack and a continuous power outlet (one which is not connected to a switch).
- The base and handset should be kept away from sources of electrical noise such as motors, microwave ovens, and fluorescent lighting.
- The base can be placed on a desk, tabletop, or mounted on a standard wall plate. For better reception, place the base as high as possible.
- The base should be placed in an open area for optimum range and reception.

www.uniden.com



If your home has specially wired alarm equipment connected to the telephone line, be sure that installing the system does not disable your alarm equipment.

If you have questions about what will disable your alarm equipment, contact your telephone company or a qualified installer.



Use only the Uniden (BT-800) rechargeable battery pack supplied with your phone.

B. Install the rechargeable battery pack into the handset

The handset is powered by a rechargeable battery pack. The battery recharges automatically when the handset is placed in the base unit.

- 1) Press down on the handset battery case cover (use the finger indentation for a better grip) and slide the cover downward to remove.
- 2) Plug the battery pack connector (red & black wires) into the small jack inside the battery compartment. (The connector notches fit into the grooves of the jack only one-way.) Match the wire colors to the polarity label in the battery compartment, connect the battery, and listen for a click to insure connection.
- 3) Make sure you have a good connection by slightly pulling on the battery wires. If the connection is secure, the battery jack will remain in place.
- 4) Place the battery case cover back on the handset by sliding it upwards until it clicks into place.

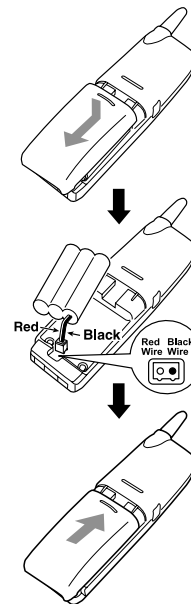

C. Connect the Base Unit and Charge the Handset

- 1) Connect the AC adapter to the **DC IN 9V** jack and to a standard 120V AC wall outlet.
- 2) Place the handset in the base unit with the keypad facing forward.
- 3) Make sure that the **charge/in use** LED illuminates.

If the LED does not illuminate, check to see that the AC adapter is plugged in and that the handset makes good contact with the base charging contacts.



- Connect the AC adapter to a continuous power supply.
- Place the base unit close to the AC outlet to avoid long extension cords.

- 4) Charge your handset at least 15-20 hours before plugging the phone line.
- 5) Once the handset battery pack is fully charged, connect the telephone line cord to the **TEL LINE** jack and a telephone outlet. If your telephone outlet isn't modular, contact your telephone company for assistance.

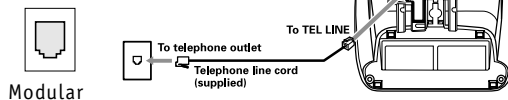
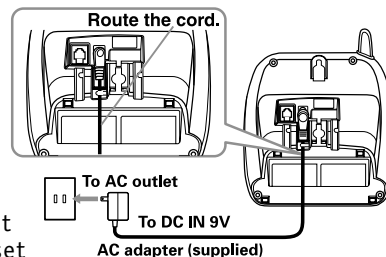

- Use only the supplied AD-314 AC adapter. Do not use any other AC adapter.
- Do not place the power cord where it creates a trip hazard or where it could become chafed and create a fire or electrical hazard.

D. Mount the Base Unit on a Wall

Standard wall plate mounting

This phone can be mounted on any standard wall plate.

- 1) Plug the AC adapter to the **DC IN 9V** jack.
- 2) Route the AC adapter cord through the molded wiring channel as shown.
- 3) Plug the AC adapter into a standard 120V AC wall outlet.
- 4) Plug the telephone line cord into the **TEL LINE** jack. Route the cord through the molded wiring channel as shown.
- 5) Plug the telephone line cord into the telephone outlet.
- 6) Align the mounting slots on the base with the mounting posts on the wall. Then push in and down until the phone is firmly seated.

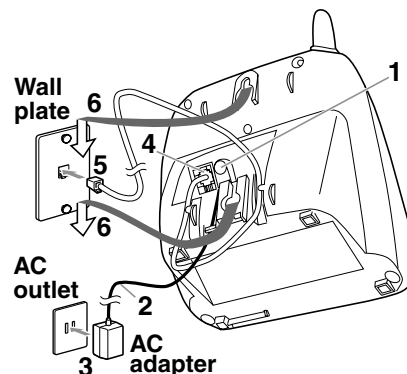

Direct wall mounting

If you don't have a standard wall plate, you can mount your phone directly to the wall. Before doing this, consider the following:

- Avoid electrical cables, pipes, or other items behind the mounting location that could cause a hazard when inserting screws into the wall.
- Try to mount your phone within 5 feet of a working phone jack to avoid excessive lengths.
- Make sure the wall material is capable of supporting the weight of the base and handset.
- Use #10 screws (minimum length of 1-3/8 inches) with anchoring devices suitable for the wall material where the base unit will be placed.

- 1) Insert two mounting screws into the wall (with their appropriate anchoring device), 3-15/16 inches apart. Allow about 1/8 of an inch between the wall and screw heads for mounting the phone.
- 2) Refer to steps 1 through 6 on page 10 to mount the telephone.

Installing the Beltclip

To attach the beltclip

Insert the beltclip into the holes on each side of the handset. Press down until it clicks.

To remove the beltclip

Pull both sides of the beltclip to release the tabs from the holes.

www.uniden.com

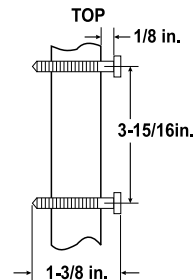

Headset Installation

Your phone may be used with an optional headset.

To use this feature, insert the headset plug into the headset jack.

Your phone is ready for hands-free conversations.

(Headsets may be purchased by visiting our website at www.uniden.com or by calling our Parts Department. See back cover page.)

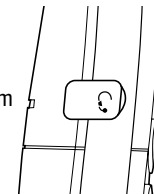

Basic Setup

There are five basic options that you will need to set up: AutoTalk, CIDCW (Caller ID on Call Waiting), Area Code, Dial Mode and Language.

Activating AutoTalk

AutoTalk allows you to answer the phone simply by removing the handset from the base. You do not have to press any keys.

- 1) When the phone is in standby mode, press and hold the **call id/menu** key. The following screen appears.
- 2) Press the **select/remote** key to turn AutoTalk on.
- 3) Press the **end** key to complete the setting. The handset returns to standby mode.

```

Auto Talk  :Off
CIDCW      :On
Area Code  :
  
```

Activating Caller ID on Call Waiting

Caller ID allows you to see the name and number of the calling party before you answer the phone. Caller ID on Call Waiting (CIDCW) lets you see the name and number of a call that comes in when you are on the line.

You must subscribe to Caller ID service through your local telephone provider to use this feature.

- 1) When the phone is in standby mode, press and hold the **call id/menu** key. The following screen appears.
- 2) Press the **▼** key to select CIDCW.
- 3) Press the **select/remote** key to toggle and turn on Caller ID on Call Waiting.
- 4) Press the **end** key and return the handset to the base unit to complete the setting. The handset returns to standby mode.

```

Auto Talk  :Off
CIDCW      :On
Area Code  :
  
```

Entering Your Area Code

If you can make a call by dialing only 7 digits (instead of 10), you can program your local area code in your phone. If you get a call from within your area code, you'll only see the 7-digit phone number. If you get a call from outside your area code, you'll see all 10 digits.

- 1) When the phone is in standby mode, press and hold the **call id/menu** key. The following screen appears.
- 2) Press the ▼ key twice to select Area Code.
- 3) Press the **select/remote** key. If an area code was already stored, the phone will display it.
- 4) Use the number keys (**0 - 9**) to enter the 3-digit area code. If you make an error, use the **delete/chan** key to backspace.
- 5) Press the **select/remote** key. A confirmation tone sounds.
- 6) Press the **end** key to complete the setting. The handset returns to standby mode.

```

▶ Auto Talk  :Off
  CIDCW     :On
  Area Code  :
  
```

```

Auto Talk  :Off
CIDCW     :On
▶ Area Code :
  
```

```

Auto Talk  :Off
CIDCW     :On
▶ Area Code : █
  
```

Choosing the Dialing Mode

Your phone can communicate with the telephone network in two different ways: tone dialing and pulse dialing. These days, most phone networks use a method called tone dialing, so your phone comes programmed for tone dialing.

If your phone company uses pulse dialing, you'll need to change your phone's dial mode. There's an easy way to tell: try making a call. If your call connects, your phone's setting is fine. If not, follow the steps below:

- 1) When the phone is in standby mode, press and hold the **call id/menu** key. The following screen appears.
- 2) Press the ▼ key three times to select Dial.
- 3) Press the **select/remote** key to set the phone to pulse dialing.
- 4) Press the **end** key to complete the setting. The handset returns to standby mode.

```
▶Auto Talk :Off
CIDCW      :On
Area Code  :
```

```
CIDCW      :On
Area Code  :
▶Dial      :Tone
```

Setting the language

You can change the language the menu display uses. Choose from English, French, or Spanish.

- 1) When the phone is in standby mode, Press and hold the **call id/menu** key. The following screen appears.
- 2) Press the ▼ key four times to select Language.
- 3) Press the **select/remote** key to select Eng, Fr., or Esp.
- 4) Press the **end** key to complete the setting. The handset returns to standby mode.

```
▶Auto Talk :Off
CIDCW      :On
Area Code  :
```

```
Area Code  :
Dial       :Tone
▶Language  :Eng
```

Selecting the Ring Tone and Volume

Your phone has five different ringer tone/volume combinations you can choose from.

- 1) With the phone in standy mode, press the ▲ or ▼ key.
- 2) The phone will sound the different ring tones at different volumes. To turn the ringer off, select Ringer Off.
- 3) When the phone sounds the ring tone and volume you wish to use, press the **end** key.



If your phone system requires pulse dialing and you need to send the DTMF tones for certain situations during a call, you may "Switch Over" to tone dialing. (Refer to "Tone Dialing Switch Over" on page 18.)



To turn on the AutoTalk feature, see "Activating Autotalk" on page 13.

Using Your Phone

Making and Receiving Calls

Making a call

- 1) Remove the handset from the base.
- 2) Press the **talk/flash** key.
- 3) Listen for the dial tone.
- 4) Dial the number.

OR

- 1) Remove the handset from the base.
- 2) Dial the number.
- 3) Press the **talk/flash** key.

Receiving a call

- 1) Remove the handset from the base. (If AutoTalk is on, the phone will automatically answer the call when you pick it up.)
 - 2) Press the **talk/flash** key.
- OR
- 1) If the handset is off the base, press the **talk/flash**, *** /tone/ ←**, **# / →** or any number key. (AutoTalk is on.)

Hanging up

Press the **end** key or return the handset to the base.

Redialing the Last Dialed Number

- 1) Remove the handset from the base.
 - 2) Press the **talk/flash** key.
 - 3) Listen for the dial tone.
 - 4) Press the **redial/pause** key.
- OR
- 1) Remove the handset from the base.
 - 2) Press the **redial/pause** key.
 - 3) Press the **talk/flash** key.

Adjust the Earpiece Volume

To change the earpiece volume, press the ▲ or ▼ key during a call.

Temporarily Mute Ringer

If the handset is off the base while an incoming call is ringing, simply press the **end** key to mute the incoming ring. The ringer will sound with the next incoming call.

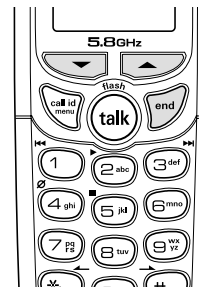

You can only mute the handset ringer if the handset is off the base when the phone starts ringing.



Tone Dialing Switch-over

If your telephone company requires pulse dialing, you can switch over to tone dialing after the call connects. This feature is useful when you need tone dialing to use automated such as telephone bank tellers, telephone prescription refills, customer support menus, etc.

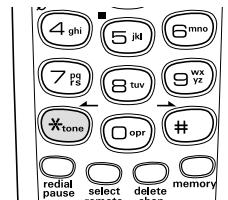

If your phone is set to pulse dialing mode, make your call normally. Once your call connects, press the *** /tone/ ←** key. Any digits you enter from then on will be sent as tone digits. When this particular call ends, the phone automatically returns to pulse dialing mode.

Traveling Out-of-Range

During a call, as you begin to move your handset too far from your base unit, noise increases. If you pass the range limits of the base, your call will terminate within one minute.

Selecting a Different Channel

If you encounter interference while using your phone, you can manually change the phone's channel for clear operation. While using your phone, press the **delete/chan** key. **Scanning** appears on the display, indicating the phone is changing to another channel. For more information on interference, refer to "Precautions" on page 55.

The **UltraClear Plus™** true compander circuitry virtually eliminates background noise. This innovative technology, together with 20 different channels, provides you with the best possible reception during all your conversations.

Find Handset

To locate the handset, press the **find hs** key on the base. The handset beeps for 60 seconds.

To cancel paging, press any key on the handset or the **find hs** key on the base, or return the handset to the base.

Paging is also canceled when the phone receives an incoming call.

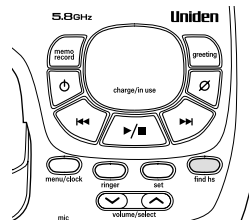

Using Call Waiting

If you have Call Waiting, you can receive calls while on the line.

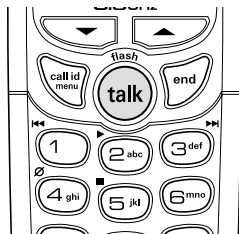

- 1) If a call comes in while you are on the phone, you will hear a call waiting tone. If you have CIDCW activated, you will see the name and number of the incoming caller.
- 2) Press the **talk/flash** key to accept the waiting call. After a short pause, you will hear the new caller.
- 3) To return to the original caller, press the **talk/flash** key again.



You must subscribe to Call Waiting through your local telephone company.



When editing the speed dial memory, you must press a key within 30 seconds or the phone will return to standby mode. If you return the handset to the base, the phone will return to standby mode also.

Using the Speed Dial Memory

The speed dial memory allows you to store up to 10 names and numbers in the handset. You can dial these numbers with just a few key presses.

The speed dial memory is not limited to phone numbers. You can store any number (up to 20 digits) that you need to enter once your call connects. This is referred to as Chain Dialing. For example, you can save your bank account number to speed dial memory. When you call your bank's telephone teller service and are prompted to enter your account number, simply press the **memory** key and the speed dial number where you stored your account number. Then press the **select/remote** key.

Storing Names and Numbers in Speed Dial Memory

- 1) With the phone in standby mode, press the **memory** key.
- 2) Enter **0-9** to select the speed dial number where you would like to store this entry. You can also scroll through the list with the **▲** and **▼** keys. Press the **select/remote** key twice.
- 3) **Store Name** appears and a cursor flashes indicating that the phone is ready for the name to be entered.

If the selected speed dial number is already assigned, the edit screen appears. You can select **Edit** to edit this entry, select **Delete** to erase this entry, or select **Go Back** to choose another speed dial number.

```
Select Memory
01▶
02 JOHN DOE
```

```
Store Name
█
```

```
▶ Edit Memory01
Delete Memory01
Go Back
```

- 4) Enter a name according to the instructions below, then press the **select/remote** key. If no name is required, go to step 5.
- The name can be up to 13 characters.
 - Use the **#/→** and *** /tone/←** key to move the cursor to the desired location.
 - Use the **delete/chan** key to delete characters as needed.
 - Press and hold the **delete/chan** key to delete all the characters.

Refer to the letters on the number keys to select the desired characters. With each press of a numeric key, the displayed character appears in the following order: upper case letters first, lower case letters next and finally the number corresponding to the key.

If you make a mistake while entering a name

Use the *** /tone/←** or **#/→** key to move the cursor to the incorrect character. Press the **delete/chan** key to erase the wrong character. Then enter the correct character. To delete all characters, press and hold the **delete/chan** key.

For example, to enter **Movies**.

- 1) Press **6**. Then press the **#/→** key to move the cursor to the right.
- 2) Press **6** six times.
- 3) Press **8** six times.
- 4) Press **4** six times.
- 5) Press **3** five times.
- 6) Press **7** eight times.

	Number of times key is pressed								
keys	1	2	3	4	5	6	7	8	9
1	i								
2abc	A	B	C	a	b	c	2		
3def	D	E	F	d	e	f	3		
4ghi	G	H	I	g	h	i	4		
5jkl	J	K	L	j	k	l	5		
6mno	M	N	O	m	n	o	6		
7pqrs	P	Q	R	p	q	r	s	7	
8tuv	T	U	V	t	u	v	8		
9wxyz	W	X	Y	w	x	y	z	9	
0oper	*	#	-	=	<	>	(blank)	0	



If the next character uses the same number key, you must press the **#/→** key to move the cursor over. Otherwise the next time you press the number key, it changes the character that was previously set.

5) Store Number is displayed. The cursor flashes indicating that the phone is ready for the number to be entered.

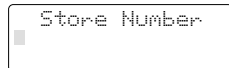

```
Store Number
█
```

6) Use the keypad to enter the phone number; each number can be up to 20 digits.
If you need the phone to pause during the dialing sequence, press the **redial/pause** key to insert a two-second delay between the numbers. You can enter multiple pauses to increase the delay. Each pause counts as a digit. The display shows a P for every pause.

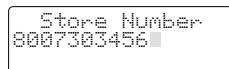

```
Store Number
8007303456█
```



When storing numbers into memory, if the handset is idle (i.e., no key is pressed) for more than 30 seconds, it will beep rapidly, and the phone will return to standby mode.

7) Press the **memory** key. You will hear a confirmation tone, and the following screen appears.
Memory storage is complete.
After about 2 seconds, the following screen displays all the speed dial memory entries.

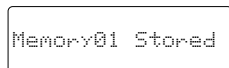

```
Memory01 Stored
```

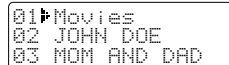

```
01▶ Movies
02 JOHN DOE
03 MOM AND DAD
```

8) Press the **end** key to exit memory setup mode. The phone returns to standby.

Storing Caller ID messages in Speed Dial Memory

Messages (Caller ID names/numbers) shown in the Caller ID list can be stored in memory dialing. For instructions on viewing the Caller ID Message list, see page 26.

- 1) Press the **call id/menu** key. Select the phone number to be stored from the Caller ID list by pressing the ▲ or ▼ key.
- 2) Press the **memory** key.
- 3) Enter a number (0 - 9) or press the ▲ or ▼ key to select the memory location to be stored.
- 4) Press the **select/remote** key. You hear a confirmation tone, and the number is stored in memory. The display returns to the Caller ID list.



If a number has already been stored in the selected memory number location, a confirmation screen is displayed. Press the ▲ key to select **Yes**. Press the **select/remote** key to overwrite. The display returns to the Caller ID list.

```
5/17 12:30PM 03
Jane Smith
214-555-1234
```

```
Select Memory
01▶
02 JOHN DOE
```

```
5/17 12:30PM
Jane Smith
214-555-1234
```

```
Replace Memory?
Yes
▶No
```



You cannot store a Caller ID message if no phone number appears in the message.

Making Calls from Speed Dial Memory

- 1) Press the **memory** key. The handset displays your programmed speed dial number.
- 2) Enter the number (**0 - 9**), or press the ▲ or ▼ key to select the speed dial number you would like to dial.
- 3) Press the **talk/flash** key. Talk and the number selected appear on the display. Then the displayed number is dialed.

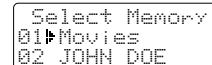

Select Memory
01 Movies
02 JOHN DOE

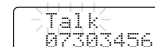

Talk
07303456

To cancel speed dialing

Press the **end** key to cancel speed dialing. The handset returns to standby mode. Also, if the handset is idle (e.g., no key is pressed) for 30 seconds, the phone returns to standby mode.

Caller ID and CIDCW (Caller ID on Call Waiting)

You must subscribe to Caller ID services through your local telephone provider to use these features. When the telephone rings, the Caller ID feature allows you to view the caller's name, phone number, date and time of call. The incoming call information is stored in the Caller ID record. If the Caller ID service includes the caller's name, the caller's name appears on the display (up to 15 letters).

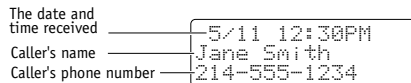

You may receive any one of the following messages:

When invalid data is received	Incomplete Data
When a private name is received	Private Name
When a private number is received	Private Number
When a unknown name is received	Unknown Name
When a unknown number is received	Unknown Number

note Data errors appear as "■".



- If you answer a call before the Caller ID message is received (for example, before the second ring), the Caller ID message will not appear.
- When the call is received via a telephone company that does not offer Caller ID service, the caller's phone number and name do not appear. (This includes international calls.)
- When the call is received via a private branch exchange (PBX), the caller's phone number and name may not appear.

CALLER ID AND CIDCW



note

- In Caller ID operation, if no key is pressed for more than 30 seconds, an error tone sounds and the handset returns to standby mode.
- Each message can be up to 15 characters for the name and 15 digits for the phone number.
- The number of calls from the same Caller ID appears next to the received time. Once you view the new message, the number will be cleared and disappear.
- During a call, don't press the **end** key, or the call will be disconnected.

Viewing the Caller ID Message List

The Caller ID list stores information for up to 30 incoming calls - even unanswered calls. You can also view the Caller ID list during a call.

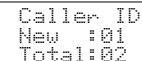
- 1) Press the **call id/menu** key.
The summary screen displays the number of new messages and total messages.
- 2) Use the ▼ key to scroll through the messages from the latest to the earliest, or use the ▲ key to scroll through the messages from the earliest to the latest.
- 3) Press the **call id/menu** key to return to talk mode, or press the **end** key to return to standby mode.



```
Caller ID
New :01
Total:02
```

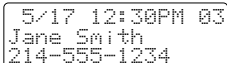

```
5/17 12:30PM 03
Jane Smith
214-555-1234
```

Deleting Information from the Caller ID List

If the phone receives more Caller ID messages than it can store, the oldest one in the list is automatically deleted. Caller ID data can also be deleted manually.

Deleting a Caller ID message

- 1) Press the **call id/menu** key in standby mode. Find the message to be deleted from the Caller ID list by pressing the ▲ or ▼ key.
- 2) Press the **delete/chan** key.
- 3) Press the ▲ or ▼ key to select **Yes**, and then press the **select/remote** key.

```
5/17 12:38PM 03
Jane Smith
214-555-1234
```

```
Delete Message?
▶ Yes
No
```

Deleting all Caller ID names/numbers

- 1) With the phone in standby mode, press the **call id/menu** key.
- 2) Press the **delete/chan** key.
- 3) Press the ▲ or ▼ key to select **Yes**, and then press the **select/remote** key. You hear a confirmation tone and all stored Caller ID messages are deleted.

```
Caller ID
New :01
Total:02
```

```
Delete All?
Yes
▶ No
```

```
Caller ID
Total:00
```



- While using the Delete All? or Delete Message? screen, if no key is pressed for more than 30 seconds, an error tone sounds, and the handset returns to standby mode.
- If you get an incoming call or page, the deleting operation is canceled and you can answer the call or page.



You cannot make a call from the Caller ID list if your cordless telephone is connected to a private branch exchange (PBX).

Making a Call from the Caller ID List

You can place a call from the Caller ID list.

- 1) Press the **call id/menu** key in standby mode. Select the phone number that you want to dial by pressing the ▲ or ▼ key.
- 2) To have the phone dial a 1 before the displayed Caller ID number, press **1**. To have the phone dial the stored area code before the displayed Caller ID number, press **3**.
- 3) Press the **talk/flash** key. The displayed phone number dials automatically.

```
5/17 12:30PM 03  
Jane Smith  
214-555-1234
```

```
Talk  
2145551234
```

Caller ID on Call Waiting (CIDCW)

With CIDCW, you will hear a Call Waiting tone while you are on a call, and the Caller ID data is displayed. To accept the waiting call, press the **talk/flash** key (see page 19).

The Integrated Answering Device

The cordless phone has a built-in answering system that answers and records incoming calls. You can also use your answering system to record a conversation, leave a voice memo message, or to announce a special outgoing message to callers when you're away from your phone.

Features

- Digital Tapeless Recording
- Access Messages with Handset Remote Key
- Up to 13 Minutes of Recording Time
- Call Screening
- Personal or Pre-recorded Outgoing Message
- Voice Prompts (English, French or Spanish)
- Time and Day Announcement
- Remote Message Retrieval
- Toll Saver
- Conversation Recording
- Voice Memo
- Selectable ringer options (high, low or off)

Digital Tapeless Recording allows you to quickly review, save, or delete the messages you choose. You will never have to worry about a tape wearing out, jamming, or resetting improperly.

The Integrated Answering System is easy to use, but **please read** through all of the instructions carefully.



note

- For your convenience, voice prompts will guide you through the menu mode.
- After the setting, press the **▶/■** key to exit the menu mode, or the **menu/clock** key to move to the next menu option.

Setting Up Your Answering System

Answering System Setting

To set the following six functions you must enter the menu mode.

Standby

menu/clock ↓

"Time"

menu/clock ↓

"Security Code"

menu/clock ↓

"Ring Time"

menu/clock ↓

"Record Time"

menu/clock ↓

"Message Alert"

menu/clock ↓

"Language"

menu/clock ↓

**Return to standby
(tone sounds)**

- With the phone in standby mode, use the **menu/clock** key to scroll through the menu options. The system returns to standby and sounds a tone after the last menu option.
- If any of the following occurs during menu setup, the system returns to standby, and you will have to start over with the procedure you were performing:
 - The **talk/flash** key is pressed
 - The **▶/■** (play/stop) key is pressed
 - 10 seconds elapse without a key press
 - An incoming call is received
- If the system remains idle for about five seconds after the announcement, the system returns to standby. Once the **volume/select/∧** or **∨** key is pressed, the idle time is extended to 10 seconds.

Setting the Time

The clock on the cordless phone's answering system starts when power is supplied to the base. Follow these steps to set the clock to the correct time.

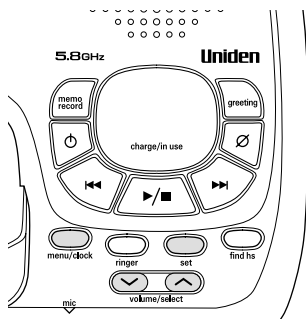

- 1) With the phone in standby mode, press the **menu/clock** key.
The system announces "Time" followed by the current time and the instructions for setting the time.
- 2) Press the **volume/select/∧** or **∨** key until the correct day is announced. The numbers [1] through [7] are displayed on the base.
- 3) Press the **set** key to select the day.
- 4) Press the **volume/select/∧** or **∨** key until you hear the correct hour setting. The numbers [1] through [12] are displayed on the base.
- 5) Press the **set** key to select the hour.
- 6) Press the **volume/select/∧** or **∨** key until you hear the correct minute setting. The numbers [00] through [59] are displayed on the base as each minute is announced.



- Normally, the system will return to standby if it remains idle for 10 seconds after the **volume/select/∧** or **∨** key is pressed. For setting the time, however, the idle time is extended to two minutes.
- Press and hold the **volume/select/∧** or **∨** key to quickly scroll through the numbers on the display.

- 7) Press the **set** key to select the minute.
- 8) Press the **volume/select/** \wedge or \vee key until you hear the correct AM or PM setting. The message counter displays [*A*] or [*P*].
- 9) Press the **set** key to select the AM/PM setting.

You hear a confirmation tone followed by the announcement "Time," and the day and time are then announced for your review. After a few seconds, the system announces "To set security code, press menu again."

Setting a Personal Security Code (PIN)

If you want to be able to play your messages from a remote location, you need to enter a two-digit Personal Identification Number (PIN) code (01-99). To select a PIN, perform the following steps:

- 1) With the phone in standby mode, press the **menu/clock** key twice.
The system announces "Security code," and the current PIN code is announced as it is displayed on the base. Then the system announces the instructions for setting the PIN code.
- 2) Press the **volume/select/** \wedge or \vee key until the desired number appears.
- 3) Press the **set** key to select the PIN code. You hear a confirmation tone, then the announcement "Security code" followed by the new PIN code is announced. After a few seconds, the system announces "To set ring time, press menu again."



note

The PIN code is set to "80" at the factory.

Setting the Ring Time

The ring time setting allows you to set the number of rings the caller hears before your answering system plays the outgoing message. You can set the ring time to answer after two, four, or six rings. If you select Toll Saver [65], the answering system picks up after two rings if you have new messages, and after four rings if there are none. This way, if you make a long distance call to check your messages, you can hang up after the second ring to avoid billing charges.

- 1) With the phone in standby mode, press the **menu/clock** key three times. You hear “Ring time” and the current ring time ([2], [4], [6], [65] Toll saver), and it is displayed on the base. Then you hear the guidance for setting the ring time.
- 2) Press the **volume/select/ ^** or **v** key until the desired ring time appears.
- 3) Press the **set** key to select the new ring time. You hear a confirmation tone, then the announcement “Ring time” followed by the new ring time. After a few seconds, the system announces “To set record time, press menu again.”



After setting the Announce only feature, you may want to change your outgoing message not to prompt the caller to leave a message. However, the prerecorded message changes automatically.

Selecting the Message Record Time

You have three record time options: one minute, four minutes, and "Announce only." "Announce only" answers the call with the preset greeting or your personal greeting but prevents the caller from leaving a message.

- 1) With the phone in standby mode, press the **menu/clock** key four times. You hear "Record time" and the current recording time ([/] 1 minute, [4] 4 minutes, [#] Announce only, No recording), and it is displayed on the base. Then you hear the guidance for setting the record time.
- 2) Press the **volume/select/^** or **v** key until the desired time appears.
- 3) Press the **set** key to select the new recording time. You hear a confirmation tone, then the announcement "Record time" followed by the new recording time. After a few seconds, the system announces "To set message alert, press menu again."

Setting the Message Alert tone

The message alert tone beeps every 15 seconds whenever you have unheard messages. The tone turns off automatically after you listen to all your new messages. You can also turn off the message alert tone by pressing any key on the base.

Follow the steps below to turn on the message alert tone:

- 1) With the phone in standby mode, press the **menu/clock** key five times. You hear “Message alert” and the current setting ([**OFF**] Off or [**ON**] On), and it is displayed on the base. Then you hear the instructions for setting the Message Alert.
- 2) Press the **volume/select/** \wedge or \vee key to make your selection.
- 3) Press the **set** key to select the new setting. You hear a confirmation tone, then the announcement “Message alert” followed by the current setting you have selected is announced. After a few seconds, the system announces “To set language, press menu again.” When the first new message is received, the alert tone will begin to sound.

Selecting the Language

The answering system voice announcements can be heard in English, French or Spanish. To choose the language of the answering system voice announcements:

- 1) With the phone in standby mode, press the **menu/clock** key six times. You hear the announcement “Language, English” followed by the guidance for setting the language. The current setting ([**E**], [**F**] or [**S**]) appears on the base.
- 2) Press the **volume/select/** \wedge or \vee key to select the desired language.
- 3) Press the **set** key. A confirmation tone is heard along with the setting in the language selected.

note

- Your greeting must be more than 2 seconds and less than 30 seconds to record.
- Position yourself as near to the base as possible and speak clearly when recording your outgoing message.

Setting Your Outgoing Message (Greeting)

When you receive a call, the answering system automatically plays either a preset message or your own greeting.

Preset message

The following message is prerecorded:

"Hello, no one is available to take your call. Please leave a message after the tone."

If the answering machine is set to announce only, the preset greeting automatically changes to:

"Hello. No one is available to take your call. Please call again."

 See "Selecting the Message Record Time", page 34 on how to set the announce only feature.

Recording a personal outgoing message (Greeting)

- 1) With the phone in standby mode, press and hold the ***greeting*** key.
You will hear the announcement "Record greeting" and a confirmation tone.
[--] flashes on the message counter.
- 2) Start recording your message. You have 30 seconds, and the message counter starts to count down [30] to [1] every second.
- 3) When you are finished recording your greeting, press the ***greeting*** key, the **▶/■** key or the ***set*** key. You hear a confirmation tone, and then your greeting plays back for you.

Choosing between the two outgoing messages

With the phone in standby mode, press the **greeting** key to play the current outgoing message. While the outgoing message is playing, press the **greeting** key again to switch between the prerecorded greeting and the personal greeting. After the message finishes playing, a confirmation tone is heard.



To delete the personal greeting, press the \emptyset key during the announcement and the system announces "Greeting has been deleted."

Setting the Base Ringer Volume

The base has three ringer volume settings: high, low, and off. You can change the ringer volume while in standby mode or while an incoming call is ringing.

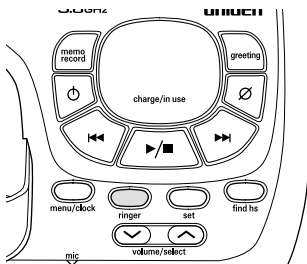

- 1) Press the **ringer** key.

You hear the ringer at the current volume level ([*H*] High, [*L*] Low, [*OFF*] off) (if you set the base ringer volume to off, "Ringer off" is announced) and it is displayed on the base.

- 2) Press the **ringer** key repeatedly until the desired ringer option appears.
- 3) The system displays the new ringer volume.



Although you have set the base ringer to off, the handset will still ring.

Temporarily Mute the Base Ringer and Call Screen

Press the **▶/■** key to temporarily mute the incoming ring and call screen. The ringer will sound with the next incoming call. To turn the ringer back on for this call, press the **ringer** key. To hear the answering machine and screen this call, press the **volume/select/∧** or **∨** key.

Adjusting the Speaker Volume Level

You can adjust the volume of the base speaker by pressing the **volume/select/∧** or **∨** key on the base. Press the **volume/select/∧** key for louder or the **volume/select/∨** key for softer while the base speaker is being used except for menu mode. The numbers [0]- [9] are displayed on the base indicating the volume levels. [0] being the softest and [9] being the loudest.

Turning the Answering System On/Off

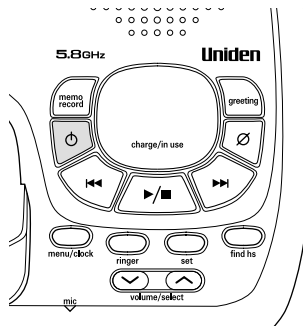

To turn the answering system on, press the **⊙** key. The system will announce “Answering system is on”. The current greeting message will be played, and you will hear a confirmation tone. The message counter displays the number of messages stored in memory. If the display flashes, then there are new messages waiting for you.

To turn the answering system off, press the **⊙** key again. After the announcement “Answering system is off”, the message counter display will no longer be illuminated.

Using Your Answering System

The message counter displays the number of messages stored in memory. If the display flashes, new messages waiting for you. The flashing number represents the number of new messages, not total messages. The cordless phone plays your new messages first; after all the new messages are played, you can play the old messages.



When the answering system is full, [FL] is displayed on the base, and the system announces "No remaining time." You should delete some messages so that the system can record new messages. (Refer to "Deleting a Message" on page 42.)

hint

To stop playing your messages, press the ►/■ key again at any time.

Playing your messages

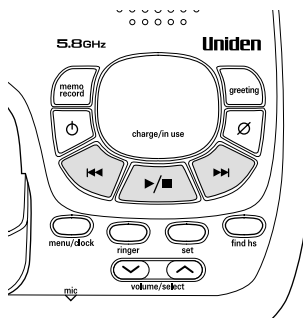

- 1) With the phone in standby mode, press the ►/■ key. The system announces the number of new and old messages. The LED displays the number of new messages, and the number flashes. The day and time that each message was received is announced after the message is played.
- 2) When all new messages have been played, you hear a confirmation tone and an announcement "End of messages." The message counter displays the total number of stored messages, and the system returns to standby.
- 3) After you have reviewed your new messages, you can play your old messages by pressing the ►/■ key again. Once you have listened to a new message, it becomes an old message. The old messages will be played in the order in which they were received.

Repeating a message

- 1) With the phone in standby mode, press the ►/■ key to review your messages. The number of stored messages are announced.

- 2) To repeat the current message, press the ⏮ (repeat/rew) key while the message is playing. To quickly scroll backwards through a message, press and hold the ⏮ (repeat/rew) key.
- 3) To go back to the previous message, press the ⏮ (repeat/rew) key as soon as a message begins playing. Each time you press ⏮ (repeat/rew), the system skips back one message.
- 4) Press the ▶/■ key at any time to stop reviewing messages and return to standby.

Skipping a message

- 1) With the phone in standby mode, press the ▶/■ key to review your messages. The number of messages is announced.
- 2) Press the ▶▶ key at any time to skip to the next message. Each time the ▶▶ key is pressed, the system scans forward one message. If you have several messages, press the ▶▶ key repeatedly to find the message you want to play. To quickly scroll forward through a message, press and hold the ▶▶ (skip/ff) key.
- 3) Press the ▶/■ key at any time to stop reviewing your messages and return to standby. The message counter shows the number of messages stored in memory.

Deleting a Message

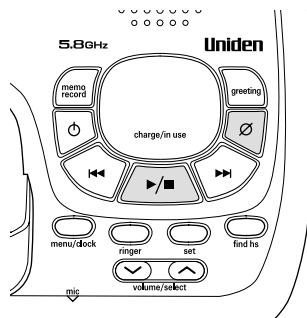

To maintain maximum record time, delete the old messages.

- 1) Press the ►/■ key to review your messages.
- 2) Press the ∅ key anytime during the message to delete.
- 3) You hear a confirmation tone and the message is deleted.

You can also delete all the messages.

- 1) Press the ∅ key in standby mode.
You hear an announcement "To delete all messages, press delete again."
- 2) Press the ∅ key again.
You hear a confirmation tone and [0] is displayed on the base. All the messages are deleted.

When you try to delete all messages without first listening to your new messages, you hear several short beeps followed by an announcement "Please playback all messages." This protects you from accidentally erasing messages you have not yet reviewed.

Voice memo

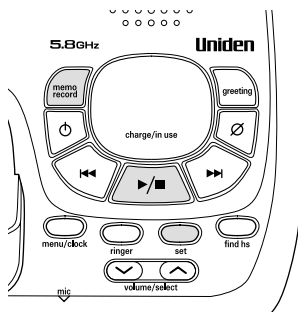

The voice memo function allows you to record messages (more than 2 seconds up to 4 minutes).

- 1) With the phone in standby mode, press and hold the **memo/record** key.
You hear an announcement "Record memo message" and a tone. [- -] flashes on the message counter.
- 2) Start your recording.
- 3) When you have finished, press the **▶/■**, **memo/record** or **set** key to stop recording. You hear a confirmation tone and the system returns to standby.

Recording a conversation

You can record up to 10 minutes of conversation while you are using your phone. Any conversation that lasts less than 2 seconds will not be recorded.

- 1) During a conversation from the handset, press and hold the **memo/record** key.
The unit begins recording with a confirmation tone and [- -] flashes on the message counter.

A beep that can be heard by both parties sounds during recording.

note If you receive a call waiting tone while recording a conversation, press the **talk/flash** key to accept the waiting call. The recording feature continues recording the new call. The original call is put on hold.

- 2) To stop recording, press the **▶/■** key or the **memo/record** key.
You hear a confirmation tone.

www.uniden.com



- When the answering system is full, [FL] appears on the message counter and recording is terminated.
- Every state has different regulations governing the recording of conversations over the telephone. Make sure to check your local, state and federal laws before using this product to record any telephone conversation in order to determine that your use is in compliance with such laws or guidelines.
- A recorded conversation is treated as a typical message and will be added to the stored messages.
- When recording a conversation, all dialing features except for flash (see page 19) are disabled. Stop recording if you need to enable any other handset keys.

Handset Operation

You can operate your answering system from another room using a handset.

- If you press the **end** key before the answering system answers, the phone will return to standby.
- If the answering system does not answer within five seconds, you hear beeps and the phone will return to standby.



- The base's keypad is disabled during remote operation.
- If you receive a call, the remote operation is canceled.
- During the remote operation [-] appears on the base.
- If you have new messages and old messages, only the new messages will be played. After you have reviewed your new messages, you can play your old messages by pressing the ►/2 key again.

1) With the phone in standby mode, press the **select/remote** key on the handset.

Remote Answering Machine operation appears on the display. The answering system announces the current time and the number of messages stored in the memory.

2) You hear "To play incoming message, press two. For help, press zero."

You hear intermittent beeps.

3) Enter a command within 15 seconds. You may select a command from the following chart:

Command	Function	Command	Function
◀◀ /1	Repeat a Message	■ /5	Stop Operation
▶ /2	Play Incoming Messages	6	Answering System On
▶▶ /3	Skip a Message	9	Answering System Off
∅ /4	Delete a Message	0	Voice Prompts

- 4) After the command has finished, you hear intermittent beeps indicating that the system is in the command waiting mode. You may enter another command at this time from the chart above.
- 5) When you are finished, hang up to exit the system. The answering system automatically returns to standby.

Remote Operation

When you are away from home, you can operate your answering system with any touch-tone telephone. Use this function to check for recorded messages, to play or delete messages, even record a new greeting message.

- 1) Call your telephone number.
- 2) During the greeting message, press **0** and enter your PIN code.
(See "Setting a Personal Security Code (PIN)," page 32).
- 3) The answering system announces the current time and the number of messages stored in memory. Then you hear "To play incoming message, press zero two. For help, press one zero."
- 4) You may continue to listen to the voice prompts, or you may select a command from the following chart:

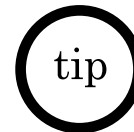

For your convenience remote operation cards are provided for you to use while away from home (located backward of this manual).



Once you enter the remote access menu, you must enter a command within 15 seconds, or the answering system automatically hangs up and returns to standby.

Command	Function
0 then 1	Repeat a Message
0 then 2	Play Incoming Messages
0 then 3	Skip a Message
0 then 4	Delete a Message
0 then 5	Stop Operation
0 then 6	Answering System On
0 then 7	Memo Record/Stop*
0 then 8	Greeting Message Record/Stop*
0 then 9	Answering System Off
1 then 0	Voice Prompts

* For Memo Record and Greeting Message Record functions, the first time you enter the corresponding command, it starts the Recording function. If you want to stop the recording, enter the command again.

- 5) After all of the Help Guidance prompts have played, you hear intermittent beeps indicating that the system is in the command waiting mode. You may enter another command at this time from the chart.
- 6) When you are finished, hang up to exit the system. The answering system automatically returns to standby.

Turn on the answering system remotely

If you have forgotten to turn on your answering system, you can turn it on remotely from any touch-tone telephone.

- 1) Call your telephone number.
- 2) Wait ten rings until the system answers. You hear a beep.
- 3) Press **0** and then enter your PIN code. The answering system announces the number of messages stored in memory. You hear "To play incoming message, press zero two. For help, press one zero."
- 4) Press **0** then **6** to turn the answering system On. You hear the outgoing message and a confirmation tone.
- 5) Hang up the phone; subsequent calls will be answered by the system.

Changing the Digital Security Code

To protect you against misbilled calls which might result from your phone being activated by other equipment, the cordless phone provides **AutoSecure™** to electronically lock your phone when the handset is in the base. Also, the **Random Code™** digital security which automatically selects one of over 262,000 digital security codes for the handset and base.

If the handset battery pack is completely discharged or the battery pack is removed, the digital security code will be lost. If this happens, a new security code is set automatically the next time the battery pack is charged.

In the rare situation that you suspect another cordless telephone is using the same security code, you can change the code.

- 1) Remove the handset from the base unit. Press and hold the **find hs** key on the base.
- 2) While holding the **find hs** key, place the handset in the base unit, and leave the handset on the base for more than 3 seconds. A new random security code is set.

Note on Power Sources

Low battery alert

When the battery pack is very low and needs to be charged, the phone is programmed to eliminate functions in order to save power. If the phone is not in use, **Low Battery** appears on the LCD and none of the keys will operate. If the phone is in use, **Low Battery** flashes and the handset beeps. Complete your conversation as quickly as possible and return the handset to the base unit for charging.

Low Battery



Information stored in the phone's memory will be retained for 30 minutes after the battery pack is removed. This includes all setup information, last number dialed, speed dial memory, and the CID list.

Even when the battery pack is not being used, it will gradually discharge over a long period of time. For optimum performance, be sure to return the handset to the base unit after a telephone call.

Battery replacement and handling

When the operating time becomes short, even after a battery is recharged, please replace the battery. With normal usage, your battery should last about one year. A replacement battery may be purchased by calling Uniden's Parts Department (see back cover page).

Warning: To avoid the risk of personal injury or property damage from fire or electrical shock, only use the Uniden battery model and Uniden adapter model specifically designated for this product.

Power Failure

During the period that the power is off, you will not be able to make or receive calls with the telephone.

Caution

- Use only the specified Uniden battery pack (BT-800).
- Do not remove the battery from the handset to charge it.
- Never throw the battery into a fire, disassemble it, or heat it.
- Do not remove or damage the battery casing.

Cleaning the battery charging contacts

To maintain a good charge, it is important to clean the charging contacts on the handset once a month. Using water only, dampen a cloth to clean the charging contacts. Then make sure to go back over the charging contacts with a dry cloth before returning the handset to the base to charge.

Caution

Do not use paint thinner, benzene, alcohol, or other chemical products. Doing so may discolor the surface of the telephone and damage the finish.

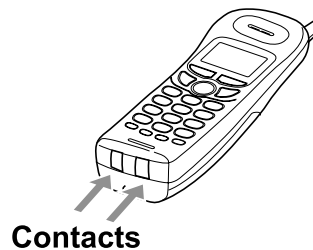

General Information

The phone complies with FCC Parts 15 and 68.
Operating temperature: -10°C to 50°C (+14°F to +122°F)

AC Adapter Information

AC Adapter part number: AD-314
Input Voltage: 120V AC 60Hz
Output Voltage: 9V DC 350 mA

Battery Information

Battery part number: BT-800
Capacity: 800 mAh, 3.6V

Frequency

925.181-927.451 MHz
5739.320-5746.130 MHz



- **To avoid damage to the phone use only Uniden AD-314 and BT-800 (or BT-905 having less usage time) with your phone.**
- If the handset is left off the base, the actual Talk Mode duration will be reduced respective to the amount of time the handset is off the base.

Recharge your phone on a regular basis by returning the handset to the base after each phone call. When the operating time becomes short, even after the battery is recharged, please replace the battery. With normal usage, the battery should last about one year.

A replacement Uniden adapter or battery may be purchased by calling Uniden's Parts Department (see back cover page).

Specifications, features, and availability of optional accessories are all subject to change without prior notice.

www.uniden.com

GENERAL INFORMATION [51]

Troubleshooting

If your phone is not performing to your expectations, please try these simple steps first. If these steps do not solve your problem, please call our Customer Hotline at 1-800-297-1023. (Mon - Fri 7 am to 7 pm, Sat/Sun 9 am to 5 pm, CST. Phone support is closed on holidays.)

Symptom	Suggestion
The charge/in use LED won't illuminate when the handset is placed in the base.	<ul style="list-style-type: none"> • Make sure the AC adapter is plugged into the base and wall outlet. • Make sure the handset is properly seated in the base. • Make sure the charging contacts on the handset are clean.
The audio sounds weak and/or scratchy.	<ul style="list-style-type: none"> • Move the handset and/or base away from metal objects or appliances and try again. • Press the <i>delete/chan</i> key in the talk mode to help eliminate background noise. • Make sure that the handset is not too far from the base.
Can't make or receive calls.	<ul style="list-style-type: none"> • Check both ends of telephone line cord. • Make sure the AC adapter is plugged into the base and wall outlet. • Disconnect the AC adapter for a few minutes, then reconnect it. • Change the digital security code (see page 48). • Make sure that the handset is not too far from the base. • Check the dialing mode used by your telephone company.
The handset doesn't ring or receive a page.	<ul style="list-style-type: none"> • The battery pack may be weak. Charge the battery for 15-20 hours. • The handset may be too far away from the base unit. • Place the base unit away from appliances or metal objects. • Change the digital security code (see page 48). • Check the battery pack to ensure there is a secure connection. • Make sure ringer volume isn't set to "off".

Symptom	Suggestion
Severe noise interference.	<ul style="list-style-type: none"> • Keep the handset away from microwave ovens, computers, remote control toys, wireless microphones, alarm systems, intercoms, room monitors, fluorescent lights, and electrical appliances. • Move the base to another location or turn off the source of interference.
The Caller ID does not display.	<ul style="list-style-type: none"> • The call was answered before the second ring. • The call was placed through a switchboard. • Charge the handset. • Your Caller ID service may not be active; contact your local telephone service provider.
The answering system does not work.	<ul style="list-style-type: none"> • Make sure the the AC adapter is plugged into wall outlet. • Make sure the answering system is turned on.
The answering system does not record any messages.	<ul style="list-style-type: none"> • Set the record time to either the one minute or four minute option. • The memory may be full. Delete some or all of the saved messages.
Messages are incomplete.	<ul style="list-style-type: none"> • The incoming messages may be too long. Remind callers to leave a brief message. • The memory may be full. Delete some or all of the saved messages.
After a power failure, the outgoing message is deleted.	<ul style="list-style-type: none"> • Record your personal outgoing message again. The default message should remain.
No sound on the base unit speaker during call monitoring or message playback.	<ul style="list-style-type: none"> • Adjust the speaker volume on the base unit.
Cannot access remote call-in features from another touch-tone phone.	<ul style="list-style-type: none"> • Make sure you're using the correct PIN code. • Make sure that the touch-tone phone you're using can transmit the tone for at least two seconds. If it cannot, you may have to use another phone to access your messages.

Liquid Damage

Moisture and liquid can damage your cordless phone. In case of accidental submersion, please read the following steps.

Case	Action
If the handset or base is exposed to moisture or liquid, but only affects the exterior plastic housing.	Wipe off the liquid, and use as normal.
If moisture or liquid has entered the plastic housing (i.e. liquid can be heard in the phone or liquid has entered the handset battery compartment or vent openings on the base).	<p>Handset:</p> <ol style="list-style-type: none"> 1. Remove the battery cover and leave it off for ventilation. 2. Remove the battery pack by disconnecting. 3. Leave the battery cover off and the battery pack disconnected for at least 3 days. 4. Once the phone is completely dry, reconnect the battery pack and the battery cover. 5. Recharge the handset's battery pack for 20 hours in the base unit before using again. <p>Base:</p> <ol style="list-style-type: none"> 1. Disconnect the AC adapter from the base unit, cutting off electrical power. 2. Disconnect the telephone cord from the base unit. 3. Let dry for at least 3 days. <p>IMPORTANT: You must unplug the telephone line while recharging the battery pack to avoid charge interruption.</p> <p>CAUTION: DO NOT use a microwave oven to speed up the drying process. This will cause permanent damage to the handset, base and the microwave oven.</p> <p>After following these steps, if your cordless telephone does not work, please call our Customer Service Hotline at 1-800-297-1023.</p>

Precautions!

Before you read anything else, please observe the following:

Warning!

Uniden America Corporation DOES NOT represent this unit to be waterproof. To reduce the risk of fire, electrical shock, or damage to the unit, DO NOT expose this unit to rain or moisture.

Rechargeable Nickel-Cadmium Battery Warning

- This equipment contains a rechargeable nickel-cadmium battery.
- Cadmium is a chemical known to the State of California to cause cancer.
- The rechargeable nickel-cadmium battery contained in this equipment may explode if disposed of in a fire.
- **Do not** short-circuit the battery.
- **Do not** charge the rechargeable nickel-cadmium battery used in this equipment in any charger other than the one designed to charge this battery as specified in the owner's manual. Using another charger may damage the battery or cause the battery to explode.

Rechargeable Nickel-Cadmium Batteries Must Be Recycled or Disposed of Properly



- Uniden voluntarily participates in an RBR[®] industry program to collect and recycle nickel-cadmium batteries at the end of their useful life, when taken out of service within the United States. The RBR[®] program provides a convenient alternative to placing used nickel-cadmium batteries into the trash or municipal waste stream, which is illegal in some areas.
- Through the RBR[®] program, Uniden makes it easy for you to drop off the used battery at local retailers of replacement nickel-cadmium batteries. You may also contact your local recycling center for information on where to return the used battery. Please call 1-800-8-BATTERY for information on Ni-Cd battery recycling in your area. Uniden's involvement in this program is part of its commitment to protecting our environment and conserving natural resources.
- RBR[®] is a registered trademark of the Rechargeable Battery Recycling Corporation.



The exclamation point within an equilateral triangle is intended to alert the user to the presence of important operating and maintenance (servicing) instructions in the literature accompanying the appliance.

Uniden works to reduce lead content in our PVC coated cords in our product and accessories.

Warning!

The cords on this products and/or accessories contain lead, a chemical known to the State of California to cause birth defects or other reproductive harm. **Wash hands after handling.**

Important Safety Instructions

When using your telephone equipment, basic safety precautions should always be followed to reduce the risk of fire, electric shock and injury to persons, including the following:

1. Do not use this product near water, for example, near a bath tub, wash bowl, kitchen sink or laundry tub, in a wet basement or near a swimming pool.
2. Avoid using a telephone (other than a cordless type) during an electrical storm. There may be a remote risk of electric shock from lightning.
3. Do not use the telephone to report a gas leak in the vicinity of the leak.
4. Use only the power cord and batteries indicated in this manual. Do not dispose of batteries in a fire. They may explode. Check with local codes for possible battery disposal instructions.
5. Do not disassemble any component of this product.

SAVE THESE INSTRUCTIONS!

CAUTION

Risk of explosion if battery is replaced by an incorrect type. Dispose of used batteries according to the instructions. Do not open or mutilate the battery, and disconnect the battery before shipping this product.

The FCC Wants You To Know

This equipment complies with Part 68 of the FCC rules and the requirements adopted by the ACTA. On the bottom of this equipment is a label that contains, among other information, a product identifier in the format US:AAEQ#TXXX. If requested, this number must be provided to the telephone company.

An applicable Universal Service Order Codes (USOC) certification for the jacks used in this equipment is provided (i.e., RJ11C) in the packaging with each piece of approved terminal equipment.

A plug and jack used to connect this equipment to the premises wiring

and telephone network must comply with the applicable FCC Part 68 rules and requirements adopted by the ACTA. A compliant telephone cord and modular plug is provided with this product. It is designed to be connected to a compatible modular jack that is also compliant. See installation instructions for details.

The REN is used to determine the number of devices that may be connected to a telephone line. Excessive RENs on a telephone line may result in the devices not ringing in response to an incoming call. In most but not all areas, the sum of RENs should not exceed five (5.0). To be certain of the number of devices that may be connected to a line, as determined by the total RENs, contact the local telephone company. For products approved after July 23, 2001, the REN for this product is part of the product identifier that has the format US:AAEQ#TXXX. The digits represented by ## are the REN without a decimal point (e.g., 03 is a REN of 0.3). For earlier products, the REN is separately shown on the label. If this equipment causes harm to the telephone network, the telephone company will notify you in advance that temporary discontinuance of service may be required. But if advance notice isn't practical, the telephone company will notify the customer as soon as possible. Also, you will be advised of your right to file a complaint with the FCC if you believe it is necessary.

The telephone company may make changes in its facilities, equipment, operations or procedures that could affect the operation of the equipment. If this happens the telephone company will provide advance notice in order for you to make necessary modifications to maintain uninterrupted service.

Please follow instructions for repairing, if any (e.g. battery replacement section); otherwise do not substitute or repair any parts of the device except as specified in this manual.

Connection to party line service is subject to state tariffs. Contact the state public utility commission, public service commission or corporation commission for information. This equipment is hearing aid compatible. Should you experience trouble with this equipment, please contact Uniden customer service at 800-297-1023. If the equipment is causing harm to the telephone network, the telephone company may request that you disconnect the equipment until the problem is resolved.

NOTICE: According to telephone company reports, AC electrical surges, typically resulting from lightning strikes, are very destructive to telephone equipment connected to AC power sources. To minimize damage from these types of surges, a surge arrest or is recommended. Changes or modifications to this product not expressly approved by Uniden, or operation of this product in any way other than as detailed by the owner's manual, could void your authority to operate this

product. This device complies with part 15 of the FCC rules. Operation is subject to the following two conditions: (1) This device may not cause harmful interference, and (2) This device must accept any interference received, including interference that may cause undesired operation. Privacy of communications, may not be ensured when using this phone. To insure the safety of users, the FCC has established criteria for the amount of radio frequency energy various products may produce depending on their intended usage. This product has been tested and found to comply with the FCC's exposure criteria. For body worn operation, the FCC RF exposure guidelines were also met when used with the Uniden accessories supplied or designed for this product. Use of other accessories may not ensure compliance with FCC RF exposure guidelines and should be avoided.

Radio Interference

Radio interference may occasionally cause buzzing and humming in your cordless handset, or clicking noises in the base. This interference is caused by external sources such as TV, refrigerator, vacuum cleaner, fluorescent lighting, or electrical storm. Your unit is NOT DEFECTIVE. If these noises continue and are too distracting, please check around your home to see what appliances may be causing the problem. In addition, we recommend that the base not be plugged into a circuit that also powers a major appliance because of the potential for interference. Be certain that the antenna on the unit is fully extended when needed. In the unlikely event that you consistently hear other voices or distracting transmissions on your phone, you may be receiving radio signals from another cordless telephone or other source of interference. If you cannot eliminate this type of interference, you need to change to a different channel.

Finally, it should be noted that some cordless telephones operate at frequencies that may cause interference to nearby TVs and VCRs. To minimize or prevent such interference, the base of the cordless telephone should not be placed near or on top of a TV or VCR. If interference is experienced, moving the cordless telephone farther away from the TV or VCR will often reduce or eliminate the interference.

Cordless Telephone Privacy

Cordless telephones are radio devices. Communications between the handset and base of your cordless telephone are accomplished by means of radio waves which are broadcast over the open airways.

Because of the inherent physical properties of radio waves, your communications can be received by radio receiving devices other than your own cordless telephone unit. Consequently, any communications using your cordless telephone may not be private.

One Year Limited Warranty

Important: Evidence of original purchase is required for warranty service. **WARRANTOR:** UNIDEN AMERICA CORPORATION ("Uniden")

ELEMENTS OF WARRANTY: Uniden warrants, for one year, to the original retail owner, this Uniden Product to be free from defects in materials and craftsmanship with only the limitations or exclusions set out below.

WARRANTY DURATION: This warranty to the original user shall terminate and be of no further effect 12 months after the date of original retail sale. The warranty is invalid if the Product is (A) damaged or not maintained as reasonable or necessary, (B) modified, altered, or used as part of any conversion kits, subassemblies, or any configurations not sold by Uniden, (C) improperly installed, (D) serviced or repaired by someone other than an authorized Uniden service center for a defect or malfunction covered by this warranty, (E) used in any conjunction with equipment or parts or as part of any system not manufactured by Uniden, or (F) installed or programmed by anyone other than as detailed by the owner's manual for this product.

STATEMENT OF REMEDY: In the event that the product does not conform to this warranty at any time while this warranty is in effect, warrantor will either, at its option, repair or replace the defective unit and return it to you without charge for parts, service, or any other cost (except shipping and handling) incurred by warrantor or its representatives in connection with the performance of this warranty. Warrantor, at its option, may replace the unit with a new or refurbished unit. **THE LIMITED WARRANTY SET FORTH ABOVE IS THE SOLE AND ENTIRE WARRANTY PERTAINING TO THE PRODUCT AND IS IN LIEU OF AND EXCLUDES ALL OTHER WARRANTIES OF ANY NATURE WHATSOEVER, WHETHER EXPRESS, IMPLIED OR ARISING BY OPERATION OF LAW, INCLUDING, BUT NOT LIMITED TO ANY IMPLIED WARRANTIES OF MERCHANTABILITY OR FITNESS FOR A PARTICULAR PURPOSE. THIS WARRANTY DOES NOT COVER OR PROVIDE FOR THE REIMBURSEMENT OR**

PAYMENT OF INCIDENTAL OR CONSEQUENTIAL DAMAGES. Some states do not allow this exclusion or limitation of incidental or consequential damages so the above limitation or exclusion may not apply to you.

LEGAL REMEDIES: This warranty gives you specific legal rights, and you may also have other rights which vary from state to state. This warranty is void outside the United States of America and Canada.

PROCEDURE FOR OBTAINING PERFORMANCE OF WARRANTY: If, after following the instructions in the owner's manual you are certain that the Product is defective, pack the Product carefully (preferably in its original packaging). Disconnect the battery from the Product and separately secure the battery in its own separate packaging within the shipping carton. The Product should include all parts and accessories originally packaged with the Product. Include evidence of original purchase and a note describing the defect that has caused you to return it. The Product should be shipped freight prepaid, by traceable means, to warrantor at:

Uniden America Service

4700 Amon Carter Blvd.
Fort Worth, TX 76155

I.C. Notice

TERMINAL EQUIPMENT

NOTICE: This equipment meets the applicable Industry Canada Terminal Equipment Technical Specifications. This is confirmed by the registration number. The abbreviation, IC, before the registration number signifies that registration was performed based on a Declaration of Conformity indicating that Industry Canada technical specifications were met. It does not imply that Industry Canada approved the equipment.

NOTICE: The Ringer Equivalence Number (REN) for this terminal equipment is marked on the equipment itself. The REN assigned to each terminal equipment provides an indication of the maximum number of terminals allowed to be connected to a telephone interface. The termination on an interface may consist of any combination of devices subject only to the requirement that the sum of the Ringer Equivalence Numbers of all the devices does not exceed five.

RADIO EQUIPMENT

The term "IC:" before the radio certification number only signifies that Industry Canada technical specifications were met.

Operation is subject to the following two conditions: (1) this device may not cause interference, and (2) this device must accept any interference, including interference that may cause undesired operation of the device. "Privacy of communications may not be ensured when using this telephone".

Index

A

AC adapter information	51
Answering system	
Deleting a message	42
Playing a message	40
Recording a conversation	43
Remote access	45
Repeating a message	40
Skipping a message	41
Turning on/off	39

B

Base setup	13
Battery pack	
Information	51
Installing	7
Preparing and charging	7
Replacement and handling	49
Beltclip installation	11

C

Caller ID service	25
Call Waiting	19
Deleting	27
Making a call	28
Viewing	26
Channel	18
Charging the battery pack	8
Cleaning contacts	50
Clock	31
Connect the base unit	9
Controls and functions	4

D

Dialing mode.....	14
Digital security code	48

E, F, G, H, I, J, K, L

Earpiece volume.....	17
Find Handset.....	19
General information	51
Greeting.....	36
Handset Operation	44
Headset installation	12
I.C. Notice	57
Installing the phone	7
Interference	56
Liquid damage.....	54

M, N, O, P, Q

Making a call	16
Menu mode	30
Message alert	34
Outgoing message	36
Personal security code (PIN code) ..	32
Precautions.....	55

R

Receiving a call.....	16
Recording time	34
Redial	17
Remote operation.....	45
Ring time	33
Ringer tone	15
Ringer volume (Base)	38

S

Speed dial memory	
Making call from	
speed dial memory	24
Storing names and numbers	
in speed dial memory	20

T, U

Technical information	51
Tone dialing switch-over	18
Traveling out-of-range	18
Troubleshooting	52

V, W, X, Y, Z

Voice memo	43
Volume control	
Base.....	38
Handset	15, 17
Wall mounting	10
Warranty	56

Memo

Memo

Remote Operation Card

REMOTE OPERATION CARD

Uniden

Remote access away from home

Turn on the answering system remotely

- | | |
|----------------------------------------------------------------------------------------------------------------------------------------------------------------------------------------------------------------------------------------------------------------------------------------------------------------------------------------------------------------------|-------------------------------------------------------------------------------------------------------------------------------------------------------------------------------------------------------------------------------------------------------------------------------|
| <ol style="list-style-type: none"> 1. Call your phone number from a touch-tone phone. 2. During the outgoing message, press 0 and enter your PIN code. The answering system announces the number of messages stored in memory and the help guidance. The phone stands by for you to enter a command. 3. To quit, hang up the phone. | <ol style="list-style-type: none"> 1. Call your phone and let it ring 10 times until it answers. 2. Press 0 and enter your PIN code. 3. Press 0 then 5 to stop the announcement. 4. Press 0 then 6 to turn the answering system on. |
|----------------------------------------------------------------------------------------------------------------------------------------------------------------------------------------------------------------------------------------------------------------------------------------------------------------------------------------------------------------------|-------------------------------------------------------------------------------------------------------------------------------------------------------------------------------------------------------------------------------------------------------------------------------|

REMOTE OPERATION CARD

Uniden

Remote access away from home

Turn on the answering system remotely

- | | |
|----------------------------------------------------------------------------------------------------------------------------------------------------------------------------------------------------------------------------------------------------------------------------------------------------------------------------------------------------------------------|-------------------------------------------------------------------------------------------------------------------------------------------------------------------------------------------------------------------------------------------------------------------------------|
| <ol style="list-style-type: none"> 1. Call your phone number from a touch-tone phone. 2. During the outgoing message, press 0 and enter your PIN code. The answering system announces the number of messages stored in memory and the help guidance. The phone stands by for you to enter a command. 3. To quit, hang up the phone. | <ol style="list-style-type: none"> 1. Call your phone and let it ring 10 times until it answers. 2. Press 0 and enter your PIN code. 3. Press 0 then 5 to stop the announcement. 4. Press 0 then 6 to turn the answering system on. |
|----------------------------------------------------------------------------------------------------------------------------------------------------------------------------------------------------------------------------------------------------------------------------------------------------------------------------------------------------------------------|-------------------------------------------------------------------------------------------------------------------------------------------------------------------------------------------------------------------------------------------------------------------------------|

REMOTE OPERATION CARD

Uniden

Remote access away from home

Turn on the answering system remotely

- | | |
|----------------------------------------------------------------------------------------------------------------------------------------------------------------------------------------------------------------------------------------------------------------------------------------------------------------------------------------------------------------------|-------------------------------------------------------------------------------------------------------------------------------------------------------------------------------------------------------------------------------------------------------------------------------|
| <ol style="list-style-type: none"> 1. Call your phone number from a touch-tone phone. 2. During the outgoing message, press 0 and enter your PIN code. The answering system announces the number of messages stored in memory and the help guidance. The phone stands by for you to enter a command. 3. To quit, hang up the phone. | <ol style="list-style-type: none"> 1. Call your phone and let it ring 10 times until it answers. 2. Press 0 and enter your PIN code. 3. Press 0 then 5 to stop the announcement. 4. Press 0 then 6 to turn the answering system on. |
|----------------------------------------------------------------------------------------------------------------------------------------------------------------------------------------------------------------------------------------------------------------------------------------------------------------------------------------------------------------------|-------------------------------------------------------------------------------------------------------------------------------------------------------------------------------------------------------------------------------------------------------------------------------|

REMOTE OPERATION CARD

Uniden

Remote access away from home

Turn on the answering system remotely

- | | |
|----------------------------------------------------------------------------------------------------------------------------------------------------------------------------------------------------------------------------------------------------------------------------------------------------------------------------------------------------------------------|-------------------------------------------------------------------------------------------------------------------------------------------------------------------------------------------------------------------------------------------------------------------------------|
| <ol style="list-style-type: none"> 1. Call your phone number from a touch-tone phone. 2. During the outgoing message, press 0 and enter your PIN code. The answering system announces the number of messages stored in memory and the help guidance. The phone stands by for you to enter a command. 3. To quit, hang up the phone. | <ol style="list-style-type: none"> 1. Call your phone and let it ring 10 times until it answers. 2. Press 0 and enter your PIN code. 3. Press 0 then 5 to stop the announcement. 4. Press 0 then 6 to turn the answering system on. |
|----------------------------------------------------------------------------------------------------------------------------------------------------------------------------------------------------------------------------------------------------------------------------------------------------------------------------------------------------------------------|-------------------------------------------------------------------------------------------------------------------------------------------------------------------------------------------------------------------------------------------------------------------------------|

Remote Operation Card

C U T

Task	Key
Repeat a Message	0 1
Play Incoming Messages	0 2
Skip a Message	0 3
Delete a Message	0 4
Stop Operation	0 5
Answering System On	0 6
Memo Record/Stop	0 7
Greeting Message Record/Stop	0 8
Answering System Off	0 9
Voice Prompts	1 0

C U T

Task	Key
Repeat a Message	0 1
Play Incoming Messages	0 2
Skip a Message	0 3
Delete a Message	0 4
Stop Operation	0 5
Answering System On	0 6
Memo Record/Stop	0 7
Greeting Message Record/Stop	0 8
Answering System Off	0 9
Voice Prompts	1 0

C U T

Task	Key
Repeat a Message	0 1
Play Incoming Messages	0 2
Skip a Message	0 3
Delete a Message	0 4
Stop Operation	0 5
Answering System On	0 6
Memo Record/Stop	0 7
Greeting Message Record/Stop	0 8
Answering System Off	0 9
Voice Prompts	1 0

C U T

Task	Key
Repeat a Message	0 1
Play Incoming Messages	0 2
Skip a Message	0 3
Delete a Message	0 4
Stop Operation	0 5
Answering System On	0 6
Memo Record/Stop	0 7
Greeting Message Record/Stop	0 8
Answering System Off	0 9
Voice Prompts	1 0

At Uniden, we'll take care of you!

Thank you for purchasing a Uniden product. If you have any questions or problems,
please do not return this product to the place of purchase.

Having Trouble?

Our customer care specialists are here to help you! Visit our website at www.uniden.com or call our Customer Hotline at **1-800-297-1023**, Mon-Fri, 7 a.m. to 7 p.m. or Sat/Sun, 9 a.m. to 5 p.m. CST. (Phone support is closed on holidays.)



Need a part?

To order headsets, additional handsets, replacement batteries or other accessories, visit our website at www.uniden.com or call **1-800-554-3988**, Mon-Fri, 8 a.m. to 5 p.m. CST.



Help for our Special Needs Customers

If you need special assistance due to a disability or have questions on the accessibility features of this product, please call **1-800-874-9314 (voice or TTY)**



Uniden®

May be covered under one or more of the following U.S. patents:

4,797,916	5,381,460	5,426,690	5,434,905	5,491,745	5,493,605
5,533,010	5,574,727	5,581,598	5,650,790	5,660,269	5,661,780
5,663,981	5,671,248	5,696,471	5,717,312	5,732,355	5,754,407
5,758,289	5,768,345	5,787,356	5,794,152	5,801,466	5,825,161
5,864,619	5,893,034	5,912,968	5,915,227	5,929,598	5,930,720
5,960,358	5,987,330	6,044,281	6,070,082	6,125,277	6,253,088
6,314,278	6,418,209	6,618,015	6,671,315	6,714,630	6,782,098
6,788,920	6,788,953				

Other patents pending.

FOR
ACCESSORIES,
GO ONLINE @
WWW.UNIDEN.COM

REGISTER ONLINE TODAY!
THANK YOU FOR BUYING A UNIDEN PRODUCT.

A World Without Wires | **Uniden®**