

Uniden®

EWCI 936

SERIES

OWNER'S

MANUAL

OWNER'S MANUAL

Contents

Welcome/Features	2	Making and Receiving Calls	36
Controls and Functions	3	Making Calls from Speed Dial Memory	37
Terms Used in this Manual	5	Making a Call from the Caller ID List	38
Getting Started		Adjusting the Earpiece Volume	38
Installing the Phone and Outdoor Sensor	6	Using a Headset	39
A. Choose the Best Location		Headset installation	39
(Base and Handset)	6	Making calls with the headset	39
B. Install the Rechargeable Battery Pack into the Handset	8	Receiving calls with the headset	40
C. Connect the Base, Set up the Outdoor sensor and		Installing the Beltclip	40
Charge the Handset	9	Tone Dialing Switch-over	41
D. Wall Mounting the Outdoor sensor	11	Traveling Out-of-Range	41
E. Mount the Base Unit on a Wall	12	Selecting a Different Channel	41
Weather Menu Options	14	Finding a Lost Handset	42
Set the Alarm Clock	17	Using Call Waiting	42
Basic Phone Setup	19	Voice Mail Waiting Indicator	43
Programming Memory Locations/Caller ID/Speed Dialing	23	Additional Information	
Storing Names and Numbers in Speed Dial Memory	23	Changing the Digital Security Code	44
Storing Caller ID Messages in Speed Memory Locations	26	Note on Power Sources	45
Caller ID and CIDCW (Caller ID on Call Waiting)	27	General Information	48
When the Telephone Rings	27	Troubleshooting	49
Viewing the Caller ID Message List	28	Liquid Damage	52
Deleting Information from the Caller ID List	29	Precautions & Warranty	53
Using Your EWC1936		I.C. Notice	55
Using the Weather Station	30	TERMINAL EQUIPMENT	55
Reading the Weather Display at the Base	30	RADIO EQUIPMENT	55
Reading the Weather Data from the Handset	35	Index	56
Making Calls from Speed Dial Memory	35	Memory List	57
Using Your Phone	36		

Welcome

Congratulations on your purchase of the Uniden cordless telephone. This phone is designed and engineered to exacting standards for reliability, long life, and outstanding performance.

Note: Illustrations in this manual are used for explanation purposes. Some illustrations in this manual may differ from the actual unit. The color of your cordless phone may vary.



As an Energy Star™ Partner, Uniden has determined that this product or product models meets the Energy Star™ guidelines for energy efficiency. Energy Star™ is a U.S. registered mark.

Features

- 900MHz Extended Range Technology
- Weather Forecast Display at both Handset & Base
- Weather Forecast Display (Barometric Variation, Moon Phase, Tide Level, Temperature, Indoor and Outdoor Humidity)
- Time & Calendar Display
- Alarm with Snooze Feature
- Backlight and LCD Contrast Control
- 3 Line Backlit Display
- Caller ID and Caller ID on Call Waiting
- 10 Number Memory Dialing
- Last Number Redial
- Voice Mail Waiting Indicator
- English, French or Spanish Support
- Pulse/Tone Dialing
- Find Handset Locator
- Earpiece Volume Control
- Ringer Volume Control
- Hearing Aid Compatible
- 17 Channel Autoscan

Be sure to visit our web site: www.uniden.com

Uniden® is registered trademark of Uniden America Corporation.

AutoTalk, AutoStandby, UltraClear Plus, Random Code, and AutoSecure are trademarks of Uniden America Corporation.

www.uniden.com

WELCOME/FEATURES [2]

Controls and Functions Handset

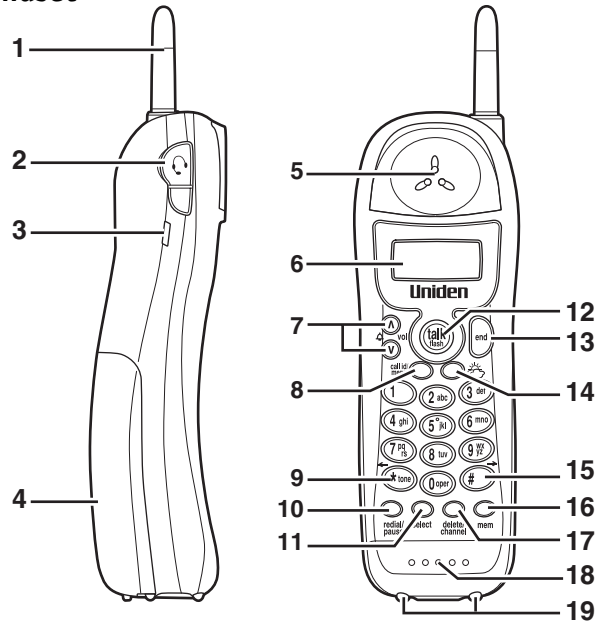

1. Handset antenna
2. Jack for optional headset
3. Beltclip hole
4. Handset battery compartment
5. Handset earpiece
6. LCD display
7. \wedge/\vee /vol/ \updownarrow (earpiece volume, ringer volume and scroll) key (pages 19, 22 and 38)
8. call id/menu key (pages 19 and 28)
9. \ast /tone/ \leftarrow key (left cursor) key (pages 24 and 41)
10. redial/pause key (pages 25 and 37)
11. select key (page 19)
12. talk/flash key (pages 35 and 42)
13. end key (pages 36 and 38)
14.  key (page 35)
15. $\#/\downarrow$ (right cursor) key (page 24)
16. mem key (page 23)
17. delete/channel key (pages 24, 29 and 41)
18. Handset microphone and ringer speaker
19. Handset charging contacts

Base

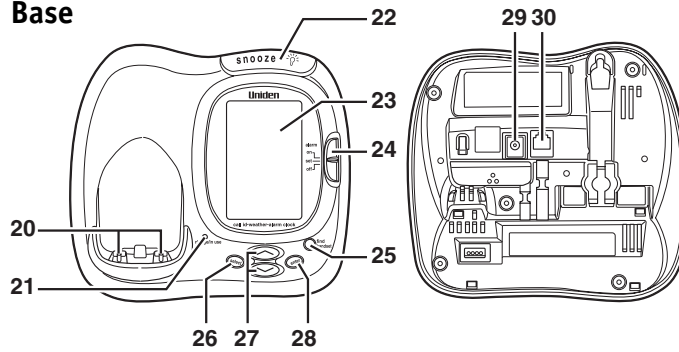

- 20. Base charging contacts
- 21. charge/in use and VMWI (Voice Mail Waiting Indicator) LED
- 22. Snooze button (page 18)
- 23. LCD display
- 24. alarm switch (page 17)
- 25. find handset key (pages 42 and 44)
- 26. select key (page 14)
- 27. ▲ or ▼ key (page 14, page 17)
- 28. enter key (page 14)
- 29. DC IN 9V jack
- 30. Telephone line jack

Outside unit

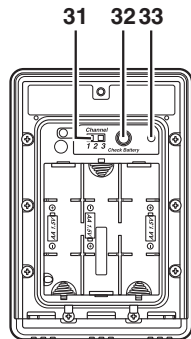

(Inside the **outside unit** compartment)

- 31. Channel switch (page 10)
- 32. Check Battery button
- 33. battery check LED

www.uniden.com

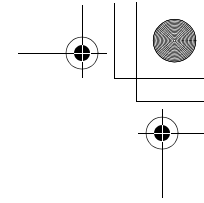
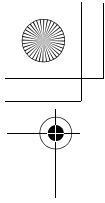

Terms Used in this Manual

- **Standby Mode** - The handset may be sitting in or off the base, but is NOT in use. The *talk/flash* key has not been pressed and there is no dial tone.
- **Talk Mode** - The handset is off the base and the *talk/flash* key has been pressed, enabling a dial tone.
- **CID** - Caller ID
- **CIDCW** - Caller ID on Call Waiting
- **Outdoor sensor** - The outdoor sensor senses the temperature and humidity and sends the received data to the base.

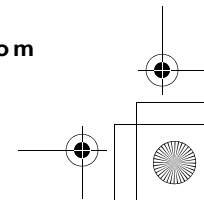
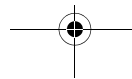
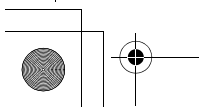
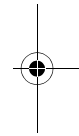
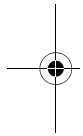

Installing the Phone and Outdoor Sensor

Do the following steps:

- A. Choose the Best Location (Base and Handset)
- B. Install the Rechargeable Battery Pack into the Handset
- C. Connect the Base, Set up the Outdoor sensor and Charge the Handset
- D. Wall Mounting the Outdoor sensor
- E. Mount the Base Unit on a Wall

A. Choose the Best Location (Base and Handset)

When choosing a location for your new phone, here are some important guidelines you should consider:

Avoid heat sources, such as radiators, air ducts, and sunlight

Avoid television sets and other electronic equipment

Choose a central location

Avoid noise sources such as a window by a street with heavy traffic

Avoid microwave ovens

Avoid excessive moisture, extremely low temperatures, dust, mechanical vibration, or shock

Avoid personal computers

Avoid other cordless telephones

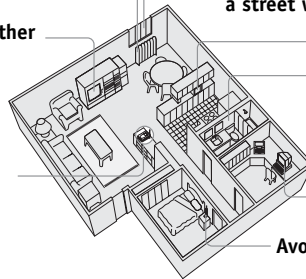

www.uniden.com



If your home has specially wired alarm equipment connected to the telephone line, be sure that installing the system does not disable your alarm equipment.

If you have questions about what will disable your alarm equipment, contact your telephone company or a qualified installer.

GETTING STARTED

GETTING STARTED [6]

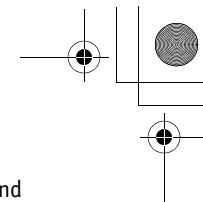
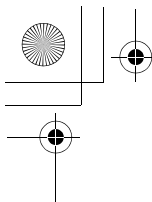

- Depending on the base location, there is any possibility that the correct temperature and humidity can't be displayed.
- Do not place any object around the base.
- The base should be placed on a location with proper ventilation.
- The location should be close to both a phone jack and a continuous power outlet (one which is not connected to a switch).
- The base and handset should be kept away from sources of electrical noise such as motors, microwave ovens, and fluorescent lighting.
- The base can be placed on a desk, tabletop, or mounted on a standard wall plate.

(Outdoor sensor)

The outdoor sensor senses the temperature and humidity and sends the received data to the base.

If you have a thermometer shelter, set up the outdoor sensor in it. If not, follow the guidelines below when choosing a location for the outdoor sensor:

- Avoid heat sources and direct sunlight.
- Set up the outdoor sensor at least 60 inches from the ground.
- Set up the outdoor sensor where it will receive proper ventilation.
~~("X" inches below, and "X" inches to each side.)~~
- Do not place the outdoor sensor where it will be exposed to rain or snow.

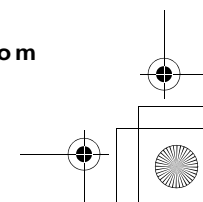
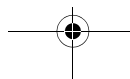
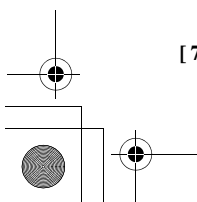
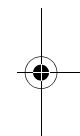
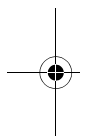

B. Install the Rechargeable Battery Pack into the Handset

The handset is powered by a rechargeable battery pack. The battery recharges automatically when the handset is placed in the base unit.

- 1) Press down on the handset battery case cover (use the finger indentation for a better grip) and slide the cover downward to remove.
- 2) Plug the battery pack connector (red & black wires) into the jack inside the battery compartment. (The connector notches fit into the grooves of the jack only one way.) Match the wire colors to the polarity label in the battery compartment, connect the battery and listen for a click to insure connection.
- 3) Make sure you have a good connection by slightly pulling on the battery wires. If the connection is secure, the battery jack will remain in place.
- 4) Place the battery case cover back in the handset by sliding it upwards until it clicks into place.

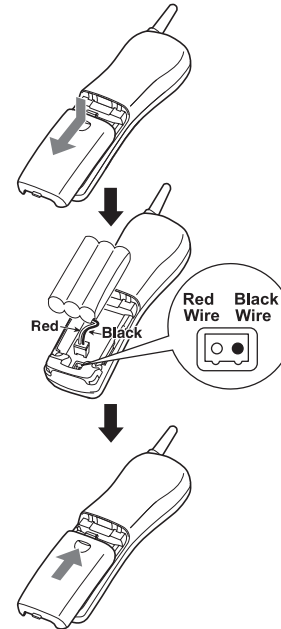

- Use only the Uniden (BT-905) rechargeable battery pack supplied with your cordless telephone.
- Replacement batteries are also available through the Uniden Parts Department at (800) 554-3988, Monday through Friday from 8:00 a.m. to 5:00 p.m. or online at www.uniden.com

www.uniden.com

GETTING STARTED [8]

GETTING STARTED



- Connect the AC adapter to a continuous power supply.
- Place the base unit close to the AC outlet to avoid long extension cords.
- **Use only the supplied AD-314 AC adapter. Do not use any other AC adapter.**

C. Connect the Base, Set up the Outdoor sensor and Charge the Hand-set

- 1) Connect the AC adapter to the **DC IN 9V** jack and to standard 120V AC wall outlet.



The base can't receive the channel data from the outdoor sensor only for the fixed time after connecting the AC adapter. As soon as the AC adapter is connected, the Alkaline batteries should be installed into the outdoor sensor.

- 2) Take off the knob on the back of the outdoor sensor with a screwdriver or a coin. Remove the cover.

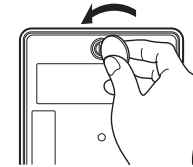
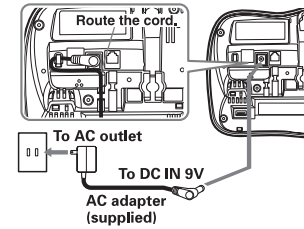

- 3) Install the Alkaline batteries into the battery compartment observing the correct polarity. Make sure the outdoor temperature and humidity appear on the base display within two or three minutes. If the outdoor temperature and humidity don't appear, switch the **Channel** another channel and remove the batteries. Install the batteries again.
- 4) Replace the cover and tighten the knob with a screwdriver or a coin.
- 5) Place the handset in the base unit with the keypad facing forward. Set up the outdoor sensor according to page 7.
- 6) Make sure the **charge/in use** LED illuminates. If the LED does not illuminate, check to see that the AC adapter is plugged in and the handset makes good contact with the base charging contacts. Charge your handset at least 15-20 hours before plugging into the phone line.
- 7) Once the handset battery pack is fully charged, connect the telephone line cord to the **TEL LINE** jack and a telephone outlet. If your telephone outlet isn't modular, contact your telephone company for assistance.

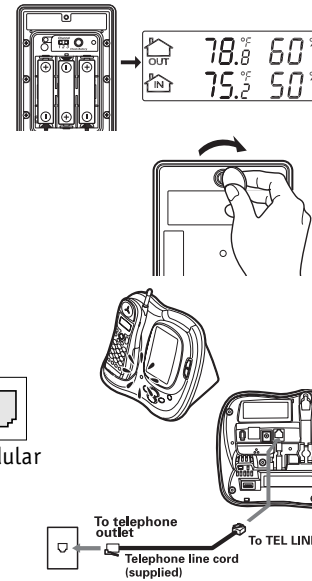

- Use only the Alkaline batteries supplied with your outdoor sensor.
- The base LCD will blink and prompt you to set the day and time. See "Setting the Time" on page 14 for the instructions on how to set the day and time.
- Once the outdoor temperature and humidity appear on the base display, do not change the channel unless you replace the batteries.
- Do not place the power cord where it creates a trip hazard or where it could become chafed and create a fire or electrical hazard.

www.uniden.com

GETTING STARTED [10]

GETTING STARTED

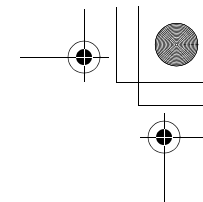
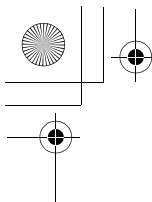

D. Wall Mounting the Outdoor sensor

Be sure to mount the outdoor sensor on a wall of outside your house. The outdoor sensor may not receive the outdoor temperature and humidity without appropriately mounting. The followings are cautions you should consider when mounting the outdoor sensor.

- Avoid electrical cables, pipes, or other items behind the mounting location that could cause a hazard when inserting screws into the wall.
- Make sure the wall material is capable of supporting the weight of the outdoor sensor.
- Use # 10 screws (minimum length of 1-3/8 inches) with anchoring devices suitable for the wall material where the wall mount holder unit will be placed.

1) Thread a screw through two kinds of washers in accordance with the order as shown.

2) Insert the screw with the two washers into the wall with a little looseness to fix the upper hole of the wall mount holder as shown.

3) Thread the other screw through two kinds of washers with the same order in step 1, and then insert it into the lower hole of the wall mount holder as shown.

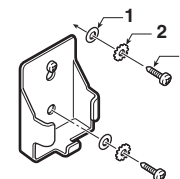

4) Tighten both upper and lower screws using a screwdriver.

5) Insert the outdoor sensor in the wall mount holder.

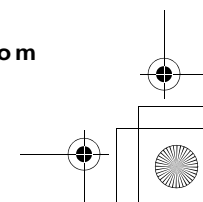
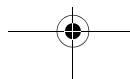
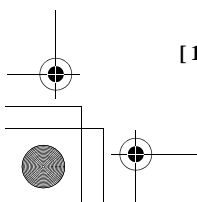
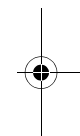
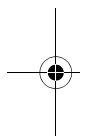

E. Mount the Base Unit on a Wall 1

Standard wall plate mounting

This phone can be mounted on any standard wall plate.

- 1) Plug the AC adapter to the **DC IN 9V** jack.
- 2) Route the AC adapter cord through the molded wiring channel as shown.
- 3) Plug the AC adapter into a standard 120V AC wall outlet.
- 4) Plug the telephone line cord into the **TEL LINE** jack. Route the cord through the molded wiring channel as shown.
- 5) Plug the telephone line cord into the telephone outlet.
- 6) Align the mounting slots on the base with the mounting posts on the wall. Then push in and down until the phone is firmly seated.

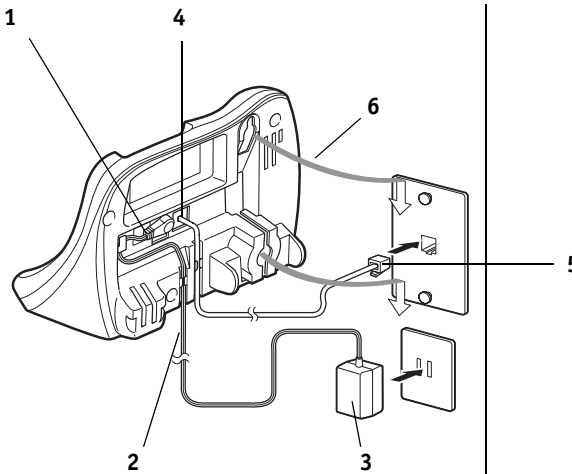

www.uniden.com

GETTING STARTED [12]

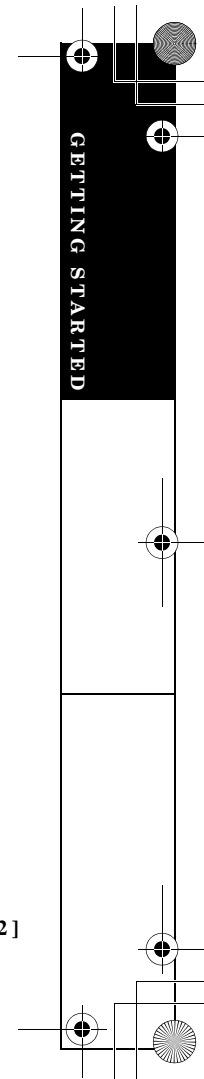

Direct wall mounting

If you don't have a standard wall plate, you can mount your phone directly to the wall. Before doing this, consider the following:

- Avoid electrical cables, pipes, or other items behind the mounting location that could cause a hazard when inserting screws into the wall.
- Try to mount your phone within 5 feet of a working phone jack to avoid excessive cord lengths.
- Make sure the wall material is capable of supporting the weight of the base and handset.
- Use #10 screws (minimum length of 1-3/8 inches) with anchoring devices suitable for the wall material where the base unit will be placed.

- 1) Insert two mounting screws into the wall, (with their appropriate anchoring device), 3-15/16 inches apart. Allow about 1/8 of an inch between the wall and screw heads for mounting the phone.
- 2) Refer to steps 1 through 6 on page 12 to mount the telephone.

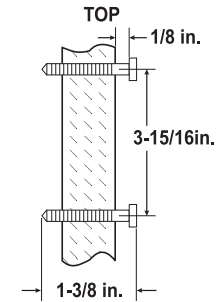

Weather Menu Options

To set the following four options, you must enter the base setup menu mode.

To scroll through the menu options, repeatedly press the **select** key in standby mode. The system returns to standby after the each last menu option.

- If any of the following occurs during menu setup, you will have to start over with the procedure you were performing.
 - Caller ID message is received
 - The **alarm** switch is changed to "**set.**"
 - Two minutes elapse without a key press
 - The AC power is off
- If the alarm setting is "**on**" and the time you have set comes, the alarm will ring.

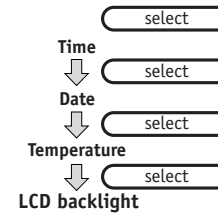

A. Set the Time

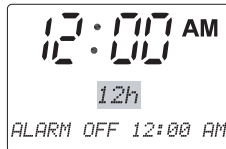

- 1) Press the **select** key on the base once.
- 2) Use the **^** or **v** key to select 12-hour (**12h**) or 24-hour (**24h**) time display, and then press the **enter** key.

www.uniden.com

GETTING STARTED [14]

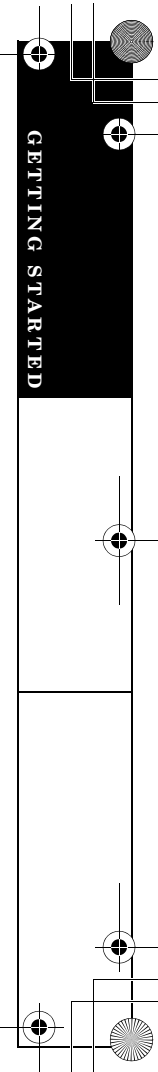



Press and hold the **^** or **v** key to scroll quickly through the numbers on the display.

- 3) Use the **^** or **v** key to set the hour (*1-12*) for 12-hour style or (*0-23*) for 24-hour style, and then press the **enter** key.
- 4) Use the **^** or **v** key to set the minute (*00-59*), and then press the **enter** key.
- 5) If you select *12h* in Step 2, you need to select **AM** or **PM**. Use the **^** or **v** key to choose **AM** or **PM**, and then press the **enter** key. The setting is complete; the phone returns to standby mode.



Press and hold the **^** or **v** key to scroll quickly through the numbers for hour and minute on the display.

B. Set the Date

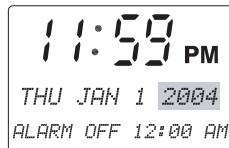

- 1) Press the **select** key on the base twice.
- 2) Use the **^** or **v** key to select the year (*2004-2030*) and then press the **enter** key.
- 3) Use the **^** or **v** key to set the month, and then press the **enter** key.
- 4) Use the **^** or **v** key to set the day (*1-31*), and then press the **enter** key. The setting is complete; the phone returns to standby mode.



- Once a data is entered, the day of the week, Tide and Moon Phase change automatically.
- Press and hold the **^** or **v** key to scroll quickly through the display.

C. Set the Temperature

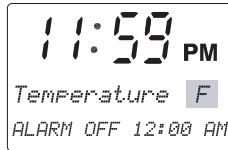

- 1) Press the **select** key on the base three times.
Use the **^** or **v** key to choose *Temperature °F* or *Temperature °C* and then press the **enter** key. The setting is complete, and the phone returns to standby mode.

D. Set Display Backlight

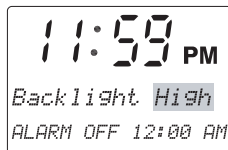

- 1) Press the **select** key on the base four times.
- 2) Use the **^** or **v** key to choose *Backlight High* or *Backlight Low* and then press the **enter** key. The setting is complete, and the phone returns to standby mode.

www.uniden.com

GETTING STARTED [16]

GETTING STARTED

note

- The alarm operation is completely independent from the handset operation. The alarm tone continues to ring despite any handset operation.
- If an incoming call is received while you are setting the alarm time, the display shows the Caller ID message, then the phone returns to the alarm setting mode.

Set the Alarm Clock

Set the Alarm

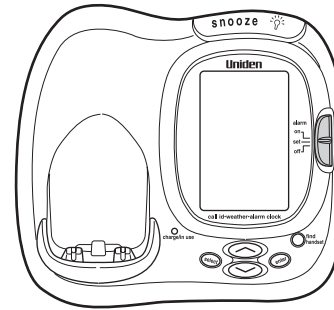
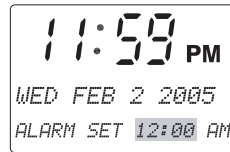

- 1) Slide the **alarm** switch on the base to "**set**" (the **alarm** switch is on the right of the display.) The current alarm time on the display blinks, and **ALARM SET** appears on the display.
- 2) Use the **▲** or **▼** key to select the time you want the alarm to go off.
- 3) Slide the alarm switch on the base to **on**, and then **ALARM ON** and setting time appears on the display.

Turning off the Alarm

When the alarm is "set" and the selected time comes, the alarm tone rings for ten minutes. To turn off the alarm tone, slide the **alarm** switch to "off."

Snooze Feature

To stop the alarm tone temporarily, press the **snooze** button. The alarm tone will ring again in five minutes.

Adjust the Base LCD Contrast



With the phone in standby mode, Use the **▲** or **▼** to select *Contrast High* or *Contrast Low*.

www.uniden.com



If the alarm is reset while the snooze feature is on, the phone returns to standby mode.

GETTING STARTED [18]

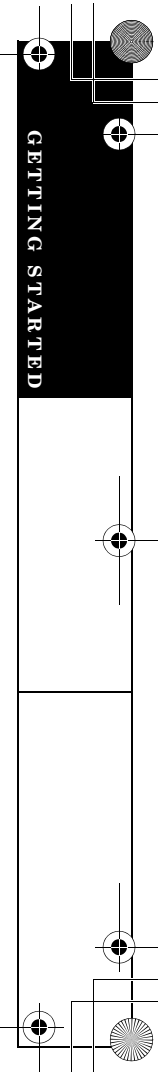

Basic Phone Setup

There are five basic options that you will need to set up: AutoTalk, CIDCW (Caller ID on Call Waiting), Area Code, Dial Mode and Language.

Activating AutoTalk (on/off)

AutoTalk allows you to answer the phone simply by removing the handset from the base. You do not have to press any keys.

- 1) When the phone is in standby mode, press and hold the **Call id/ menu** key. The following screen appears.
- 2) Press the **select** key to turn AutoTalk on.
- 3) Press the **end** key to complete the setting. The handset returns to standby mode.

```
▶Auto Talk :Off
CIDCW      :On
Area Code  :
```

Activating CIDCW (Caller ID on Call Waiting)

Caller ID allows you to see the name and number of the calling party before you answer the phone. Caller ID on Call Waiting (CIDCW) lets you see the name and number of a call that comes in when you are on the line.

You must subscribe to Caller ID service through your local telephone provider to use this feature.

- 1) When the phone is in standby mode, press and hold the **Call id/ menu** key. The following screen appears.

```
▶Auto Talk :Off
CIDCW      :On
Area Code  :
```

2) Press the **▼/vol/▲** key to select CIDCW.

```
Auto Talk :Off
▶CIDCW   :On
Area Code :
```

3) Press the **select** key to toggle and turn on Caller ID on Call Waiting.

4) Press the **end** key and return the handset to the base unit to complete the setting. The handset returns to standby mode.

Entering Your Area Code

If you enter a 3-digit area code number in the Area Code option, your local area code does not appear in Caller ID messages. Do not program this option if your calling area requires 10-digit dialing. When reviewing Caller ID messages, you will see only the local seven digit number. For calls received from outside your local area code, you will see a full 10-digit number.

1) When the phone is in standby mode, press and hold the **Call id/menu** key. The following screen appears.

```
▶Auto Talk :Off
CIDCW     :On
Area Code :
```

2) Press the **▼/vol/▲** key twice to select Area Code.

```
Auto Talk :Off
CIDCW     :On
▶Area Code :
```

3) Press the **select** key. If an area code was already stored, the phone will display it.

4) Use the number keys **(0 - 9)** to enter the 3-digit area code. If you make an error or delete the current area code, use the **delete/channel** key to backspace.

```
Auto Talk :Off
CIDCW     :On
Area Code :■
```

5) Press the **select** key. A confirmation tone sounds.

www.uniden.com

GETTING STARTED [20]

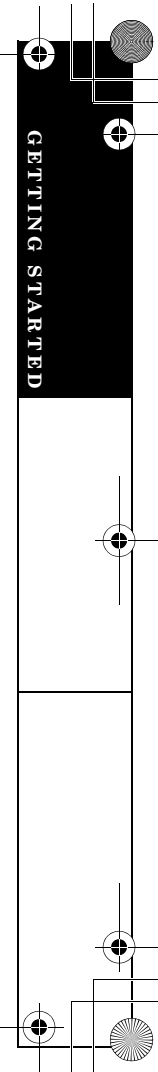

note

- If you are not sure of your dialing system, make a trial call. If the call connects, leave the setting as is. Otherwise, set for pulse dialing.
- If your phone system requires pulse dialing and you need to send DTMF tones during a call, you can temporarily switch over to tone dialing. (Refer to "Tone Dialing Switch-over" on page 41.)

6) Press the **end** key to complete the setting. The handset returns to standby mode.

Choosing the Dialing Mode (pulse vs. tone)

Most phone systems use tone dialing. However some phone systems (such as in rural areas) still use pulse dialing. Your Uniden phone supports both tone and pulse dialing. The default setting is tone dialing. If your phone system uses pulse dialing, follow the steps below to change the dialing mode:

- 1) When the phone is in standby mode, press and hold the **Call id/menu** key. The following screen appears.
- 2) Press the **∇/vol/▲** key three times to select Dial.
- 3) Press the **select** key to set the phone to pulse dialing.
- 4) Press the **end** key to complete the setting. The handset returns to standby mode.

```
▶Auto Talk :Off
CIDCW :On
Area Code :
```

```
CIDCW :On
Area Code :
▶Dial :Pulse
```

Setting the Language (English, French or Spanish)

There are three languages to choose from: English, French and Spanish.

- 1) When the phone is in standby mode, press and hold the **Call id/menu** key. The following screen appears.
- 2) Press the **∇/vol/▲** key four times to select Language.

```
▶Auto Talk :Off
CIDCW :On
Area Code :
```

- 3) Press the **select** key to select Eng. (English), Fr. (French) or Esp (Spanish).
- 4) Press the **end** key to complete the setting. The handset returns to standby mode.

```
Area Code :  
Dial      :Tone  
Language  :Eng
```

Selecting the Ring Tone and Volume

Your phone has five different ringer tone/volume combinations you can choose from.

- 1) With the phone in standby mode, press the **^/vol/▲** or **∇/vol/▼** key.
- 2) The phone will sound the different ring tones at different volumes.
- 3) When the phone sounds the ring tone and volume you wish to use, press the **end** key.

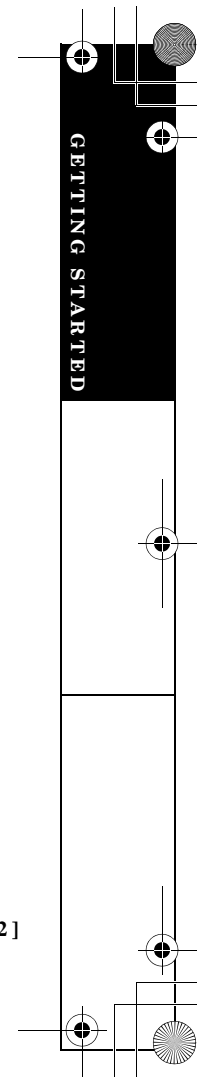

note

When editing the speed dial memory, you must press a key within 30 seconds or the phone will return to standby mode. If you return the handset to the base, the phone will return to standby mode also.

Programming Memory Locations/Caller ID/Speed Dialing

The speed dial memory allows you to store up to 10 names and numbers in the handset. You can dial these numbers with just a few key presses.

The speed dial memory is not limited to phone numbers. You can store any number (up to 20 digits) that you need to enter once your call connects. This is referred to as Chain Dialing. For example, you can save your bank account number to speed dial memory. When you call your bank's telephone teller service and are prompted to enter your account number, simply press the **mem** key and the speed dial number where you stored your account number. Then press the **select** key.

Storing Names and Numbers in Speed Dial Memory Entering letters and special characters

- 1) With the phone in standby mode, press the **mem** key.
- 2) Enter **0-9** to select the speed dial number where you would like to store this entry. You can also scroll through the list with the **▲/vol/▲** and **▼/vol/▲** keys. Press the **select** key twice.
- 3) **Store Name** appears and a cursor flashes indicating that the display is ready for the name to be entered.

```
Select Memory
01*
02 JOHN DOE
```

```
Store Name
█
```

If the selected speed dial number is already assigned, the Edit screen appears. You can select **Edit** to edit this entry, select **Delete** to erase this entry, or select **Go Back** to choose another speed dial number.

```
▶Edit Memory01
Delete Memory01
Go Back
```

- 4) Enter a name according to the instructions below, then press the **select** key. If no name is required, go to "Entering phone numbers" on page 25.
- The name can be up to 13 characters.
 - Use the **#/↓** and ***/tone/↑** keys to move the cursor to the desired location.
 - Use the **delete/channel** key to delete characters as needed.
 - Press and hold the **delete/channel** key to delete all the characters.

Refer to the letters on the number keys to select the desired characters. With each press of a numeric key, the displayed character appears in the following order: Upper case letters first, lower case letters next and finally the number corresponding to the key.

If you make a mistake while entering a name

Use the ***/tone/↑** or **#/↓** key to move the cursor to the incorrect character. Press the **delete/channel** key to erase the wrong character. Then enter the correct character. To delete all characters, press and hold the **delete/channel** key.



If the next character uses the same number key, you must press the **#/↓** key to move the cursor over. Otherwise the next time you press the number key, it changes the character that was previously set.

GETTING STARTED

For example, to enter **Movies**.

- 1) Press **6**. Then press the **#/↓** key to move the cursor to the right.
- 2) Press **6** six times.
- 3) Press **8** six times.
- 4) Press **4** six times.
- 5) Press **3** five times.
- 6) Press **7** eight times.

keys	Number of times key is pressed								
	1	2	3	4	5	6	7	8	9
1	1								
2abc	A	B	C	a	b	c	2		
3def	D	E	F	d	e	f	3		
4ghi	G	H	I	g	h	i	4		
5jkl	J	K	L	j	k	l	5		
6mno	M	N	O	m	n	o	6		
7pqrs	P	Q	R	S	P	q	r	s	7
8tuv	T	U	V	t	u	v	8		
9wxyz	W	X	Y	Z	w	x	y	z	9
0*#	*	#	-	&	()	(blank)	0	

Entering phone numbers

- 1) **Store Number** is displayed. The cursor flashes indicating that the display is ready for the number to be entered.

Store Number

- 2) Use the keypad to enter the phone number; each number can be up to 20 digits.

Store Number
8007303456

If you need the phone to pause during the dialing sequence, press the **redial/pause** key to insert a two-second delay between the numbers. You can enter multiple pauses to increase the delay. Each pause counts as a digit. The display shows a P for every pause.

note When storing numbers into memory, if the handset is idle (i.e., no key is pressed) for more than 30 seconds, it will beep rapidly, and the phone will return to standby mode.

- 3) Press the **mem** key. You will hear a confirmation tone, and the following screen appears.
Memory storage is complete.
After about 2 seconds, the following screen displays all the speed dial memory entries.

```
Memory01 Stored
```

```
01 Movies  
02 JOHN DOE  
03 MOM AND DAD
```

- 4) Press the **end** key to exit memory setup mode. The phone returns to standby.

Storing Caller ID Messages in Speed Memory Locations

Messages (Caller ID names/numbers) shown in the Caller ID list can be stored in memory dialing. For instructions on viewing the Caller ID Message list, see page 28.

- 1) Press the **Call id/menu** key. Select the phone number to be stored from the Caller ID list by pressing the **^/vol/▲** or **∇/vol/▼** key.
- 2) Press the **mem** key.
- 3) Enter a number (**0 - 9**) or press the **^/vol/▲** or **∇/vol/▼** key to select the memory location to be stored.
- 4) Press the **select** key. You hear a confirmation tone, and the number is stored in memory. The display returns to the Caller ID list.

```
5/17 12:30PM  
Jane Smith  
214-555-1234
```

```
Select Memory  
01  
02 JOHN DOE
```

```
5/17 12:30PM  
Jane Smith  
214-555-1234
```

```
Replace Memory?  
Yes  
No
```

note If a message has already been stored in the selected memory number location, a confirmation screen is displayed. Press the **^/vol/▲** key to select Yes. Press the **select** key to overwrite. The display returns to the Caller ID list.

www.uniden.com



You cannot store a Caller ID message if no phone number appears in the message.

GETTING STARTED

GETTING STARTED [26]



- If you answer a call before the Caller ID message is received (for example, before the second ring), the Caller ID message will not appear.
- When the call is received via a telephone company that does not offer Caller ID service, the caller's phone number and name do not appear. (This includes international calls.)
- When the call is via a private branch exchange (PBX), the caller's phone number and name may not appear.

Caller ID and CIDCW (Caller ID on Call Waiting)

You must subscribe to Caller ID service through your local telephone provider to use this feature. When the telephone rings, the Caller ID feature allows you to view the caller's name, phone number, date and time of call (The date and time display only on the handset). The Caller ID list stores information for up to 30 incoming calls - even unanswered calls. With CIDCW (Caller ID on Call Waiting), you will hear a Call Waiting tone while you are on a call, and the Caller ID data is displayed. To accept the waiting call, press the **talk/flash** key (see page 42.)

Additionally, you can dial a number stored in the Caller ID list or save data to your Memory dial list (see page 26).

When the Telephone Rings

When the Caller ID message is received, the display shows the caller's phone number. The handset display shows the date and time also. The incoming call information is stored in the handset Caller ID record. If the Caller ID service includes the caller's name, the caller's name appears on the display (up to 15 letters).

(Base)

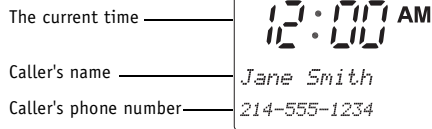

(Handset)

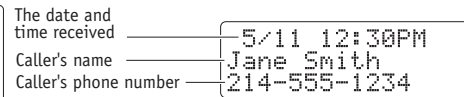

You may receive any one of the following messages:

When invalid data is received Incomplete Data

When a private name is received Private Name

When a private number is received Private Number
When a unknown name is received Unknown Name
When a unknown number is received Unknown Number

note Data errors appear as "■".

Viewing the Caller ID Message List

- 1) With the phone in standby mode, press the **Call id/menu** key on the handset.
The summary screen appears. The screen shows the number of new messages and total messages.
- 2) Press the **▼/vol/▲** key to view the messages from the most recent to the oldest. Press the **▲/vol/▲** key to view messages from the oldest to the most recent.
- 3) Press the **end** key to return to standby mode.

```
Caller ID  
New :01  
Total:02
```

```
5/17 12:30PM  
Jane Smith  
214-555-1234
```



- In Caller ID operation, if no key is pressed for more than 30 seconds, an error tone sounds and the telephone returns to standby mode.
- Each message can be up to 15 characters for the name and 15 digits for the phone number.
- The number of calls from the same Caller ID appears next to the received time. Once you view the new message, the number will be cleared and disappear.

note

- While using the Delete All? or Delete Message? screen, if no key is pressed for more than 30 seconds, an error tone sounds, and the handset returns to standby mode.
- If you get an incoming call or page, the deleting operation is canceled, and you can answer the call or page.

Deleting Information from the Caller ID List

The cordless phone stores up to 30 Caller ID names/numbers. If the phone receives the 31st Caller ID, the oldest one in the list is automatically deleted. Caller ID data can also be deleted manually.

Deleting a Caller ID message

- 1) With the phone in standby mode, press the **call id/menu** key on the handset. Find the message to be deleted from the Caller ID list by pressing the **^/vol/▲** or **∇/vol/▼** key.

```
5/17 12:30PM  
Jane Smith  
214-555-1234
```

- 2) Press the **delete/channel** key.

```
Delete Message?  
▶ Yes  
No
```

- 3) Press the **^/vol/▲** or **∇/vol/▼** key to select **Yes**, and then press the **select** key.

Deleting all Caller ID names/numbers

- 1) With the phone in standby mode, press the **Call id/menu** key.

```
Caller ID  
New :01  
Total:02
```

- 2) Press the **delete/channel** key.

```
Caller ID  
Total:00
```

- 3) Press the **^/vol/▲** or **∇/vol/▼** key to select **Yes**, and then press the **select** key.
You hear a confirmation tone and all stored Caller ID messages are deleted.

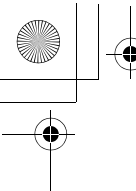

Using the Weather Station

Reading the Weather Display at the Base

A. The Weather Forecast

The Weather Forecast system displays the weather type forecasted for the next 12 hours to 24 hours. There are three types of Weather: Sunny, Cloudy or Rainy. These weather types are displayed on the base with the icons shown below:

These description will be moved before the forecast marks(Sunny, Cloudy, Rainy) on the next page.

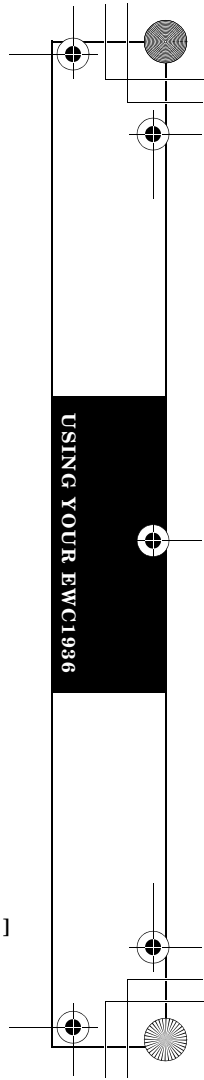
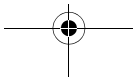
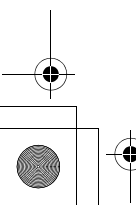
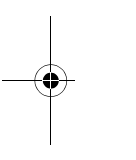

This illustration will be moved to previous page.

Example of the standby mode display

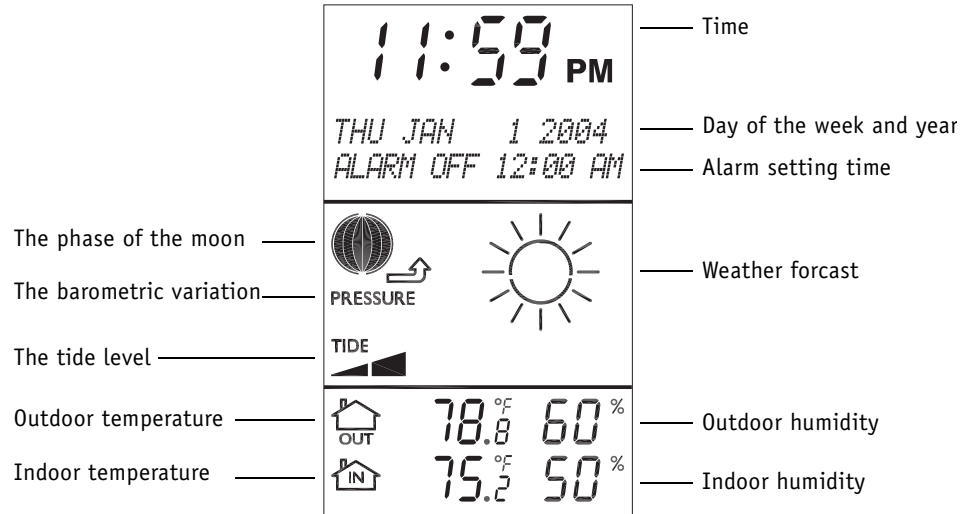

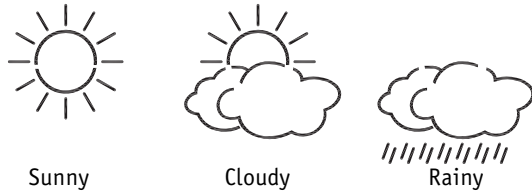

B. The Barometric Variation

The barometric variation system displays the current changes in barometric pressure using the icons shown below:

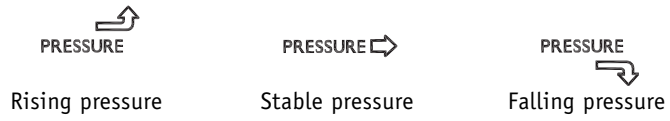

C. The Phases of the Moon

The phases of the moon system displays the current phase of the moon using the 12 icons shown below. The phases of the moon displayed depend on the day and time set on the base; if an incorrect day or time is set on the base, the phases of the moon may not display correctly.

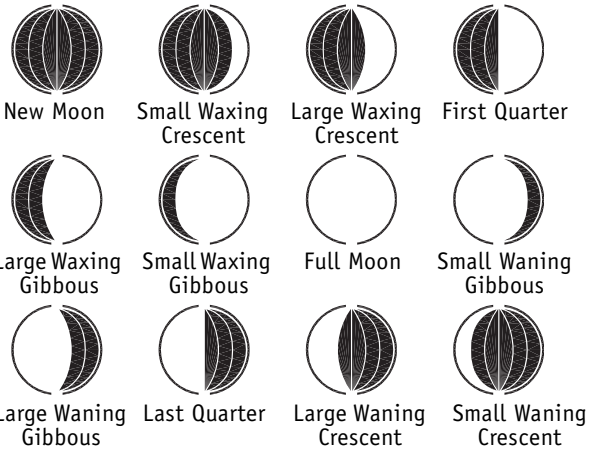

D. The Tide Level

The tide level system displays the current tide level using the three icons shown below. The tide level displayed depends on the day and time set on the base; if an incorrect day or time is set on the base, the tide level may not display correctly.



E. Indoor and Outdoor Temperature and /Humidity

The weather system displays temperature and humidity for both the indoors and the outdoors. You can check the temperature/humidity both for indoor and outdoor on the display. The outdoor temperature and humidity data can be received from the Outdoor sensor.





- You can change the temperature format from to °F or °C. For details, see "Set the temperature format" on page 16.
- When the base can't receive the data from the Outdoor sensor for ten minutes, --.- or -- appears on the base display. Check the status of the batteries in the Outdoor sensor. Replace the batteries if necessary. (See "Battery replacement and handling (Outdoor sensor)" on page 46.)

note

- If the handset can't receive any data for five seconds, an error tone sounds and the handset returns to standby mode.
- If the base can't receive weather data from the outdoor sensor, appears on the handset display.
- You can receive the weather data even while in talk mode.





Reading the Weather Data from the Handset

You can check the temperature, humidity and weather forecast from the handset.

- 1) With phone in standby or talk mode, press the  key on the handset. The display flashes *Connecting*; the data from the base appears on the handset display for ten seconds.
- 2) To return to standby mode or talk mode, press the  key.

```
Outdoor:78.8F 73%  
Indoor :75.2F 48%  
Forecast:Cloudy
```

Making Calls from Speed Dial Memory

- 1) Press the **mem** key. The handset displays your programmed speed dial number.
- 2) Enter the number (**0 - 9**), or press the /vol/ or /vol/ key to select the speed dial number you would like to dial.
- 3) Press the **talk/flash** key. *Talk* and the number selected appear on the display. Then the displayed number is dialed.

```
Select Memory  
01:Movies  
02 JOHN DOE
```

```
Talk  
8007303456
```

To cancel speed dialing

Press the **end** key to cancel speed dialing. The handset returns to standby mode. Also, if the handset is idle (e.g., no key is pressed) for 30 seconds, the phone returns to standby mode.

Using Your Phone

Making and Receiving Calls

Making a call

- 1) Remove the handset from the base.
- 2) Press the **talk/flash** key.
- 3) Listen for the dial tone.
- 4) Dial the number.

OR

- 1) Remove the handset from the base.
- 2) Dial the number.
- 3) Press the **talk/flash** key.

Receiving a call

- 1) Remove the handset from the base. (If AutoTalk is on, the phone will automatically answer the call when you pick it up.)
 - 2) Press the **talk/flash** key.
- OR
- 1) If the handset is off the base, press the **talk/flash** key or any number key. (AutoTalk is on.)

Hanging up

Press the **end** key or return the handset to the base.

www.uniden.com



Refer to page 19
"Basic Phone Setup" to
turn on the AutoTalk
feature if desired.

USING YOUR EWC1936 [36]

Redialing the last dialed number

- 1) Remove the handset from the base.
 - 2) Press the **talk/flash** key.
 - 3) Listen for the dial tone.
 - 4) Press the **redial/pause** key.
- OR
- 1) Remove the handset from the base.
 - 2) Press the **redial/pause** key.
 - 3) Press the **talk/flash** key.

Making Calls from Speed Dial Memory

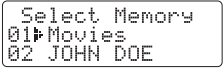
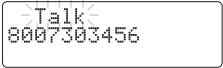
- 1) Press the **mem** key. The handset displays your programmed speed dial number.
- 2) Enter the number (**0 - 9**), or press the **^/vol/▲** or **∇/vol/△** key to select the speed dial number you would like to dial.
- 3) Press the **talk/flash** key. Talk and the number selected appear on the display. Then the displayed number is dialed.

To cancel speed dialing

Press the **end** key to cancel speed dialing. The handset returns to standby mode. Also, if the handset is idle (e.g., no key is pressed) for 30 seconds, the phone returns to standby mode.

Making a Call from the Caller ID List

You can place a call from the Caller ID list.

- 1) With the phone is standby mode, press the **call id/menu** key on the handset. Select the phone number that you want to dial by pressing the **^/vol/▲** or **∇/vol/△** key.
- 2) To have the phone dial a "1" before the displayed Caller ID number to set a long distance call, press **1**. To have the phone dial the stored area code before the displayed Caller ID number, press **3**.
- 3) Press the **talk/flash** key. The displayed phone number dials automatically.

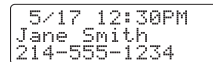

5/17 12:30PM
Jane Smith
214-555-1234



You cannot make a call from the Caller ID list if your cordless phone is connected to a private branch exchange (PBX).

Adjusting the Earpiece Volume

To change the earpiece volume, press the **^/vol/▲** or **∇/vol/△** key during a call.

Temporarily Mute Ringer

If the handset is off the base while an incoming call is ringing, simply press the **end** key to temporarily mute the incoming ring. The ringer will sound with the next incoming call.



www.uniden.com

USING YOUR EWC1936 [38]

USING YOUR EWC1936

Using a Headset

Headset installation

Your phone may be used with an optional headset, the Uniden HS910. Your phone is ready for hands-free conversations. (Headset may be purchased by calling the Uniden Parts Department or visiting the web site. See page 48.)

- 1) Place the headset on your head so the against the speaker covers your ear. The other end of the headset should rest comfortably against the side of your head above your ear. Do not place the end of the headband against the other ear.
- 2) The microphone arm swings over the top of the headset so you can wear the headset on the left or right ear. Position the flexible arm so the microphone is about 2 inches away from your mouth.
- 3) To use the headset, plug the headset plug into the headset jack.



Making calls with the headset

- 1) Remove the handset from the base and place the headset on your head with the earpiece over either ear.
- 2) Press the *talk/flash* key.
- 3) Listen for the dial tone from the headset.
- 4) Dial the number.

OR

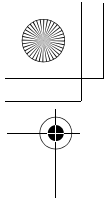

- 1) Remove the handset from the base and place the headset on your head with the earpiece over either ear.
- 2) Dial the number.

Receiving calls with the headset

- 1) Place the headset on your head with the earpiece over either ear and remove the handset from the base. (If AutoTalk is on, the phone will automatically answer the call when you pick it up.)
- 2) Press the *talk/flash* key.

OR

- 1) If the handset is off the base, place the headset on your head with the earpiece over either ear.
- 2) Press the *talk/flash* key or any number key. (AutoTalk is on.)

Installing the Beltclip

To attach the beltclip

Insert the beltclip into the holes on each side of the handset. Press down until it clicks.

To remove the beltclip

Pull both sides of the beltclip to release the tabs from the holes.

www.uniden.com

USING YOUR EWC1936 [40]

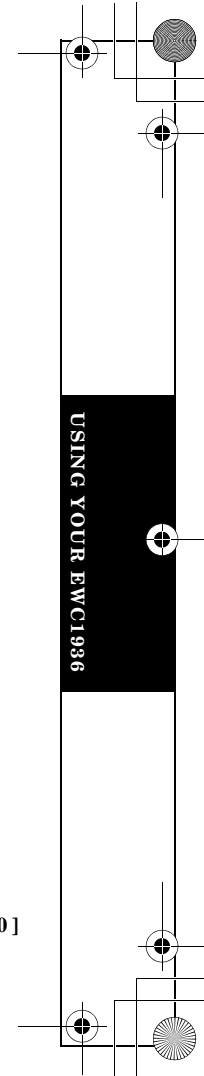
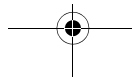
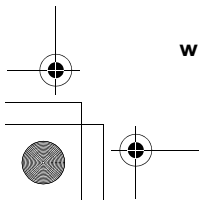



The **UltraClear Plus™** true compander circuitry virtually eliminates background noise. This innovative technology, together with 20 different channels, provides you with the best possible reception during all your conversations.

Tone Dialing Switch-over

If your telephone company requires pulse dialing, you can switch-over to tone dialing after the call connects. This feature is useful when you need tone dialing to use any automated menu systems, such as telephone bank tellers, telephone prescription refills, customer support menus, etc.



If your phone is set to pulse dialing mode, make your call normally. Once your call connects, press the ***/tone/↑** key. Any digits you enter from then on will be sent as tone digits. When this particular call ends, the phone automatically returns to pulse dialing mode.

Traveling Out-of-Range

During a call, as you begin to move your handset too far from your base unit, noise increases. If you pass the range limits of the base unit, your call will terminate within five minutes.

Selecting a Different Channel

If you encounter interference while using your phone, you can manually change the phone's channel for clear operation. While using your phone, press the **delete/channel** key. Scanning appears on the display, indicating the phone is changing to another channel. For more information on interference, refer to "Precautions" on page 54.

Finding a Lost Handset

To locate the handset, press the **find handset** key on the base. The handset beeps for 60 seconds.

To cancel paging, press any key on the handset, return the handset to the base, or press the **find handset** key on the base.

Paging is canceled automatically when the phone receives an incoming call.

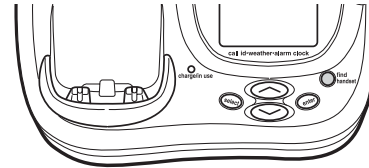

Using Call Waiting

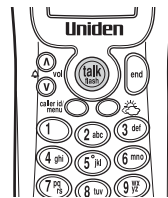

If you have Call Waiting service, you can receive calls while on the line.

- 1) If a call comes in while you are on the phone, you will hear a call waiting tone. If you have CIDCW activated, you will see the name and number of the incoming caller.
- 2) Press the **talk/flash** key to accept the waiting call. After a short pause, you will hear the new caller.
- 3) To return to the original caller, press the **talk/flash** key again.



You must subscribe through your local telephone company to receive Call Waiting service.

www.uniden.com

USING YOUR EWC1936 [42]

USING YOUR EWC1936

note

You must subscribe to voice mail service from your telephone company in order to use this feature. The voice mail company will provide you with the access number.

Voice Mail Waiting Indicator

If you subscribe to voice mail service, you can use your cordless telephone to access your voice mailbox. The *charge/in use* LED on the base of your phone flashes whenever you have messages waiting in your voice mailbox.

Just dial the access number supplied by your voice mail provider to enter your mailbox. You can program your voice mail access number to a speed dial number. If the voice mail waiting indicator remains on after you have retrieved your messages, press and hold the *find handset* key for 5 seconds. This will reset the indicator.

Changing the Digital Security Code

To protect you against misbilled calls which might result from your phone being activated by other equipment, the cordless phone provides **AutoSecure™** (which electrically locks your phone when the handset is in the base) and **Random Code™** digital security which automatically selects one of over 262,000 digital security codes for the handset and base.

If the handset battery pack is completely discharged or the battery pack is removed, the digital security code will be lost. If this happens, a new security code is set automatically the next time the battery pack is charged. In the rare situation that you suspect another cordless telephone is using the same security code, you can change the code.

- 1) Remove the handset from the base unit. Press and hold the **find handset** key on the base.
- 2) While holding the **find handset** key, place the handset in the base unit, and leave the handset in the base for more than 3 seconds. A new random security code is set.

Note on Power Sources

Low battery alert (Handset)

When the battery pack is very low and needs to be charged, the phone is programmed to eliminate functions in order to save power. If the phone is not in use, **Low Battery** appears on the LCD and none of the keys will operate. If the phone is in use, **Low Battery** flashes and the handset beeps. Complete your conversation as quickly as possible and return the handset to the base unit for charging.



Low Battery



Dial mode setting, last number dialed, names and numbers stored in memory locations and CID list are retained up to 30 minutes while you replace the battery pack.

Even when the battery pack is not being used, it will gradually discharge over a long period of time. For optimum performance, be sure to return the handset to the base unit after a telephone call.

Low battery confirmation (Outdoor sensor)

To check the battery status of the Outdoor sensor, remove the cover with a screwdriver or a coin and press the **Check Battery** button inside the battery compartment. The battery check LED on the right side of the **Check Battery** button shows the current battery status:

- The battery check LED is turned on. ↓ The battery is full.
- The battery check LED is blinking. ↓ The battery is low.
- The battery check LED is turned off. ↓ The battery is empty. Replace with new "AA" size Alkaline batteries.

[45] ADDITIONAL INFORMATION

www.uniden.com

Battery replacement and handling (Handset)

When the operating time becomes short even after a battery is recharged, please replace the battery. With normal usage, your battery should last about one year.

Please contact your place of purchase or the Uniden Parts Department for a replacement battery.

Warning: To avoid the risk of personal injury or property damage from fire or electrical shock, only use the Uniden battery model and Uniden adapter model specifically designated for this product.

Battery replacement and handling (Outdoor sensor)

When you check the Outdoor sensor's battery status and the battery check LED is off, the batteries are empty. Please replace with new "AA" size Alkaline batteries.

Power Failure

During the period that the power is off, you will not be able to make or receive calls with the telephone.

Caution

- Use only the specified Uniden battery pack (BT-905) for the handset.
- Use only "AA" size Alkaline batteries for the Outdoor sensor. To avoid risk of fire or damage to the unit, do not use other types of batteries.
- Do not remove the battery from the handset or Outdoor sensor to charge it.
- Never throw the battery into a fire, disassemble it, or heat it.
- Do not remove or damage the battery casing.

Cleaning the battery charging contacts

To maintain a good charge, clean the charging contacts on the handset once a month. Dampen a cloth with plain water. Gently rub the damp cloth over the charging contacts until all visible dirt is removed. Dry the contacts thoroughly before returning the handset to the base.

Caution

Do not use paint thinner, benzene, alcohol, or other chemical products. Doing so may discolor the surface of the telephone and damage the finish.

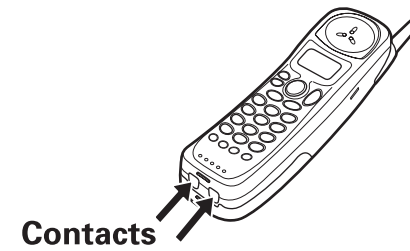

[47] ADDITIONAL INFORMATION

www.uniden.com

General Information

The phone complies with FCC Parts 15 and 68.

Operating temperature: -10°C to +50°C (+14°F to +122°F) (for Band & Handset)

Operating temperature: -20°C to +60°C (+4°F to +140°F) (for Outdoor sensor)

AC Adapter Information

AC Adapter part number: AD-314
Input Voltage: 120V AC 60Hz
Output Voltage: 9V DC 350 mA

Battery Information (for Handset)

Battery part number: BT-905(for Handset)
Capacity: 600 mAh, 3.6V

Battery Information (for Outdoor sensor)

Type: Alkaline Battery "AA" size



•To avoid damage to the phone use only Uniden AD-314 and BT-905 with your phone.

•Use only "AA" size Alkaline batteries for the outdoor unit.

•If the handset is left off of the base, the actual Talk mode duration will be reduced respective to the amount of time the handset is off the base.

Recharge your phone on a regular basis by returning the handset to the base after each phone call. When the operating time becomes short, even after the battery is recharged, please replace the battery. With normal usage, the battery should last about one year.

A replacement Uniden adapter and battery may be purchased at your local Uniden dealer or by contacting the Uniden Parts Department (800) 554-3988. Hours are from 8:00 a.m. to 5:00 p.m. Central Time, Monday through Friday. We can also be reached on the web at www.uniden.com. Specifications, features, and availability of optional accessories are all subject to change without prior notice.

www.uniden.com

ADDITIONAL INFORMATION [48]

Troubleshooting

If your phone is not performing to your expectations, please try these simple steps first.

Symptom	Suggestion
The <i>charge/in use</i> LED won't illuminate when the handset is placed in the base.	<ul style="list-style-type: none"> • Make sure the AC adapter is plugged into the base and wall outlet. • Make sure the handset is properly seated in the base. • Make sure the charging contacts on the handset are clean.
The audio sounds weak and/or scratchy.	<ul style="list-style-type: none"> • Move the handset and/or base away from metal objects or appliances and try again. • Press the <i>delete/channel</i> key in the Talk mode to help eliminate background noise. • Make sure that the handset is not too far from the base.
Can't make or receive calls.	<ul style="list-style-type: none"> • Check both ends of the telephone line cord. • Make sure the AC adapter is plugged into the base and wall outlet. • Disconnect the AC adapter for a few minutes. Then reconnect it. • Change the digital security code (see page 44). • Make sure that the handset is not too far from the base. • Check the dialing mode used by your telephone company. • Charge the handset.

Symptom	Suggestion
The handset doesn't ring or receive a page.	<ul style="list-style-type: none">• The battery pack may be weak. Charge the battery for 15-20 hours.• The handset may be too far from the base unit.• Place the base unit away from appliances or metal objects.• Change the digital security code (see page 44).• Check the battery pack to ensure there is a secure connection.• Make sure ringer volume isn't set to turned "off."• Charge the handset.
Severe noise interference.	<ul style="list-style-type: none">• Keep the handset away from microwave ovens, computers, remote control toys, wireless microphones, alarm systems, intercoms, room monitors, fluorescent lights, and electrical appliances.• Move to another location or turn off the source of interference.• Make sure that the handset is not too far from the base.
The Caller ID does not display.	<ul style="list-style-type: none">• The call was answered before the second ring.• The call was placed through a switchboard.• Charge the handset.• Your Caller ID service may not be active; contact your local telephone service provider.

Symptom	Suggestion
Voice Message Indication does not work.	<ul style="list-style-type: none">• Contact your local telephone company to make sure that your telephone receives FSK message signaling.• Reset the indicator by pressing and holding the <i>find handset</i> key for 5 seconds.
--.- or -- The outdoor temperature and humidity doesn't appear on the base display.	<ul style="list-style-type: none">• Check the battery status of the Outdoor sensor. If the battery is full, switch the <i>Channel</i> another channel and remove the batteries. Then re-install the batteries.• Check the battery status of the Outdoor sensor. If the battery is empty, remove the batteries. Then install new batteries.
If you still have a problem.	<ul style="list-style-type: none">• Call our customer hotline at 1-800-297-1023.

[51] ADDITIONAL INFORMATION

www.uniden.com

Liquid Damage

Moisture and liquid can damage your cordless phone and outdoor sensor. In case of accidental submersion, please follow these steps.

Case	Action
If the handset, base or outdoor sensor is exposed to moisture or liquid, but it only affects the exterior plastic housing.	Wipe off the liquid, and use as normal.
If moisture or liquid has entered the plastic housing (i.e., liquid can be heard in the phone or liquid has entered the handset battery compartment or vent openings on the base).	<p>Handset and Outdoor sensor:</p> <ol style="list-style-type: none"> 1.Remove the battery cover and leave it off for ventilation 2.Remove the battery pack by disconnecting 3.Leave the battery cover off and the battery pack disconnected for at least 3 days 4.Once the handset is completely dry, reconnect the battery pack and the battery cover. 5.Recharge the handset's battery pack for 20 hours before using again (only for the handset). <p>Base:</p> <ol style="list-style-type: none"> 1.Disconnect the AC adapter from the base unit, cutting off electrical power. 2.Disconnect the telephone cord from the base unit. 3.Let dry for at least 3 days. <p>IMPORTANT: You must unplug the telephone line while recharging the battery pack to avoid charge interruption.</p> <p>CAUTION: DO NOT use a microwave oven to speed up the drying process. This will cause permanent damage to the handset, base and the microwave oven. After following these steps, if your cordless telephone does not work, please send to:</p> <p style="text-align: center;">Uniden America Corporation Parts and Service Division 4700 Amon Carter Blvd. Ft. Worth, TX 76155 1-800-554-3988, Monday through Friday 8 a.m. to 5 p.m. CST</p>

Precautions!

Before you read anything else, please observe the following:

Warning!

Uniden America Corporation DOES NOT represent this unit to be waterproof. To reduce the risk of fire, electrical shock, or damage to the unit, DO NOT expose this unit to rain or moisture.

Rechargeable Nickel-Metal-Hydride Battery Warning

- This equipment contains a rechargeable nickel-cadmium battery.
 - Cadmium is a chemical known to the State of California to cause cancer.
 - The rechargeable nickel-cadmium battery contained in this equipment may explode if disposed of in a fire.
 - Do not short-circuit the battery.
 - Do not charge the rechargeable nickel-cadmium battery used in this equipment in any charger other than the one designed to charge this battery as specified in the owner's manual.
- Using another charger may damage the battery or cause the battery to explode.

Rechargeable Nickel-Cadmium Batteries Must Be Recycled or Disposed of Properly

- Uniden voluntarily participates in an RBRC® industry program to collect and recycle nickel-cadmium batteries at the end of their useful life, when taken out of service within the United States. The RBRC® program provides a convenient alternative to placing used nickel-cadmium batteries into the trash or municipal waste stream, which is illegal in some areas.
- Through the RBRC® program, Uniden makes it easy for you to drop off the used battery at local retailers of replacement nickel-cadmium batteries. You may also contact your local recycling center for information on where to return the used battery. Please call 1-800-8-BATTERY for information on Ni-Cd battery recycling in your area. Uniden's involvement in this program is part of its commitment to protecting our environment and conserving natural resources.
- RBRC® is a registered trademark of the Rechargeable Battery Recycling Corporation.

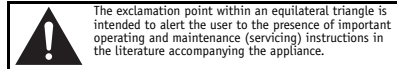

Uniden works to reduce lead content in our PVC coated cords in our product and accessories.

WARNING: The cords on this products and/or accessories contain lead, a chemical known to the State of California to cause birth defects or other reproductive harm. *Wash hands after handling.*

Important Safety Instructions

When using your telephone equipment, these basic safety precautions should always be followed to reduce the risk of fire, electrical shock, and injury to persons:

1. Read and understand all instructions.
2. Follow all warnings and instructions marked on the product.
3. Unplug this product from the wall outlet before cleaning. Use a dry cloth for cleaning without liquid or aerosol cleaners.
4. Do not use this product near water; for example, near a bathtub, wash bowl, kitchen sink or laundry tub, in a wet basement, or near a swimming pool.
5. Do not place this product on an unstable cart, stand, or table. The telephone may fall, causing serious damage to the unit.
6. Slots and openings in the cabinet and the back or bottom are provided for ventilation. To protect the product from overheating, these openings must not be blocked or covered. This product should never be placed near or over a radiator or heat register. This product should not be placed in a built-in installation unless proper ventilation is provided.
7. This product should be operated only from the type of power source indicated on the marking label. If you are not sure of the type of power supply to your home, consult your dealer or local power company.
8. Do not allow anything to rest on the power cord. Do not locate this product where the cord will be damaged by persons walking on it.
9. Do not overload wall outlets and extension cords, as this can result in the risk of fire or electrical shock.
10. Never push objects of any kind into this product through cabinet slots, as they may touch dangerous voltage points or short out parts that could result in a risk of fire or electric shock. Never spill liquid of any kind on the product.
11. To reduce the risk of electric shock, do not disassemble this product. Take it to qualified service personnel when service or repair work is required. Opening or removing covers may expose you to dangerous voltages or other risks. Incorrect reassembly can cause electric shock when the appliance is subsequently used.
12. Unplug this product from the wall outlet and refer servicing to qualified service personnel under the following conditions:
 - A. When the power supply cord is damaged or frayed.
 - B. If liquid has been spilled into the product.
 - C. If the product has been exposed to rain or water.
 - D. If the product does not operate normally when following the operating instructions. (Adjust only those controls that are covered by the operating instructions. Improper adjustment of other controls may result in damage and will often require extensive repair work by a qualified technician.)
 - E. If the product has been dropped or the cabinet has been damaged.
 - F. If the product exhibits a distinct change in performance.
13. Do not use the telephone to report a gas leak in the vicinity of the leak.

Additional Battery Safety Precautions

Caution! To reduce the risk of fire or injury to persons by the battery, read and follow these instructions:

1. Use only the Uniden power cord and batteries specified in the owner's manual.
2. Do not dispose of the battery pack in a fire. The cell may explode. Check with local codes for possible special disposal instructions.

3. Do not open or mutilate the battery pack. Released electrolyte is corrosive and may cause damage to the eyes or skin. It may be toxic if swallowed.
4. Exercise care in handling the battery in order not to short the battery with conducting materials such as rings, bracelets, and keys. The battery or conductor may overheat and cause burns.
5. Charge the battery pack provided with or identified for use with this product only in accordance with the instructions and limitations specified in the owner's manual provided for this product.
6. Observe proper polarity orientation between the battery pack and battery charger.
7. Batteries must be disconnected and removed from the product before shipment to prevent accidental operation during transport. Any batteries transported with the product must be separately secured and cushioned with any exposed terminals covered to prevent their breakage, leakage, movement within the packaging, or short circuits. Failure to follow these recommendations for shipment may result in serious damage and/or personal injury during transport and may be against the U.S. Department of Transportation (DOT), International Civil Aviation Administration (ICAO), International Air Transport Association (IATA), and/or the International Maritime Organization (IMO) regulations.
8. Avoid using a telephone (other than a cordless type) during an electrical storm. There may be a remote risk of electric shock from lightning.

SAVE THESE INSTRUCTIONS!

Important Electrical Considerations

Unplug all electrical appliances when you know an electrical storm is approaching. Lightning can pass through your household wiring and damage any device connected to it. This phone is no exception.

The FCC Wants You To Know

Changes or modifications to this product not expressly approved by Uniden, or operation of this product in any way other than as detailed by the owner's manual, could void your authority to operate this product. Your telephone complies with Part 68 of FCC Rules. You must, upon request, provide the FCC registration number and the REN to your telephone company. Both numbers are on the base unit.

- Note:**
- You must not connect your phone to:
 - coin-operated systems
 - most electronic key telephone systems

This device complies with Part 15 of the FCC rules. Operation is subject to the following two conditions: (1) This device may not cause harmful interference, and (2) This device must accept any interference received, including interference that may cause undesired operation. Privacy of communications may not be ensured when using this phone.

Range

Your new phone is designed to achieve the maximum possible range by transmitting and receiving according to the highest specifications set forth by the FCC. We have rated this phone to operate at a maximum distance with the qualification that the range depends upon the environment in which the telephone is used. Many factors limit range, and it would be impossible to include all the variables in our rating. The Maximum Range rating of this phone is meant to be used as a means of comparison against other range claims.

www.uniden.com

[53] ADDITIONAL INFORMATION

Telephone Line Problems

The FCC has granted the telephone company the right to disconnect service in the event that your phone causes problems on the telephone line. Also, the telephone company may make changes in facilities and services which may affect the operation of your unit. However, your telephone company must give adequate notice in writing prior to such actions to allow you time for making necessary arrangements to continue uninterrupted service.

If you are having trouble with your telephone service, you must first disconnect your phone to determine if it is the cause of your problem. If you determine that it is the cause, you must leave it disconnected until the trouble has been corrected.

Radio Interference

Radio interference may occasionally cause buzzing and humming in your cordless handset, or clicking noises in the base. This interference is caused by external sources such as TV, refrigerator, vacuum cleaner, fluorescent lighting, or electrical storm. Your unit is NOT DEFECTIVE. If these noises continue and are too distracting, please check around your home to see what appliances may be causing the problem.

In addition, we recommend that the base not be plugged into a circuit that also powers a major appliance because of the potential for interference. Be certain that antenna on the unit is fully extended. In the unlikely event that you consistently hear other voices or distracting transmissions on your phone, you may be receiving radio signals from another cordless telephone or other source of interference. If you cannot eliminate this type of interference, you need to change to a different channel.

Finally, it should be noted that some cordless telephones operate at frequencies that may cause interference to nearby TVs and VCRs. To minimize or prevent such interference, the base of the cordless telephone should not be placed near or on top of a TV or VCR. If interference is experienced, moving the cordless telephone farther away from the TV or VCR will often reduce or eliminate the interference.

More than One Cordless Telephone

If you want to use more than one cordless telephone in your home, they must operate on different channels. Press the delete/channel key to select a channel that provides the clearest communication.

Cordless Telephone Privacy

Cordless telephones are radio devices. Communications between the handset and base of your cordless telephone are accomplished by means of radio waves which are broadcast over the open airways. Because of the inherent physical properties of radio waves, your communications can be received by radio receiving devices other than your own cordless telephone unit. Consequently, any communications using your cordless telephone may not be private.

Installation Considerations

Selecting a Location (Base and Handset)

Before choosing a location for your new phone, there are some important guidelines you should consider:

- The location should be close to both a phone jack and continuous power outlet. (A continuous power outlet is an AC outlet which does not have a switch to interrupt its power.)
- Keep the base and handset away from sources of electrical noise such as motors or fluorescent lighting.
- The base can be placed on a desk or tabletop or mounted on a standard telephone wall plate.
- You should charge your new phone for 15-20 hours before completing the installation or using the handset.

(Outdoor sensor)

- Avoid heat sources and direct sunlight.
- Set up the Outdoor sensor at least 60 inches from the ground.
- Set up the Outdoor sensor where it will receive proper ventilation.
- The unit require the proper space for ventilation
- Do not place the Outdoor sensor where it will be exposed to rain or snow.

Telephone Line Outlets

There are two types of phone outlets:

Modular Jack

Most phone equipment available now uses modular jacks. Phone cords are fitted with a molded plastic connector which plugs into this type of jack. If you do not have modular phone jacks, contact your local telephone company for information about their installation.

Hardwired Jack

Some equipment is wired directly to a phone jack, and these types of installations require a modular jack converter. This type of installation is not difficult; however, you should contact your Uniden telephone dealer or a telephone supply store for advice about the proper adapter or converter for your particular situation.

Connecting the Telephone Cords

Consider these safety guidelines before connecting the telephone cords:

- Caution!**
- Never install telephone wiring during a lightning storm.
 - Never touch uninsulated telephone wires or terminals unless the telephone line has been disconnected.
 - Use caution when installing or modifying telephone lines.

Applying Power to the Base

This phone requires an AC outlet, without a switch to interrupt power, and the included AC adapter. To relieve strain on the DC plug when the phone is placed on a desk or table, wrap the power cord around the strain relief notch on the back of the base.

NOTE: Place the power cord so that it does not create a trip hazard, or where it could become chafed and create a fire or other electrical hazards.

One Year Limited Warranty

Important: Evidence of original purchase is required for warranty service. **WARRANTOR:** UNIDEN AMERICA CORPORATION ("Uniden")
ELEMENTS OF WARRANTY: Uniden warrants, for one year, to the original retail owner, this Uniden Product to be free from defects in materials and craftsmanship with only the limitations or exclusions set out below.

WARRANTY DURATION: This warranty to the original user shall terminate and be of no further effect 12 months after the date of original retail sale. The warranty is invalid if the Product is (A) damaged or not maintained as reasonable or necessary, (B) modified, altered, or used as part of any conversion kits, subassemblies, or any configurations not sold by Uniden, (C) improperly installed, (D) serviced or repaired by someone other than an authorized Uniden service center for a defect or malfunction covered by this warranty, (E) used in any conjunction with equipment or parts or as part of any system not manufactured by Uniden, or (F) installed or programmed by anyone other than as detailed by the owner's manual for this product.

STATEMENT OF REMEDY: In the event that the product does not conform to this warranty at any time while this warranty is in effect, warrantor will either, at its option, repair or replace the defective unit and return it to you without charge for parts, service, or any other cost (except shipping and handling) incurred by warrantor or its representatives in connection with the performance of this warranty. Warrantor, at its option, may replace the unit with a new or refurbished unit. **THE LIMITED WARRANTY SET FORTH ABOVE IS THE SOLE AND ENTIRE WARRANTY PERTAINING TO THE PRODUCT AND IS IN LIEU OF AND EXCLUDES ALL OTHER WARRANTIES OF ANY NATURE WHATSOEVER, WHETHER EXPRESS, IMPLIED OR ARISING BY OPERATION OF LAW, INCLUDING, BUT NOT LIMITED TO ANY IMPLIED WARRANTIES OF MERCHANTABILITY OR FITNESS FOR A PARTICULAR PURPOSE. THIS WARRANTY DOES NOT COVER OR PROVIDE FOR THE REIMBURSEMENT OR PAYMENT OF INCIDENTAL OR CONSEQUENTIAL DAMAGES.** Some states do not allow this exclusion or limitation of incidental or consequential damages so the above limitation or exclusion may not apply to you.

LEGAL REMEDIES: This warranty gives you specific legal rights, and you may also have other rights which vary from state to state. This warranty is void outside the United States of America and Canada.

PROCEDURE FOR OBTAINING PERFORMANCE OF WARRANTY: If, after following the instructions in the owner's manual you are certain that the Product is defective, pack the Product carefully (preferably in its original packaging). The Product should include all parts and accessories originally packaged with the Product. Include evidence of original purchase and a note describing the defect that has caused you to return it. The Product should be shipped freight prepaid, by traceable means, to warrantor at:

Uniden America Corporation
 Parts and Service Division
 4700 Amon Carter Blvd, Fort Worth, TX 76155
 (800) 297-1023, 8 a.m. to 5 p.m. CST, Monday through Friday
 or visit our website at www.uniden.com

www.uniden.com

ADDITIONAL INFORMATION [54]

ADDITIONAL
 INFORMATION

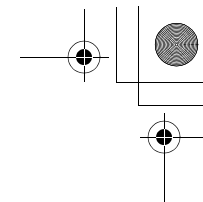
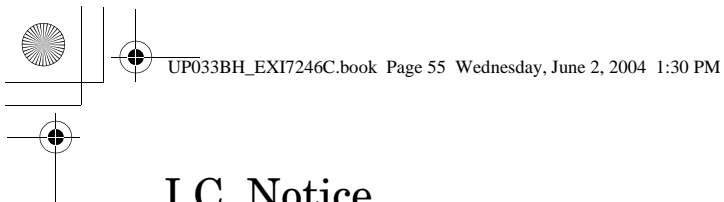

I.C. Notice

TERMINAL EQUIPMENT

NOTICE: This equipment meets the applicable Industry Canada Terminal Equipment Technical Specifications. This is confirmed by the registration number. The abbreviation, IC, before the registration number signifies that registration was performed based on a Declaration of Conformity indicating that Industry Canada technical specifications were met. It does not imply that Industry Canada approved the equipment.

NOTICE: The Ringer Equivalence Number (REN) for this terminal equipment is marked on the equipment itself. The REN assigned to each terminal equipment provides an indication of the maximum number of terminals allowed to be connected to a telephone interface. The termination on an interface may consist of any combination of devices subject only to the requirement that the sum of the Ringer Equivalence Numbers of all the devices does not exceed five.

RADIO EQUIPMENT

The term "IC:" before the radio certification number only signifies that Industry Canada technical specifications were met.

Operation is subject to the following two conditions: (1) this device may not cause interference, and (2) this device must accept any interference, including interference that may cause undesired operation of the device. "Privacy of communications may not be ensured when using this telephone".

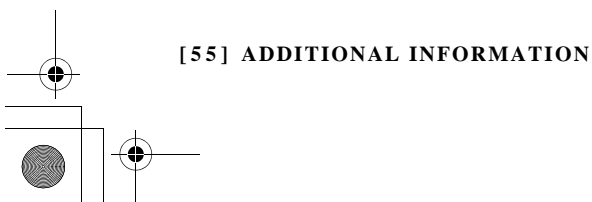
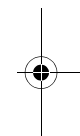
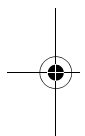

www.uniden.com

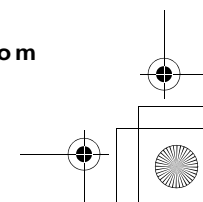
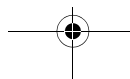

Index

A

- AC adapter information 48
- Access the weather data from the handset 35
- Alarm clock 17
- AutoTalk 19

B

- Base display icons 30
- Basic phone setup 19
- Battery pack (Handset)
 - Information 48
 - Installing 8
 - Replacement and handling . . . 46
- Battery pack (outdoor unit)
 - Information 48
 - Installing 9
 - Replacement and handling . . . 46
- Beltclip installation 40

C

- Call waiting 42
- Caller ID service 27
 - Call waiting 42
 - Deleting 29
 - Making a call 36
 - Viewing 28
- Channel 41

www.uniden.com

- Charging the handset battery pack .10
- CIDCW 19
- Cleaning contacts 47
- Connect the base unit 9
- Controls and functions 3, 4

D

- Dial mode 21
- Digital security code 44

E, F, G, H, I, J, K, L

- Earpiece volume 38
- Find handset 42
- General information 48
- Headset installation 39
- I.C. Notice 55
- Installing the phone 6
- Interference 54
- Language 21
- Liquid damage 52

M, N, O, P, Q

- Making a call 36
- Mount the Outdoor sensor 11
- Precautions 53

R

- Making a call 36
- Mount the outdoor unit 11
- Precautions 53

S

- Set the weather display 30

- Snooze feature 18
- Speed dial memory 23

T, U

- Tone dialing switch-over 41
- Traveling out-of-range 41
- Troubleshooting 49

V, W, X, Y, Z

- Voice mail waiting indicator . . . 43
- Wall mounting 12
- Warranty 54

Memory List

CUT
MEMORY LOCATION MEMO

Memory Location	Name	Phone Number	Memory Location	Name	Phone Number
1			6		
2			7		
3			8		
4			9		
5			10		

CUT
MEMORY LOCATION MEMO

CUT
MEMORY LOCATION MEMO

Memory Location	Name	Phone Number	Memory Location	Name	Phone Number
1			6		
2			7		
3			8		
4			9		
5			10		

CUT
MEMORY LOCATION MEMO

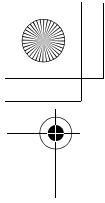

Memo

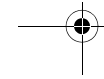
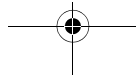
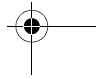
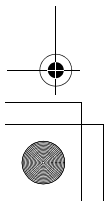
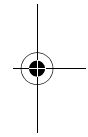
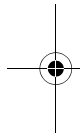
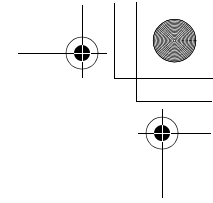

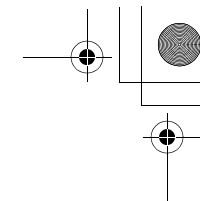
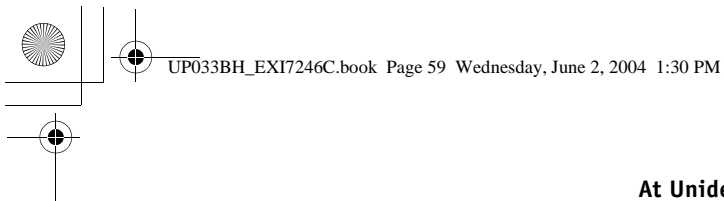

At Uniden, we'll take care of you!

If you need any assistance with this product, please call our Customer Hotline at **1-800-297-1023** or visit our web site at **www.uniden.com**

PLEASE DO NOT RETURN THIS PRODUCT TO THE PLACE OF PURCHASE.

Our Uniden representatives will be happy to help you with any matters regarding the operation of this unit, available accessories, or any other related matters.

Thank you for purchasing a Uniden product.
Hours: M-F 8:00 AM to 5:00 PM CST.

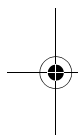

For information on the accessibility features of this product, please call **1-800-874-9314 (V/TTY)**

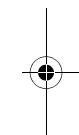

May be covered under one or more of the following U.S. patents:
4,523,058 4,595,795 4,797,916 5,381,460 5,426,690 5,434,905
5,491,745 5,493,605 5,533,010 5,574,727 5,581,598 5,650,790
5,660,269 5,661,780 5,663,981 5,671,248 5,696,471 5,717,312
5,732,355 5,754,407 5,758,289 5,768,345 5,787,356 5,794,152
5,801,466 5,825,161 5,864,619 5,893,034 5,912,968 5,915,227
5,929,598 5,930,720 5,960,358 5,987,330 6,044,281 6,070,082
6,125,277 6,253,088 6,314,278 6,418,209 6,618,015 6,671,315
For my info. The numbers will be revised after checking the latest patent numbers.

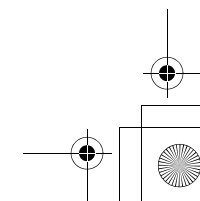
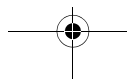
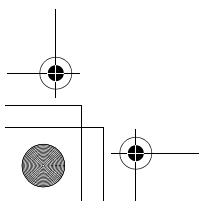

FOR
ACCESSORIES,
GO ONLINE @
WWW.UNIDEN.COM

REGISTER ONLINE TODAY!
THANK YOU FOR BUYING A UNIDEN PRODUCT.

A World Without Wires | **Uniden®**

©2004 Uniden America Corporation, Fort Worth, Texas. Contains additional foreign articles. Custom manufactured in China.

UCZZ01435EZ