

**QUICK  
EASY STEPS**  
FOR SETTING UP YOUR PHONE!  
SEE YOUR QUICK REFERENCE GUIDE SECTION

**Uniden®**  
OWNER'S MANUAL

**2.4GHz**

INTEGRATED DIGITAL ANSWERER WITH CALLER ID/CALL WAITING

**EXA 3245SERIES**

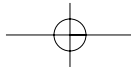
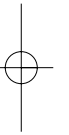
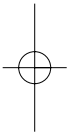
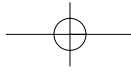

# Contents

## Quick Reference Guide

### Welcome/Features

### Controls and Functions

### Getting Started

- Checking the Package Contents 6
- Setting up the Phone 7
- Mounting the Base Unit on a Wall 12

### Basics

- Making and Receiving Calls 14
- Adjusting the Handset Ringer and Earpiece Volume 15
- Redial 15
- Tone Dialing Switch-over 16
- Traveling Out-of-Range 16
- Selecting a Different Channel 17
- Page 17
- Flash and Call Waiting 17

### Memory Dialing

- Storing Phone Numbers in Memory 18
- Making Calls with Memory Dialing 18
- Chain Dialing 19
- Erasing a Stored Number from Memory 19

<b>2</b>	<b>Rocket Dial</b>	
<b>3</b>	Rocket Dial	20
<b>4</b>	Storing the Rocket Dial	20
	Making Calls with the Rocket Dial	20
	Deleting the Rocket Dial	20
	<b>The Integrated Answering Device</b>	
	The Integrated Answering Device	21
	Features	21
	Turning the Answering System On/Off	22
	Setting Up Your Answering System	23
	Using Your Answering System	31
	<b>Additional Information</b>	
	Changing the Digital Security Code	37
	Note on Power Sources	38
	Maintenance	38
	Troubleshooting	39
	General Information	43
	Precautions & Warranty	44
	I.C. Notice	46
	Index	47
	Remote Operation Card	

**Step 1 Checking the Package Contents**

Make sure you have received the following items in the package. If any of these items are missing or damaged, contact the Uniden Parts Department.

- Base unit
- Handset
- AC adapter
- Rechargeable battery
- Telephone cord
- Wall mount adapter
- Beltclip
- This Owner's Manual
- Other Printed Material

Uniden Parts Department at  
(800) 554-3988  
Hours: M-F 7:00 a.m. to 5:00 p.m. CST.  
We can also be reached on the web at  
[www.uniden.com](http://www.uniden.com)

**Step 2 Install and Charge the Handset Battery**

- A** Remove the cover.



- B** Connect the battery pack connector with the correct polarity.

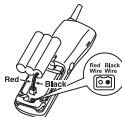

- C** Replace the cover.



- D** Plug the AC adapter cord into the base unit and then into a 120V AC outlet.

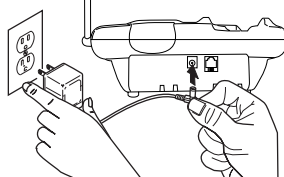

- E** Place the handset on the base and charge continuously for 15-20 hours before using the phone.

**Note:** Use ONLY the Uniden AC adapter supplied!

**Step 3 Connect to Phone Line****CONNECT TO A PHONE LINE**

When the handset battery pack is fully charged, after 15-20 hours of charging, plug the telephone cord into the base unit and then into a telephone wall jack.

Your phone is set for tone dialing. If your local network requires pulse dialing, please see "Choosing the dial mode" on page 15.

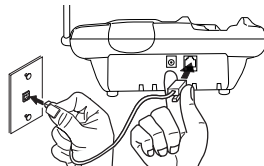
**Step 4 Setting Display Options**

**Note:** Three Caller ID options are available: AutoTalk, Caller ID on Call Waiting (CIDW), and Area Code.

To set Caller ID, Language and Dialing Options

- A** Press/hold *call id/menu* key.
- B** Press  $\wedge$  or  $\vee$  keys to move the pointer to an option.
- C** Press *select* to change the option setting.
- D** Press *end* to exit.

**Step 5 Set Answering System**

To turn answering system on, press *answer on/off*.

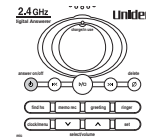

A pre-recorded greeting will play and your system is ready to accept calls.

To record a personal outgoing greeting to callers, please see page 43.

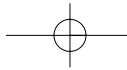

## Welcome

Congratulations on your purchase of the Uniden EXA3245 series cordless telephone and answering system. This phone is designed and engineered to exacting standards for reliability, long life, and outstanding performance.

**Note: Some illustrations in this manual may differ from the actual unit for explanation purpose.**



As an ENERGY STAR® Partner, Uniden has determined that this product or product models meets the ENERGY STAR® guidelines for energy efficiency. ENERGY STAR® is a U.S. registered mark.

## Features

- 2.4 GHz Extended Range Technology
- Integrated Telephone Answering Device (ITAD) (Bi-lingual Announcement Option)
- Voice Prompted Guidance through ITAD Setup Menu
- 10 Number Memory Dialing
- Rocket Dial
- 24 Digit Redial
- Flash and Pause
- Pulse/Tone Dialing
- Page/Find Handset
- 7 Hour Talk Time/14 Day Standby Time
- Handset Earpiece and Ringer Volume Control
- Hearing Aid Compatible
- 20 Channel Autoscan

**Be sure to visit our web site: [www.uniden.com](http://www.uniden.com)**

Uniden® is a registered trademark of Uniden America Corporation.

AutoTalk, AutoStandby, UltraClear Plus, Random Code, AutoSecure, and Rocket Dial are trademarks of Uniden America Corporation.

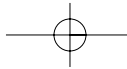

## Controls and Functions

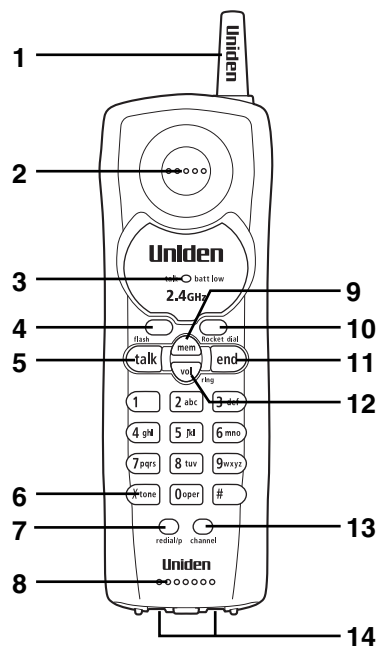

1. Handset antenna
2. Handset earpiece
3. talk/batt low LED
4. flash key
5. talk key
6. \* /tone key
7. redial/p
8. Handset Microphone
9. mem key (memory)
10. Rocket Dial key
11. end key
12. vol/ring key
13. channel key
14. Handset charging contacts

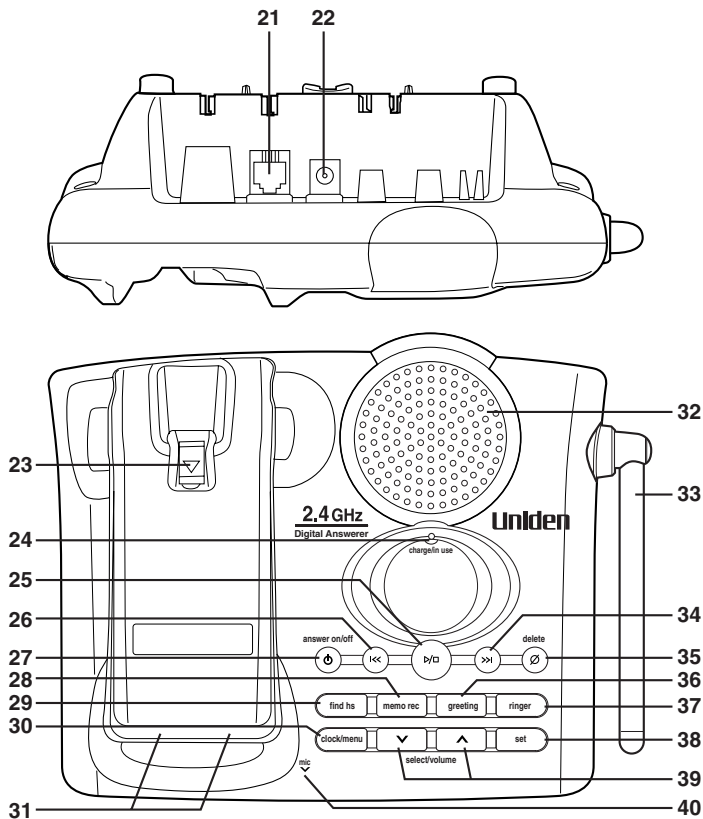

- 21. Telephone line jack
- 22. DC IN 9V jack
- 23. Handset retainer clip
- 24. Charge/in use LED
- 25. Play/stop  $\triangleright \square$  key
- 26. Repeat/rewind ( $\ll$ ) key
- 27. Answer on/off ( $\phi$ ) key
- 28. Memo record (rec) key
- 29. Find handset (hs) key
- 30. Clock/menu key
- 31. Base charging contacts
- 32. Base speaker
- 33. Base antenna
- 34. Skip/fast forward ( $\gg$ ) key
- 35. Delete ( $\emptyset$ ) key
- 36. Greeting key
- 37. Ringer key
- 38. Set key
- 39. Select/volume keys
- 40. Microphone

## Checking the Package Contents

Make sure you have received the following items in the package. If any of these items are missing or damaged, contact the Uniden Parts Department.

- **Base unit**
- **Handset**
- **AC adapter**
- **Rechargeable battery**
- **Telephone cord**
- **Wall mount adapter**
- **This Owner's Manual**
- **Other Printed Material**

Uniden Parts Department at (800) 554-3988  
Hours: M-F 7:00 a.m. to 5:00 p.m. CST. We can also  
be reached on the web at [www.uniden.com](http://www.uniden.com).



## Setting up the Phone

### Do the following steps:

- A. Choose the best location
- B. Install the battery pack
- C. Connect the base unit
- D. Choose the dialing mode

### A. Choose the best location

Before choosing a location for your new phone, read the **INSTALLATION CONSIDERATIONS** included in the **PRECAUTIONS AND IMPORTANT SAFETY INSTRUCTIONS**. Here are some important guidelines you should consider:

**Avoid heat sources, such as radiators, air ducts, and sunlight**

**Avoid television sets and other electronic equipment**

**Choose a central location**

**Avoid noise sources such as a window by a street with heavy traffic**

**Avoid microwave ovens**

**Avoid excessive moisture, extremely low temperatures, dust, mechanical vibration, or shock**

**Avoid personal computers**

**Avoid other cordless telephones**

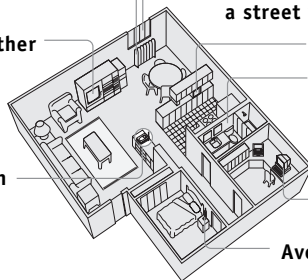

- The location should be close to both a phone jack and a continuous power outlet which is not switchable.
- Keep the base and handset away from sources of electrical noise such as motors, microwave ovens, and fluorescent lighting.
- Be sure there is sufficient space to raise the base antenna to a vertical position.
- The base can be placed on a desk, tabletop, or mounted on a standard wall plate.

[www.uniden.com](http://www.uniden.com)



If your home has specially wired alarm equipment connected to the telephone line, be sure that installing the system does not disable your alarm equipment. If you have questions about what will disable your alarm equipment, contact your telephone company or a qualified installer.



- Use only the Uniden battery (BT-905) supplied with your phone. Replacement batteries are also available through the Uniden Parts Department (see page 8).
- Recharge your phone on a regular basis by returning the handset to the base after each phone call.

## B. Install the rechargeable battery pack into the handset

Charge the battery pack for at least 15-20 hours before plugging in the telephone line and start using your phone.

- 1) Press in on the battery cover release and slide the cover down until it comes off.
- 2) Connect the battery pack connector, observing correct polarity (black and red wires), to the jack inside the battery compartment.

Do not exert any force on this connection. It could cause damage to the battery or handset. Once you are certain that you have made a good connection, then insert the battery pack into the battery compartment. Do not pinch the wires.

- 3) Securely close the battery compartment cover by sliding it up until it snaps into place.
- 4) Place the handset on the base.

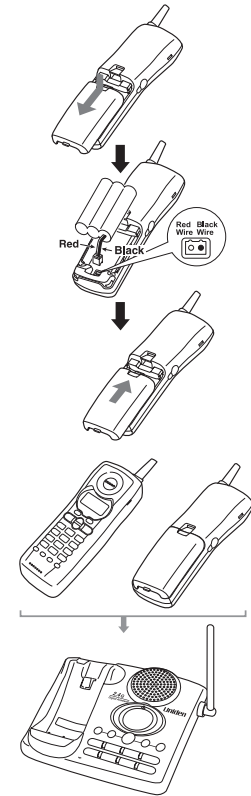

### Battery use time (per charge)

From fully charged (15-20 hours charge time)

- Seven hours continuous use.
- Fourteen days when the handset is in the standby mode.

### Low battery alert

When the battery pack is very low and needs to be charged, the phone is programmed to eliminate functions in order to save power. If the phone is not in use, the **talk/batt low** LED flashes when the battery pack is low.

If the phone is in use, the **talk/batt low** LED flashes and the handset beeps. Complete your conversation as quickly as possible and return the handset to the base unit for charging.



The last number dialed in the redial memory and the numbers stored in the memory locations are retained for up to 1 minutes while you replace the battery pack.

### Cleaning the battery charging contacts

To maintain a good charge, it is important to clean the charging terminals on both the handset and base unit once a month. Use a dry cloth or pencil eraser to clean. If the contacts became very dirty, use water only, dampen a cloth to clean the charging terminals. Then make sure to go back over the charging terminals with a dry cloth before returning the handset to the base to charge.

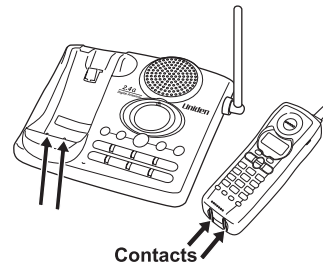

Throughout this manual, terms such as Standby and Talk Mode are used. Below is the terminology explanation.

- **Standby Mode** - The handset is not in use, off the base, and **talk/flash** has not been pressed. A dial tone is not present.
- **Talk Mode** - The handset is off the base and **talk/flash** has been pressed enabling a dial tone.



- Place the power cord so that it does not create a trip hazard or where it could become chafed and create a fire or electrical hazard.
- **Use only the supplied AD-314 AC adapter. Do not use any other AC adapter.**



The handset can be placed face up or face down in the base for charging.

### C. Connect the base unit

- 1) Connect the AC adapter to the **DC IN 9V** jack and a standard 120V AC wall outlet.
- 2) Set the base on a desk or tabletop, and place the handset on the base unit as shown. (For wall mounting, see "Mounting the Base Unit on a Wall", on page 12.)
- 3) Raise the antenna to a vertical position.
- 4) Make sure the **charge/in use** LED illuminates. If the LED does not illuminate, check to see that the AC adapter is plugged in and the handset makes good contact with the base charging contacts.



- Connect the AC adapter to a continuous power supply.
- Place the base unit close to the AC outlet so that you can unplug the AC adapter easily.

- After installing the battery pack in the handset, charge your handset at least **15-20 hours before plugging into the phone line**. Once the handset battery pack is fully charged, connect the telephone line cord to the base and telephone wall outlet.

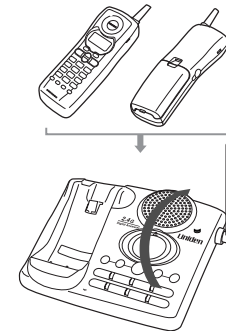
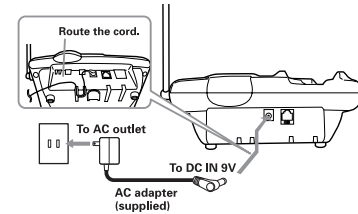

- 5) Connect the telephone line cord to the **TEL LINE** jack and a telephone outlet once the handset is fully charged.



If your telephone outlet isn't modular, contact your telephone company for assistance.

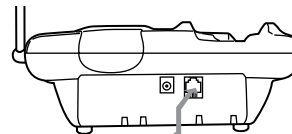

### D. Choose the dial mode

Most phone systems use tone dialing which sends DTMF tones through the phone lines. However some phone systems still use pulse dialing such as in rural areas. The default setting is tone dialing. Depending on your dialing system, set the mode as follows:

- 1) Press and hold **flash** until you hear a confirmation tone.
  - 2) To set the dial mode for pulse dialing, press **#**.  
Or to set the dial mode for tone dialing, press **\*/tone**.  
You hear a confirmation tone to indicate the setting is complete.
- If you are not sure of your dialing system, set for tone dialing. Make a trial call. If the call connects, leave the setting as is, otherwise set for pulse dialing.
  - If your phone system requires pulse dialing and you need to send DTMF tones for certain situations during a call, you may “switch-over” to tone dialing. (Refer to “Tone Dialing Switch-over” on page 16.)



Make sure your battery pack is fully charged before choosing the dial mode.



DO NOT use an AC outlet controlled by a wall switch.

## Mounting the Base Unit on a Wall

### Setting the handset retainer clip for wall mounting

- 1) On the base unit, pull the handset retainer clip out of the slot and rotate it clockwise 180 degrees.
- 2) Flip the retainer clip from front to back. Slide it back into the slot so that the lip of the retainer is up and the ▼ is down. The retainer holds the handset in place.

### Standard wall plate mounting

This phone can be mounted on any standard wall plate.

- 1) Plug the AC adapter to the **DC IN 9V** jack.
- 2) Wrap the AC adapter cord inside the molded wiring channel as shown.
- 3) Plug the AC adapter into a standard 120V AC wall outlet.
- 4) Plug the telephone line cord into the **TEL LINE** jack. Wrap the cord inside the molded wiring channel as shown.
- 5) Plug the telephone line cord into the telephone outlet.
- 6) Raise the antenna to a vertical position.
- 7) Align the mounting slots on the base with the mounting posts on the wall. Then push in and down until the phone is firmly seated.

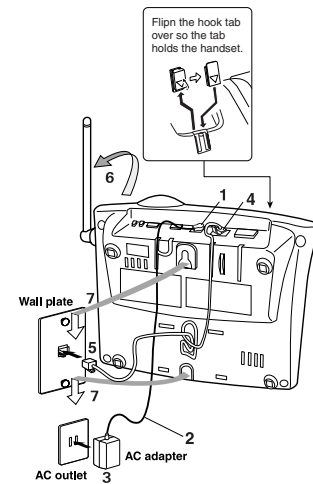

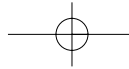

## Direct wall mounting

If you don't have a standard wall plate, you can mount your phone directly to the wall. Before doing this, consider the following:

- Avoid electrical cables, pipes, or other items behind the mounting location that could cause a hazard when inserting screws into the wall.
- Try to mount your phone within 5 feet of a working phone jack to avoid excessive cord lengths.
- Make sure the wall material is capable of supporting the weight of the base and handset.
- Use #10 screws (minimum length of 1-3/8 inches) with anchoring devices suitable for the wall material where the base unit will be placed.

- 1) Insert two mounting screws into the wall, (with their appropriate anchoring device), 3-15/16 inches apart. Allow about 1/8 of an inch between the wall and screw heads for mounting the phone.
- 2) Refer to steps 1 through 7 on page 13 to mount the telephone.

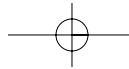
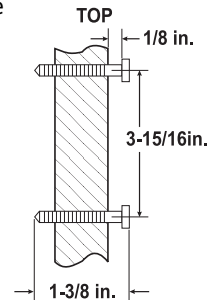

## Making and Receiving Calls

	Handset On Base	Handset Off Base
To answer a call	Pick up the handset (AutoTalk).	Press <b>talk</b> , any number, <b>*/tone</b> or <b>#</b> key (AutoTalk).
To make a call	<ol style="list-style-type: none"> <li>1) Pick up the handset.</li> <li>2) Press <b>talk</b> key. The <b>talk/batt low</b> LED flashes and turns on.</li> <li>3) Listen for the dial tone.</li> <li>4) Dial the number.</li> </ol>	<ol style="list-style-type: none"> <li>1) Press <b>talk</b> key. The <b>talk/batt low</b> LED flashes and turns on.</li> <li>2) Listen for the dial tone.</li> <li>3) Dial the number.</li> </ol>
To hang up	Press <b>end</b> key or return the handset to the base (AutoStandby).	
To redial	<ol style="list-style-type: none"> <li>1) Pick up the handset.</li> <li>2) Press <b>talk</b> key.</li> <li>3) Listen for the dial tone.</li> <li>4) Press <b>redial/p</b> key.</li> </ol>	<ol style="list-style-type: none"> <li>1) Press <b>talk</b> key.</li> <li>2) Listen for the dial tone.</li> <li>3) Press <b>redial/p</b> key.</li> </ol>



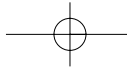

## Adjusting the Handset Ringer and Earpiece Volume

### Handset ringer tone

When the phone is in standby mode, pressing **vol/ring** key on the handset selects the handset ringer tone. There are two ringer tones. Continue pressing **vol/ring** key to listen to all tones. The phone keeps the last ringer tone setting selected.

### Earpiece volume

The handset earpiece volume settings (Low, Medium and High) can only be adjusted during a call. Press **vol/ring** key repeatedly to select Low, Medium and High. When you hang up, the phone keeps the last volume setting selected.

### Ringer Mute

You can temporarily mute the handset ringer tone. (The base unit will continue to ring.) When the handset is off the base and phone is ringing, press **end** key. The ringer tone will return to normal starting with the next incoming call.

## Redial

The **redial/p** key redials the last number dialed. The redialed number can be up to 24 digits long.

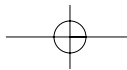
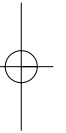
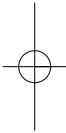



- The tone feature only applies when the dial mode is set to pulse.
- This special number can be stored in a memory location. This is referred to as Chain Dialing (See page 19.)

## Tone Dialing Switch-over

Some telephone companies use equipment that requires pulse dialing (sometimes referred to as rotary dialing). If you need to enter tone dialing digits, you can switch-over to tone dialing during the call. For example, entering your bank account number after you have called your bank.

Initially make your call with the pulse dialing mode. Once your call connects, press **\*/tone** key. Enter the desired number. These digits will be sent as tone dialing. Once the call ends, the tone mode is canceled and pulse dialing mode resumes.

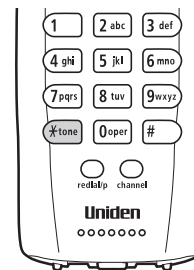

## Traveling Out-of-Range

During a call, as you begin to move your handset too far from your base unit, noise increases. If you pass the range limits of the base unit, your call will terminate within 1 minute.

## Selecting a Different Channel

If you encounter interference while using your phone, you can manually change the phone's channel for clear operation. This function works only when the phone is in use.

Press **channel** key. The **talk/batt low** LED flashes indicating the phone is changing to another channel. For more information on interference, refer to "Precautions" on page 45.

## Page

To locate the handset (while it's off the base), press **find hs** on the base. The handset beeps for 60 seconds.

Paging is canceled when pressing any handset key, **find hs** on the base or the handset is returned to the base.

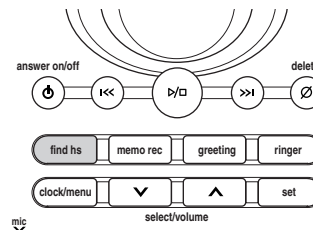

## Flash and Call Waiting

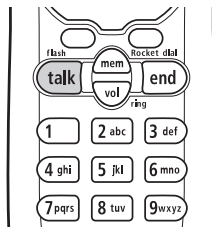

If you have "Call Waiting" service and a call waiting tone sounds while you are on a call, press **flash** key to accept the waiting call. There is a short pause, then you will hear the new caller. To return to the original caller, press **flash** key again.



You must subscribe through your local telephone company to receive Call Waiting Service.

www.uniden.com



- The **UltraClear Plus™** true compander circuitry virtually eliminates background noise. This innovative technology, together with 20 different channels, provides you with the best possible reception during all your conversations.

- Paging is also canceled when the phone receives an incoming call.
- Paging is not available while TAD (see page 21) is in use.



- The pause feature is useful for long distance calling, credit card dialing, or sequences that require a pause between digits.
- The pause key counts as one digit. Pressing **redial/p** more than once increases the length of pause between numbers.
- To exit the memory function without dialing, press **end**. The handset returns to standby.
- If you select a memory location that does not have a stored number, an error tone will sound and the phone will not dial.

## Storing Phone Numbers in Memory

Memory Dialing allows you to dial a number using just a few key presses. Your cordless phone stores up to 10 numbers in the handset.

- 1) Press **mem**. The **talk/batt low** LED flashes.
- 2) Enter the phone number, up to 20 digits. If a pause is needed during the dialing sequence, press **redial/p** to insert a pause. Each pause counts as a digit and represents a two second delay in time between digits as they are sent.
- 3) Press **mem** again.
- 4) Enter the memory location (0 - 9) on the keypad. A tone indicates that the number is stored. If you enter a number in a location that has a previously stored number it will overwrite the existing number without warning.



In memory dialing operation, you must press a key within 30 seconds. Otherwise, an error tone will sound and the phone will return to standby. If you return the handset to the base, the phone will return to standby also.

## Making Calls with Memory Dialing

- 1) Press **talk**, then press **mem**.
- 2) Enter the memory location on the keypad. The stored number automatically dials.

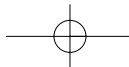

## Chain Dialing

The memory locations on the handset are not limited to phone numbers. You can also store a group of numbers (up to 20 digits) that you need to enter once your call connects. This is referred to as Chain Dialing.

An example of this is a bank account number. Once you have called your bank, and are prompted to enter the account number, simply press **mem** and the location number where the special number has been stored.

Store your special number in memory as you would store a phone number. (Refer to "Storing Phone Numbers in Memory" on page 18.)

## Erasing a Stored Number from Memory

- 1) Press **mem** twice.
- 2) Press the memory location (0-9) or **Rocket Dial**. You hear a confirmation tone and the stored number is erased from memory.

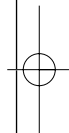
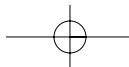
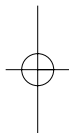



- **Rocket Dial™** is a one touch speed dial key that automatically dials your most important or frequently called number. The number dialed, is a preset number stored by the user.
- Number stored in Rocket Dial is independent from the numbers stored in Memory Dial.
- If the Rocket Dial does not have a stored number, the handset will beep rapidly and the phone will not dial.

## Rocket Dial

You can store your most frequently dialed number in the Rocket Dial. The Rocket Dial allows you to dial a number with one key press. (There is no need to press **talk**. The phone will automatically dial the number stored.)

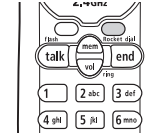

## Storing the Rocket Dial

- 1) When the phone is in the standby mode, press **mem**.  
The **talk/batt low** LED flashes.
- 2) Enter the phone number up to 20 digits. See page 18 for detail.
- 3) Press **mem** again.
- 4) To actually store a number, press **Rocket Dial**. A tone indicates that the number is stored. If there is a number already stored, the new number will be overwritten without warning.

## Making calls with the Rocket Dial

When the phone is in the standby mode, simply press **Rocket Dial**. The number stored in the Rocket Dial is instantly dialed.

## Deleting the Rocket Dial

- 1) Press **mem** twice.
- 2) Press **Rocket Dial** key. You hear a confirmation tone and the stored number is erased.

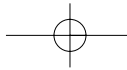

# The Integrated Answering Device

The cordless phone has a built-in answering system that answers and records incoming calls. You can also use your answering system to record a conversation, leave a voice memo message, or to announce a special outgoing message to callers when you're away from your phone.

## Features

- Digital Tapeless Recording
- 11 minutes of Recording Time
- Call Screening
- Selectable Outgoing Messages
- Voice Prompts for Guidance (Bi-lingual Announcement Option)
- Time and Day Announcement
- Remote Message Retrieval
- Toll Saver
- Conversation Recording
- Voice Memo

Digital Tapeless Recording allows you to quickly review, save, or delete the messages you choose. You will never have to worry about a tape wearing out, jamming, or resetting improperly.

The Integrated Answering System is easy and convenient to use, but **please read** through all of the instructions carefully.

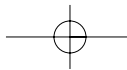

## Turning the Answering System On/Off

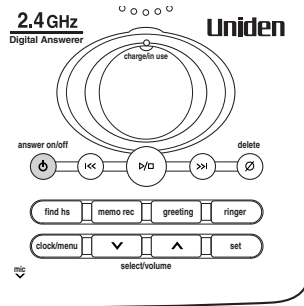

- 1) To turn the answering system on, press **answer on/off**.  
“Answering system is on” and the current greeting message will be played and you will hear a confirmation tone. The message counter displays the number of messages stored in memory. If the display flashes, then there are new messages waiting for you.
- 2) To turn the answering system off, press **answer on/off** again. After the announcement “Answering system is off” the message counter display will no longer be illuminated.



# Setting up Your Answering System

## Using the Menu Mode

The Menu mode allows you to set the following Answering System functions.

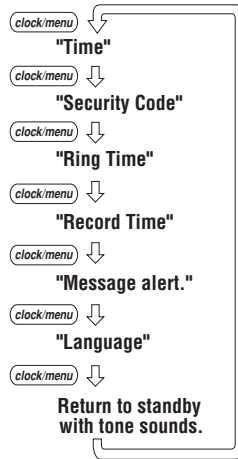

- To scroll through the menu options, repeatedly press **clock/menu**. The system returns to standby after the last menu option. You hear a confirmation tone to indicate standby mode.
- If any of the following occurs during menu setup, the handset returns to standby. Start over with the menu function prior to the interruption.
  - Press **talk**
  - Press **play/stop**
  - 10 seconds lapse of time
  - Receive a call
- The idle time default setting is 10 seconds. If the base remains idle for 5 seconds, an error tone sounds and the system returns to standby.
- You can use select/volume **^/∇** keys to adjust the announcement volume level during a voice prompt/guidance.



- For your convenience, voice prompts will guide you through the menu mode.
- After the setting, press **play/stop** to exit the menu mode, or **clock/menu** to move to the next menu option. Or the system automatically returns to standby in 10 seconds after the setting.

## note

- Normally the idle time for the menu mode is 10 seconds before the system returns to standby. However for setting the time, the idle time is extended to two minutes.
- Press and hold **skip/ff** or **repeat/rew** to quickly scroll through the numbers on the display.

## Setting the Time

The clock on the cordless phone's answering system starts when power is supplied to the base. Follow these steps to set the clock to the correct time.

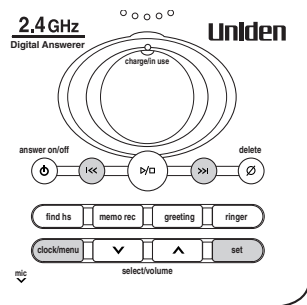

- 1) Press **clock/menu**.  
The system announces "Time", the current time and the guidance for setting.
- 2) Press **select/volume**  $\wedge$  or  $\vee$  key until the correct day is announced. The numbers [ 1 ] through [ 7 ] are displayed on the base.
- 3) Press **set** to select the day.
- 4) Press **select/volume**  $\wedge$  or  $\vee$  key until you hear the correct hour setting. The numbers [ 1 ] through [ 12 ] are displayed on the base as each hour is announced.
- 5) Press **set** to select the hour.
- 6) Press **select/volume**  $\wedge$  or  $\vee$  key until you hear the correct minute setting. The numbers [ 00 ] through [ 59 ] are displayed on the base as each minute is announced.

- 7) Press **set** to select the minute.
- 8) Press **select/volume**  $\wedge$  or  $\vee$  key until you hear the correct AM or PM setting. The message counter displays [ *A* ] or [ *P* ].
- 9) Press **set** to select the AM/PM setting.

You hear a confirmation tone, then the announcement "Time" and the time and day are announced for your review. After a few seconds, the system announces "To set security code, press **menu** again".

### Setting a Personal Security Code (PIN)

To play your messages from a remote location, you will need to enter a two-digit Personal Identification Number (PIN) code (01-99). To select a PIN, perform the following steps:

- 1) Press **clock/menu** twice in standby mode. "Security code" and the current PIN code is announced as it is displayed on the base. Then the system announces the guidance for setting.
- 2) Press **select/volume**  $\wedge$  or  $\vee$  keys until the desired number appears.
- 3) Press **set** to select the PIN code. You hear a confirmation tone, then the announcement "Security code" and the new PIN code is announced. After a few seconds, the system announces "To set ring time, press menu again".



The PIN code is set to "80" when you purchase the cordless phone.

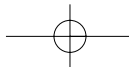

### Setting the ring time

The ring time setting allows you to set the number of rings the caller hears before your answering system plays the outgoing message. You can set the ring time to answer after two, four, or six rings. Setting **5** (Toll Saver), the answering system picks up after two rings if you have new messages, and after four rings if there are none. This way, if you make a long distance call to check your messages, you can hang up after the second ring to avoid billing charges.

- 1) Press **clock/menu** three times in standby mode.  
You hear “Ring time” and the current ring time ([ 2 ] 2, [ 4 ] 4, [ 5 ] 6, [ 5 ] Toll saver), and it is displayed on the base. Then you hear the guidance for setting.
- 2) Press **select/volume** **^** or **v** key until the desired ring time appears.
- 3) Press **set** to select the new ring time. You hear a confirmation tone, then the announcement “Ring time” and the new ring time is announced. After a few seconds, the system announces “To set record time, press menu again”.

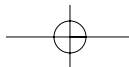

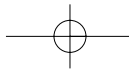

## Selecting the message record time

You have three record time options. The options "1 minute" or "4 minutes" set the duration for recording the incoming messages. "Announce only" answers the call with the preset greeting or your personal greeting but prevents the caller from leaving a message.

- 1) Press **clock/menu** four times in standby mode.  
You hear "Record time" and the current recording time ([ 1 ] 1 minute, [ 4 ] 4 minutes, [ # ] Announce only), and it is displayed on the base. Then you hear the guidance for setting.
- 2) Press **select/volume**  $\wedge$  or  $\vee$  keys until the desired time appears.
- 3) Press **set** to select the new recording time. You hear a confirmation tone, then the announcement "Record time" and new recording time is announced. After a few seconds, the system announces "To set message alert, press menu again".

### ▼ Announce only feature

The announce only feature plays a prerecorded outgoing message "Hello, no one is available to take your call. Please call again.", but it will not allow the caller to leave a message. To set "Announce only", follow the steps above.

To scroll between the prerecorded message or your own personal greeting, press **greeting** when the outgoing message is played. If you want to use your own greeting, you may want to change your greeting to omit the prompt "to leave a message". Refer to "Recording a personal outgoing message" (Greeting) on page 29.



After setting for the Announce only feature, you may want to change your outgoing message if the message prompts the caller to leave a message. But the prerecorded message changes automatically.

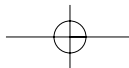
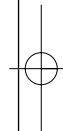

### Setting the Message Alert tone

Message Alert feature lets you know you have new messages by sounding a short beeping tone. If you set the Message Alert to On and when a new message is received, the alert tone will sound every 15 seconds.

Setting the Message Alert tone to On or Off by using menu key.

1) Press **clock/menu** five times in standby mode.

You hear the announcement "Message Alert" and the current setting ([ *Off* ] Off or [ *On* ] On), and it is displayed on the base. And you hear the guidance for setting.

2) Press **select/volume** **^** or **v** key to select.

3) Press **set** to select the new setting. You hear a confirmation tone, then the announcement "Message Alert" and the current setting you have selected is announced. After a few seconds, the system announces "To set language, press menu again".

When the first new message is received, the beeping tone will begin to sound.

Turning the Message Alert tone Off by pressing any key.

1) To quickly turn Message Alert tone off, **press any key** on the base unit and the tone will **automatically deactivate**. To reset, go back into the menu setup mode (steps 1 - 3 above.)

Turning Message Alert tone Off when you're away from your phone.

1) When all **new messages** are played back using the remote playback feature (see page 50) the Message Alert tone will automatically deactivate. The tone will not deactivate until all messages are played back.

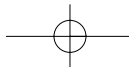

## Selecting the Language

The answering system voice announcements can be heard in English or French. To choose the language of the answering system voice announcements:

- 1) Press **clock/menu** six times in standby mode.  
The current setting ("E" or "F") appears on the base, and you hear the announcement "Language, English" followed by the guidance for setting.
- 2) Press **select/volume** **▲** or **▼** key to select the desired language.
- 3) Press **set**.  
A confirmation tone is heard along with the setting in the language selected.

## Setting Your Outgoing Message (Greeting)

When you receive a call, the answering system automatically plays either a preset message or your own greeting.

### ▼Preset message

The following message is prerecorded:

"Hello, no one is available to take your call. Please leave a message after the tone."



See "Selecting the message record time", page 27 how to set the announce only feature.

### ▼Recording a personal outgoing message (Greeting)

- 1) Press and hold **greeting**.  
You hear the announcement "Record greeting" and a confirmation tone.  
[ -- ] flashes on the message counter.
- 2) Start recording your message. You have 30 seconds, and the message counter starts to count down [ 30 ] to [ / ] every second.
- 3) When you are finished recording your greeting, press **greeting, play/stop** or **set**.  
You hear a confirmation tone, and then your greeting plays back for you.

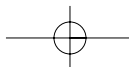

- You can record a greeting up to 30 seconds long.
- Position yourself as near to the base as possible and speak clearly when recording your outgoing message.

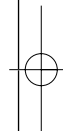



When you have set the base ringer to off and the handset is on the base, you will still hear the ringer from the handset.

### ▼ Choosing between the two outgoing messages

Press ***greeting***. Then press ***greeting*** again when the outgoing message is played. This switches between the prerecorded greeting and the personal greeting. After finishing playing back the message, a confirmation tone is heard.



To delete the personal Greeting, press ***delete*** during the announcement and the system announces "Greeting has been deleted".

### Setting the base ringer volume

You have three ringer options. One allows you to turn the ringer off. The other two are volume levels.

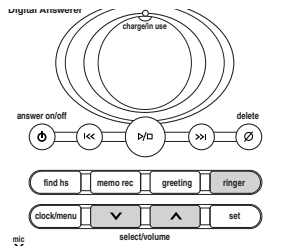

#### 1) Press ***ringer***.

You hear the ringer at the current volume level ([ ***H*** ] High, [ ***L*** ] Low, [ ***OFF*** ] off) (if you set the base ringer volume to off, "off" is announced) and it is displayed on the base.

#### 2) Press ***ringer*** until the desired ringer option appears.

#### 3) The system displayed new ringer volume.

### Adjusting the speaker volume level

You can adjust the volume of the base speaker by pressing ***select/volume*** **^** or **∨** on the base.

Press **^** for louder or **∨** for softer during the base speaker is being used. The numbers 0-9 are displayed on the base indicating the volume levels. 0 being the softest and 9 being the loudest.



When you press **^** at 9 or **∨** at 0, an error tone sounds.



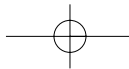

## Using Your Answering System

The message counter displays the number of messages stored in memory. If the display flashes, then there are new messages waiting for you. The flashing number represents the number of new messages, not total messages. The cordless phone is designed to play your new messages first. After you play all your new messages, you can then play your old messages.



When the answering system is full, *FL* is displayed on the base, and the system announces "No remaining time". You should delete some messages so that the system can record new messages. (Refer to "Deleting a message" on page 33.)

### Playing your messages

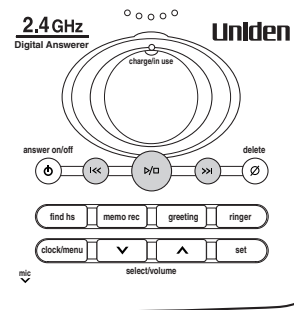

#### 1) Press **play/stop**.

The system announces the number of new and old messages. The LED displays the number of new messages, and the number flashes. The day and time that each message was received is announced after the message is played. The message counter displays the number of current messages stored.

When all new messages have been played, you hear a confirmation tone and an announcement "End of messages". The system returns to standby.

#### 2) After you have reviewed your new messages, you can play your old messages by again pressing **play/stop**. Once you have listened to a new message, it becomes an old message. The old messages will be played in the order in which they were received.



To stop playing your messages, press **play/stop** again at any time.

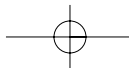

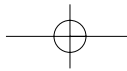

### Repeating a message

- 1) Press **play/stop** to review your messages. The number of stored messages are announced.
- 2) After a message has played for a few seconds, press **repeat/rew** to replay the message. If you have several messages, press **repeat/rew** repeatedly until you return to the message you want to replay.
- 3) Press **play/stop** at any time to stop reviewing messages and return to standby. The message counter shows the number of messages stored in memory.

*To quickly scroll backward through a message, press and hold **repeat/rew**.*

### Skipping a message

- 1) Press **play/stop** to review your messages. The number of messages is announced.
- 2) Press **skip/ff** at anytime to skip to the next message.  
Each time **skip/ff** is pressed, the system scans forward one message. If you have several messages, press **skip/ff** to find the message you want to play.
- 3) Press **play/stop** at any time to stop reviewing your messages and return to standby. The message counter shows the number of messages stored in memory.

*To quickly scroll forward through a message, press and hold **skip/ff**.*

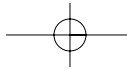

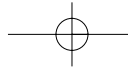

## Deleting a message

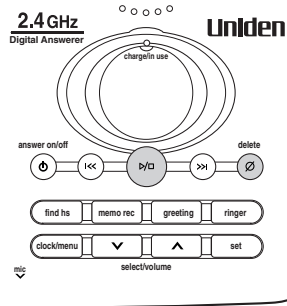

To maintain maximum record time, delete the old messages.

- 1) Press **play/stop** to review your messages.
- 2) Press **delete** anytime during the message to delete.
- 3) You hear a confirmation tone and the message is deleted.

You can also delete all the messages.

- 1) Press **delete** in standby mode.  
You hear an announcement "To delete all messages, press delete again".
- 2) Press **delete** again.  
You hear a confirmation tone and all the messages are deleted.

When you try to delete all messages without first listening to your new messages, you hear several short beeps followed by an announcement "Please playback all messages". This protects you from accidentally erasing messages you have not yet reviewed.



When you press **delete**, you are permanently deleting the message. Once deleted, the message cannot be replayed.

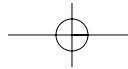



- The voice memo function is completely independent of the greeting message.
- The voice memo messages are recorded as incoming messages.

- A recorded conversation is treated as a typical message and will be added to the stored messages.
- When recording a conversation, all handset keys except **talk** are disabled. Stop recording if you need to enable any other handset keys.

## Voice memo

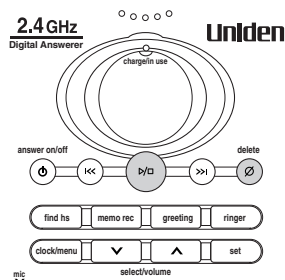

The voice memo function allows the user to record messages (up to 4 minutes).

- 1) Press and hold **memo rec**.  
You hear an announcement "Record memo message" and a tone. [ - - ] flashes on the message counter.
- 2) Start your recording.
- 3) When you have finished, press **play/stop**, **memo rec** or **set** to stop recording. You hear a confirmation tone and the system returns to standby.

## Recording a conversation

You can record up to 10 minutes of conversation while you are using your phone.

- 1) During a conversation from the handset, press and hold **memo rec**. The unit begins recording with a confirmation tone and [ - - ] flashes on the message counter.  
**A beep that can be heard by both parties, sounds during recording.**



If you receive a call waiting tone while recording a conversation, press **talk** to accept the waiting call. The recording feature continues recording the new call. The original call is put on hold.

- 2) To stop recording, press **play/stop** or **memo rec**.  
You hear a confirmation tone.

## Remote access away from home

You can operate your answering system from a remote location using any touch-tone telephone. Use this function to check for recorded messages, to play or delete messages, even to record a new greeting message.

- 1) Call your telephone number.
- 2) During the greeting message, press **0** and enter your PIN code.  
(See "Setting a Personal Security Code", page 39).
- 3) The answering system announces the current time and the number of messages stored in memory. Then you hear "To play incoming messages, press zero two. For help, press one zero".
- 4) You may continue to listen to the Help Guidance, or you may select a command from the following chart:

Command	Function
0 then <b>1</b>	Repeat a Message
0 then <b>2</b>	Playing Incoming Messages
0 then <b>3</b>	Skipping a Message
0 then <b>4</b>	Deleting a Message
0 then <b>5</b>	Stop Operation
0 then <b>6</b>	Answering System On
0 then <b>7</b>	Memo Record/Stop*
0 then <b>8</b>	Greeting Message Record/Stop*
0 then <b>9</b>	Answer System Off
1 then <b>0</b>	Help Guidance

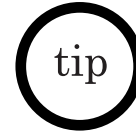

For your convenience remote operation cards are provided for you to use while away from home (located after the index page).



You must enter a command within 15 seconds of entering command waiting mode or the answering system automatically hangs up and returns to standby.

\* For Memo Record and Greeting Message Record function, the first time you enter the corresponding command, it starts the Recording function. If you want to stop the recording, enter the command again.

- 5) After all of the Help Guidance prompts have played, you hear intermittent beeps indicating that the system is in the command waiting mode. You may enter another command at this time from the chart.
- 6) When you are finished, hang up to exit the system. The answering system automatically returns to standby.

#### **Turn on the answering system remotely**

If you have forgotten to turn on your answering system, you can turn it on remotely from any touch-tone telephone.

- 1) Call your telephone number.
- 2) Wait ten rings until the system answers. You hear a beep.
- 3) Press **0** and then enter your PIN code. The answering system announces the number of messages stored in memory. You hear "To play incoming messages, press zero two. For help, press one zero".
- 4) Press **0** then **6** to turn the answering system On. You hear the outgoing message and a confirmation tone.
- 5) Hang up the phone and subsequent calls will be answered by the system.

## Changing the Digital Security Code

The digital security code is an identification code used to connect the handset and the base unit. Normally, setting the code is not necessary. The first time you charge your handset, the security code is automatically set. In the rare situation that you suspect another cordless telephone is using the same security code, you can change the code.

- 1) Remove the handset from the base unit. Press and hold ***find hs*** on the base.
- 2) While the handset is emitting the paging sound, place the handset on the base unit holding ***find hs***. The paging sound stops. Leave the handset on the base for more than 3 seconds. A new random security code is set.



- To protect you against misbilled calls which might result from your phone being activated by other equipment, the cordless phone has ***Random Code™*** digital security which automatically selects one of over 262,000 digital security codes for the handset and base. Also, the ***AutoSecure™*** feature electronically locks your phone when the handset is in the base.
- If the handset battery pack is completely discharged or the battery pack is removed, the digital security code will be lost. If this happens, a new security code is set automatically next time the battery pack is charged.

ADDITIONAL  
INFORMATION

## Note on Power Sources

### Battery replacement and handling

When the operating time becomes short, even after a battery is recharged, please replace the battery. With normal usage, your battery should last about one year.

Please contact your place of purchase or the Uniden Parts Department for a replacement battery.

**Warning:** To avoid the risk of personal injury or property damage from fire or electrical shock, only use the Uniden battery model and Uniden adapter model specifically designated for this product.

#### Power Failure

During the period that the power is off, you will not be able to make or receive calls with the telephone.

#### Caution

- Use only the specified Uniden battery pack (BT-905).
- Do not remove the battery from the handset to charge it.
- Never throw the battery into a fire, disassemble it, or heat it.
- Do not remove or damage the battery casing.

## Maintenance

### When the handset or base unit becomes slightly dirty

Wipe with a soft, dry cloth.

### When the handset or base unit becomes very dirty

Wipe with a soft cloth that has been dampened with diluted, neutral detergent. Dry with a dry cloth.

### When the charging terminals become very dirty on both the handset and base unit

Use water only, dampen a cloth to clean the charging terminals. Then make sure to go back over the charging terminals with a dry cloth before returning the handset to the base unit to charge.

#### Caution

Do not use paint thinner, benzene, alcohol, or other chemical products. Doing so may discolor the surface of the telephone and damage the finish.



## Troubleshooting

If your phone is not performing to your expectations, please try these simple steps first.

Symptom	Suggestion
The <b>charge/in use</b> LED won't illuminate when the handset is placed in the base.	<ul style="list-style-type: none"> <li>• Make sure the AC adapter is plugged into the base and wall outlet.</li> <li>• Make sure the handset is properly seated in the base.</li> <li>• Make sure the charging contacts on the handset and base are clean.</li> </ul>
The audio sounds weak and/or scratchy.	<ul style="list-style-type: none"> <li>• Make sure that the base antenna is in a vertical position.</li> <li>• Move the handset and/or base to a different location away from metal objects or appliances and try again.</li> <li>• Press <b>channel</b> in the Talk mode to help eliminate background noise.</li> <li>• Make sure that the handset is not too far from the base.</li> </ul>
Can't make or receive calls.	<ul style="list-style-type: none"> <li>• Check both ends of the telephone line cord.</li> <li>• Make sure the AC adapter is plugged into the base and wall outlet.</li> <li>• Disconnect the AC adapter for a few minutes, then reconnect it.</li> <li>• Change the digital security code (See page 37).</li> <li>• Make sure that the handset is not too far from the base.</li> </ul>

<b>Symptom</b>	<b>Suggestion</b>
The handset doesn't ring or receive a page.	<ul style="list-style-type: none"> <li>• The battery pack may be weak. Charge the battery for 15-20 hours.</li> <li>• The handset may be too far from the base unit.</li> <li>• Place the base unit away from appliances or metal objects.</li> <li>• Change the digital security code (See page 37).</li> </ul>
Severe noise interference.	<ul style="list-style-type: none"> <li>• Keep the handset away from microwave ovens, computers, remote control toys, wireless microphones, alarm systems, intercoms, room monitors, fluorescent lights, and electrical appliances.</li> <li>• Move to another location or turn off the source of interference.</li> </ul>
The answering system does not work.	<ul style="list-style-type: none"> <li>• Make sure the base unit is plugged in.</li> <li>• Make sure the answering system is turned on.</li> </ul>
The answering system does not answer calls.	<ul style="list-style-type: none"> <li>• Set the record time to either the one minute or four minute option.</li> <li>• The memory may be full. Delete some or all of the saved messages.</li> </ul>
Messages are incomplete.	<ul style="list-style-type: none"> <li>• The incoming messages may be too long. Remind callers to leave a brief message.</li> <li>• The memory may be full. Delete some or all of the saved messages.</li> </ul>
After a power failure, the outgoing message is deleted.	<ul style="list-style-type: none"> <li>• Record your personal outgoing message again. The default message should remain.</li> </ul>

<b>Symptom</b>	<b>Suggestion</b>
No sound on the base unit speaker during call monitoring or message playback.	<ul style="list-style-type: none"><li>• Adjust the speaker volume on the base unit.</li></ul>
Cannot access remote call-in features from another touch-tone phone.	<ul style="list-style-type: none"><li>• Make sure you're using the correct PIN code.</li><li>• Make sure that the touch-tone phone you're using can transmit the tone for at least two seconds. If it cannot, you may have to use another phone to access your messages.</li></ul>
If you still have a problem, outgoing message is deleted.	<ul style="list-style-type: none"><li>• Call our customer hotline at 1-800-297-1023.</li></ul>

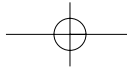

## Liquid Damage

Moisture and liquid can damage your cordless phone. In case of accidental submersion, please read the following steps.

Case	Action
If the handset or base is exposed to moisture or liquid, but only affects the exterior plastic housing.	Wipe off the liquid and use as normal.
If moisture or liquid has entered the plastic-housing (i.e. liquid can be heard in the phone or liquid has entered the battery compartment).	<ol style="list-style-type: none"> <li>1. Remove the battery cover of the handset and leave it off for ventilation.</li> <li>2. Remove the battery pack by disconnecting.</li> <li>3. Leave the battery cover off and the battery pack disconnected for 3 days for maximum drying time.</li> <li>4. Once completely dry, reconnect the battery pack and the battery cover.</li> <li>5. Recharge the handset's battery pack for 20 hours in the base unit before using the phone.</li> </ol> <p><b>IMPORTANT:</b> You must <b>unplug the telephone line while recharging the battery pack</b> to avoid charge interruption.</p>
If the base unit or the handset is submerged or covered in a sticky substance, such as juice.	<p>Handset:</p> <ol style="list-style-type: none"> <li>1. Remove the battery cover of the handset and the battery pack by disconnecting.</li> <li>2. Rinse the handset in warm distilled water.</li> <li>3. Let dry for at least 3 days.</li> <li>4. Once completely dry, reconnect the battery pack and the battery cover.</li> <li>5. Recharge the handset's battery pack for 20 hours in the base unit before using the phone.</li> </ol> <p>Base:</p> <ol style="list-style-type: none"> <li>1. Disconnect the AC adapter from the base unit, ending power supply.</li> <li>2. Disconnect the telephone cord from the base unit.</li> <li>3. Rinse the base in warm distilled water.</li> <li>4. Let dry for at least 3 days.</li> </ol> <p><b>CAUTION:</b> DO NOT use a microwave oven to speed up the drying time. This will cause permanent damage to the handset and the microwave oven.</p>

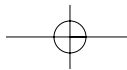

## General Information

The phone complies with FCC Parts 15 and 68.  
Operating temperature: 0° to 50°C (+32°F to +122°F)

### AC Adapter Information

AC Adapter part number: AD-314  
Input Voltage: 120V AC 60Hz  
Output Voltage: 9V AC 350 mA

### Battery Information

Battery part number: BT-905  
Capacity: 600 mA<sub>H</sub>, 3.6V  
Battery use time (per charge)  
From fully charged  
Talk mode duration: 7 hours  
Standby mode duration: 14 days



If the handset is left off of the base, the actual Talk mode duration will be reduced respective to the amount of time the handset is off the base.

Recharge your phone on a regular basis by returning the handset to the base after each phone call. When the operating time becomes short, even after the battery is recharged, please replace the battery. With normal usage, the battery should last about one year.

A replacement Uniden adapter and battery may be purchased at your local Uniden dealer or by contacting the Uniden Parts Department (800) 554-3988. Hours are from 7:00 a.m. to 5:00 p.m. Central Time, Monday through Friday. We can also be reached on the web at [www.uniden.com](http://www.uniden.com).

Specifications, features, and availability of optional accessories are all subject to change without prior notice.

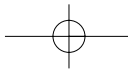

## Precautions!

Before you read anything else, please observe the following:

### Warning!

Uniden America Corporation DOES NOT represent this unit to be waterproof. To reduce the risk of fire, electrical shock, or damage to the unit, DO NOT expose this unit to rain or moisture.

### Rechargeable Nickel-Cadmium Battery Warning

- This equipment contains a rechargeable nickel-cadmium battery.
- Cadmium is a chemical known to the State of California to cause cancer.
- The rechargeable nickel-cadmium battery contained in this equipment may explode if disposed of in a fire.
- Do not short-circuit the battery.
- Do not charge the rechargeable nickel-cadmium battery used in this equipment in any charger other than the one designed to charge this battery as specified in the owner's manual. Using another charger may damage the battery or cause the battery to explode.

## Rechargeable Nickel-Cadmium Batteries Must Be Recycled or Disposed of Properly



- Uniden voluntarily participates in an RBRC® industry program to collect and recycle nickel-cadmium batteries at the end of their useful life, when taken out of service within the United States. The RBRC® program provides a convenient alternative to placing used nickel-cadmium batteries into the trash or municipal waste stream, which is illegal in some areas.
- Through the RBRC® program, Uniden makes it easy for you to drop off the used battery at local retailers of replacement nickel-cadmium batteries. You may also contact your local recycling center for information on where to return the used battery. Please call 1-800-8-BATTERY for information on Ni-Cd battery recycling in your area. Uniden's involvement in this program is part of its commitment to protecting our environment and conserving natural resources.
- RBRC® is a registered trademark of the Rechargeable Battery Recycling Corporation.



The exclamation point within an equilateral triangle is intended to alert the user to the presence of important operating and maintenance (servicing) instructions in the literature accompanying the appliance.

## Important Safety Instructions

When using your telephone equipment, these basic safety precautions should always be followed to reduce the risk of fire, electrical shock, and injury to persons:

1. Read and understand all instructions.
2. Follow all warnings and instructions marked on the product.
3. Unplug this product from the wall outlet before cleaning. Use a dry cloth for cleaning without liquid or aerosol cleaners.
4. Do not use this product near water; for example, near a bathtub, wash bowl, kitchen sink or laundry tub, in a wet basement, or near a swimming pool.
5. Do not place this product on an unstable cart, stand, or table. The telephone may fall, causing serious damage to the unit.
6. Slots and openings in the cabinet and the back or bottom are provided for ventilation. To protect the product from overheating, these openings must not be blocked or covered. This product should never be placed near or over a radiator or heat register. This product should not be placed in a built-in installation unless proper ventilation is provided.
7. This product should be operated only from the type of power source indicated on the marking label. If you are not sure of the type of power supply to your home, consult your dealer or local power company.
8. Do not allow anything to rest on the power cord. Do not locate this product where the cord will be damaged by persons walking on it.
9. Do not overload wall outlets and extension cords, as this can result in the risk of fire or electrical shock.
10. Never push objects of any kind into this product through cabinet slots, as they may touch dangerous voltage points or short out parts that could result in a risk of fire or electric shock. Never spill liquid of any kind on the product.
11. To reduce the risk of electric shock, do not disassemble this product. Take it to qualified service personnel when service or repair work is required. Opening or removing covers may expose you to dangerous voltages or other risks. Incorrect reassembly can cause electric shock when the appliance is subsequently used.
12. Unplug this product from the wall outlet and refer servicing to qualified service personnel under the following conditions:
  - A. When the power supply cord is damaged or frayed.
  - B. If liquid has been spilled into the product.
  - C. If the product has been exposed to rain or water.
  - D. If the product does not operate normally when following the operating instructions. (Adjust only those controls that are covered by the operating instructions. Improper adjustment of other controls may result in damage and will often require extensive repair work by a qualified technician.)
  - E. If the product has been dropped or the cabinet has been damaged.
  - F. If the product exhibits a distinct change in performance.
13. Do not use the telephone to report a gas leak in the vicinity of the leak.

### Additional Battery Safety Precautions

**Caution!** To reduce the risk of fire or injury to persons by the battery, read and follow these instructions:

1. Use only the Uniden battery pack specified in the owner's manual.

2. Do not dispose of the battery pack in a fire. The cell may explode. Check the nickel-cadmium battery disposal package insert for disposal instructions.
3. Do not open or mutilate the battery pack. Released electrolyte is corrosive and may cause damage to the eyes or skin. It may be toxic if swallowed.
4. Exercise care in handling the battery in order not to short the battery with conducting materials such as rings, bracelets, and keys. The battery or conductor may overheat and cause burns.
5. Charge the battery pack provided with or identified for use with this product only in accordance with the instructions and limitations specified in the owner's manual provided for this product.
6. Observe proper polarity orientation between the battery pack and battery charger.

**SAVE THESE INSTRUCTIONS!**

## Important Electrical Considerations

Unplug all electrical appliances when you know an electrical storm is approaching. Lightning can pass through your household wiring and damage any device connected to it. This phone is no exception.

### Warning!

Please do not attempt to unplug any appliance during an electrical storm.

### The FCC Wants You To Know

Changes or modifications to this product not expressly approved by Uniden, or operation of this product in any way other than as detailed by the owner's manual, could void your authority to operate this product. The equipment cannot be used on public coin phone service provided by the telephone company. Connection to party line service is subject to state tariffs. (Contact the state public utility commission, public service commission or corporation commission for information.)

### Range

Your new phone is designed to achieve the maximum possible range by transmitting and receiving according to the highest specifications set forth by the FCC. We have rated this phone to operate at a maximum distance with the qualification that the range depends upon the environment in which the telephone is used. Many factors limit range, and it would be impossible to include all the variables in our rating. The Maximum Range rating of this phone is meant to be used as a means of comparison against other range claims.

### Telephone Line Problems

The FCC has granted the telephone company the right to disconnect service in the event that your phone causes problems on the telephone line. Also, the telephone company may make changes in facilities and services which may affect the operation of your unit. However, your telephone company must give adequate notice in writing prior to such actions to allow you time for making necessary arrangements to continue uninterrupted service.

If you are having trouble with your telephone service, you must first disconnect your phone to determine if it is the cause of your problem. If you determine that it is the cause, you must leave it disconnected until the trouble has been corrected.

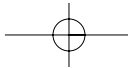

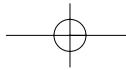

## Radio Interference

Radio interference may occasionally cause buzzing and humming in your cordless handset, or clicking noises in the base. This interference is caused by external sources such as TV, refrigerator, vacuum cleaner, fluorescent lighting, or electrical storm. Your unit is NOT DEFECTIVE. If these noises continue and are too distracting, please check around your home to see what appliances may be causing the problem. In addition, we recommend that the base not be plugged into a circuit that also powers a major appliance because of the potential for interference. Be certain that the antenna on the unit is fully extended when needed. In the unlikely event that you consistently hear other voices or distracting transmissions on your phone, you may be receiving radio signals from another cordless telephone or other source of interference. If you cannot eliminate this type of interference, you need to change to a different channel.

Finally, it should be noted that some cordless telephones operate at frequencies that may cause interference to nearby TVs and VCRs. To minimize or prevent such interference, the base of the cordless telephone should not be placed near or on top of a TV or VCR. If interference is experienced, moving the cordless telephone farther away from the TV or VCR will often reduce or eliminate the interference.

## More Than One Cordless Telephone

If you want to use more than one cordless telephone in your home, they must operate on different channels. Press the channel key to select a channel that provides the clearest communication.

## Cordless Telephone Privacy

Cordless telephones are radio devices. Communications between the handset and base of your cordless telephone are accomplished by means of radio waves which are broadcast over the open airways. Because of the inherent physical properties of radio waves, your communications can be received by radio receiving devices other than your own cordless telephone unit. Consequently, any communications using your cordless telephone may not be private.

## Installation Considerations

### Selecting a Location

Before choosing a location for your new phone, there are some important guidelines you should consider:

- The location should be close to both a phone jack and continuous power outlet. (A continuous power outlet is an AC outlet which does not have a switch to interrupt its power.)
- Keep the base and handset away from sources of electrical noise such as motors or fluorescent lighting.
- Be sure there is sufficient space to fully extend the base antenna.
- The base can be placed on a desk or tabletop or mounted on a standard telephone wall plate.
- You should charge your new phone for 15-20 hours before completing the installation or using the handset.

www.uniden.com

## Telephone Line Outlets

There are two types of phone outlets:

### Modular Jack

Most phone equipment available now uses modular jacks. Phone cords are fitted with a molded plastic connector which plugs into this type of jack. If you do not have modular phone jacks, contact your local telephone company for information about their installation.

### Hardwired Jack

Some equipment is wired directly to a phone jack, and these types of installations require a modular jack converter. This type of installation is not difficult; however, you should contact your Uniden telephone dealer or a telephone supply store for advice about the proper adapter or converter for your particular situation.

## Connecting the Telephone Cords

Consider these safety guidelines before connecting the telephone cords:

### Caution!

- Never install telephone wiring during a lightning storm.
- Never touch uninsulated telephone wires or terminals unless the telephone line has been disconnected.
- Use caution when installing or modifying telephone lines.

## Applying Power to the Base

This phone requires an AC outlet, without a switch to interrupt power, and the included AC adapter. To relieve strain on the DC plug when the phone is placed on a desk or table, wrap the power cord around the strain relief notch on the bottom of the base.

**NOTE:** Place the power cord so that it does not create a trip hazard, or where it could become chafed and create a fire or other electrical hazards.

## Adapter Safety Features

Do not use an outlet controlled by a wall switch.



Use only the Uniden AC Adapter supplied with this phone.

## One Year Limited Warranty

**Important:** Evidence of original purchase is required for warranty service.

WARRANTOR: UNIDEN AMERICA CORPORATION ("Uniden")

ELEMENTS OF WARRANTY: Uniden warrants, for one year, to the original retail owner, this Uniden Product to be free from defects in materials and craftsmanship with only the limitations or exclusions set out below.

**WARRANTY DURATION:** This warranty to the original user shall terminate and be of no further effect 12 months after the date of original retail sale. The warranty is invalid if the Product is (A) damaged or not maintained as reasonable or necessary, (B) modified, altered, or used as part of any conversion kits, subassemblies, or any configurations not sold by Uniden, (C) improperly installed, (D) serviced or repaired by someone other than an authorized Uniden service center for a defect or malfunction covered by this warranty, (E) used in any conjunction with equipment or parts or as part of any system not manufactured by Uniden, or (F) installed or programmed by anyone other than as detailed by the owner's manual for this product.

**STATEMENT OF REMEDY:** In the event that the product does not conform to this warranty at any time while this warranty is in effect, warrantor will either, at its option, repair or replace the defective unit and return it to you without charge for parts, service, or any other cost (except shipping and handling) incurred by warrantor or its representatives in connection with the performance of this warranty. Warrantor, at its option, may replace the unit with a new or refurbished unit. THE LIMITED WARRANTY SET FORTH ABOVE IS THE SOLE AND ENTIRE WARRANTY PERTAINING TO THE PRODUCT AND IS IN LIEU OF AND EXCLUDES ALL OTHER WARRANTIES OF ANY NATURE WHATSOEVER, WHETHER EXPRESS, IMPLIED OR ARISING BY OPERATION OF LAW, INCLUDING, BUT NOT LIMITED TO ANY IMPLIED WARRANTIES OF MERCHANTABILITY OR FITNESS FOR A PARTICULAR PURPOSE. THIS WARRANTY DOES NOT COVER OR PROVIDE FOR THE REIMBURSEMENT OR PAYMENT OF INCIDENTAL OR CONSEQUENTIAL DAMAGES. Some states do not allow this exclusion or limitation of incidental or consequential damages so the above limitation or exclusion may not apply to you.

**LEGAL REMEDIES:** This warranty gives you specific legal rights, and you may also have other rights which vary from state to state. This warranty is void outside the United States of America.

**PROCEDURE FOR OBTAINING PERFORMANCE OF WARRANTY:** If, after following the instructions in the owner's manual you are certain that the Product is defective, pack the Product carefully (preferably in its original packaging). The Product should include all parts and accessories originally packaged with the Product. Include evidence of original purchase and a note describing the defect that has caused you to return it. The Product should be shipped freight prepaid, by traceable means, to warrantor at:

**Uniden America Corporation**  
Parts and Service Division  
4700 Amon Carter Blvd.  
Fort Worth, TX 76155

(800) 297-1023, 8 a.m. to 5 p.m. Central, Monday through Friday

ADDITIONAL INFORMATION

ADDITIONAL INFORMATION [ 45 ]

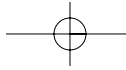

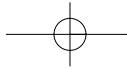

## I.C. Notice

### TERMINAL EQUIPMENT

**NOTICE:** This equipment meets the applicable Industry Canada Terminal Equipment Technical Specifications. This is confirmed by the registration number. The abbreviation, IC, before the registration number signifies that registration was performed based on a Declaration of Conformity indicating that Industry Canada technical specifications were met. It does not imply that Industry Canada approved the equipment.

**NOTICE:** The Ringer Equivalence Number (REN) for this terminal equipment is marked on the equipment itself. The REN assigned to each terminal equipment provides an indication of the maximum number of terminals allowed to be connected to a telephone interface. The termination on an interface may consist of any combination of devices subject only to the requirement that the sum of the Ringer Equivalence Numbers of all the devices does not exceed five.

### RADIO EQUIPMENT

The term "IC:" before the radio certification number only signifies that Industry Canada technical specifications were met.

Operation is subject to the following two conditions: (1) this device may not cause interference, and (2) this device must accept any interference, including interference that may cause undesired operation of the device. "Privacy of communications may not be ensured when using this telephone".

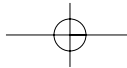



<b>A</b>	Controls and Functions .....	4	Quick reference guide .....	2
AC adapter information .....			<b>R</b>	
Announce only feature .....			Receiving a call .....	16
Answering system	<b>D</b>		Recording time .....	41
Deleting a message .....	Dial mode .....	15	Redial .....	18
Playing a message .....	Digital security code .....	51	Remote access .....	49
Recording a conversation .....	<b>E, F, G, H, I, J, K, L</b>		Repeating .....	46
Remote access .....	Earpiece volume .....	17	Ringer volume	
Repeating a message .....	Flash .....	19	Base .....	44
Skipping a message .....	General information		Handset .....	17
Turning on/off .....	(Specification) .....	57	Ring time .....	40
<b>B</b>	Greeting .....	43	Rocket Dial .....	28
Base location .....	Headset installation .....	51	<b>S</b>	
Battery pack	I.C. Notice .....	60	Setting Menu Options .....	13
Information .....	Interference .....	19	Setting up the Phone .....	7
Installing .....	Liquid Damage .....	56	Storing phone number .....	20
Preparing and charging .....	<b>M, N, O, P, Q</b>		<b>T, U</b>	
Replacement and handling .....	Maintenance .....	52	Tone .....	18
Beltclip installation .....	Making a call .....	16	Traveling out-of-range .....	18
<b>C</b>	Memory dialing		Troubleshooting .....	53
Caller ID	Editing a stored name and		<b>V, W, X, Y, Z</b>	
Caller ID service .....	phone number .....	25	Voice memo .....	48
Call Waiting .....	Erasing a stored name and		Volume control .....	17
Deleting .....	phone number .....	27	Wall mounting .....	11
Setting Caller ID options .....	Making calls with memory		Warranty .....	59
Using .....	dialing .....	23		
Viewing .....	Storing phone numbers and			
Call waiting .....	names .....	20		
Chain dialing .....	Menu mode .....	37		
Channel .....	Message alert .....	42		
Charging the battery pack .....	Outgoing message .....	43		
Cleaning Battery Contacts .....	Package contents .....	6		
Clock .....	Page .....	19		
Connect the base unit .....	Personal Security Code (PIN code) .....	39		
	Precautions .....	58		

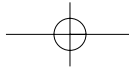

# MEMO

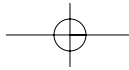
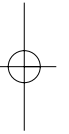
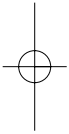

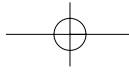

# MEMO

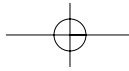
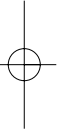
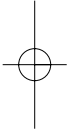

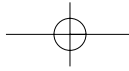

# MEMO

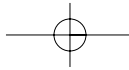
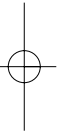
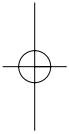

# Remote Operation Card

## REMOTE OPERATION CARD

**Uniden**  
EXA3245 series

### Remote access away from home

1. Call your phone number from a touch-tone phone.
2. During the outgoing message, press 0 and enter your PIN code. The answering system announces the number of messages stored in memory and the help guidance. The phone stands by for you to enter a command.
3. To quit, hang up the phone.

### Turn on the answering system remotely

1. Call your phone and let it ring 10 times until it answers.
2. Enter your PIN code.
3. Press 0 then 5 to stop the announcement.
4. Press 0 then 6 to turn the answering system on.

## MEMORY LOCATION MEMO

\* Memory 1 is reserved for RocketDial.

Memory Location	Name	Phone Number
1*		
2		
3		
4		
5		

## REMOTE OPERATION CARD

**Uniden**  
EXA3245 series

### Remote access away from home

1. Call your phone number from a touch-tone phone.
2. During the outgoing message, press 0 and enter your PIN code. The answering system announces the number of messages stored in memory and the help guidance. The phone stands by for you to enter a command.
3. To quit, hang up the phone.

### Turn on the answering system remotely

1. Call your phone and let it ring 10 times until it answers.
2. Enter your PIN code.
3. Press 0 then 5 to stop the announcement.
4. Press 0 then 6 to turn the answering system on.

## MEMORY LOCATION MEMO

\* Memory 1 is reserved for RocketDial.

Memory Location	Name	Phone Number
1*		
2		
3		
4		
5		

# Remote Operation Card

C U T C U T

## MEMORY LOCATION MEMO

Memory Location	Name	Phone Number
6		
7		
8		
9		
10		

Task	Key
Repeat a Message	0 1
Playing Incoming Messages	0 2
Skipping a Message	0 3
Deleting a Message	0 4
Stop Operation	0 5
Answering System On	0 6
Memo Record/Stop	0 7
Greeting Message Record/Stop	0 8
Answer System Off	0 9
Help Guidance	1 0

C U T C U T

## MEMORY LOCATION MEMO

Memory Location	Name	Phone Number
6		
7		
8		
9		
10		

Task	Key
Repeat a Message	0 1
Playing Incoming Messages	0 2
Skipping a Message	0 3
Deleting a Message	0 4
Stop Operation	0 5
Answering System On	0 6
Memo Record/Stop	0 7
Greeting Message Record/Stop	0 8
Answer System Off	0 9
Help Guidance	1 0

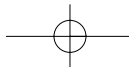

## **At Uniden, we'll take care of you!**

If you need any assistance with this product, please call our Customer Hotline at

**1-800-297-1023**

**PLEASE DO NOT RETURN THIS PRODUCT TO THE PLACE OF PURCHASE.**

Our Uniden representatives will be happy to help you with any matters regarding the operation of this unit, available accessories, or any other related matters.

Thank you for purchasing a Uniden product.  
Hours: M-F 8:00 AM to 5:00 PM CST.



For information on the accessibility features of this product, please call

**1-800-874-9314 (V/TTY)**

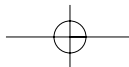



# Uniden®

May be covered under one or more of the following U.S. patents:

4,511,761	4,523,058	4,595,795	4,797,916	5,381,460	5,426,690
5,434,905	5,491,745	5,533,010	5,543,605	5,574,727	5,581,598
5,650,790	5,660,269	5,661,780	5,663,981	5,671,248	5,696,471
5,717,312	5,732,355	5,754,407	5,758,289	5,768,345	5,787,356
5,794,152	5,801,466	5,825,161	5,838,721	5,864,619	5,893,034
5,912,968	5,915,227	5,929,598	5,930,720	5,960,358	5,987,330
6,044,281	6,070,082	6,125,277	6,253,088		

©2003 Uniden America Corporation, Fort Worth, Texas  
Contains additional foreign articles.

Custom manufactured in China.

UPZZ01003ZZ