

Uniden®

ELBT 595

SERIES

OWNER'S

MANUAL

OWNER'S MANUAL

Contents

Welcome/Features/Terminology	3	Making Calls	47
Accessibility	4	From the Handset Speakerphone	48
Controls & Functions	5	From the base	49
Setting up the Phone	7	Receiving a call/AutoTalk set to OFF	49
Choose the best location	7	Hanging Up	50
Power Backup Feature	8	Switching to the Handset Speakerphone During a Call	50
Install the rechargeable battery pack	9	Moving out of range	50
Low battery alert	10	Call Waiting	51
Cleaning the battery charging contacts	10	Placing a Call on Hold	52
Connect the base unit and charge the handset	11	Conferencing	52
Mounting the Base Unit on a Wall	12	Mobile Line Transfer	54
Standard wall plate mounting	12	Redialing Calls	55
Expanding Your Phone	13	Adjusting the Base Ringer and Speaker	56
Backwards/Forwards Compatibility	13	Using the Handset Volume Setting Menu	57
Connect the expansion handset's charger	14	Mute	59
Register the Handset	14	Mute the Handset Microphone	59
Register the ELX500 expansion handset to main base	15	Tone Dialing Switch Over	59
Changing the Digital Security Code	16	Privacy Mode	60
Installing the Holster	16	Find Handset	60
Optional Headset Installation	17	Reminder (Handset only)	61
Installation of PC Application CD-ROM	17	Using the Phonebook	63
Using the Interface	19	Creating and Editing Phonebook Entries	63
Display Icons	20	Storing Caller ID or Redial Numbers in the Phonebook	66
Soft Key Function	21	Managing the Phonebook	66
Entering text	23	Checking the number of stored entries	67
Main Menu Options	24	Changing the sorting order	68
Setup Menu	25	Naming phonebook groups	68
System Setup	25	Making Calls with the Phonebook	68
Global Setup	29	Caller ID Features	70
Setting the Ringer Options	31	Using the Caller ID List	70
Display Setting (Handset Only)	36	Deleting Caller ID numbers	71
Using Bluetooth Feature	39	Answering Machine	72
Registering Your Cellular Phone to Your Phone	39	Features	72
Using Bluetooth headset	43	Setting Up the Answering Machine	73
De-register the Bluetooth Headset	46	Setting Your Outgoing Greeting	76
Using Your Phone	47	Using the Answering Machine	77



Recording a phone conversation	80
Screening Calls	80
Do Not Disturb (DND)	81
Remote Operation	82
Multi-Handset Features	84
Using DirectLink Mode	84
Room/Baby Monitor	85
Intercom	86
Transferring a Call	86
Note on Power Sources	88
Power Failure	88
Battery replacement and handling	88
Warning	88
General Information	89
AC Adapter Information	89
Battery Information	89
Troubleshooting	90
System Reset	92
Liquid Damage	94
Precautions & Warranty	95
I.C. Notice	97
Index	98

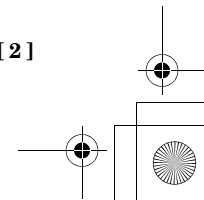
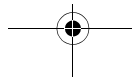
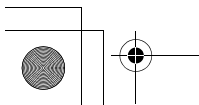
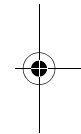
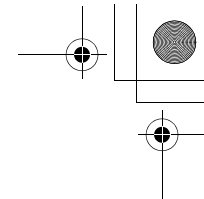
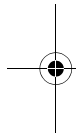

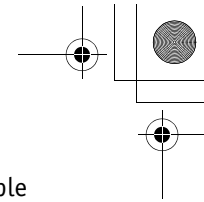
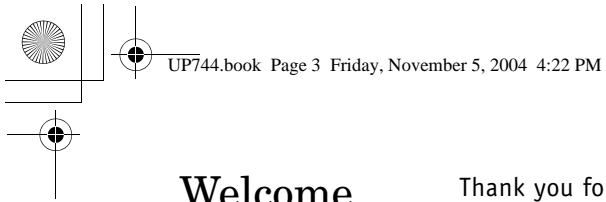

Welcome

Thank you for purchasing a Uniden Multi-Handset phone. This phone is compatible with Bluetooth enabled mobile telephones and headsets, plus USB connection for convenient system setup.

Note: Illustrations in this manual are used for explanation purposes. Some illustrations in this manual may differ from the actual unit.



As an Energy Star™ Partner, Uniden has determined that this product or product models meets the Energy Star™ guidelines for energy efficiency. Energy Star™ is a U.S. registered mark.



Features

- 5.8GHz Direct Spread Spectrum
- Full Color Backlit Display
- Integrated Answering Device
- Caller ID/Call Waiting Deluxe Options
- Compatible with Bluetooth Enabled Mobile Handset/Headsets
- USB Cable/CD-Rom included for System Setup
- 100 Programmable Phonebook Names with 400 Numbers
- Recordable Ringer Tones
- Battery Backup During Power Failure
- Calendar w/Programmable Reminders

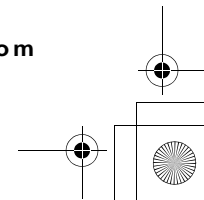
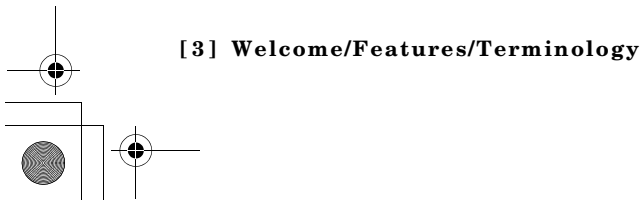
Uniden™ is a registered trademark of Uniden America Corporation. AutoStandby, DirectLink, IntegriSound and Random Code are trademarks of Uniden America.



Terminology

- **Standby Mode** - The handset maybe sitting on or off the cradle, but is NOT in use. *talk/flash* or  key (or the LAND or MOBILE soft key) has not been pressed. No dial tone is present.
- **Talk Mode** - The handset is not in the cradle, and *talk/flash* or  key has been pressed and enabling a dial tone.

Accessibility

Uniden provides a customer service hotline for accessibility questions. If you have a disability and need customer service assistance or if you have any questions about how Uniden's products can accommodate persons with disabilities, please call the accessibility voice/TTY line:

1-800-874-9314

A representative is available to talk to you M-F, 8:00 am to 5:00 pm, CST. After hours, you can leave us a message, and we will call you back. Information is also available on our website, www.uniden.com, under the "Accessibility" link.

Controls & Functions

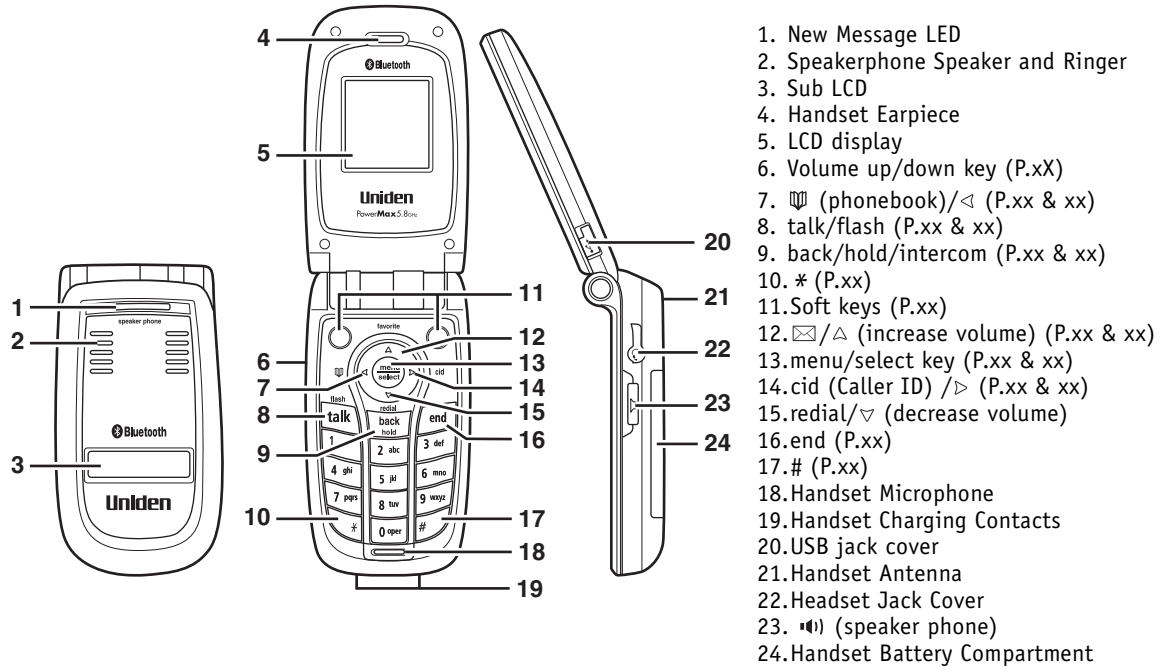

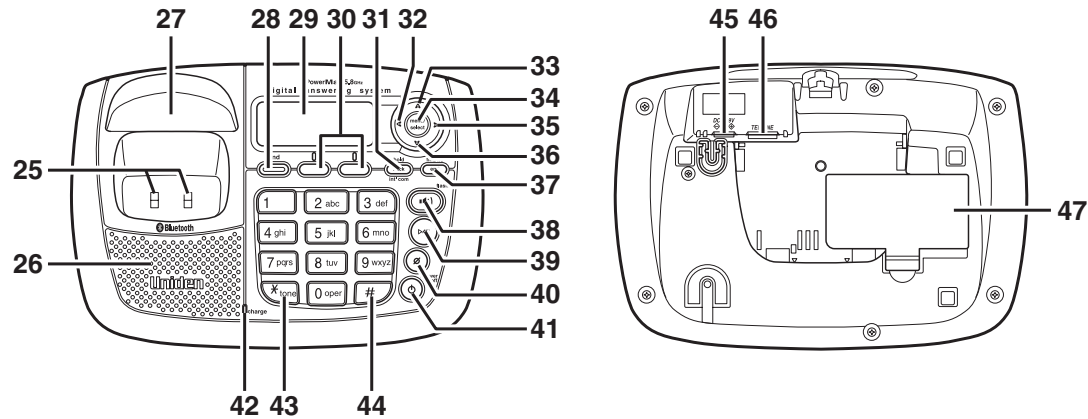

- | | | |
|---------------------------------------|-----------------------------------|------------------------------|
| 25. Base Charge Contacts | 34. menu/select (P.xx & xx) | 43. */tone (P.xx & xx) |
| 26. Base Speaker | 35. cid (Caller ID)/▷ (P.xx & xx) | 44. # (P.xx) |
| 27. Base Antenna | 36. Volume down (P.xx) | 45. DC IN 9V Jack |
| 28. dnd key (P.xx) | 37. end/find HS (P.xx & xx) | 46. TEL LINE Jack |
| 29. LCD Display | 38. 🔊 (speaker)/flash (P.xx & xx) | 47. Base Battery Compartment |
| 30. Soft keys (P.xx) | 39. ▶◻ (play/stop) (P.xx & xx) | |
| 31. back/hold/intercom (P.xx xx & xx) | 40. ⌀ (delete) (P.xx) | |
| 32. Phonebook/◀ key (P.xx & xx) | 41. ⓪ answer on/off (P.xx) | |
| 33. Volume up (P.xx) | 42. Handset Charge LED | |

Setting up the Phone

Choose the best location

When choosing a location for your new phone, here are some important guidelines you should consider:

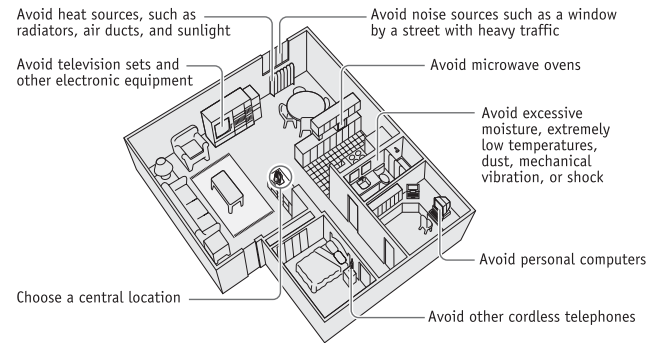

- The location should be close to both a phone jack and a continuous power outlet (one which is not connected to a switch).
- The base and handset should be kept away from sources of electrical noise such as motors, Microwave ovens, and fluorescent lighting.
- For better reception, place the base as high as possible.
- The base should be placed in an open area for optimum range and reception.
- If your home has specially wired alarm equipment connected to phone line, be sure that installing the system does not disable your alarm equipment.
- If you have questions about what will disable alarm equipment, contact your telephone company or a qualified installer.
- The base should be placed in an open area for optimum range and reception.

[7] Setting up the Phone



For maximum range:

- Do not hold the handset where you would block the signal.

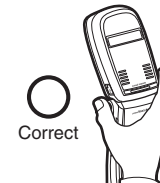

- Metal and reinforced concrete may affect cordless telephone performance.

www.uniden.com

note

-  appears if the battery pack is not installed in the base.
- To use power backup feature, you need to connect the AC adapter to the base, and charge the base battery at least for 24 hours.

www.uniden.com

Power Backup Feature

The phone uses the power backup feature to provide power backup for a power failure or outage.

Install the power backup battery in the base

- 1) Open the battery case cover by pressing the release button on the bottom of the base as shown.
- 2) Plug the battery connector (red and black wires) into the jack inside the battery compartment. (The connector notches fit into the grooves of the jack only one way). Match the wire colors to the polarity label in the battery compartment, connect the battery and listen for a click to insure connection.
- 3) Make sure you have a good connection by gently pulling on the battery wires. If the connection is secure, the battery jack will remain in place.
- 4) Place the battery case cover back on the base.
- 5) Align the tabs on the cover with the grooves on the base, and press down the cover until it clicks into place.

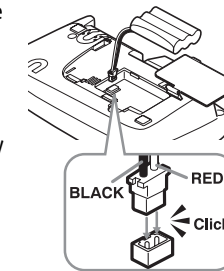
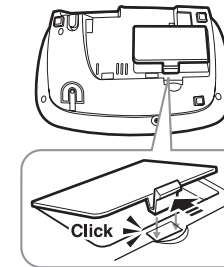

Setting up the Phone [8]

Setting up the Phone

Install the rechargeable battery pack

Follow the steps below if you need to install a battery.

- 1) Press down on the handset battery case cover (use the finger indention for a better grip) and slide the cover downward to remove.
- 2) Place the battery pack in the battery compartment with the connectors on the battery and the on the compartment aligned.
- 3) Place the battery case cover back on the handset and slide it upwards until it clicks into place.

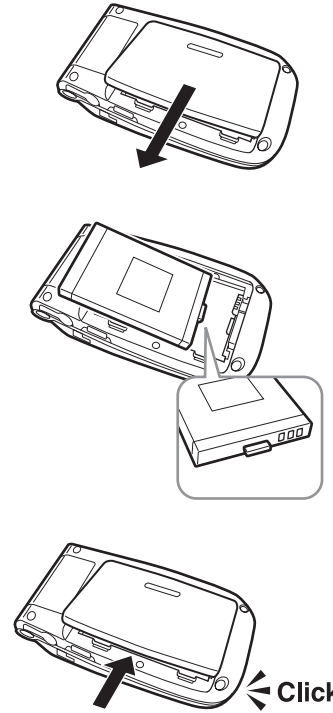

Use only the Uniden (BT-0002) rechargeable battery pack supplied with your cordless telephone.

note

- Even when the battery pack is not being used, it will gradually discharge over a long period of time.
- For optimum performance, be sure to return the handset to the cradle after each telephone call.
- If the handset is left off of the base, the actual Talk mode duration will be reduced respective to the amount of time the handset is off the cradle.

www.uniden.com

Low battery alert

When the battery pack is very low, the phone is programmed to eliminate functions in order to save power.

The battery pack needs to be charged when:

- The empty battery icon appears.
- Low Battery appears in the display.

If the phone is in standby mode, none of keys will operate. If you are on a call, complete your conversation as quickly as possible, and return the handset to the cradle.

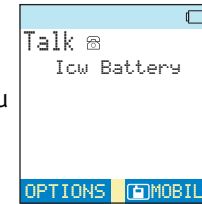

Cleaning the battery charging contacts

To maintain a good charge, clean the charging contacts on the handset once a month. Dampen a cloth with plain water. Gently rub the damp cloth over the charging contacts until all visible dirt is removed. Dry the contacts thoroughly before returning the handset to the cradle.

Caution: Do not use paint thinner, benzene, alcohol, or other chemical products. Doing so may discolor the surface of the telephone and damage the finish.

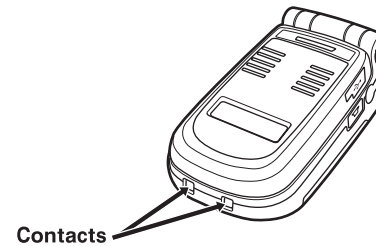

Setting up the Phone [10]

Setting up the Phone

Connect the base unit and charge the handset

- 1) Connect the AC adapter to the **DC IN 9V** jack and to a standard 120V AC wall outlet.
Connect the AC adapter to a continuous power supply (i.e., an outlet that is not controlled by a switch).

Place the base unit close to the AC outlet to avoid long extension cords.

- 2) Place the handset in the base unit with the keypad facing forward.
Connect the AC adapter to a continuous power supply (i.e., an outlet that is not controlled by a switch).

Place the base unit close to the AC outlet to avoid long extension cords.

- 3) Make sure that the **charge** LED illuminates.
If the LED does not illuminate, check to see that the AC adapter is plugged in and the handset makes good contact with the base charging contacts.
- 4) Charge your handset at least **15-20 hours before plugging into the phone line.**
- 5) Once the handset battery pack is fully charged, connect the telephone line cords to the **TEL LINE** jack and to a telephone outlets.

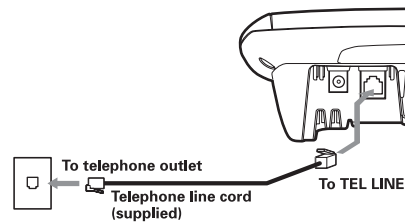
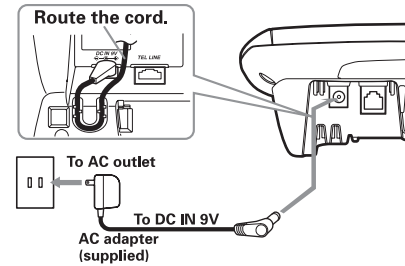

note

- Use only the supplied **AD-0009 AC adapter**. Do not use any other AC adapter.
 - Do not place the power cord where it creates a trip hazard or where it could become chafed and create a fire or electrical hazard.
 - Don't place the base in direct sunlight or subject it to high temperatures. The battery may not charge properly.
- for assistance.

tip

If your telephone outlet isn't modular, contact your telephone company.



DO NOT use an AC outlet controlled by a wall switch.

Mounting the Base Unit on a Wall

Standard wall plate mounting

This phone can be mounted on any standard wall plate.

- 1) Snap the wall mount adapter into the notches on the base top.
- 2) Plug the AC adapter into the DC IN 9V jack.
- 3) Wrap the AC adapter cord inside the molded wiring channel as shown.
- 4) Plug the AC adapter into a standard 120V AC wall outlet.
- 5) Plug the telephone line cord into the TEL LINE jack.
Wrap the cord inside the molded wiring channel as shown.
- 6) Plug the telephone line cord into the telephone outlet.
- 7) Raise the antenna to a vertical position.
- 8) Align the mounting slots on the base with the mounting posts on the wall. Then push in and down until the phone is firmly seated.

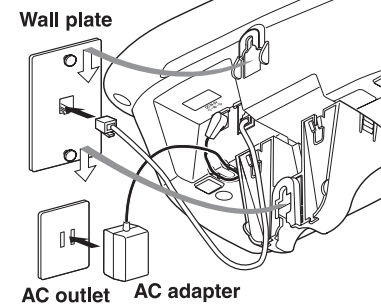
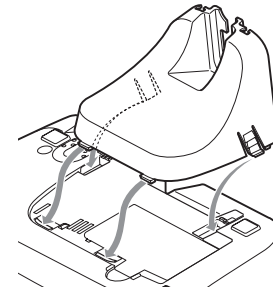

www.uniden.com

Mounting the Base Unit on a Wall [12]

Mounting the Base Unit on a Wall

Expanding Your Phone

Your phone can support a total of ten handsets. Expansion handsets do not need to be connected to a phone jack. Expansion handsets allow you to use additional features such as DirectLink Mode and up to 5-way conference calling. Expansion handsets need to be registered to the base before they will operate.

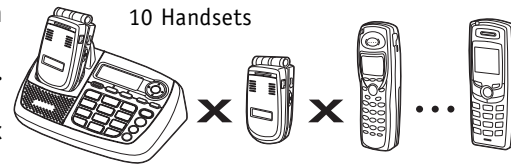

Backwards/Forwards Compatibility

Your phone is compatible with other Uniden 5.8GHz Digital Expandable Handsets. Compatible models include the TCX800, TCX860, and ELX500. Visit our website for updated model listings and feature compatibility information.



- Some of this model's advanced features may not be supported by older handsets (such as the TCX800 and the TCX860).
- If you have any trouble with your phone or if you need a part or accessory, call our Customer Hotline at 1-800-297-1023 (Mon - Fri 7 am to 7pm, Sat/Sun/holidays -- except US Thanksgiving and Christmas --9 am to 5 pm, CST) or visit our web site at www.uniden.com.

note

•Use only the supplied AD-xxxx AC adapter. Do not use any other AC adapter.

•Your phone maybe compatible with other Uniden 5.8Ghz Digital Expandable Systems. Look for the technology icon on our boxes or visit our website for a list of compatible models.

www.uniden.com

Connect the expansion handset's charger

The handset is powered by a rechargeable battery pack. The battery recharges automatically when the handset is placed in the charger.

- 1) Connect the AC adapter to the DC IN 9V jack and to a standard 120V AC wall outlet.
- 2) Set the charger on a desk or tabletop, and place the handset in the charger with the top panel facing forward.
- 3) Make sure that the **charge** LED illuminates. If the LED does not illuminate, check to see that the AC adapter is plugged in and the handset makes good contact with the base charging contacts.
- 4) Charge the handset battery pack for at least 15-20 hours before using your new cordless telephone for the first time.

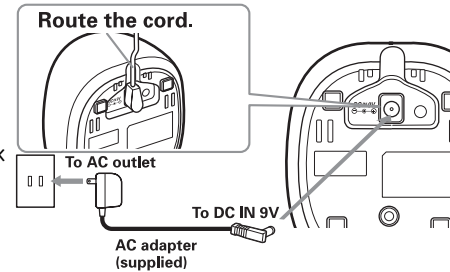

Register the Handset

Handsets supplied with the phone are registered to the base by the factory. When charged, pre-registered handsets display a handset ID number. Handsets that have not been registered display **MUST** place the handset in base to register! Models may vary, refer to owners manual for guidance in the LCD, and Handset must be registered in the sub LCD. When you register an extra handset to the base, the handset ID will be assigned. Only one handset can be registered at a time.

Register the ELX500 expansion handset to main base

Before registering the extra handset, the battery pack MUST be charged for 15-20 hours.

To ELBT5 series base

- 1) From the base, press the MENU soft key, and select System Setup menu.
- 2) Select Register Handset, and press *menu/select*.
- 3) On the handset, press and hold # until you hear beep.



To ELT5 series base

- 1) Press and hold the **Registration** button on the back of the base.
- 2) Keep pressing the Registration button on the base until all LEDs on main base start to blink.
- 3) On the handset, press and hold # until you hear beep.
- 4) While the handset is registering, Handset Registering will appear in the LCD. When Registration Complete is displayed, the handset has been registered to the base. If Registration Failed appears, please try these steps again.

Register the TCX800 and TCX860 Backward/Forward Compatible Handsets to main base

To register the TCX800 or TCX860 handset, do the following steps of "To ELBT5 series base" above.

- 1) Press and hold the **Registration** button on the back of the base.
- 2) Keep pressing the Registration button on the base until all LEDs on main base start to blink.
- 3) On the handset, press and hold # until you hear beep.

note

You must remove the holster to charge the handset.

www.uniden.com

Changing the Digital Security Code

The digital security code is an identification code used to connect the handset and the base unit. Normally, setting the code is not necessary. In the rare situation that you suspect another cordless telephone is using the same security code, you can change the code. To change the digital security code:

1. Perform the "System Reset" options ("De-register the Handset" and "Replacing the Base Setting") for all the handsets you have (see page 92).
2. Re-register each handset by following the steps on page 14.

Installing the Holster

- Line up the groove on the back of the handset with the groove on the holster. It fits in the holster only one way.
- Slide the phone into the holster.
- Use the spring clip to attach the holster to your belt or pocket.

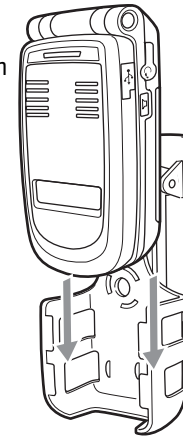

Optional Headset Installation

Your phone may be used with an optional headset. To use an optional headset, insert the headset plug into the headset jack. Your phone is ready for hands-free conversations. (Headset may be purchased by calling Uniden's Customer Hotline or visiting the web site. See page xx.)

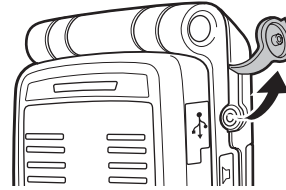

To use with a bluetooth headset, see page xx.

Installation of PC Application CD-ROM

The PC application CD-ROM is included in your package. The CD-ROM allows you to:

- Download Animations
- Edit and download the phonebook data, reminders, and images for the Personal message.
- Configure the phone setup (Speaker, Ringer Tone, Display Setup, Answer Machine, Global Setup, and Handset Setup)

- 1) Connect the USB cable to the handset and your PC as shown.
- 2) Insert the CD into your CD drive. The program will start automatically. If the program doesn't start automatically, go to the start menu and click run. In the window, type d: {executable file name xxxxxx}
(where D= the letter assigned to your CD-ROM drive) and click OK.

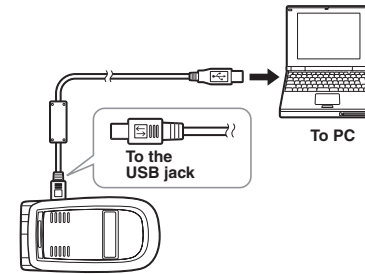

www.uniden.com

Optional Headset Installation [18]

Optional Headset Installation

Using the Interface

Example of the standby mode display

• Handset

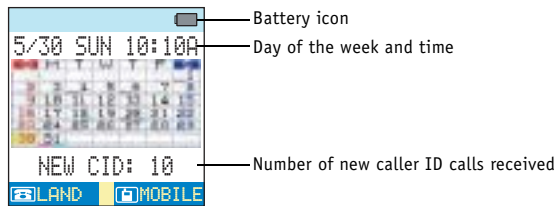

• Sub-LCD

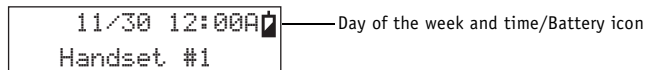

• Base

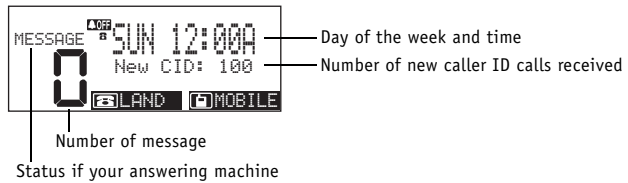

NEW — appears if you have a new message.

FULL — appears when the message storage is full.

Announce ONLY — appears if you set your answering system to announce only.

Display Icons

ICON			DESCRIPTION
Handset	Base	Sub-LCD	
	-		Battery icons indicate the handset battery status. This icon cycles depending on the battery status (full, medium, low, and empty).
			Ringer off icon indicates that ringer is turned off.
			LAND line icon indicate that the line in use is LAND.
			MOBILE line icon indicate that the line in use is MOBILE.
	-	-	Bluetooth icon appear when you are using bluetooth features.
			Mute icon appears when you mute the handset.
	-		Speaker icon appears when the handset speaker phone is used.
	-	-	When a new message is received, an envelope icon is displayed on the LCD screen
			Privacy icon appears when the Privacy Mode is turned on.
			Call record icon appears while recording a conversation.

Soft Key Function

"Soft" keys are keys that change function during the operation of the phone. There are two soft keys on the handset and base.

The function of each soft key is determined by the text that appears directly above it. For example, when the phone is in standby mode, pressing soft key 1 access the LAND line. When the phone is in talk mode, pressing soft key 1 will go to list for options. Complete information on the features controlled by the soft keys can be found under each feature.

In standby mode

Handset

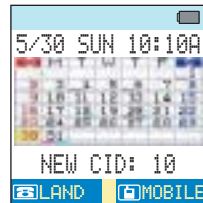

Soft key 1 Soft key 2

In talk mode

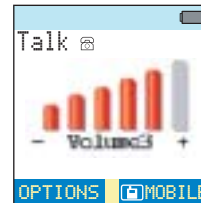

Soft key 1 Soft key 2

Base



Soft key 1 Soft key 2

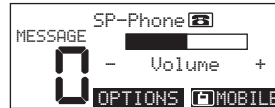

Soft key 1 Soft key 2

To make menu selection, please follow the instruction below:

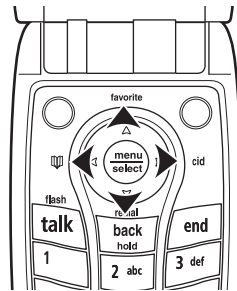

Press **menu/select**.

Highlight the option you want by pressing up, down, right, or left key on the handset, or up or down key on the base. This will move the cursor; the option currently highlighted appears in reversed out text:

To exit the **MENU** and return to standby, press the **end** key on the handset or the **end/find HS** key on the base.

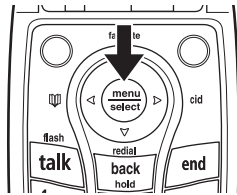

Select the highlighted option by pressing the **menu/select** key.

Entering text

You can use the number keypad on your phone to enter text by referring to the letters printed on each number key. When you press the number key in a text entry field, the phone displays the first letter printed on the number key. Press the number key twice to display the second letter and three times to display the third. Capital letters are displayed first, then lower case letters, then the number on the key.

If two letters in a row use the same number key, enter the first letter, then use the right and left key to move the cursor to the next position to enter the second letter. For example, to enter Movies:

- 1) Press 6 once to enter M.
- 2) Use **menu/select** to move the cursor to the right.
- 3) Press 6 six times to enter o.
- 4) Press 8 six times to enter v.
- 5) Press 4 six times to enter i.
- 6) Press 3 five times to enter e.
- 7) Press 7 eight times to enter s.
- 8) Press **menu/select** to end your text entry.

If you make a mistake while entering a name, use **menu/select** to move the cursor to the incorrect character. Press the **DELETE** soft key to erase the incorrect character, and then enter the correct character. To delete all characters in the text entry field, press and hold the **DELETE** soft key.

keys	Number of times key is pressed								
	1	2	3	4	5	6	7	8	9
1	i								
2 abc	A B	C	a b c						
3 def	D E F	d e f							
4 ghi	G H I	g h i							
5 jkl	J K L	j k l							
6 mno	M N O	m n o							
7 pqrs	P Q R	S P q r	s						
8 tuv	T U V	t u v							
9 wxyz	W X Y Z	w x y z							
	& < > / (blank)	- _							
0 oper	= : ; ? ! @ * "	'							
	# 0								

Main Menu Options

Your phone has various main menu options:

For Handset DirectLink, Room Monitor, Messages, Reminders, Speaker Setup, Display Setup, Ringer Setup, System Setup and Bluetooth.

Note:

- If you do not press a key within 30 seconds, the phone will time out and exit the menu mode. When setting Day and Time, the time-out period is extended to two minutes.
- All of these options can be configured in the Cordless Customization Application.

Handset Main Menu Options



For Base

Rings/Volumes, Caller ID, Redial, Phonebook, Room Monitor, Record Memo, System Setup

www.uniden.com



Main Menu Options [24]

Main Menu Options

Setup Menu

System Setup

The following submenu options must be set separately for each handset and the base.

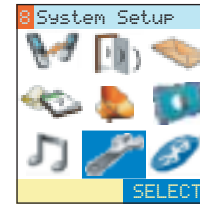

Mobile Priority

Mobile Priority allows you to set the default cellular phone. The phone rings only when receiving a call to the cellular. The cellular you select will be used when you press the **MOBILE** soft key to make a call.

To set the mobile priority, go to Mobile Priority, and select a cellular or All from the list. A confirmation tone tells you that the setting is active.

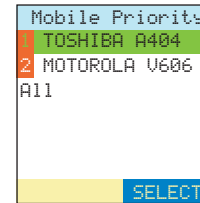

Through this section we use handset display images for explanation.

Call Privacy

If you don't want other registered handsets and the base to interrupt you on a call, you can turn on privacy mode. As long as your handset or the base is in privacy mode, other handsets won't be able to join your call or make any calls of their own. To turn on privacy mode, go to **Call Privacy** and select **On**. You can turn on privacy mode when the phone is in standby or when you're already on a call.

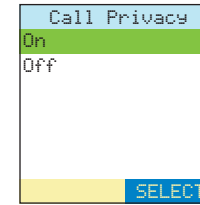

Language (For Base)

You can change the language the menu display will use. Choose from English, French, or Spanish. To change the language, go to **Language** and select **English**, **Français** (French), or **Español** (Spanish). You'll hear a confirmation tone, and the display will use the selected language.



LCD Contrast (For Base)

You can change the contrast of your base display to make it easier to read. You might want to adjust the contrast whenever you change the display color. Your phone gives you 10 levels of contrast to choose from. To adjust the contrast, go to **LCD Contrast**. Use up or right key to increase the contrast and down or left key to decrease the contrast. When you like the level of contrast, press the menu/select to select it.

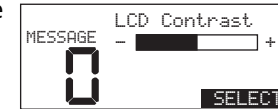

Key Touch Tone

Key Touch Tone is the tone your keypad makes when keys are pressed.

To turn off the tone, go to **Key Touch Tone** and select **Off**. A confirmation tone tells you that the tone has been deactivated.

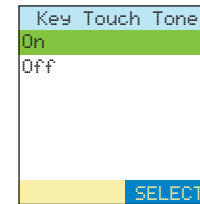

Open to Answer (Handset only)

Open to Answer lets you answer the phone by opening flip cover of the handset. To turn on Open to Answer, go to **Open to Answer** and select **On**. A confirmation tone tells you that Open to Answer is active.

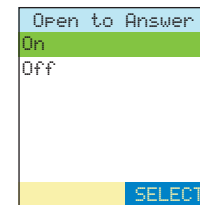

Any Key Answer (Handset only)

Any Key Answer lets you answer the phone by pressing any key on the number pad. To turn on Any Key Answer, go to **Any Key Answer** and select **On**. A confirmation tone tells you that Any Key Answer is active.

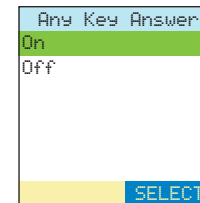

Banner (Handset only)

You can change the name your phone displays on the screen. If you have more than one handset, you can use the banner name to identify your handset during handset-to-handset functions like intercom and DirectLink. Go to **Banner Display** and enter the name you want to use. You can use up to 10 characters. Use the **DELETE** soft key to delete an existing handset name. Press **menu/select** when you're finished.

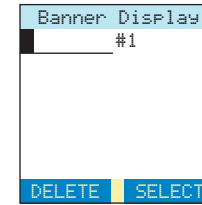

Unique ID (Handset only)

You can assign special ringer tones to anyone in your phonebook. When your phone gets a call, it looks up the Caller ID information in your phonebook; if you've assigned a distinctive ringer and pictures to that number, the phone uses it so you know who's calling. To turn on distinctive ringing, go to **Unique ID** and select **On**. A confirmation tone tells you that distinctive ringing is active.

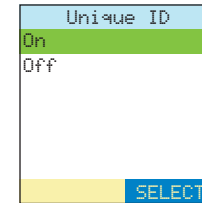

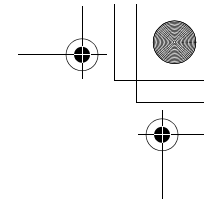

Global Setup

Global settings apply to all registered handsets and the base. If you change something under the global menu, you change it for all handsets and the base. Only one handset or the base can change global settings at a time, and you have to make sure the phone is not currently being used.



Day and Time

To change the date and time shown in the display, go to Date & Time. Use the up, down, right, left keys to highlight the part you want to change (date, time, AM/PM). Use the number keypad, up or down key, or * to change each part. Press **menu/select** when you're finished.

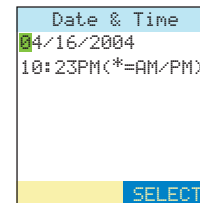

Note: For setting Day and Time, if no key is pressed for two minutes, the phone will exit the menu mode.

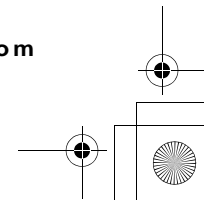
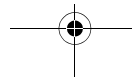
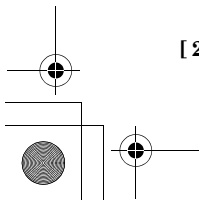
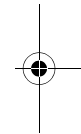
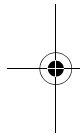

note

For mobile line, you can not set the Call Waiting feature to off. If you want to change the setting, ask your telephone company for instructions.

Call Waiting

Your phone supports Caller ID on Call Waiting, so you can see the name and number of someone who calls when you're already on the line. Your phone also supports Call Waiting Deluxe, which gives you a choice of how you want to handle a waiting call. You'll need to subscribe to these features with your phone company before you can use them.

To let your phone support these features, go to **Call Waiting**. Select **On**, and the phone will display the CallWaitDeluxe screen. Select **On**. (You have to turn on Call Waiting before you can turn on Call Waiting Deluxe.) A confirmation tone tells you that your phone is ready to use these features.

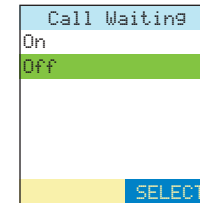

Area Code

If you can make a call by dialing only 7 digits (instead of 10), you can program your local area code in your phone. If you get a call from within your area code, you'll only see the 7-digit phone number. If you get a call from outside your area code, you'll see all 10 digits.

To enter an area code, go to **Area Code**. Use the number keypad to enter your 3-digit area code. Press **menu/select** when you're finished.

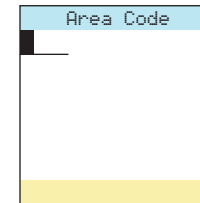

www.uniden.com

Setup Menu [30]

Setup Menu

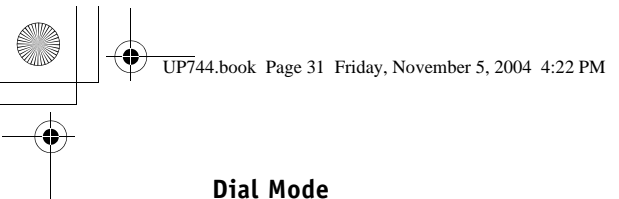

Dial Mode

Your phone can communicate with the telephone network in two different ways: tone dialing and pulse dialing. These days, most phone networks use a method called tone dialing, so your phone comes programmed for tone dialing.

If your phone company uses `Pulse` dialing, you'll need to change your phone's dial mode. There's an easy way to tell: try making a call. If your call connects, your phone's setting is fine. If not, go to `Dial Mode` and select `Pulse`. A confirmation tone tells you you've changed the dial mode, and you can try making a call again.

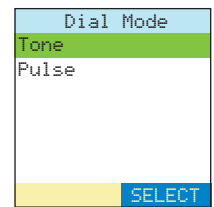

Setting the Ringer Options

This menu lets you customize Ringer or Speaker Volume setting in your phone. You can set these options separately for each handset and the base.

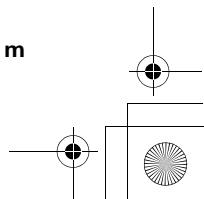
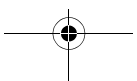
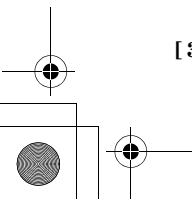
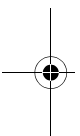

Ringer Tone

You can set a different ringer for each handset and the base. This phone comes with 10 prerecorded songs and 15 different ringer tones; you can also record your own ringer tones (see page 34).

- Songs: Beethoven's Symphony #9 [Beethoven9], Fur Elise [Elise], Home Sweet Home [Home Sweet Home], Lorri Song #6 [Lorri Song], When the Irish Eyes Are Smiling [Irish Eyes] (Base only), Aura Lee, Let Me Call You Sweet Heart [Sweetheart] (Base only), Star Spangled Banner [Star Spangled] (Base only), Old MacDonald [Old MacDonald], We Wish You A Merry Christmas [Merry Christmas]
- WT Overture (Handset only), Twinkle Star (Handset only), Je Te Veux (Handset only)
- Ringer tones: Flicker, Clatter, Coin Toss, Synthesize, Finish Lin, Soft Alert, Wake Up, Lighting Bug, Bebop, Tone Board, Chirp, Party Clap, Reminder, Burble, TeleTone,

- 1) Go to **Ringer Tones** and highlight the ringer you want. (Each ringer will sound as you highlight it.)
- 2) Select the tel type, Land or Mobile.
- 3) Select a ringer from the list.
- 4) Press **menu/select** to confirm the setting. You'll hear a confirmation tone, and the phone will go back to the menu.

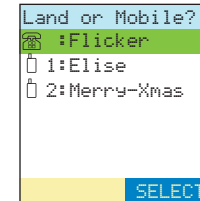

Unique Ring Setup (Base Only)

You can assign special ringer tones to anyone in your phonebook. When your phone gets a call, it looks up the Caller ID information in your phonebook; if you've assigned a distinctive ringer to that number, the phone uses it so you know who's calling.



To turn on distinctive ringing, go to `Unique Ring` and select `On`. A confirmation tone tells you that Unique Ring is active.

Vibrate Alert (Handset Only)

The vibrator mode allows you to vibrate the phone when you receive a call and the handset is off the base. To turn on the Vibrate Alert, go to `Vibrate Alert` and select `On`. A confirmation tone tells you that Vibrate Alert is active.

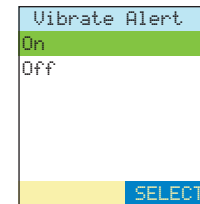

Vibrate Pattern (Handset Only)

You can choose a vibrate pattern (4 patterns (1-4) and Off). To set Vibrate Alert, go to **Vibrate Pattern** and select Tel Type (LAND or MOBILE), and then select the pattern. A confirmation tone tells you that Vibrate Pattern is active.

Customize Your Own Distinctive Ringer Tones

Your phone can store up to 5 different recordings to use as ringer tones (a total of 100 seconds). Each recording must be less than 20 seconds long.

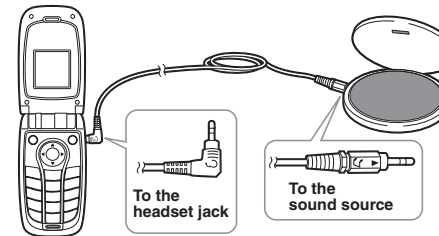

Storing Ringer Tones

- 1) Connect the audio recording cable to the handset and sound source (e.g. stereo or cd player). Insert one end of the audio recording cable into the handset's headset jack and the other end into the sound source. You can also simply use the handset's microphone by holding the handset close to the sound source.
- 2) Go to **Rec/Edit Rings**.
- 3) Select a location from 1-5, and press the **OPTIONS** soft key.
- 4) Use up/down key to select **Record**. To start recording, press the **RECORD** soft key. The message counter displays 20 and then begins to count down.



Setup Menu [34]

- 5) When you are finished recording, press the **STOP** soft key. The phone will play the recorded ringer. To record another ringer, press the **ReRec** soft key.
- 6) Enter the title of this ringer (up to 12 digits) using the number keypad, */tone, #, the **DELETE** soft key, right, or left key.
- 7) Press **menu/select**, you will hear a confirmation tone, and Done! appears.

Playing the Ringer

- 1) Go to Rec/Edit Rings.
- 2) Select a ringer to play, and press the **OPTIONS** soft key.
- 3) Use up/down key to select **Play**. To start playing, press **menu/select**. To stop, press **menu/select** again.



Change Ringer Name

- 1) Go to Rec/Edit Rings.
- 2) Select a ringer you want to change the title, and press the **OPTIONS** soft key.
- 3) Use up/down key to select **Change Title**.
- 4) Edit the title of this ringer (up to 12 digits) using the number keypad, */tone, #, the **DELETE** soft key, right, or left key.

When you are finished, press **menu/select**, you will hear a confirmation tone, and Done! appears.

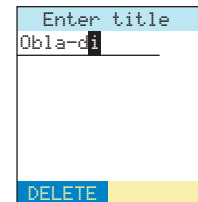



You can not delete the ringer used for ringer tone, Unique ring, or Reminder.

You can download images from the PC application CD-ROM, and use them for your wallpaper.

www.uniden.com

Delete Ringer

To delete a ringer tone, go to *Rec/Edit Rings*, and select the ringer you want to delete. Press **OPTIONS** soft key. Use up/down key to select *Delete*. Select *Yes*. You will hear a confirmation tone, and *Deleted!* appears. The ringer is deleted from the list, and the phone stays on the ringer list.

Display Setting (Handset Only)

The following submenu options must be set separately for each handset.

Themes (wallpaper)

Your phone has 30 different wall papers themes (example is Yellow flower). The wall paper will displays on the handset's LCD during standby mode:

To turn on the wallpaper, go to *Wall Paper* and highlight the wallpaper you want. Press the **VIEW** soft key to see the wallpaper or **menu/select** to activate it.

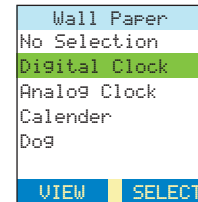
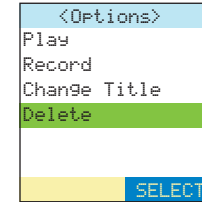

Setup Menu

Color Scheme

You can change the color of your phone's display. There are 5 different colors choose from: Lucid Whit, Haze Gray, Chic purple, Coral Red, and Lime Green.

To change the color of the display, go to **Color Scheme** and select the color you want. As you scroll through the options, the phone displays the highlighted color for you.

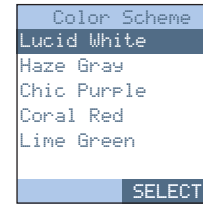

LCD Contrast (for the handset)

LCD Contrast adjusts the handset LCD brightness. To adjust the contrast, go to **LCD Contrast** and highlight the contrast level you want. Press **menu/select** to activate it. you will hear a confirmation tone.





- If no Bluetooth headset was found, Bluetooth Device was not found, appears.
- To cancel searching, press the **STOP** soft key.

www.uniden.com

Animation Type (Handset only)

Your phone has 4 different system animations (Dog, Car, Frog and Abstract) with 10 different animation schemes (example is for dog):



To turn on the animation, go to Animation Type and highlight the animation you want. Press the **SELECT** soft key to activate it.

Language

You can change the language the menu display will use. Choose from English, French, or Spanish. To change the language, go to Language and select English, Français (French), or Español (Spanish). You'll hear a confirmation tone, and the display will use the selected language.

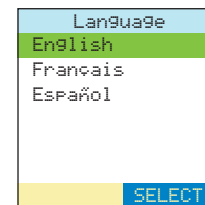
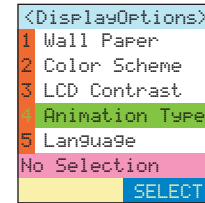

Setup Menu [38]

Setup Menu

Using Bluetooth Feature

Registering Your Cellular Phone to Your Phone

If your cellular phone is a Bluetooth v 1.1 compliant, and if you register the cellular phone to the phone, the phone allows you to use the mobile line in **addition** to usual land line. To register the cellular phone, do the following steps: Before you can use a bluetooth feature, you must pair cellular phones with the phone. Once you have paired your cellular phone with the phone, you do not have to pair it again until you want to use it with another phone.

- 1) Prepare your cellular phone according to the cellular's owner's manual on pairing.
- 2) When the phone is in standby mode, press **menu/select** on the base.
- 3) Select `System Setup` menu, and then `Bluetooth`.
- 4) Use up/down key to select `Select` ⌘ `Mobile`, and then press **menu/select**.
- 5) Use up/down key to select a slot to be registered and press the **OPTIONS** soft key.
- 6) Use up/down key to select `Pairing` ⌘ and then press **menu/select**.
- 7) Enter the pin code using the number from the cellular phone keypad, and then press `menu/select`. Pairing (registration) will start.





When pairing is completed successfully, you will hear a confirmation tone, and `Pairing Successfull!` appears on the base. If pairing failed, `Pairing failed, Try again` appears.

De-registering the Cellular Phone

- 1) When the phone is in standby mode, press *menu/select* on the base.
- 2) Select System Setup menu, and then Bluetooth.
- 3) Use up/down key to select Select  Mobile, and then press *menu/select*.
- 4) To delete individual cellular phone, use up/down key to select a cellular phone to be de-registered and press the **OPTIONS** soft key.



To delete all cellular phones, just press the **OPTIONS** soft key.

- 5) Use up/down key to select Deregister  or Deregister All  to de-register all, and then press *menu/select*.
- 6) Use up/down key to select Yes, and then press *menu/select*.



When the de-registration is complete, you will hear a confirmation tone, and Deregistration Successful! appears.

Editing the Mobile Name

You can store and edit names of registered cellular phones.

- 1) When the phone is in standby mode, press **menu/select** on the base.
- 2) Select **System Setup** menu, and then **Bluetooth**.
- 3) Use up/down key to select **Select**  **Mobile**, and then press **menu/select**.
- 4) Use up/down key to select a cellular phone to edit the name, and press the **OPTIONS** soft key.
- 5) Use up/down key to select **Edit Name** and then press **menu/select**.



Enter or edit the name using the number keypad, ***/tone**, **#**, the **DELETE** soft key, and right and left key.

- 6) When you are finished, press **menu/select**. You will hear a confirmation tone, and **Done!** appears.

note

If you set the mobile ringer tone to off, the unique ringer feature will be disabled.

www.uniden.com

Turning On/Off the Mobile Ringer Tone

- 1) When the phone is in standby mode, press *menu/select* on the base.
- 2) Select *System Setup* menu, and then *Bluetooth*.
- 3) Use up/down key to select *Mobile Ring Tones*, and then press *menu/select*.
- 4) Use up/down key to select *On* or *Off*, and then press *menu/select*.
- 5) Use up/down key to select *Yes*, and then press *menu/select*.

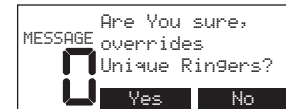
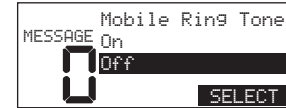

Viewing Paired Headset

- 1) When the phone is in standby mode, press *menu/select* on the base.
- 2) Select *System Setup* menu, and then *Bluetooth*.
- 3) Use up/down key to select *My base unit*, and then press *menu/select*.

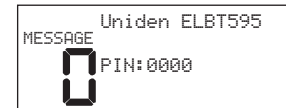

The property of the Mobile appears.

To go back to the Bluetooth setup Menu, press *back/hold/intercom*.

Using Bluetooth headset

The phone also supports Bluetooth v 1.1 compliant headsets. Please visit our web site for detailed information.

Before you can use a bluetooth headset, you must pair with the phone. Once you have paired your headset with the phone, you do not have to pair it again until you want to use it with another phone.

Registering the bluetooth headset

- 1) Prepare your bluetooth headset according to the headset's owner's manual on pairing.
- 2) When the phone is in standby mode, press **menu/select** on the handset.
- 3) Select the Bluetooth icon.
- 4) Use up/down key to select Find Pair , and then press **menu/select**.

The phone will search a bluetooth device.
When a BlueTooth headset is detected, its name appears on the display.
Press the **STOP** soft key to back to show the list of the bluetooth headsets.

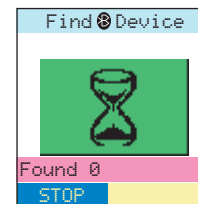

- 5) Use up/down key to select a headset to be registered and press the **CONNECT** soft key.
- 6) Enter the pin code using the number keypad, and then press **menu/select**.

When the operation is complete, Pairing Successful! appears.

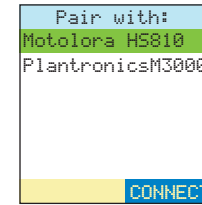

Using Bluetooth Feature

Turning On or Off the Bluetooth Set Up

This feature allows you to save the power of the phone. When you do not use the Bluetooth feature for a long period, turn the Bluetooth Set Up to off.

- 1) When the phone is in standby mode, press *menu/select* on the handset.
- 2) Select the Bluetooth icon.
- 3) Use up/down key to select  On/Off, and then press *menu/select*.
- 4) Use up/down key to select On or Off, and then press *menu/select*.

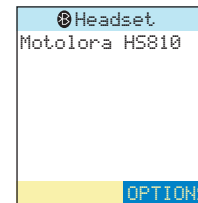

Viewing Paired Headsets

- 1) When the phone is in standby mode, press *menu/select* on the handset.
- 2) Select the Bluetooth icon.
- 3) Use up/down key to select My Handset, and then press *menu/select*.

Property of the Handset appears on the handset.



If no device is detected, Bluetooth Device was not found. appears, and back to the Bluetooth setup menu.

To reconnect the Bluetooth Headset

- 1) Press the **OPTION** key, and select *Reconnect...*
- 2) Use up/down key to select *Yes*, and then press *menu/select*.

You will hear a confirmation tone, and *Done!* appears.

De-register the Bluetooth Headset

- 1) Press the **OPTION** key, and select *Deregister*
- 2) Use up/down key to select *Yes*, and then press *menu/select*.

You will hear a confirmation tone, and *Done!* appears.

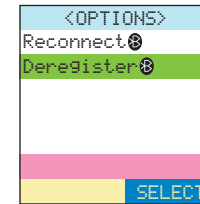
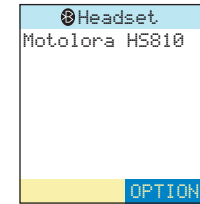

Using Your Phone

If you have a Bluetooth v1.1 compliant Cellular phone and register it to the base, you can make or receive a call through the mobile line as well as the normal land line. To use the mobile line, press the **MOBILE** soft key. The **twol** line will be completely independent on your phone. For example, you can have one handset talking on LAND line while another handset and the base unit participate in a 3-way conference on the mobile line.

Making Calls

From the Handset

- 1) Remove the handset from the charging cradle.
- 2) Flip the top panel up.
- 3) Press **talk/flash** or the **LAND** soft key.
For Mobile line connection, press the **MOBILE** soft key.
Use up/down key, to select the cellular phone to use and press the **CONNECT** soft key.
- 4) Listen for the dial tone.
- 5) Dial the number.

OR

- 1) Remove the handset from the charging cradle.
- 2) Flip the top panel up.

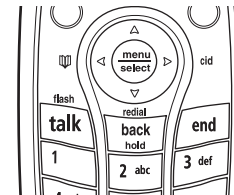

- Before using Mobile line, you need to register the cellular phone to the base (see page xx).
- When you dial the number, hyphens are inserted between numbers.
- If the line is already in use, all registered handsets and the base that are not currently in use will display "In Use."
- For best performance, use the speaker phone in a quiet room and let the caller finish speaking before you speak. If you or the other party has difficulty hearing, adjust the speaker volume.

www.uniden.com

note

In the list for MOBILE line, select the cellular with *. cellular without * means the cellular is out of range, or other handset or the base is in use.

3) Dial the number.

If you need the phone to pause before dialing more digits (for example, to enter an access code or extension), press **menu/select**, and select **Pause Entry** from the list. **P** appears in the display, which represents a 2-second pause.

4) Press **talk/flash** or the **LAND** soft key for Land line.

For Mobile line connection, press the **MOBILE** soft key. Use up/down key, to select the cellular phone to use and press the **CONNECT** soft key.

From the Handset Speakerphone

- 1) Remove the handset from the charging cradle.
- 2) Flip the top panel up.
- 3) Press **▷** (Speaker Phone) on the side of the handset.
- 4) Listen for the dial tone.
- 5) Dial the number.
- 6) When the other party answers, talk into the microphone in the bottom of the handset.

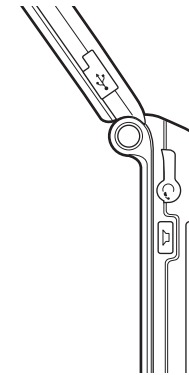

From the base

- 1) Press **FLASH** or the **LAND** soft key.
For Mobile line connection, press the **MOBILE** soft key.
- 2) Listen for the dial tone.
- 3) Dial the number.

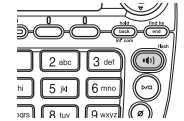

OR

- 1) Dial the number.
If pause is required, press **menu/select**, and select **Pause Entry** from the list.
- 2) Press **FLASH** or the **LAND** soft key for the Land line. For Mobile line connection, press the **MOBILE** soft key. Use up/down key, to select the cellular phone to use and press the **CONNECT** soft key.

Receiving a call/AutoTalk set to OFF

Handset is in the cradle	Handset is off the cradle
<ol style="list-style-type: none"> 1) Remove the handset from the charging cradle. 2) Flip the top panel up. 3) Press talk/flash or the corresponding soft key (LAND or MOBILE). <p>If Open to Answer is ON, the phone will automatically answer the call when you flip the top panel up.</p>	<ol style="list-style-type: none"> 1) Flip the top panel up. 2) Press talk/flash or the corresponding soft key (LAND or MOBILE). <p>If Any Key Answer is set to On, you can also press any number key on the keypad to answer a call.</p>



- To set Open to Answer see page xx or to set "Any Key Answer" see page xx.
- If you plug a headset, or use the handset speaker phone, you can not hang up the call when you close the top panel.

note

- If you set the mobile priority to a cellular phone, the phone ring only when you receive a call to the cellular phone.
- While using the handset speaker phone or a headset, closing the top panel will not hang up the call.
- To scroll through the help, press the **NEXT** soft key or down key.
- You must subscribe through your local telephone company to receive Call Waiting or Caller ID on call waiting service.
- Your phone can't show call waiting caller ID information when a call is on hold.

www.uniden.com

From the base

Press **Ⓜ**/*flash* or the corresponding soft key (**LAND** or **MOBILE**).

Hanging Up

From the handset or handset speakerphone, press **end** or return the handset to the cradle (AutoStandby). Or close the top panel.

From the base, **end/find hs**.

Switching to the Handset Speakerphone During a Call

To switch a normal call to the speakerphone, press **Ⓜ** (speaker phone) on the handset. To switch from a speakerphone call to a normal call, press **Ⓜ** (speaker phone).

Moving out of range

If you move your handset farther from the base unit during a call, you might start to hear more noise than usual. If you go too far from the base, you'll hear a beep and see **No Signal**. Press the **HELP** soft key on the display. The base will stay connected to the caller for another 35 seconds, so you can move back within range and press **talk/flash** or **Ⓜ** (speaker phone), or **Ⓜ**/*flash* on the base to return to the call.

Call Waiting

If you hear a call waiting tone while you're on a call, press **talk/flash** or **Ⓜ/flash** on the base to switch to the new call. After a short pause, you'll hear the new caller. Press **talk/flash** or **Ⓜ/flash** on the base again to go back to the original caller.

Call Waiting Deluxe

If you subscribe to Call Waiting Deluxe (CWDX) from your phone company, you have several different options when you get a call waiting call. When you hear the call waiting tone, instead of answering the call, you can press **menu/select** or the **OPTION** soft key, and then select **CallWaitDeluxe**. Then, use up/down key or press 1-7 (1-4 for Mobile line) to choose from the following options:



Option	Definition	On a LAND line, press	On a MOBILE line, press
Ask to Hold	A prerecorded message tells the caller that you'll be available shortly, and the call is place on hold	1	-
Tell Busy	A prerecorded message tells the caller you are busy, and the waiting call is disconnected.	2	1
Forward	The caller is sent to your voice mail box, if available.	3	-
Answer/Drop 1	Disconnects the first call, and connects to the new caller.	4	2
Conference	Starts a conference call with your first and second callers.	5	4
Drop First/Drop Last	During a conference call, allows you to choose to drop the first or last caller.	6 / 7	-
Answer/Hold 1	Releases all active calls (if any exist) and accepts the other (held or waiting) call	-	3

note

- If you leave a call on hold for more than 5 minutes, warning tone sounds and **Call on Hold Answer soon** appears, and the line will disconnect in 15 seconds.
- If someone is using another handset or base in Privacy Mode, **Unavailable** appears in the display and you cannot join the call.

Placing a Call on Hold

During a call, press. Press **back/hold/intercom, end,** or **end/find HS** on the base to put the call on hold. Press **talk/flash** or **Ⓜ/flash** on the base to go back to the call.

Conferencing

If you have two handsets and the MOBILE line, up to five people can participate in a conference call. A five-way conference call consists of

Outside Line (LAND) + Outside Line (MOBILE) + Base + Two Handsets.

Only two handsets can participate in any conference call.

Joining a Conference Call

You can easily join a call already in progress.

