

Uniden®

MHS050-2

FLOATING VHF MARINE RADIO

RADIO VHF MARITIME FLOTTANTE



**OWNER'S MANUAL
GUIDE D'UTILISATION**

MAKING A DISTRESS CALL

For future reference, write your boat's name & call sign here:

Speak slowly - clearly - calmly.

1. Make sure your radio is on.
2. Press the **16/9-TRI** button to switch to Channel 16 (156.8 MHz). (If the display does not show 16, press the **16/9-TRI** button again until it does.)
3. Press the **Push to Talk** button and say: "**MAYDAY -- MAYDAY -- MAYDAY.**"
4. Say "**THIS IS** {*name of your boat (three times) and call sign/ boat registration number (once)*}."
5. Repeat "**MAYDAY** {*name of your boat*}" once.
6. Tell where you are: (what navigational aids or landmarks are near, or read the latitude and longitude from your GPS).
7. State the nature of your distress (e.g. sinking, medical emergency, man overboard, on fire, adrift, etc.).
8. State the type of assistance you need (medical, towing, pumps, etc.).
9. Give the number of persons aboard and describe the condition of any injured persons.
10. Estimate present seaworthiness of your ship (e.g. how immediate is the danger due to flooding or fire).
11. Briefly describe your ship, giving ship name (i.e., "Blue Duck is 32 foot cabin cruiser, white hull, blue deck house").
12. Say: "**I WILL BE LISTENING ON CHANNEL 16.**"
13. End the message by saying "**THIS IS** {*name or call sign of your boat*}, **OVER.**"
14. Release the **Push to Talk** button and listen.

If you do not get an answer after 30 seconds, repeat your call beginning at step 3 above.

FAIRE UN APPEL DE DÉTRESSE

Pour toute référence ultérieure, transcrivez ci-dessous le nom et l'indicatif d'appel de votre bateau:

Parlez lentement – clairement – calmement.

1. Vérifiez si votre radio est en marche.
2. Appuyez sur la touche **16/9-TRI** du microphone afin de commuter au canal 16 (156,8 MHz). (Si le canal 16 n'apparaît pas à l'affichage, appuyez de nouveau sur la touche **16/9-TRI** jusqu'à ce qu'il soit affiché.)
3. Appuyez sur le bouton de microphone **Push to Talk** et dites: "**MAYDAY -- MAYDAY -- MAYDAY**".
4. Donnez l'identité de votre navire en disant : "**ICI** {*nom de votre bateau (trois fois) ou indicatif d'appel et le numéro d'identification de votre bateau (une fois)*}".
5. Dites "**MAYDAY** {*nom ou indicatif d'appel de votre bateau*} *une fois*".
6. Donnez votre position : (quels sont les points de repère ou aides à la navigation près de vous ou lisez les coordonnées de longitude et de latitude apparaissant sur votre dispositif GPS).
7. Révélez la nature de votre détresse (par exemple, nous sommes en train de couler, urgence médicale, un homme à la mer, un incendie, nous sommes à la dérive, etc.
8. Révélez la nature de l'aide désirée (médicale, remorquage, essence, etc.)
9. Donnez le nombre de personnes à bord et les conditions des blessés, s'il y en a.
10. Donnez la condition de navigabilité actuelle de votre navire, tel que le degré de l'urgence par rapport une inondation, et une incendie.
11. Donnez une brève description de votre navire en donnant le nom du bateau (par exemple, "Blue Duck est un yacht de croisière de 32 pieds, avec une coque blanche et un rouffle bleu.)
12. Dites : "**JE VAIS ÉCOUTER SUR LE CANAL 16**".
13. Terminez le message en disant "**ICI** {*nom ou indicatif d'appel de votre bateau*}, **À VOUS**".
14. Relâchez le bouton **Push to Talk** du microphone et écoutez.

Si vous n'obtenez pas de réponse après 30 secondes, répétez l'appel en commençant à l'étape 3 ci-dessus.

TABLE OF CONTENTS

MHS050-2 INTRODUCTION	6
FEATURES	6
GETTING STARTED	7
WHAT'S INCLUDED	7
CONTROLS AND INDICATORS	8
GETTING STARTED	9
CONNECTING POWER	9
INSTALL THE BATTERY PACK	9
CHARGING THE BATTERY PACK	10
BATTERY LEVEL DISPLAY	11
ATTACHING THE BELTCLIP	12
USING THE CARABINER CLIP	12
OPERATION	12
BASICS	12
POWER ON/OFF	12
VOLUME	12
SELECT A CHANNEL	13
SET SQUELCH	13
SRT CHANNEL MODE	14
TRANSMITTING AND RECEIVING	14
ONE-TOUCH CHANNEL 16/9	15
TRIPLE WATCH	15
SCANNING	15
STORING SCANNED CHANNELS	16
MONITOR	16
DROP-OUT DELAY	16
BATTERY SAVE	16
BACKLIGHTING	16

KEYPAD LOCK	17
MAINTENANCE & TROUBLESHOOTING.....	17
COMMON QUESTIONS	17
SPECIFICATIONS	18
CHANNELS AND FREQUENCIES (MHZ).....	20
US CHANNEL FREQUENCIES AND NAMES.....	20
CANADIAN CHANNEL FREQUENCIES AND NAMES.....	21
INTERNATIONAL CHANNEL FREQUENCIES AND NAMES.....	23
REGULATIONS AND SAFETY WARNINGS	26
MARITIME RADIO SERVICES OPERATION	26
BASIC RADIO GUIDELINES	26

MHS050-2 INTRODUCTION

The MHS050-2 is a floating, waterproof, portable 2.5-watt two-way VHF marine transceiver. It is compact, lightweight, rugged, and fits easily in your hand. This handheld VHF marine radio will give you consistent, outstanding performance in virtually all conditions and situations.

To ensure that you get the most from the MHS050-2 features, please read this operating guide carefully before using the unit.

FEATURES

- US, Canadian, and International Marine Channels
- Built-in Precision Matched Antenna
- Floating / Waterproof to JIS8
- Carabiner Clips
- Emergency 16CH / 9CH Mode
- Battery Level Display
- Memory Scan
- Triple Watch
- TX Power Select
- Channel Select
- Volume Select
- 3-Level Squelch Selectable
- Key Lock On / Off
- Battery Save

*Protected against the effects of continuous immersion in water. The MHS050-2 can withstand immersion in water up to 5 feet depth for 1 hour.

Note: This is not suitable for scuba diving.



The MHS050-2 will float when the carabiner clip is not connected and the battery cover is securely fastened.

GETTING STARTED

WHAT'S INCLUDED



MHS050-2 Radio (2)

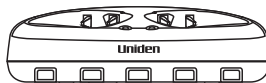

Dual Charging Cradle
(DTMHS2)



AC Adapter
[AAD-050S(M)]

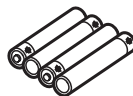

NiMH Battery Pack (2)
(BP38)



Beltclip

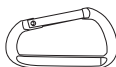

Carabiner Clip* (2)

Owner's Manual
(Not Shown)



NOTE

If any of these items are missing or damaged, contact Uniden Customer Service (see back cover for contact information). For information on available accessories, visit www.uniden.com.

CONTROLS AND INDICATORS

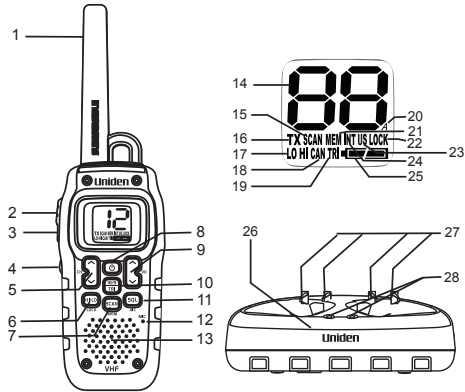

No.	Description	No.	Description
1	Antenna	9	Volume Up/Down
2	PTT (Push-To-Talk) button	10	16/9 TRI (Triple Watch) button
3	Power Boost button	11	SQL/UIC (Squelch) button
4	Monitor button	12	Microphone
5	Channel Up/Down	13	Speaker
6	HI/LO (Transmit Power)/ Keylock button	14	Channel Indicator
7	SCAN/MEM (Memory) button	15	Scan Indicator
8	Power Key	16	TX Indicator

No.	Description	No.	Description
17	TX LO/HI Power Indicator	23	US Channel Mode
18	Canada Channel Mode	24	International Channel Mode
19	Triple Watch Indicator	25	Battery Level Indicator
20	"A" Channel Indicator	26	Charging Cradle
21	Memory Indicator	27	Charging Contacts
22	Keylock Indicator	28	Charging Indicators

GETTING STARTED

CONNECTING POWER

The dual charging cradle uses a single AC adapter.

1. Connect the AC adapter to the DC 12 V jack on the rear of the charging cradle.
2. Plug the other end of the AC adaptor into a 120 VAC wall outlet.



NOTE

- The drop-in charger is not water proof. Ensure the radio is dry before connecting to the charger.
- Don't use the charger when the ambient temperature is below 32°F (0°C) or above 113°F (45°C).

INSTALL THE BATTERY PACK

Your radio uses the supplied NiMH battery pack. To install the NiMH battery pack:

1. Make sure the radio is off.
2. Use a screwdriver to turn the battery compartment screw counterclockwise and then lift up and remove the battery cover.
3. Put the NiMH battery pack in the battery compartment, applying the battery contacts to the lower charge contacts. Be sure to follow the instructions written on the battery pack's label.

Installing the battery pack incorrectly will prevent the unit from operating.



Use only the supplied NiMH battery pack. Do not charge alkaline or non rechargeable batteries.

5. Before placing the battery cover back on the radio, check the rubber seal around the battery compartment and the ribbon of the battery pack. Make sure that the seal is in good condition and that there is no foreign matter under the seal.
If the rubber seal appears worn, nicked, or dried out, replace it. Visit the website on the cover of this manual to order a replacement seal.
6. Replace the battery compartment door. Tighten the screws securely.

CHARGING THE BATTERY PACK

Your radio includes a charging cradle and a rechargeable battery pack. Follow these instructions to recharge the radio in the charging cradle.



For the initial battery charge, make sure the radio is off for optimum charging.

1. Connect the charging cradle to power. Refer to page 9.
2. Set the charging cradle on the desk or tabletop, and place the radio in the charging cradle with the keypad facing forward.
3. Make sure that the LED illuminates. Charge the battery pack for 13 hours then remove the radio from the charging cradle.



- The charging cradle is not waterproof. If the charging cradle falls into water, unplug it before attempting to remove it from the water. Allow the cradle to dry completely before reconnecting the power.
- If your radio is soiled or wet, wipe off dirt or shake water from your radio before placing it in the charging cradle.

BATTERY LEVEL DISPLAY

The battery icon at the bottom of the screen indicates the battery level (displayed as one of the 4 levels below) at all times.

Battery Level	Icon	Battery Level	Icon
LEVEL 4 Battery 100% full		LEVEL 3 Battery approx. 40% capacity	
LEVEL 2 Low Battery		LEVEL 1 (flashing) Empty Battery	



When the **PTT** button is pressed at Level 1, an error tone sounds and transmission is disabled. Once at Level 1, the unit will shutdown automatically after 60 seconds.



Recharge the battery at any time. From empty, the battery requires 13 hours to fully charge. For faster charging, turn off the radio.

Battery Life: 12 Hours (Typical)

This is based on the following Duty Cycle:

Condition	% Duty Cycle
Transmit (Low Power)	5%
Receive	5%
Stand-by	90%

ATTACHING THE BELTCLIP

To attach the belt clip:

Slide the belt clip until it snaps into place.

To remove the belt clip:

Press and hold down the belt clip lock while simultaneously sliding it upward until it releases.

USING THE CARABINER CLIP



Use the carabiner clip to conveniently secure the radio to a belt or strap.

OPERATION



In order to get the most out of your new radio, read this owner's manual completely before attempting to operate the unit.

BASICS

Power On/Off

1. Press and hold  to turn the radio ON. A channel number and battery level should appear on the display.
2. Press and hold  to turn the radio OFF.

Volume

The volume level can be adjusted from  (no volume) to  (maximum volume).

Press **VO ▲** or **VO ▼** to increase or decrease the volume level.  shows on the display and the current volume level flashes.



Select a Channel

Press **CH ▲** or **CH ▼** to scroll through the channels individually. Press and hold **CH ▲** or **CH ▼** to scroll rapidly through the channel numbers. Refer to page 20 for a list of available channels and their corresponding frequencies and usage guidelines.

Set Squelch

Use squelch to eliminate any annoying background noise when there are no signals present.



NOTE

Make sure to first select a channel not in use before setting the squelch.

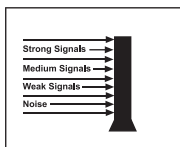

Think of the squelch control as a gate. If you increase the squelch level to maximum, it raises the “Squelch Gate” so only the strongest signals get through.

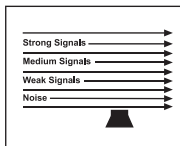

If you decrease the squelch level to minimum, it lowers the “Squelch Gate” to the extent that weak signals can get through.

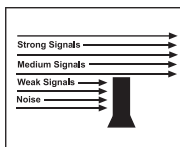

If unwanted weak and noisy signals are getting through, increase the squelch level (raise the “Squelch Gate”) to a medium level. Now only medium and strong signals get through.

S1 - minimum squelch

S2 - medium squelch

S3 - maximum/tight squelch

1. Press **SQL/UC**. **S** displays and the current squelch level flashes.
2. Press **SQL/UC** while the squelch level displays in order to change the squelch level to the next step.
3. Press and hold **SQL/UC** to save and exit the squelch setting.



SRT Channel Mode

Press and hold **SQL/UC** to switch between USA, International, and Canadian Channel Modes.

TRANSMITTING AND RECEIVING

The radio uses U.S., Canadian, and International Marine Channels. Refer to page 20 for a list of the available channels and corresponding frequencies. The radio's maximum RF transmit power is 2.5 W.

1. Hold the radio with microphone approximately 2 inches in front of your mouth with the antenna at approximately 45° angle away from your head. Speak in a clear, normal conversational voice.
2. Press **HI/LO-LOCK** to change the transmit power between High (2.5 W) and Low (1 W). **HI** displays when on high power and **LO** displays when on low power.
3. Before you transmit again, listen for activity on the selected channel.
4. When the channel is clear, press and hold **PTT** or **BOOST** to transmit. **TX** displays.

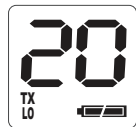



NOTE

When you press **BOOST** and the transmit power is low (LO - 1W), the radio transmits at maximum high power (HI - 2.5W) except for channels 75 and 76.

- When you have finished speaking, release **PTT** or **BOOST** to listen for a response. **TX** then disappears.

One-touch Channel 16/9

While monitoring CH 20, press **16/9** to monitor CH 16.



Press **16/9** again to monitor CH 9.



Press **16/9** again to monitor the original channel (CH 20).



Triple Watch

Triple Watch mode monitors channels 16 and 9 for a signal while you listen to the currently-selected channel. The marine radio checks channel 16 and 9 for activity every 2 seconds.

- Press and hold **TRI** to activate Triple Watch.
- Press and hold **TRI** again to exit Triple Watch.



NOTE

While in Triple Watch mode, you can change the currently-selected channel using **CH ▲** or **CH ▼**.

SCANNING

The radio can scan the channels programmed into memory (see page 16). To initiate scanning:

- Select channel 17.
- Press **SCAN** and scanning starts. **SCAN** displays during scanning.



The radio will scan memory channels in ascending order.

If Triple Watch is turned on during the scan, the radio will scan the memory channels in ascending order. Check channel 9 and channel 16 every 2 seconds, and then resume scanning the memory channels.

Storing Scanned Channels

1. Select the channel you want to store by pressing **CH ▲** or **CH ▼**.
2. Press and hold **MEM**. **MEM** displays and you hear a double beep.
3. To remove channels from Memory, press and hold **MEM** once more. A double beep sounds and **MEM** disappears.



MONITOR

1. Press **MON** to start monitoring one channel with fixed (open) squelch.
2. Press and hold **MON** for 2 seconds to hold the monitor status on. All channel indicators will start to flash.
3. Press **MON** again to release the monitoring status.



NOTE

Monitor is not available in Scan or Triple Watch modes.

Drop-out Delay

While scanning, the radio stops on channels when it receives a signal. When the received signal is over, the unit provides a drop-out delay of 2 seconds for the return of the signal. After 2 seconds, if the signal does not return, the radio resumes scanning.

Battery Save

This feature extends the battery life by switching the receiver circuit power on and off. Battery Save automatically activates during standby mode (RX mode without signal).

Backlighting

The Liquid Crystal Display (LCD) is backlit for easy viewing at night or in low light situations. Backlighting automatically

switches on every time a key is pressed (except **PTT** and **BOOST**) and off 10 seconds after the last key is pressed.

Keypad Lock

To prevent accidental entries, you can lock the keypad. Press and hold **HI-LO/LOCK** until it beeps to activate Key Lock. **LOCK** displays on the LCD. When Key Lock is active, a warning beep sounds and **LOCK** blinks if you try to press any keys other than **PTT**, **BOOST**, and **MON**.



To unlock the keypad, press and hold **LOCK** again. **LOCK** disappears.

MAINTENANCE & TROUBLESHOOTING

Due to its rugged design, your radio requires very little maintenance. However, it is a precision electronic instrument, so you should follow a few precautions:

- If the antenna has been damaged, do not transmit except in an emergency situation. Transmitting with a defective antenna may cause further radio damage.
- You are responsible for continued FCC technical compliance of your radio.
- You should arrange for periodic performance checks with your Uniden dealer.

COMMON QUESTIONS

Problem	Things to Try
The radio won't turn on.	Charge the radio.
The power LED on the charger doesn't turn on.	<ul style="list-style-type: none">• Don't use the charger when the ambient temperature is below 32°F (0°C) or above 113°F (45°C).• Make sure the charging contacts on the radio and charger are clean.• Replace the battery.

Problem	Things to Try
The radio won't transmit.	<ul style="list-style-type: none"> • Make sure you are not in weather or scan mode. • Make sure you are not trying to transmit on a receive-only channel or transmit at the wrong power level for this channel (see the channel lists starting on page E-23). • Check the battery power level; if it's low, charge the battery before trying to transmit. • Make sure the duration of each transmission is less than 5 minutes.
I can't hear anything from the speaker.	Adjust the squelch level; it is probably too high.
Noise comes out of the speaker all the time	Adjust the squelch level; it is probably too low.
I can transmit, but no one can hear me.	Check your UIC channel settings: does the area you are in use different channel assignments?
Where can I find my radio's serial number?	The serial number is on a plate inside the battery compartment.

SPECIFICATIONS

General	
Channels	All US, International, and Canada marine channels
	10 Weather channels
Frequency Control	PLL
Frequency Tolerance	Transmit: 1.5 PPM (at 25°C)
	Receive: 1.5 PPM (at 25°C)
Operating Temperature	-4°F (-20°C) to +122°F (+50°C)
Antenna	Flexible Whip
Microphone	Built-in Electret type

Display	Liquid Crystal Display
Speaker	16 Ω 0.2 W
Power Source	Rechargeable NiMH Battery Pack 4.8 V 700 mAh
Size (without antenna)	8.98 (H) x 2.52 (W) x 1.54 (D) inch 228 (H) x 64 (W) x 39 (D) mm
Weight	8.53 oz (242g) (w/battery and antenna)
Transmitter	
Frequency Range	156 ~ 158 MHz
Frequency Stability	± 2.5 PPM
Power Output	1.0 W and 2.5 W
Spurious Emissions	-34 dBm 2 Hi, -39 dBm Lo
Current Drain	1100 mA (2.5 W)
Receiver	
Type	Double Conversion Super Heterodyne Phase Locked Loop system for Local Oscillator
Frequency Range	156 ~ 162 MHz
Sensitivity	0.20 μ V for 12 dB SINAD
Squelch Sensitivity	Threshold 0.12 μ V
Audio Frequency Response	+6 dB @ 500 Hz; -6 dB @ 2000 Hz
Adjacent Channel Selectivity	70 dB @ ± 25 kHz
Audio Output Power	0.16 W @ 10% THD
Current Drain	Squelched: 55 mA; Max. Audio: 175 mA

CHANNELS AND FREQUENCIES (MHZ)

US CHANNEL FREQUENCIES AND NAMES

US Marine Channels				
Ch	RX Freq	TX Freq	Status	Name
1A	156.050	156.050	Simplex	Vessel traffic system/commercial
5A	156.250	156.250	Simplex	Vessel traffic system/commercial
6	156.300	156.300	Simplex	Inter-ship safety
7A	156.350	156.350	Simplex	Commercial
8	156.400	156.400	Simplex	Commercial
9	156.450	156.450	Simplex	Non commercial
10	156.500	156.500	Simplex	Commercial
11	156.550	156.550	Simplex	Vessel traffic system
12	156.600	156.600	Simplex	Vessel traffic system
13	156.650	156.650	Simplex, 1W	Bridge to bridge
14	156.700	156.700	Simplex	Vessel traffic system
15	156.750	Inhibit	Receive only	Environmental
16	156.800	156.800	Simplex	Distress, safety, and calling
17	156.850	156.850	Simplex, 1W	Govt maritime control
18A	156.900	156.900	Simplex	Commercial
19A	156.950	156.950	Simplex	Commercial
20	161.600	157.000	Duplex	Port operation
20A	157.000	157.000	Simplex	Port operation
21A	157.050	157.050	Simplex	Coast guard only
22A	157.100	157.100	Simplex	Coast guard
23A	157.150	157.150	Simplex	Coast guard only
24	161.800	157.200	Duplex	Marine operator
25	161.850	157.250	Duplex	Marine operator
26	161.900	157.300	Duplex	Marine operator
27	161.950	157.350	Duplex	Marine operator
28	162.000	157.400	Duplex	Marine operator
63A	156.175	156.175	Simplex	Vessel traffic system
65A	156.275	156.275	Simplex	Port operation

US Marine Channels				
Ch	RX Freq	TX Freq	Status	Name
66A	156.325	156.325	Simplex	Port operation
67	156.375	156.375	Simplex, 1W	Bridge To Bridge
68	156.425	156.425	Simplex	Non Commercial
69	156.475	156.475	Simplex	Non Commercial
70	156.525	Inhibit	Receive only	Digital Selective Calling
71	156.575	156.575	Simplex	Non Commercial
72	156.625	156.625	Simplex	Non Commercial (Ship-Ship)
73	156.675	156.675	Simplex	Port Operation
74	156.725	156.725	Simplex	Port Operation
75	156.775	156.775	Simplex, 1W	Port Operation
76	156.825	156.825	Simplex, 1W	Port Operation
77	156.875	156.875	Simplex, 1W	Port Operation (Ship-Ship)
78A	156.925	156.925	Simplex	Non Commercial
79A	156.975	156.975	Simplex	Commercial
80A	157.025	157.025	Simplex	Commercial
81A	157.075	157.075	Simplex	Coast Guard
82A	157.125	157.125	Simplex	Coast Guard
83A	157.175	157.175	Simplex	Government
84	161.825	157.225	Duplex	Marine Operator
85	161.875	157.275	Duplex	Marine Operator
86	161.925	157.325	Duplex	Marine Operator
87	157.375	157.375	Simplex	Marine Operator
88	157.425	157.425	Simplex	Commercial (Ship-Ship)

CANADIAN CHANNEL FREQUENCIES AND NAMES

Canadian Marine Channels				
Ch	RX Freq	TX Freq	Status	Name
1	160.650	156.050	Duplex	Marine Operator
2	160.700	156.100	Duplex	Marine Operator
3	160.750	156.150	Duplex	Marine Operator
4A	156.200	156.200	Simplex	Canadian Coast Guard

Canadian Marine Channels				
Ch	RX Freq	TX Freq	Status	Name
5A	156.250	156.250	Simplex	Vessel Traffic System
6	156.300	156.300	Simplex	Inter-Ship Safety
7A	156.350	156.350	Simplex	Commercial
8	156.400	156.400	Simplex	Commercial
9	156.450	156.450	Simplex	Boater Calling Channel
10	156.500	156.500	Simplex	Commercial
11	156.550	156.550	Simplex	Vessel Traffic System
12	156.600	156.600	Simplex	Vessel Traffic System
13	156.650	156.650	Simplex, 1W	Bridge To Bridge
14	156.700	156.700	Simplex	Vessel Traffic System
15	156.750	156.750	Simplex, 1W	Environmental
16	156.800	156.800	Simplex	Distress, safety, calling
17	156.850	156.850	Simplex, 1W	State Control
18A	156.900	156.900	Simplex	Commercial
19A	156.950	156.950	Simplex	Canadian Coast Guard
20	161.600	157.000	Duplex, 1W	Port Operation
21A	157.050	157.050	Simplex	Canadian Coast Guard
22A	157.100	157.100	Simplex	Canadian Coast Guard
23	161.750	157.150	Duplex	Canadian Coast Guard
24	161.800	157.200	Duplex	Marine Operator
25	161.850	157.250	Duplex	Marine Operator
26	161.900	157.300	Duplex	Marine Operator
27	161.950	157.350	Duplex	Marine Operator
28	162.000	157.400	Duplex	Marine Operator
60	160.625	156.025	Duplex	Marine Operator
61A	156.075	156.075	Simplex	Canadian Coast Guard
62A	156.125	156.125	Simplex	Canadian Coast Guard
63A	156.175	156.175	Simplex	Port Operation
64	160.825	156.225	Duplex	Marine Operator
64A	156.225	156.225	Simplex	Port Operation
65A	156.275	156.275	Simplex	Port Operation
66A	156.325	156.325	Simplex, 1W	Port Operation

Canadian Marine Channels				
Ch	RX Freq	TX Freq	Status	Name
67	156.375	156.375	Simplex	Bridge To Bridge
68	156.425	156.425	Simplex	Non Commercial
69	156.475	156.475	Simplex	Non Commercial
70	156.525	Inhibit	Receive only	Digital Selective Calling
71	156.575	156.575	Simplex	Non Commercial
72	156.625	156.625	Simplex	Non Commercial
73	156.675	156.675	Simplex	Port Operation
74	156.725	156.725	Simplex	Port Operation
75	156.775	156.775	Simplex, 1W	Port Operation
76	156.825	156.825	Simplex, 1W	Port Operation
77	156.875	156.875	Simplex, 1W	Port Operation
78A	156.925	156.925	Simplex	Inter Ship
79A	156.975	156.975	Simplex	Inter Ship
80A	157.025	157.025	Simplex	Inter Ship
81A	157.075	157.075	Simplex	Canadian Coast Guard
82A	157.125	157.125	Simplex	Canadian Coast Guard
83	161.775	157.175	Duplex	Canadian Coast Guard
83A	157.175	157.175	Simplex	Canadian Coast Guard
84	161.825	157.225	Duplex	Marine Operator
85	161.875	157.275	Duplex	Marine Operator
86	161.925	157.325	Duplex	Marine Operator
87	157.375	157.375	Simplex	Port Operation
88	157.425	157.425	Simplex	Port Operation

INTERNATIONAL CHANNEL FREQUENCIES AND NAMES

International Marine Channels				
Ch	RX Freq	TX Freq	Status	Name
1	160.650	156.050	Duplex	Marine operator
2	160.700	156.100	Duplex	Marine operator

International Marine Channels				
Ch	RX Freq	TX Freq	Status	Name
3	160.750	156.150	Duplex	Marine operator
4	160.800	156.200	Duplex	Marine operator
5	160.850	156.250	Duplex	Marine operator
6	156.300	156.300	Simplex	Inter-ship safety
7	160.950	156.350	Duplex	Marine operator
8	156.400	156.400	Simplex	Commercial (ship-ship)
9	156.450	156.450	Simplex	Boater calling channel
10	156.500	156.500	Simplex	Commercial
11	156.550	156.550	Simplex	Vessel traffic system
12	156.600	156.600	Simplex	Vessel traffic system
13	156.650	156.650	Simplex	Bridge to bridge
14	156.700	156.700	Simplex	Vessel traffic system
15	156.750	156.750	Simplex, 1W	Environmental
16	156.800	156.800	Simplex	Distress, safety, calling
17	156.850	156.850	Simplex, 1W	Govt maritime control
18	161.500	156.900	Duplex	Port operation
19	161.550	156.950	Duplex	Commercial
20	161.600	157.000	Duplex	Port operation
21	161.650	157.050	Duplex	Port operation
22	161.700	157.100	Duplex	Port operation
23	161.750	157.150	Duplex	Marine operator
24	161.800	157.200	Duplex	Marine operator
25	161.850	157.250	Duplex	Marine operator
26	161.900	157.300	Duplex	Marine operator
27	161.950	157.350	Duplex	Marine operator
28	162.000	157.400	Duplex	Marine operator
60	160.625	156.025	Duplex	Marine operator
61	160.675	156.075	Duplex	Marine operator
62	160.725	156.125	Duplex	Marine operator
63	160.775	156.175	Duplex	Marine operator
64	160.825	156.225	Duplex	Marine operator
65	160.875	156.275	Duplex	Marine operator

International Marine Channels				
Ch	RX Freq	TX Freq	Status	Name
66	160.925	156.325	Duplex	Marine operator
67	156.375	156.375	Simplex	Bridge to bridge
68	156.425	156.425	Simplex	Non commercial
69	156.475	156.475	Simplex	Non commercial
70	156.525	Inhibit	Receive only	Digital Selective Calling
71	156.575	156.575	Simplex	Non commercial
72	156.625	156.625	Simplex	Non commercial
73	156.675	156.675	Simplex	Port operation
74	156.725	156.725	Simplex	Port operation
75	156.775	156.775	Simplex, 1W	Port operation
76	156.825	156.825	Simplex, 1W	Port operation
77	156.875	156.875	Simplex	Port operation (ship-ship)
78	161.525	156.925	Duplex	Port operation
79	161.575	156.975	Duplex	Port operation
80	161.625	157.025	Duplex	Port operation
81	161.675	157.075	Duplex	Port operation
82	161.725	157.125	Duplex	Port operation
83	161.775	157.175	Duplex	Port operation
84	161.825	157.225	Duplex	Marine operator
85	161.875	157.275	Duplex	Marine operator
86	161.925	157.325	Duplex	Marine operator
87	157.375	157.375	Simplex	Marine operator
88	157.425	157.425	Simplex	Marine operator

REGULATIONS AND SAFETY WARNINGS

WARNING! Read this information before using the radio.

MARITIME RADIO SERVICES OPERATION

Warning! This transmitter will operate on channels/frequencies that have restricted use in the United States. The channel assignments include frequencies assigned for exclusive use of the U.S. Coast Guard, use in Canada, and use in international waters. Operation on these frequencies without proper authorization is strictly forbidden. See pages 20 through 25 for tables of the available channels and their uses. If you are still not certain which channels to use, see the FCC maritime radio page at the FCC website (<http://wireless.fcc.gov/marine/>) or contact the FCC Call Center at 1-888-CALL-FCC. For individuals requiring a license, such as commercial users, you should obtain a license application from your nearest FCC field office (for US users) or Industry Canada (for Canadian users).

BASIC RADIO GUIDELINES

You should familiarize yourself with the rules on marine radios and be aware of which rules apply to your boat. Complete guidelines for all ship and marine radio types can be found at the US Coast Guard website under the topic Radio Info for Boaters (the direct link is:

<http://www.navcen.uscg.gov/marcomms/boater.htm>).

Here are a few guidelines that affect nearly all boaters:

- If you have a VHF radio on your boat, you must maintain a watch on channel 16 (156.800 MHz) whenever the radio is not being used to communicate. Starting in 2004, if a radio is carried, it must be on and set to channel 16 whenever your boat is underway.
- If you hear a distress call, wait a few minutes to let a shore station or Coast Guard vessel respond. If no other station

has responded after 5 minutes, you must respond to the distress call.

- Do not make false mayday or distress calls as a prank or to test your radio. (This is essentially like making a false 9-1-1 call; you may be subject to fines.)

FCC/Industry Canada Information

- Certification: FCC Part 80 or RSS-182
- Output Power: 2.5W
- Emission: 16K0F3E
- Transmitter Frequency Range: 156.025-157.425 MHz

This device complies with Part 15 of the FCC Rules.

Operation is subject to the condition that this device does not cause harmful interference.

Unauthorized changes or modifications to this equipment may void compliance with the FCC Rules. Any change or modification must be approved in writing by Uniden. Changes or modifications not approved by Uniden could void the user's authority to operate the equipment.

FCC RF Exposure Information

In August 1996 the Federal Communications Commission (FCC) of the United States with its action in Report and Order FCC 96-326 adopted an updated safety standard for human exposure to radio frequency electromagnetic energy emitted by FCC regulated transmitters. Those guidelines are consistent with the safety standard previously set by both U.S. and international standards bodies. The design of the radio complies with the FCC guidelines and these international standards.

Never allow children to operate the radio without adult supervision and the knowledge of the following guidelines.

WARNING! It is up to the user to properly operate this radio transmitter to insure safe operation. Please adhere to the following:

- Use only the supplied or an approved antenna. Unauthorized antennas, modifications, or attachments could impair call quality, damage the radio, or violate FCC regulations.
- Do not use the radio with a damaged antenna. If a damaged antenna comes into contact with the skin, a minor burn may result. Please contact your local dealer for a replacement antenna.

RF Exposure Information

For hand-held operation, the radio should be held 1 inch from the user's face. The use of accessories that do not satisfy these requirements may not comply with FCC RF exposure requirements and should be avoided. For more information about RF exposure, please visit the FCC website at **www.fcc.gov**.

Avoid exposing the battery (whether attached to the radio or not) to direct sunlight, heated cars, or temperatures below -4°F (-20°C) or above $+140^{\circ}\text{F}$ ($+60^{\circ}\text{C}$). Exposing the chemical contained within the battery pack to temperatures above $+140^{\circ}\text{F}$ ($+60^{\circ}\text{C}$) may cause the battery to rupture, fail, or reduce performance.

In case of exposure to the cell contents, wash the affected area thoroughly, and seek medical attention.

Three Year Limited Warranty

WARRANTOR: UNIDEN AMERICA CORP. (“Uniden”)

ELEMENTS OF WARRANTY: Uniden warrants, for three years, to the original retail owner, this Uniden Product to be free from defects in materials and craftsmanship with only the limitations or exclusions set out below.

WARRANTY DURATION: This warranty to the original user shall terminate and be of no further effect 36 months after the date of original retail sale. The warranty is invalid if the Product is (A) damaged or not maintained as reasonable or necessary, (B) modified, altered, or used as part of any conversion kits, subassemblies, or any configurations not sold by Uniden, (C) improperly installed, (D) serviced or repaired by someone other than an authorized Uniden service center for a defect or malfunction covered by this warranty, (E) used in any conjunction with equipment or parts or as part of any system not manufactured by Uniden, or (F) installed or programmed by anyone other than as detailed by the Operating Guide for this product.

STATEMENT OF REMEDY: In the event that the product does not conform to this warranty at any time while this warranty is in effect, warrantor will repair the defect and return it to you without charge for parts, service, or any other cost (except shipping and handling) incurred by warrantor or its representatives in connection with the performance of this warranty. **THE LIMITED WARRANTY SET FORTH ABOVE IS THE SOLE AND ENTIRE WARRANTY PERTAINING TO THE PRODUCT AND IS IN LIEU OF AND EXCLUDES ALL OTHER WARRANTIES OF ANY NATURE WHATSOEVER, WHETHER EXPRESS, IMPLIED OR ARISING BY OPERATION OF LAW, INCLUDING, BUT NOT LIMITED TO ANY IMPLIED WARRANTIES OF MERCHANTABILITY OR FITNESS FOR A PARTICULAR PURPOSE. THIS WARRANTY DOES NOT COVER OR PROVIDE FOR THE REIMBURSEMENT OR PAYMENT OF INCIDENTAL OR CONSEQUENTIAL DAMAGES.** Some states do not allow this

exclusion or limitation of incidental or consequential damages so the above limitation or exclusion may not apply to you.

LEGAL REMEDIES: This warranty gives you specific legal rights, and you may also have other rights which vary from state to state. This warranty is void outside the United States of America.

PROCEDURE FOR OBTAINING PERFORMANCE OF WARRANTY: If, after following the instructions in this Operating Guide you are certain that the Product is defective, pack the Product carefully (preferably in its original packaging). Include evidence of original purchase and a note describing the defect that has caused you to return it. The Product should be shipped freight prepaid, by traceable means, or delivered, to warrantor at:

Uniden America Corporation
Parts and Service Division
4700 Amon Carter Boulevard
Fort Worth, TX, 76155
(800) 554-3988



QUESTIONS?
Visit our website at
www.uniden.com or
call 1-800-297-1023.

QUESTIONS?
Contactez-nous au
www.uniden.com ou
appelez 1-800-297-1023.

Printed in China

Imprimé en Chine

U01UT639BZA(0)