TABLE OF CONTENTS

Introduction	2
What is Scanning?	2
What is Searching?	2
Types of Communications	3
Feature Highlights	4
Where to Obtain More Information	5
Included with Your Scanner	6
Setup	7
Installing the Batteries	7
AC Adapter/Charger	8
Charging Warning	8
Adapter Safety Feature	9
Flexible Antenna	9
Belt Clip	9
Basic Operation	10
Setting the Squelch	10
Keylock	12
Programming	13
Duplicate Frequency Alert	14
Programming Tips	15
Scanning	16
Channel Lockout	17
Lockout in Manual Mode	17
Locking a Channel While Scanning	18
Lockout Tips	18
Restore a Locked Out Channel	19
Restore All Locked-out Channels	20
Priority Scan	21
Changing the Priority Channel	22
Chain Search	23
Setting a Search Range	23
Search Hold Feature	26
Channel Skip	27
Storing Search Frequencies	27
Weather Scan	30
Care and Maintenance	31
General Use	31
Location	31
Cleaning	31
Repairs	32
Birdies	32
Troubleshooting	33
Specifications	34
Accessories and Replacement Parts	35
One Year Limited Warranty	36

Introduction

The **BC60XLT-1** Scanner is a sophisticated information radio that allows you to monitor 10 different frequency bands and the NOAA weather information broadcasts. It is a state-of-the-art radio with scanning capabilities, and it can save up to 30 different frequencies in memory.

What is Scanning?

Unlike standard AM or FM radio stations, most two-way communications do not transmit continuously. The **BC60XLT-1** scans *programmed* channels until it finds an active frequency.

Scanning stops on an active frequency and remains on that channel as long as the transmission continues. When the transmission ends, the scanning cycle resumes until another transmission is received.

What is Chain Searching?

You can program five different personal search bands in your new scanner. You simply select a Chain Search location, define the search range, and begin your search. The scanner looks for active communications in the range you've specified, so you can locate frequencies in your area which may not be listed in your *Betty Bearcat Starter Frequency Guide*.

You can set your scanner to search up to all five Chain Search bands at once, or you can turn off those search bands you don't want. This gives you complete control of the search function.

Types of Communications

Monitor communications such as:

- Police and fire department (including rescue and paramedics)
- NOAA weather broadcasts (preprogrammed channels)
- Business/industrial radio
- Motion picture and press relay
- Utilities
- Land transportation frequencies, such as trucking firms, buses, taxis, tow trucks, and railroads
- Marine and amateur (ham radio) bands
- And more in these bands:

Frequency Range	Transmission
29-29.7 MHz	10 Meter Amateur Band
29.7-50 MHz	VHF Low Band
50-54 MHz	6 Meter Amateur Band
137-144 MHz	Military Land mobile
144-148 MHz	2 Meter Amateur Band
148-174 MHz	VHF High Band
406-420 MHz	Federal Govt. Land Mobile
420-450 MHz	70 cm Amateur Band
450-470 MHz	UHF Standard Band
470-512 MHz	UHF "T" Band

Feature Highlights

- **30 Channels** – Program one frequency into each channel. You must have at least one channel programmed to use the Scan mode.
- **29 MHz-512 MHz** – Search these frequency ranges with your scanner. (The frequency coverage is not totally continuous from 29 MHz to 512 MHz.)
- **Chain Searching** – You can define five different personal search bands, and search up to all five chain locations at once.
- **Priority Channel Scanning** – Allows you to designate a priority channel which is monitored every two seconds when Priority Scanning is selected.
- **Manual Channel Access** – Go directly to any channel.
- **Memory Backup** – Frequencies programmed in channels are retained in memory. If power is completely disconnected, the frequencies are retained for one hour.
- **Weather Scan** – Use as a weather information radio.
- **Preset Two-second Delay** – Scanner waits two seconds after transmission stops before resuming scanning.
- **LCD Back Light** – An orange LCD light remains on for 15 seconds when  is pressed.

Where to Obtain More Information

Before using your scanner, you must program frequencies into available channels. The *Betty Bearcat Starter Frequency Guide* lists typical frequencies used around the U.S.A. and Canada that you may program into your new scanner.

If the frequencies listed in the starter guide do not work in your area, call the enclosed **Mr. Scanner (800) Number**. A Uniden representative should be able to provide you with sample frequencies, or use the enclosed order form to purchase a local frequency list.

The Bearcat Radio Club and other similar hobby clubs have publications, information on computer bulletin boards, and even contests for the radio enthusiast. Also, your local library has more information.

Included with Your Scanner

If any of these items are missing or damaged, immediately contact your place of purchase or Uniden Customer Service at: (800) 297-1023, 8:00 a.m. to 5:00 p.m., Central, Monday through Friday.



Belt Clip
with
Screws
(BCK150)

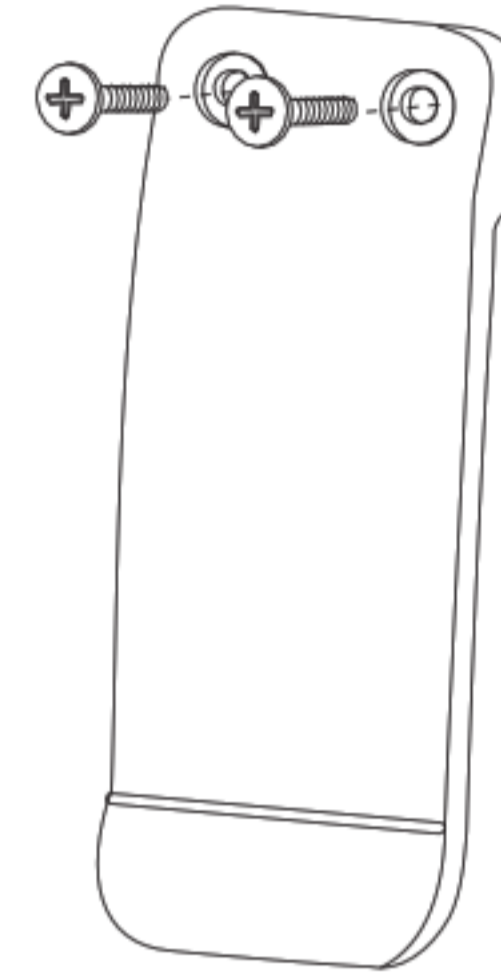

AC Adapter
(AD70U)

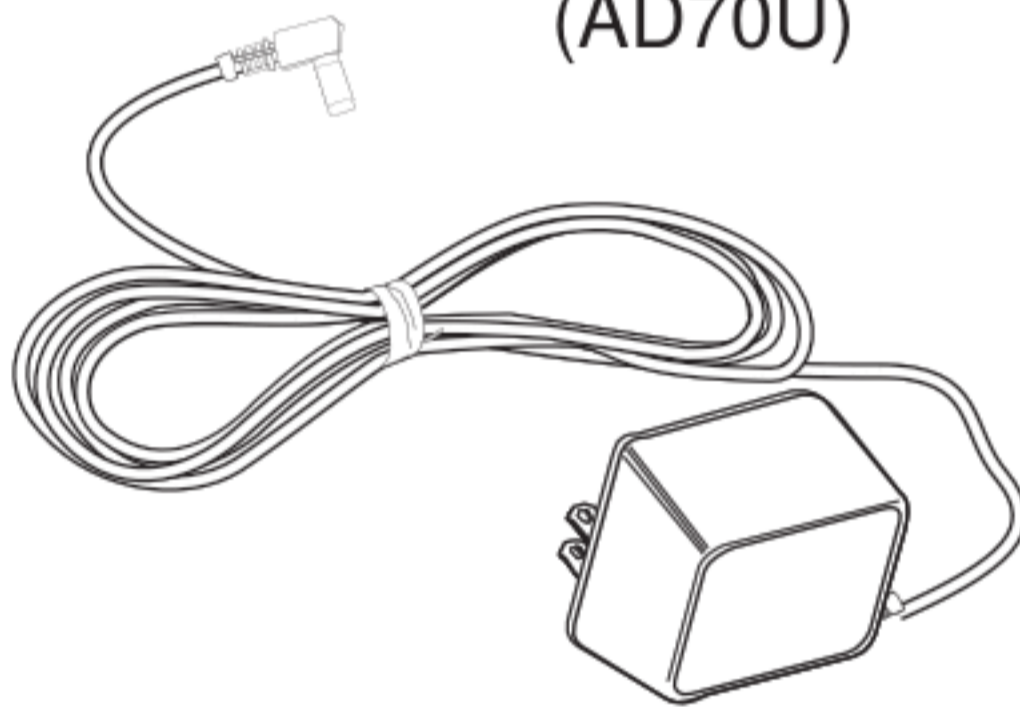

BC60XLT-1
Operating Guide
(OMBC60XLT1)



Betty Bearcat
Starter
Frequency
Guide



Other
Printed
Material

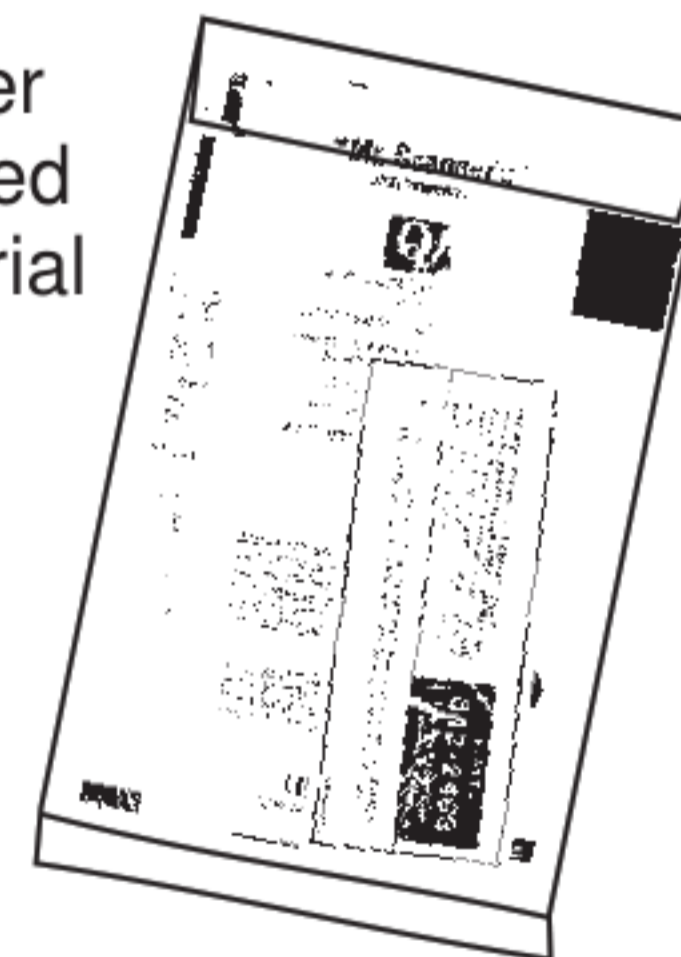

Setup

These are helpful guidelines when using your new scanner:

- If your scanner receives interference or electrical noise, move the scanner or its antenna away from the source.
- If you need to improve reception, use an optional antenna designed for multi-band coverage. (You can purchase this type of antenna at a local electronics store.)
- Use the included earphone or an optional stereo headset with proper impedance for private listening. Read the precautions on the inside front cover of this Guide.

Installing the Batteries

1. Open the cover.

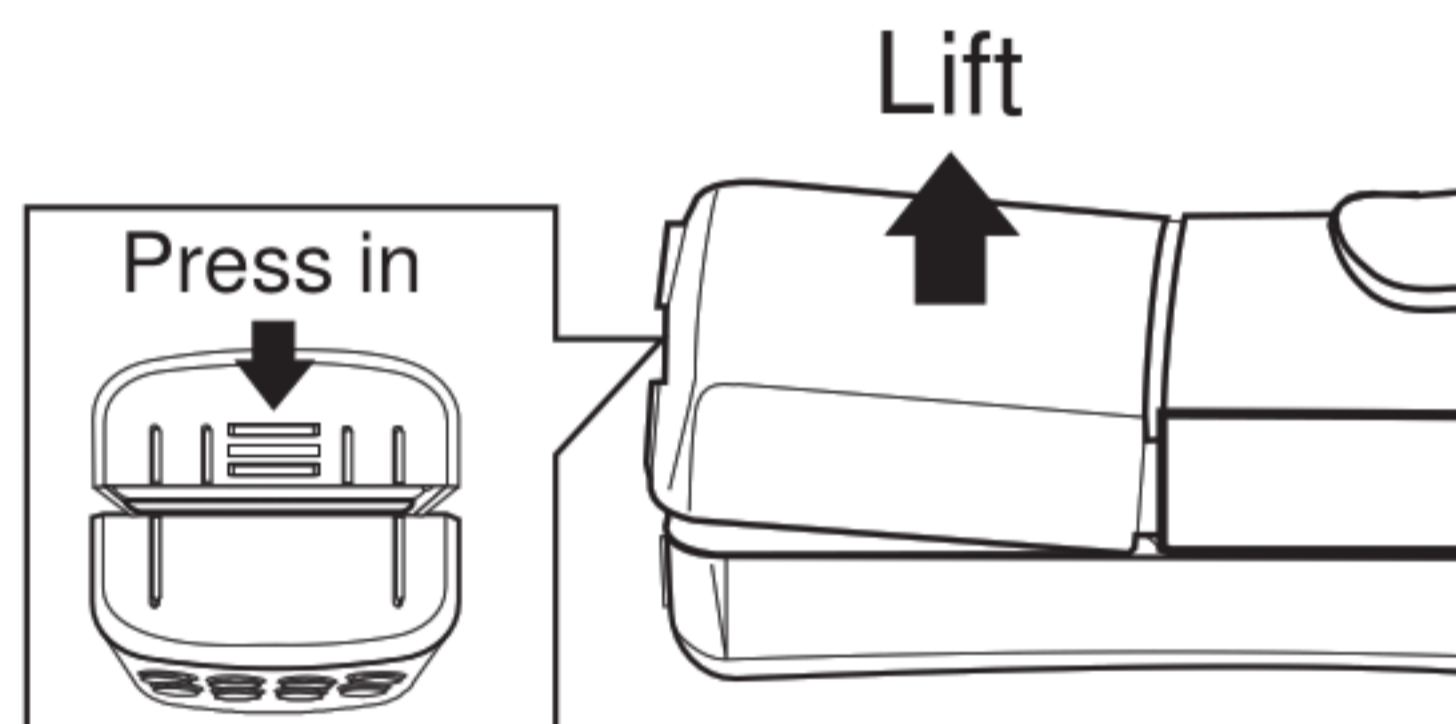

2. Insert batteries.

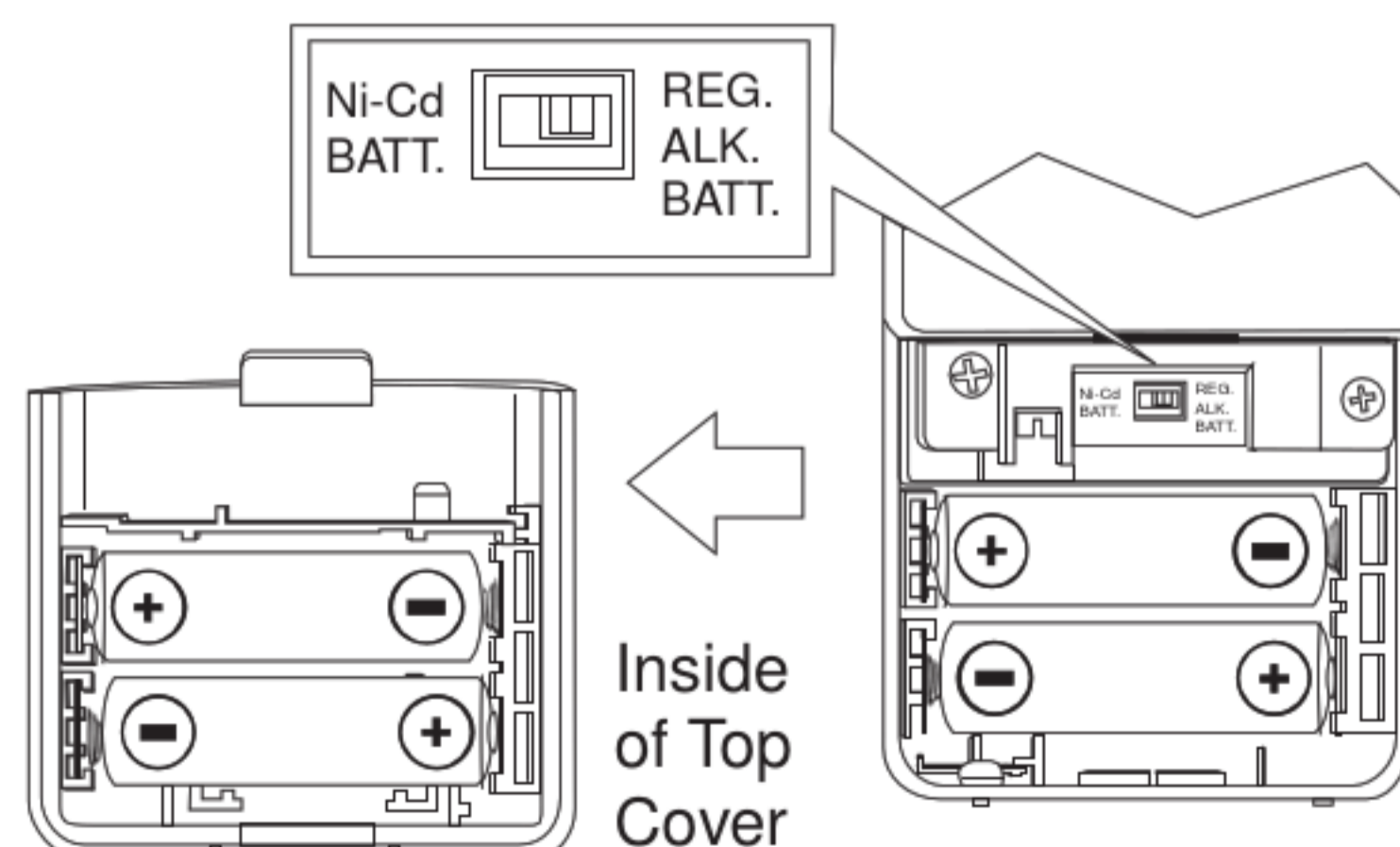

Note: If you are installing alkaline batteries, set the switch to **REG. ALK. BATT.** If installing Nickel-Cadmium Batteries, set the switch to **Ni-Cd BATT.**

3. Replace cover and press down until it clicks into place.

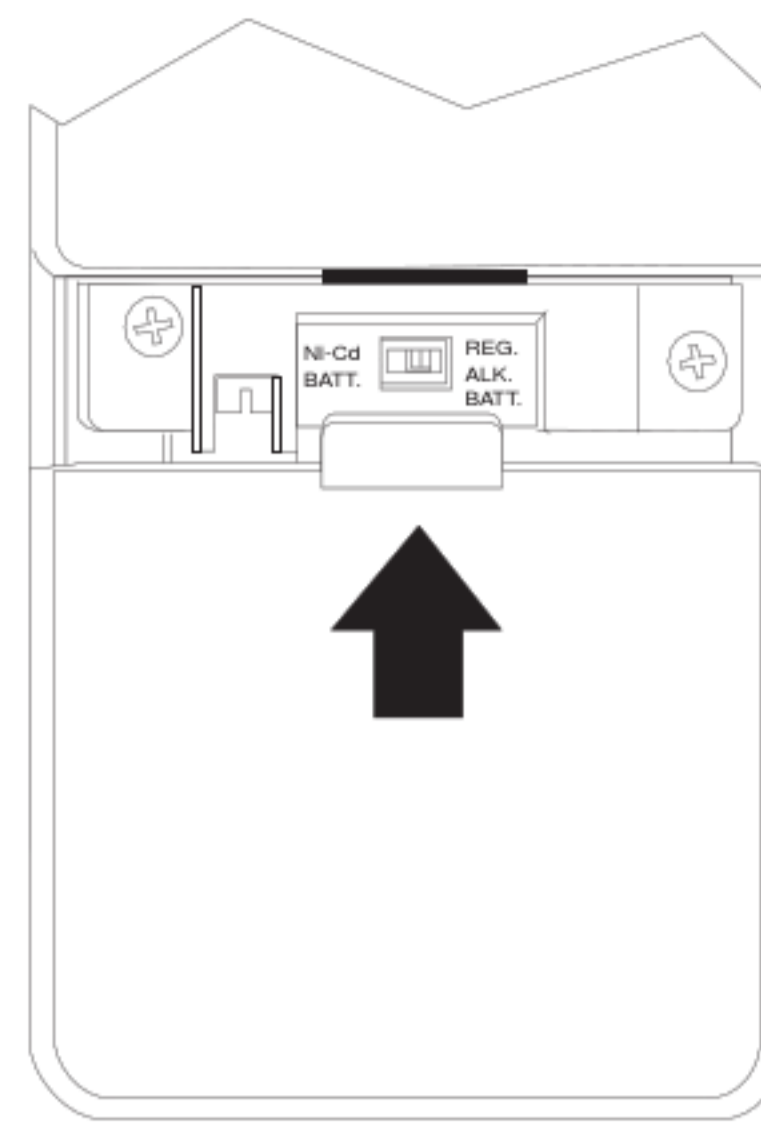

Warning: Do not mix alkaline batteries with Ni-Cd Batteries. Be sure to install four batteries of the same type.

AC Adapter/Charger

Use the AC Adapter/Charger to power the *BC 60XLT-1* from an AC outlet.

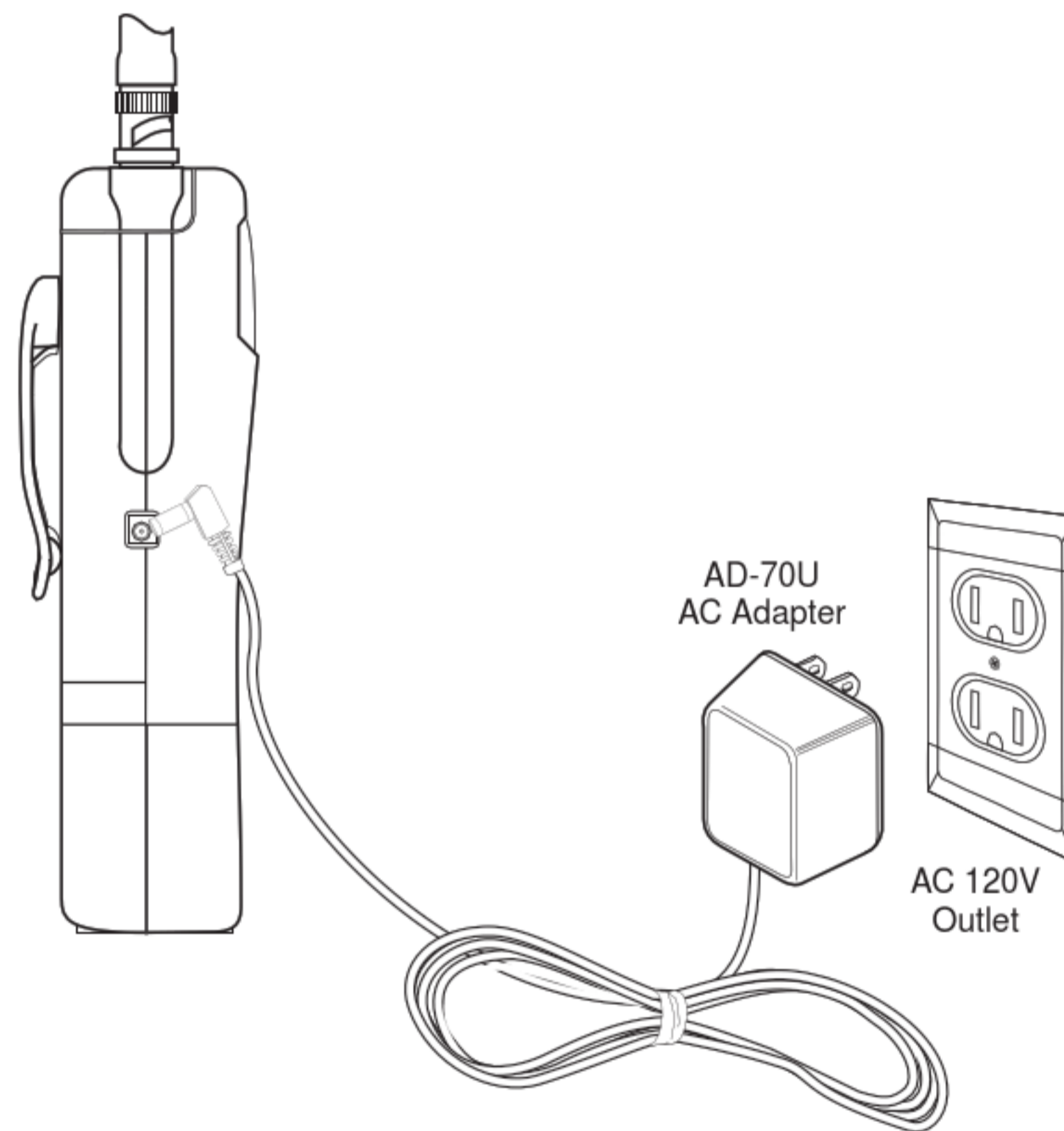

Use only the supplied AC Adapter (AD70U) or one of the optional power cords (UA502 or UA510).

Charging Warning

Do not charge alkaline batteries in this scanner. Doing so may cause serious damage to the product and void the warranty. Before attempting to recharge batteries, make sure you have installed four rechargeable nickel-cadmium batteries and the selector switch is set to **Ni-Cd BATT.**

Adapter Safety Feature

The AC Adapter included with this scanner may be equipped with a polarized line plug — a plug with one blade wider than the other. This plug will fit into the power outlet only one way. If you are unable to insert the plug fully into the outlet, try reversing the plug.

Flexible Antenna

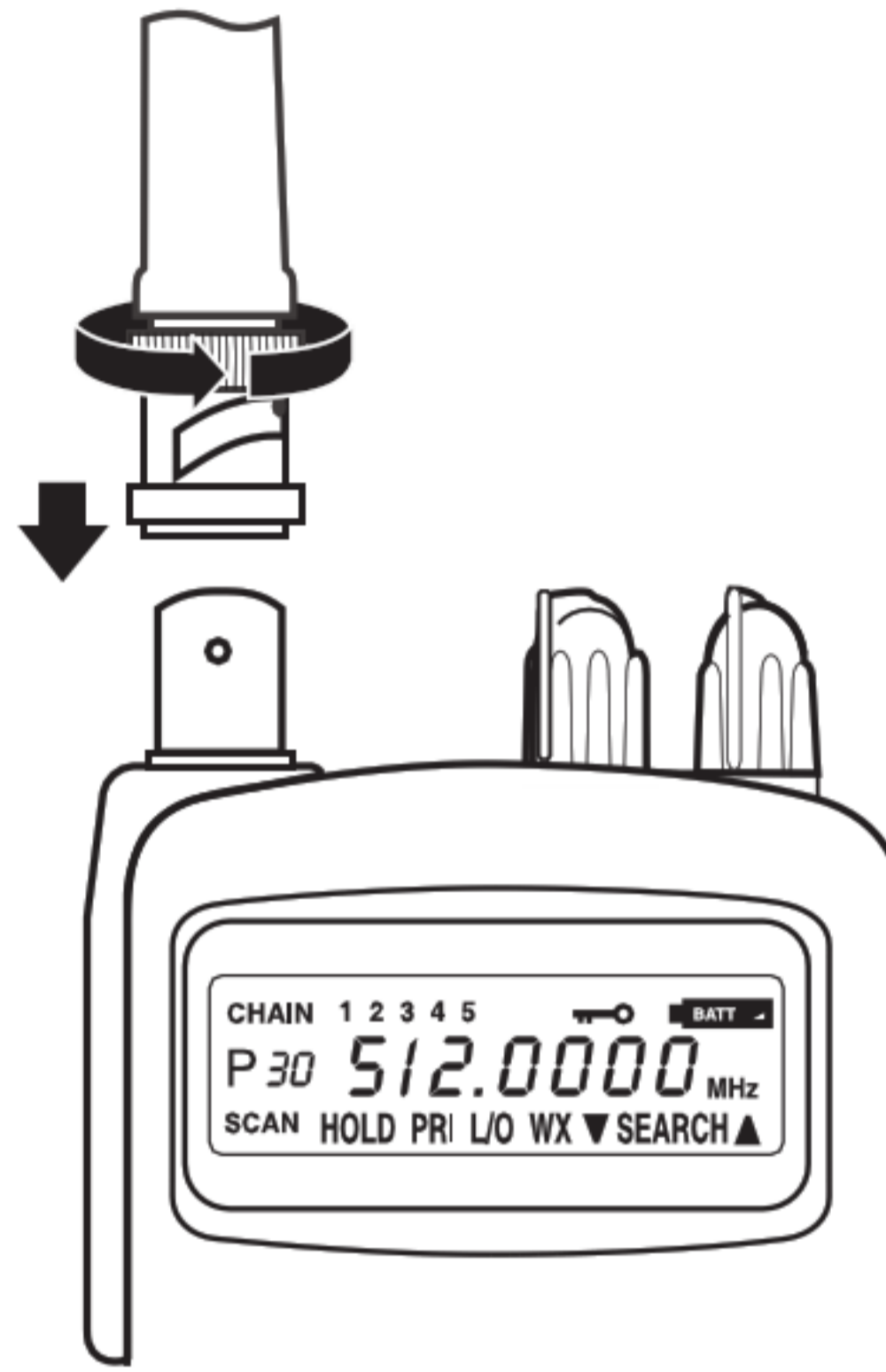

Attach the flexible antenna to the **BNC** connector.

Belt Clip

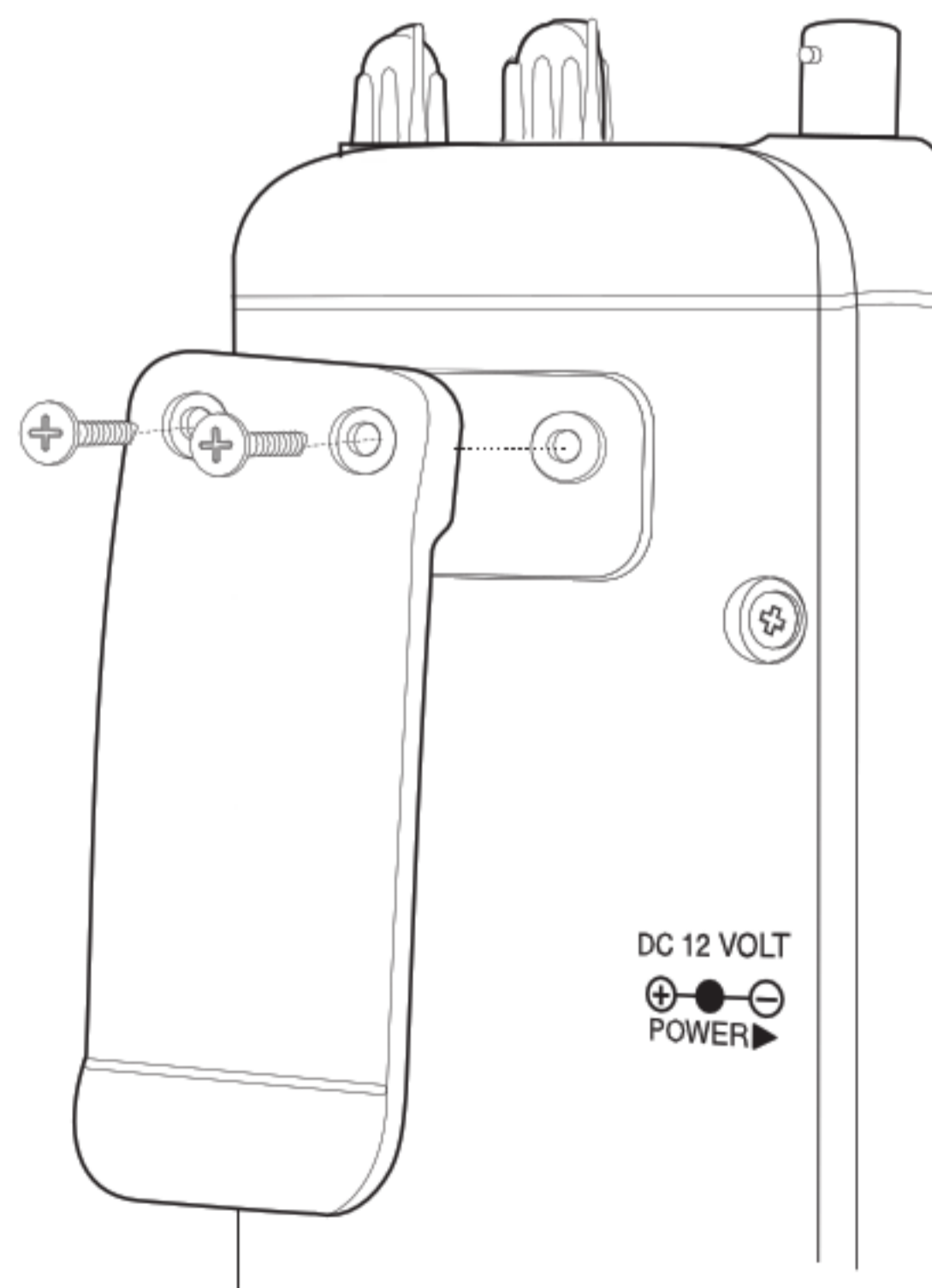

Do not tighten the screws too tight.
You can damage the case or clip.

Basic Operation

Note: You can fold out the Front Cover to see the Controls and Indicators while reading this Guide.

Setting the Squelch

To set the Squelch, you must be in the Manual Mode. No signal should be present when adjusting squelch.

1. Press **MANUAL** until you do not hear a signal.

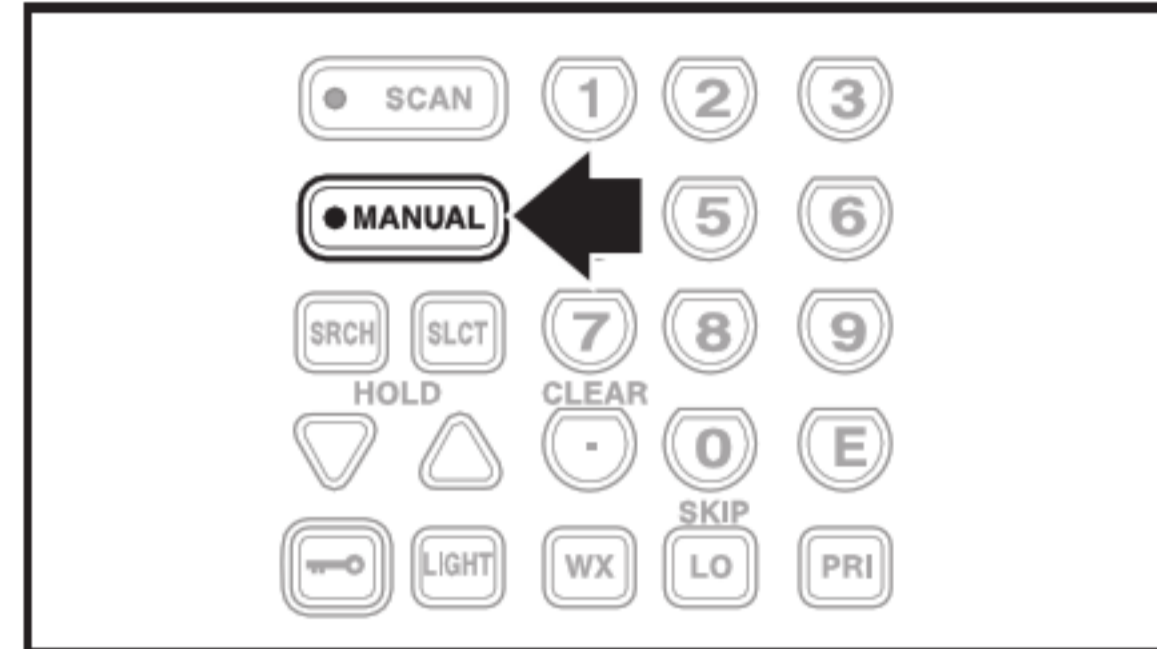

2. Adjust **VOLUME** to a comfortable listening level.

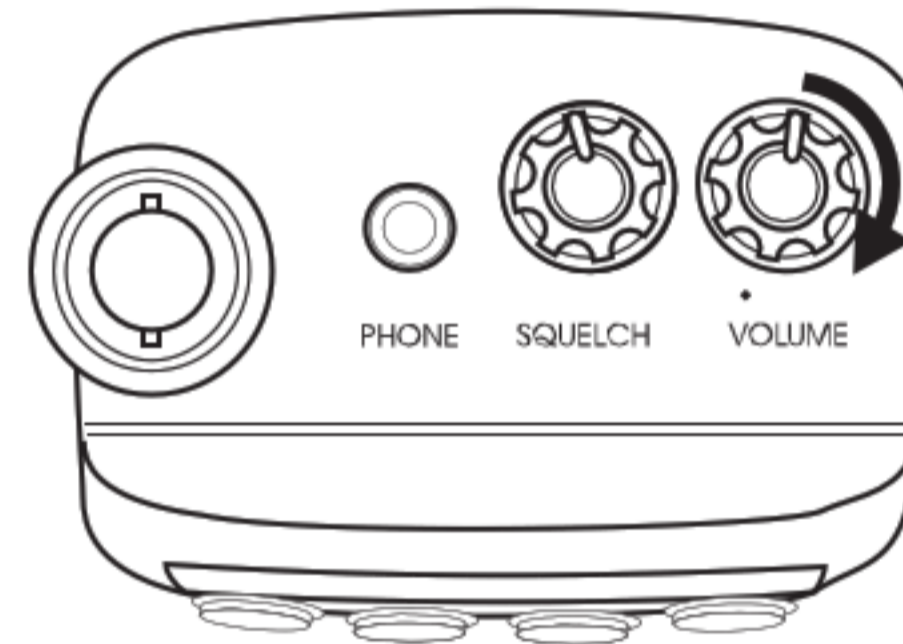

3. Think of the Squelch Control as a gate. Turn **SQUELCH** fully counter-clockwise. This raises the "Squelch Gate" so high that no signals can get through.

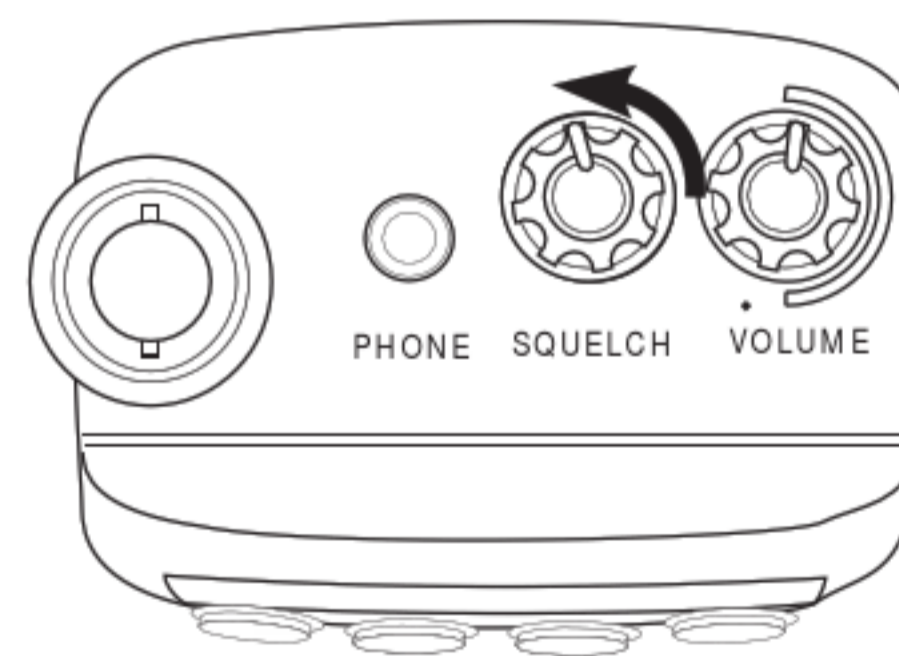
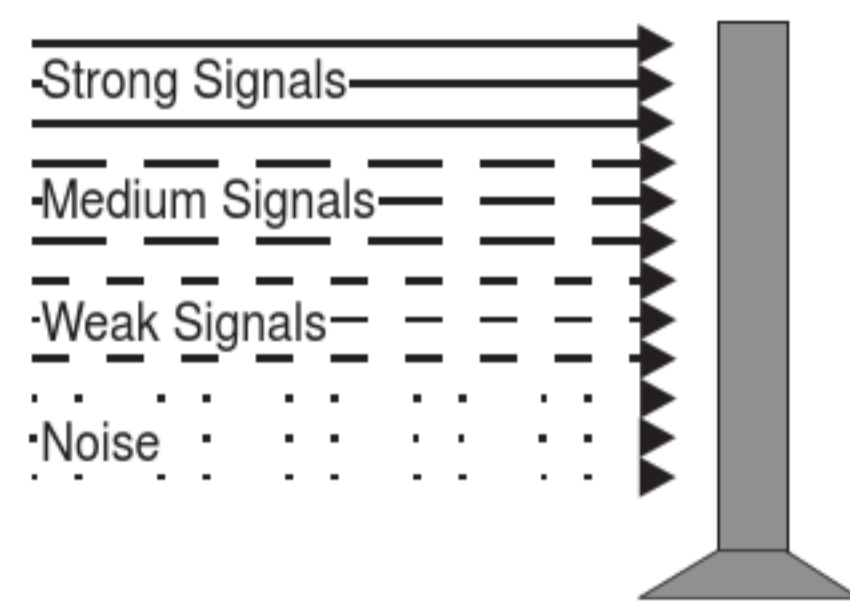

4. Turn **SQUELCH** fully clockwise until you hear a hiss. This lowers the “Squelch Gate” so that everything gets through—noise, weak signals, and strong signals.

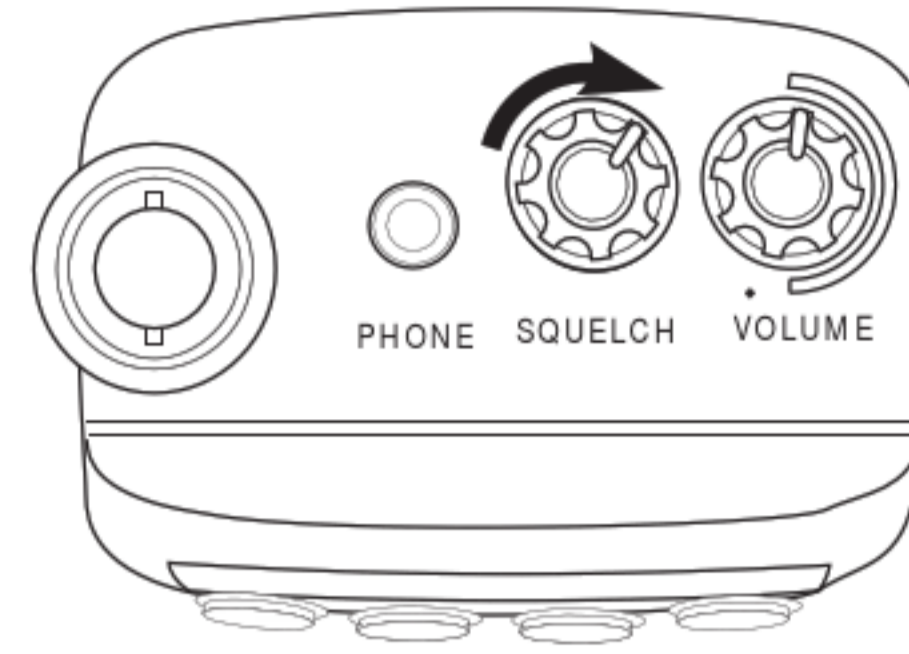
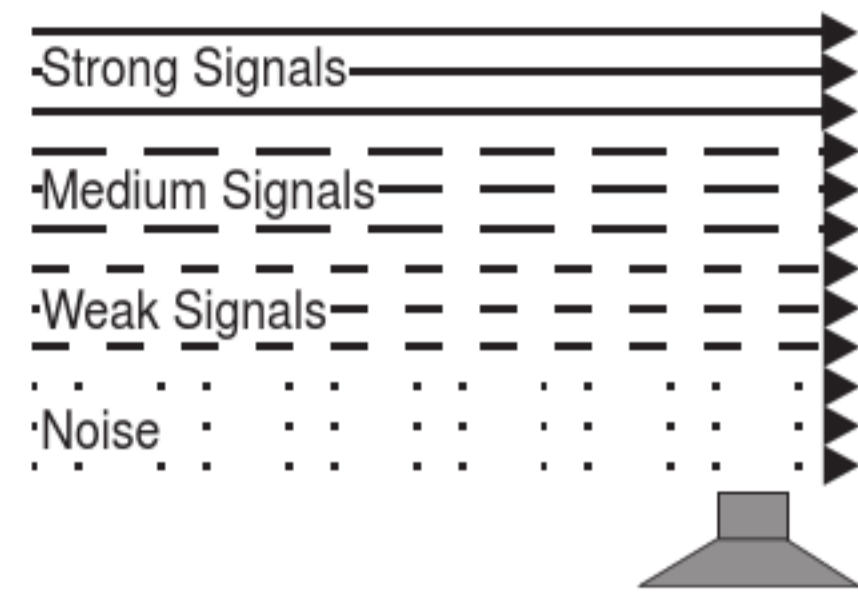

5. Turn **SQUELCH** back counter-clockwise just until the hiss stops. Now the “Squelch Gate” allows only strong signals through.

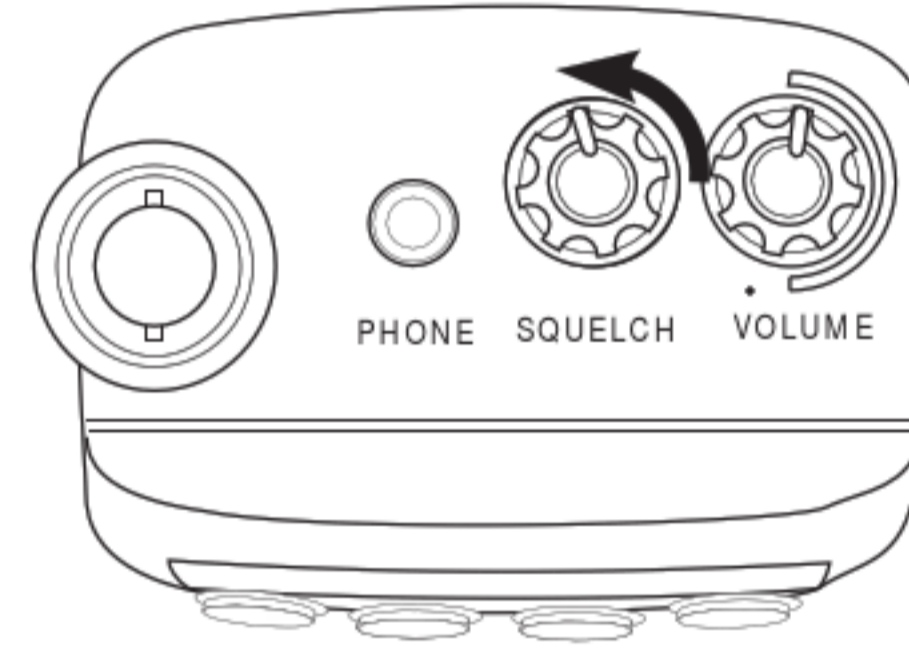
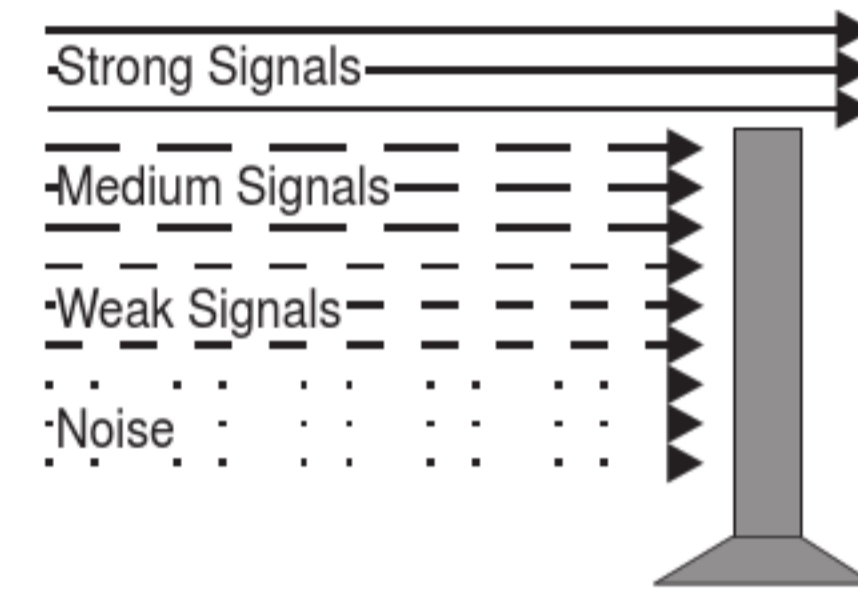

Keylock

Key Lock prevents accidental key entries during scanning.

1. To lock the keypad, press and hold  until the key symbol appears.

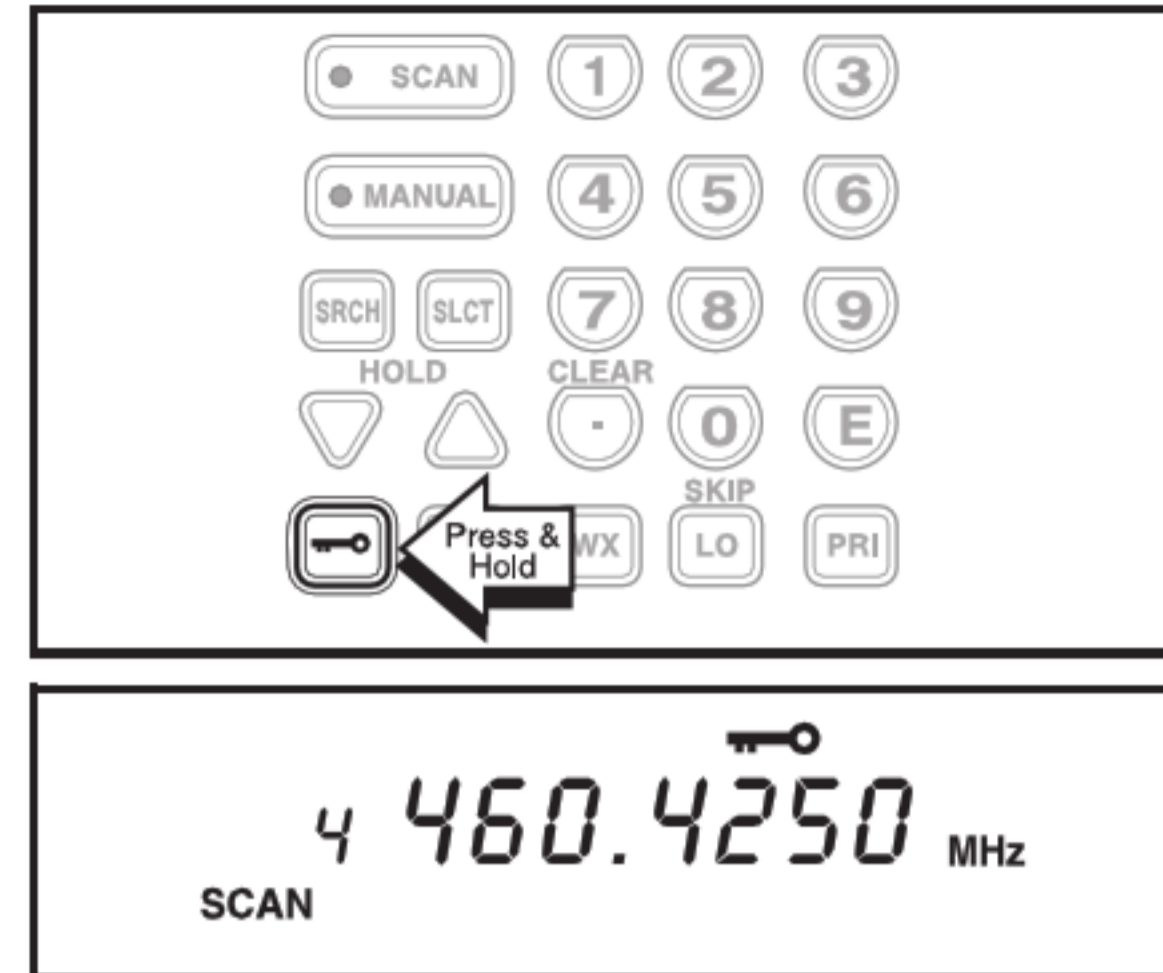

2. To unlock the keypad, press and hold  until the key symbol disappears.

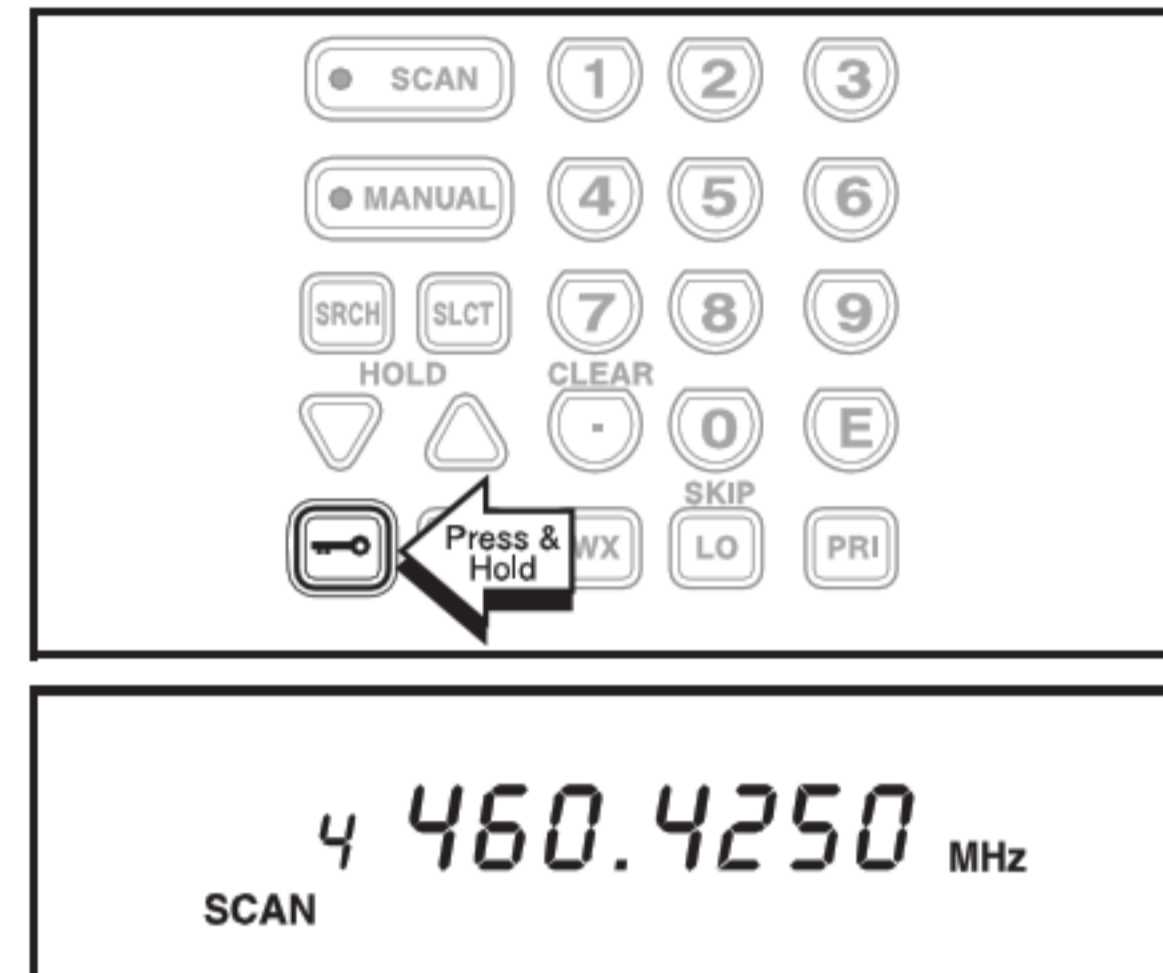

Programming

Before the *BC 60XLT - 1* can receive radio broadcasts, you must program a frequency into at least one channel. Before scanning, repeat this procedure for each channel you program.

1. Select frequencies from your starter guide.

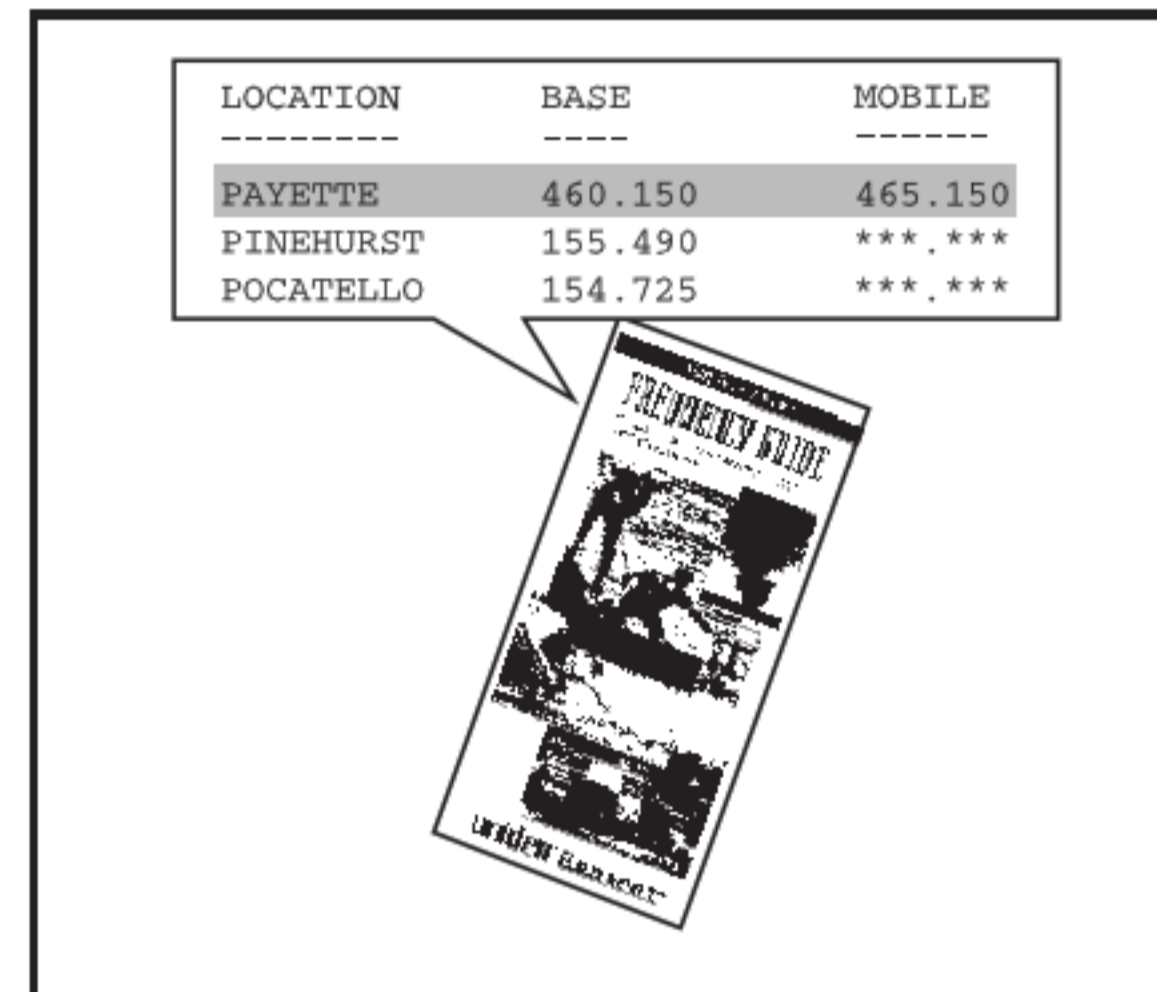

2. Press **MANUAL**.

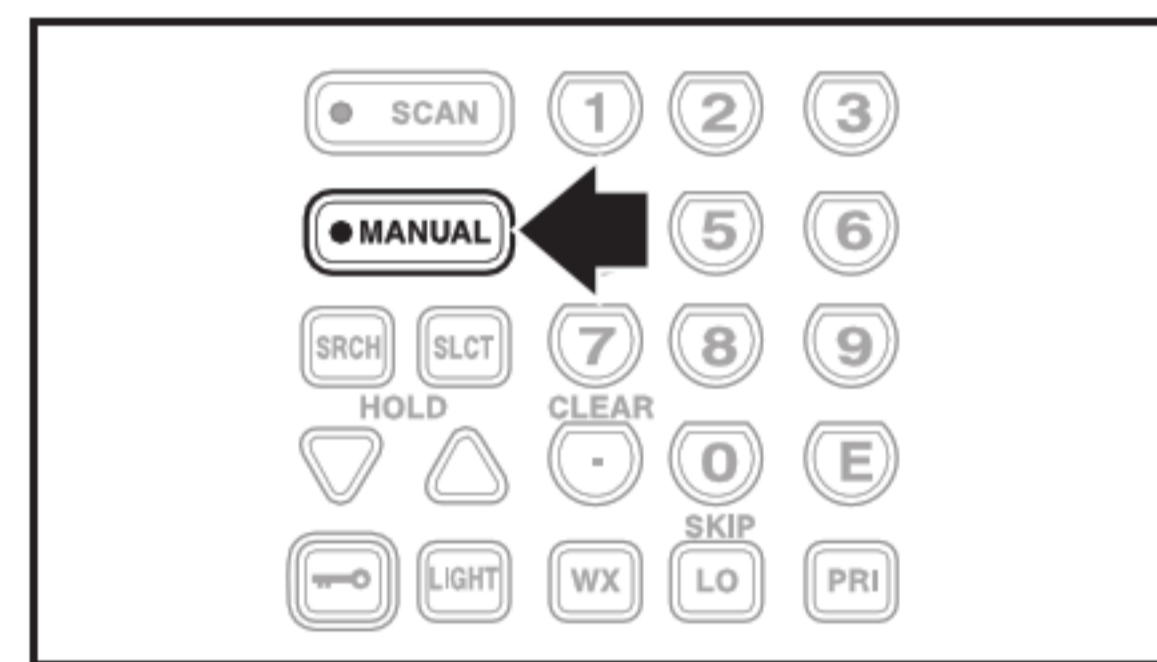

3. Select a channel.
 - a. Enter the channel number.
 - b. Then press **MANUAL**.

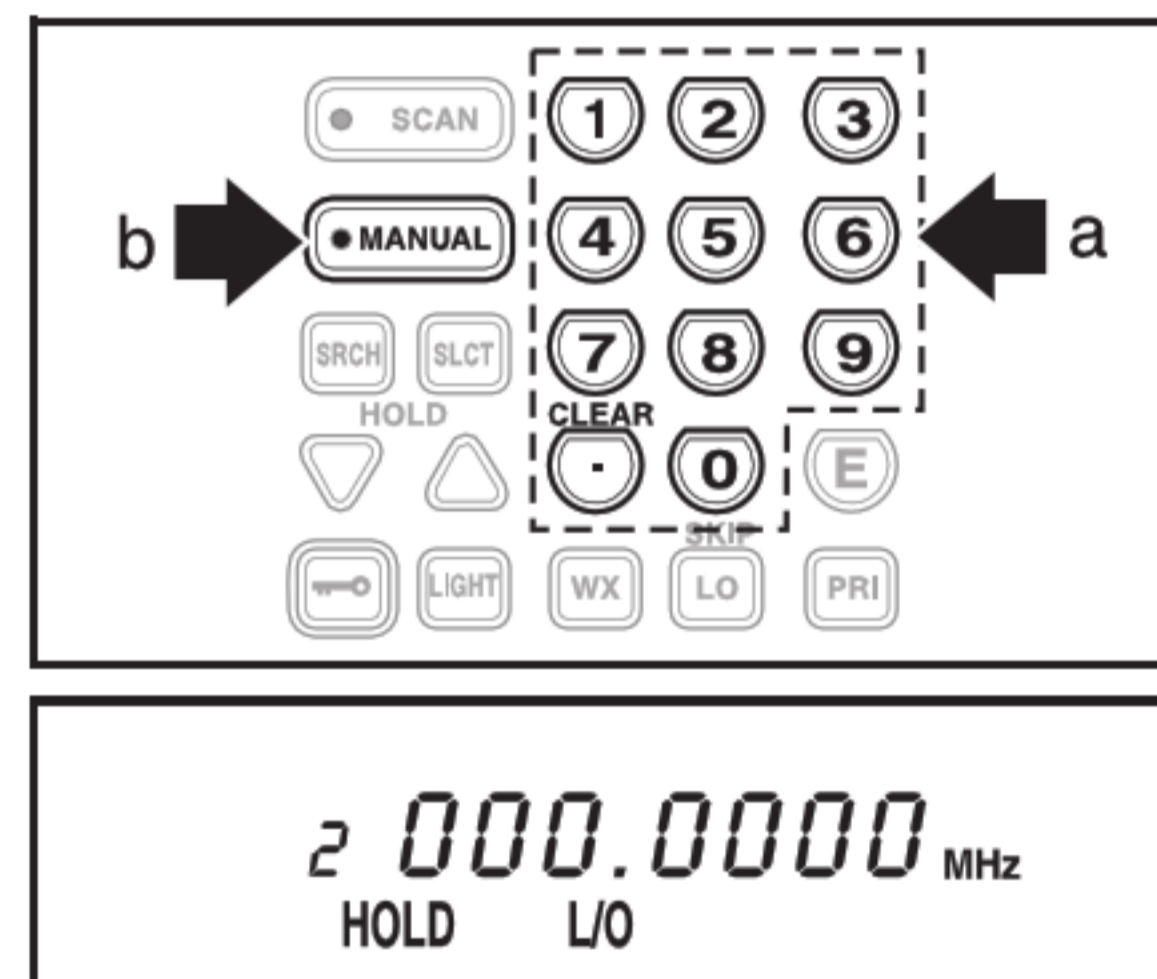

4. Enter the frequency.
 - a. Enter the frequency number.
 - b. Then press .

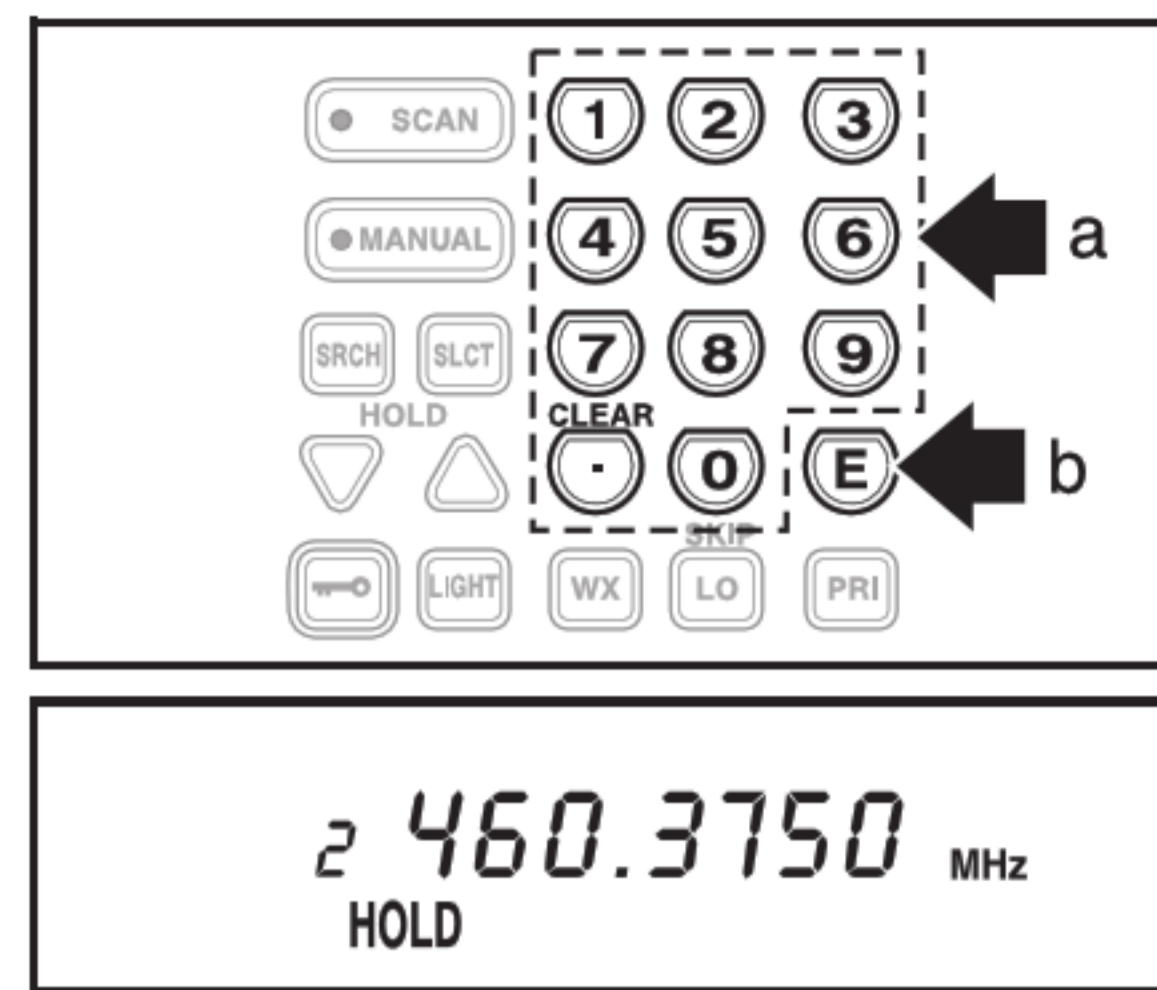

Note: To clear a mistake while entering the frequency, press  twice, and start over.

If the frequency entered is outside the Frequency Range of the scanner, a distinctive beep sounds. (See the Table on page 3 or the Band List on the back of the scanner).

Press  and go back to Step 4.

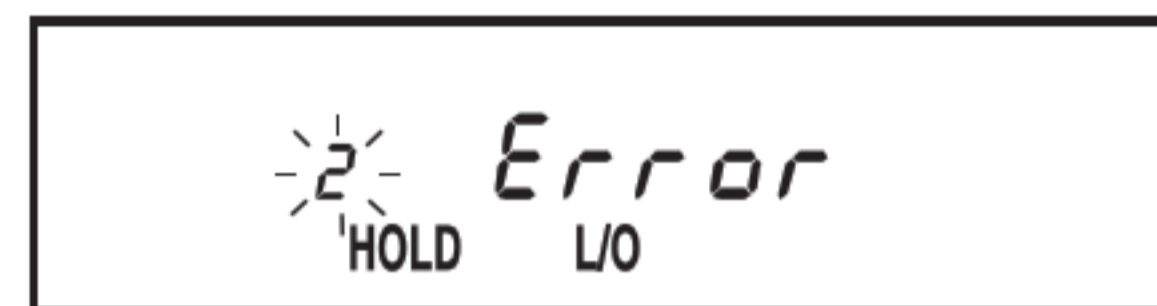

Duplicate Frequency Alert

If you enter a frequency stored in another channel, you hear a beep and the other channel appears in the display.

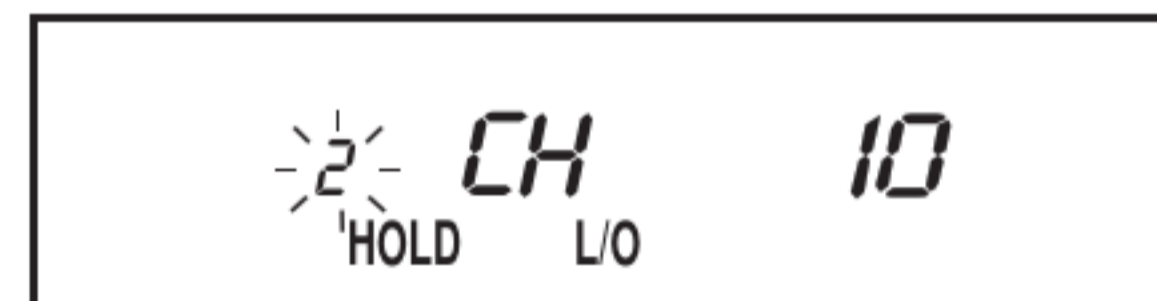

Press  to start again

—OR—

Press  again to store the frequency in both channels.

Programming Tips

- Do not program a weather frequency into one of the channels, since weather channels transmit continuously. Use **WX** for weather information.
- Group similar frequencies into adjacent channels. For example, program police frequencies in channels 1 through 10 and fire/emergency into channels 11 through 20, and so on.
- Put the frequency that you listen to the most or the most important frequency into a Priority channel.
- To quickly program a series of channels, start with the lowest number channel. For example, when you are programming five new frequencies into Channels 4 through 8, start with Channel 4. After you finish programming a channel, press **MANUAL** or **▲** to go to the next higher channel.
- To erase the channel, press **0**, and then press **E**. Channels with no frequencies are automatically locked out.



- Record channels and frequencies in some convenient place in case the scanner memory is lost.

Scanning

When you turn on the power, the BC60XLT-1 automatically starts in the Scan mode.



During normal scanning the scanner skips unprogrammed or locked out channels.

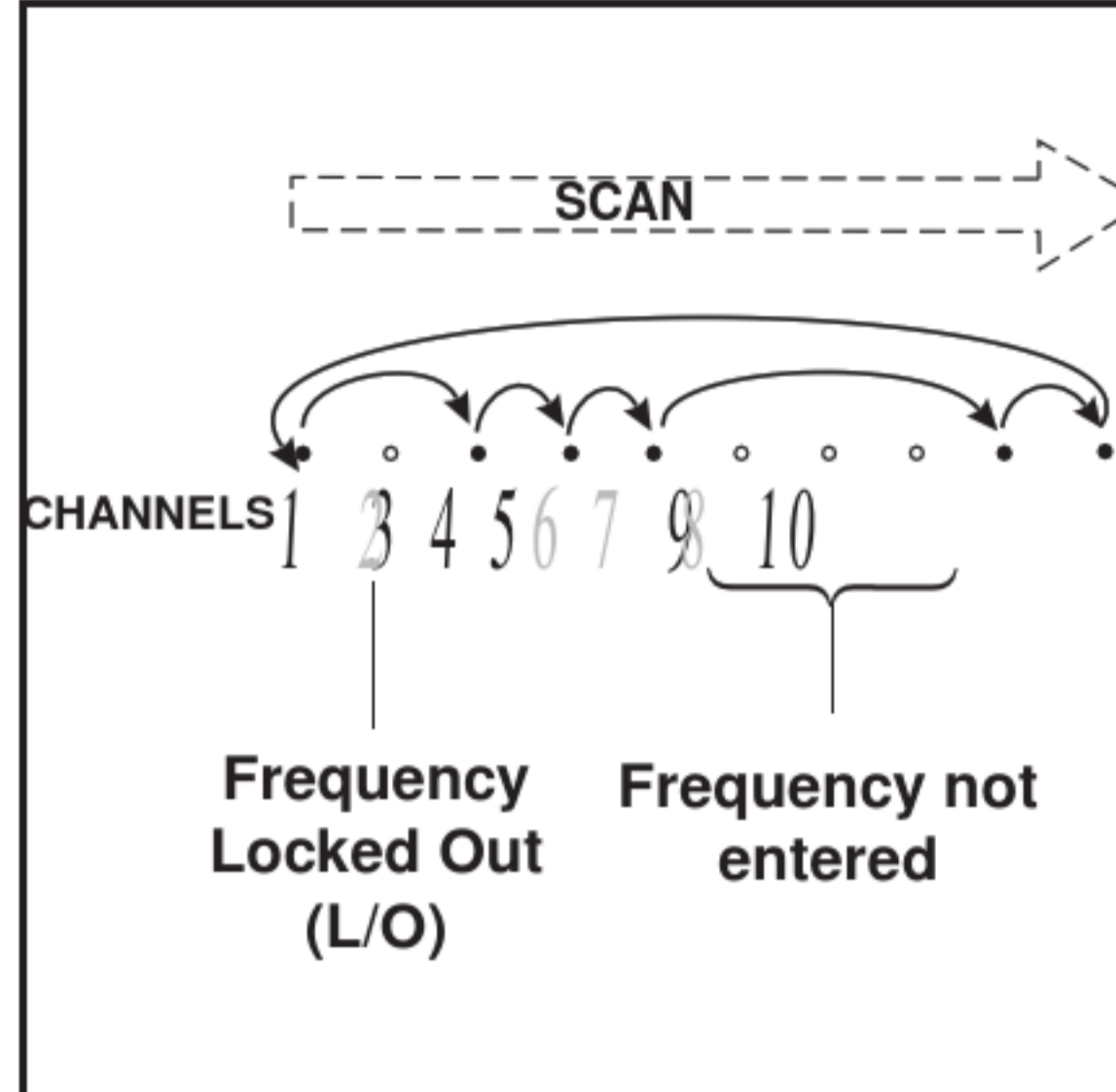

When a transmission is received, the Scanner stops on that channel. When the transmission ends, scanning resumes automatically after two seconds.



To stop on a channel during scanning, press **MANUAL**.

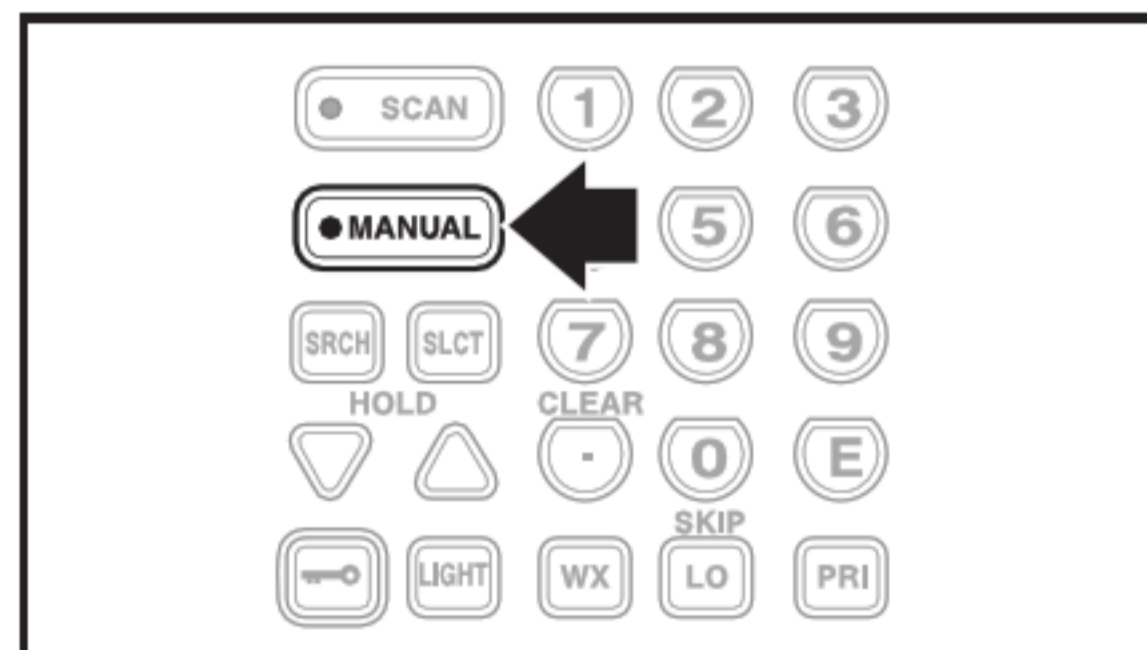

To resume scanning, press **SCAN**.

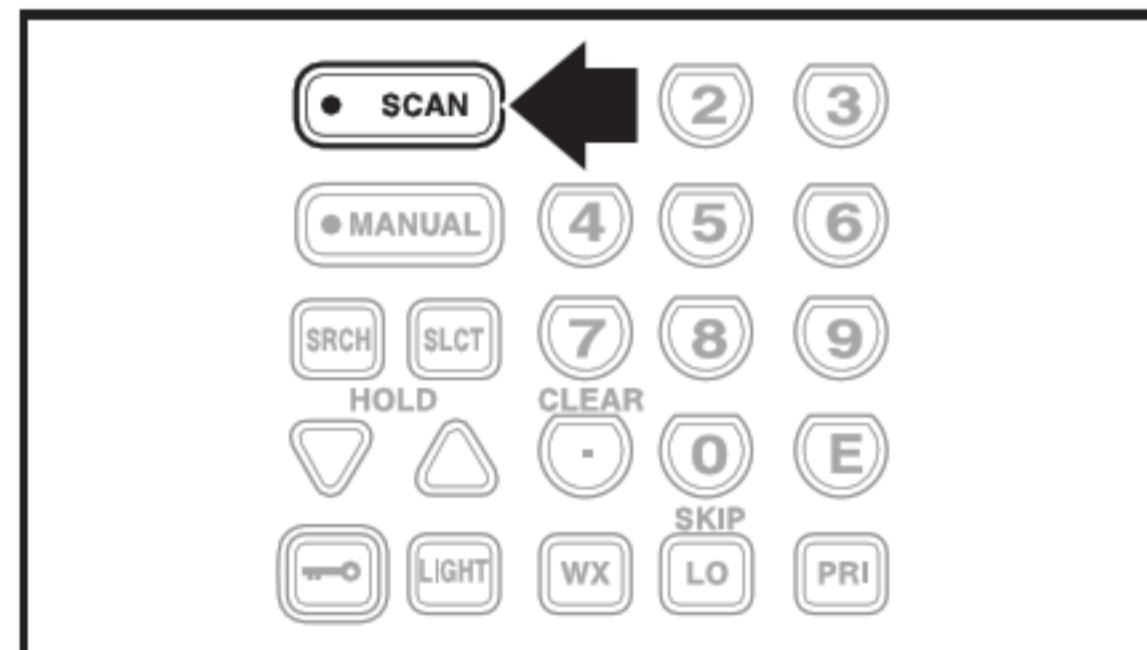

Channel Lockout

You can lockout any channel so it is not reviewed during normal scanning. You can restore the channel to scanning whenever you wish.

Lockout in Manual Mode

1. Press **MANUAL**.

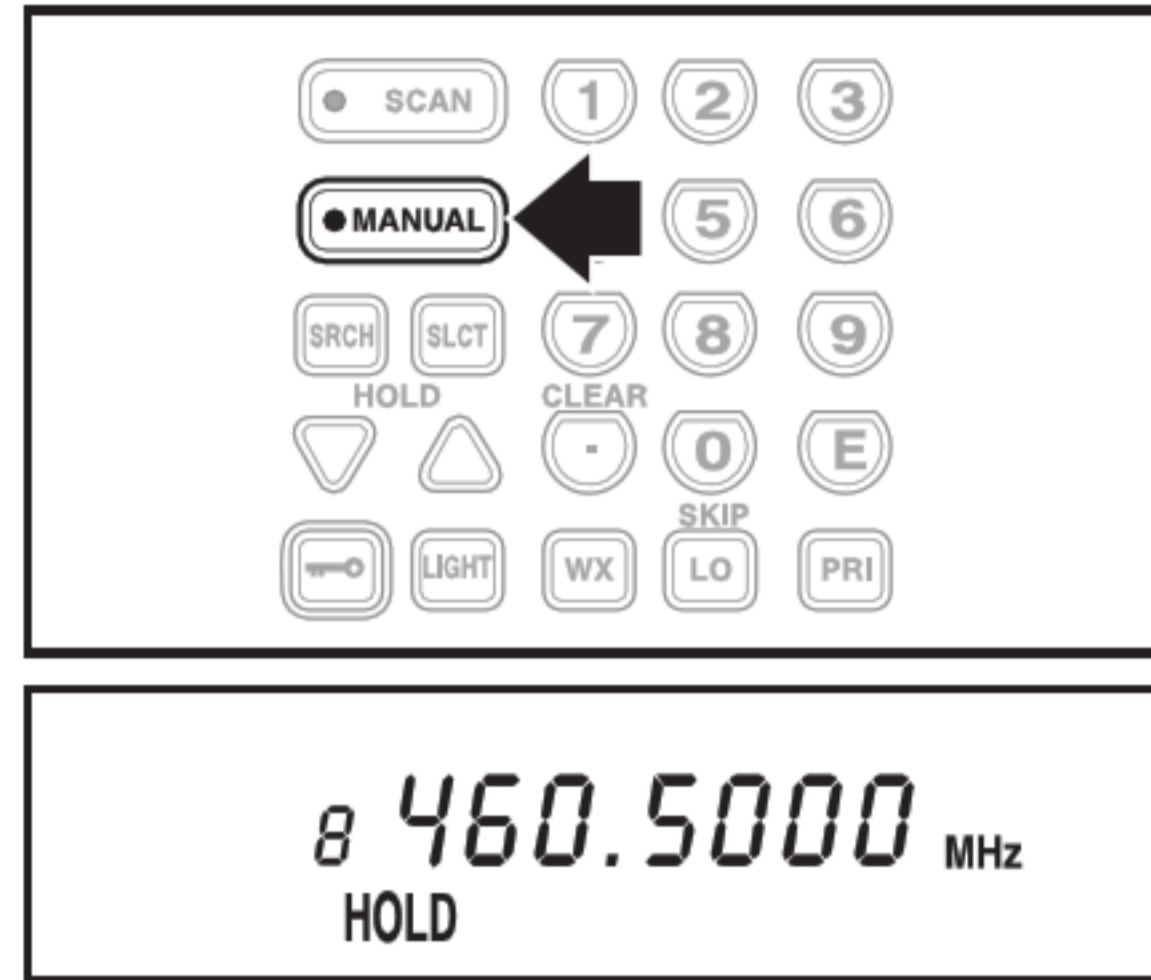

2. Select a channel.
 - a. Enter the channel number.
 - b. Then press **MANUAL** again.

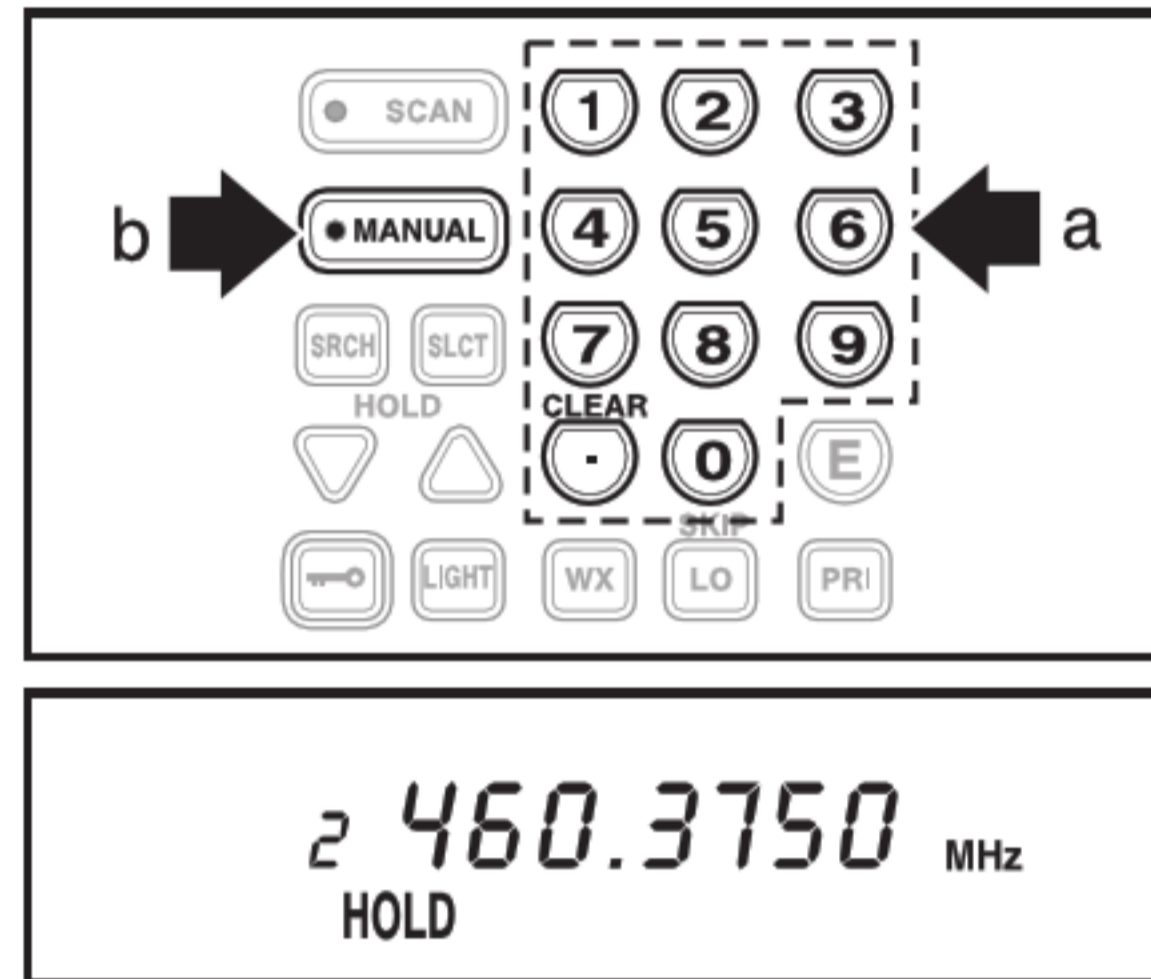

3. Press **LO** to lockout the channel.

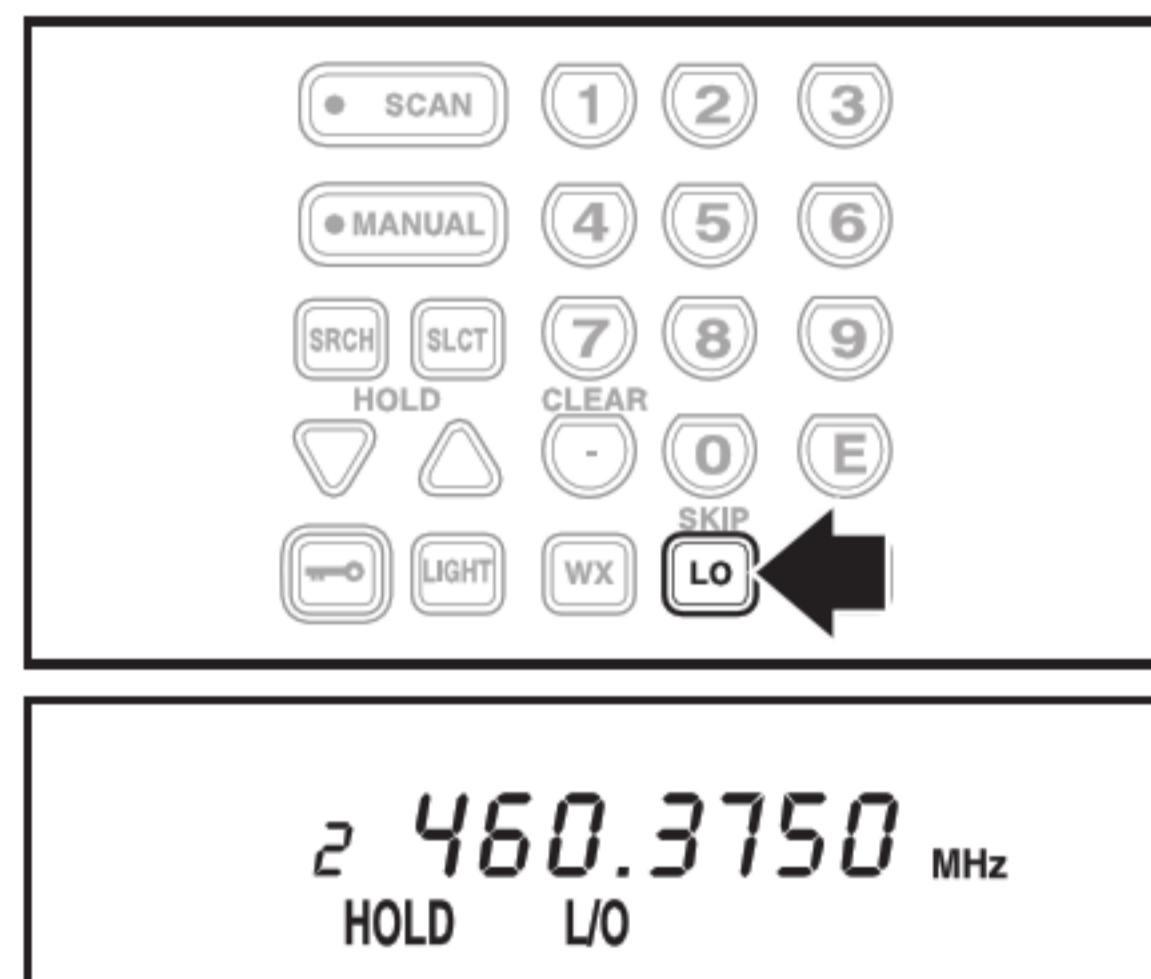

Locking a Channel While Scanning

If the scanner keeps stopping on a particular channel due to noise or too frequent transmissions, you may want to keep that channel from scanning.

1. Wait until the scanner stops at the channel.



2. Then press **LO**.

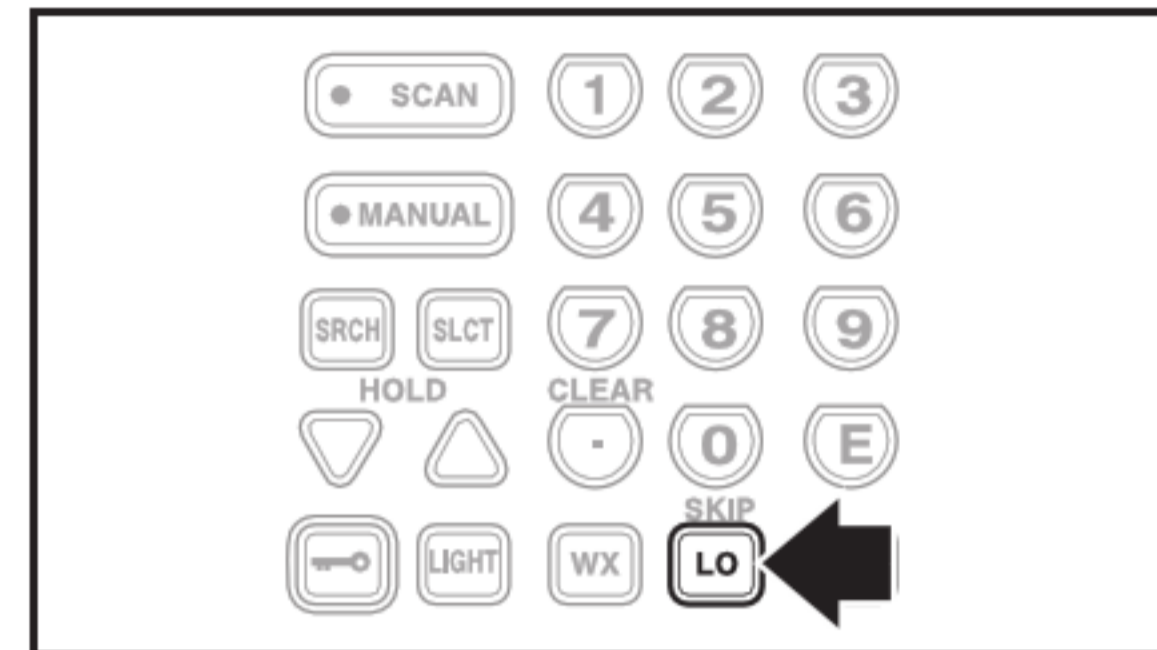

3. The scanner immediately resumes scanning because the locked out channel is no longer in the scanning sequence.



Lockout Tips

- To quickly lockout a series of channels, start with the lowest number channel.
For example, if you are locking out channels 4, 7, 8, 12, and 15, start with Channel 4. After selecting channel 4, press **LO**. Then press **MANUAL** one or more times to step up to the next channel to be locked out.
- Record the locked-out channels in some convenient place so you can restore them.

Restore a Locked Out Channel

1. Press **MANUAL**.

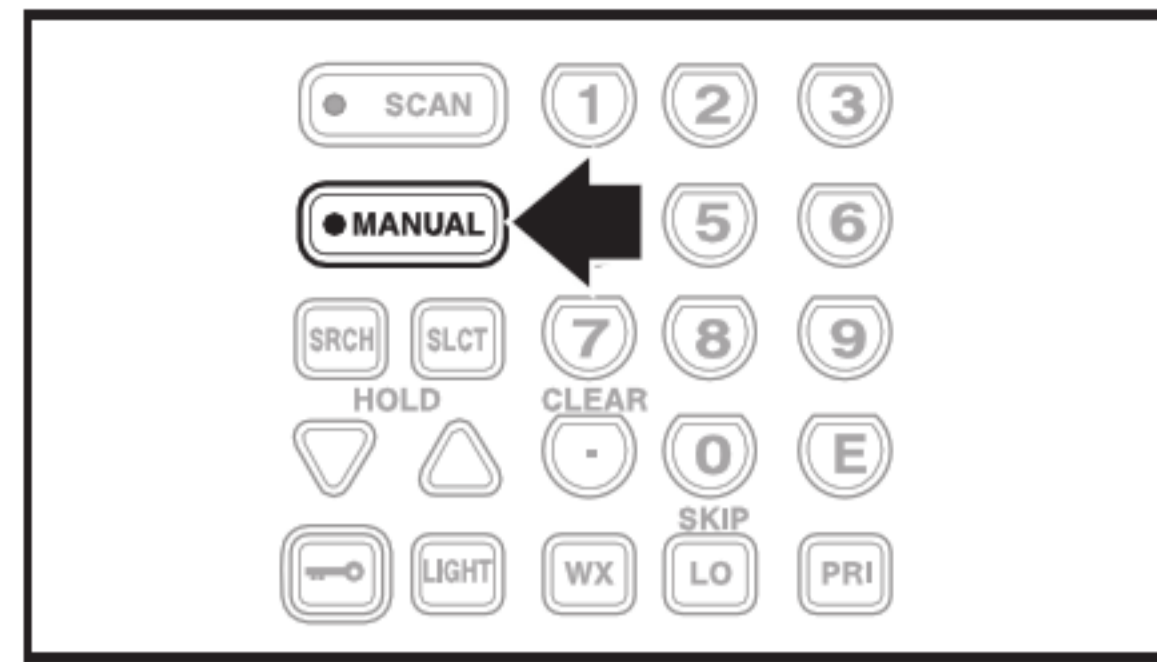

2. Select a locked out channel.
 - a. Enter the channel number.
 - b. Then press **MANUAL** again.

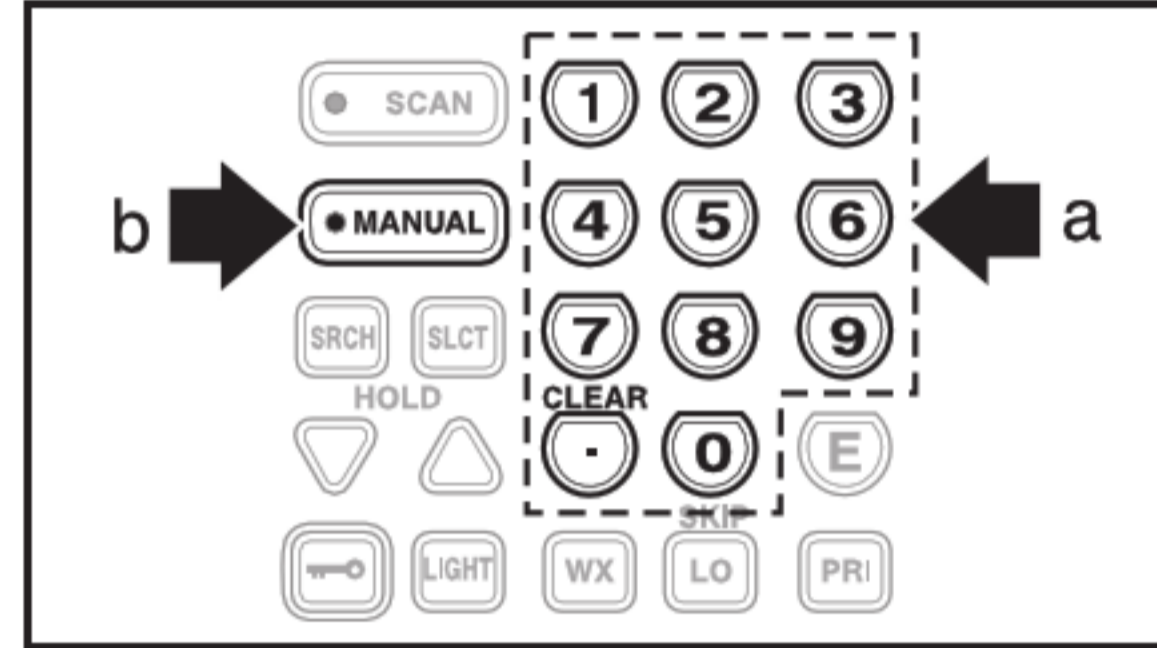

3. Press **LO** to unlock the channel.

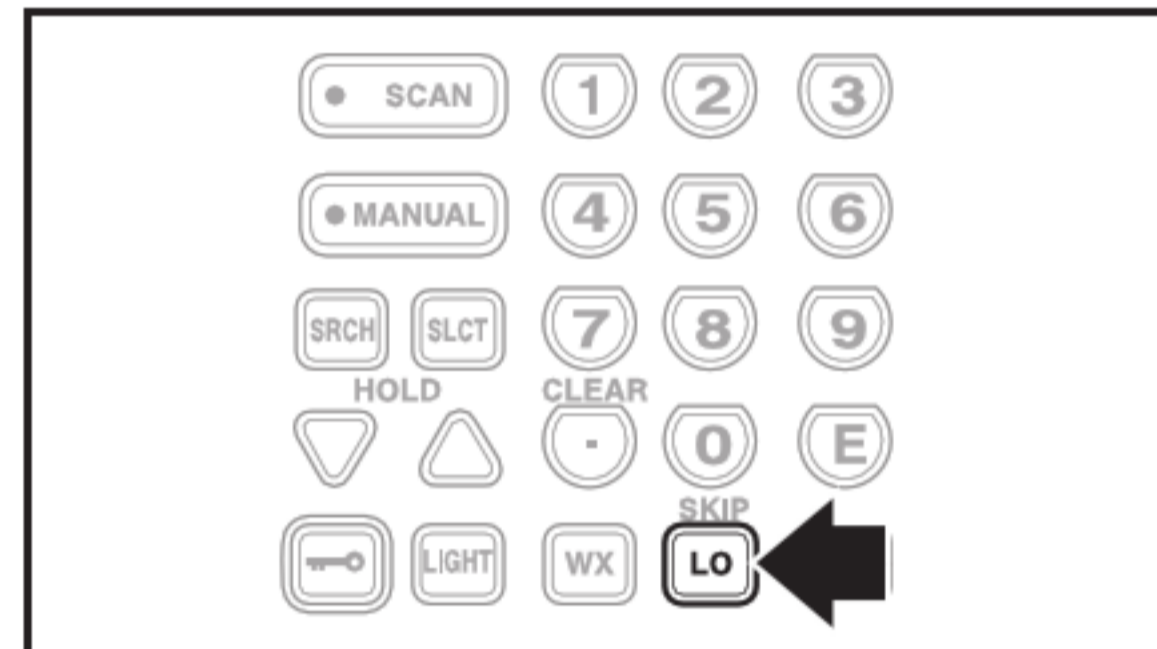

Restore All Locked-out Channels

1. Press **MANUAL**.

Note: You must be in Manual Mode before restoring all locked-out channels.

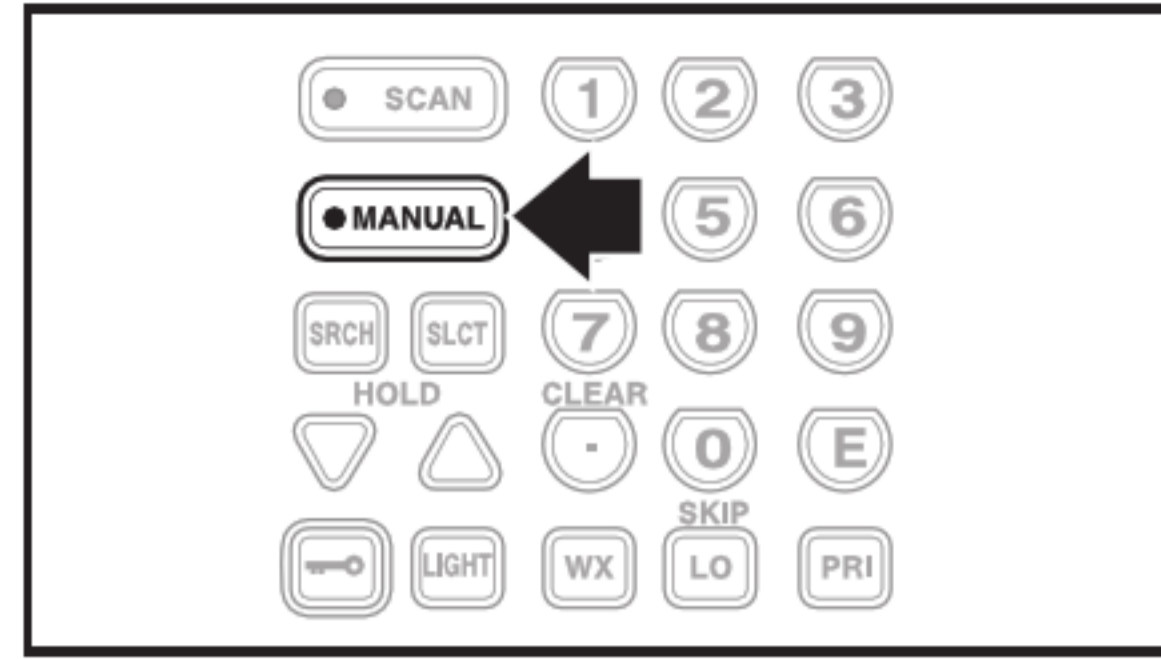

2. Press and hold **LO** for about two seconds.

You will hear two beeps when all the channels have been restored.

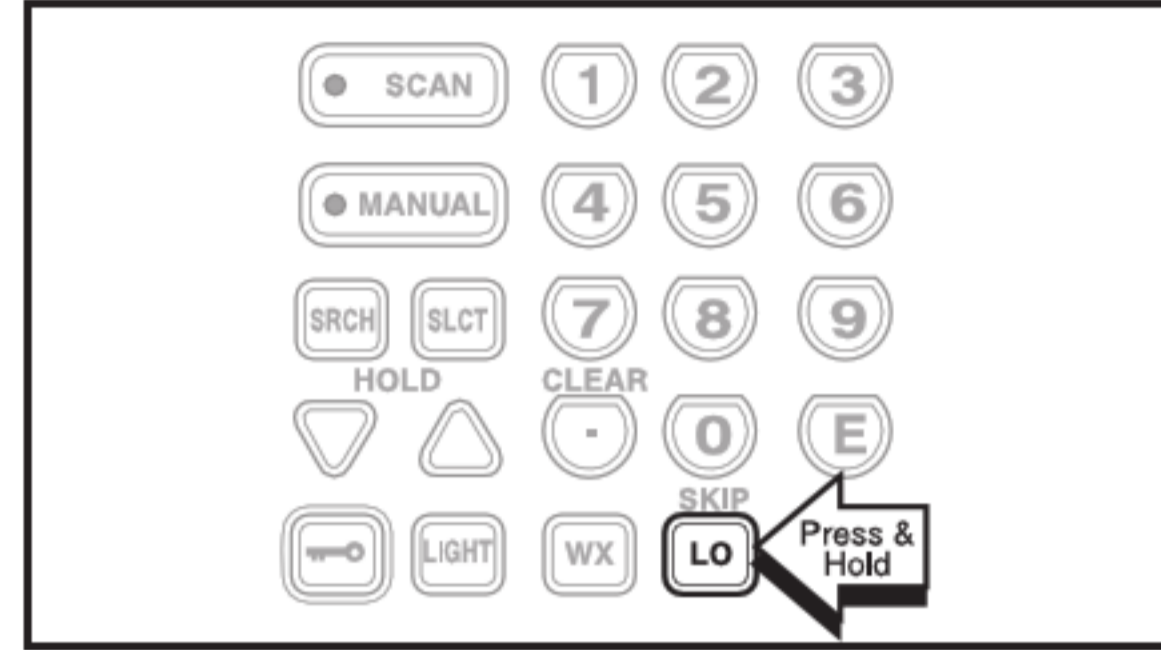

Priority Scan

When Priority Scan is turned on, your scanner checks the priority channel every two seconds for activity. If a signal is present on the priority channel, your scanner monitors the channel until the transmission ends, then resumes normal scanning. You can designate any of the 30 available channels as your Priority Channel.

To activate Priority Scan (in either Manual or Scan Mode):

1. Press **PRI** .

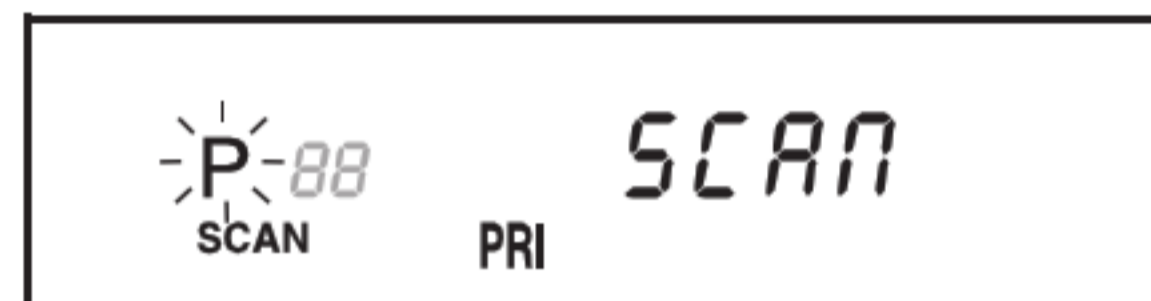
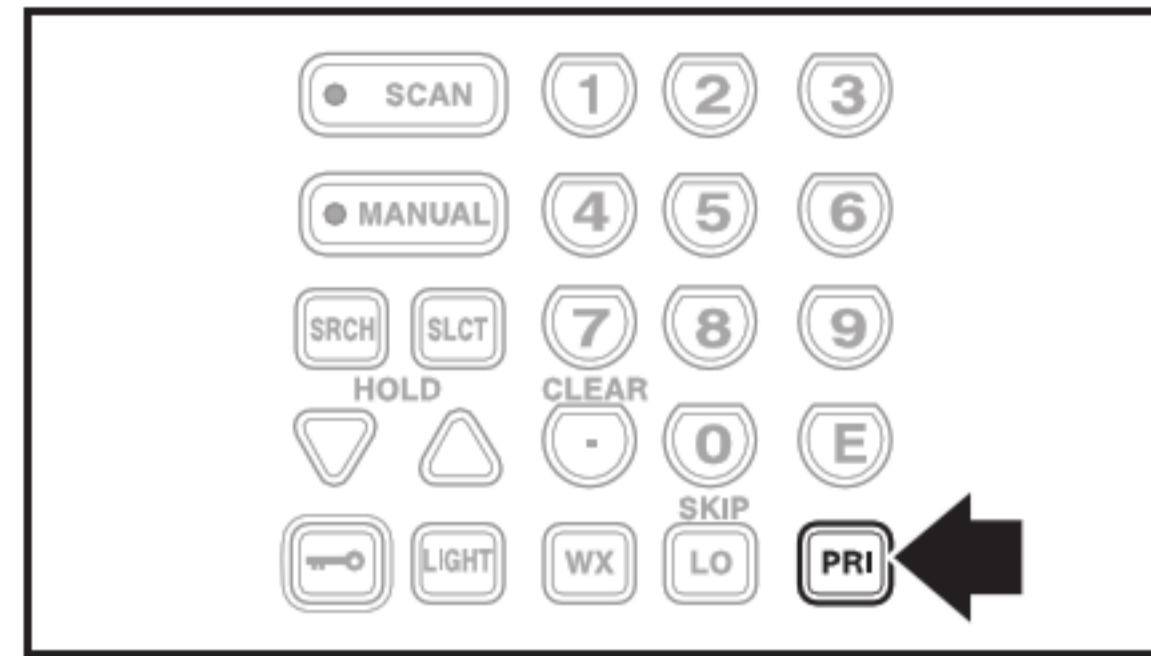

Note: If you have locked out the priority channel, this message appears when you select Priority Mode.

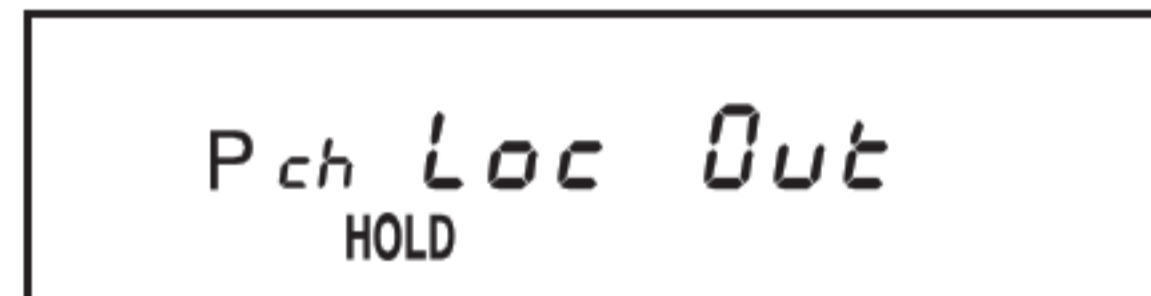

2. Press **PRI** again at anytime to deactivate Priority Scan.

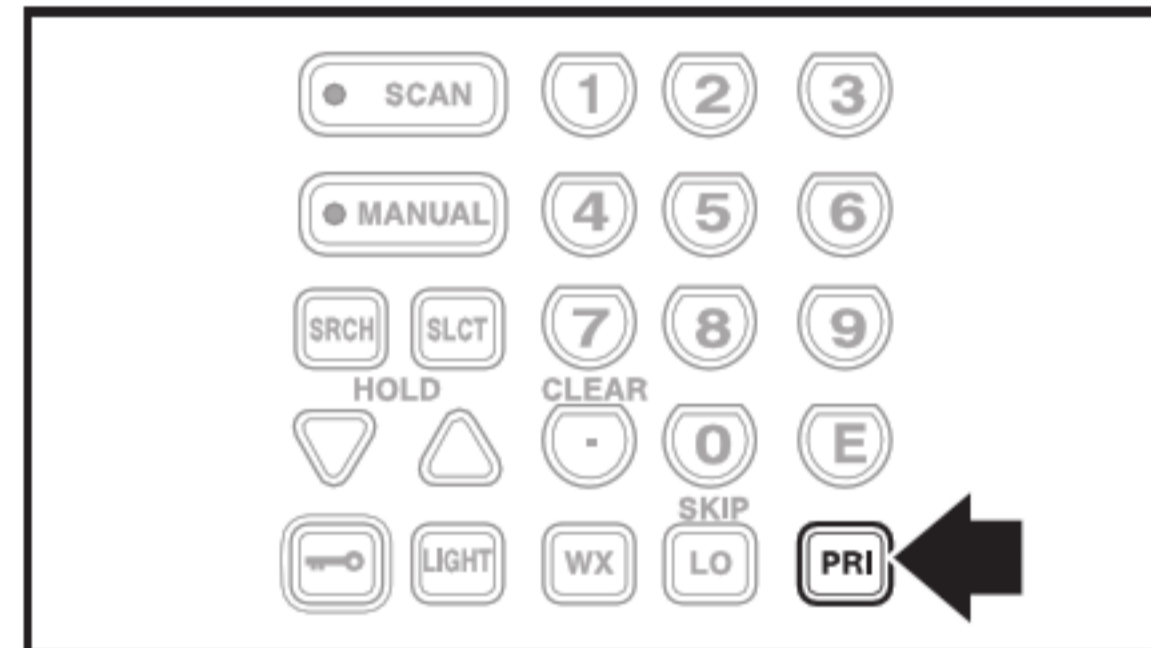

Changing the Priority Channel

You cannot eliminate the Priority Channel, but you can change it to any other of the 30 available channels.

1. Press **MANUAL**

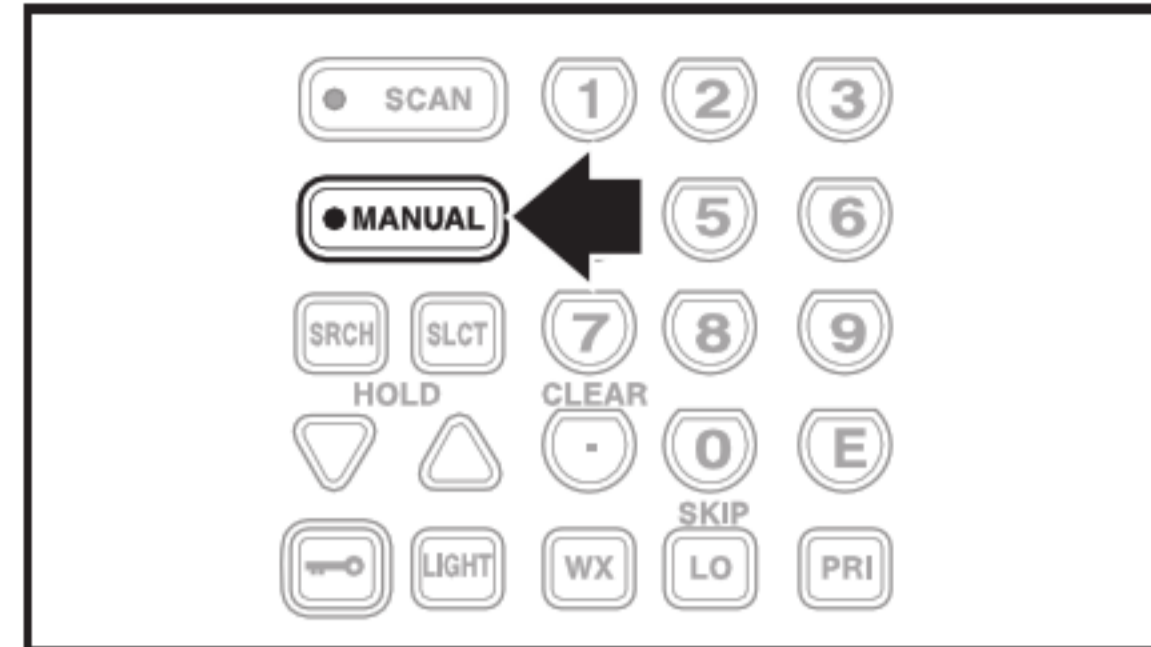

2. Select a new Priority Channel.
 - a. Enter the channel number.
 - b. Then press **MANUAL** again.

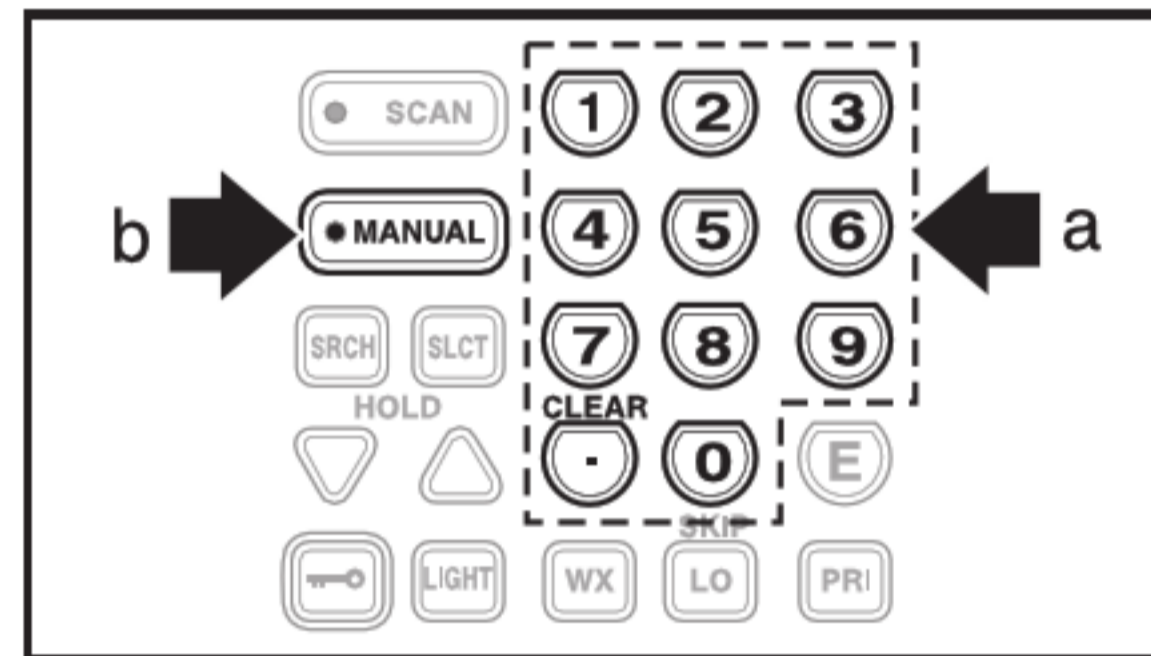

3. Press and hold **PRI** for two seconds to designate this channel as your new Priority Channel.

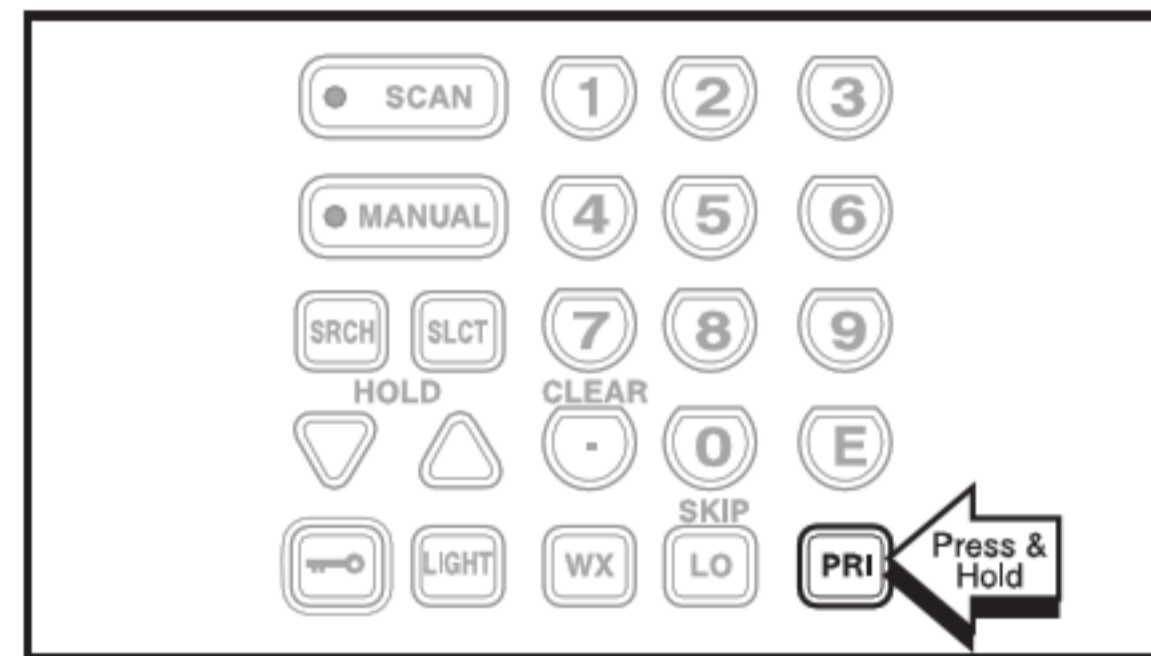

Two beeps indicate that the Priority Channel is changed.

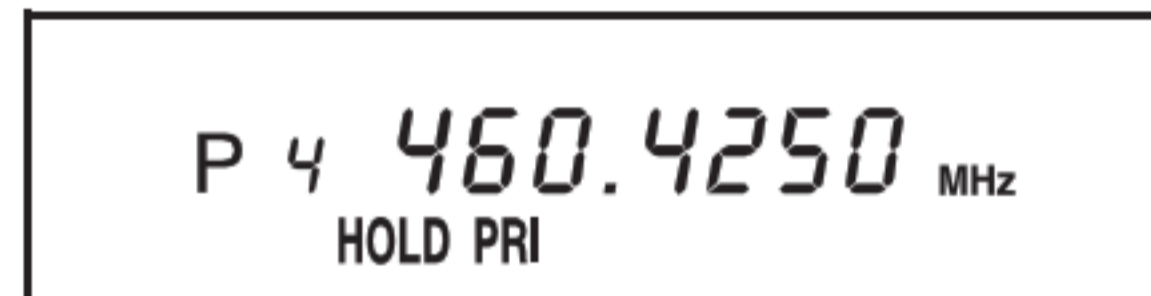

Chain Search

Use Chain Search to find active frequencies in your area. You can search up to all five personal bands or turn off those bands you don't want to hear. This gives you flexibility of searching for any channel between 29 and 512 MHz, as long as they are within the 10 frequencies bands covered by the *BC60XLT-1*. See the table on page 3, the Technical Specifications on page 34, or the table on the back of the *BC60XLT-1*.

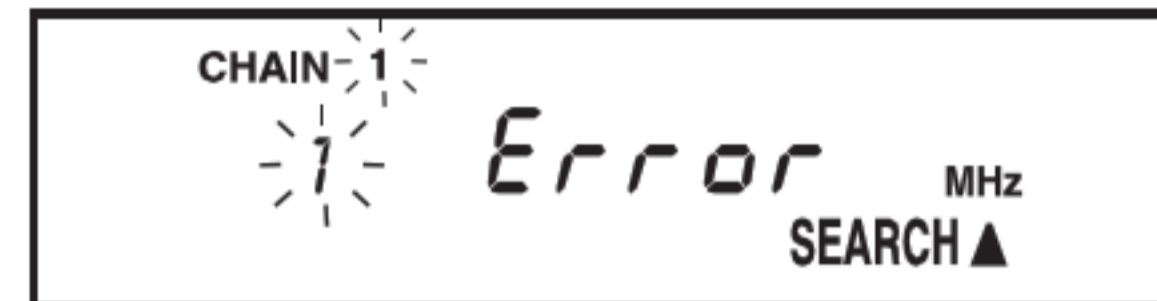

Setting a Search Range

An error message displays when  is pressed and you have not either specified a search range in at least one Chain Search band



—OR—

If you attempt to turn off all Personal Chain Search bands.

The *Error* message turns off automatically and Chain 1 is selected when all search locations are empty. Press  to return to normal scan, or press  to select the band you want to program.



To program a frequency range into one of the five personal Chain Search bands, follow these steps:

1. Press  until the search location you want appears in the display.

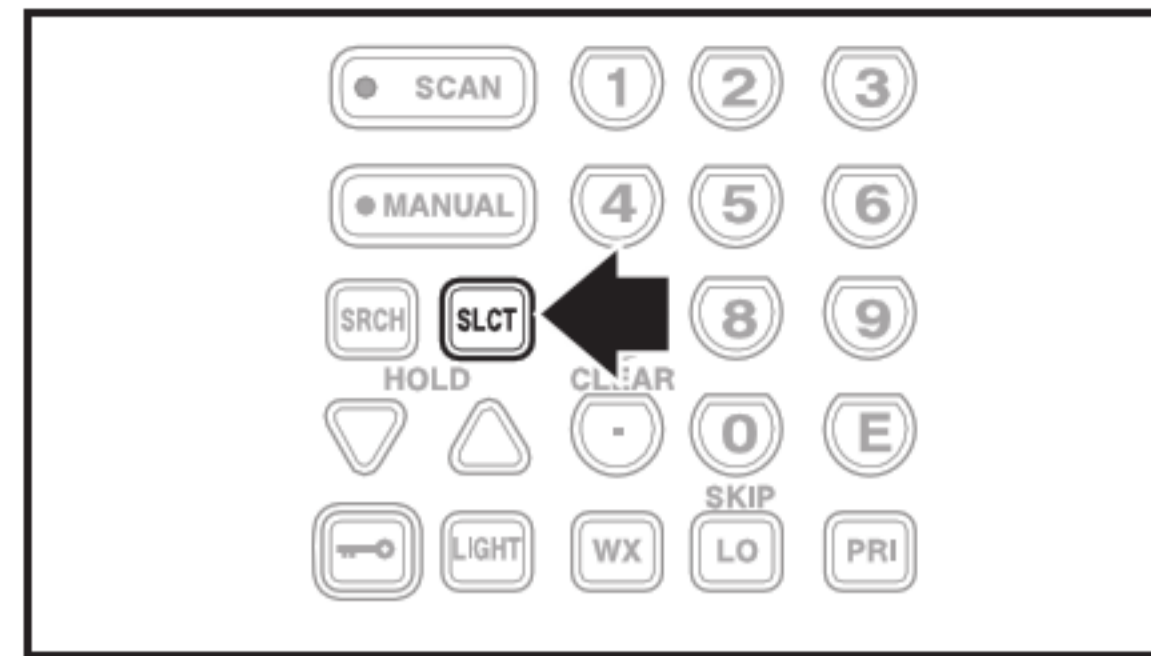

2. Enter lower limit of the search band.
 - a. Enter the frequency number.
 - b. Then press .

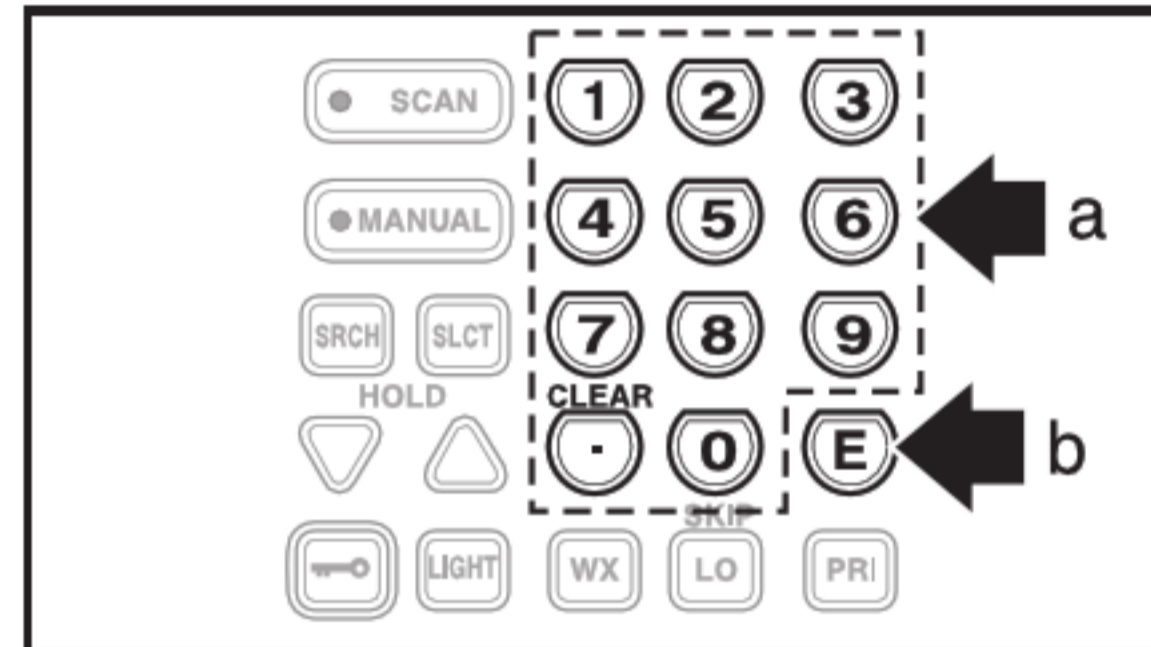



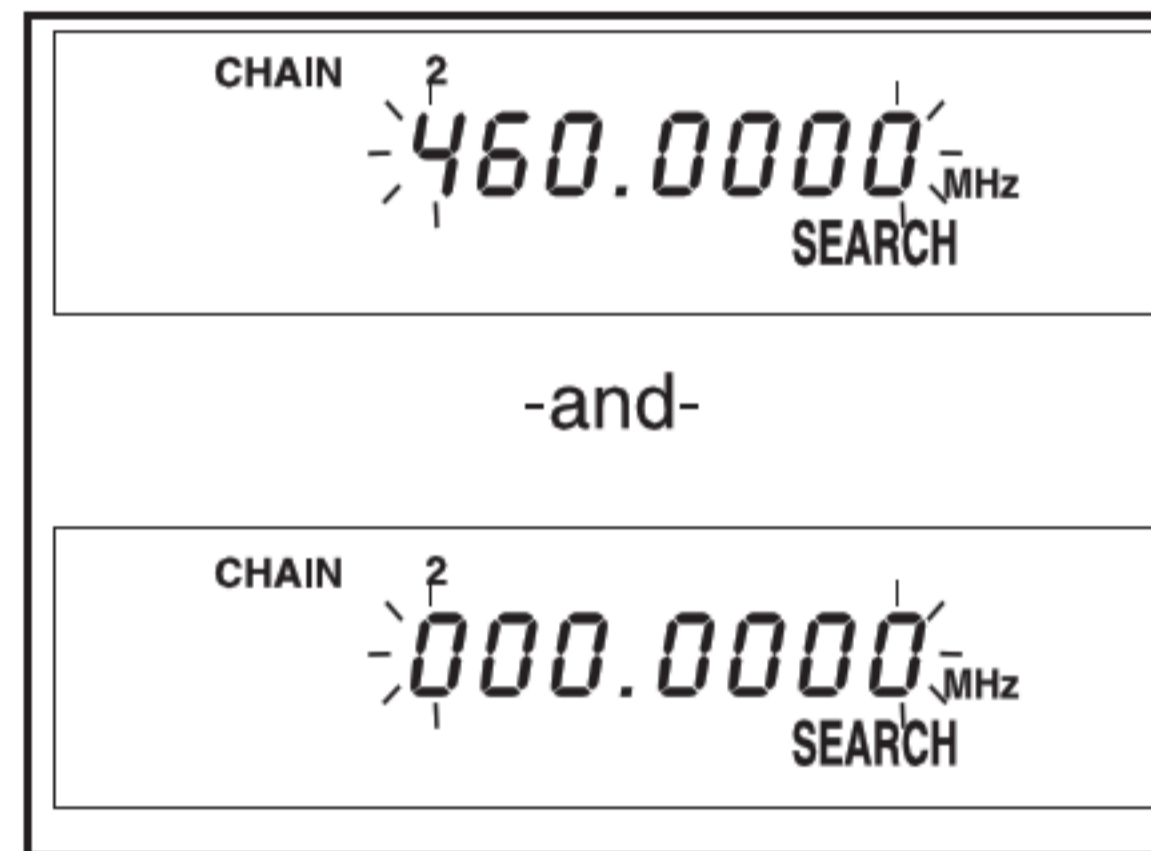

Note: The display alternates between the upper and lower ranges.

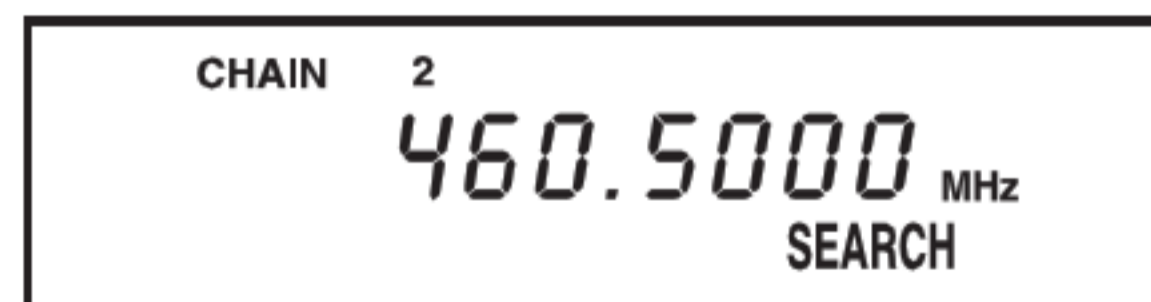
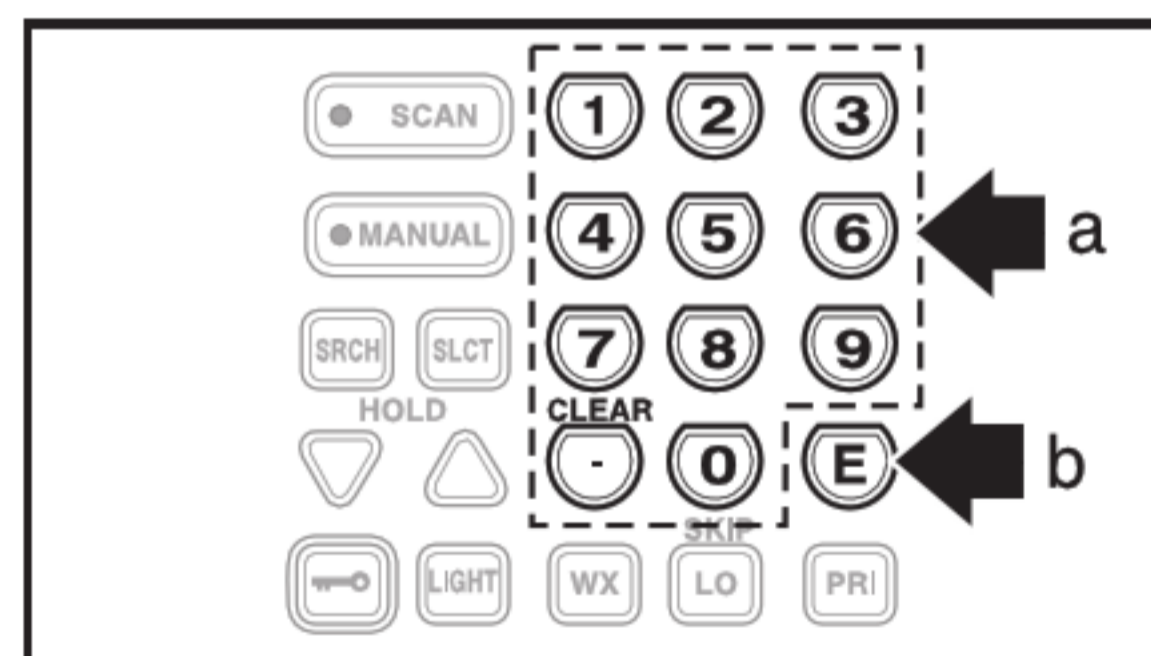

3. Enter upper limit of the search band.
 - a. Enter the frequency number.
 - b. Then press .



Note: The display alternates between the upper and lower ranges. If you program the wrong limit, press  and , then press  and  again to erase the error and reset the limits to zero. Then begin again.

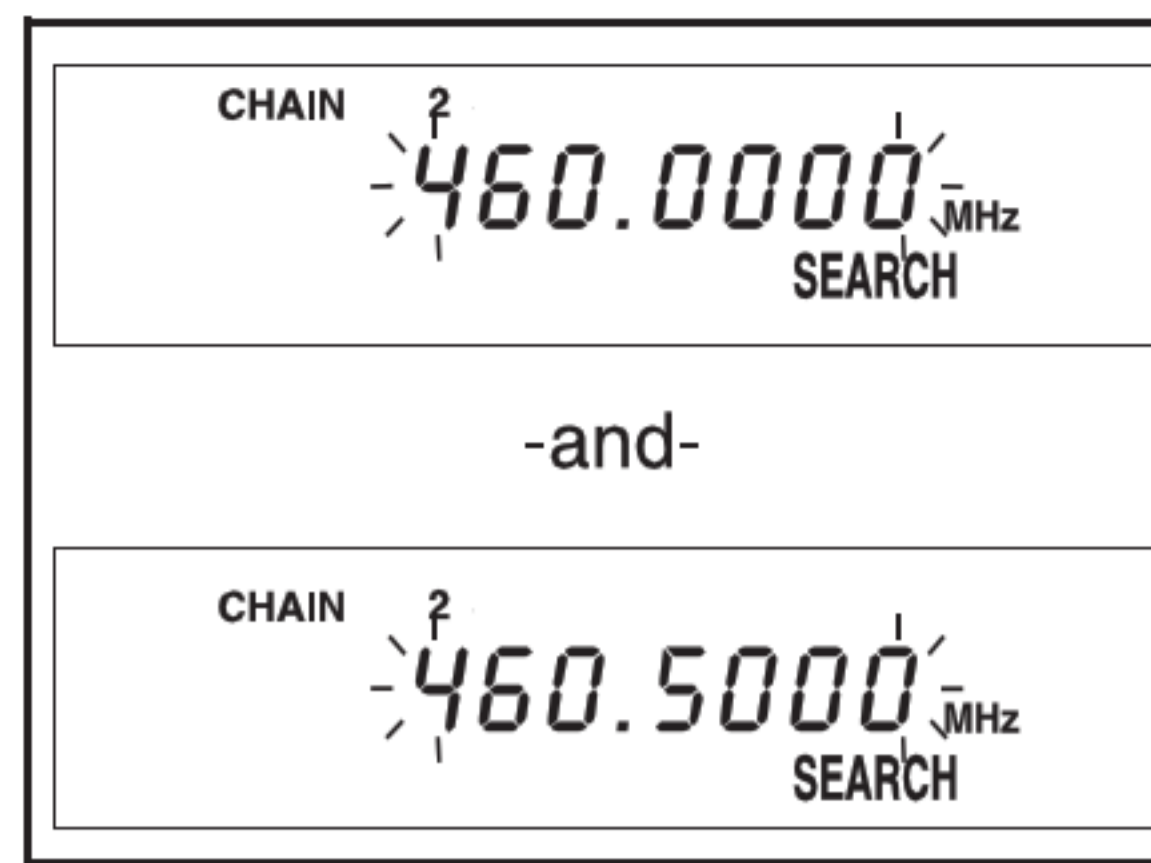

4. Either press  to begin your search.

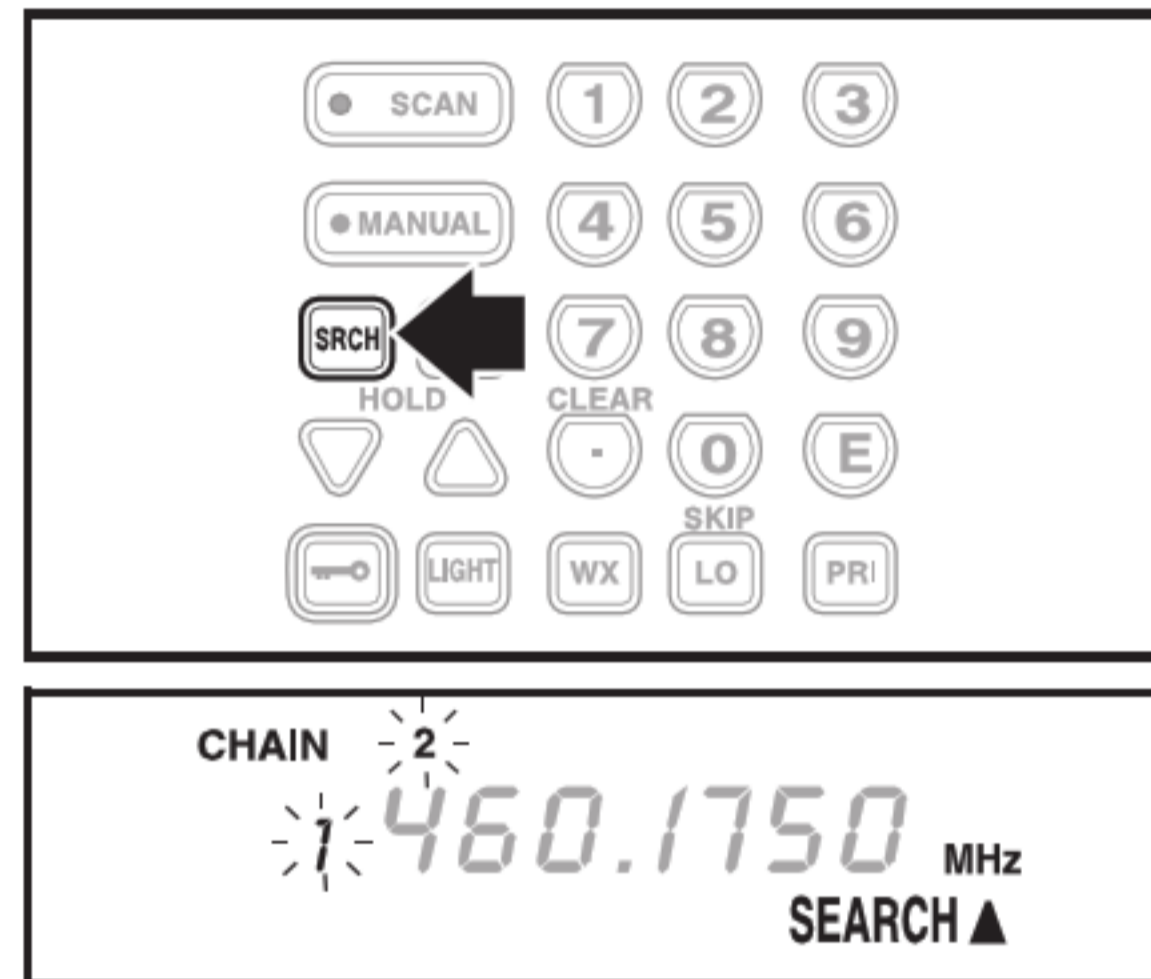

Note: Your scanner searches each selected Personal Chain Search band. The display flashes the number of the band while it's scanned. Other bands which are programmed and selected are displayed but do not flash.

—OR—

Press  to move to the next chain location.

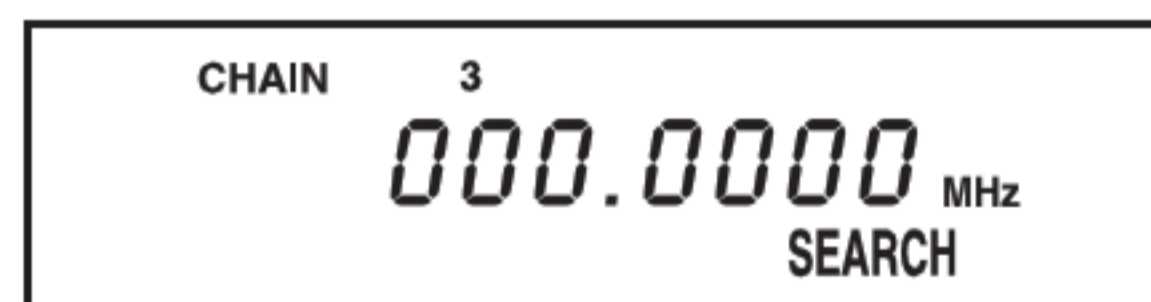

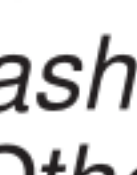
Note: You can press the Chain Search band number, followed by , to access the location directly.



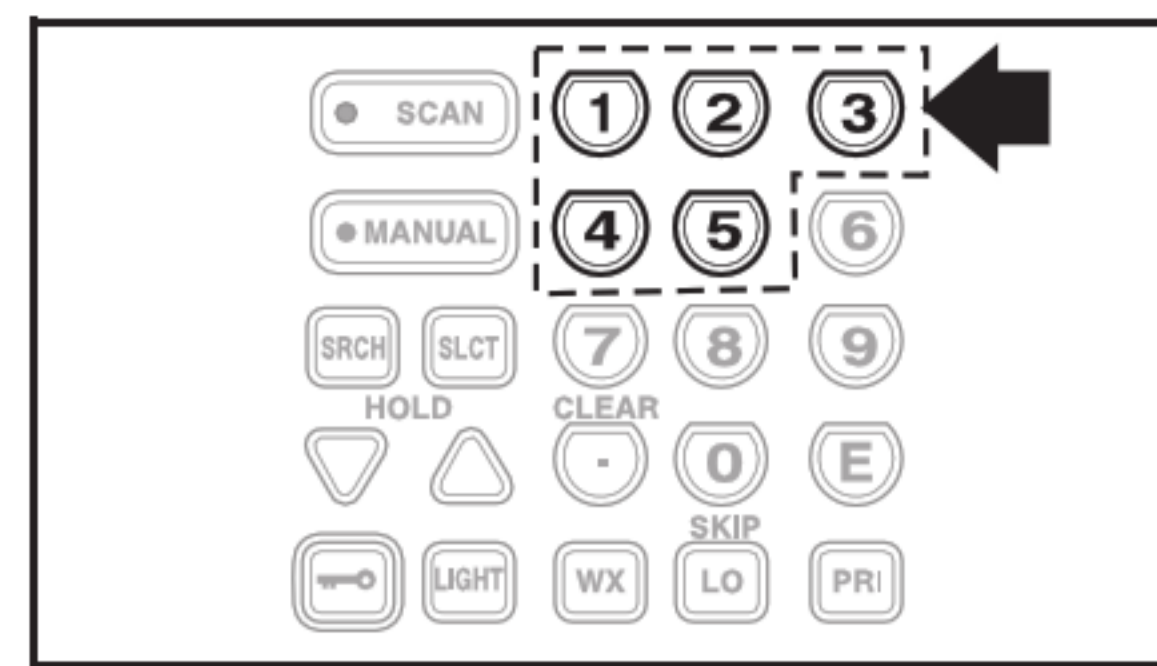

- To turn off a Chain Search band during search scanning, press its location number.

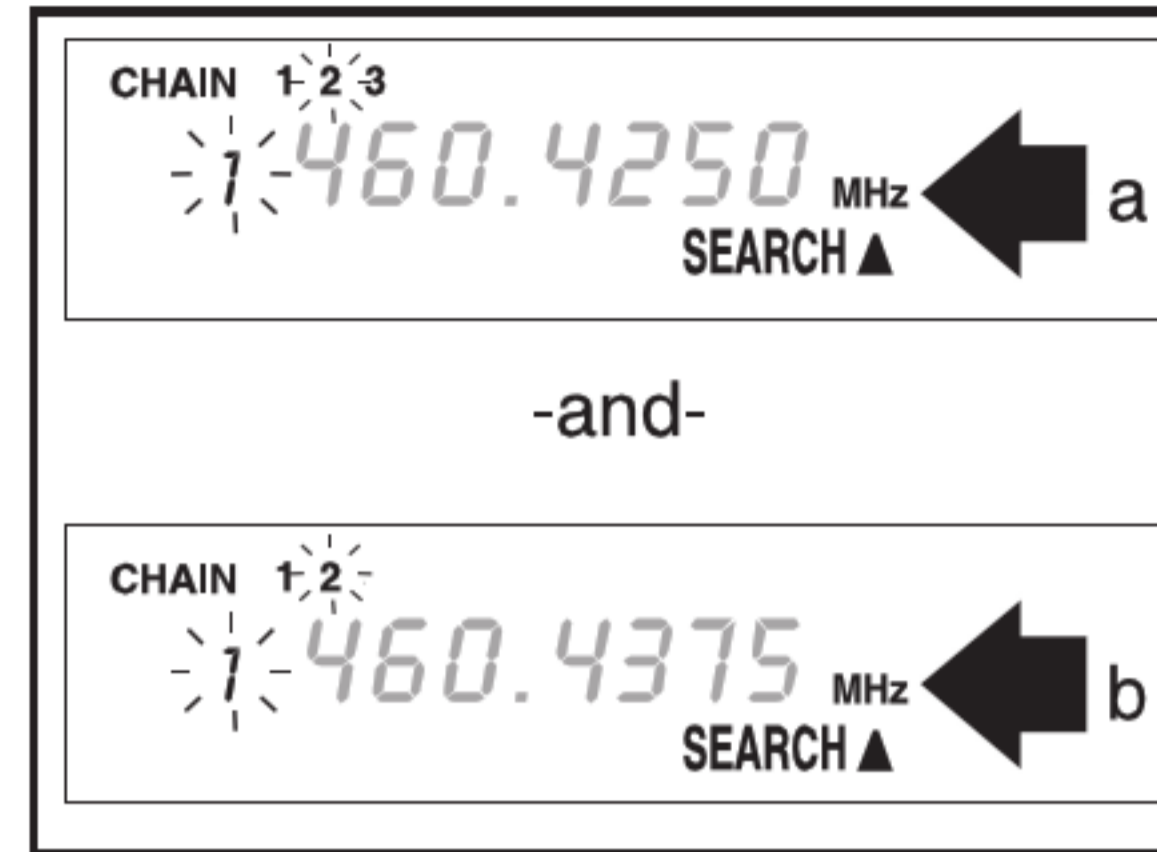



For example, (a) if Chain Search locations 1, 2 and 3 are selected, (b) press  to turn off band three so that it's not scanned during your search.

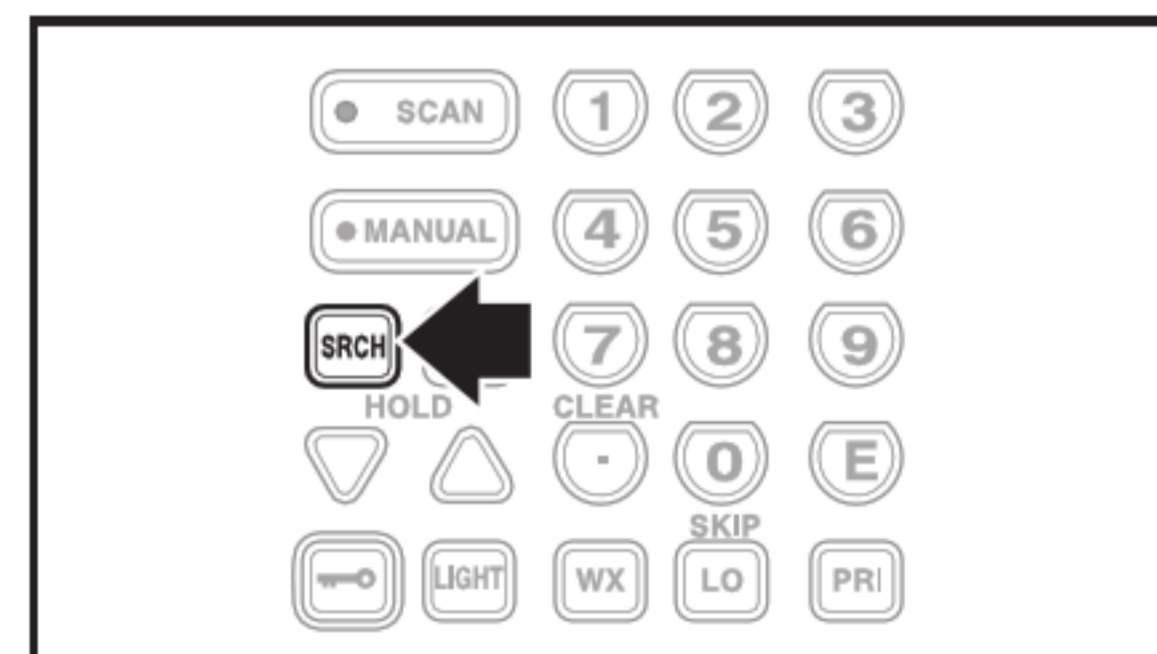
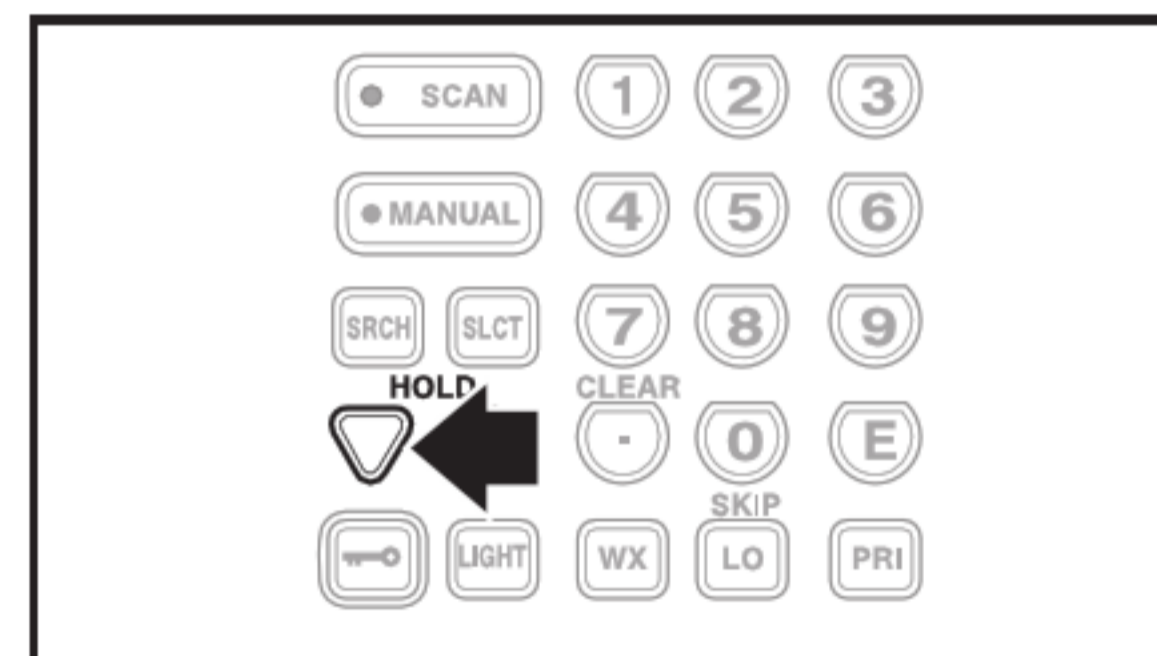
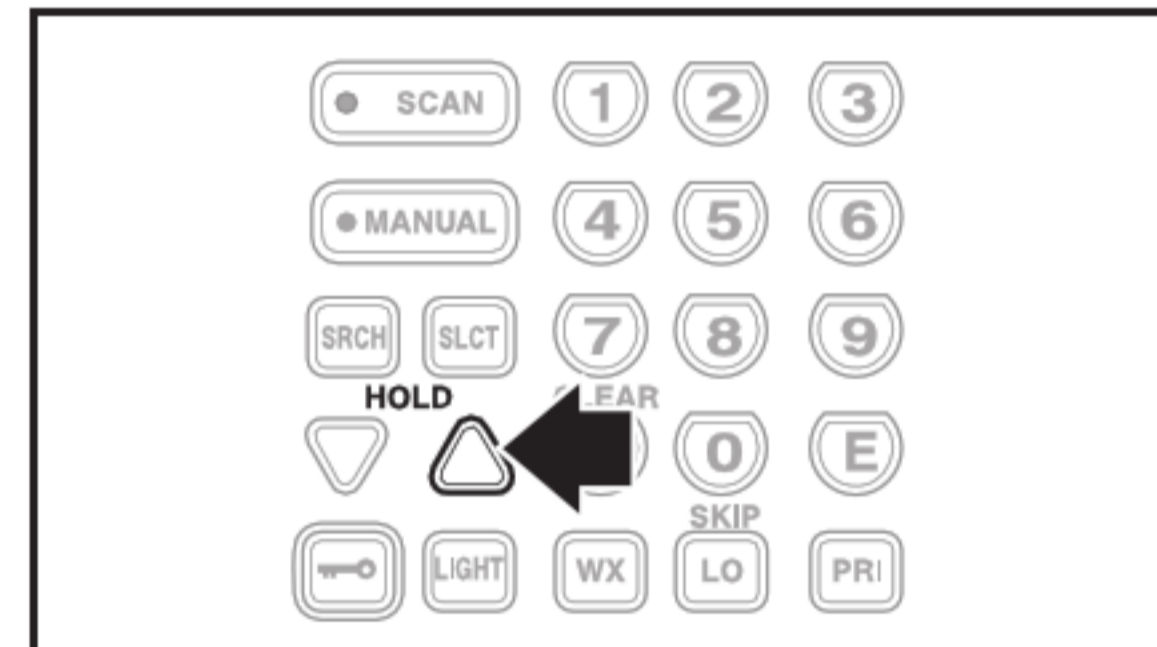
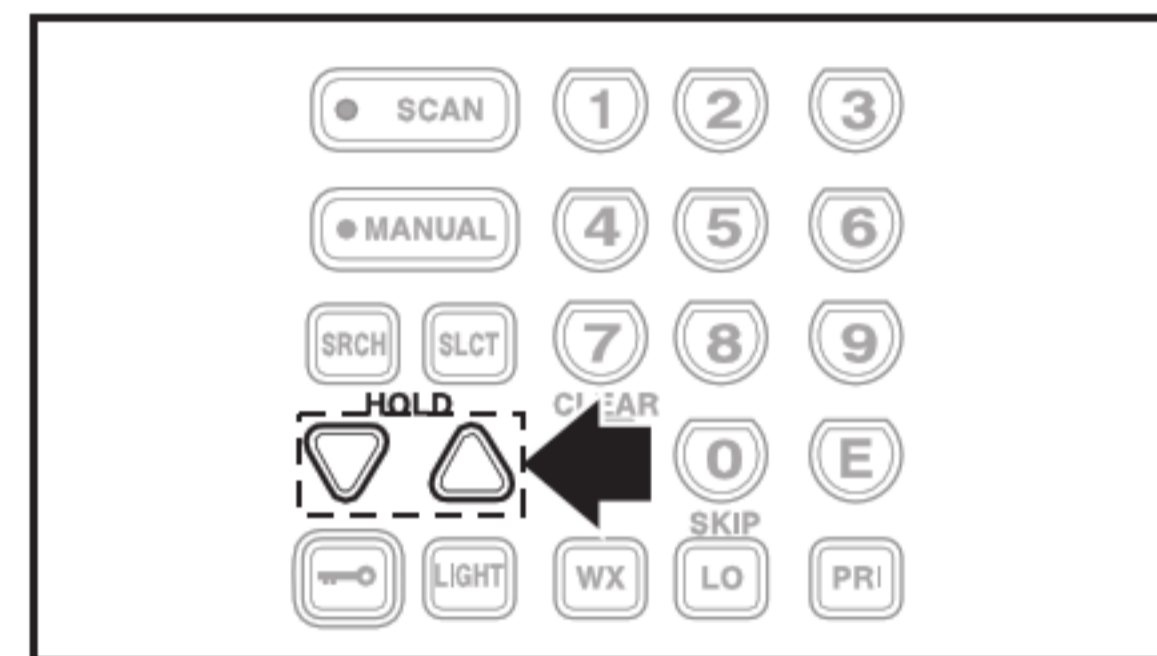

Search Hold Feature

- Press  or  at anytime to stop the search.
- Press  to move to the next higher frequency
—OR—
(See Step 3)
- Press  to move down to the previous frequency.
- Press  to resume searching.



Note: The search continues toward either the upper or lower search limit, depending on which direction key ( or ) was pressed last.

Channel Skip

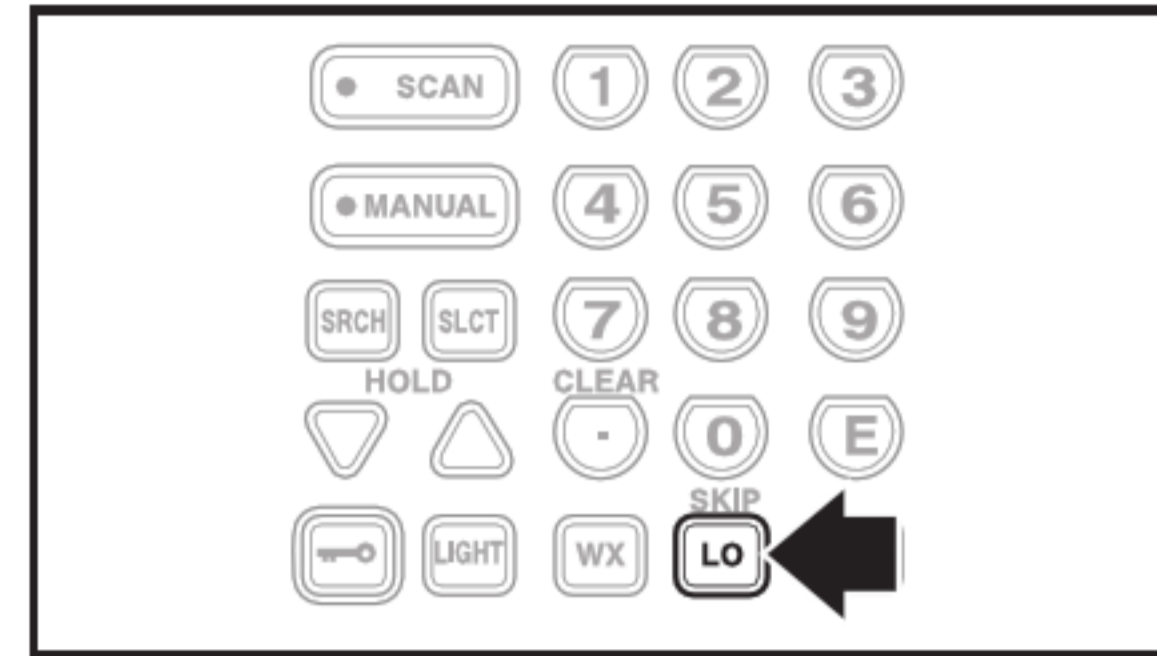

If a particular channel continues to interrupt search scanning, it is possible to set your scanner to skip the frequency.

If your scanner stops while searching, press  to lockout the frequency from the search range.





Note: You can program 10 skip frequencies. The 11th skip frequency entered causes the 1st skip frequency to unlock.

To unlock all skip frequencies at once, follow these steps:

1. Press either  or  during a search.

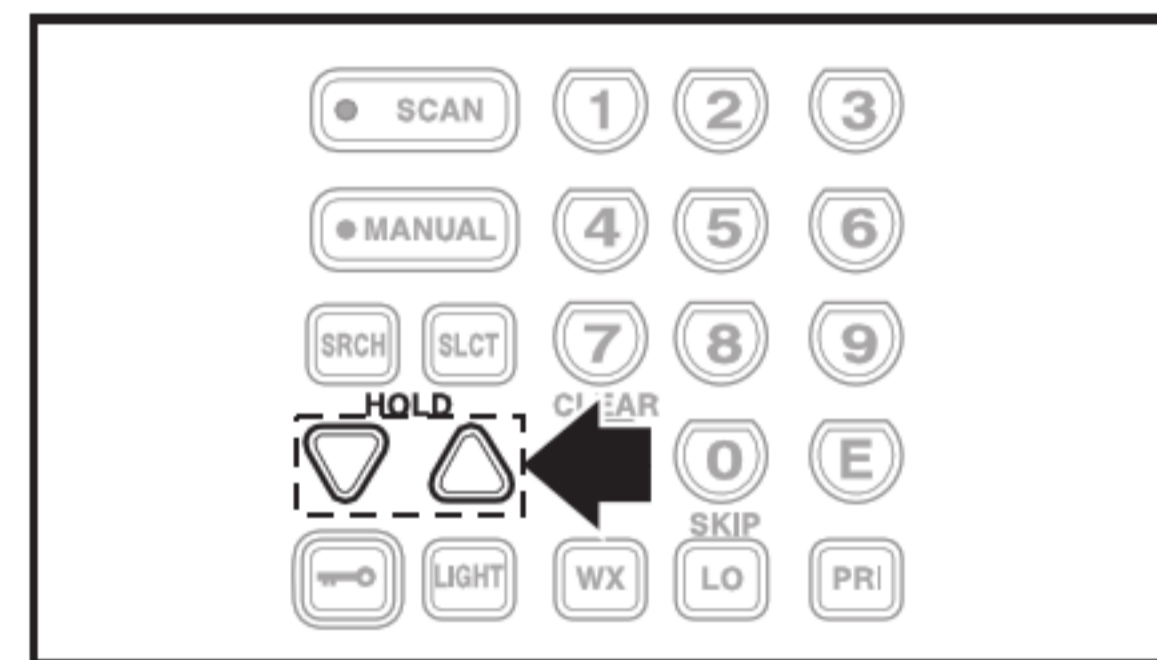
Note: You must be in Search Hold before restoring all skipped frequencies.



2. Press and hold  for about two seconds.

You will hear two beeps when all the channels have been restored.

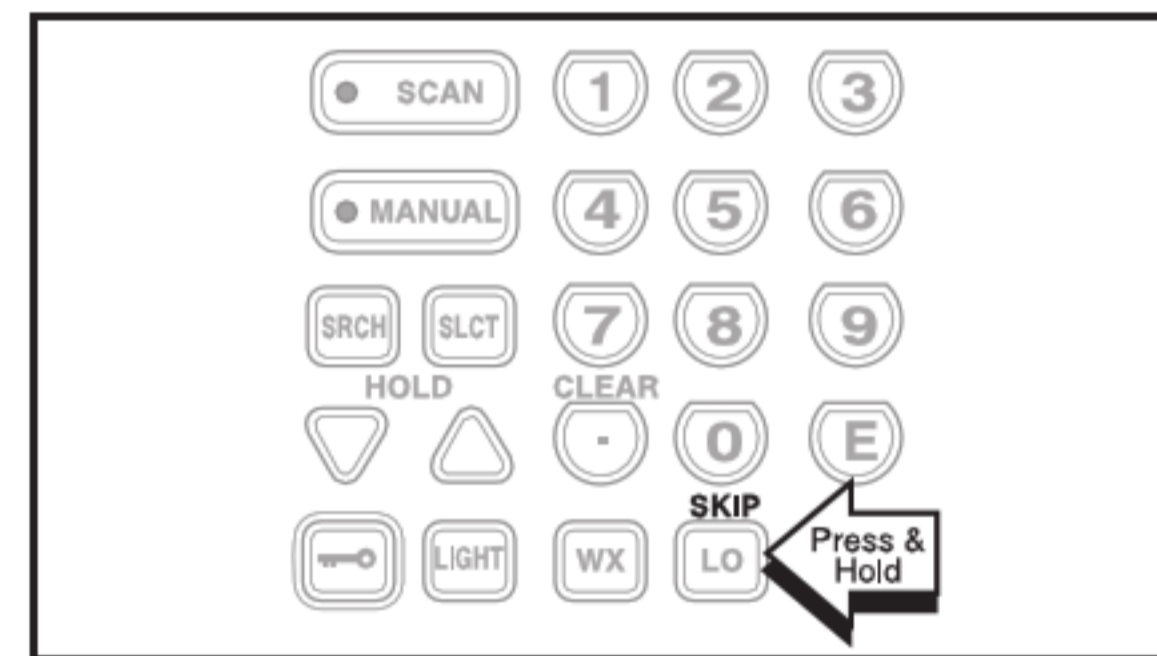

Storing Search Frequencies

You can quickly store any frequency you find during Search.

Caution: You must select the channel in which you will store the frequency before entering the search mode. Otherwise, you may erase a stored frequency that you want to keep.

1. Press **MANUAL**.

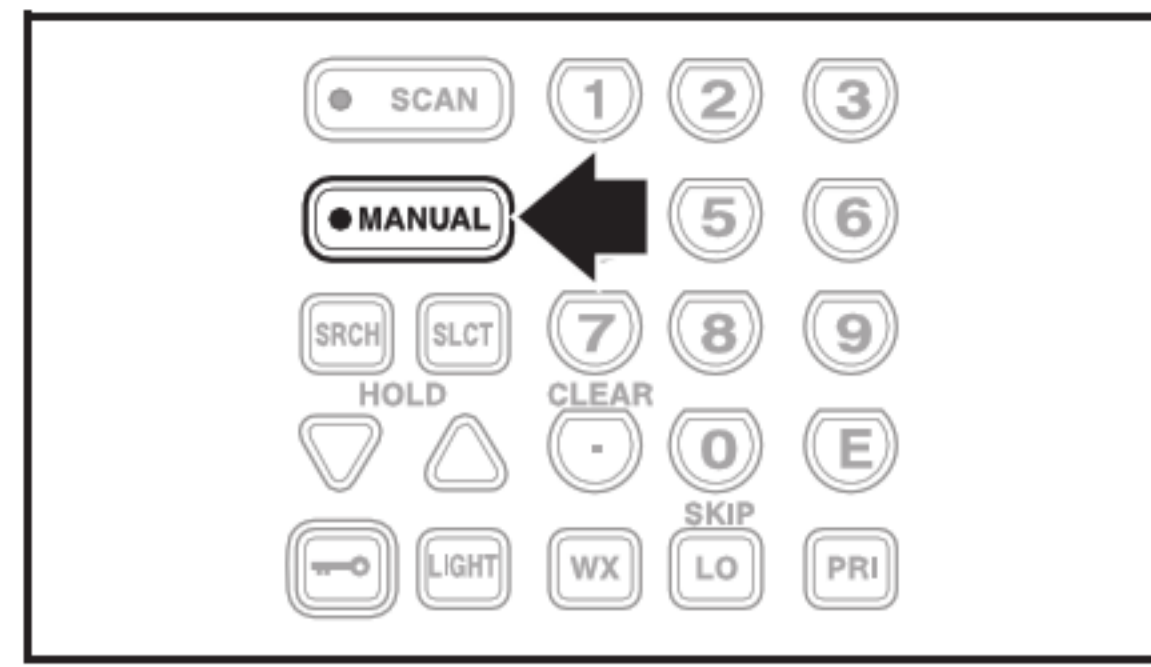

2. Select a channel.
a. Enter the channel number.
b. Then press **MANUAL** again.

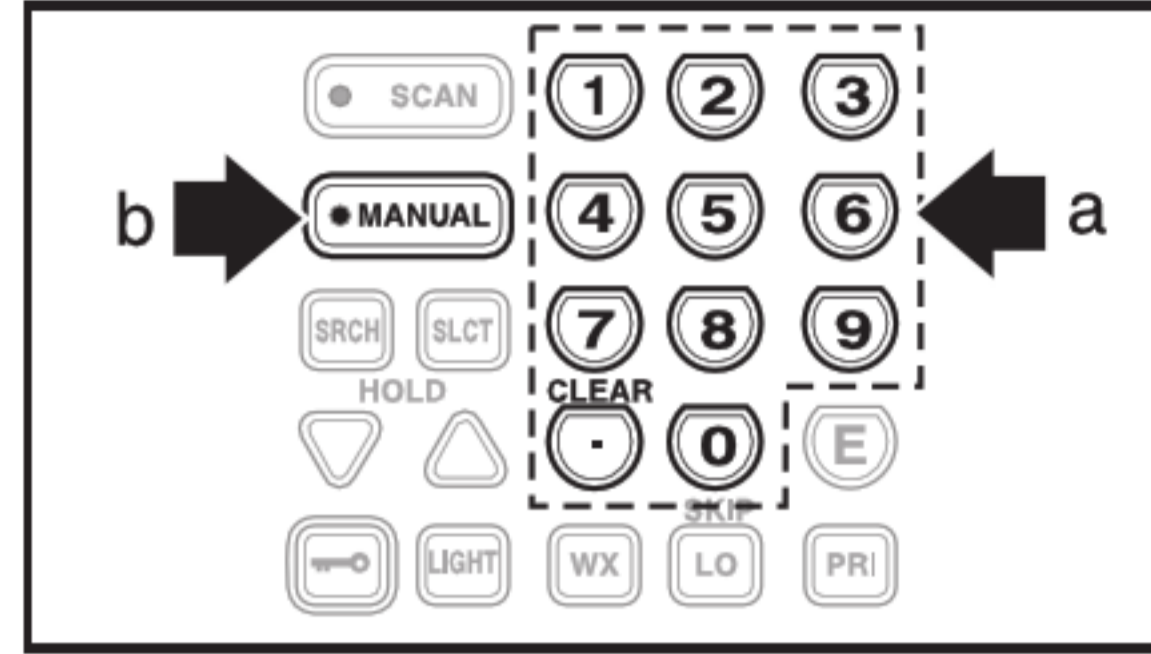

3. Select one or more of the personal search bands.

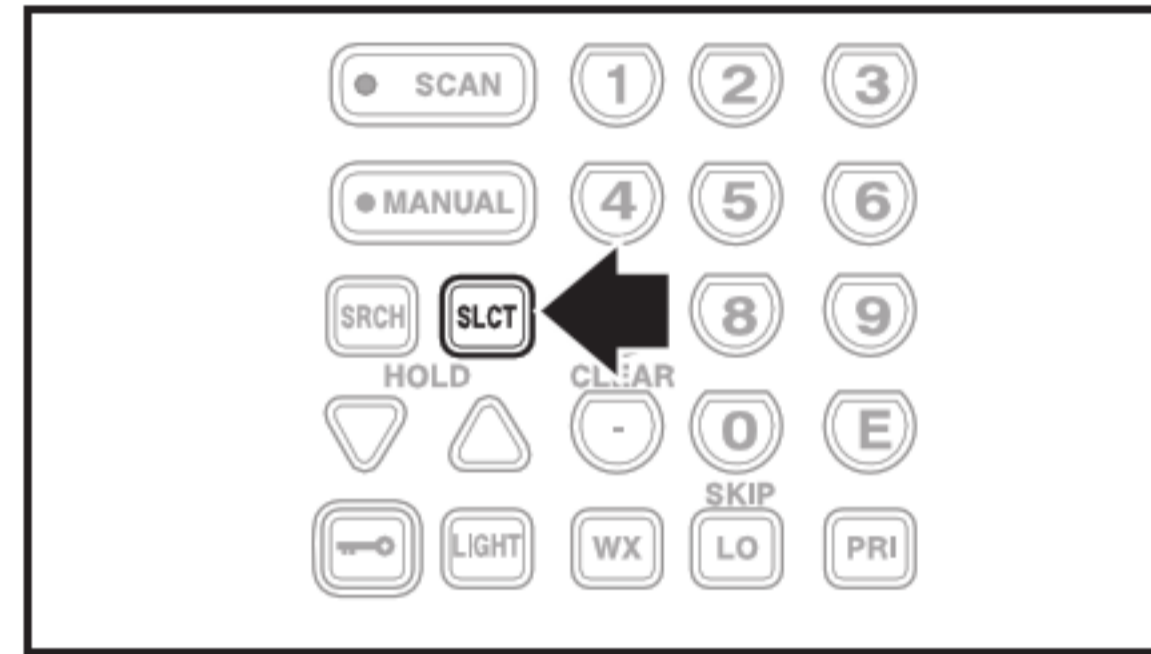

For example, select **CHAIN 2**.

Note: These frequencies were used during "Setting a Search Range," on page 23.

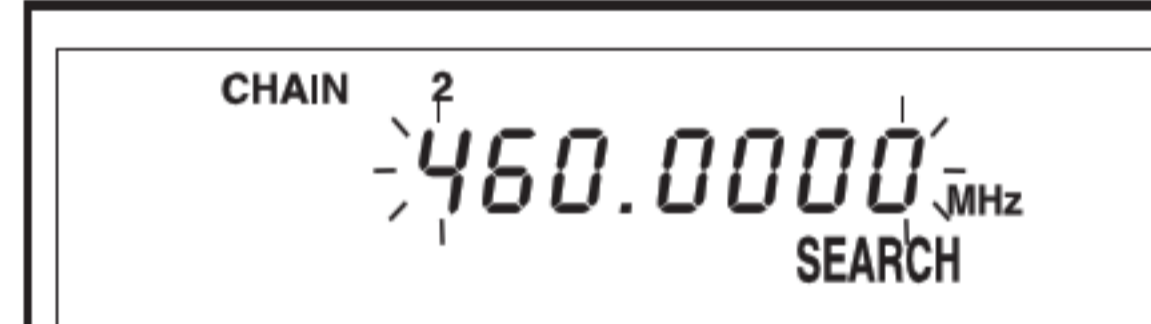

-and-

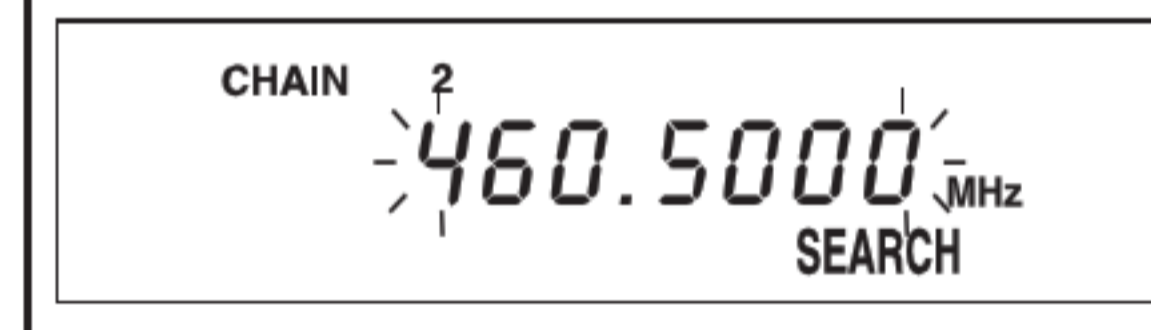

4. Press **SRCH**.

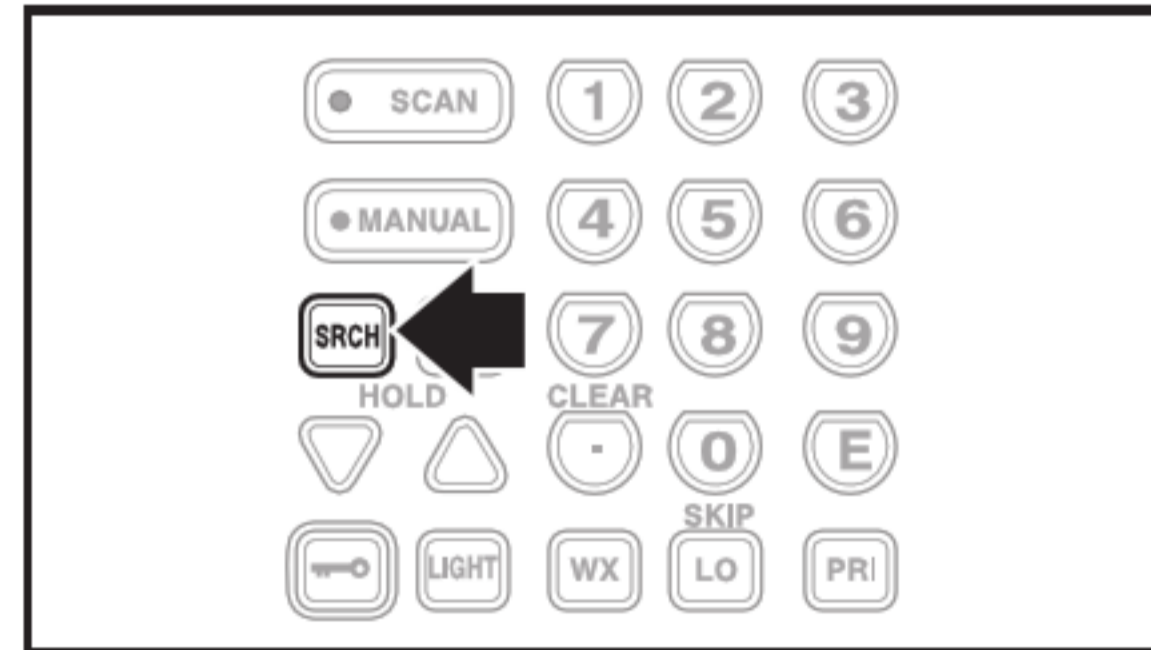

5. When the scanner stops at the frequency you want, press either **UP** or **DOWN**.

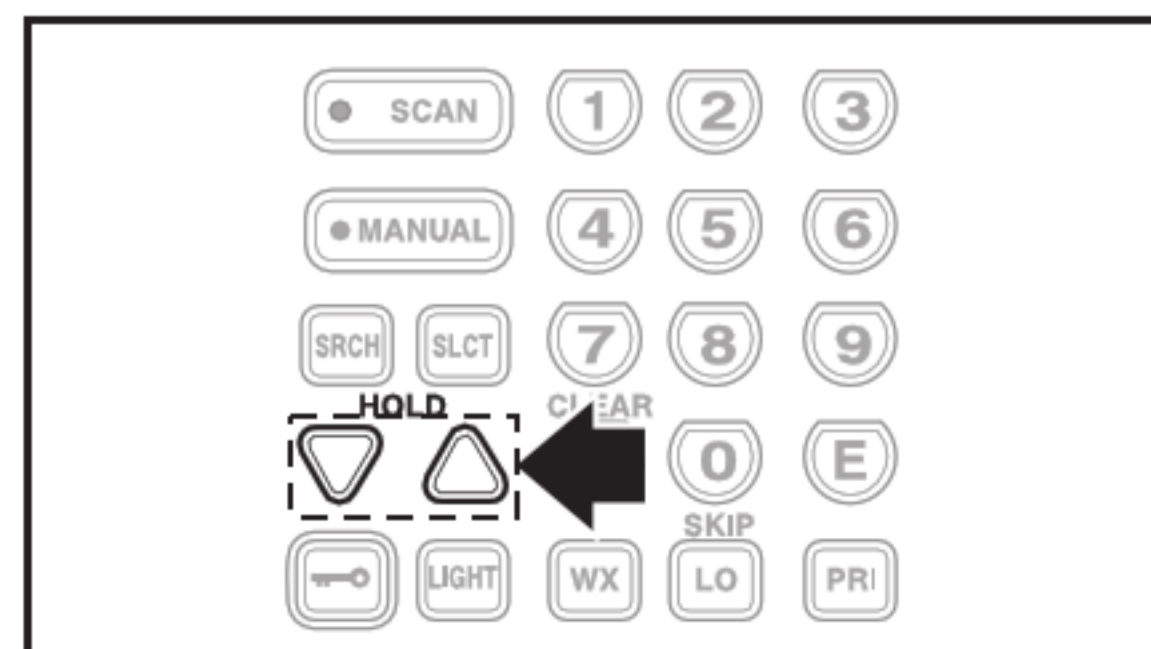

Note: After this step you are in Search Hold mode. Press  to resume scanning.



6. Press  to store the frequency in the channel you selected.

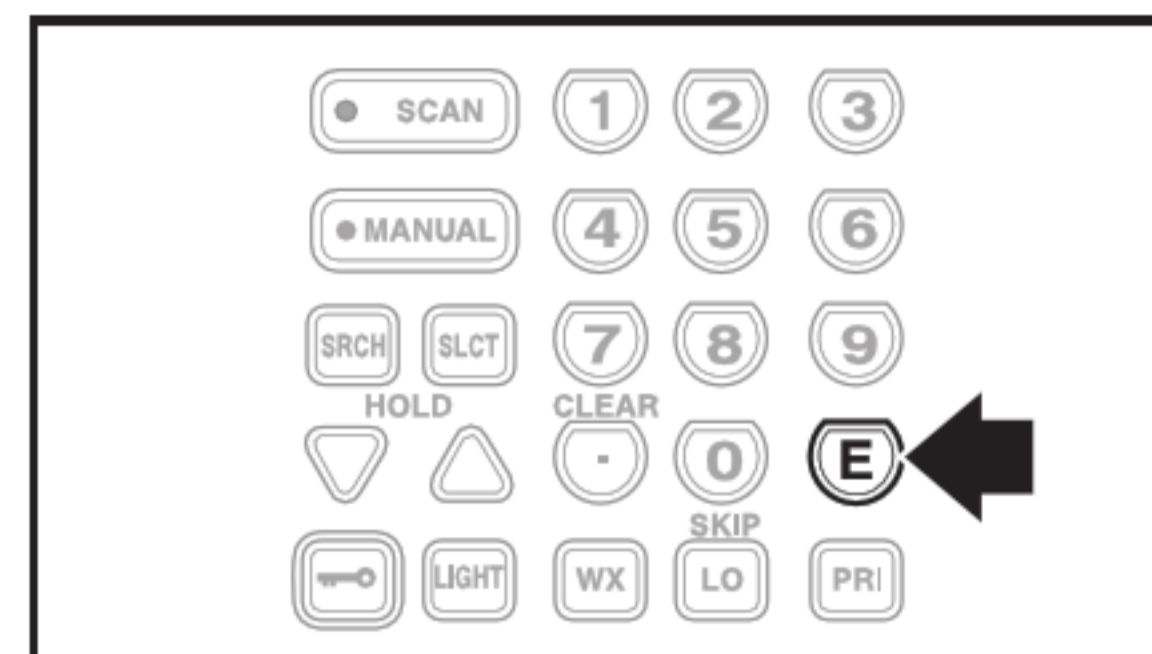

Note: After this step you are in manual mode.



Repeat steps 2 through 6 for all the Search frequencies you want to store.

Note: Remember that there are only 30 channels available to store frequencies, whether you program them directly or while using the Chain Search mode.

Weather Scan

Your *BC60XLT-1* is designed to scan 7 programmed NOAA frequencies, so you easily find your local NOAA weather broadcast.

Note: *It is not advisable to program a weather frequency into one of the 30 channels since weather channels transmit continuously. The scanner will remain on the weather channel, disrupting the scanning cycle.*

1. Press  to activate the Weather scan.

Note: *Be sure **SQUELCH** is set properly.*

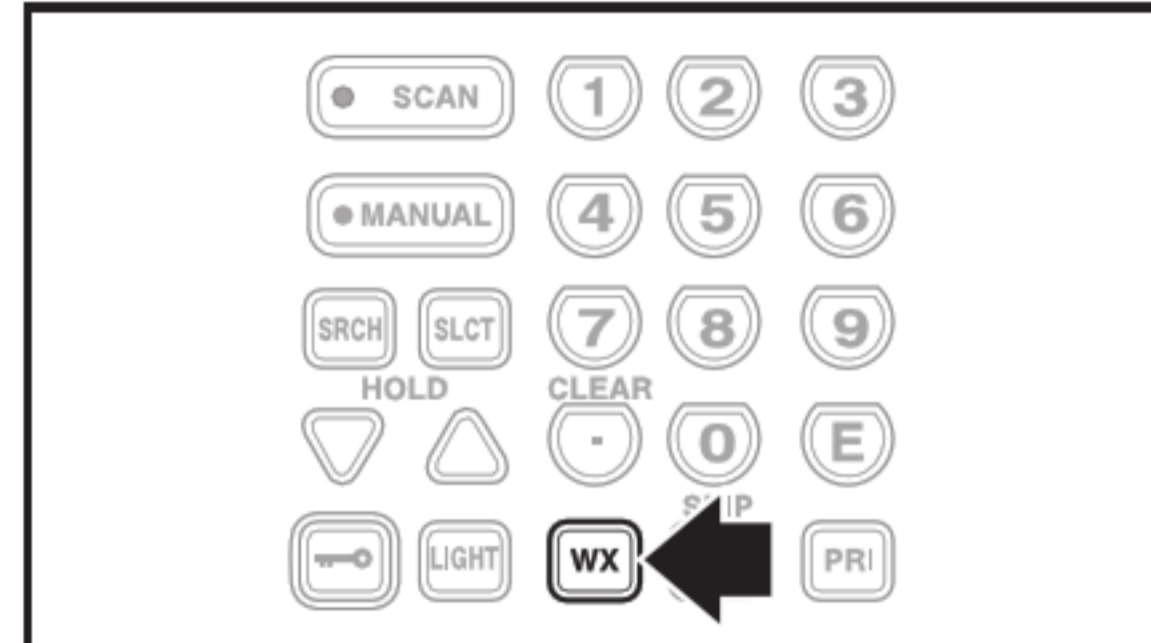



2. When the Weather Scan finds an active weather channel, it stops.

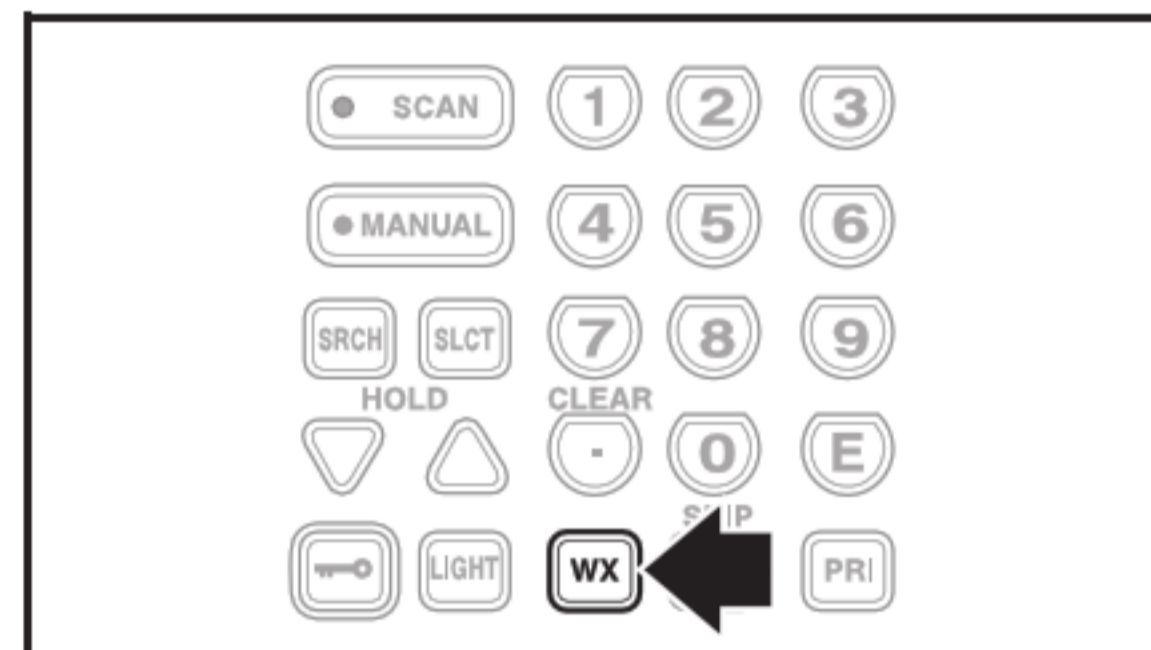

3. Press  again to find the next active weather channel.



Note: *In some parts of the country, you may not be able to monitor weather broadcasts, such as in low-lying areas. Normally, a higher location or a better antenna improves reception.*

4. To exit Weather Scan, press , , or .

Care and Maintenance

General Use

- Turn the scanner off before disconnecting the power or replacing the batteries.
- Always write down the programmed frequencies in the event of memory loss.
- If memory is lost, simply reprogram each channel. The display shows *000.0000* in all channels when there has been a memory loss.
- Always press each button firmly until you hear the entry tone for that key entry.

Location

- Do not use the scanner in high-moisture environments such as the kitchen or bathroom.
- Avoid placing the unit in direct sunlight or near heating elements or vents.
- If the scanner receives strong interference or electrical noise, move it or its antenna away from the source of the noise. If possible, a higher elevation, may provide better reception. Also try changing the height or angle of the antenna.
- Do not plug the scanner into an outlet controlled by a wall switch because long power interruptions may cause memory loss.

Cleaning



- Disconnect the power to the unit before cleaning.
- Clean the outside of the scanner with a mild detergent. To prevent scratches, **do not** use abrasive cleaners or solvents. Be careful not to rub the LCD window.
- Do not use excessive amounts of water.

Repairs

- Do not attempt any repair. The scanner contains no serviceable parts. Contact the Uniden Customer Service Center or take it to a qualified repair technician.

Birdies

- All radios can receive “birdies” (undesired signals). If your scanner stops during Scan mode and no sound is heard, it may be receiving a birdie. Birdies are internally generated signals inherent in the electronics of the receiver.

Press  to lockout the channel, and then press  to resume scanning.

Troubleshooting

If your *BC60XLT-1* is not performing properly, try the following steps.

Problem	Suggestion
Scanner won't work.	1. Check the connections at both ends of the AC Adapter.
	2. Turn on the wall switch of your room. You could be using an outlet controlled by the wall switch.
	3. Move the AC Adapter to another wall outlet or replace the batteries.
Improper reception.	1. Check the antenna connection or move and reposition the antenna.
	2. Move the scanner.
	3. You may be in a remote area which could require an optional multi-band antenna. Check with your dealer or local electronics store.
Scan won't stop.	1. Adjust squelch threshold - refer to page 10, <i>Setting the Squelch</i> .
	2. Check the antenna connection.
	3. Check to see if many of the channels are locked out. If so, the scanner has less chance of finding an active channel.
	4. Review each channel's frequency to see if it is still stored in memory and is correct.
	5. It's possible that none of the programmed frequencies are currently active.
Scan won't start.	1. Press the  key again.
	2. Adjust the SQUELCH control.
	3. Check to see if all channels are locked out.
Weather Scan won't work.	1. Adjust squelch threshold - refer to page 10, <i>Setting the Squelch</i> .
	2. Check the antenna.

If you still cannot get satisfactory results and want additional information, or to return the unit for service, please call or write the Uniden Parts and Service Division. The address and phone number are listed in the Warranty at the end of this manual, or call 1-800-297-1023.

Specifications

Certified in accordance with FCC Rules and Regulations Part 15, Subpart C, as of date of manufacture.

Channels:	30 (1 Bank)
WX:	7 NOAA Weather Service Channels
Search Bands:	10 Preprogrammed Bands 5 Programmable Chain Search Bands
Frequency Range:	29.0–29.7 MHz 10 Meter Amateur Band 29.7–50 MHz VHF Low Band 50–54 MHz 6 Meter Amateur Band 137–144 MHz Military Land Mobile 144–148 MHz 2 Meter Amateur Band 148–174 MHz VHF High Band <i>Above bands in 5 kHz steps</i> 406–420 MHz Federal Government 420–450 MHz 70 cm Amateur Band 450–470 MHz UHF Standard Band 470–512 MHz UHF “T” Band <i>Above bands in 12.5 kHz steps</i>
Operating Temperature:	–20 °C to +60 °C
Scan Rate:	10 Channels per second
Search Rate:	10 Steps per second
Scan Delay:	2 seconds
Audio Output:	18 mW nominal into 8Ω internal speaker 3 mW nominal into 32Ω stereo headphone 8 mW nominal into 64Ω earphone
Power Requirements:	12VDC using AD70U Adapter or 4AA Alkaline or rechargeable Nickel-Cadmium Batteries
Antenna:	Rubber antenna (included)
External Jacks:	External earphone, DC 12V power jack
Size:	2½ in. (W) x 1½ in. (D) x 7 in. (H)
Weight:	12 oz.

Features, Specifications, and availability of optional accessories are all subject to change without notice.

Accessories and Replacement Parts

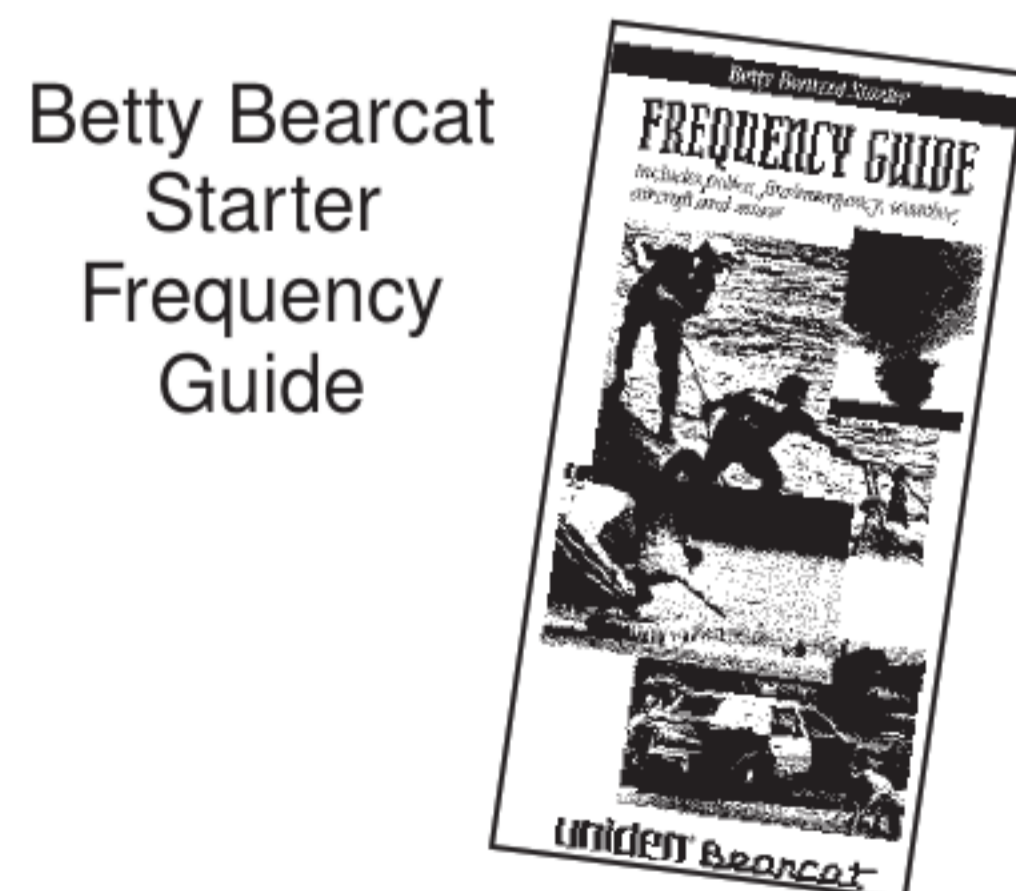
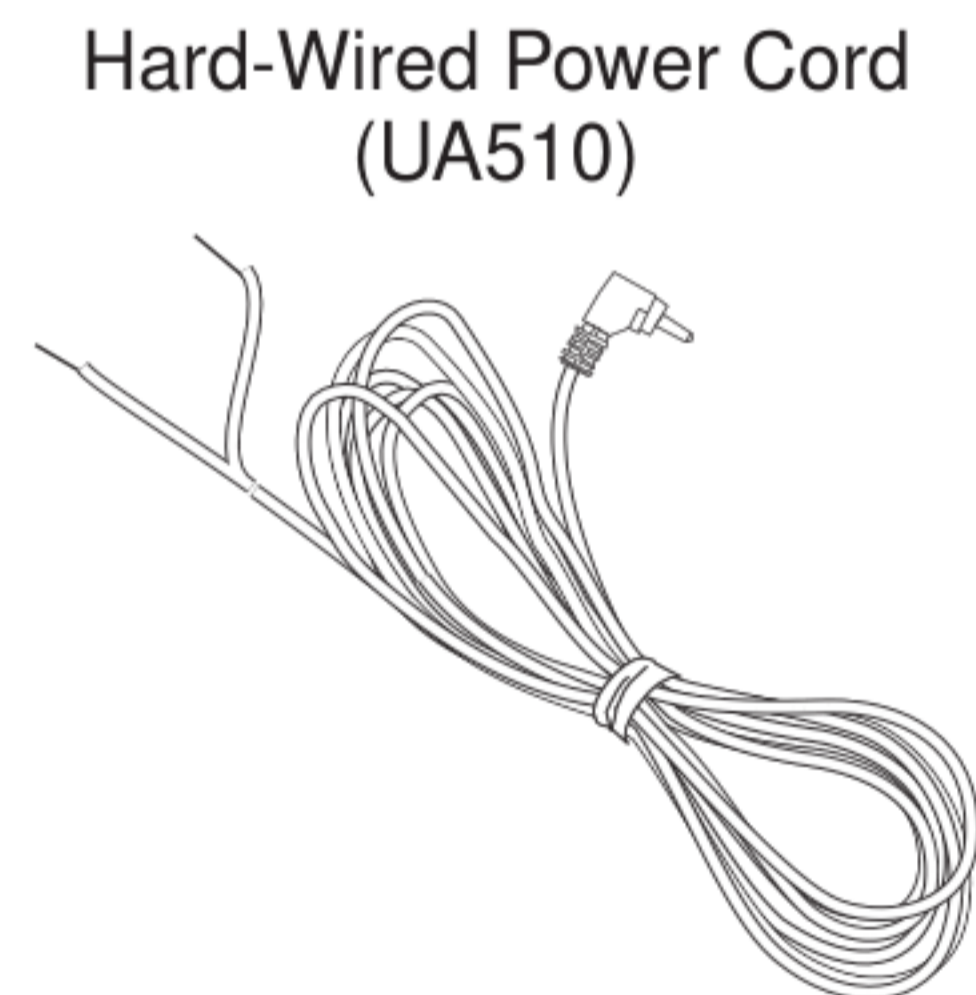
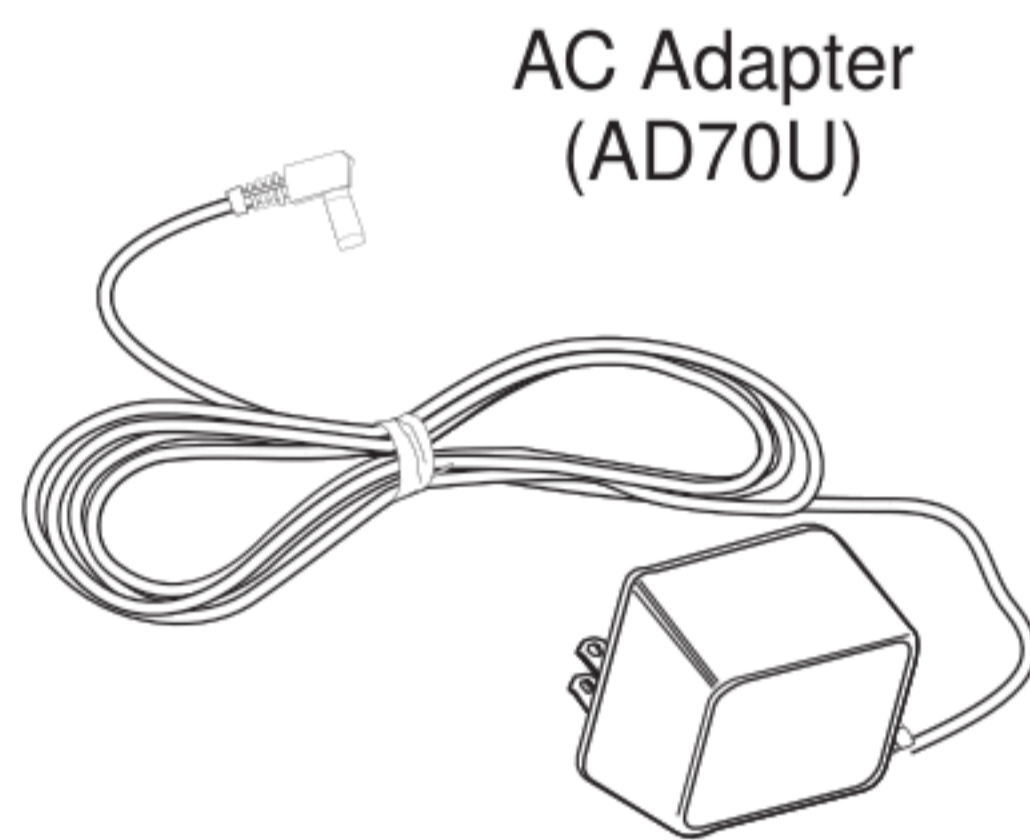
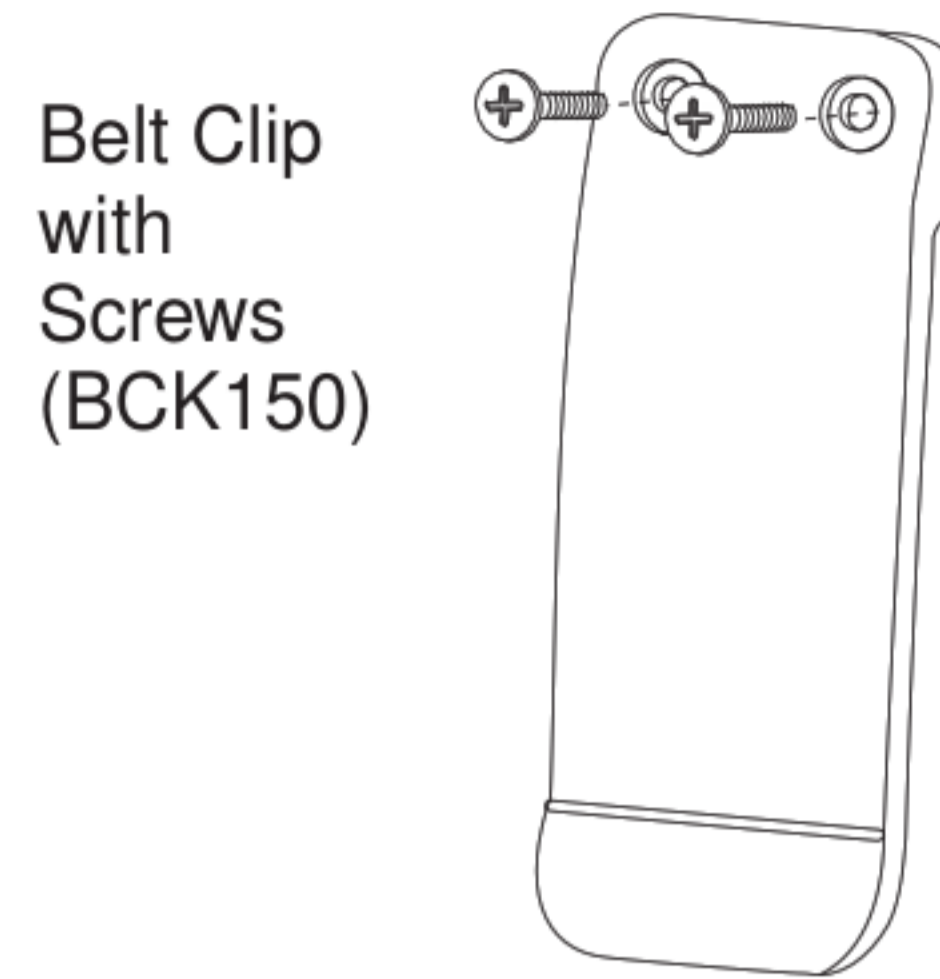

One Year Limited Warranty

Important: Evidence of original purchase is required for warranty service.

WARRANTOR: UNIDEN AMERICA CORPORATION (“Uniden”)
ELEMENTS OF WARRANTY: Uniden warrants, for one year, to the original retail owner, this Uniden Product to be free from defects in materials and craftsmanship with only the limitations or exclusions set out below.

WARRANTY DURATION: This warranty to the original user shall terminate and be of no further effect 12 months after the date of original retail sale. The warranty is invalid if the Product is (A) damaged or not maintained as reasonable or necessary, (B) modified, altered, or used as part of any conversion kits, subassemblies, or any configurations not sold by Uniden, (C) improperly installed, (D) serviced or repaired by someone other than an authorized Uniden service center for a defect or malfunction covered by this warranty, (E) used in any conjunction with equipment or parts or as part of any system not manufactured by Uniden, or (F) installed or programmed by anyone other than as detailed by the Operating Guide for this product.

STATEMENT OF REMEDY: In the event that the product does not conform to this warranty at any time while this warranty is in effect, warrantor will repair the defect and return it to you without charge for parts, service, or any other cost (except shipping and handling) incurred by warrantor or its representatives in connection with the performance of this warranty. THE LIMITED WARRANTY SET FORTH ABOVE IS THE SOLE AND ENTIRE WARRANTY PERTAINING TO THE PRODUCT AND IS IN LIEU OF AND EXCLUDES ALL OTHER WARRANTIES OF ANY NATURE WHATSOEVER, WHETHER EXPRESS, IMPLIED OR ARISING BY OPERATION OF LAW, INCLUDING, BUT NOT LIMITED TO ANY IMPLIED WARRANTIES OF MERCHANTABILITY OR FITNESS FOR A PARTICULAR PURPOSE. THIS WARRANTY DOES NOT COVER OR PROVIDE FOR THE REIMBURSEMENT OR PAYMENT OF INCIDENTAL OR CONSEQUENTIAL DAMAGES. Some states do not allow this exclusion or limitation of incidental or consequential damages so the above limitation or exclusion may not apply to you.

LEGAL REMEDIES: This warranty gives you specific legal rights, and you may also have other rights which vary from state to state. This warranty is void outside the United States of America.

PROCEDURE FOR OBTAINING PERFORMANCE OF WARRANTY: If, after following the instructions in this Operating Guide you are certain that the Product is defective, pack the Product carefully (preferably in its original packaging). Include evidence of original purchase and a note describing the defect that has caused you to return it. The Product should be shipped freight prepaid, by traceable means, or delivered, to warrantor at:

**Uniden America Corporation
Parts and Service Division
4700 Amon Carter Boulevard
Fort Worth, TX 76155
(800) 297-1023, 8:00 a.m. to 5:00 p.m., Central, Monday
through Friday**

Covered under one or more of the following U.S. patents:

RE31,523	4,027,251	4,057,760	4,092,594	4,100,497
4,114,103	4,123,715	4,156,193	4,157,505	4,179,662
4,219,821	4,270,217	4,398,304	4,409,688	4,455,679
4,461,036	4,521,915	4,627,100	4,888,815	4,932,074
4,947,456	5,014,348	5,199,109		

uniden®

Beancat®

©1995 Uniden America Corporation. All rights reserved.
Printed in the Philippines