

uniden[®]

**OPERATIONS MANUAL
BC80 XLT
SCANNER**

Controls and Indicators

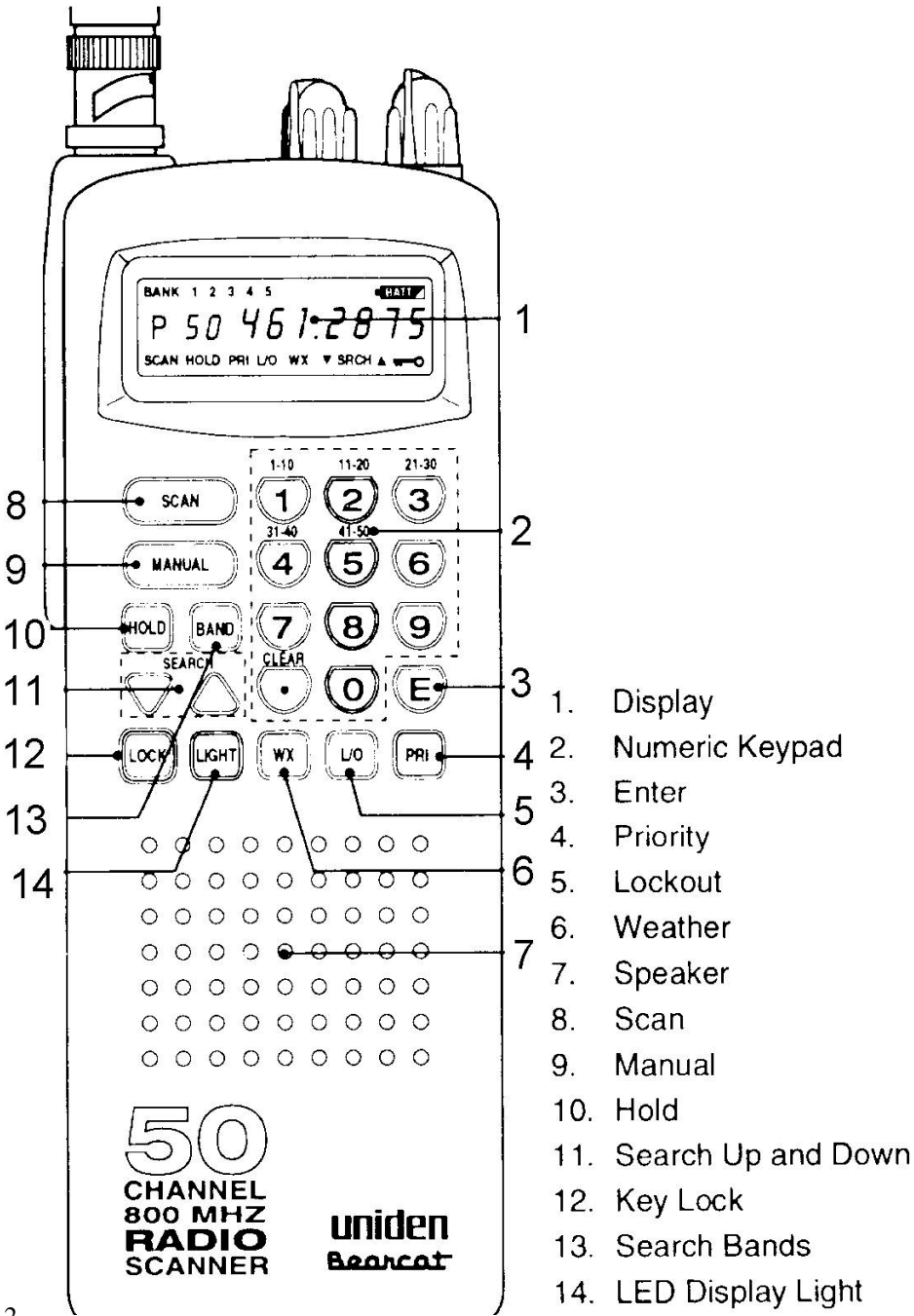

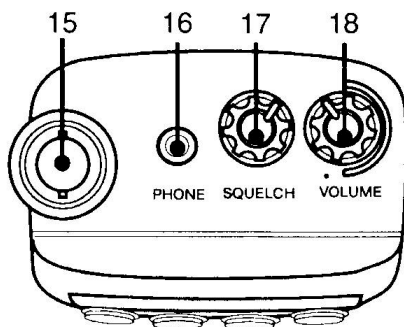

- 15. Antenna Connector
- 16. Phone Jack
- 17. Squelch Control
- 18. On/Off Volume Control

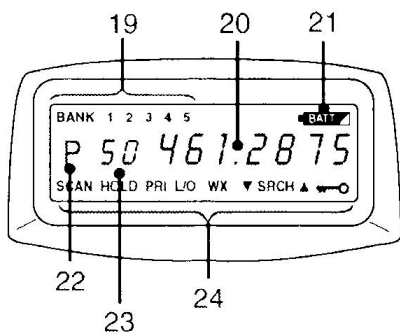

- 19. Bank Indicators
- 20. Frequency Display
- 21. Low Battery Indicator
- 22. Priority Channel Indicator
- 23. Channel Display
- 24. Function Indicators

Precautions

Before you use this scanner, please read and observe the following:

Earphone Warning!

Be sure to use only the recommended optional monaural earphone (EPO09). You may also use a 32Q stereo headset. Use of an incorrect earphone or stereo headset may be potentially hazardous to your hearing. The output of the Phone jack is monaural, but you will hear it in both headphones of a stereo headset.

Set the Volume to a comfortable audio level coming from the speaker before plugging in the monaural earphone or a stereo headset of the proper impedance (32Q). Otherwise you might experience some discomfort or possible hearing damage if the Volume suddenly becomes too loud because of the Volume Control or Squelch Control setting. This may be particularly true of the type of earphone that is placed in the ear canal.

WARNING!

Uniden does not represent this unit to be waterproof. To reduce the risk of fire or electrical shock, do not expose this unit to rain or moisture.

IMPORTANT!

The installation, possession, or use of this scanning radio in a motor vehicle may be prohibited, regulated, or require a permit in certain states, cities, and/or local jurisdiction. Your local law enforcement officials should be able to provide you with information regarding the laws in your community.

General Battery Warning!

Do not short-circuit any Battery.

Do not discard Batteries in a fire; they may explode.

Alkaline Battery Warning!

Do not recharge Alkaline Batteries in this product.

Doing so may cause serious damage to the product and will void the warranty.

Uniden does not recommend using rechargeable Alkaline Batteries in this product.

Nickel-Cadmium Battery Warning! When using Nickel-Cadmium Batteries with this product, take note of the following warnings:

Cadmium is a chemical known to the State of California to cause cancer.

Do not charge Nickel-Cadmium Batteries with any charger other than the one supplied with this product. Using another charger may damage the Batteries, or cause them to explode.

Nickel-Cadmium Batteries must be disposed of properly

Residents of Minnesota should contact 1-800-225-PRBA for information concerning reclamation and disposal of nickel-cadmium batteries.

Residents outside of Minnesota should contact their local authorities for information concerning reclamation and disposal of nickel-cadmium batteries.

Uniden and Bearcat are registered trademarks of Uniden America Corporation.

Contents

Introduction	6
What is Scanning?	6
What is Searching?	6
Types of Communications	6
Feature Highlights	7
Scanner Care & Safety Tips	7
Where to Obtain More Information	7
Included with your Scanner	8
Setup	9
Power	9
Install Batteries	9
AC Adapter/Charger	10
Flexible Antenna	11
Belt Clip	11
Basic Operation	12
How Squelch Works	12
Setting the Squelch	12
Key-Lock	13
Programming	14
Programming Tips	15
Scanning	16
Banks	18
Channel Lockout	18
Lockout in Manual Mode	18
Locking a Channel While Scanning.	19
Lockout Tips	17
Restore a Locked Out Channel . . .	17
Restore All Locked-out Channels. .	20
Priority Scan	20
Changing the Priority Channel	21
Search	22
Access Frequencies Manually	24
Storing Search Frequencies	25
Weather Scan	27
Care and Maintenance	28
General Use	28
Location	28
Cleaning	28
Repairs	28
Birdies	28
Troubleshooting	29
Technical Specifications	30
Warranty	31

Introduction

The **BC80XLT** is a new state-of-the-art radio with scanning capabilities. Store frequencies into 5 banks of 10 channels each.

What is Scanning?

Unlike standard AM or FM radio stations, most two-way communications (listed on this page) do not transmit continuously. The **BC80XLT** scans programmed channels until it finds an active frequency. Scanning stops on an active frequency, and remains on that channel as long as the transmission continues. When the transmission ends, the scanning cycle resumes until another transmission is received. While the **BC80XLT** scans channels, it is in Scan mode. When you stop scanning with "MANUAL" it is in Manual mode.

What is Searching?

The **BC80XLT** can search 11 bands to find active frequencies. This gives you the opportunity to find new frequencies that have not been programmed. While the **BC80XLT** searches for active frequencies, it is in Search mode. When you stop the search with "HOLD" it is in Search Hold mode.

Types of Communications

Monitor communications such as:

- Police and fire department (including rescue and paramedics)
- NOAA weather broadcasts (preprogrammed channels)
- Business/industrial radio
- Motion picture and press relay
- Utility
- Land transportation frequencies, such as trucking firms, buses, taxis, tow trucks, and railroads
- Marine and amateur (ham radio) bands
- And more in the following 11 Bands:

Frequency Range Transmission

29-29.7	MHz 10 Meter Amateur Band
29.7-50	MHz VHF Low Band
50-54	MHz 6 Meter Amateur Band
137-144	MHz Military Land mobile
144-148	MHz 2 Meter Amateur Band
148-174	MHz VHF High Band
406-420	MHz Federal Govt. Land Mobile
420-450	MHz 70 cm Amateur Band
450-470	MHz UHF Standard Band
470-512	MHz UHF "T" Band
806-956	MHz Public Service Band except Cellular Band

Feature Highlights

50 Channels — Program one frequency into each channel. You must have at least one channel programmed to use the Scan mode.

29 MHz-956 MHz — Search these frequency ranges with your scanner. (The frequency coverage is not totally continuous from 29 MHz to 956 MHz.)

5 Priority Channels — Assign one Priority channel in each bank. Keep track of the activity on most important channel(s) while monitoring others.

Manual Channel Access — Go directly to any channel.

Memory Backup — Frequencies programmed in the channels are retained in memory. If the power is disconnected, the memory retains the frequencies for 7 days.

Weather Scan — Use as a weather information radio.

Preset 2-Second Delay — Scanner waits 2 seconds after transmission stops before resuming scanning.

Scanner Care & Safety Tips

Do not use the scanner in high-moisture areas such as the kitchen or bathroom.

Do not plug the scanner into an outlet controlled by a wall switch as prolonged periods without power causes scanner memory loss.

Avoid placing the unit in direct sunlight or near heating elements or vents.

Where to Obtain More Information

Before you can scan, you must program a frequency into each channel you want to use. The *“Betty Bearcat Scanner Frequency Guide”* lists typical frequencies used around the U.S. and Canada that you may program into the **BC80XLT**.

If the frequencies listed in the *“Betty Bearcat Starter Frequency Guide”* do not work in your area, call the enclosed **“Mr. Scanner”** 800 number. A Uniden representative should be able to provide you with a few sample frequencies. Or, use the enclosed order form to purchase a local frequency list.

The Bearcat Radio Club and other similar hobby clubs have publications, information on computer bulletin boards, and even contests for the radio enthusiast. Also, your local library has more information.

— Included With Your Scanner —



Other
Printed
Material

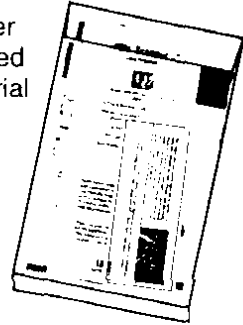

- ☞ If any items are missing or damaged, immediately contact your place of purchase.
- ☞ Read this Operating Guide thoroughly before operating the scanner.
- ☞ Complete and immediately mail the Registration Form.

Rubber Antenna
(AT218)



Monaural Earphone
64 Ω
(EP009)

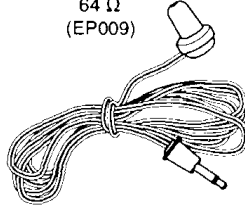

BC80XLT
Operating Guide
(OMBC80XLT)

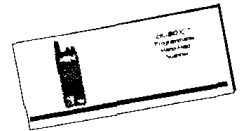

Betty Bearcat
Starter
Frequency
Guide



Belt Clip
with
Screws
(BCK150)



AC Adapter
(AD70U)

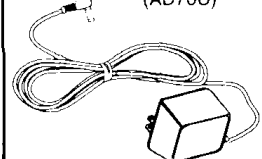

Note

- If your scanner receives strong interference or electrical noise, move the scanner or its antenna away from the source.
- If you are operating the scanner in a fringe area or need to improve reception, use an optional antenna designed for multi-band coverage. (You can purchase this type of antenna at a local electronics store.) If the plug at the end of the cable does not match the antenna jack, you may need to purchase an adapter.
- In noisy areas or for private listening, use the included earphone or an optional stereo headset of the proper impedance. Read the precautions on the inside front cover of this Guide

Power

Install Batteries

1. Open the cover.

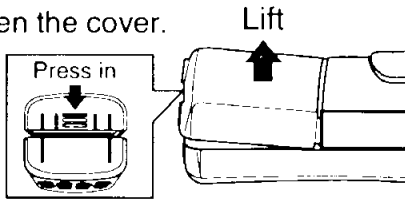

2. Insert batteries.

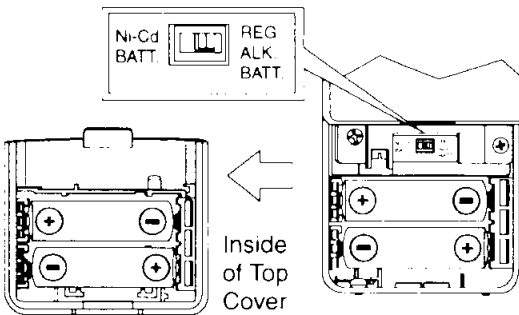

Important!

If you are installing alkaline batteries, set the switch to **REG. ALK. BATT.** If installing Nickel Cadmium batteries, set the switch to **Ni-Cd BATT.**

Warning!

Do not mix alkaline batteries with nickel-cadmium batteries. Be sure to install 4 batteries of the same type.

3. Replace cover.

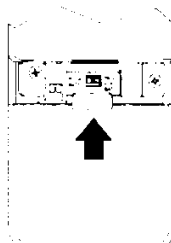

4. Press down until the cover clicks into place.

Warning!

Do not mix alkaline batteries with nickel-cadmium batteries. Be sure to install 4 batteries of the same type.

Warning!

Use only the supplied AC Adapter (AD70U) or one of the optional power cords (UA502 or UA510).

Battery Warning!

*Do not charge alkaline batteries in this scanner. Doing so may cause serious damage to the product and void the warranty. Before attempting to recharge batteries, make sure you have installed 4 rechargeable nickel-cadmium batteries and the selector switch is set to **Ni-Cd**.*

Caution

The AC Adapter included with this scanner may be equipped with a polarized alternating line plug (a plug with one blade wider than the other.) This plug will fit into the power outlet only one way. If you are unable to insert the plug fully into the outlet, try reversing the plug. If the plug should still fail to fit, contact an electrician to replace the obsolete outlet. **Do not** alter the shape of the blades to the polarized plug.

Note:

Changes or modifications to this product not expressly approved by Uniden, or operation of this product in any way other than as detailed by the owner's manual, could void your authority to operate this product.

AC Adapter/Charger

Use the AC Adapter/Charger to power the **BC80XLT** from the AC outlet.

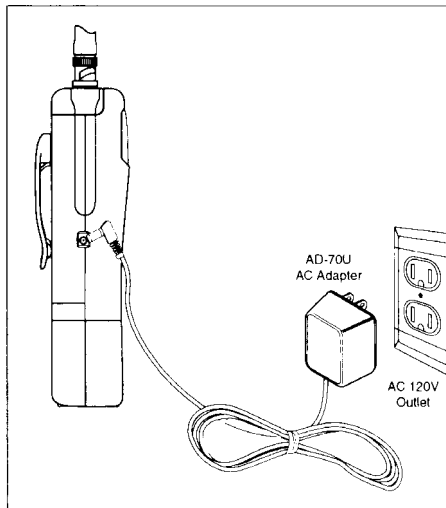

Flexible Antenna

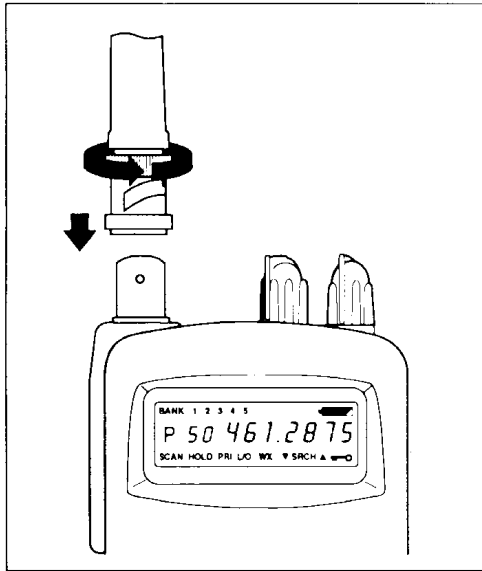

Belt Clip

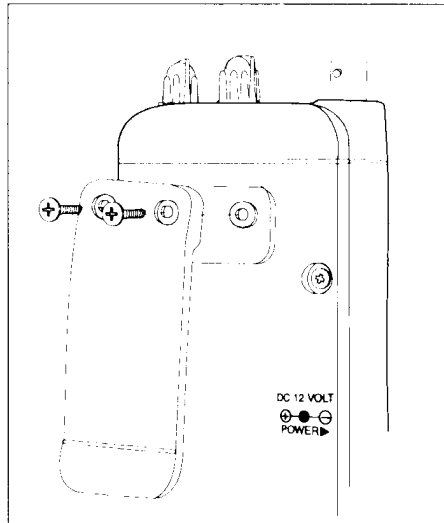

Caution:

Do not tighten the screws too tight. You can damage the case or clip.

Basic Operation

Note: *Fold out the illustration from the Front Cover to see the Controls and Indicators while reading this Guide.*

How Squelch Works

Think of "Squelch" as a gate. If the gate is too low (squelch too high), everything (all noise as well as signals) gets through.

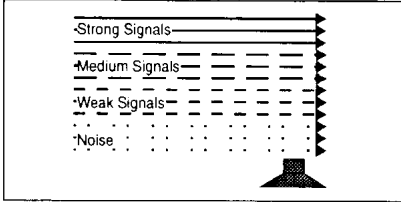

If the gate is set too high (squelch too high), nothing gets through.

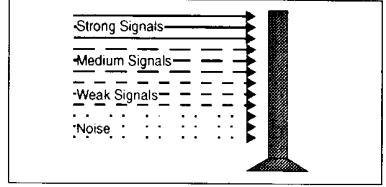

If the gate is set just right (squelch set properly), just the desired signals get through.

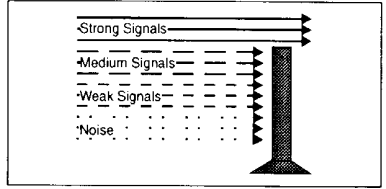

Setting the Squelch

Adjust **VOLUME** to a comfortable listening level.

To set the Squelch, you must be in the Manual Mode. No signal should be present when adjusting squelch.

Press **MANUAL** until you **do not** hear a signal.

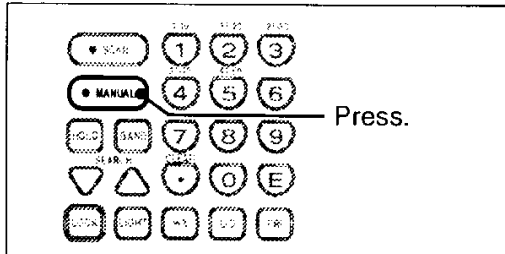

Turn until hiss heard.
 This lowers the “squelch gate,” allowing
 all signals and noise to get through.

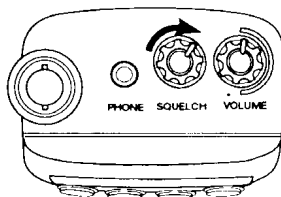

Turn just until hiss stops.
 This raises the “squelch gate” allowing
 only strong signals to get through.

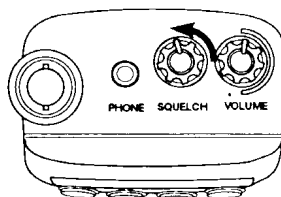

Keylock

Key lock prevents accidental key entries.

1. To lock the keypad:

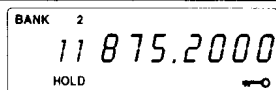
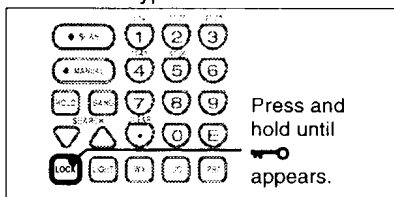

2. To unlock the keypad:

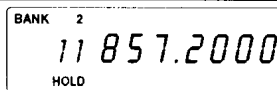
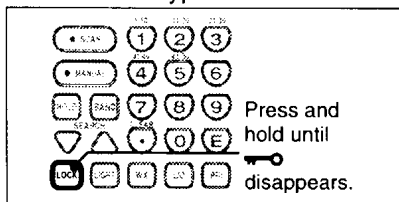

Programming

Before the **BCBOXLT** can receive, you must program a frequency into at least one channel. Before scanning, repeat this procedure for each channel you program.

1. Select the frequency.

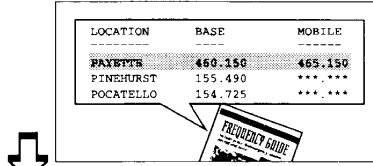

- 2.

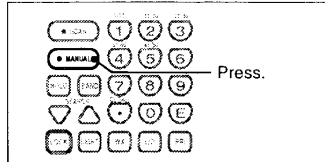

3. Select the channel.

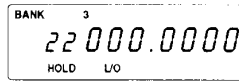
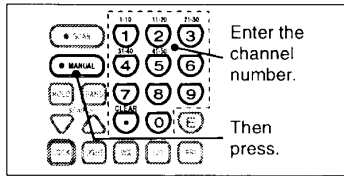

4. Enter the frequency.

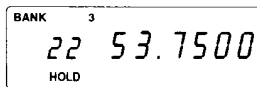
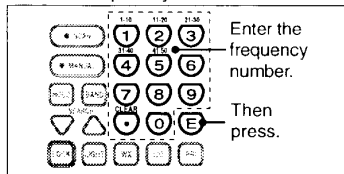

To clear a mistake while entering the frequency, press **(C)** twice, and start over.

If the entered frequency is outside the Frequency Range of the scanner, (See Table on page 2, and the Band List on the back the scanner), a distinctive beep sounds.

Press **(C)** and go back to Step 4.

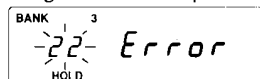

Programming Tips

- Do not program a weather frequency into one of the channels. Since weather channels transmit continuously, the scanner will remain on that channel, disrupting the scanning cycle. Use **[WX]** for weather information.
- Group similar frequencies into adjacent channels, such as police frequencies in channels 1 through 10 and fire/emergency into channels 11 through 20.
- Put the frequency that you listen to the most or the most important frequency into a Priority channel.
- To quickly program a series of channels, start with the lowest number channel. For example, when you are programming five new frequencies into Channels 4 through 8, start with Channel 4. After you finish programming a channel, press **[MANUAL]** or **▲** to step up to the next channel.
- To erase the channel, enter **[0]** or **[E]**. Channels with no frequencies are automatically locked out.

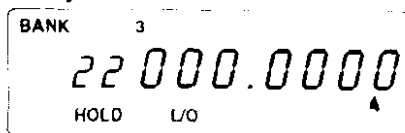

- Record channels and frequencies in some convenient place in case the scanner memory is lost.

Scanning

When you turn on the power, the **BCBOXLT** automatically starts in the Scan mode.

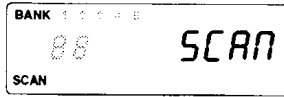

During normal scanning the scanner skips unprogrammed or locked out channels.

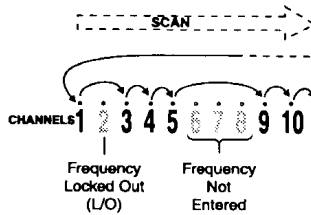

When a transmission is received, the Scanner stops on that channel. When the transmission ends, scanning resumes automatically after 2 seconds.

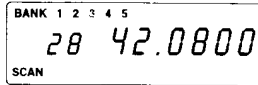

To stop on a channel during scanning:

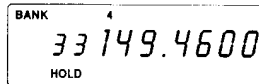
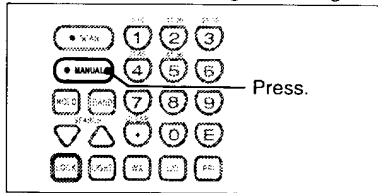

To resume scanning:

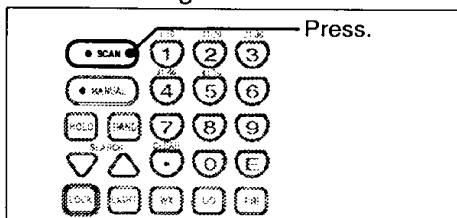

Lockout Tips

- To quickly lockout a series of channels, start with the lowest number channel.

Example, when you are locking out 5 channels in numerical sequence (Channels 4, 7, 8, 12, and 15), start with Channel 4. Press **MANUAL**, press **4**, and press **MANUAL** to go to channel 4. Press **LO**.

Then, press **MANUAL** one or more times to step up to the next channel to be locked out.

- Record locked-out channels in some convenient place so you can restore them.

Restore a Locked Out Channel

1. Enter Manual mode.

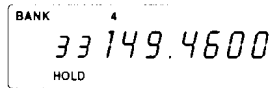
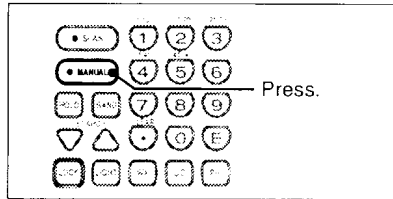

2. Select the channel.

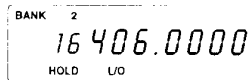
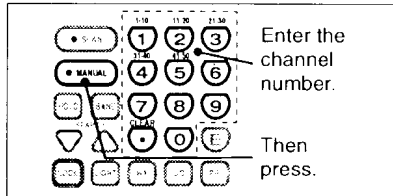

3. Unlock the channel.

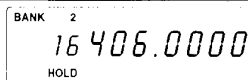
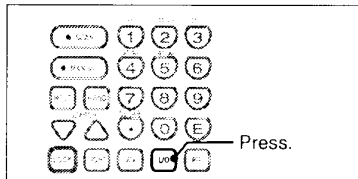

Banks

Channels are grouped by Banks for easy scanning control.

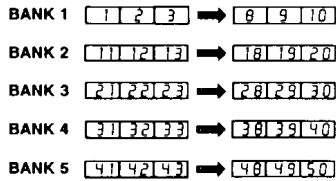

Active Banks display during scanning.

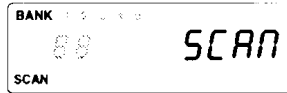

To deactivate a Bank during scanning:

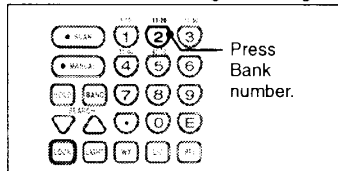

To restore a Bank for Scanning:

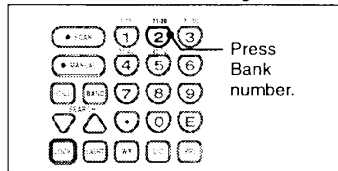

Channel Lockout

You can "lock out" any channel so it is not scanned during normal scanning. You can restore the channel to scanning whenever you wish.

Note: You can lock out up to 49 channels, but not all 50 channels. One channel must remain active for the scanner to work.

Lockout in Manual Mode

1. Enter Manual mode.

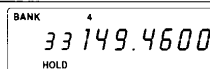
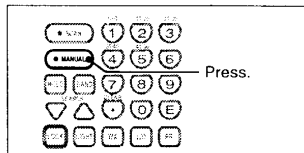

2. Select the channel.

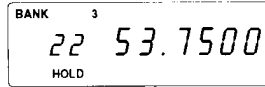
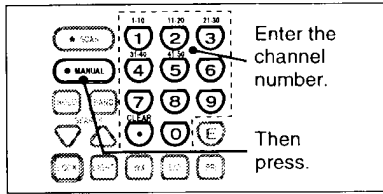

3. Lock out the channel.

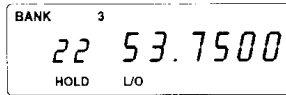
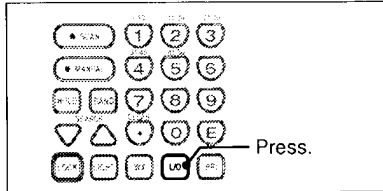

Locking a Channel While Scanning

If the scanner keeps stopping on a particular channel due to noise or too-frequent transmissions, you may want to keep that channel from scanning.

1. Wait until the scanner stops at the channel.

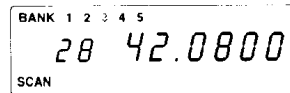

2. Then:

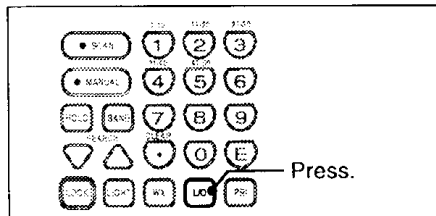

The scanner immediately resumes scanning because that channel is no longer in the scanning sequence.

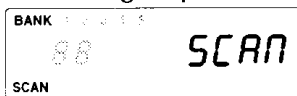

Restore All Locked-out Channels

1. Enter Manual Mode.

Note: You must select a programmed channel **not** locked out before restoring locked-out channels.

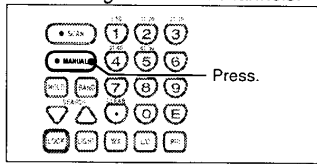

2. Restore all channels.

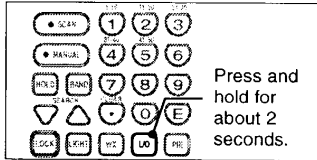

You hear 2 beeps when channels are restored.

Note: Restores locked out channels only in active banks.

Priority Scan

With Priority Scan active, the scanner checks the priority channels every 2 seconds for activity. If a signal is present, the Priority channel is monitored until the transmission ends. Scanning then resumes normally. The **BC80XLT** comes with one Priority channel preprogrammed in each Bank: **1, 11, 21, 31, and 41.**

To activate Priority Scan at any time (Manual or Scan Mode):

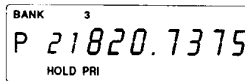
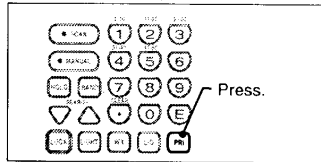

Note: If you have all the priority channels locked out, when you select Priority mode, this displays:

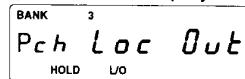

To de-activate Priority Scan at any time (Manual or Scan mode):

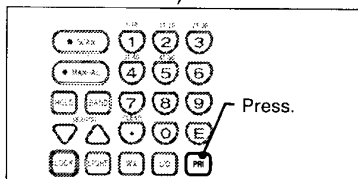

Changing the Priority Channel

There can be only 1 Priority channel per bank. You cannot *eliminate* a Priority channel, but you can *change* the Priority channel to any other channel within that Bank.

1. Enter Manual mode.

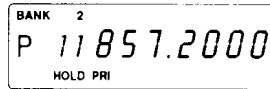
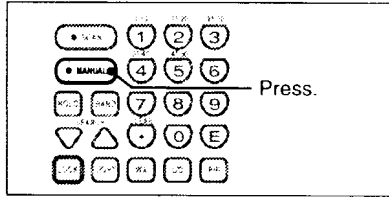

2. Select the new Priority channel.

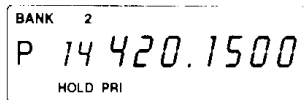
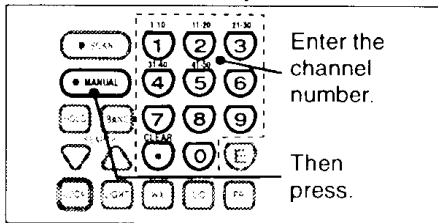

3. Change Priority to *this* channel.

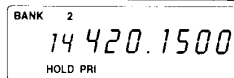
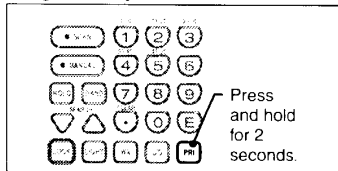

2 “beeps” indicate Priority channel is changed.

Note: If you now go back to check the previous Priority channel, you’ll see the P is gone.

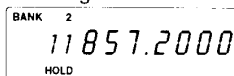

Search

You can use the Search feature to find active frequencies in your area. This feature is handy for finding frequencies besides those in your Betty Bearcat Starter Frequency Guide.

You can search for any frequencies between 29 and 956 MHz, as long as they are within the 11 bands covered by the **BC8OXLT**. See the table on page 2, the Technical Specifications on page 26, or the table on the back of the **BC8OXLT**.

1. Enter Manual mode.

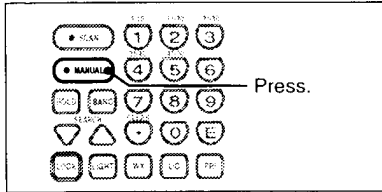

2. Band select.

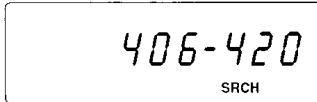
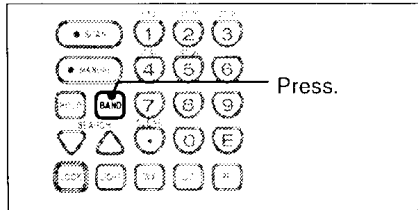

3. Changing Bands:

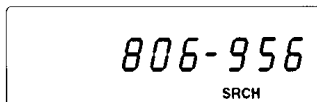
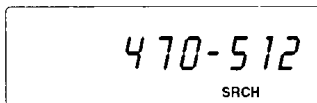
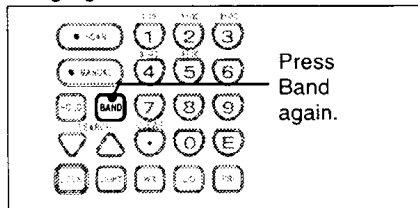

4. Wait a few seconds or press ▲ or ▼ to begin Search.

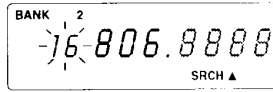

5. When a transmission is detected, the **BCBOXLT** stops on that frequency.

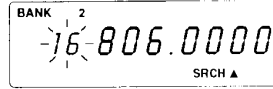

- 6a. When the transmission stops, Search resumes.

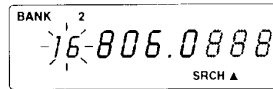

OR

- 6b. You can stay on that frequency to continue to monitor it.

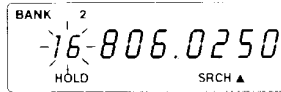
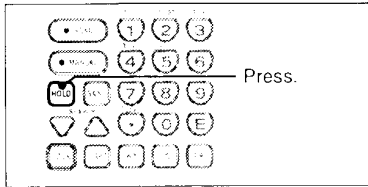

Note: When you find frequencies that interest you, write them down so you can program them into the scanner. You can also automatically program a desired frequency into one of the channels. See page 21.

7. To continue the search:

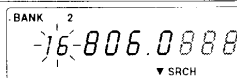
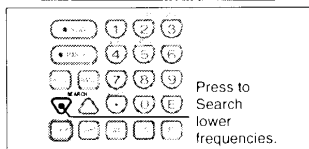
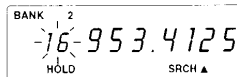
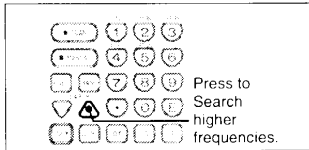

Access Frequencies Manually

1. Stop the Search.

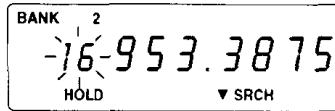
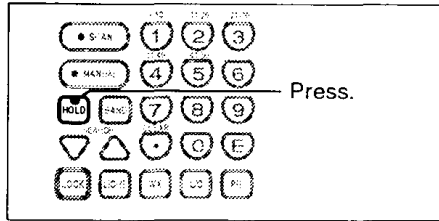

2a. To move up to the next higher frequency:

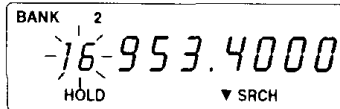
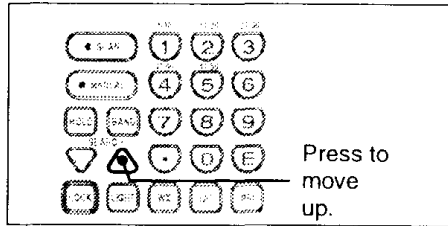

OR

2b. To move down to the previous frequency:

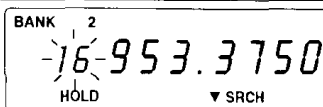
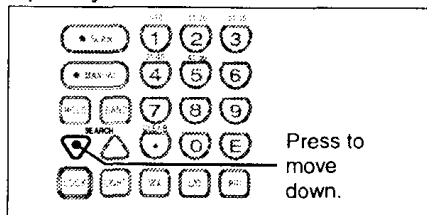

Storing Search Frequencies

You can quickly store any frequency you find during Search.

Important

You must select the channel in which you will store the frequency *before* you enter Search! Otherwise, you may erase a stored frequency that you want to keep.

1. Enter Manual mode.

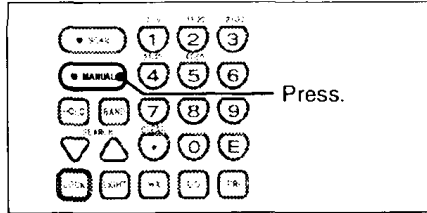

2. Select the channel.

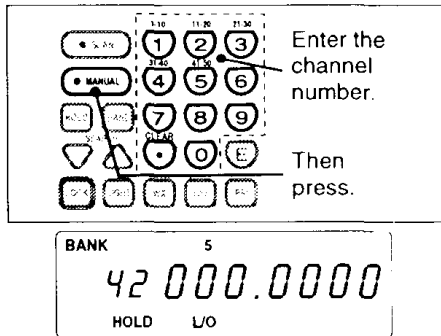

3. Enter Search

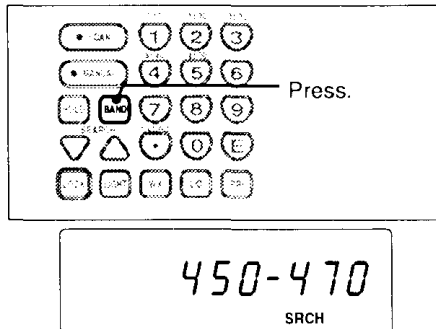

- Wait until the scanner stops at the frequency you want.

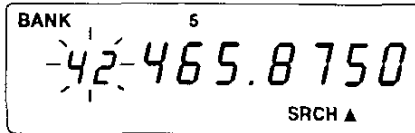
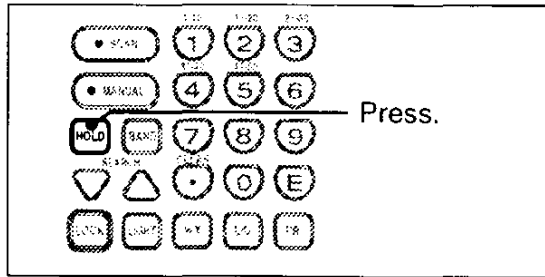

- Store the frequency in the channel you selected earlier.

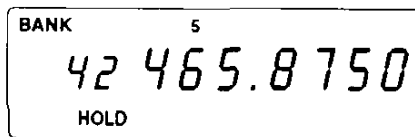
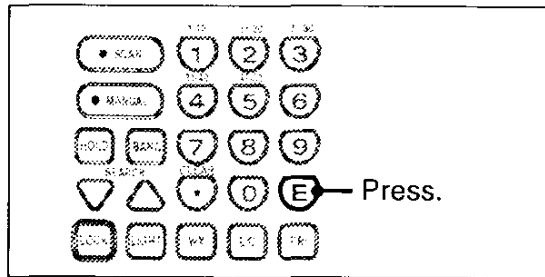

Note: After Step 5 you are in normal Scan Hold mode.

Repeat steps 1 through 5 for all the Search frequencies you want to store. Remember, there are a total of 50 channels for storing frequencies, whether you program them directly or by using the Search mode.

Weather Scan

Your **BC80XLT** is designed to scan the 7 preprogrammed NOAA frequencies to find your local NOAA weather broadcast.

Note: *It is not advisable to program a weather frequency into one of the 50 channels. Because weather channels transmit continuously, the scanner remains on that channel, disrupting the scanning cycle.*

1. To activate the Weather Scan:
(Be sure the Squelch is set properly)

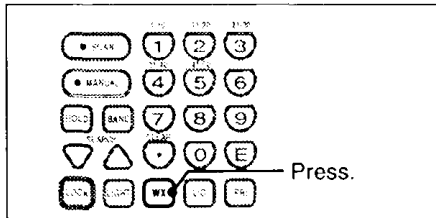

2. When the Weather Scan finds an active weather channel, it stops.

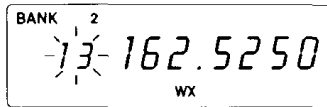

3. To find the next active weather channel:

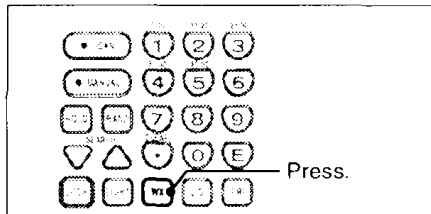

Note: *In some parts of the country, you may not be able to monitor weather broadcasts, such as in low-lying areas. Normally a higher location or a better antenna improves the reception.*

4. To exit Weather Scan, press **(MANUAL)**, **(SCAN)**, or **(BANK)**.

Care and Maintenance

General Use

- Turn the scanner off before disconnecting the power or replacing the batteries.
- Always write down the programmed frequencies in the event of memory loss.
- If memory is lost, simply reprogram each channel. The display shows 000.0000 in all channels when there has been a memory loss.
- Always press each keypad button firmly until you hear the entry tone for that key entry.

Location

- Do not use the scanner in high-moisture environments such as the kitchen or bathroom.
- Avoid placing the unit in direct sunlight or near heating elements or vents.
- If the scanner receives strong interference or electrical noise, relocate it or its antenna away from the source of the noise. If possible, a higher elevation, may provide better reception. Also try changing the height or angle of the antenna.
- Do not plug the scanner into an outlet controlled by a wall switch as prolonged periods without power will cause scanner memory loss.

Cleaning

- Disconnect the power to the unit before cleaning.
- Clean the outside of the scanner with a mild detergent. To prevent scratches, **do not** use abrasive cleaners or solvents. Be careful not to rub the LCD Display window.
- Do not use excessive amounts of water.

Repairs

- Do not attempt any repair. The scanner contains no serviceable parts. Contact the Uniden Customer Service Center or take it to a qualified repair technician.

Birdies

- All radios are subject to receiving "birdies" (undesired signals). If your scanner stops during Scan mode and no sound is heard, it may be receiving a birdie. Birdies are internally-generated signals inherent in the electronics of the receiver. Press **(LOCK)** to lockout a channel, then press **(SCAN)** to resume scanning.

Troubleshooting

If your **BCBOXLT** is not performing properly, try the following steps.

Problem	Suggestion
Scanner won't work.	Check the connections at both ends of the AC Adapter. Turn on the wall switch of your room. You could be using an outlet controlled by the wall switch. Move the AC Adapter to another wall outlet or replace the batteries.
Improper reception.	Check antenna connection. Move or angle the antenna. Relocate the scanner. You may be in a fringe area. This could require an optional multi-band antenna. Check with your dealer or local electronics store.
Scan won't stop.	Adjust squelch threshold - refer to page 8, <i>Setting the Squelch</i> . Check the antenna connection. Check to see if many of the channels are locked out. If so, the scanner has less chance of finding an active channel. Review each channel's frequency to see if it is correct and no memory has been lost. Possibly, none of the programmed frequencies are currently active.
Scan won't start.	Press the Scan key again. Adjust the Squelch control.
Weather Scan won't work.	Check to see if 49 channels are locked out. If so, all but one channel is locked out. Adjust squelch to the threshold - Refer to page 8, <i>Adjusting the Squelch</i> . Check antenna.

If you still cannot get satisfactory results and want additional information, or to return the unit for service, please call or write the Uniden Parts and Service Division. The address and phone number are listed in the Warranty at the end of this manual or call 1-800-297-1023.

Technical Specifications

Certified in accordance with FCC Rules and Regulations Part 15 Sub-part C as of date of manufacture.

Receiver Type	Triple conversion, super heterodyne
Channels:	50
Banks:	5 with 10 channels in each bank
WX:	7 Preprogrammed NOAA Weather Service Channels
Search Bands:	11 Preprogrammed search bands
Frequency Range:	29-29.7 MHz 10 Meter Amateur Band 29.7-50 MHz VHF Low Band 50-54 MHz 6 Meter Amateur Band 137-144 MHz Military Land Mobile 144-148 MHz 2 Meter Amateur Band 148-174 MHz VHF High Band Above bands in 5 kHz steps 406-420 MHz Federal Government 420-450 MHz 70 cm Amateur Band 450-470 MHz UHF Standard Band 470-512 MHz UHF-"T" Band 806-956 MHz Public Service Band, Except Cellular Above bands in 12.5 kHz steps
Operating Temperature:	-20°C to +60°C
Scan Rate:	10 to 20 channels per second
Search Rate:	10 to 20 steps per second
Scan Delay:	2 seconds
Audio Output:	18mW nominal into 8Ω internal speaker, 3mW nominal into 32Ω stereo headphone, 8mW nominal into 64Ω supplied earphone.
Power Requirements:	12 VDC using AD70U DC Adapter or 4 AA Alkaline or rechargeable Nickel-Cadmium Batteries
Antenna:	Rubber antenna (included)
External Jacks:	External earphone, DC 12 V power jack
Size:	2 1/2 in. (W) x 1 1/2 in. (D) x 7 in. (H)
Weight:	12 oz.

Features, specifications, and availability of optional accessories are all subject to change without notice.

One Year Limited Warranty

Important: Evidence of original purchase is required for warranty service.

WARRANTOR: Uniden America Corporation ("Uniden")

ELEMENTS OF WARRANTY: Uniden warrants, for one year, to the original retail owner, this Uniden Product to be free from defects in materials and craftsmanship with only the limitations or exclusions set out below.

WARRANTY DURATION: This warranty to the original user shall terminate and be of no further effect 12 months after the date of original retail sale. The warranty is invalid if the Product is (A) damaged or not maintained as reasonable or necessary, (B) modified, altered, or used as part of any conversion kits, subassemblies, or any configurations not sold by Uniden, (C) improperly installed, (D) serviced or repaired by someone other than an authorized Uniden service center for a defect or malfunction covered by this warranty, (E) used in any conjunction with equipment or parts or as part of any system not manufactured by Uniden, or (F) installed or programmed by anyone other than as detailed by the Operating Guide for this product.

STATEMENT OF REMEDY: In the event that the product does not conform to this warranty at any time while this warranty is in effect, warrantor will either, at its option, repair or replace the defective unit and return it to you without charge for parts, service, or any other cost (except shipping and handling) incurred by warrantor or its representatives in connection with the performance of this warranty. Warrantor, at its option, may replace the unit with a new or refurbished unit. THE LIMITED WARRANTY SET FORTH ABOVE IS THE SOLE AND ENTIRE WARRANTY PERTAINING TO THE PRODUCT AND IS IN LIEU OF AND EXCLUDES ALL OTHER WARRANTIES OF ANY NATURE WHATSOEVER, WHETHER EXPRESS, IMPLIED OR ARISING BY OPERATION OF LAW, INCLUDING, BUT NOT LIMITED TO ANY IMPLIED WARRANTIES OF MERCHANTABILITY OR FITNESS FOR A PARTICULAR PURPOSE. THIS WARRANTY DOES NOT COVER OR PROVIDE FOR THE REIMBURSEMENT OR PAYMENT OF INCIDENTAL OR CONSEQUENTIAL DAMAGES. Some states do not allow this exclusion or limitation of incidental or consequential damages so the above limitation or exclusion may not apply to you.

LEGAL REMEDIES: This warranty gives you specific legal rights, and you may also have other rights which vary from state to state. This warranty is void outside the United States of America.

PROCEDURE FOR OBTAINING PERFORMANCE OF WARRANTY:

If, after following the instructions in this Operating Guide you are certain that the Product is defective, pack the Product carefully (preferably in its original packaging). The Product should include all parts and accessories originally packaged with the Product. Include evidence of original purchase and a note describing the defect that has caused you to return it. The Product should be shipped freight prepaid by traceable means to warrantor at:

Uniden America Corporation

Parts and Service
4700 Amon Carter Blvd.
Ft. Worth, TX 76155

Uniden offers 30 days of toll free support and you can call (800)297-1023, 8 a.m. to 5 p.m. Central, Monday through Friday. Beyond that period, you can obtain assistance by calling (900)224-4UAC.

uniden[®]

Beancat

© Uniden America Corporation. All Rights Reserved
Printed in the USA