

BCT8 SCANNER

OWNER'S MANUAL

Uniden®

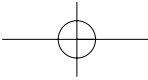

Precautions

Before you use this scanner, please observe the following:

WARNING!

Uniden America Corporation does not represent this unit to be waterproof. To reduce the risk of fire, electrical shock, or damage to the unit, do not expose this unit to rain or moisture.

IMPORTANT!

- This scanning radio has been manufactured so that it will not tune radio frequencies assigned by the FCC for cellular telephone usage. The Electronic Communications Privacy Act of 1986, as amended, makes it a federal crime to intentionally intercept cellular or cordless telephone transmissions or to market this radio when altered to receive them.
- The installation, possession, or use of this scanning radio in a motor vehicle may be prohibited, regulated, or require a permit in certain states, cities, and/or local jurisdictions. Your local law enforcement officials should be able to provide you with information regarding the laws in your community.
- Change or modifications to this product not expressly approved by Uniden, or operation of this product in any way other than as detailed by this Operating Guide, could void your authority to operate this product.
- The screen displays used in this manual are representations of what might appear when you use your scanner.

May be covered under one or more of the following U.S. patent:				
4,627,100	4,841,302	4,888,815	4,932,074	4,947,456
5,014,348	5,199,109	5,408,692	5,428,826	5,438,688
5,448,256	5,465,402	5,471,660	5,483,684	5,530,296
5,548,832	5,551,071	5,574,995	5,577,076	5,598,430
5,600,223	5,642,424	5,710,992	5,896,422	5,991,346
5,991,603	6,012,158	6,025,758	6,034,573	6,064,270
6,266,521				

** U.S. Patent Number 4,841,302 is licensed from Gray Electronics, Inc.

** These products contain Uniden proprietary information. Software, control codes, protocols and other such related matter may be the copyrighted work of Uniden America Corporation.

© Copyright 2002-2003, Uniden America Corporation. All Rights Reserved.

© 2003 Uniden. This product contains Uniden proprietary information.

Software, control codes, protocols and other such related matter may be the copyrighted work of Uniden America Corporation.

Uniden ® is a registered trademark of Uniden America Corporation.

Bearcat ® is a registered trademark of Uniden America Corporation.

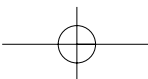

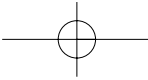

Contents

- Introduction 1
- Front and Rear Views 2
- Icon Display 3
- Terminology 4
 - What are Highway Patrol Alerts? 4
 - What is Scanning? 4
 - What is Searching? 4
 - What is Trunk Tracking? 4
- Feature Highlights 6
- Where to Obtain More Information 7
 - Information on the Internet 7
- Included with Your Scanner Package 8
 - Optional Accessories 8
- Installing the BCT8 9
 - For Home Use (Desktop Installation) 9
 - For Mobile Use (In-Car Installation) 9
 - Typical Mounting Methods 11
 - Mounting the Scanner in Your Vehicle 11
 - Applying Power for Vehicle Installation 12
 - DC power Installation 12
 - Applying Power Using Standard AC Powe 13
 - Connecting an External Speaker 13
 - Listening Safely 13
 - Connecting the Clone Cable 13
- Scanning Overview 14
 - Turn the Scanner On 14
 - How Squelch Works 15
 - Setting the Squelch 15
- Highway Patrol Scanning 16
 - Selecting the State 16
 - Scanning Highway Patrol Frequency 16
 - Highway Patrol Scan Hold 17
 - Highway Warning Alert 17
 - Alert Tone Volume 17
 - Muting the Alert Tone 17
 - Alert Light Adjustment 18
 - Storing Highway Patrol Frequencies 18
 - Skip Frequencies 18
 - Priority Channels 18
 - Trunked Highway Frequency 20
- Private Bank Scanning 21
 - Programming Frequencies into Channels 21
 - Deleting a Stored Frequency 21
 - Duplicate Frequency Alert 22
 - Memory Lock 22
 - Scanning Private Bank 22
 - Hold/Resume 23
 - Channel Lockout 23
 - Restoring a Locked-out Channel in Hold Mode 23
 - Restoring All Locked-out Channels 24
 - Priority Scan 24
 - Changing the Priority Channel 24
- Service Scanning 25
- Band Search 26
 - Setting a Search Band 26
 - Search Hold Feature 27
 - Data Skip 27
 - Frequency Skip 27
 - Storing Search Frequencies 28
 - Delay 28

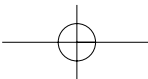

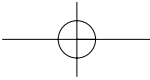

- Trunk Tracking 29
 - Setting the Squelch 29
- Programming Trunking Frequencies 30
 - STEP 1: Selecting Trunking System Type 30
 - STEP 2: Programming Trunking Frequencies 31
- Programming Talk Group ID/Scan Lists 31
 - Scan Lists 31
- Receiving Trunked Systems 33
 - ID Scan Mode 33
 - ID Scan Hold Feature 34
 - ID Search Mode 34
 - ID Monitor Mode 35
 - ID Search Hold and Direct Entry ID in Hold Mode 35
 - Programming Scan Lists During Search 35
 - Deleting a Stored ID 35
 - ID Lockout 36
 - Review ID Lockout 36
 - Restoring Locked-out IDs 36
 - Setting the Delay Mode for Trunking Mode 37
 - Trunking Frequency Confirmation 37
 - Setting Priority in Trunking Mode 37
 - Moving between Scan List Memories 37
 - Multi-Track 38
- EDACS® Reception 39
 - EDACS® Tracking 39
 - Programming EDACS System Frequencies 39
 - An EDACS® Trunked system 40
 - Special EDACS® Features 41
 - EDACS ID Range Search 41
 - EDACS SCAT 41
- LTR® Reception 42
 - LTR® Tracking 42
- Motorola Reception 43
 - Motorola Tracking 43
 - Fleet Map Programming 44
 - Selecting Preset Fleet Map 44
 - Programming a User Fleet Map 44
 - Programming a Hybrid System 45
 - Setting the Base, Spacing Frequencies and Offset Channel for Motorola VHF/UHF Trunked Systems 45
 - Toggling the Status Bit 46
 - Control Channel Only Mode 46
 - Disconnect Tone Detect Option (End Code) 47
- Remote Interface 48
 - PC Control Mode 48
 - Clone Mode 49
- Care and Maintenance 52
- Troubleshooting 53
- Specifications 55
- Appendix 56
- One Year Limited Warranty 61

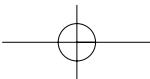
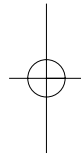
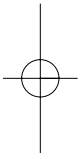

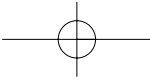

Introduction

The BCT8 is a state-of-the-art Trunk Tracking Scanner with BearTracker technology which will alert you when the highway patrol is within approximately a 3 mile radius. It can store 250 frequencies such as police, fire/emergency, marine, railroad, air, amateur, and other communications into 5 banks of 50 channels for a total of 250 channels.

Use your new scanner to monitor:

- Highway Patrol
- Local Police and Country Sheriffs
- Trunking for:
 - Motorola
 - Type I
 - Type II
 - Type II: (Hybrid)
 - EDACS
 - Wide band
 - Scat
 - LTR
- Business/Industrial Radio
- Utilities
- Marine Band
- Aircraft Band
- And much more...

The chart below identifies the scanner band numbers, the frequency range, the modulation mode and the default step size settings.

Band No.	Range (MHz)	Mode	Step	Transmission
1	25.0000 - 27.9950	AM	5kHz	Citizens Band
2	28.0000 - 29.9950	FM	5kHz	10 Meter Amateur Band
3	30.0000 - 49.9950	FM	5kHz	VHF Low Band
4	50.0000 - 54.0000	FM	5kHz	6 Meter Amateur Band
5	108.0000 - 136.9875	AM	12.5kHz	AM Aircraft
6	137.0000 - 143.9950	FM	5kHz	Military Land Mobile
7	144.0000 - 147.9950	FM	5kHz	2 Meter Amateur Band
8	148.0000 - 174.0000	FM	5kHz	VHF High Band
9	400.0000 - 419.9875	FM	12.5kHz	Federal Govt. Land Mobile
10	420.0000 - 449.9875	FM	12.5kHz	70 cm Amateur Band
11	450.0000 - 469.9875	FM	12.5kHz	UHF Standard Band
12	470.0000 - 512.0000	FM	12.5kHz	UHF "T" Band
13	806.0000 - 826.9875	FM	12.5kHz	Public Service Band
	849.0125 - 868.9875			
	894.0125 - 956.0000			

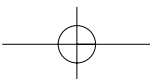

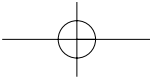

Front and Rear Views

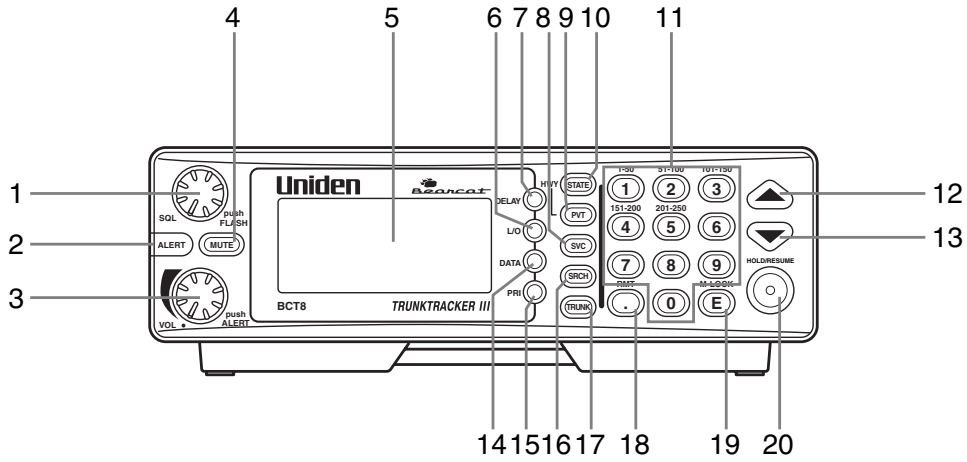

- | | |
|--|---|
| <ul style="list-style-type: none"> 1. Squelch Control / Flash Brightness Selector (SQL, FLASH) 2. Alerting Light (ALERT) 3. Volume Control / Alert Tone Selector (VOL) 4. Mute Key (MUTE) 5. Display 6. Lockout Key (L/O) 7. Delay Key (DELAY) 8. Service Key (SVC) 9. Private / Highway Scanning Key (PVT/HWY) | <ul style="list-style-type: none"> 10. State Key (STATE) 11. Numeric Keypad 12. Up Key (▲) 13. Down Key (▼) 14. Data Key (DATA) 15. Priority Key (PRI) 16. Search Key (SRCH) 17. Trunk Key (TRUNK) 18. Decimal/Remote Key (⊙, RMT) 19. Enter / Memory Lock Key (E, M-LOCK) 20. Hold/Resume Key (HOLD/RESUME) |
|--|---|

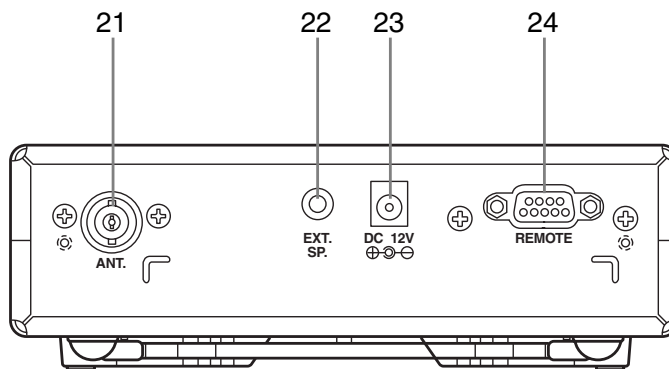

- | | |
|--|--|
| <ul style="list-style-type: none"> 21. Antenna Connector (ANT.) 22. External Speaker Jack (EXT. SP.) | <ul style="list-style-type: none"> 23. DC Power Jack (DC 12V) 24. Remote Control Terminal (REMOTE) |
|--|--|

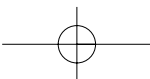

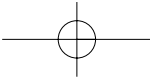

Icon Display

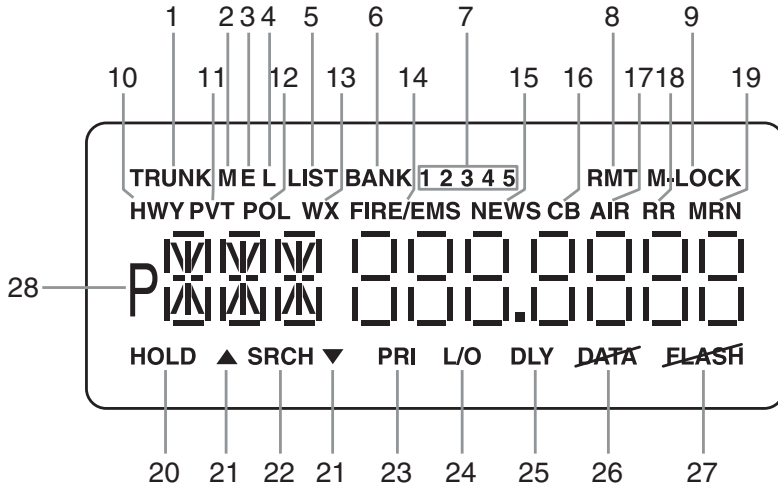

- | | |
|---|--|
| <ol style="list-style-type: none"> 1. Trunk Tracking mode (TRUNK) 2. Motorola trunking channel (M) 3. EDACS trunking channel (E) 4. LTR trunking channel (L) 5. Scan list (LIST) 6. Scan bank (BANK) 7. Bank's number and ID's list number (12345) 8. Remote control mode (RMT) 9. Memory locked (M-LOCK) 10. Highway Patrol scan mode (HWY) 11. Private bank scan mode (PVT) 12. Police scan mode (POL) 13. Weather scan mode (WX) 14. Fire and Emergency scan mode (FIRE/EMS) | <ol style="list-style-type: none"> 15. News scan mode (NEWS) 16. Citizen Band scan mode (CB) 17. Aircraft band scan mode (AIR) 18. Railroad scan mode (RR) 19. Marine scan mode (MRN) 20. Scan hold and Search hold mode (HOLD) 21. Search direction (▲, ▼) 22. Band and ID search mode (SRCH) 23. Priority function option (PRL) 24. Lockout channel and talk group (L/O) 25. Delay option (DLY) 26. DATA Skip option (DATA) 27. While Alert Light is off (FLASH) 28. Priority channel and talk group (P) |
|---|--|

Uniden®, BearTracker® and Bearcat® are registered trademarks of Uniden America Corporation.

TrunkTracker is a proprietary trademark of Uniden America Corporation.

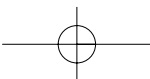

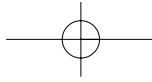

Terminology

What are Highway Patrol Alerts?

Most highway patrol vehicles on the road today are equipped with a secondary radio system known as a “mobile extender” or “vehicular repeater.” Whenever the dispatcher transmits to any vehicle in the district, “mobile extender” in every car within the district is activated.

Using a constant PRIORITY check of specific frequencies in each state, the BCT8 recognizes and alerts you to transmissions from “mobile extender” radios as well as from car-to-car, aircraft-to-car and other special-purpose frequencies. You receive an audible (beep tone) and visual (flashing Alert light) alert whenever you are within an approximate three-mile radius of Highway Patrol/ State Police units using a mobile extender unit.

What is Scanning?

Unlike standard AM or FM radio stations, most two-way communications do not transmit continuously. The BCT8 scans the Frequencies you have programmed into the Scanner’s channels until it finds an active frequency.

Scanning stops on an active frequency and remains on that channel as long as the transmission continues. When the transmission ends, the scanning cycle resumes until another transmission is received.

What is Searching?

The BCT8 can search each of its 13 bands to find active frequencies. This is different from scanning because you are searching for frequencies that have not been programmed into your Scanner’s channels. The scanner automatically chooses between two speeds while searching. During search mode the scanner will search 100 frequencies per second for band with 12.5 kHz steps and during Turbo SEARCH mode the scanner can achieve up to 300 frequencies per second for bands with 5 kHz steps.

What is Trunk Tracking?

Conventional scanning is a simple concept. You enter a radio frequency in your scanner’s memory which is used by someone you want to monitor. For example, the police in your area may broadcast on 460.500 MHz, the fire department on 154.445 MHz, the highway department on 37.900 MHz, etc. So when your scanner stops on a frequency, you usually know who it is, and more importantly, you can stop on a channel and listen to an entire conversation. This type of scanning is easy and fun.

As the demand for public communications has increased, many public radio users don't have enough frequencies to meet their needs, and this has created a serious problem. Trunking radio systems have been implemented to solve this problem.

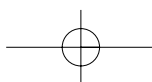

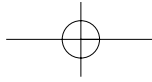

In a trunked radio system the frequencies are shared among the police and fire departments and a computer systematically assigns available frequencies when they are needed for communications.

Sharing of the available public service frequencies, or trunking, allows cities, counties, or other agencies to accommodate hundreds of users with relatively few frequencies. Following a conversation on a trunked system using a scanner is difficult, if not impossible. Because when there's a short break during the conversation you're monitoring, it's possible that the talkgroup will be assigned to a completely different frequency in the trunked system. This type of scanning is difficult and frustrating.

TrunkTracker Technology changes this! Not only does your new BCT8 scan channels like a conventional scanner, it actually follows the users of a trunked radio system. Once you know a talkgroups ID, you won't miss any of the action.

If you're a new scanner enthusiast, you may want to read the first part of this manual and use your scanner in conventional mode before you begin trunk tracking. Understanding scanning fundamentals and its terminology will make trunk tracking much easier.

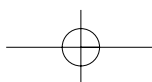
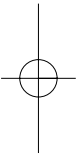
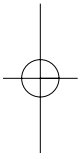

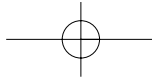

Feature Highlights

- Pre-programmed frequencies specific to each state (except Hawaii).
- Pre-programmed Trunked and conventional Highway Patrol frequencies
- Highway Patrol Priority Alert
 - Receive audible and visual alert when within three miles of many Highway Patrol/State units
- Pre-programmed frequencies for the following categories:
 - Local Police and County Sheriffs
 - Fire and Emergency Medical Service
 - News Media
 - Weather (continuous NOAA weather and Canadian Coast Guard broadcasts)
 - CB Radio
 - Aircraft
 - Railroads
 - Marine Band
 - Department of Transportation
- **Trunk Tracking** – Follow VHF High Band UHF 800MHz trunked public safety and public service systems just as if conventional two-way communications were used.
- **Multi-Track** – Track more than one trunking system at a time. Scan conventional and trunked systems at the same time.
- **250 Channels** – Program one frequency into each channel. You must have at least one channel programmed to use the Scan mode.
- **13 Bands** – Includes 13 bands, with aircraft and 800 MHz.
- **5 Banks** – 5 banks with 50 channels each are useful for storing similar frequencies to maintain faster scanning cycles or for storing all the frequencies of a trunked system.
- **25 MHz-956 MHz** – Indicates the range of frequencies that can be searched within the bands of your scanner.
 - Note:** The frequency coverage is not continuous and excludes the cellular telephone Band.
- **5 Priority Channels** – You can assign one priority channel in each bank. Assigning a priority channel allows you to track activity on your most important channel(s) while monitoring other channels for transmissions. You can also assign trunking priority talkgroups.
- **Data Skip** – Allows your scanner to skip unwanted data transmissions and reduces birdies.
- **Direct Channel Access** – Go directly to any channel without entering programming mode.
- **Turbo Search** – Increases the search speed to 300 steps per second. This applies only to transmission bands with 5 kHz steps.
- **PC Programmable** – Allows you to easily program all frequencies and Trunking Talk Groups into your BCT8 through Uniden BCT8 Scanning software running on your PC.
 - For more information on BCT8 SS Programming software visit our website at scanner.uniden.com.

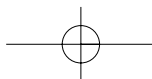

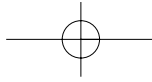

Where to Obtain More Information

Before you can scan the PRIVATE bank, you must program frequencies into the scanner's channels. The Frequency Guide lists typical frequencies used around the U.S.A. and Canada that you may program into your new scanner. However, this is not a complete list of frequencies for your area.

To obtain frequency information for your area, contact one of the following:

- Scanner Master

1 (800) Scanner (7226634) (Hours are from 10:00 a.m. to 5:00 p.m. Eastern Time Monday through Friday.) frequenciew@scannermaster.co

To obtain another copy of the frequency guide, contact one of the following:

- Uniden Parts Department
(800) 554-3988 (Hours are from 8:00 a.m. to 5:00 p.m. Central Time Monday through Friday.)
- Local Dealer

Information on the Internet

If you have access to the internet, you may want to visit one of the following websites for additional information:

scanner.uniden.com
www.bearcat1.com

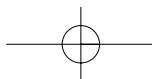

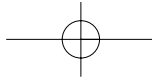

Included with Your Scanner Package

- BCT8 Scanner
- AC Adapter (AD 140U)
- DC Power Cord
- Cigarette Lighter Adapter Plug (Model CD007)
- Telescopic Antenna (Model AT129)
- Window Mount Antenna (Model AT002)
- Operating Guide
- Trunk Tracker Frequency Guide
- Other Printed Materials

If any of these items are missing or damaged, immediately contact your place of purchase or Uniden Customer Service at: (800) 297-1023, 8:00 a.m. to 5:00 p.m., Central Time, Monday through Friday.

Optional Accessories

The following optional accessories for your BCT8 are available from your local Uniden Dealer or through the Uniden Parts Department by calling: (800) 554-3988, 8:00 AM to 5:00 PM CST, Monday through Friday. We can also be reached on the web at www.uniden.com.

Mobile Mounting Bracket (Model MB-007) - For mobile use (in-car installation), use it to install the BCT8 in your car.

DC Power Cord (Model PS-001) - For hard wiring power from your car to your scanner.

Motorola Antenna Adapter (Model PLG-134) - Use only if your antenna has a Motorola-type plug.

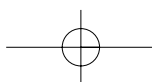

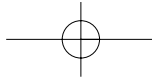

Installing the BCT8

For Home Use (Desktop Installation)

1. Insert the DC plug end of the AC Adapter into the DC 12V jack on the rear panel.
2. Plug the AC Adapter into a standard 120V AC wall outlet.
3. Plug the Telescoping Antenna into the ANT connector.
Extend the antenna to its full height. For frequencies higher than 406 MHz, shortening the antenna may improve the reception.
4. Use the desktop stand for a better viewing and operating angle.

Helpful Hints

- If strong interference or electrical noise is received, relocate the scanner or its antenna away from the source.
- If you are operating the scanner in a fringe area or need to improve reception, use an optional antenna designed for multi-band coverage. (You can purchase this type of antenna at a local electronics store.)
- If the optional antenna has no cable, use 50-70 ohm coaxial cable for lead-in. A mating plug may be necessary for the optional antennas.

For Mobile Use (In-Car Installation)

Mounting the Radio for every day use

Installation for Temporary Use:

A Cigarette Lighter Power Cord is provided for easy, temporary installation.

Warning: Do not use the cigarette lighter power cord in a positive ground vehicle.

Plug one end of the Cigarette Lighter Power Cord into the cigarette lighter jack and the other end into the DC 12V jack on the back of the scanner.

Connecting the Antenna Plug

Connect the mobile antenna plug into the ANT connector on the rear panel. (For more information on antenna installation, please refer to the instruction guide that came with your antenna.)

The BCT8 can be mounted using the mounting bracket (optional).

This bracket is available from the Uniden parts department (see page 8)

1. Select an ideal location in your vehicle to mount the BCT8. Avoid a location that could interfere with your driving. In a passenger car, the ideal location is underneath the dashboard on the passenger side.
2. Use the mounting bracket (optional) as a template for marking the location of the mounting screws. Note: If there are screws already holding the dashboard, you can use the same screw holes to mount the bracket.

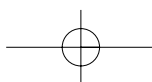

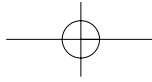

3. Drill the necessary holes and secure the mounting bracket in place using the screws provided.
4. Mount the radio to the bracket only after the wiring has been connected to the rear panel.

Connecting the Power Cord

Note: If you are not experienced in connecting accessories to the vehicle fuse box, please see your automotive dealer for advice on proper installation.

Installation for everyday use:

1. Check the vehicle battery connections to determine which battery terminal (positive or negative) is grounded to the engine block or chassis. Most of today's vehicles use a negative ground. If your vehicle has a negative ground, follow Steps 2 and 3. Otherwise, skip to the note following Step 3.
2. Connect the RED wire of the DC power cord to the accessory contact in your vehicle's +12V DC fuse box.
3. Connect the BLACK wire of the DC power cord to the negative side of the vehicle (usually the chassis).

Note: In vehicles with a positive ground, the RED wire connects to the chassis and the BLACK wire connects to the accessory contact in the fuse box.

4. Insert the DC plug into the DC 12V jack on the back of the scanner.

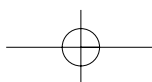
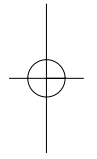
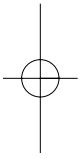

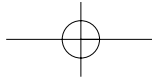

Typical Mounting Methods

The BCT8 can be conveniently mounted on a table, bulkhead, overhead, or any other desired location with the optional mounting Bracket (MB007) (refer to figure below for typical mounting methods).

Caution: Make sure there are no hidden electrical wires or other items behind the desired location before proceeding. Check that free access for mounting and cabling is available.

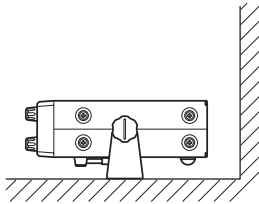

• Table top mount

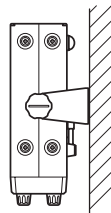

• Bulkhead mount

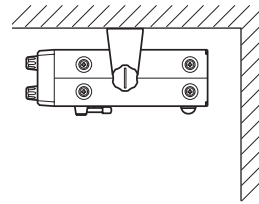

• Overhead mount

Mounting the Scanner in Your Vehicle

Before you mount the scanner, make sure you have all the necessary materials. Then confirm that the scanner fits your vehicle's mounting area. This unit requires a mounting area of 2.44 inch high by 7.06 inch wide by 6.10 inch deep (50.8 x 176.5 x 152.5 mm).

Caution: Be sure to avoid obstructions behind the mounting surface.

Follow these steps to mount the scanner in your vehicle.

1. Choose a mounting location, then use the supplied mounting bracket as a template to mark the positions for the mounting screw holes.
2. In the marked positions, drill holes slightly smaller than the supplied screws.
3. Attach the mounting bracket to the mounting location using the supplied screws and lock washers.
4. Attach the scanner to the mounting bracket using the supplied mounting knobs.
5. Connect the antenna's cable to the **ANT.** connector on the rear of the scanner.

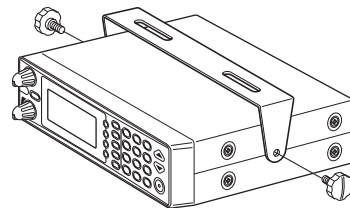
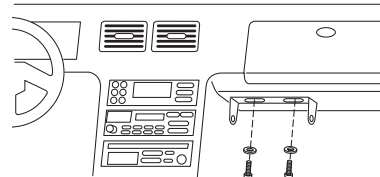

Note: If the antenna cable's connector does not fit in the **ANT.** connector, you might also need a Motorola-to BNC antenna plug adapter (available at a local electronics store).

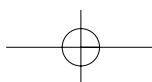
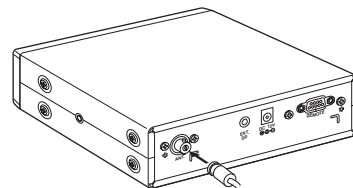

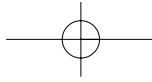

Applying Power for Vehicle Installation

You can power your scanner using the supplied DC cigarette lighter power cord or an DC power cord.

DC power Installation

To power the scanner from a vehicle's 12V power source (such as a cigarette-lighter socket), you need a cigarette-lighter adapter.

To connect an DC cigarette-lighter power cable, insert its barrel plug into the **DC 12V** jack on the rear of the scanner, then plug the power cable into your vehicle's cigarette lighter socket.

Note : If you use a cigarette-lighter power cable and your vehicle's engine is running, you might hear electrical noise from the engine while scanning. This is normal.

Caution: DC 12 V Jack can use a power source that supplies 12V DC at least 500 mA. You must use a power source that supplies 12V DC and delivers at least 500 mA. Your standard 12V car battery should be sufficient. The cord connector's center tip must be set to positive and its plug must fit the scanner's **DC 12V** jack. The supplied DC power cord meets these specifications. Using a power cord that does not meet these specifications could damage the scanner or the adapter.

- Always connect the adapter or DC power cord to the scanner before you connect it to the power source. When you finish, disconnect the adapter or DC power cord from the power source before you disconnect it from the scanner.
- For added safety and to protect your scanner, disconnect the cable from your vehicle battery's negative (-) terminal before you begin.

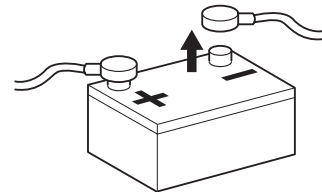

Follow these steps to connect the DC power cord.

1. Connect the power cord's black wire to a chassis ground, such as a metal screw attached to a metal part of the vehicle's frame. Be sure that the screw is not insulated from the frame by a plastic part.
2. Connect the power cord's red wire (with in-line fuse) to a source of voltage that turns on and off with the ignition switch, such as a spare accessory terminal in your vehicle's fuse box.
3. Insert the power cord's barrel plug into the **DC 12V** jack on the rear of the scanner.
4. Reconnect the cable to the vehicle battery's negative (-) terminal.

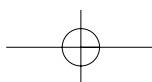
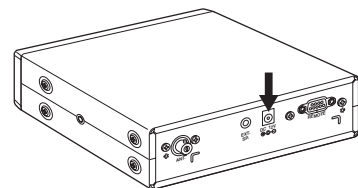
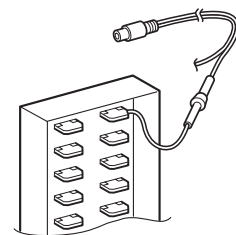

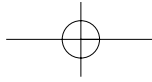

Applying Power Using Standard AC Power

To power the scanner from an AC outlet, use the provided AC adapter with a 5.5 mm outer diameter/2.1mm inner diameter tip.

Caution: You must use a Class 2 power source that supplies 12V DC and delivers at least 500 mA. The cord connector's center tip must be set to positive and its plug must fit the scanner's **DC 12V** jack. Using an adapter that does not meet these specifications could damage the scanner or the adapter.

- Always connect the AC adapter to the scanner before you connect it to AC power. When you finish, disconnect the adapter from the AC power before you disconnect it from the scanner.

1. Insert the adapter's barrel plug into the **DC 12V** jack on the rear of the scanner.
2. Plug the adapter into a standard AC outlet.

Note: Use only the AC adapter supplied with your scanner.

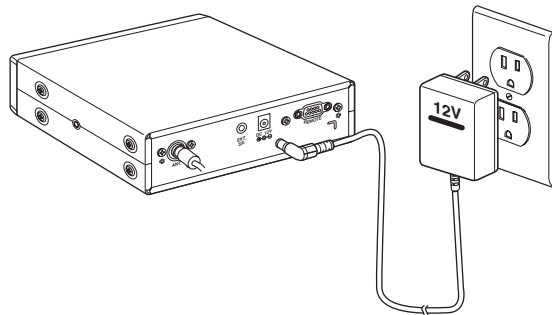

Connecting an External Speaker

In a noisy area, an external speaker (available at a local electronics store) positioned in the right place might provide more comfortable listening.

Plug the speaker cable's 1/8 inch (3.5 mm) plug into your scanner's **EXT. SP.** jack.

Note: Connecting an external speaker disconnects the scanner's internal speaker.

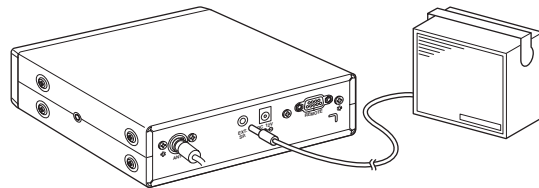

Listening Safely

- **Do not use the earphone. The volume is not adjustable for the Warning Alert and damage to your hearing could occur.**

Connecting the Clone Cable

You can transfer the programmed data to and from another BCT8 scanner using a RS232C Straight Cable (9 pin to 9 pin) (not supplied). Connect the cable between each scanner's **REMOTE** jacks. See "Clone Mode" on page 49. You can also upload or download the programmed data to or from a PC using optional programming software available through your local electronics store.

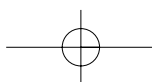

Scanning Overview

You can scan in one of three ways:

1. **Highway Patrol Scanning** After selecting a state to scan, press **PVT/HWY** to activate Highway Patrol Scanning. You can scan pre-programmed Highway Patrol frequencies.
2. **Service Scanning** Press **SVC** to select one of the nine services to find an active frequency.
3. **Band Search** Select a frequency band to search. The Search function is different from scanning. It searches for any active frequency step by step within the lower and upper limits of the band. When an active frequency is found, the scanner will stop and stay on that frequency as long as that transmission lasts. If that frequency is interesting to you, press **HOLD/RESUME** to hold the frequency on the display. Then program it into the private bank you want to store. If you do not want to program that frequency, press **HOLD/RESUME** or just wait until the transmission ends. The search resumes automatically 2 seconds after the last transmission and looks for more active frequencies.
4. **Private Scanning** If you have programmed frequencies into this bank, press **PVT/HWY** to scan only those that you have programmed in this bank.

Note: Before you can scan the Private Bank, you must program frequencies into the channels. To program frequencies, see “Programming Frequencies into Channels” on page 21.

When scanning stops on an active frequency, it remains on that channel as long as the transmission continues. When the transmission ends, the scanner will remain on the same channel for 2 more seconds, waiting for a responding transmission. If there is no responding transmission within 2 seconds, the scanning cycle resumes.

Turn the Scanner On

1. Turn the **VOL** knob clockwise.

The scanner is turned on: the Alert Light flashes and the Alert Tone beeps loudly.

Note: The Alert Tone depends on the currently setting selected (see page 17).

2. The last setting mode selected before starts.

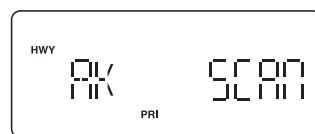
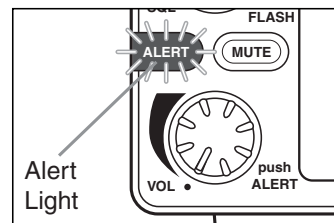
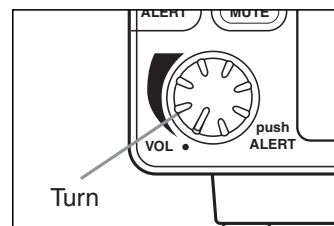

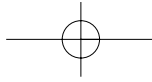

How Squelch Works

Think of “SQUELCH” as a gate. If the gate is too low (squelch too low), everything (all noise as well as signals) gets through.

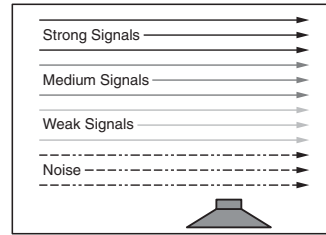

If the gate is set too high (squelch too high), nothing gets through.

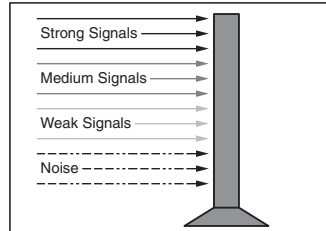

If the gate is set just right (squelch set properly), just the desired signals get through.

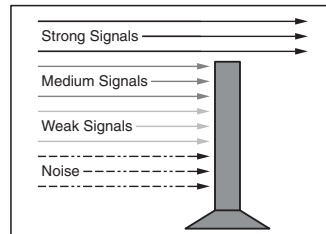

Setting the Squelch

1. To set the squelch, press **HOLD/RESUME** to stop scanning. If needed, adjust **VOL** until you **do not** hear a signal (see page 17).
2. Turn **SQL** fully clockwise until hiss heard. This lowers the “squelch gate,” allowing all signals and noise to get through.
3. Turn **SQL** fully counterclockwise just until hiss stops. This raises the “squelch gate,” allowing only strong signals to get through.



In the city, you may want to adjust the Squelch even further counterclockwise to decrease the range of the Highway Warning Alert signal.

This prevents the alert from sounding unnecessarily due to farther, less important sources.

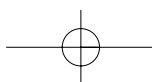
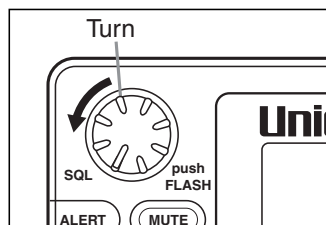
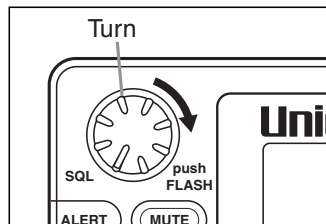

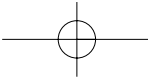

Highway Patrol Scanning

Highway Patrol frequencies are pre-programmed on a U.S. state-by-state. While Highway Patrol scanning, Highway Warning Alert will be activated.

Selecting the State

1. Press **STATE** to select the state you are operating in.
Press and hold **STATE** to scroll rapidly.

Hint: For the State Cord Order, please see page 56.

2. To step forward through the states (A - W), press **STATE** and, within three seconds, press the **▲** key repeatedly. To step backward through the states (W - A), press **STATE** and, within three seconds, press the **▼** key repeatedly.
3. To scroll rapidly, press and hold the **▲** or **▼** key.

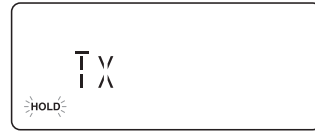

Scanning Highway Patrol Frequency

You can scan Highway Patrol frequencies and/or User-programmed Channels by pressing **PVT/HWY**.

1. Press **PVT/HWY** repeatedly until "**HWY**" appears on the display to scan through pre-programmed Highway Patrol frequencies.

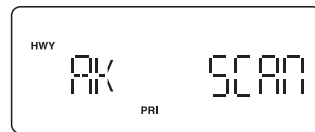

2. Press **PVT/HWY** repeatedly until "**PVT**" appears on the display to scan through User-programmed channels. The bank indicators selected flash on the display as User Programmed channels are scanned (Refer to "Private Bank Scanning" on page 21).

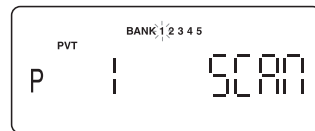

Note: You must program a frequency into at least one channel before the Private bank scanning.

3. Press **PVT/HWY** repeatedly until "**HWY**" and "**PVT**" appears on the display to scan through Highway Patrol frequencies and User Programmed channels continuously.



Note: Priority Scanning is disabled. When both "**HWY**" and "**PVT**" are in operation. "**PRI**" will remain on the display.

4. When the scanner receives communications, scanning stops, the state code and the frequency displays.

When the transmission ends, the scanner holds for two seconds on that frequency for a response. For more information on Delay feature, please see page 28. If there is no response, scanning resumes.

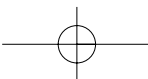
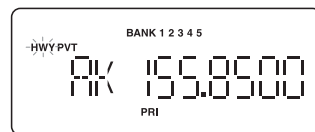

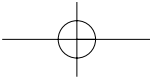

Highway Patrol Scan Hold

- When scanning stops on a desired frequency, press **HOLD/RESUME** to hold on that frequency as long as you like. When in the HOLD mode, press the ▲ or ▼ key to step up or down the frequency. To step up or down rapidly, press and hold the ▲ or ▼ key.

If you change into a frequency which is a control channel, the scanner may display the Active ID (When TRUNK mode is active).

- To resume scanning, press **HOLD/RESUME**.

Note: Highway Warning Alert does not work while in the HOLD mode.

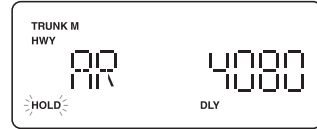
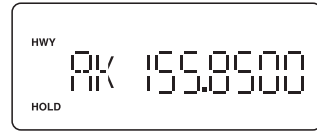

Highway Warning Alert

The scanner alerts you when Highway Patrol/State Police units using mobile extenders are within an approximate three mile radius.

- The ALERT Light flashes and the Alert Tone beeps twice when a signal is received.
- The ALERT Light glows steadily for approximately three minutes. Then, if no other mobile extender transmissions are received, the light goes out.
- If more transmissions are received before three minutes have passed, the ALERT Light flashes and the Alert Tone beeps once.

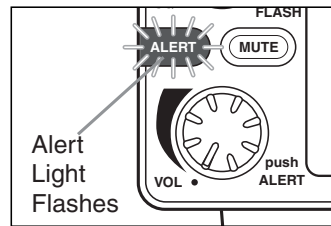

Alert Tone Volume

Push **VOL** to select Loud, Medium, or Soft.

The Alert Tone beeps and the ALERT Light flashes to your choice.

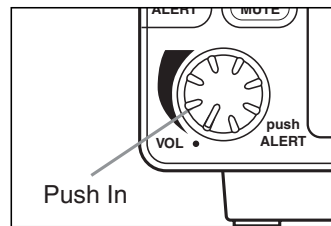

Muting the Alert Tone

Temporary Mute

Press **MUTE** during the Highway Warning Alert. The Alert Tone stops and the MUTE LED flashes until the alarm cycle (three minutes) is finished.

Continuous Mute

Press and hold **MUTE** for two seconds to turn Continuous Mute on whenever you wish. You hear two beeps and the MUTE LED lights continuously. No Alert Tones will beep.

Canceling Mute

To cancel Mute,

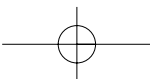
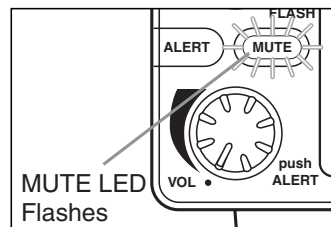

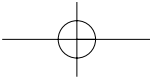

- Press **MUTE** to cancel One Moment Mute.
- Press and hold **MUTE** for two seconds to cancel Continuous Mute. You hear two beeps and the MUTE LED goes out.
- Change states. The MUTE LED goes out after scanning starts.
- Turn the scanner off and on.

Note: If **MUTE** is pressed for less than 2 seconds during the Continuous Mute mode, nothing will be changed.

Alert Light Adjustment

The ALERT Light has three settings: Bright, Dim, and Off.

Push **FLASH** to select Bright, Dim or Off. The ALERT Light flashes and the Alert Tone beeps.

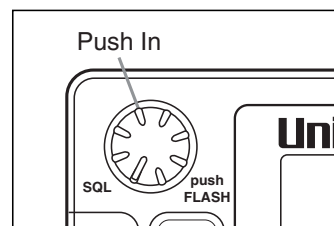

If you select Off, "~~FLASH~~" on the display reminds you the ALERT Light is off.

WARNING: You can turn off the ALERT Light and completely mute the Alert Tone at the same time.
This deactivates the Highway Warning Alert.

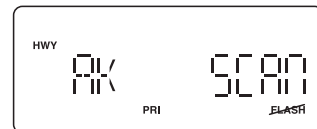

Storing Highway Patrol Frequencies

You can quickly store any frequency you find during scanning. When in Hold mode or the scanner stops on the frequency you want to store, you can store the frequency. For detail see page 21.

Skip Frequencies

To skip a frequency, press **L/O**.

You can program up to 50 skip frequencies for priority channels. And also you can program up to 100 skip frequencies for other frequencies (See page 27). If you skip a preprogrammed frequency in one state and that frequency is programmed into another state, the frequency is skipped of both states. If you change the state code, skipped frequencies are cancelled as soon as scanning starts.

Priority Channels

Each state preprogrammed in the **scanner** contains a number of Priority channels. The **scanner** automatically checks a state's Priority channels every two seconds for activity. If there is activity on one of the Priority channels, the ALERT Light will flash and the alarm tone will beep (see "Highway Warning Alert," page 17).

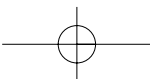

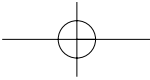

You will experience a slight in the conversations you hear as the **scanner** checks the Priority channels. You can cancel the priority check and the interruptions in the conversations by pressing **HOLD/RESUME** to hold on the frequency.

Note: The Highway Warning Alert is inoperative while the scanner is on Hold.

Remember to press **HOLD/RESUME** to return to normal priority-scan operation.

Priority channel cannot be changed, but you can lock-out priority channels using **L/O**. Priority channels have been pre-determined by the manufacturer as those Highway Patrol frequencies most commonly used for mobile extenders and for car-to-car and aircraft-to-car operations. Mobile extenders re-transmit every radio broadcast received on the patrol car radio to the officer's walkie-talkie at low-power. Every time any officer or dispatcher talks (transmits), the signal is broadcast like a beacon at low-power whether or not the officer is out of the car.

You can select Priority Scanning mode by pressing **PRI**.

- Normal Priority Scan mode.

The scanner checks the Priority frequency every two seconds. "**PRI**" will be displayed.

- Priority only mode.

When no sound is heard for long interval in Priority Scanning mode, Priority only mode is effective. Especially for the following states, this mode is recommended.

- | | |
|---------------|----------------|
| AR (Arizona) | MI (Michigan) |
| DE (Delaware) | OK (Oklahoma) |
| FL (Florida) | WI (Wisconsin) |

The scanner checks only Priority Alert frequency "**PRI**" will flash.

- Priority off mode

The scanner does not check the Priority frequency. "**PRI**" will not displayed.

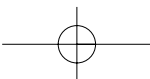

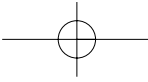

Trunked Highway Frequency

Trunked Highway frequencies are pre-programmed on a U.S. state-by-state. When the scanner finds the control channel data, the scanner begins to find any active IDs. If the scanner finds any ID, the active ID appears on the display and you will hear it.



If you press the ▲ key while monitoring on ID, the scanner will check if any other IDs are active and if none are active, the scanning resumes.

When the scanner finds the control channel, it will check if any other IDs are active on the control channel until the control channel is lost. If you don't want the first pre-programmed trunking control channel that the scanner receives, press **DATA** to move to the next control channel.

Press the ▼ key while a talk group ID is active, and the frequency on which talk group is transmitting flashes on the display.

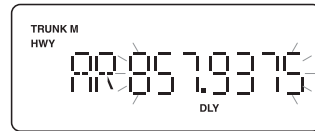

Or press and hold the ▼ for two seconds, and the ID and the frequency alternately appears on the display. To return normal display, press the ▼ key again.

Like conventional scanning, you can lockout reception of unwanted traffic.

You can lockout up to 30 IDs. Press **L/O** on the ID you want to lockout.

If you lockout 31st ID, the 1st ID already lockouted is restored.

If you want to restore all the lockout IDs, pres and hold **L/O** for two seconds.

Or when the state code is changed, all lockout IDs are restored as soon as scanning starts.

If you find an interesting ID you want to continue listening to, press **HOLD/RESUME**.



Press **HOLD/RESUME** to resume scanning.

And also you can set the scanner to hold on an ID for two seconds to wait for a replay before the scanning resumes. While trunking, press **DELAY** and "DLY" appears on the display.

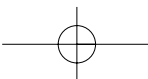

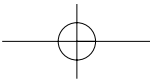

Private Bank Scanning

Programming Frequencies into Channels

Before the scanner begins Private Bank scanning, you must program a frequency into at least one channel. Program frequencies you purchased from your dealer, from various free and FCC-based sources on the internet, or from the Frequency guide included in BCT8 package. You will need to program each frequency into the scanner's channels in order to hear these frequencies.

1. While Private Bank scanning is activated, press **HOLD/RESUME** and enter the channel number where you want to store a frequency by using the keypad, then press **HOLD/RESUME**.

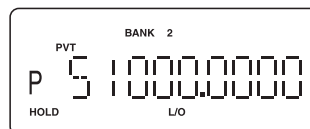

2. Change the channel by using the ▲ or ▼ key.

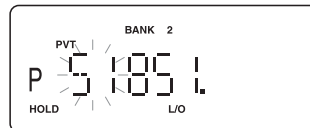

2. Enter the frequency you want to store by using the keypad and . (decimal key).

3. Press **E** to store the frequency into the channel.
4. If you want to program another frequencies into the channel, select another channel by using the ▲ or ▼ key.



- Note:**
- To clear a mistake while entering the frequency, press . (decimal key) repeatedly until the display is cleared.
 - If you enter a invalid frequency, an error tone will sound and **ERROR** appears on the display. To clear the Error message immediately, press . (decimal key).
 - Even if you don't enter full numbers as a frequency number, the scanner will automatically select the nearest valid frequency.

Deleting a Stored Frequency

To delete a stored frequency:

- a. Select a channel.
- b. Press **0**.
- c. Then press **E**.

Note: Channels with no frequencies are automatically locked out.

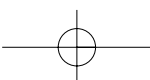

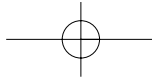

Duplicate Frequency Alert

If you enter a frequency which has been stored in another channel, you will hear an error tone and the other channel displays.

Press **⊙** (decimal key) to clear and start again.

— OR —

Press **E** again to store the frequency in both channels.

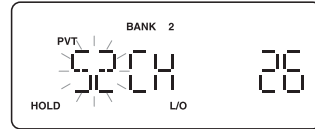

Note: The smallest channel appears on the display when you store same frequency in two or more channels.

Memory Lock

To avoid the accidental programming frequencies and talk group IDs, you can lock the memory with Memory Lock.

Press and hold **M-LOCK** for 2 seconds to activate this feature ,and “**M-LOCK**” appears on the display. If you press **E** to program memory, you will hear two beeps. To deactivate Memory Lock, press and hold **M-LOCK** for 2 seconds again.

Scanning Private Bank

1. After programming frequencies, simply press **HOLD/RESUME** to begin scanning. Or pressing **PRV/HWY** repeatedly until “**PVT**” appears on the display, you can start Private Bank Scanning. The scanner scans only upward all the channels.

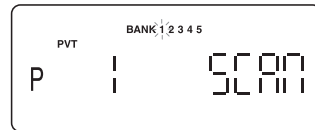

2. The bank indicators selected for scanning appear on the display, and the bank being currently monitored flashes. You can deselect banks from active scanning by entering their numbers on your keypad. The indicator for each deselected bank disappears, and the bank’s channels are not scanned.

Note: One bank must always be active. You cannot deactivate all five banks at the same time. If you try to deselect all the banks, the first bank is automatically selected.

To restore a bank to active scanning, enter the bank’s number on your keypad. The bank’s indicator will display again.

3. During normal scanning the scanner skips unprogrammed or locked out channels.
4. When a transmission is received, the scanner stops on that channel. When the transmission ends, scanning resumes automatically.

Note: You can set the scanner to hold for two seconds on the frequency for a response. For more information on Delay feature, please see page 28.

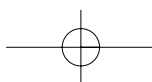
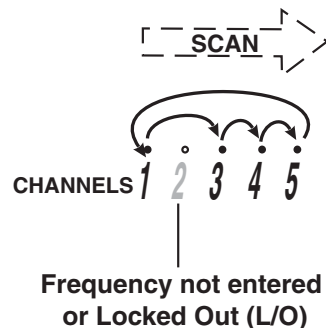

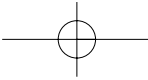

Hold/Resume

If you want to stop on a channel during scanning, press **HOLD/RESUME**.

If you want to resume scanning, press **HOLD/RESUME**.

Direct channel access:

There are several ways to access a specific channel quickly.

1. Press **HOLD/RESUME**.
2. Using the keypad, enter the channel number.
3. Press **HOLD/RESUME** again.

Note: You can also use the **PRV/HWY**, **▲** or **▼** key instead of pressing **HOLD/RESUME**.

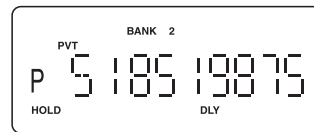
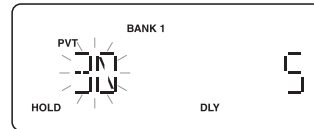

Channel Lockout

You can lockout any channel so it is not checked during normal scanning. You can also restore the channel to scanning when you wish.

Lockout in Hold Mode

1. Press **HOLD/RESUME** and enter the channel number by using the keypad, then press **HOLD/RESUME**.
— OR —
1. Press **HOLD/RESUME** and enter the channel by using the **▲** or **▼** key.
2. Press **L/O** to lockout the channel.
“L/O” appears on the display.

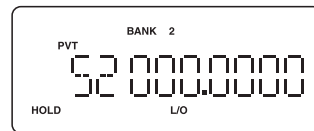

Lockout in Scanning Mode

If the scanner keeps stopping on a particular channel due to noise or frequent transmissions, you may want to keep that channel from scanning.

1. Wait until the scanner stops on the channel.
2. Then press **L/O**.
3. The scanner immediately resumes scanning because the locked out channel is no longer in the scanning sequence.

Lockout Tips Write down your locked-out channels and put in a convenient place in case you need to restore them.

Restoring a Locked-out Channel in Hold Mode

1. Press **HOLD/RESUME** and select the channel number you want to restore by using the keypad, the **▲** or **▼** key, then press **HOLD/RESUME**.
2. Press **L/O** to unlock the channel. The “L/O” disappears.

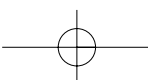

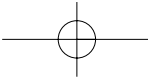

Restoring All Locked-out Channels

You can restore all locked-out channels in a bank only when a bank is selected for scan. If you have deselected a bank and you want to restore all of its locked-out channels using the steps below, you must press **PVT/HWY** until “**PVT**” appears and then enter the number of the bank on your keypad.

1. Press **HOLD/RESUME**.

Note: You must be in Hold mode before restoring all locked-out channels.

2. Press and hold **L/O** for about 2 seconds. You will hear two beeps when all the channels have been restored.

Priority Scan

When Priority Scan is turned ON, your scanner checks the priority channel in the banks you selected every two seconds for activity. If a signal is present on the priority channel, your scanner monitors the channel until the transmission ends, then resumes normal scanning. You can designate one channel in each bank as a Priority Channel. By default, the first channel in each bank is the Priority Channel, but you can change this.

To activate Priority Scan (in either the Hold or Scan mode):

1. Press **PRI**. “**PRI**” appears.

Note: If you have locked out the priority channel, error message appears when you select Priority mode.

2. Press **PRI** again to deactivate Priority Scan. “**PRI**” disappears.

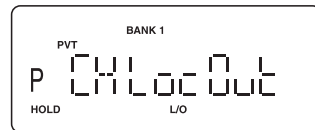
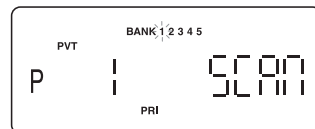

Changing the Priority Channel

You cannot eliminate the Priority Channel, but you can change it to any one of the 50 available channels in each bank.

1. Press **HOLD/RESUME**.
2. Select a new Priority Channel:
 - a. Enter the channel number using the keypad.
 - b. Then press **HOLD/RESUME**.
3. Press and hold **PRI** for 2 seconds to designate this channel as your new Priority Channel. When you hear two beeps, the Priority Channel has been changed. “**P**” appears on the display.

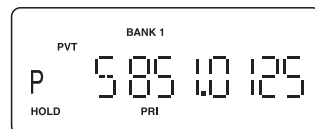

Note: Priority in Trunking mode works just the same, except you set them for talkgroup IDs instead of setting priorities for channels. The scanner only checks priority talkgroups between transmission.

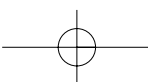

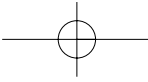

Service Scanning

The service scan feature allows you to rotate through the following nine service banks.

- ① Local Police and County Sheriffs *1
- ② Fire and Emergency Medical Service
- ③ News Media
- ④ Weather (NOAA, weather and Canadian Coast Guard broadcasts)
- ⑤ CB Band
- ⑥ Aircraft *2
- ⑦ Railroads
- ⑧ Marine Band
- ⑨ Department of Transportation *1

*1) Frequencies are pre-programmed on every U.S. state.

*2) Except Aeronautic Radio Navigation (108-117.9875 MHz)

1. Press **SVC** to select a Service.
The current service bank icon appears on the display.

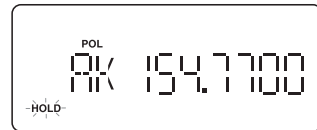

2. Continue pressing **SVC** until your desired Service is displayed.

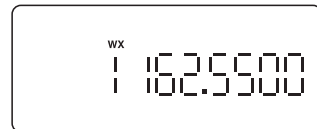

3. After a three second delay scanning begins. If you want to start scanning immediately, press **HOLD/RESUME**.

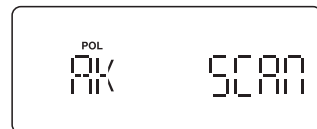

Note : • Press **HOLD/RESUME** at any time to hold the frequency. Press the ▲ or ▼ key to move up or down the frequency. If you find the frequency you want to store, while in Hold mode you can store the frequency (see page 21).

- If you want to remain on a frequency until a responding transmission is received, press **DELAY** to activate the delay feature (See page 28).
- To skip a frequency, press **L/O**. You can program up to 100 skip frequencies for Local Police, County Sheriffs and Department of transportation. And you can program up to 50 skip frequencies for other services (See page 27).
- If you select POLICE or DOT, press **STATE** to select the desired state.

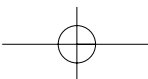

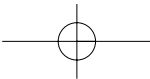

Band Search

Setting a Search Band

The BCT8 can search up to 13 separate frequency ranges to help you discover new stations in your area.

To set a Search Bands, enter into the Band Search mode.

Band	Frequency Range (MHz)	Mode	Step	Display
1	25.0000 - 27.9950	AM	5kHz	25-28
2	28.0000 - 29.7000	FM	5kHz	28-30
3	30.0000 - 49.9950	FM	5kHz	30-50
4	50.0000 - 54.0000	FM	5kHz	50-54
5	108.0000 - 136.9875	AM	12.5kHz	108-137
6	137.0000 - 143.9950	FM	5kHz	137-144
7	144.0000 - 147.9950	FM	5kHz	144-148
8	148.0000 - 174.0000	FM	5kHz	148-174
9	400.0000 - 419.9875	FM	12.5kHz	400-420
10	420.0000 - 449.9875	FM	12.5kHz	420-450
11	450.0000 - 469.9875	FM	12.5kHz	450-470
12	470.0000 - 512.0000	FM	12.5kHz	470-512
13	806.0000 - 826.9875	FM	12.5kHz	806-956
	849.0125 - 868.9875			
	894.0125 - 956.0000			

1. Press **SRCH**. The upper and lower limits of the Bands currently selected are on the display.

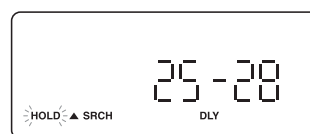

2. Use the **▲** or **▼** key to select the band you want to search. Wait for about two seconds and the scanner will begin searching that band. Or press **HOLD/RESUME** to begin immediately.



- Note:**
- You must set the Search Bands prior to any searching.
 - The scanner automatically increases its search speed up to 300 steps per second for bands having 5 kHz steps. (Turbo Search)
 - While searching, you can change the search direction by using the **▲** or **▼** key. Make sure which of icon, "**▲SRCH**" or "**SRCH▼**" appears on the display.

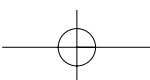

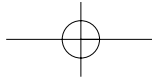

- While Private Scanning in the trunking banks, press **SRCH**, then it will move to ID Search mode.

Search Hold Feature

1. Press **HOLD/RESUME** at anytime to stop the search. To move up or down 1 frequency step, use the **▲** or **▼** key.
2. Press **HOLD/RESUME** to resume searching.

Data Skip

A scanner will normally stop on any transmission it receives. This means the BCT8 will occasionally stop on data signals and unmodulated transmissions. You can automatically skip many of these types of transmissions during search.

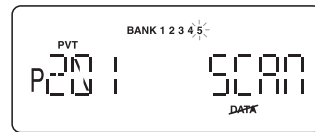

1. To activate the Data Skip feature, press **DATA** in Scan or Search mode. "**DATA**" appears on the display.
2. To deactivate the Data Skip feature, press **DATA** again. "**DATA**" disappears.

When Data Skip is active, your scanner may pause momentarily on an unwanted signal but will resume searching in two or three seconds. The Data Skip feature is active as well as Scan mode and Service Search mode. Data Skip does not function during Service Scanning band (for AIR, CB, or Weather band), Priority Scan, and Trunking mode.

Frequency Skip

If a particular frequency continues to interrupt search scanning, it is possible to set the scanner to skip the frequency.

To skip over a frequency, press **L/O** when stopping on the frequency you want to skip or when in Search Hold mode.

Note: You can program up to 100 skip frequencies.
The 101st skip frequency entered causes the first skipped frequency to unlock.

To restore a Locked out/Skipped channel.

1. Select the desired frequency by using the **▲** or **▼** key in Search Hold mode.
2. Press **L/O**, and then press **HOLD/RESUME**.

To restore all skipped frequencies, press and hold **L/O** for 2 seconds in Search Hold mode.

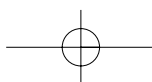

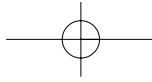

Storing Search Frequencies

You can quickly store any frequency you find during Search.

1. During Search, press **HOLD/RESUME**. If you want to change the frequency, use the **▲** or **▼** key to move up or down 1 frequency step. Then press **E**. Or when the scanner stops on the frequency you want to store, press **E**.
2. Select a bank you want to store by using the keypad. The smallest empty channel number and the frequency alternately appear on the display. If necessary, you can also change the channel by using the keypad, the **▲** or **▼** key.
3. Press **E**.

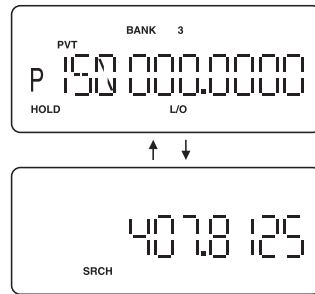

- Note :**
- If the frequency you want to store exists already in a bank, you will hear an error tone and other channel appears on the display. (See “Duplicate Frequency Alert” on page 22.)
 - After storing the frequency, it moves to the Search Hold mode.
 - If there is no free channel, the frequency you want to store will automatically be stored in the first channel in the selected bank.
4. Press **SRCH** to resume searching.

Delay

To help prevent missing a reply on a specific channel or frequency, you can program a two-seconds delay into any channel, frequency, service band or band search. When scan or search stops on a channel or frequency, there is a two-second pause before the scanning cycle resumes.

To activate the Delay feature (in either Scan mode or Search mode):

1. For Highway Scan mode or Private Scan mode, when in Hold mode, select the desired frequency or channel and then press **DELAY**. Or when the scanner stops on an active frequency or channel, quickly press **DELAY** before it continues scanning again.
- OR —
1. For Search mode, while searching press **DELAY**.
 2. “**DLY**” will appear on the display.

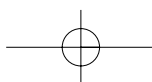

Trunk Tracking

Your BCT8 tracks three major types of trunked radio systems. These systems are described here.

- ❖ **MOTOROLA** - Including Type I, Type II, Hybrid, SMARTNET, and Privacy Plus.
Motorola systems are widely used by public safety and business users. Most are on the 800 MHz band, and recent systems are appearing on other bands. (see page 43).
- ❖ **EDACS** - Including "Wideband" 9600 baud and SCAT. "Wideband" systems are mostly on the 800 MHz band, and are used by public safety, utilities, and business users. Some systems are used on the VHF and UHF bands. (see page 39). SCAT systems are single-channel EDACS systems, and are mainly used in the Midwestern United States.
- ❖ **LTR** - These systems are mostly for business users, and found on the UHF, 800 and 900 MHz bands. (See page 42).

For details on the operation and programming for all of these systems, see pages 29-47.

When tracking these types of systems, remember these important points:

- Your scanner defaults to monitor Motorola Type II 800; however, you can change this if the system in your area is different. (The types of systems are discussed below.)
- The frequencies for many of the trunked public safety systems are listed in the TrunkTracker Frequency Guide included with your BCT8 scanner. Frequencies sometimes change, check with www.trunktracker.com.
- If you have internet access, you can visit scanner.uniden.com or www.trunktracker.com for additional information, for current news and frequency information, about Trunk Tracking Scanning.

* Motorola, SMARTNET, and PRIVACY PLUS are trademarks of Motorola Inc. EDACS is a registered trademark of the M/A - COM Inc. LTR is a registered trademark of E.F. Johnson Company.

Setting the Squelch

For trunked reception, a good setting for the **SQL** control is in the center of the range with the color marker pointing up. See the illustration.

If it is set too high, it could prevent your scanner from locking to the Control Channel reliably. If it is set too low, it will slightly delay finding the Control Channel. The best setting is the same as for conventional reception, and is critical for monitoring trunked systems.

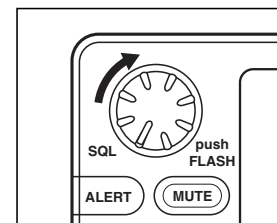

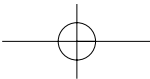

Programming Trunking Frequencies

There are three steps for programming a trunked system:

1. Program the Trunk Type – What type of system will the scanner be tracking, Motorola Type II, Type I, EDACS, LTR, etc.
 2. Program the Trunked Frequencies – Within a trunked system, the frequencies are shared among all the users, called “Talk Groups”.
 3. Program the Talk Groups – Within the trunked system, each agency or department is assigned a Talk Group ID. This ID must be programmed into the scanner in order for it to monitor that specific agency or department.
- When programming you decide which “Location” to program the “Talk Groups”. This is similar to how you program frequencies into channels. Here you need to program Talk Group ID’s into Locations.

Before you start programming your scanner to track a trunked system, consider the following:

- You can only program one trunking system in each bank of your scanner.
- Trunked frequencies must be entered while in the Trunk Programming mode.
- If you’re in the Trunk Programming mode, you cannot select channels in other banks.
For example, if you are programming Bank 4, you can only select channels 151-200 with the ▲ or ▼ key.
- **IMPORTANT:** If you are programming an EDACS® trunked system, you must enter the frequencies in a specific order. Check the frequency guide included with the radio and the listed web sites for details.

STEP 1: Selecting Trunking System Type

The first step in a Trunk Tracking system is storing the frequencies in one of the five available banks in your scanner.

1. Press **TRUNK** for 1.5 seconds.
You will hear two beeps, and “**BANK**” and “**TRUNK**” will begin to flash on the display.
2. Select the bank you want to store the frequency by using the keypad.
3. Select the system you want to track by using the ▲ or ▼ key, then press **E**.



- List of trunking systems as follows:
- E2-800 (Motorola Type II 800 MHz)
 - E2-Hi (Motorola Type II VHF 136-174 MHz) *
 - E2-UHF (Motorola Type II UHF 406-512 MHz) *
 - E1 (Motorola Type I and Hybrid) **
 - Ed (EDACS® Wide Band: 9600 band)***
 - Ed SCt (EDACD Scat)

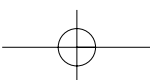

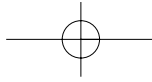

Lt (LTR)

* Requires programming of a Base and Spacing frequency Offset channel (See page 45).

** Requires programming of a Fleet map (See page 44).

*** Requires programming of frequencies in exact order and location.

STEP 2: Programming Trunking Frequencies

1. Select **TRK F** and press **E**. Use the keypad and **⊙** (decimal key) to enter a frequency for the trunked system.

For example, enter 85 10 125 .

Note: To clear a mistake while entering a frequency, press **⊙** (decimal key) twice, and start over.

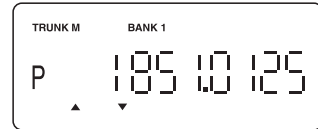

2. Then press **E**.

The “**E**” (EDACS), “**M**” (Motorola) or “**L**” (LTR) appears depending on the trunked system selected.

If the frequency is out of the range of the system chosen in this step, you will hear an error tone, the channel number flashes and an error message appears on the display.

3. Use the **▲** or **▼** key to select the next channel in the bank and press **E**.
4. Repeat steps 2 and 3 until all frequencies have been entered.
5. Press **SRCH** to begin searching the bank you’ve programmed.

Then select the programmed bank by using the keypad.

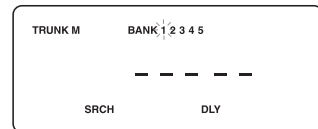

Remember! To lockout the keypad to prevent re-programming of talkgroups, you can use Memory Lock (Refer to “Memory Lock” on page 22).

Hint: If you want to return to the previous menu screen, press **HOLD/RESUME** in the Trunk Programming mode.

Programming Talk Group ID/Scan Lists

Scan Lists

Each bank of your BCT8 can be a trunk tracking bank and it can be a conventional scanning bank. When you designate a bank as a trunking bank, your scanner sets up 5 Scan Lists, which are simply lists used to store your favorite Talk Group IDs. Each list can contain up to 10 IDs, so you can store a total of 50 IDs for each trunk tracking bank. (250 IDs if you use all the banks as trunking banks!)

Scan Lists help you organize the trunking system users into categories. For example, you might use List#1 for police IDs, List#2 for fire department IDs, List#3 for emergency medical service IDs, etc. Once IDs are stored in lists, you can scan them as you scan conventional frequencies and you can lockout any one (up to 4) of the 5 Scan Lists by pressing the corresponding numeric key. When an ID is active, the Scan List number will appear on the display. You can program your Scan Lists either manually or during Trunking Search mode.

Check the web site www.trunktracker.com for a complete list of talkgroups for your area

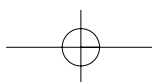

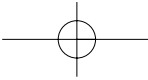

that you can program into your Scan Lists.

In order to program Talk Group ID's, you must first complete Step1—"Selecting Trunking System Type", page 30 and Step 2 – "Programming Trunking Frequencies", page 31.

1. After programming a frequency, press **HOLD/RESUME** to return to the main screen of system type selected and select **Prog ID**. Then press **E**.
2. Select the Scan List location by using the **▲** or **▼** key.
3. Enter the Talk Group IDs for each trunk system as follows.

To enter a Type 2 Talk Group ID:

1. Enter the ID you want to store by using the keypad.
2. Press **E**.

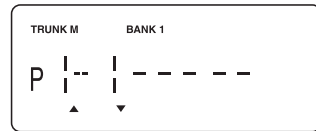

To enter a Type 1 ID:

For a Type I ID, the Block number, Fleet number and Subfleet number make up the Talk Group ID number. For detail please see page 59.

1. Enter the ID you want to store by using the keypad (ID = Block number + Fleet number + **⊙** (decimal key) + Subfleet number).
2. Press **E**.

To enter a Full EDACS ID®:

1. Enter the Agency number.
2. Press **⊙** (decimal key) for the "dash".
3. Enter the Fleet number and Subfleet number.
4. Press **E**.

To enter a Partial EDACS® ID:

1. Enter the Agency number you want to store. Use the **⊙** (decimal key) for the "dash".
2. Press **E**.

Or you can program all the Talk Group numbers within one fleet of an Agency.

1. Enter the Agency number.
2. Press **⊙** (decimal key) for the "dash".
3. Enter the Fleet number.
4. Press **E**.

Hint: Remember that Uniden's AFS format allows you to enter full or partial EDACS IDs for powerful flexibility in all modes. Be sure to read the section "EDACS Reception" on page 39 to learn how this works.

Note: The BCT8 default to "AFS" talkgroup displays for EDACS® only.

To enter a LTR ID:

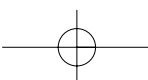

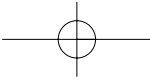

For a LTR ID, the Area Code, Home Repeater number and ID make up the Talk Group ID. Please see page 42 for more information.

1. Enter the Area Code.
2. Enter the Home Repeater number.
3. Enter the ID you want to store
4. Press **E**.

Note: To clear a stored ID while entering an ID, press **0** and **E** successively, and start over.

Receiving Trunked Systems

When you have properly programmed all the frequencies for a trunked system, you can monitor the system in several different ways. You will find that Search, Hold, Lockout, Scan and Delay are all similar to conventional scanning.

- ❖ ID SCAN lets you receive those talkgroups that you store in Scan Lists.
- ❖ ID SCAN HOLD lets you selectively listen to a talkgroup in your Scan Lists.
- ❖ ID SEARCH lets you hear all system talkgroup activity. This is the best way to get started.
- ❖ ID SEARCH HOLD works with Search mode to let you quickly freeze reception on an interesting transmission. Or you can manually specify a talkgroup with DIRECT ENTRY in ID HOLD.
- ❖ ID LOCKOUT works with Search and Scan to exclude talkgroups that you don't want to hear.
- ❖ ID DELAY works with each talkgroup to be delayed when the communication ends.

When receiving EDACS systems, remember that Uniden's AFS talkgroups give you powerful flexibility. In a few key presses, you can specify a single talkgroup, a fleet, or an entire agency in all the above modes. Read the section "EDACS Reception" to understand how this works.

Hint: If the scanner is not in the Trunking mode, you can enter the Trunk mode by pressing **TRUNK**. Pressing **TRUNK** in the Trunking mode will move to the Private Scan Hold mode.

ID Scan Mode

1. When in the Trunking mode, press **PVT/HWY** to begin scanning the lists you have programmed.

If you haven't programmed any IDs, the scanner cannot stop on an active conversation.

2. To remove a Scan List from active scanning, press the number of the Scan List on your keypad.

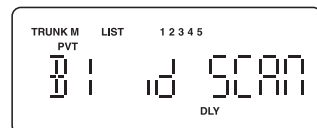

The Scan List indicator turns Off, and the IDs in that list are not scanned.

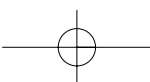

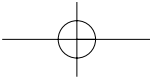

Note: One Scan List must always be active. If you try and deactivate all the Scan Lists, Scan List 1 will automatically be active.

3. To restore a Scan List to active scanning, press its number again.

☞ Remember! When you press **TRUNK** in the Trunking mode, you can be out of the Trunking mode and enter into Private Scan Hold mode.

Note: • **id SCAN** appears on the display during Trunk Scan instead of simply **SCAN**.

ID Scan Hold Feature

If you want to stop on a ID during ID scanning, press **HOLD/RESUME**.

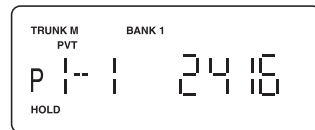

To directly access a specific ID location:

There are several ways to access a specific ID quickly.

1. Press **HOLD/RESUME** to enter into Hold mode.
2. Using the keypad, **▲** or **▼** key, enter the ID location number (See page 31).
3. Press **HOLD/RESUME**.

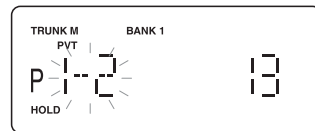

If you want to resume scanning, press **HOLD/RESUME**.

ID Search Mode

Once you have programmed all the frequencies for a trunked system, Search will let you immediately start hearing transmissions.

When in the Trunking mode, press **SRCH** and the scanner begins to find any active IDs. When the scanner finds any ID, you will hear it.

Talkgroups display differently in Motorola, EDACS and LTR systems. You should read the appropriate parts of this guide to understand the formats.

The display indicates the bank and the type of trunked system you are monitoring. While monitoring on ID, press the **▲** key, and the scanner will check if any other IDs are active.

Regardless of the system, you won't know exactly who you are receiving until you listen for a while, or refer to frequency guides or internet sites such as www.trunktracker.com. Of course, figuring out who each ID represents is half the fun of Trunk Tracking.

Later, when you learn more about a system, you will want to store lists of talkgroups. Then you can scan specific agencies and users, and use the many other features your radio provides.

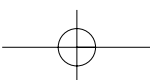

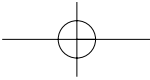

ID Monitor Mode

By using ID Monitor mode, you can determine which talk groups are the most active without hearing conversations.

1. Press and hold **SRCH** for 2 seconds until you hear two beeps. Then **SRCH** begins flashing and all active talk group IDs appear on the display every 0.5 seconds.
2. To activate ID search mode, press **SRCH**

Note: Lockout ID also appears on the display.

ID Search Hold and Direct Entry ID in Hold Mode

Just like in Conventional Search, Hold lets you pause ID Search on an interesting transmission without storing the talkgroup into memory.

If you hear an interesting ID during Search mode, and want to continue listening to it --

- Press **HOLD/RESUME** to stop the search.

If you want to listen to a specific ID, while in Hold mode --

- Use the keypad to enter the ID you want and press the **▼** key.

If you want to resume searching --

- Press **HOLD/RESUME** to return to Search mode.

Note: ID Hold feature is also applied to ID Scan mode.

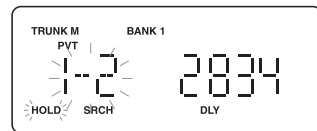
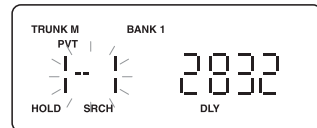

Programming Scan Lists During Search

To select a Scan List location and store an ID during Search mode, follow these steps:

1. When your scanner stops on an ID you want to store, press **HOLD/RESUME**.
2. You can change the Scan List memory location by using the **▲** or **▼** key. And then press **E**.
3. Press **SRCH** to return to Trunk Tracking Search mode.

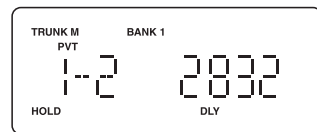
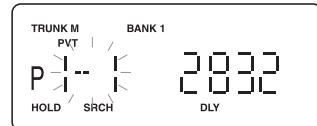

Deleting a Stored ID

To delete a stored ID:

1. Press **HOLD/RESUME** in the ID Scan mode.
2. Select the Scan List location you want to delete by using the **▲** or **▼** key.
3. Press **0**.
4. Then press **E**.

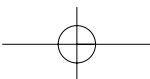

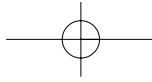

ID Lockout

Like conventional scanning, it's possible to lockout unwanted traffic. This is particularly important in trunked systems because in many areas, water meters, door alarms, traffic signals, and other mechanical devices are assigned IDs just like other users. Also some departments scramble or encrust their communications, and you may want to lock out these unintelligible broadcasts.

To Lockout an ID, press **L/O** on the ID you want to lockout.

The ID is locked out. You can Lockout up to 100 IDs. The 101st skip frequency entered causes the first skipped frequency to unlock.

Note: If you Lockout an ID in Search mode, it is also locked out in Scan List mode. Conversely, if you Lockout an ID while in Scan List mode, it is locked out in Search mode. For information about Scan Lists see page 31.

EDACS BLOCKOUT is a powerful form of ID Lockout that can be used only with AFS and EDACS systems. This feature lets you lockout entire Agencies or Fleets, not just individual talkgroups. Using EDACS Blockout you can, for example, prevent Search from stopping on any of hundreds of talkgroups in the Utilities agency. You can do this with just a few key presses. To use this mode just enter the Agency-part, or the Agency-Fleet part, of the talkgroup code and press **L/O**. For example, to Blockout Agency 4 in Trunk Search, press **HOLD/RESUME, 0, 4, .** (decimal key), and then **L/O**. For other ways to use partial AFS entry, be sure to read the section "EDACS Reception".

Review ID Lockout

You can check all IDs already locked out.

1. Press and hold **TRUNK** for 1.5 seconds in the Trunking mode.
2. Select the bank you want to review by using the keypad, and then the trunked system selected appears on the display. Then press **E**.
3. Select **id Lock** by using the **▲** or **▼** key, and then press **E**.
4. You can see the locked out IDs by using the **▲** or **▼** key.

Hint: Press and hold **L/O** for 2 seconds to check all locked out IDs when in the Trunking mode.

Restoring Locked-out IDs

To restore a single ID, follow these steps:

1. While in locked out review mode, select the locked out ID you want to restore and press **L/O**.

The ID is restored and "**L/O**" disappears.

To restore all locked out IDs in a bank once:

1. While in locked out review mode, press and hold **L/O** for 3 seconds. All locked out IDs in a bank are restored.

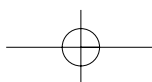

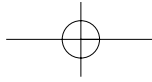

Setting the Delay Mode for Trunking Mode

A default delay of 2 seconds is automatically set for each talkgroup for ID Scan mode and ID Search mode. To set the delay feature on or off, press **DELAY** while trunking, “**DLY**” will appear or disappear depending on your setting.

Trunking Frequency Confirmation

You can check the frequency while a talkgroup ID is active.

Press the ▼ key, and the active frequency on which the talk group is transmitting will flash on the display. Or press and hold the ▼ key for 2 seconds, the ID and the frequency alternately appears on the display. To cancel this mode, press the ▼ key again.

Hint: This feature is applied to ID Scan mode and ID Search mode.

Setting Priority in Trunking Mode

You can set priority in your Scan lists, just as you do in your conventional ones. Default setting for the Priority ID is the first location in each Scan List. You can set the priority by pressing and holding **PRI** for 2 seconds in ID Scan Hold mode. After you've set up your Scan List, press **PRI** to activate it.

It's very similar to conventional priority although there is no "interrupt" during the transmissions. Priorities are checked in between transmissions.

With Priority ON, you can hold on an ID in your Scan List, such as Scan List 3, memory location 7, and the scanner will check all the priorities in all the active Scan Lists in between any transmissions on the ID on which you're holding. The lowest numbered priority will be checked first. For example, the Priority ID in List 1 will be checked before the Priority in List 2, etc.

Note:

- This function does not work in LTR tracking.
- Priority Scan does not operate when Priority IDs are locked out.

Moving between Scan List Memories

There are a number of ways to step and move through your Scan List memories:

1. Press **HOLD/RESUME** in the ID Scan mode and use the ▲ or ▼ key to move to up or down.
2. Or, press **HOLD/RESUME** in the ID Scan mode, next press **0-9** (scan list number), then press **0-9** (memory position). For example to move to Scan List 4, memory position 10, press: **HOLD/RESUME, 4, 0, HOLD/RESUME**

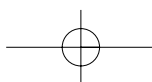

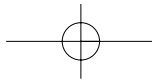

Multi-Track

The BCT8 allows you to track more than one system at a time. Here are some highlights of this feature:

- ❖ You can actually track up to 5 trunking systems at one time.
- ❖ You can trunk scan, or search and scan conventional frequencies at the same time.
- ❖ You can program conventional frequencies in the same bank as trunking systems. After the scanner finishes checking a trunked system for activity, it will conventionally scan the other frequencies in the bank (remember, only trunking frequencies are programmed in Trunk mode).

To scan a mix of trunking and conventional banks, select the banks you wish to be active, and then press **TRUNK**. The scanner will instantly begin scanning. You can switch to Search mode and the scanner will search for any active ID's on the system.

Note: To switch ID Scan or ID Search, press **PVT/HWY** or **SRCH** in the trunked system.

Multi-Track Operational Details

When more than one trunk system is active (for example two or more trunked systems or a trunked system and one or more conventional frequencies), the radio jumps between systems/frequencies as follows:

TRUNK SCAN: The scanner moves to a trunked system and looks for IDs in your Scan List(s) for up to 1 second. If it finds no activity on your programmed talkgroups, it moves on to conventional channels in the same bank or to the next active bank.

If the scanner finds a talkgroup in one of your active Scan Lists, you will begin to hear that communication and the scanner will of course display the proper talkgroup number. When the communication ends, the scanner will wait for 2 seconds for any further replies and, if none, the scanner will move to the conventional channels in the same bank or to the next bank.

The scanner will not look for any other IDs within the same trunked system (as this would slow the scan process). If you press the ▲ key while you are listening to one ID, the scanner will check to see if another ID in your Scan List is active. It will disregard the ID to which you were just monitoring.

TRUNK SEARCH: This mode works similarly to Trunk Scan. If the scanner finds any (non-locked-out) ID when it checks the control channel, you will hear it. You will then hear any replies that follow within 2 seconds. After that the scanner will move on and not continuously search the system for additional IDs (on busy systems you would never leave the system if this were the case). If you press the ▲ key while monitoring one ID, the radio will check if any other IDs are active (it will disregard the ID you just left), and if none are active, it will move on.

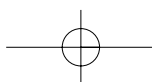

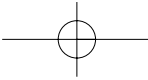

EDACS® Reception

EDACS® Tracking

TrunkTracker III now allows tracking of EDACS® trunked systems. Until now these widely used systems have been almost impossible to monitor with a conventional scanner. With your TrunkTracker III listening to EDACS(s) is remarkably easy, and perhaps even easier than conventional scanning.

EDACS systems use 'Transmission Trunking', which means that each transmission is assigned a new frequency. As the conversation moves through the system's frequencies, your TrunkTracker III automatically follows it.

This chart shows a 30 second sample of EDACS transmissions. Eight different talkgroups are using the system as their transmissions switch between the thirteen system frequencies. Notice how the dotted line shows talkgroup 02-023 moving from channel to channel. Your BCT8 can clearly and automatically follow this talkgroup, or any other, as you select.

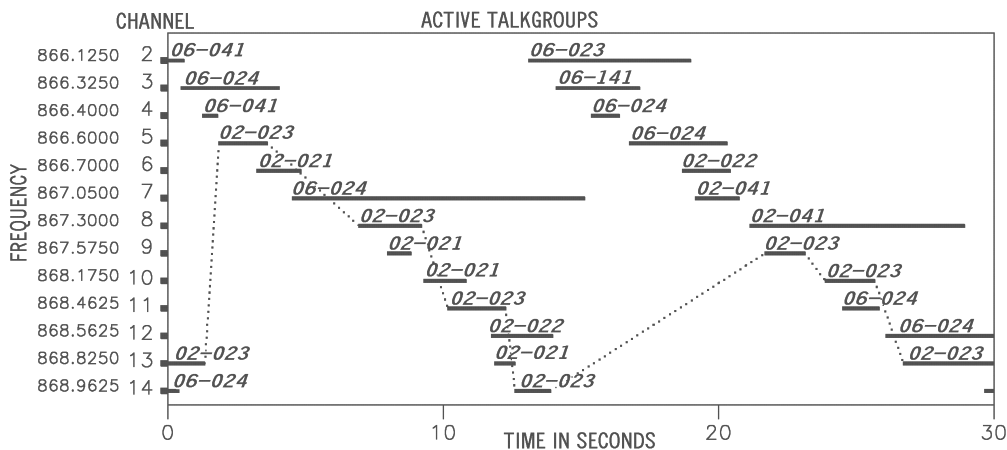

EDACS systems are organized in a logical way that keeps related talkgroups together. Your scanner is designed to take maximum advantage of this organization to make your scanning easy. It lets you zero in on just the part of the system you want to hear, whether it is an individual channel, an entire department or city.

Programming EDACS System Frequencies

When you program EDACS frequencies, it is critical that you store each one in the CORRECT LOCATION. By the nature of EDACS systems this is necessary for tracking. This often is not the frequency order, so you must be sure you have the right sequence. Sources for this information can be found at scanner.uniden.com.

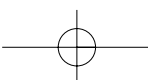

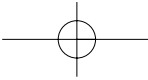

An EDACS® Trunked system

This chart shows how talkgroups are organized within an EDACS system at the Agency level. The individual talkgroups cannot be shown at this scale because there are over 2000. However the chart can show the 16 Agencies in this example. The system is logical and easy to understand. EDACS systems are typically arranged in an outline structure.

The system users are given blocks of talkgroups. Sizes vary but most large cities and other agencies have blocks of 128 channels. Smaller cities have only 64 or 32 channels.

In this example, the County Sheriff is agency 01. The city of Sullivan is Agency 03. Adams Hill and Matthew Junction share Agency 08.

Your scanner shows EDACS talkgroups in AFS (Agency-Fleet-Subfleet) format. This helps you see, at a glance, who you are monitoring. And with the partial-entry feature you can easily include nearby, related channels in the same Fleet or Agency. You can just as easily exclude entire unwanted Fleets and Agencies.

When in Search mode, with the system frequencies programmed, and your scanner locked to the control channel, you can select a desired city by keying in the Agency part of the AFS talkgroup. For example, in Hold mode you can select the entire city of Sullivan with 4 key presses **0, 3,**

⓪ (decimal key), **SRCH** key.

When you hear an interesting talkgroup, in Hold mode capture it to your Scan List by pressing **E** during the transmission.

Or hold on it by pressing **HOLD/RESUME**.

If you want to monitor the Sullivan Police Dispatch channel (which is talk group 03-062), press **0, 3, ⓪** (decimal key), **0, 6, 2,** the **▼** key. Your scanner can also work in decimal format.

Talkgroup 03-62 in decimal format is 402. But decimal format does not give you any information about the system hierarchy.

For example Sullivan, in decimal, uses channels from 384 to 511. This is not as easy to remember as Agency 03. But decimal is useful if you need to work from decimal talkgroup lists.

AFS	AGENCY	DECIMAL
00		000
01	COUNTY SHERIFF	200
02	HOSPITALS COUNTY FIRE AMBULANCE	300
03	SULLIVAN	400
04	SWANSON BIRMINGHAM	500
05	MILLIKEN RANORA POND TROUBLE CREEK	600
06	COLUMBIA	700
07		800
08	ADAMS HILL MATTHEW JCT	900
09	CLIFFORD	1000
10	COUNTY GOVT	1100
11	BEACONSFIELD	1200
12	NEW ELFERS BRENNAN EXMORE OAK VALLEY	1300
13	MIRANDA CANYON	1400
14		1500
15		1600
		1700
		1800
		1900
		2000

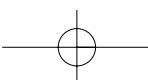
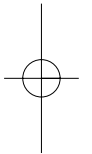

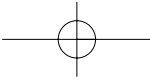

Special EDACS® Features

AFS Partial Entry Feature

AFS is Uniden's method of encoding EDACS talkgroups.

AFS stands for 'Agency-Fleet-Subfleet'.

AFS talkgroups are used in all EDACS reception -- in ID Search, ID Lockout and ID Scan. The powerful AFS Partial Entry feature designed into the BCT8 lets you use either a complete talkgroup code, or just the most significant part.

This feature lets you expand or narrow searching and scanning to one of 4 levels. By entering only the desired part of an AFS talkgroup, you can select 128 talkgroups, 8 talkgroups, or a single talkgroup.

For example, you could program every talkgroup in a police department with just 4 key presses. You can use the AFS Partial Entry feature anywhere you need to specify EDACS talkgroup.

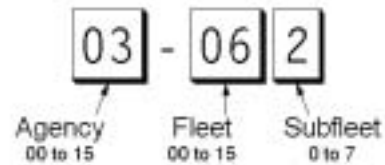

Your BCT8 can also enter or display EDACS talkgroups in decimal format (0-2047).

1. Press and hold **TRUNK** for 1.5 seconds and select the bank you want to change.
2. Use the ▲ or ▼ key to select Ed , then press **E**.
3. Use the ▲ or ▼ key to select AFS , then press **E**.
4. Use the ▲ or ▼ key to select AFS ON or AFS OFF , then press **E**.

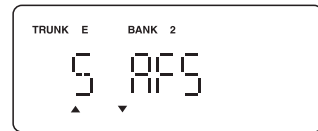

You can use this feature to translate decimal talkgroups lists to the much more powerful AFS format.

Examples of how you might use AFS are shown above in the description of an EDACS trunked system, and elsewhere in this manual. It is very easy to use. Be sure to become familiar with AFS Partial Entry, and your scanning will become far more flexible and efficient.

EDACS ID Range Search

When the scanner searches EDACS talk group IDs, the scanner can search within a range you set for Agency or Fleet listings. For example if you want to search within the 01 agency, while in Hold mode press **0, 1, *** (decimal key) then **SRCH**. Or if you want to search within the 01 agency and 01 fleet, while trunking press **0, 1, *** (decimal key), **0, 1**, then **SRCH**. To stop the ID range search, press **SRCH**.

EDACS SCAT

With the EDACS SCAT feature, the data stream transmissions will be eliminated allowing you to clearly monitor the voice communications on EDACS SCAT systems.

To monitor EDACS SCAT systems you only need to program the frequency in the Trunk Tracking Programming mode. You do not need to enter group ID's.

Note: As EDACS SCAT is different from the other tracking feature, and it is not a feature which the scanner tracks any ID, you do not need to program Talk Group ID's.

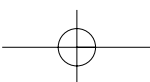

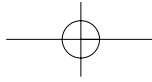

LTR[®] Reception

LTR[®] Tracking

LTR[®] (Logic Trunked Radio) systems are trunking systems used primarily by business or private communications service providers, such as taxicabs, delivery trucks, and repair services. These systems encode all trunking information as digital subaudible data that accompanies each transmission. Users on an LTR system are assigned to specific talkgroups, which are identified by the radio as six digit numbers.

These numbers are in the form AHHUUU, where:

A= Area code (0 or 1)

H= Home repeater (01 through 20)

U= User ID (000 through 254)

When the scanner receives a transmission on a channel set to the LTR mode, it first decodes the LTR data included with the transmission. In the ID Search mode, the scanner stops on the transmission and displays the talkgroup ID on the display. In the ID Scan mode, the scanner only stops on the transmission if the LTR data matches a talkgroup ID that you have stored in the bank's talkgroup ID list and have not locked out.

LTR systems are frequently programmed so that each radio has a unique ID code.

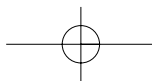
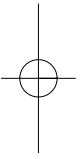
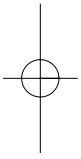

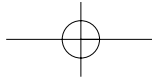

Motorola Reception

Motorola Tracking

There are really two types of Motorola trunking systems. These are usually referred to as Type I and Type II systems. Type I only occurs on some 800 MHz systems. All VHF and UHF trunking systems use Type II.

One important distinction between these two systems is the amount of data transmitted by each radio when its push-to-talk button (**PTT**) is pressed. Every radio in a trunked system is assigned a unique ID so the central site computer can identify it when it's used. Both Type I and Type II systems place radios (or radio users) into groups, called talkgroups, and these talkgroups are also assigned unique IDs. Some radios have access to only one talkgroup, while others have access to many talkgroups. The talkgroup(s) each radio can access is called the radio's affiliation(s).

In a Type II system, when someone uses their radio, only the radio ID is transmitted when **PTT** is pressed, whereas in a Type I system the radio ID and its current affiliation are both transmitted when **PTT** is pressed.

Why the difference? Type II systems are slightly more advanced because the central computer maintains a database which is used to determine each radio's affiliation(s).

Changes to a Type II system are easier than Type I because the system manager only needs to update the database instead of reprogramming individual radios.

Another difference between the systems is that Type I systems are arranged in a Fleet-Subfleet hierarchy. For example, its possible for a city using a Type I system to designate 4 Fleets, each with 8 Subfleets. Their fleets might be the Police Department, the Fire Department, Utilities, and Administration. The Police may decide to further divide their fleet into subfleets such as Dispatch, Tactical Operations, Detectives, North, South, East and West Side Patrols, and Supervisors. All the available police radios would then be assigned to one of the police subfleets. Determining the exact Fleet-Subfleet hierarchy for a particular area is referred to as Fleet Map Programming, which is discussed further in this manual.

The disadvantage of a Type I system is that when **PTT** is pressed, the brief burst of data must contain the radio's ID and its Fleet and Subfleet. This is three times the amount of data a Type II system radio sends, and as a result Type I systems usually accommodate fewer users than Type II systems.

Even though there are many Type II systems, Type I systems are still in use. There are also Hybrid systems which are a combination of both Type I and Type II. Your scanner defaults to monitor Type II systems, but its possible to select a Preprogrammed Fleet Map or create a Custom Fleet Map for your area.

For VHF and UHF Type II trunking systems, you will need to know the base, spacing frequencies and offset channels. See page 45 for details.

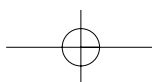

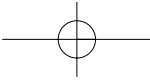

Fleet Map Programming

If you have programmed a trunk tracking bank for Motorola, press **TRUNK** to start Multi-Track, and you will see user IDs on the display. Since the BCT8 defaults to Type II systems, all the IDs will appear as numbers. However, if you notice a mix of odd and even user IDs, for example 6477, 2560, 6481, 6144, 1167, etc., then you are probably monitoring either a Type I or Hybrid systems.

You may also notice that you are missing responses when you hold on an active ID. Unlike Type II, Type I/Hybrid systems require a Fleet Map that sets specific Fleet-Subfleet parameters. It is easy to select a Fleet Map for your scanner; what is not always easy is selecting or programming a map that matches your particular area.

There are 16 preset Fleet Maps listed in the Appendix that you can choose, and these are usually a good place to start when setting up a Type I/Hybrid trunk tracking bank. If you choose a preset map and still have difficulty following complete conversations, then you'll have to program your own Fleet Map.

Selecting Preset Fleet Map

1. Press and hold **TRUNK** for 1.5 seconds and select the bank you want to change.
2. Use the ▲ or ▼ key to select **E 1** (Type 1 system), then press **E**.
3. Use the ▲ or ▼ key to select **FLEET**, then press **E**.
4. Use the ▲ or ▼ key to select the map you want, then press **E**. The scanner returns to FLEET Map list item.

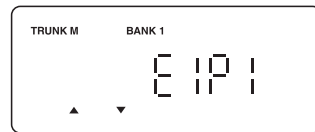

Note: You will now begin to see Type I Fleet-Subfleet IDs. For example, 100-12, 100-9, 000-12, 400-8, etc. See "User Defined Fleet Maps in the Appendix" for more information about Type I IDs.

How do you know if the preset map is correct? You will have to listen to see if you're following complete conversations. If not, you should try another preset map.

Programming a User Fleet Map

You may want to read "User Defined Fleet Maps" in the Appendix before programming a Fleet Map. It contains a detailed explanation of Scanner Fleet Map Programming, as well as a table listing the Fleet Map Size Codes.

1. Press and hold **TRUNK** for 1.5 seconds and select the bank you want to change.
2. Use the ▲ or ▼ key to select **E 1** (Type 1 system), then press **E**.
3. Use the ▲ or ▼ key to select **FLEET**, then press **E**.
4. Use the ▲ or ▼ key to select **USR**, then press **E**.
5. Use the ▲ or ▼ key to select the size code for the first block, then press **E**.

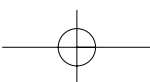
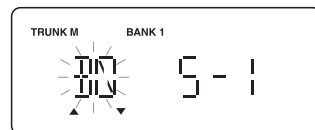
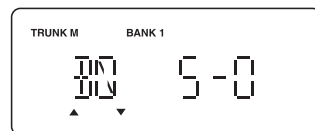

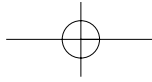

The next available block appears on the display.

- Repeat step 5 until you have selected a size code for each block.
For details about each size code, see "Fleet Map Size Codes" in the Appendix.



Programming a Hybrid System

A Hybrid system is simply a Type I system with some blocks designated as Type II blocks. To program a Hybrid system, follow the steps listed in "Programming a User Fleet Map" in the previous section. However, if you want a block to be Type II, select Size Code 5-0. When you begin searching a trunking bank with a Hybrid Fleet Map, you will see both types of system IDs. That is, Type II IDs usually appear as an even number without a dash; Type I IDs appear as a three or four digit number, followed by a hyphen, followed by a one or two digit number.

Setting the Base, Spacing Frequencies and Offset Channel for Motorola VHF/UHF Trunked Systems

To properly track Motorola VHF and UHF trunked systems, you must enter what is known as the Base, Spacing Frequencies and Offset Channels for each system.

To find these out, check the scanner.uniden.com or www.trunktracker.com and other web sites and frequency resources.

To enter the Base, Spacing Frequencies and Offset Channel: (You can set up to three sets of these, but almost all systems only use one set)

- Press and hold **TRUNK** for 1.5 seconds and select the bank you want to change.
- Use the **▲** or **▼** key to select **E2-V** (Motorola Type2 VHF) or **E2-UHF** (Motorola Type2 UHF), then press **E**.
- Use the **▲** or **▼** key to select **BASE**, then press **E**.
- Use the keypad to enter Configuration Block Number(1-3).
- Use the keypad to enter a new Base Frequency, then press **E**.
- Press the **▲** key and select **SPC** for entering the Spacing Frequency.
- Use the keypad to enter a new Spacing Frequency, then press **E**.

Note: You can only enter within a range of 5-100 kHz, and 5 or 12.5 kHz multiples.

- Press the **▲** key and select **OFFS** for entering the Offset Channel.

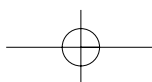
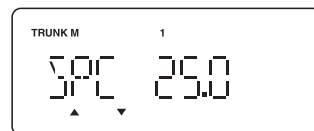
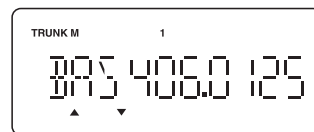

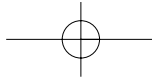

9. Use the keypad to enter a new Offset Channel, then press **E**.

Notes:• You can only input within a range of 380-759.

- If the system is not tracking properly, you may need to try a new Base Frequency or Offset Channel, or you may be missing frequencies from the system.
- You can set up to three Base, Spacing and Offsets for Motorola VHF/UHF trunked systems.

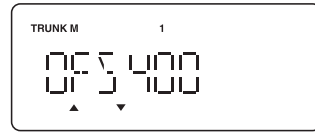

toggling the Status Bit

On Type II trunking systems there is a method by which specialized types of communications utilize unique talkgroup numbers. An emergency call will occur on a unique talkgroup from its primary assignment, for example. Because the BCT8 defaults to Status-Bit ON mode, you never need to worry about missing these transmissions. If you have programmed talkgroup 33264 into Scan List memory, for example, and there is an emergency call within the group, you will hear it on 33264.

The only time you may wish to turn Status Bits OFF is if you're trying to figure out the proper Fleet Map of a Type I trunking system.

1. Press and hold **TRUNK** for 1.5 seconds and select the bank you want to change.
2. Use the **▲** or **▼** key to select **E2-800** (Motorola TYPE2 800MHz), **E2-V** (Motorola Type2 VHF) or **E2-UHF** (Motorola Type2 UHF), then press **E**.
3. Use the **▲** or **▼** key to select **S-BIT**, then press **E**.
3. Use the **▲** or **▼** key to select **SBIT ON** or **SBIT OFF**, then press **E**. The scanner returns to Status Bit list item.

Control Channel Only Mode

When this function is activated, trunking is performed using Control Channel data only. Voice channel (also known as "DATA channel") frequencies do not have to be programmed into memory. This feature only applies to Motorola 800 MHz systems.

1. Press and hold **TRUNK** for 1.5 seconds and select the bank you want to change.
2. Use the **▲** or **▼** key to select **E2-800** (Motorola Type2 800MHz) or **E1** (Motorola Type1 800 MHz), then press **E**.
3. Use the **▲** or **▼** key to select **CC ONLY**, then press **E**.
4. Use the **▲** or **▼** key to select a plan from 4 frequency plans, then press **E**. The scanner returns to Control Channel Only list item.

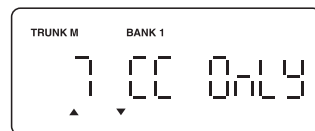

Note: You must choose a plan before you begin to Control Channel Trunk (Only when 800 MHz system is selected).

When you deselect Control Channel only mode, **CC OFF** appears on the display.

Read the descriptions of the Plan 1~4 for details on which may apply for you.

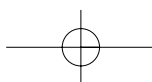

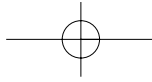

PL1 (plan 1): This plan is the most common. Use Plan 1 if the last three digits of ALL the frequencies in use end in one of the following three digits: 125, 375, 625, or 875 (example: 856.1125, 860.7375, 859.6625, 855.8875).

PL2 (plan 2): If the last three digits of frequencies are less than 860.000 and end in one of the following three digits (125, 375, 625, or 875) and if ANY other frequencies end in (000, 250, 500, or 750) use Plan 2.

PL3 (plan 3): If the last three digits of ALL the frequencies in use end in one of the following three digits (000, 250, 500, or 750) use Plan 3.

PL4 (plan 4): If the last three digits of frequencies are less than 866.0000 and end in one of the following three digits (000, 250, 500, or 750) and if ANY other frequencies end in (125, 375, 625, or 875) use Plan 4.

Of course you will know the Control Channel frequency itself so that will help you determine the proper plan. If you try one plan and you receive errors (such as the scanner jumping to channels that are obviously not part of the system), you should try an alternate Plan.

Notes:

- You can assign a Fleet Map to TYPE 1 or Hybrid systems scanned in Control Channel Only mode by going into the Trunk Programming mode. You can also program IDs, set a delay, and all the other parameters for systems scanned in this mode. You can then either search the system to find new IDs or you can program IDs into memory and then scan them.

- The Control Channel Only feature is an extremely powerful tool. You can use it to determine if systems you are familiar with may have added new frequencies or you can use it to discover new systems by simply finding active control channels (using Search) and then programming them for Control Channel operation only. Remember that this feature only applies to Motorola 800 systems, that you do have to set the proper system type (800 MHz of Type 1 or Type 2) and you do have to program the Control Channel frequency into memory and identify the frequency as trunked in the Trunk Programming mode.

Disconnect Tone Detect Option (End Code)

When this function is disabled, the radio looks for squelch before returning to the Control Channel instead of waiting for the Disconnect Tone. Only in rare instances will you need to adjust the default settings. The condition to return to Control Channels depends on whether the signal is present or not.

- Press and hold **TRUNK** for 1.5 seconds and select the bank you want to change.
- Use the **▲** or **▼** key to select **E2-800** (Motorola TYPE2 800MHz), **E2-V** (Motorola Type2 VHF) or **E2-UHF** (Motorola Type2 UHF), then press **E**.
- Use the **▲** or **▼** key to select **E0t**, then press **E**.
- Use the **▲** or **▼** key to select **E0t ON** or **E0t OFF**, then press **E**.

Note: Set the **SQL** control so that you hear a hissing, and the scanner will remain on the voice channel (even when a disconnect tone is transmitted or there is no signal at all).

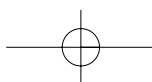

Remote Interface

You can communicate and program your BCT8 in numerous ways with peripheral devices using a Remote Interface Cable port. This radio offers the following modes:

- ❖ PC Control mode
Program and control your scanner from a PC using Uniden's BCT8 Scanner Software.
- ❖ Clone mode
Clone all the frequencies, trunking talkgroups, and fleet maps programmed into your scanner to another BCT8 scanner or another BCT8.

PC Control Mode

To connect Scanner to PC:

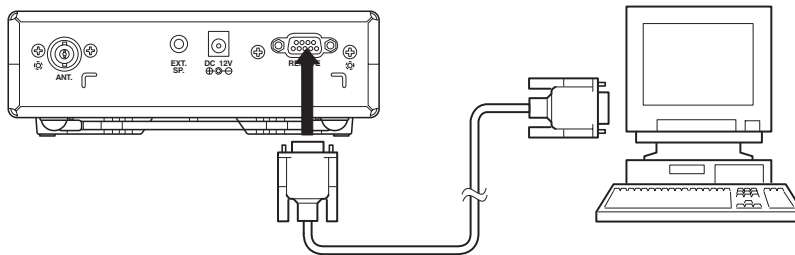

Plug the scanner end of the RS232C straight cable into the remote port which is on the rear of the scanner. Plug the other end of the cable (DB-9 serial connector) into a personal computer's serial port. A few PC's may require an adapter, most will not. Of course, make sure your PC is turned ON.

To program your scanner:

You can program and control your scanner remotely from a PC using Uniden's BCT8 Scanner software.

After connecting the scanner to a PC, turn the scanner ON.

To use the Remote (PC Control) mode, you must install Uniden's BCT8 Scanner software and use as directed. Make sure that your scanner is connected to the serial port of the PC using the RS232C straight cable.

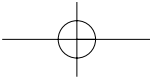

Start Remote Mode and Change Transfer Speed:

1. Press and hold **RMT** for 2 seconds to activate the Remote mode.
2. Select the transfer speed except for **OFF**, then press **E** and the scanner will start Remote mode.



A unique feature of the BCT8 is that all the front panel keys on the radio remain operational in Remote mode.

For information on purchasing BCT8 Scanner software to program and control your BCT8, you can contact the following:

Uniden Parts Department (800) 554-3988
 (Hours are from 8:00 a.m. to 5:00 p.m. Central Time
 Monday through Friday)

scanner.uniden.com

PC Control Parameter

For your information:

- Transfer speed : 9600/19200/38400/57600 bps (adjustable)
- Start/Stop bit : 1 bit, 1 bit
- Data Length : 8 bit
- Parity Check : None
- Code : ASCII code
- Flow Control : None
- Return Code : Carriage Return only

Clone Mode

You will need to purchase a RS232C straight cable a null modem adapter. RS232C straight cables are available as male to male or male to female. Even if the RS232C straight cable you buy already has the male to male connectors, you will still have to have the null modem adapter. On the next page you will see the pin connections that are internal to a standard device. (These items are available at your local electronics stores.)

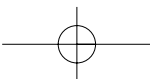

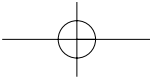

To connect the Scanner to Scanner:

Plug the male end of the RS232C straight interface cable into the remote port on the rear of one of the two scanners. Then connect the DB-9 to DB-9 null modem adapter to the cable. Plug the other end of the null modem adapter into the other scanner (DB9 Gender Changers are also available at your local electronics store.).

Null Modem Adapter
Pin connections

Female DB9	Male DB9
1	4
2	3
3	2
4	6 & 1
5	5
6	4
7	8
8	7
9	Not used

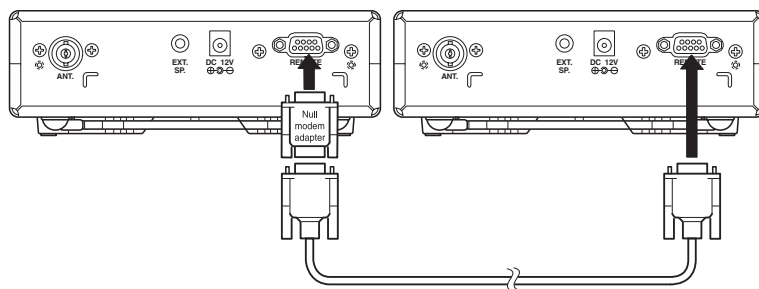

You can clone all of the programming of one BCT8 into another, including frequencies, talkgroup IDs, delay settings, etc. After connecting the two scanners, turn the radios ON. Prepare each scanner for clone mode as follows.

After connecting the two scanners, make sure the scanners are turned off.

1. While you press and hold **E**, turn the radio on for each scanner.
2. Determine the scanner which has the frequency data that you want to transfer. This one must be set up as the "First Unit", and the other must be set as the "Clone Unit".
3. On the scanner that is the "Clone Unit", use the ▲ or ▼ key to select **CLONE**, then press **HOLD/RESUME**.

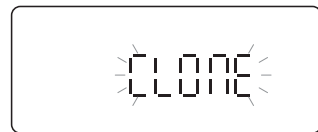

4. On the scanner that is the "First Unit", use the ▲ or ▼ key to select **FIRST**, then press **HOLD/RESUME**.

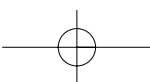
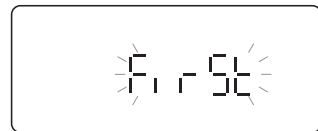

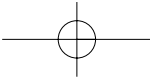

5. The data transfer begins from the First Unit to the Clone Unit.

During the data transfer, both scanners show the following displays.

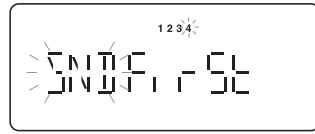

send data



receive data

When the data transfer is complete, done displays.

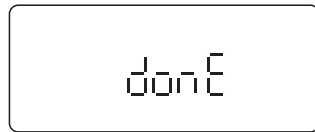

If the data transfer is not successful, the following error message will appear.



- Note:**
- To clear Error, press (decimal key).
 - Once you have completed the cloning of the scanners, reset the scanners by turning the scanners OFF and then ON again. This is particularly important to know if you wish to clone another scanner right away.

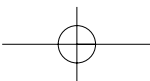

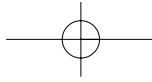

Care and Maintenance

General Use

- Turn the scanner OFF before disconnecting the power.
- Always write down the programmed frequencies in the event of memory loss.
- If memory is lost, simply reprogram each channel.
The display shows 000.0000 in all channels when there has been a memory loss.

Location

- Do not use the scanner in high-moisture environments such as the kitchen or bathroom.
- Avoid placing the unit in direct sunlight or near heating elements or vents.
- If the scanner receives strong interference or electrical noise, move it or its antenna away from the source of the noise. If possible, a higher elevation may provide better reception.

Cleaning

- Disconnect the power to the unit before cleaning.
- Clean the outside of the scanner with a mild detergent.
To prevent scratches, do not use abrasive cleaners or solvents. Be careful not to rub the LCD window.
- Do not use excessive amounts of water.

Repairs

- Do not attempt any repair. The scanner contains no user serviceable parts. Contact the Uniden Customer Service Center or take it to a qualified repair technician.

Birdies

- All radios can receive birdies (undesired signals). If your scanner stops during Scan mode and no sound is heard, it may be receiving a birdie. Birdies are internally generated signals inherent in the electronics of the receiver.

Press **L/O** to lockout the channel, and then press **HOLD/RESUME** to resume scanning.

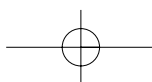

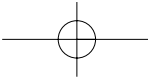

Troubleshooting

If your BCT8 is not performing properly, try the following steps.

Problem	Suggestion
Going by patrol cars and not receiving alarms.	<ol style="list-style-type: none"> 1. Make sure you are scanning in Highway Mode. 2. Check antenna connections. 3. Conditions to activate the alarm are variable and depend upon the timing of the dispatcher transmissions and proximity of patrol car to your vehicle. Also, terrain and other factors may be involved. 4. Officer has the ability to turn off the mobile extender when off-duty, or when going to court, etc., but will normally leave extender operating when on traffic duty. 5. If you're monitoring user-programmed frequencies, switch to one of the preprogrammed frequency banks. 6. Check to see if MUTE and FLASH are both turned off. 7. Some priority frequencies may be locked out.
Scanner won't work.	<ol style="list-style-type: none"> 1. Check the connections at both ends of the AC Adapter. 2. Turn ON the wall switch of your room. You could be using an outlet controlled by the wall switch. 3. Move the AC Adapter to another wall outlet.
Improper reception.	<ol style="list-style-type: none"> 1. Check the antenna connection. 2. Move the scanner. 3. You may be in a remote area which could require an optional multi-band antenna. Check with your dealer or local electronics store.
Scan won't stop.	<ol style="list-style-type: none"> 1. Adjust squelch threshold - refer to page 15, "Setting the Squelch". 2. Check the antenna connection. 3. Check to see if many of the channels are Locked Out. If so, the scanner has less chance of finding an active channel. 4. Review each channel's frequency to see if it is still stored in Memory and is correct. 5. It's possible that none of the programmed frequencies are currently active.
Scan won't start.	<ol style="list-style-type: none"> 1. Press PVT/HWT key again. 2. Adjust the SQL control. 3. Check to see if all channels are Locked Out.
Weather Scan won't work.	<ol style="list-style-type: none"> 1. Adjust squelch threshold - refer to page 15, "Setting the Squelch". 2. Check the antenna.
Radio transmissions (conversations) are cutting in and out in Highway mode.	<ol style="list-style-type: none"> 1. The priority system is checking for alarms. Use HOLD/RESUME to hold on a frequency without checking priority channels every two seconds. 2. Select Priority off mode or Priority only mode.

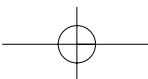

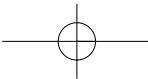

If you experience difficulty while in TrunkTracker mode, try the following steps.

Problem	Suggestion
Scanner won't track.	<ol style="list-style-type: none"> 1. Missing the Data Frequency. 2. Change to a Type 1 Scanner setup. Review Fleet Map Programming on page 45.
Scanner won't stop during Scan List mode.	<ol style="list-style-type: none"> 1. No IDs have been programmed. 2. The IDs you have stored are not active.
Scanner will not acquire data channel.	<ol style="list-style-type: none"> 1. Adjust the squelch for Trunking mode - refer to page 29. 2. Missing the frequency used for the data channel. Check your frequency list.
Missing replies to conversations.	<ol style="list-style-type: none"> 1. Change a Type 1 scanner setup. Review Fleet Map Programming on page 44. 2. Try another Preset Fleet Map or Program your own Fleet Map. 3. Check to see that all of the system's frequencies have been entered.
Channel Activity Indicators are flashing but no sound is heard.	<ol style="list-style-type: none"> 1. May be a telephone interconnect call, which are intentionally blocked by your scanner. 2. The ID on your display is not active.
Scanner not tracking an EDACS system properly.	<ol style="list-style-type: none"> 1. Logical channel numbers (frequencies) for the system are not programmed in the correct order. Check frequency resources and reprogram. 2. Not all frequencies for the system are programmed. Check frequency resources.

If you still cannot get satisfactory results while using your scanner or if you want additional information, please call or write the Uniden Parts and Service Division. The address and phone number is listed in the warranty at the end of this manual. If you would like immediate assistance, please call Customer Service at (800)297-1023.

If you have internet access, you can visit **scanner.uniden.com** for additional information.

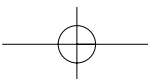

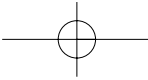

Specifications

Certified in accordance with FCC Rules and Regulations Part 15, Subpart C, as of date of manufacture.

- Channel: 250
- Banks: 5 (50 channels each)
- Service Bands: 9 preprogrammed search bands
(including the NOAA and Canada Weather Service band)
- Frequency Range: 25.0-28.0 MHz Petroleum Prod., CB Class D channels,
Business and Forest Products
- 28.0-29.7 MHz 10 Meter Amateur Band
- 29.7-50.0 MHz VHF Low Band
- 50.0-54.0 MHz 6 Meter Amateur Band
- 108-137 MHz Aircraft Band
- 137-144 MHz Military Land Mobile
- 144-148 MHz 2 Meter Amateur Band
- 148-174 MHz VHF High Band
- 400-420 MHz Federal Government
- 420-450 MHz 70 cm Amateur Band
- 450-470 MHz UHF Standard Band
- 470-512 MHz UHF T Band
- 806-956 MHz 800 Band
- Operating Temperature: -20 °C to +60 °C (-4 °F to +140)
- Scan Rate: 100 channels per second (conventional mode)
- Search Rate: 100 steps per second (Normal Search)
300 steps per second (Turbo Search)
- Audio Output: Maximum 2.6W (2.2W normal @ 10% THD)
- Internal Speaker: 8 ohms (57 mm outer diameter)
- Power Requirements: AD140U AC Adapter (12V DC, 500mA)
- Antenna: Telescopic Antenna (included)
Window Mount Antenna (included)
- Antenna Jack: BNC type
- External Jacks: External Speaker (EXT.SP.) (3.5 mm)
DC 12 V Power Jack, (center is positive)
Remote Control (REMOTE) Jack (DB-9)
- Size: 7.06 in. (W) x 6.10 in. (D) x 2.44 in. (H)
176.5mm (W) x 152.5mm (D) x 50.8mm (H)
- Weight: 1.1 kg (38.8 oz.)

Features and specifications are all subject to change without notice.

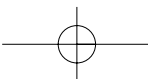

Appendix

State Cord Order

NO.	Code	State Name	NO.	Code	State Name
1	AK	Alasaka	33	NB	Nevada
2	AL	Alabama	34	NY	New York
3	AR	Arkansas	35	OH	Ohio
4	AZ	Arizona	36	OK	Oklahoma
5	CA	California	37	OR	Oregon
6	CO	Colorado	38	PA	Pennsylvania
7	CT	Connecticut	39	RI	Rhode Island
8	DC	District of Columbia	40	SC	South Carolina
9	DE	Delaware	41	SD	South Dakota
10	FL	Florida	42	TN	Tennessee
11	GA	Georgia	43	TX	Texas
12	IA	Iowa	44	UT	Utah
13	ID	Idaho	45	VA	Virginia
14	IL	Illinois	46	VT	Vermont
15	IN	Indiana	47	WA	Washington
16	KS	Kansas	48	WI	Wisconsin
17	KY	Kentucky	49	WV	West Virginia
18	LA	Louisiana	50	WY	Wyoming
19	MA	Massachusetts	51		
20	MD	Maryland	52		
21	ME	Maine	53		
22	MI	Michigan	54		
23	MN	Minnesota	55		
24	MO	Missouri	56		
25	MS	Mississippi	57		
26	MT	Montana	58		
27	NC	Noth Carolina	59		
28	ND	North Dakota	60		
29	NE	Nebraska	61		
30	NH	New Hampshire	62		
31	NJ	New Jersey	63		
32	NM	New Mexico	64		

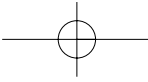

Preset Fleet Maps

E1P1

Block	Size Code
0	SIZE CODE 11
1	SIZE CODE 11
2	SIZE CODE 11
3	SIZE CODE 11
4	SIZE CODE 11
5	SIZE CODE 11
6	SIZE CODE 11
7	SIZE CODE 11

E1E2

Block	Size Code
0	SIZE CODE 4
1	SIZE CODE 4
2	SIZE CODE 4
3	SIZE CODE 4
4	SIZE CODE 4
5	SIZE CODE 4
6	SIZE CODE 4
7	SIZE CODE 4

E1P3

Block	Size Code
0	SIZE CODE 4
1	SIZE CODE 4
2	SIZE CODE 4
3	SIZE CODE 4
4	SIZE CODE 4
5	SIZE CODE 4
6	SIZE CODE 12
7	(SIZE CODE 12)

E1P4

Block	Size Code
0	SIZE CODE 12
1	(SIZE CODE 12)
2	SIZE CODE 4
3	SIZE CODE 4
4	SIZE CODE 4
5	SIZE CODE 4
6	SIZE CODE 4
7	SIZE CODE 4

E1P5

Block	Size Code
0	SIZE CODE 4
1	SIZE CODE 4
2	SIZE CODE 12
3	(SIZE CODE 12)
4	SIZE CODE 4
5	SIZE CODE 4
6	SIZE CODE 4
7	SIZE CODE 4

E1P6

Block	Size Code
0	SIZE CODE 3
1	SIZE CODE 10
2	SIZE CODE 4
3	SIZE CODE 4
4	SIZE CODE 12
5	(SIZE CODE 12)
6	SIZE CODE 12
7	(SIZE CODE 12)

E1P7

Block	Size Code
0	SIZE CODE 10
1	SIZE CODE 10
2	SIZE CODE 11
3	SIZE CODE 4
4	SIZE CODE 4
5	SIZE CODE 4
6	SIZE CODE 4
7	SIZE CODE 4

E1P8

Block	Size Code
0	SIZE CODE 1
1	SIZE CODE 1
2	SIZE CODE 2
3	SIZE CODE 2
4	SIZE CODE 3
5	SIZE CODE 3
6	SIZE CODE 4
7	SIZE CODE 4

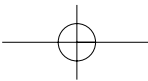
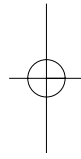
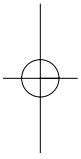

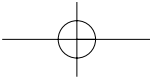

E1P9

Block	Size Code
0	SIZE CODE 4
1	SIZE CODE 4
2	SIZE CODE 0
3	SIZE CODE 0
4	SIZE CODE 0
5	SIZE CODE 0
6	SIZE CODE 0
7	SIZE CODE 0

E1P10

Block	Size Code
0	SIZE CODE 0
1	SIZE CODE 0
2	SIZE CODE 0
3	SIZE CODE 0
4	SIZE CODE 0
5	SIZE CODE 0
6	SIZE CODE 4
7	SIZE CODE 4

E1P11

Block	Size Code
0	SIZE CODE 4
1	SIZE CODE 0
2	SIZE CODE 0
3	SIZE CODE 0
4	SIZE CODE 0
5	SIZE CODE 0
6	SIZE CODE 0
7	SIZE CODE 0

E1P12

Block	Size Code
0	SIZE CODE 0
1	SIZE CODE 0
2	SIZE CODE 0
3	SIZE CODE 0
4	SIZE CODE 0
5	SIZE CODE 0
6	SIZE CODE 0
7	SIZE CODE 4

E1P13

Block	Size Code
0	SIZE CODE 3
1	SIZE CODE 3
2	SIZE CODE 11
3	SIZE CODE 4
4	SIZE CODE 4
5	SIZE CODE 0
6	SIZE CODE 0
7	SIZE CODE 0

E1P14

Block	Size Code
0	SIZE CODE 4
1	SIZE CODE 3
2	SIZE CODE 10
3	SIZE CODE 4
4	SIZE CODE 4
5	SIZE CODE 4
6	SIZE CODE 12
7	(SIZE CODE 12)

E1P15

Block	Size Code
0	SIZE CODE 4
1	SIZE CODE 4
2	SIZE CODE 4
3	SIZE CODE 11
4	SIZE CODE 11
5	SIZE CODE 0
6	SIZE CODE 12
7	(SIZE CODE 12)

E1P16

Block	Size Code
0	SIZE CODE 3
1	SIZE CODE 10
2	SIZE CODE 10
3	SIZE CODE 11
4	SIZE CODE 0
5	SIZE CODE 0
6	SIZE CODE 12
7	(SIZE CODE 12)

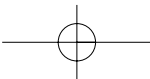

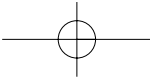

User Defined Fleet Maps

Type I Programming Information

When a Type I system is designed, the address information for all the IDs are divided into 8 equal sized blocks. When you program your scanner to track a Type I system, you must select a size code for each of these blocks. When you have assigned a size code to all 8 blocks, you have defined the Fleet Map for the system you're tracking. Each size code determines the number of Fleets, Subfleets, and IDs each block will have. For example, a size code of "4" has one Fleet, which is divided into 16 separate Subfleets, and it has a total of 512 individual IDs.

When a block is assigned a size code, the Fleet or Fleets created within the block are assigned a Type I ID. The way these IDs display on your scanner depends on the block number and the blocks size code. When a Type I ID displays, the left most digit represents the block which contains the ID. The next two or three digits identify which Fleet is active, and the last digit(s) identifies the Subfleet.

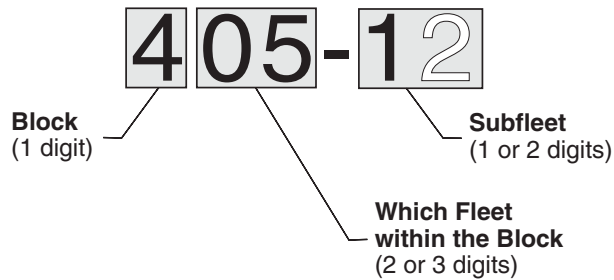

Your task is to program your fleet map with the same size code assignments as the trunked system. If you do this accurately, you'll track all the Fleet-Subfleet combinations used by the system. In other words, you'll hear complete communications while monitoring a trunked system.

If you don't already know the size codes used, you'll have to guess at them. But since you don't have to figure out all the blocks at once, this isn't as hard as it seems. Select a size code for a block, and then press **SRCH**. Now listen to the communications. If you decide you are receiving most of the replies to the conversations with IDs assigned to the block you just programmed, then you've probably selected the right size code and can work on the next block of the map.

Finally, for most public safety systems there are some size codes which are more common. SIZE CODE 3 and SIZE CODE 4 are probably the most common, followed by SIZE CODE 10, SIZE CODE 11, and SIZE CODE 12.

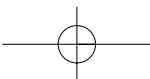

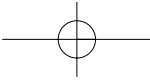

Fleet Map Size Codes

Size	Fleets	Subfleets	IDs	Blocks Used
0	Reserves block for Type II IDs			
1	128	4	16	1
2	16	8	64	1
3	8	8	128	1
4	1	16	512	1
5	64	4	32	1
6	32	8	32	1
7	32	4	64	1
8	16	4	128	1
9	8	4	256	1
10	4	8	256	1
11	2	16	256	1
12	1	16	1024	2
13	1	16	2048	4
14	1	16	4096	8

Size Code Restrictions

If you select SIZE CODE 12, 13, or 14, there are some restrictions as to which blocks can be used for these codes.

- SIZE CODE 12 can only be assigned to Blocks 0, 2, 4, or 6.
- SIZE CODE 13 can only be assigned to Blocks 0 and 4.
- SIZE CODE 14 can only be assigned to Block 0.

Since these SIZE CODES require multiple blocks, you will be prompted for the next available block when programming a Fleet Map. For example, if you assign Block 0 as an SIZE CODE 12, you will be prompted for Block 2, the next block available, instead of Block 1. And if you assign Block 0 as SIZE CODE 14, you would not see another prompt because all available blocks have been used.

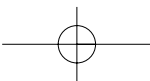

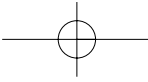

One Year Limited Warranty

Important: Evidence of original purchase is required for warranty service.

WARRANTOR: UNIDEN AMERICA CORPORATION (Uniden)

ELEMENTS OF WARRANTY: Uniden warrants, for one year, to the original retail owner, this Uniden product to be free from defects in materials and craftsmanship with only the limitations or exclusions set out below.

WARRANTY DURATION: This warranty to the original user shall terminate and be of no further effect 12 months after the date of original retail sale. The warranty is invalid if the Product is (A) damaged or not maintained as reasonable or necessary, (B) modified, altered, or used as part of any conversion kits, subassemblies, or any configurations not sold by Uniden, (C) improperly installed, (D) serviced or repaired by someone other than an authorized Uniden service center for a defect or malfunction covered by this warranty, (E) used in any conjunction with equipment or parts or as part of any system not manufactured by Uniden, or (F) installed or programmed by anyone other than as detailed by the owners manual for this product.

STATEMENT OF REMEDY: In the event that the product does not conform to this warranty at any time while this warranty is in effect, warrantor will either, at its option, repair or replace the defective unit and return it to you without charge for parts, service, or any other cost (except shipping and handling) incurred by warrantor or its representatives in connection with the performance of this warranty. Warrantor, at its option, may replace the unit with a new or refurbished unit. THE LIMITED WARRANTY SET FORTH ABOVE IS THE SOLE AND ENTIRE WARRANTY PERTAINING TO THE PRODUCT AND IS IN LIEU OF AND EXCLUDES ALL OTHER WARRANTIES OF ANY NATURE WHATSOEVER, WHETHER EXPRESS, IMPLIED OR ARISING BY OPERATION OF LAW INCLUDING, BUT NOT LIMITED TO ANY IMPLIED WARRANTIES OF MERCHANTABILITY OR FITNESS FOR A PARTICULAR PURPOSE. THIS WARRANTY DOES NOT COVER OR PROVIDE FOR THE REIMBURSEMENT OR PAYMENT OF INCIDENTAL OR CONSEQUENTIAL DAMAGES. Some states do not allow this exclusion or limitation of incidental or consequential damages so the above limitation or exclusion may not apply to you.

LEGAL REMEDIES: This warranty gives you specific legal rights, and you may also have other rights which vary from state to state. This warranty is void outside the United States of America.

PROCEDURE FOR OBTAINING PERFORMANCE OF WARRANTY: If, after following the instructions in the owners manual you are certain that the product is defective, pack the Product carefully (preferably in its original packaging). The product should include all parts and accessories originally packaged with the Product. Include evidence of original purchase and a note describing the defect that has caused you to return it. The Product should be shipped freight prepaid, by traceable means, to warrantor at:

UNIDEN AMERICA CORPORATION
Parts and Service Division
4700 Amon Carter Boulevard
Fort Worth, TX 76155
(800) 554-3988, 7 a.m. to 5 p.m. Central Time, Monday through Friday

