

Uniden®

OWNER'S MANUAL



UNIDEN Model UH037
UHF CB Radio

Contents

Contents	1
Introduction / Features.....	2
Getting Started.....	3
Installing the Batteries.....	4
Installing the Belt Clip.....	5
Operation.....	6
Power ON / OFF.....	6
Volume.....	6
Selecting a Channel.....	6
Transmitting and Receiving.....	6
Operating in Duplex Mode	7
Power Save	7
Battery Level Indicator	7
Monitor Mode	7
UHF Channels & Frequencies	8
Warranty	9

Introduction

The UH037 is a portable, two way UHF-CB radio. It is compact, rugged and fits easily into your hand. This hand held UHF radio will give you consistent, outstanding performance in virtually all conditions and situations. To ensure that you get the most from your UH037's features, please read this owners manual carefully before using the unit.

Warning - NOT Waterproof!

Uniden does not represent this unit to be waterproof. Do not expose this unit to rain or moisture.

Features

- 40 Channels
- 500mW Output Power
- Up to 3Km range*
- LCD Display
- Open Scan
- Duplex Capability
- Monitor
- LCD Back Light (Auto On for 5 seconds)
- Auto Power Save
- Battery Level Indicator

*Range varies depending on the environment. 3km range is noted in a flat, open environment.

Getting Started

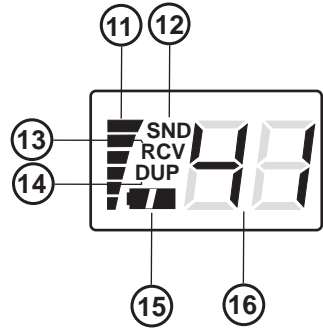
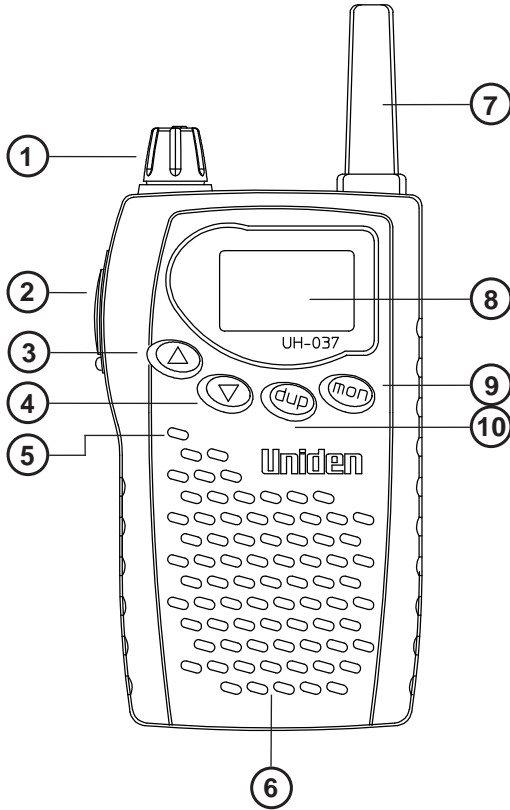

- ① On / Off and Volume Knob
- ② PTT Button
- ③ Channel Button - Up
- ④ Channel Button - Down
- ⑤ Microphone
- ⑥ Speaker
- ⑦ Antenna
- ⑧ LCD Display Screen
- ⑨ Monitor Button
- ⑩ DUP Button
- ⑪ Transmit Indicator & Receive Indicator
- ⑫ Sending Transmission
- ⑬ Receiving Transmission
- ⑭ Duplex Transmit
- ⑮ Battery Level Indicator
- ⑯ Channel Numbers

Getting Started

Installing the Batteries

Your UH037 radio uses 3 AAA Alkaline batteries for power.

To install the batteries:

1. Make sure your radio is OFF.

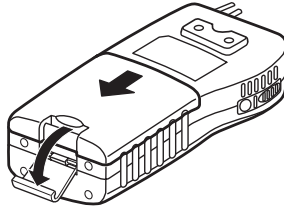

2. Release the battery clip, then remove the battery cover.

3. Insert 3 AAA alkaline batteries according to polarity symbols inside the battery compartment.

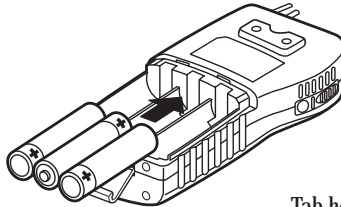

4. Align the battery cover with the UH037 tab holes, then replace the cover.

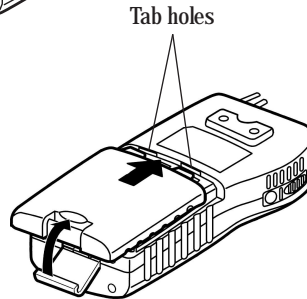

NOTE

To avoid damage to the radio, DO NOT mix old and new batteries.

NOTE

Batteries are not included with your UH037 package.

Low Battery Alert

The LCD on your radio shows a battery meter in the lower right-hand corner.  icon indicates the batteries are fully charged.

When the batteries are low the  icon is reduced and will flash.

When the batteries in the UH037 are low, the radio will enter a Battery Low / Sleep Mode. Transmit Mode is disabled. To continue using the radio, replace the batteries immediately.

Getting Started

Belt Clip

The UH037 is equipped with a belt clip to securely fasten the unit to your belt or purse.

To remove the belt clip:

1. Turn the screws counter clockwise.

To attach the belt clip:

1. Insert the belt clip screws into the slots on the belt clip.
2. Align the screws with the holes on the back of the radio and screw clockwise to secure the belt clip.

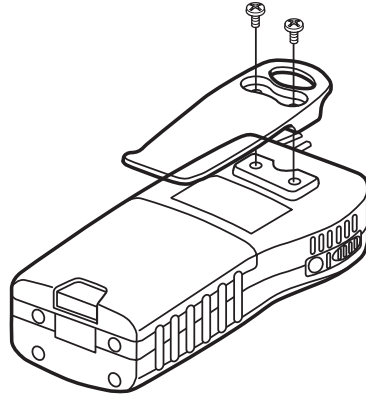

NOTE

Do not over-tighten the screws.

Operation

**NOTE**

When you press any button (except PTT or MON), a short tone is heard.

Power ON / OFF

To turn the UH037 ON, rotate the ON/OFF VOL knob counter clockwise until it clicks. A channel number 05 plus the battery level icon will be displayed on the screen.

To turn the UH037 OFF, rotate the ON/OFF VOL knob counter-clockwise until it clicks. The screen display will disappear.

Volume



To alter the volume of your UH037:

1. Turn the ON/OFF VOL control knob clockwise to increase the volume.
Turn counter clockwise to decrease the volume.

Selecting a Channel

Press the  or  buttons to select the desired channel.

**NOTE**

If you press and hold the  or  buttons the channel numbers will scroll rapidly.

To Transmit and Receive

The UH037 uses the 40 UHF-CB channels. For your reference a list of available channels and corresponding frequencies is printed on Page 7 of this manual.

1. The maximum RF transmit power for the UH037 is 500mWatts.
2. Before you transmit, listen for activity on the selected channel.
3. When the channel is clear, press and hold the **PTT** button to transmit. SND is displayed on the screen and the Tx level indicator scrolls up.
4. When you have finished speaking, release the **PTT** button to listen for a response. The SND icon disappears from the screen. RCV is displayed when a transmission is being received and the Rx level indicator scrolls down.

**NOTE**

Hold the microphone approximately 50mm in front of your mouth with the antenna at approximately 45 degrees away from your head. Speak in a clear, normal conversational voice.

Operation

To Operate in Duplex Mode

For example: If channel 01 is being used in your area for repeater use.

1. Press the **(DUP)** button momentarily. The DUP icon is displayed.
2. Press **(DUP)** again to deactivate the Duplex operation. The UH037 will return to Simplex Mode.

Power Save

The Battery Save feature extends the battery life by switching the required circuit power ON and OFF. This feature automatically activates Standby Mode (RX Mode without signal). It turns OFF automatically when a signal is present and activates again after a channel is inactive.

Back lighting

The liquid crystal display (LCD) and function buttons are backlit for viewing in low light situations. The back lighting switches ON for 5 seconds when any button (except PTT) is pressed.

Battery Level Indicator



The  icon in the bottom left-hand corner of the screen, indicates the UH037's current battery voltage level at all times.

NOTE When the battery level icon blinks -  , the battery is low and needs replacing.
When the **(PTT)** button is pressed an error tone is heard and the channel number flashes on the screen.

Monitor Mode

This feature enables users to listen in for weak signals on the current channel at the press of a button.

To use monitor:

1. For brief listening, press **(MON)**
2. For continuous listening, press and hold **(MON)** for 2 seconds.
A two tone beep will be heard and the receiver signal will stay open letting in both the noise and weak signals.
3. The screen displays RCV.
4. To return to Normal Receive Mode, press **(MON)** or  or  once.

UHF Channels & Frequencies

UHF - CB Frequency List - Australia & New Zealand

CH No.	Frequency (MHz)	Usage	CH No.	Frequency (MHz)	Usage
01	476.425	Simplex/Duplex	21	476.925	Simplex
02	476.450	Simplex/Duplex	22	476.950	Simplex
03	476.475	Simplex/Duplex	23	476.975	Simplex
04	476.500	Simplex/Duplex	24	477.000	Simplex
05	476.525	Simplex/Duplex	25	477.025	Simplex
06	476.550	Simplex/Duplex	26	477.050	Simplex
07	476.575	Simplex/Duplex	27	477.075	Simplex
08	476.600	Simplex/Duplex	28	477.100	Simplex
09	476.625	Repeater	29	477.125	Simplex
10	476.650	Repeater	30	477.150	Simplex
11	476.675	Emergency	31	477.175	Simplex
12	476.700	Repeater	32	477.200	Simplex
13	476.725	Repeater	33	477.225	Simplex
14	476.750	Repeater	34	477.250	Simplex
15	476.775	Repeater	35	477.275	Simplex
16	476.800	Repeater	36	477.300	Simplex
17	476.825	Repeater	37	477.325	Simplex
18	476.850	Repeater	38	477.350	Simplex
19	476.875	Repeater	39	477.375	Simplex
20	476.900	Repeater	40	477.400	Simplex

NOTE: Channel 11 is a Backup Emergency Channel for both Simplex and Duplex.
Please do not use this Channel for Non-emergency calling.

Warranty

One Year Limited Warranty

Important: Evidence of original purchase is required for warranty service.

Warrantor: Uniden Australia Pty Limited A.B.N. 58 001 865 498
Uniden New Zealand Limited

ELEMENT OF WARRANTY: Uniden warrants to the original retail owner for the duration of this warranty, its UH037 (herein after referred to as the Product), to be free from defects in materials and craftsmanship with only the limitations or exclusions set out below.

WARRANTY DURATION: This warranty to the original retail owner only, shall terminate and be of no further effect 12 months after the date of original retail sale. This warranty will be deemed invalid if the product is; (A) Damaged or not maintained as reasonable and necessary, (B) Modified, altered or used as part of any conversion kits, subassemblies or any configurations not sold by Uniden, (C) Improperly installed, (D) Repaired by someone other than an authorised Uniden Repair Agent for a defect or malfunction covered by this warranty, (E) Used in conjunction with any equipment or parts or as part of a system not manufactured by Uniden. (F) Only available in the original country of sale.

PARTS COVERED: This warranty covers for one (1) year, the UH037 transceiver only. All accessories (Belt Clip etc.) are covered for 90 days only.

STATEMENT OF REMEDY: In the event that the product does not conform to this warranty at any time while this warranty is in effect, the warrantor at its discretion, will repair the defect or replace the product and return it to you without charge for parts or service. **THIS WARRANTY DOES NOT COVER OR PROVIDE FOR THE REIMBURSEMENT OR PAYMENT OF INCIDENTAL OR CONSEQUENTIAL DAMAGES. THIS GUARANTEE IS IN ADDITION TO AND DOES NOT IN ANY WAY AFFECT YOUR RIGHTS UNDER THE CONSUMER**

PROCEDURE FOR OBTAINING PERFORMANCE OR

WARRANTY: In the event that the product does not conform to this warranty, the Product should be shipped or delivered, freight pre-paid, with evidence of original purchase (eg. a copy of the sales docket), to the warrantor at:

UNIDEN AUSTRALIA PTY LIMITED
SERVICE DIVISION
345 Princes Highway,
Rockdale NSW 2216
Ph (02) 9599 3577 Fx (02) 9599 3278
Toll Free 1300 366 895

www.uniden.com.au

UNIDEN NEW ZEALAND LIMITED
SERVICE DIVISION
150 Harris Road,
East Tamaki, Auckland
Ph (09) 273 8383 Fx (09) 274 4253
Toll Free 0800 4 UNIDEN
(864 336)

www.uniden.co.nz

Customers in other States should ship or deliver the Product freight pre-paid to their Uniden Authorised Repair Centre. See Unidens Website for the nearest Repair Centre.

Uniden[®]

©2002 Uniden Australia Pty Limited / Uniden New Zealand Limited
Printed in the Philippines