

A Versatile Multi-Function Terminal

MT380-A6WE0G



User Manual

400628G Version 2.0



About This Manual

This manual explains how to install, operate and maintain the MT380 Versatile Multi-Function Terminal.

No part of this publication may be reproduced or used in any form, or by any electrical or mechanical means, without permission in writing from the manufacturer. This includes electronic or mechanical means, such as photocopying, recording, or information storage and retrieval systems. The material in this manual is subject to change without notice.

© Copyright 2009 Unitech Electronics Co., Ltd. All rights reserved.

Unitech TASHI Website: <http://www.unitech-sbd.com>

Unitech Global Website: <http://www.unitech-adc.com>



Microsoft, Windows and ActiveSync are either registered trademarks or trademarks of Microsoft Corporation. Other product names mentioned in this manual may be trademarks or registered trademarks of their respective companies and are hereby acknowledged.

Regulatory Compliance Statements

FCC Warning Statement

This equipment has been tested and found to comply with the limits for a Class B digital device, pursuant to part 15 of the FCC rules. These limits are designed to provide reasonable protection against harmful interference in a residential installation.

This equipment generates, uses and can radiate radio frequency energy and, if not installed and used in accordance with the instructions, may cause harmful interference to radio communications. However, there is no guarantee that interference will not occur in a particular installation. If this equipment does cause harmful interference to radio or television reception, which can be determined by turning the equipment off and on, the user is encouraged to try to correct the interference by one or more of the following measures:

- Reorient or relocate the receiving antenna.
 - Increase the separation between the equipment and receiver.
 - Connect the equipment into an outlet on a circuit different from that to which the receiver is connected.
 - Consult the dealer or an experienced radio/TV technician for help.
1. This Transmitter must not be co-located or operating in conjunction with any other antenna or transmitter.
 2. This equipment complies with FCC RF radiation exposure limits set forth for an uncontrolled environment. This equipment should be installed and operated with a minimum distance of 20 centimeters between the radiator and your body.
 3. Any changes or modifications (including the antennas) made to this device that are not expressly approved by the manufacturer may void the user's authority to operate the equipment.

This device complies with part 15 of the FCC Rules.

Operation is subject to the following two conditions:

- 1) this device may not cause interference and
- 2) this device must accept any interference, including interference that may cause undesired operation of the device.

Canadian Compliance Statement

This Class B Digital apparatus meets all requirements of the Canadian Interference-Causing Equipment Regulations.

Cet appareil numérique de la classe B respecte les exigences du Règlement sur le matériel brouilleur du Canada.

European Conformity Statement

Declaration of Conformity with Regard to the R&TTE 1999/5/EC and EMC 89/336/ EEC directives.

RoHS Statement



This device conforms to RoHS (Restriction of Hazardous Substances) European Union regulations that set maximum concentration limits on hazardous materials used in electrical and electronic equipment.

Taiwan NCC Warning Statement

根據 NCC 低功率電波輻射性電機管理辦法 規定：

第十二條 經型式認證合格之低功率射頻電機，非經許可，公司、商號或使用者均不得擅自變更頻率、加大功率或變更原設計之特性及功能。

第十四條 低功率射頻電機之使用不得影響飛航安全及干擾合法通信；經發現有干擾現象時，應立即停用，並改善至無干擾時方得繼續使用。

前項合法通信，指依電信法規定作業之無線電通信。

低功率射頻電機須忍受合法通信或工業、科學及醫療用電波輻射性電機設備之干擾。



Battery Notices

The MT380 is equipped with a Lithium-Ion battery pack. After extended storage periods, however, the unit may not start without an external power due to battery discharge. In this case connect the unit to the power cable and recharge the MT380 for about 12 hours to charge the battery to full capacity.

The battery supplies operational power to the MT380 for approximately one hour (depending on hardware configuration and with limited backlight use) or provides backup data for three days when there is no external power connected.

Battery Charge Notice

It is important to consider the environmental temperature whenever the Lithium-Ion battery pack is charged. Charging is most efficient at normal room temperature or in a slightly cooler environment. It is essential that batteries are charged within the stated range of 0°C to 50°C. Charging batteries outside of the specified range could damage the batteries and shorten their charging life cycle.

Storage and Safety Notice

Although charged Lithium-Ion batteries may be left unused for several months, their capacity may be depleted due to build up of internal resistance. If this happens they will require recharging prior to use. Lithium-Ion batteries may be stored at temperatures between -20°C to 70°C, however they may be depleted more rapidly at the higher temperature ranges. It is recommended to store batteries within normal room temperature ranges.

Warranty

The following items are covered under Unitech Limited Warranty:

- MT380 Versatile Multi-Function Terminal – 1-year limited warranty.
- Cables – three month limited warranty.
- Backup Battery – three month limited warranty.



Table of Contents

Preface

- About This Manual i
- Regulatory Compliance Statements i
- FCC Warning Statement i
- Canadian Compliance Statement ii
- European Conformity Statement ii
- RoHS Statement ii
- Taiwan NCC Warning Statement ii
- Notices iii
- Battery Charge Notice iii
- Storage and Safety Notice iii
- Warranty iii

Chapter 1w

- Getting Started 1
- Introducing MT380 1
- Features 1
- Setting up MT380 2
- Connecting Power 2
- Charging the Battery 2
- Turning MT380 on for the First Time 3
- Powering On 3
- Calibrating MT380 Screen 3
- Setting the Date and Time 3
- Utilizing Software 4

Chapter 2

- Using the Hardware 5
- Using the Keypad 5
- Using Windows CE Keyboard 5
- Entering Characters 6
- Entering Numerics 6
- Moving the Keyboard 6
- Closing the Keyboard 6
- Using the Stylus 7
- Using Proximity Reader 7
- Testing Proximity Card Verification 7
- Using the Finger Print Reader 10
- Testing Finger Print Verification 10
- Using the Camera 14
- Testing Imager 14
- Audio Demo Program 15

Chapter 3

- Data Communication 17
- Establishing USB Connection 17
- Establishing Device-PC Connection 17
- Serial Cable 17
- Ethernet Cable 17
- Establishing WiFi Connection 18

Using ActiveSync.....	19
Additional Capabilities.....	19
Requirements.....	19
Installing Microsoft ActiveSync.....	19
Connecting the Device to Your Computer.....	20
Setting up the Wireless Local Area Network Card.....	22
Obtaining an IP Address via DHCP Server.....	22
Specifying an IP Address.....	23
Chapter 4	
Power System.....	25
Charging the Backup Battery for the First Time.....	25
Checking the Battery Status.....	25
Extending Battery Life.....	26
Changing the Automatic Power Settings.....	26
Reducing CPU Speed.....	26
Adjusting the Backlight.....	27
Performing a Hardware Reset.....	28
Performing a Warm Start.....	28
Performing a Cold Start.....	29
Appendix A	
System Specification.....	30
Appendix B	
Worldwide Support.....	31

Getting Started

Introducing MT380

MT380 is a compact terminal device integrating intercom, security and home automation features, and communicates with central host security and T&A systems through standard Ethernet or WLAN networks. The built-in CMOS digital camera, microphone, and audio speaker provides complete area security with a small footprint.

MT380 features a variety of built-in readers including proximity and finger print identification. Powered by Windows CE.NET 5.0, MT380 package includes programming tools and support software for developing custom security and provides cost-efficient solution for diverse applications.

Features

Powerful system

- Microsoft Windows CE.NET 5.0 operating system
- Intel PXA270 processor with speeds up to 520MHz

System memory

- 128 MB SDRAM
- 64 MB Flash ROM

Display

- 3.5 inch QVGA TFT-LCD touch-sensitive screen
- 240 x 320 resolution

Multimedia

- 2.0 megapixel CMOS camera
- Audio output via 0.8/2-watt speaker
- Built-in microphone

Expansion slot

- SD memory slot

Finger print reader

- Verification time: 0.4 sec per template
- Capacity of fingerprint: up to 100 templates

Reader types

- EM, 125kHz
- HID, 125kHz
- Mifare, 13.56mHz

Wireless connectivity

- 802.11b/g via SDIO interface

Communication

- Full RS232 support
- Half RS232 support
- Half RS485 support
- USB v1.1 Host
- Relay outputs x 2
- Photo-coupler inputs x 2
- Ethernet with POE

Battery life

- Normal usage: 1 hours
- Charging time: 12 hours
- Embedded backup battery cell

User interface

- 17 hard keys
- Touch-sensitive screen with stylus

TASHI Middleware

- VoIP
- Video streaming
- Access control and time and attendant management

Software programming tools

- TAS SDK
- C#, VB.NET, C++

Setting up MT380

This section explains how to charge the battery and how to turn on MT380 for the first time.

Connecting Power

Follow these instructions to connect power to MT380.

NOTE: A UPS battery is used for normal operation when there is no main power. The battery also functions as a data backup battery. Therefore, data you enter may not be properly stored until the built-in backup battery has been adequately recharged.

1. Plug the adapter cable into the DC input jack of the terminal (1), then connect the adapter into an electrical outlet (2).

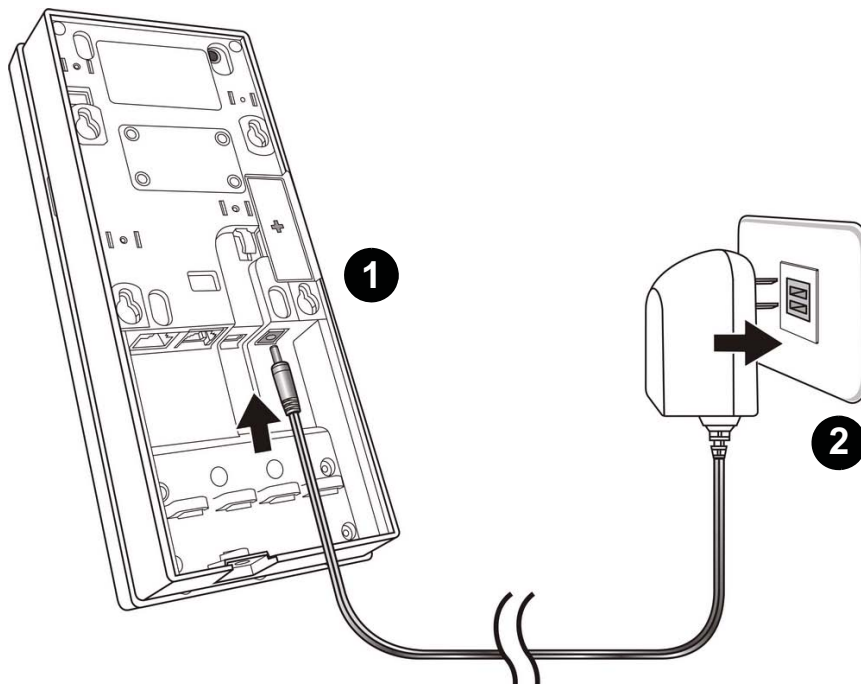

2. Turn on the backup battery by switching it left to charge the battery.

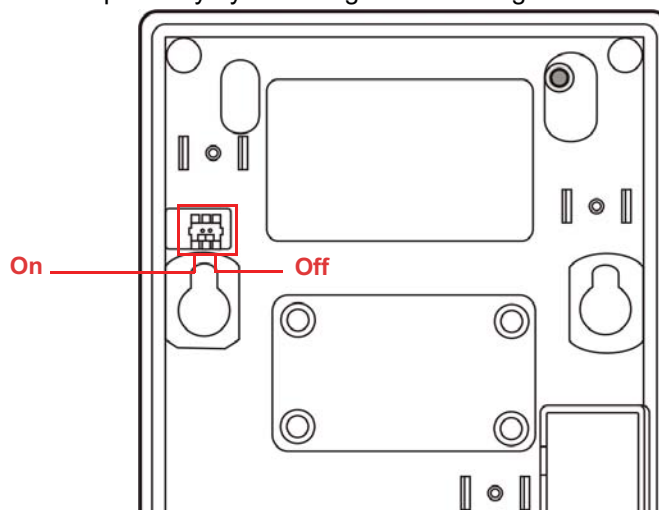

Charging the Battery

Before using MT380 for the first time, you need to charge it for about 12 hours. The battery begins charging as soon as you connect the power cable.

Turning MT380 on for the First Time

After you have initially charged your device for about 12 hours, the device is ready to be used. You can now start up your device where you'll calibrate the display, and set up the system time zone, date and time.

Powering On

MT380 automatically powers-on when the 12V DC power adapter is plugged-in. MT380 welcome screen appears followed by the Windows CE screen.

Calibrating MT380 Screen

The calibrate screen automatically appears when the unit is powered-on for the first time or after the system is reset.

MT380 prompts you to calibrate the unit by tapping a sequence of screen locations. Tap gently but firmly with the stylus.

When you have completed the series of taps, press the [F5]/[ENTER] key to confirm calibration or press the [F4]/[ESC] key to cancel it.

After confirming calibration, the Date/Time Properties screen appears prompting you to set the date and time.

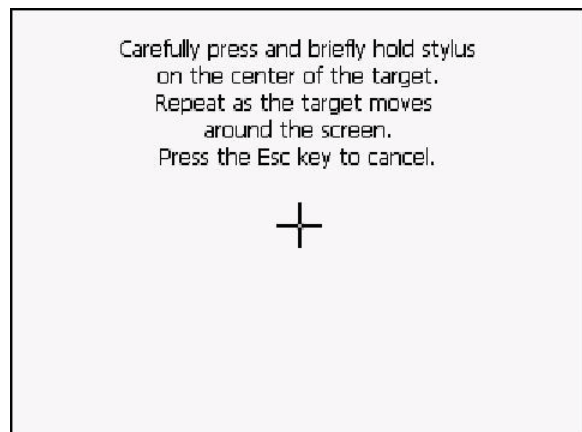

Setting the Date and Time

In the Date/Time Properties window, use the stylus to select the current date and time, time zone, and daylight saving time option.

- Tap the Left or Right arrows to scroll the year and month you desire or directly tap location of year or month to change the year or month setting.
- Tap on the Hr/Min/Sec AM/PM to input the Hr/Min/Sec to set the time.
- Tap the arrow and set the correct time zone from the drop-down list.
- Check the box to enable Windows to automatically adjust for daylight saving.
- Tap **OK** to save the settings and exit the Date/Time Properties dialog or tap **X** to exit without saving.

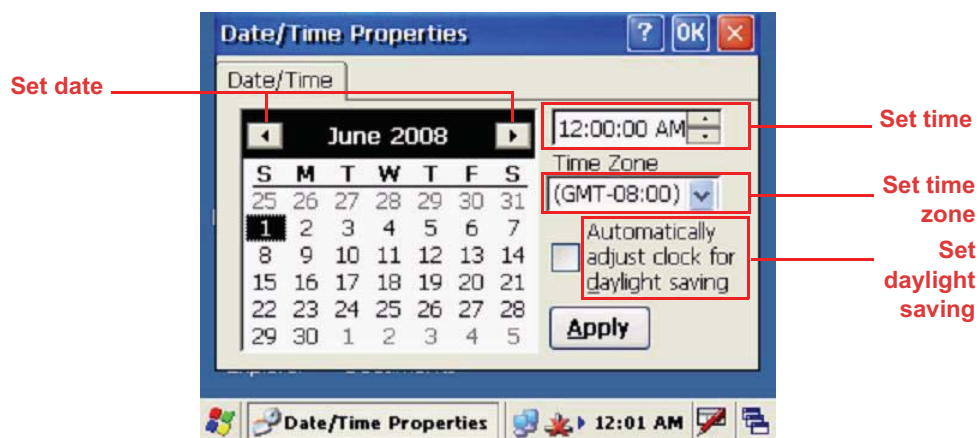

NOTE: To change the time and date at any time tap  → **Settings** → **Control Panel** → **Date/Time**.

Utilizing Software

Unitech MTTool is designed for technical engineers to set up MT380 and allows them easily to customize access control, attendance control, and manage function modules in a specified controller.

Compared with MTTool, JanitorLite serves for end-users to apply in a wide area of TASHI network. Refer to the comparison table below to find the best way working out your setup.

Software	MTTool (Free offer)	JanitorLite (Optional)
Target	Computer/ Software engineering	End user
Operation System	Windows on Computer (PC/ Notebook)	Windows on Computer (PC/ Notebook) Windows Mobile (WinCE) for MT380 T&A
Network	Stand-alone terminal	Terminals/ Controllers (as server)
Function	Setting/ debugging/ maintenance	Setting/ managing small to large scale TASHI networks
Model	MT180/ 380	MT180/ 380

If you find necessary to get MTTool, please contact regional sales representatives or technical support. For more details, please refer to MTTool User Manual and JanitorLite User Manual respectively.

Using the Hardware

Using the Keypad

MT380 contains five function keys and twelve numeric keys.



The following table describes the function keys.

Key	Main Function
	Menu [F1]: Function Key
	Clock-in [F2]: Function Key
	Clock-out [F3]: Function Key
	Break-in [F4]: Function Key, or [ESC]: Performs the same function as tapping the button on the touch screen.
	Break-out [F5]: Function Key, or [ENTER]: Enters a carriage return or executes a command.

Using Windows CE Keyboard

The Windows CE Software provides a touch screen keyboard for alphanumeric input. The Windows based keyboard replicates the layout of a standard PC keyboard.

Open the Windows CE keyboard by tapping the “keyboard” icon on the task bar and tapping Keyboard.



Keyboard icon

Entering Characters

Character input is the same as on a standard PC keyboard. Tap the on-screen button corresponding to the character you want to input.

International Character Support:

Tap the [âü] button to switch from the Standard English keyboard to the European keyboard or switch from the standard keyboard to perform the desired special characters.

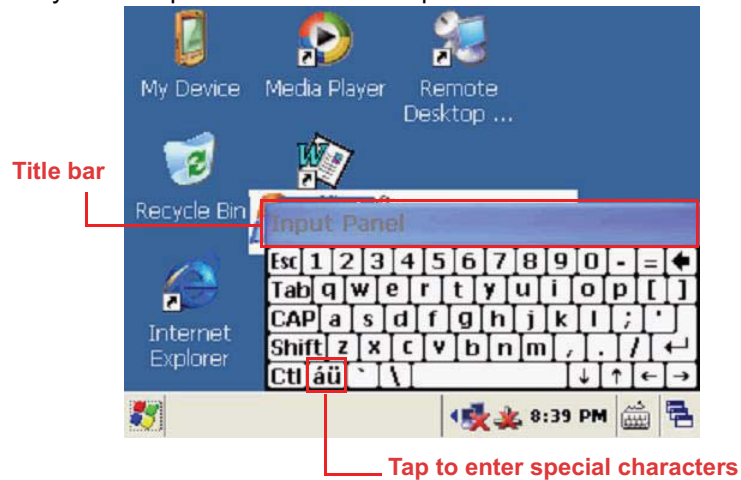

Entering Numerics

Open the Windows CE numeric keyboard by tapping the “keyboard” icon on the task bar and tapping Numeric Keyboard. Tap the on-screen button corresponding to the numeric you want to input.

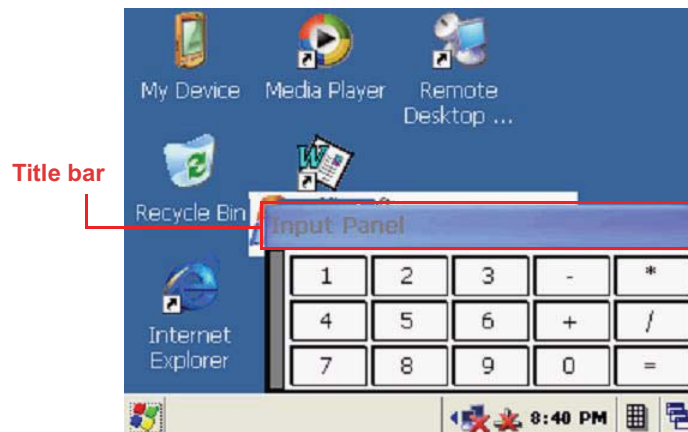

Moving the Keyboard

Tap the title bar and drag the keyboard to the desired location.

Closing the Keyboard

Tap the keyboard icon and tap Hide Input Panel to close Windows CE keyboard.

Using the Stylus

CAUTION! Never use anything other than MT380 stylus on the screen. Using an object other than the stylus could cause permanent damage.

1. Hold the stylus as you would hold a pencil.
2. To make a choice from a menu, lightly tap the tip of the stylus on that choice.
3. Double-tap to open programs.
4. To write data into a field on a form, use the stylus to print the letters or numbers.

Using Proximity Reader

MT380 features a standard proximity reader, which is compatible with all 125kHz EM, 125kHz HID, and 13.56MHz Mifare cards.

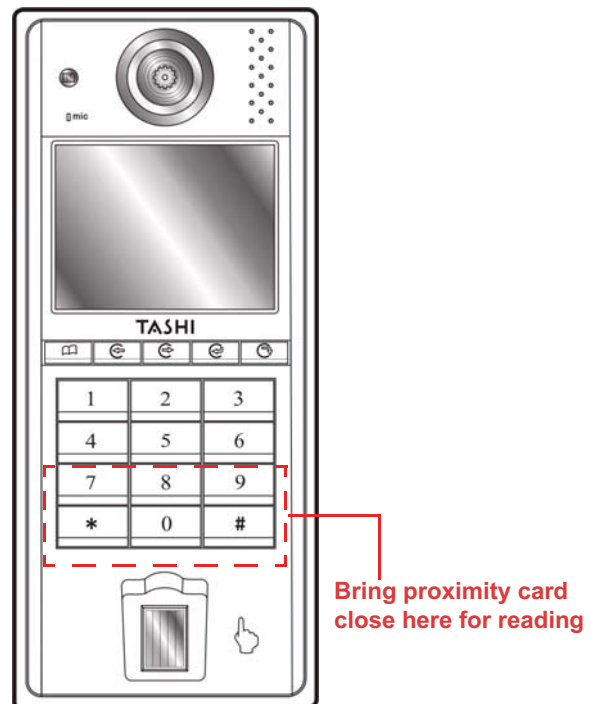

Testing Proximity Card Verification

MT380 has a built-in demo programs that enable users to make proximity card verification.

1. Double-tap the **My Device** icon on the Windows CE desktop.

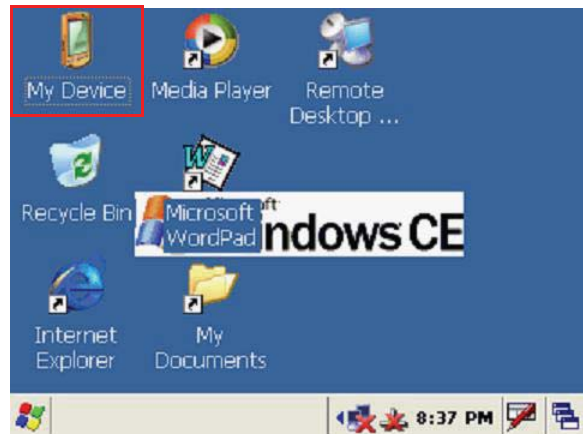

2. Double-tap the Flash Storage.

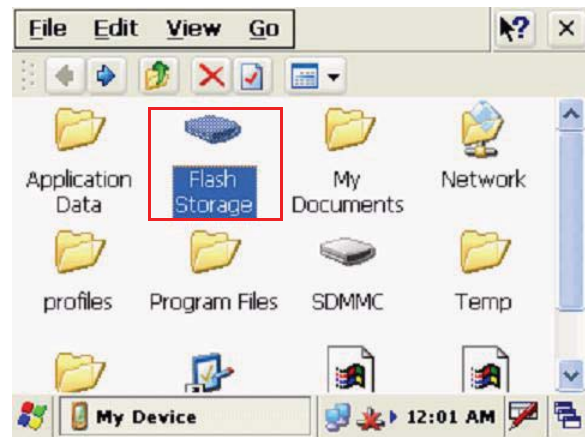

3. Double-tap MT380 Test AP.

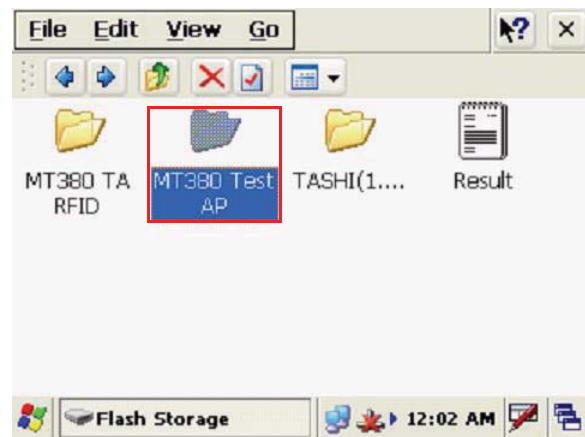

4. Double-tap the RFID test folder.

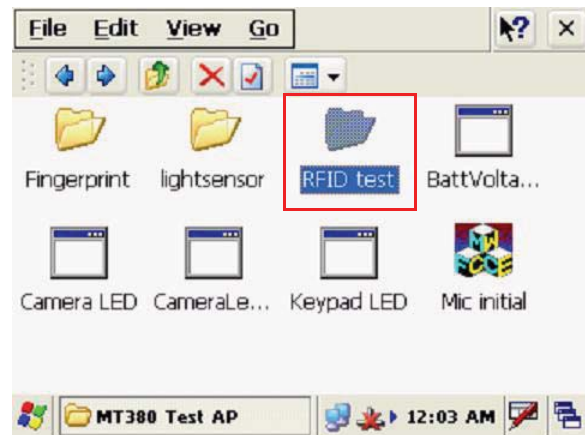

5. Double-tap the PDA_10 to open the demo program.

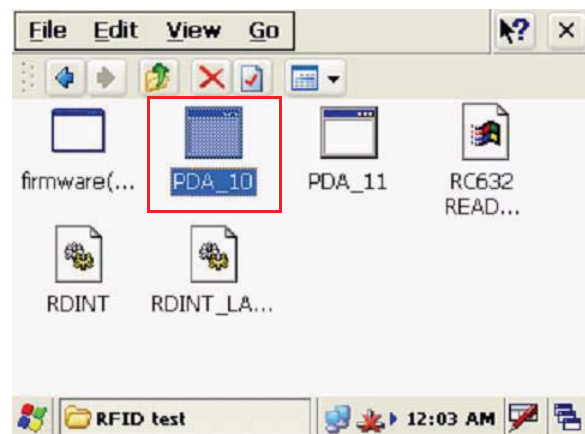

- Set the COM Port=2. Tap Connect.

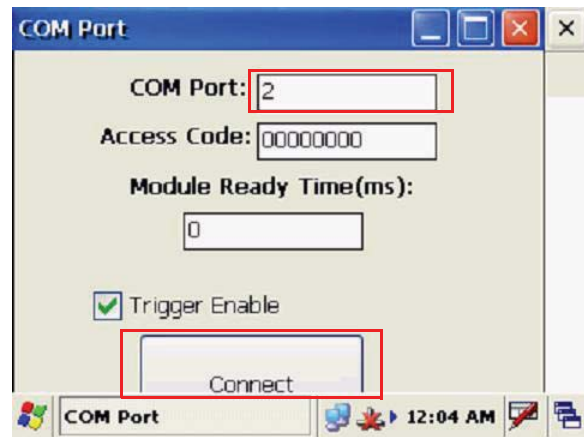

- Tap a card type to activate the demo program you want to test.

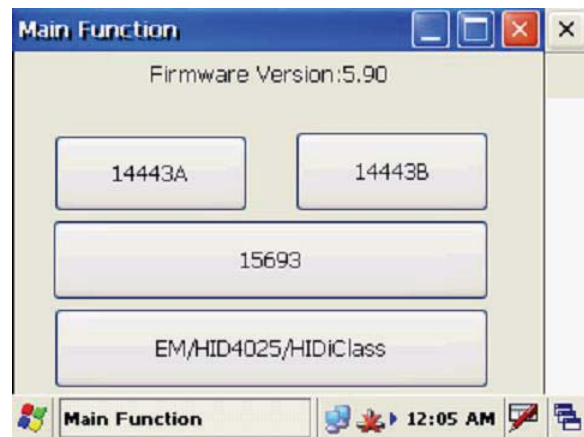

- Tap **Auto** and bring the proximity card close to the sensor. The code will be read and displayed on the field below.

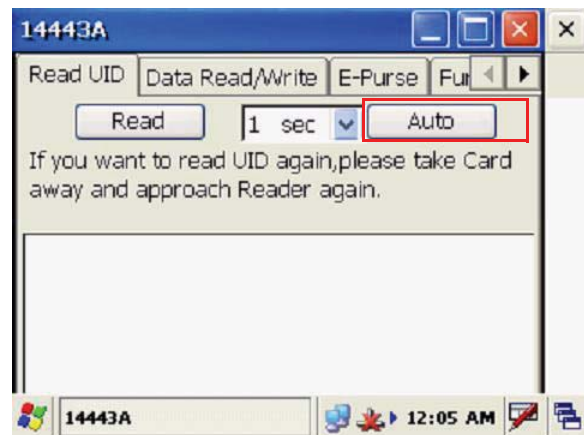

- Tap **Stop** to end reading.

Using the Finger Print Reader

MT380 has an optional integrated Finger Print reader that able to verify fingerprint in 0.4 seconds per template. The Finger Print Reader can store up to 100 templates.

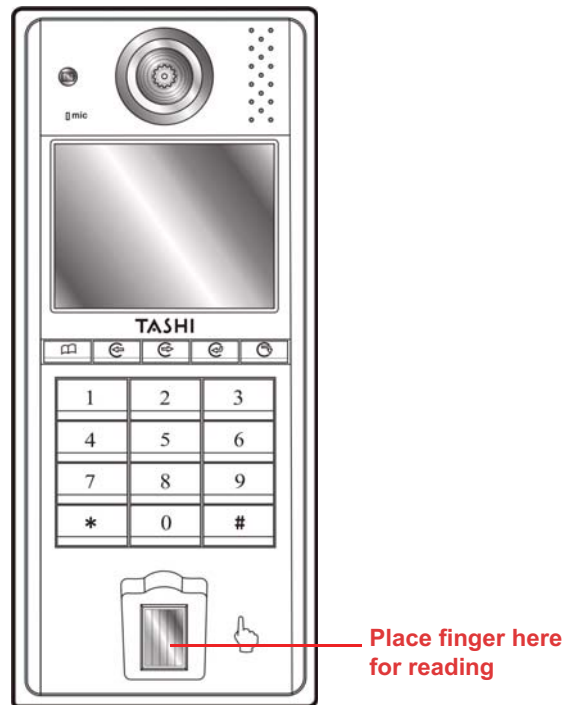

Testing Finger Print Verification

MT380 has a built-in BIO ID Manager programs that enable users to test finger print verification.

1. Double-tap the **My Device** icon on the Windows CE desktop.



2. Double-tap the Flash Storage.

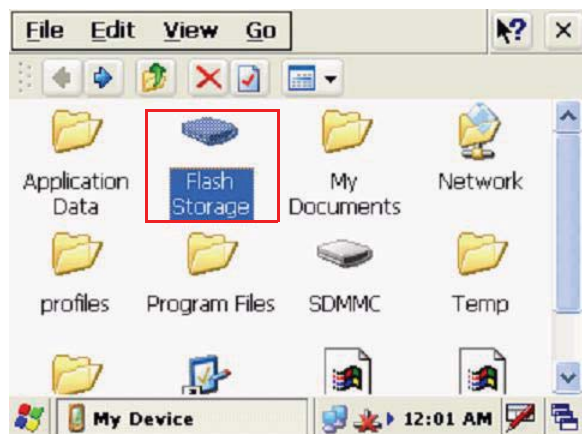

3. Double-tap MT380 Test AP folder.

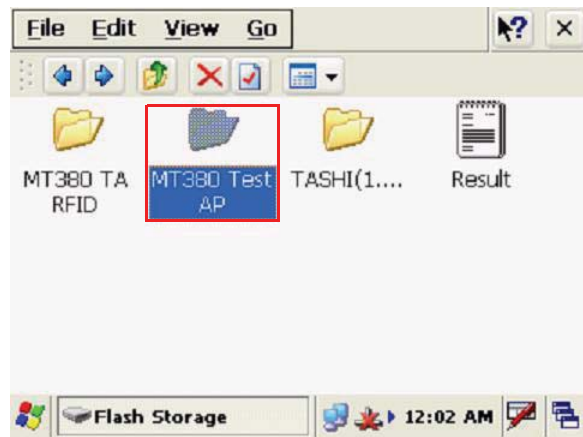

4. Double-tap the Fingerprint folder to open the demo program.

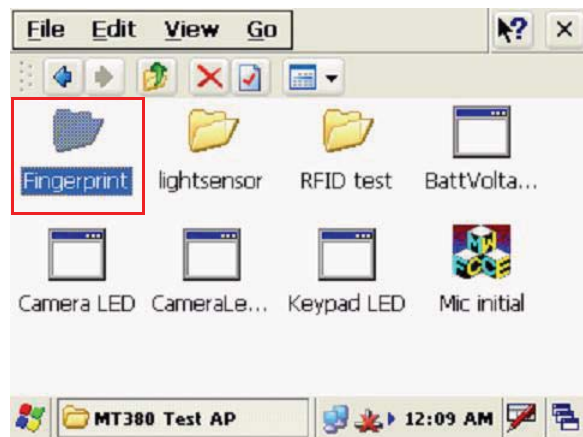

5. Double-tap the **BioIDMgr** to open the demo program.

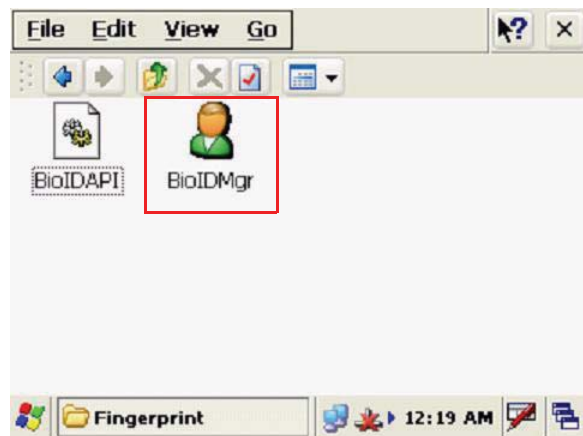

6. Tap **Open** to activate the program.



- Tap **Enroll** to input a new sample id for the fingerprint. For example, 123. Tap **OK**.



- Put finger on the sensor three times according to the message shown on screen.



- The finger print is enrolled into the program and displayed in the Slot-Id field.



- Select a finger print id and tap **Verify** to start verifying the finger print.

A pop-up window appears "Verify live finger with slot 0 id '123'?". Tap **Yes**.



11. Put finger on the sensor according to the message shown on screen.

A pop-up window appears with verification results: "Match" or "No match". Tap **OK**.

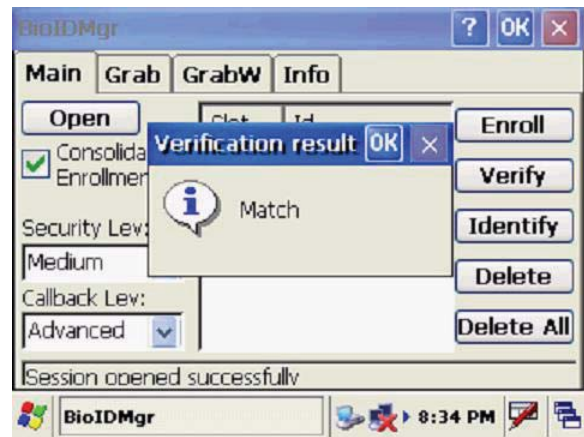

12. Tap **Identify** to find finger print id info.

Put finger on the sensor according to the message shown on screen.

A pop-up window appears with verification results: "Match found: slot 0 id '123'" or "No match". Tap **OK**.



13. Under the **Grab/GrabW** tab, tap **Grab/GrabWindow** to collect a finger print image.



14. Under the **Info** tab, tap **Get Module Info** to display the Finger Print module info.

Under the **Type** drop-down menu, select all, internal, or external, then tap **Get Available Memory** to display the Finger Print Reader's memory.

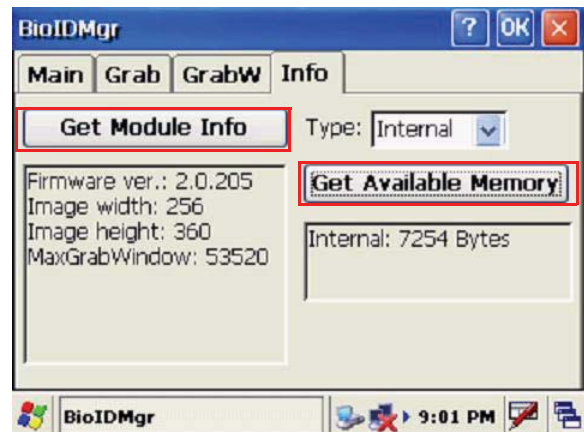

Using the Camera

MT380 has a built-in 2.0 megapixel camera which provides the following extra functionality:

- Enable users to capture still image when a card is being read
- Verify attendant time with a photo image
- Serve as video recorder
- Function as an audio/video intercom

Additionally, facial recognition can be incorporated using third party software.

MT380 has a demo program that enables users to capture a still picture with a card number and time stamp when a proximity card is read.

Testing Imager

MT380 has a built-in CameraDemo program that enable users to test the camera efficiency.

1. Double-tap the **My Device** icon on the Windows CE desktop.



2. Double-tap the Windows folder.



3. Double-tap the Windows folder.

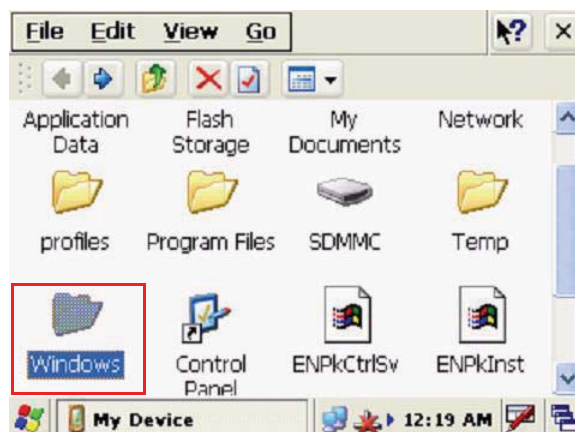

4. Double-tap **CameraDemo** to open the demo program.



5. Tap **Preview** → **Start**.

A continuous image is displayed enabling users to capture image/audio/video.

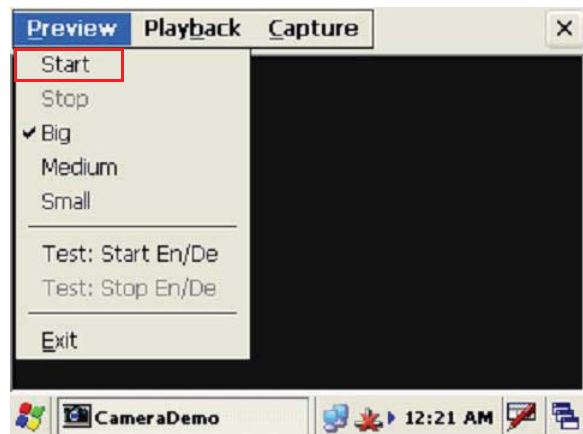

6. Tap **Capture**.

Audio Demo Program

The audio demo program enables you to test audio input (recording) and output (playback).

1. Double-tap the **My Device** icon on the Windows CE desktop.

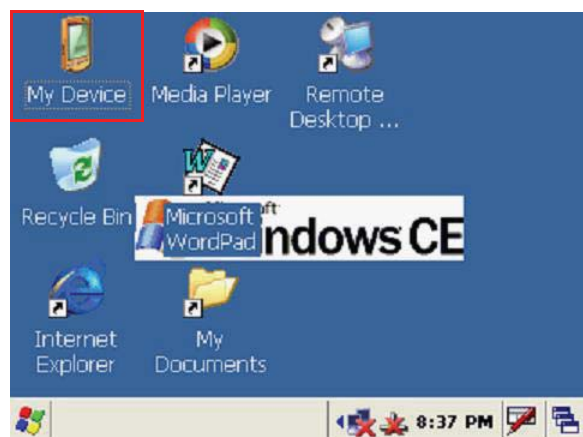

2. Double-tap the Windows folder.



3. Double-tap **wavtest** to open the demo program.

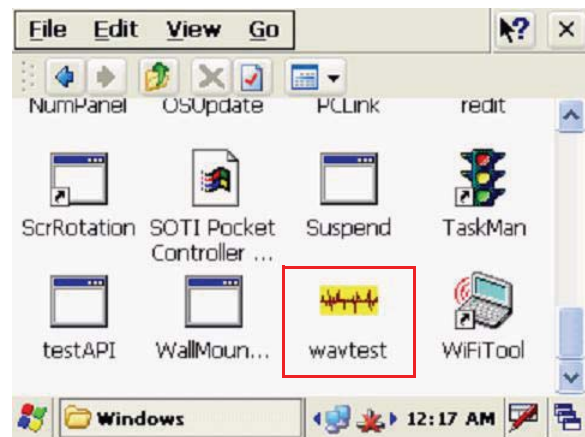

4. Do one of the following:
 - Tap **Rec** to record the voice
 - Tap **Stop** to finish recording
 - Tap **Play** to listen to the recording



Data Communication

MT380 enables users to link to a host computer via RS232/485 cable or Ethernet cable for data communication.

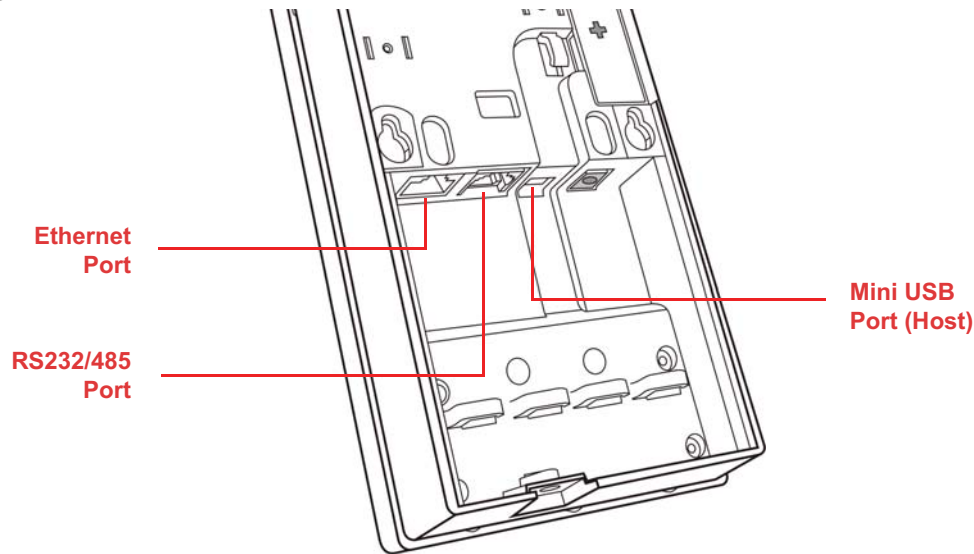

Establishing USB Connection

Connect the provided mini USB cable to the terminal's USB host port, and connect the other end to a USB peripheral, such as keyboard, mouse, memory card, and HID compliant device.

Establishing Device-PC Connection

The following connection methods are provided.

Serial Cable

1. Plug the provided RS232 communication cable into the PC's 9-pin COM port.
2. Connect the other end to MT380 RS232 interface Port.

Ethernet Cable

1. Plug an Ethernet cable into the PC's RJ-45 Ethernet Port.
2. Connect the other end of the cable to MT380 Ethernet Port.

NOTE: In order for the optional power over Ethernet module to support power over the RJ-45 Ethernet cable, the client side must have a POE Hub.

Establishing WiFi Connection

MT380 supports wireless communication with a built-in WiFi card for 802.11b/g wireless LAN.

Everytime when you power on the device, the pop-on window with wireless information will appear. If not, tap the network icon on the task bar.



Network icon

1. Under the Wireless Information tab, double-tap **Add New...** to add a new network.



2. Enter the **SSID** (UTE for example).

Select **Open** from the **Authentication** drop-down menu.

Uncheck **The key is provided automatically**, and input the 10-digit **Network key**.

Tap **OK**.

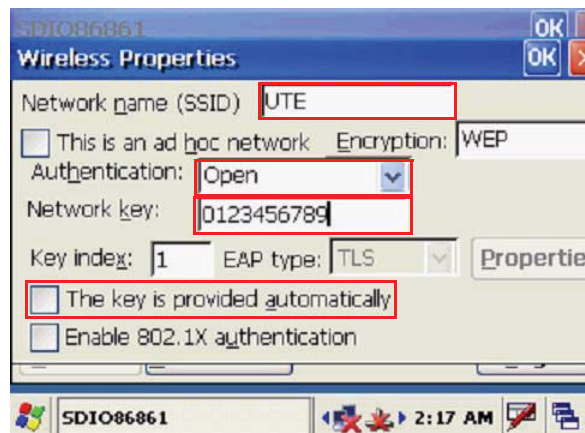

3. The new network is automatically connected.

If not, tap **Connect** to connect the new network (UTE for example).



Using ActiveSync

Using Microsoft ActiveSync, you can synchronize and transfer information between your desktop computer and terminal.

Additional Capabilities

With ActiveSync, you can also:

- Back up and restore your device data.
- Copy (rather than synchronize) files between your device and desktop computer.
- Control when synchronization occurs by selecting a synchronization mode. For example, you can synchronize continually while connected to your desktop computer or only when you choose the synchronize command.
- Select which information types are synchronized and control how much data is synchronized. For example, you can choose how many weeks of past appointments you want to synchronize.

Requirements

To synchronize, ActiveSync program must be installed on both your desktop computer and the terminal. MT380 terminal ships with ActiveSync already installed. You can download and install the most current version of ActiveSync from www.microsoft.com.

Installing Microsoft ActiveSync

In order to exchange data between your computer and MT380, Microsoft ActiveSync must be installed on your computer.

NOTE: If you have a previous version of the Microsoft ActiveSync installed in your computer, uninstall it first before installing the latest version of Microsoft ActiveSync. MT380 IP-based Access Control Terminal requires ActiveSync version 4.5 or higher.

To install Microsoft ActiveSync on your computer:

1. Close any open programs, including those that run at startup, and disable any virus-scanning software.
2. Download the ActiveSync software from the Microsoft ActiveSync Download page at <http://www.microsoft.com/windowsmobile/activesync/activesync45.msp>.
3. Browse to the location of the downloaded file, and double-click it. The installation wizard begins.
4. Follow the instructions on the screen to install Microsoft ActiveSync.

Connecting the Device to Your Computer

1. Locate the I/O panel on MT380's rear cover, and remove the I/O panel by twisting a Philips screwdriver on the cross mark shown as the illustration.

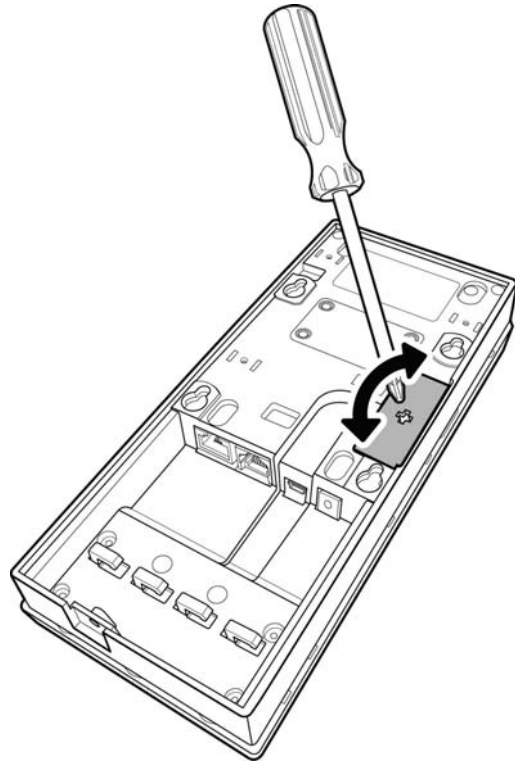

2. Connect the provided full RS232 converter cable to the terminal's full-duplex RS232 port, and then connect the other end to PC.

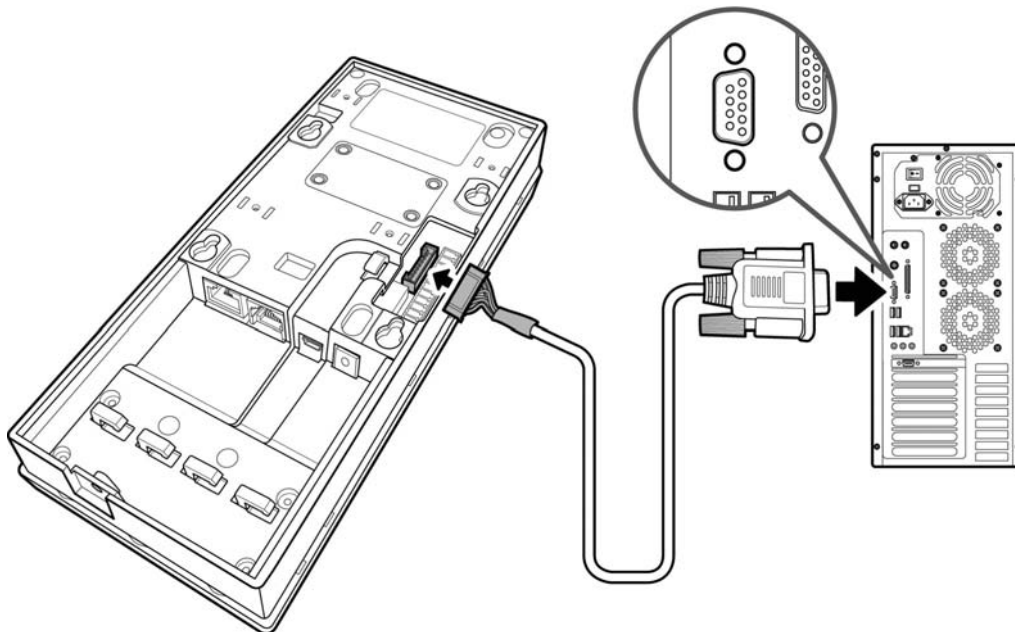

3. Power on MT380.

4. ActiveSync starts automatically and configure the communication port to work with MT380. The New Partnership setup wizard automatically starts.

NOTE: If ActiveSync doesn't start automatically, click  → **Programs** → **Microsoft ActiveSync**.

If a message appears indicating that it is unable to detect a connection, click the **Cancel** button and manually configure the communication settings.



5. Follow the onscreen instructions.
6. When the configuration process is complete, the ActiveSync window appears.

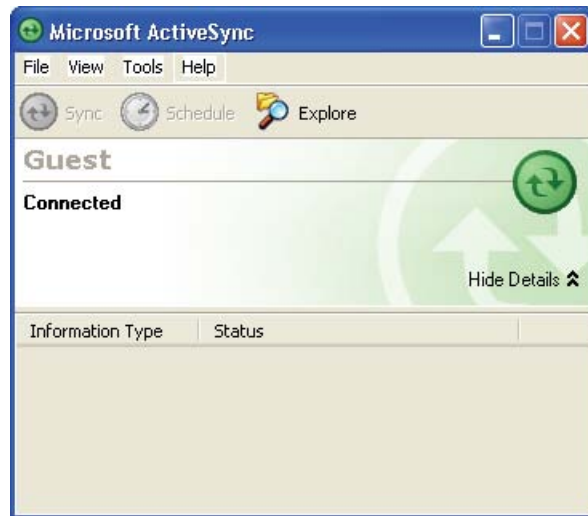

7. Synchronization will be initialized and will take place if you've chosen to synchronize periodically or upon connection.

NOTE: Your computer can create a partnership with multiple MT380s. Also, a MT380 can create a partnership with up to two computers.

8. On MT380, tap  → **Settings** → **Control Panel** → **PC Connection**.



9. Check **Enable direct connections to the desktop computer**.

Tap **Change Connection**.



10. Select the type of connection you want to use.



Setting up the Wireless Local Area Network Card

MT380 automatically detects RF cards during the first-time installation. Note that you can use one of the following two ways to set the IP address:

- Obtaining an IP Address via DHCP Server
- Specifying an IP Address

Obtaining an IP Address via DHCP Server

To obtain the IP address via DHCP server, make sure a DHCP server is available in your LAN environment.

1. Tap  → **Settings** → **Control Panel** → **Network and Dial-up Connections**.



2. Tap **DM9ISA1**.

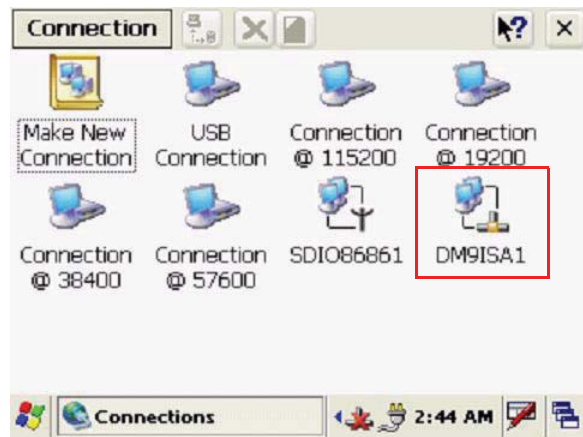

3. Tap the radio button next to **Obtain an IP address via DHCP** and then tap the **OK**.



Specifying an IP Address

If there is no DHCP server available/if you want to specify an IP address, assign IP address to each MT380 as follows:

1. Tap → **Settings** → **Control Panel** and then double-tap **Network and Dial-up Connections**.



2. Tap **DM9ISA1**.

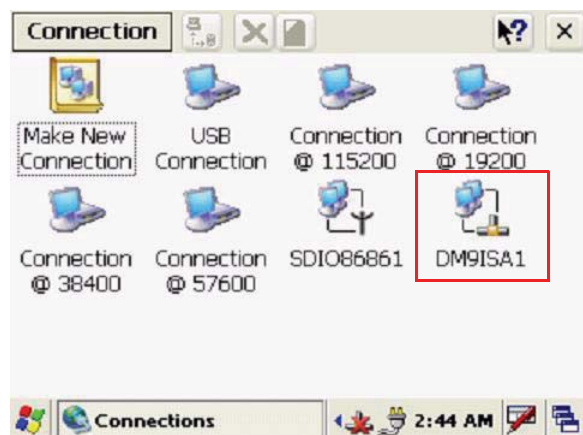

3. Tap the radio button next to **Specify IP Address**.

Input the proper IP address, Subnet Mask, and Default Gateway.

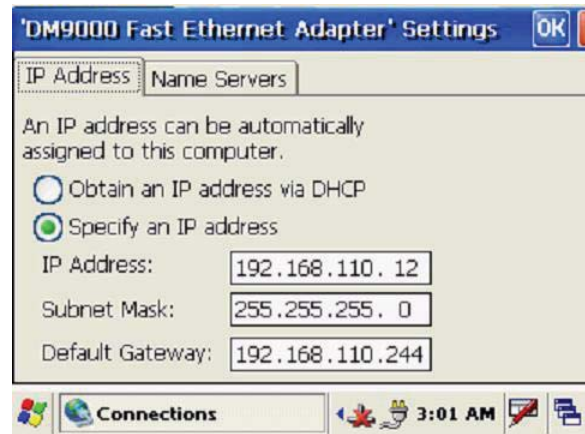

4. Tap the **Name Servers** tab, and then input the proper Primary DNS, Secondary DNS, Primary WINS, and Secondary WINS.

To avoid conflict with your LAN environment, consult with your MIS department for the correct TCP/IP setting.

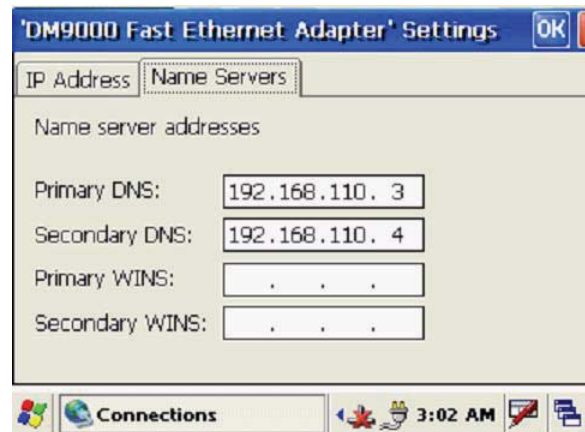

Power System

Charging the Backup Battery for the First Time

MT380 is equipped with a Lithium-Ion battery pack. After long storage periods, the unit may not power-on without an external power adapter due to battery discharge. In this case, connect MT380 to the power adapter and recharge the unit for about 12 hours to fully charge the battery.

NOTE: MT380 can operate for approximately two hours (depending on the hardware configuration and backlight usage) or can store data for three days without external power. Operating MT380's backlight screen at 100 percent brightness, and using the fingerprint utility reader consumes the most power. Therefore, when MT380 is disconnected from its external power source it will enter into sleep mode, which automatically turns off the backlight. Tapping the touch-screen will set the backlight screen to minimum brightness, saving battery power.

Checking the Battery Status

This status icon  appears on MT380's taskbar indicating low or very low battery status. MT380 will enter suspend mode when the battery level reaches low status, and MT380 will enter sleep mode when the battery level reaches very low status. There is a 12 hour time window to recharge MT380, but after more than 12-hours there is a strong risk of losing all the data on the device's internal memory.

This icon  appears in the taskbar when the backup battery is low and the backup battery should be recharged as soon as possible.

Check the Power Properties by tapping  → **Settings** → **Control Panel** → double-tap **Power**.



CAUTION! Immediately backup MT380's data or risk losing everything when there is no external power, and the backup battery icon  appears in the system tray.

Extending Battery Life

Extend MT380's battery life by doing the following:

- Change the automatic power settings.
- Reduce the CPU speed.
- Minimize the backlight.

Changing the Automatic Power Settings

MT380 enters an idle mode when there is no task, or all tasks are waiting for input. In the default setting, MT380 enters User Idle mode when there is no data input for one minute. MT380 remains idle for three minutes when there is no external power source. Pressing the power button will return MT380 to the automatic shutdown mode screen.

To change the automatic power settings:

1. Open the Power Properties by tapping  → **Settings** → **Control Panel** → **Power**.
2. Tap the **Schemes** tab.
3. Tap the automatic shut off time arrow to select from a list of time periods for the following modes:
 - **User Idle:** MT380 switches to User Idle mode when there is no user input after the selected time.
 - **Switch State to System Idle:** MT380 switches from User Idle mode to System Idle mode when the system is inactive after the selected time.
 - **Switch State to Suspend:** MT380 switches from System Idle mode to Suspend mode when the system is inactive after the selected time.

The available time periods are 1, 2, 3, 4, 5, 10 and 30 minutes.

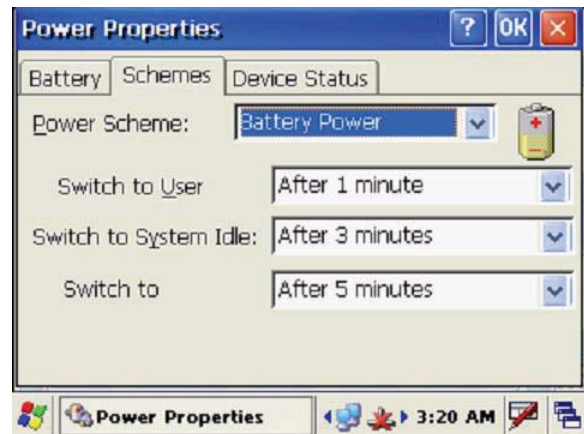

Reducing CPU Speed

Follow these instructions to reduce the CPU speed.

1. Tap  → **Settings** → **Control Panel** → double-tap **CPU Speed**.



2. Select a lower CPU speed to conserve battery power.

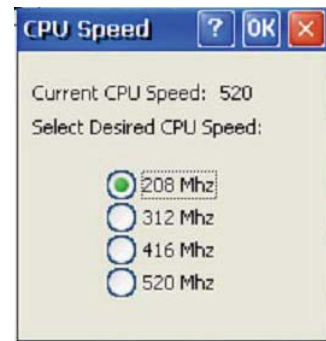

Adjusting the Backlight

The following section describes how to conserve power by adjusting the backlight screen settings.

NOTE: MT380 screen contrast has been preset by Unitech for optimum performance.

The color display's backlight can be customized. There are two tabs: **Battery Power** and **External Power**.

1. Tap  → **Settings** → **Control Panel** → double-tap **Backlight** to adjust the screen brightness.

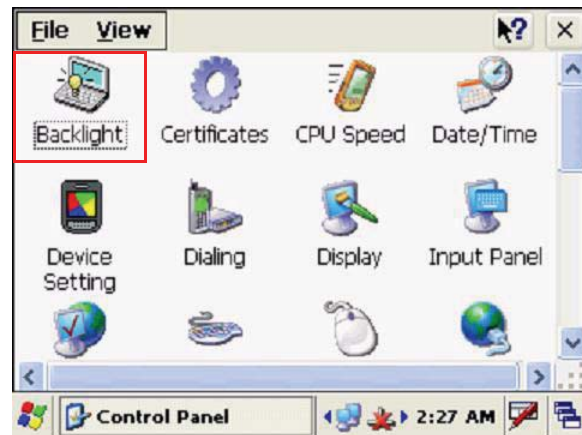

2. Set the backlight behavior and drag the **On Intensity** and **Dim Intensity** sliders to the desired levels.

Field	Description
Dim Backlight	Minutes until the backlight dims.
Turn Off Backlight	Minutes until the backlight turns off automatically.
Turn on Backlight	The Backlight turns on when a button is pressed, or the touch-screen is tapped.



Performing a Hardware Reset

Perform a reset if MT380 freezes (i.e., device no longer responds to the buttons on the screen).

Performing a Warm Start

A Warm Start is used to reset or reboot the device without losing data stored in RAM. Perform a Warm Start in any of the following situations:

- MT380 fails to respond.
- After installing software applications.
- After making changes to certain system settings (i.e. SD card).

CAUTION! A Warm Start will cause unsaved data to be lost.

Method 1: From Windows CE

1. Tap  → **Programs** → **Utilities** → **Boot-Mode**.



2. Tap **Warm Boot**.



Method 2: From Hardware

1. Locate the function keys on MT380.
2. Press **F2** and **F4** simultaneously.

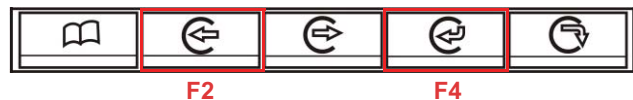

Performing a Cold Start

A Cold Start will erase all added data and programs, but it will restore the device to the default factory settings. However, data and application programs stored in the Flash Storage will not delete.

Always perform a Warm Start before attempting to use a Cold Start to correct a problem. Data previously synchronized to the computer can be restored during a future Microsoft ActiveSync operation, or data can be restored from a backup storage card.

Perform a Cold Start by using the BootMode utility in the operating system, or by pressing the Cold Boot hardware reset button in the unit.

Perform a cold start in the following situations:

- Reset the operating system.
- Restore MT380 back to factory settings.
- Reset MT380 after a boot loader, keyboard and kernel upgrade.

CAUTION! A cold start erases all data and installed applications in RAM memory.

Method 1: From WinCE

1. Tap  → **Programs** → **Utilities** → **Boot-Mode**.



2. Tap **Cold Boot**.



Method 2: From Hardware

1. Locate the cold start button on the rear of MT380.
2. Press the Cold Start button with a stylus.

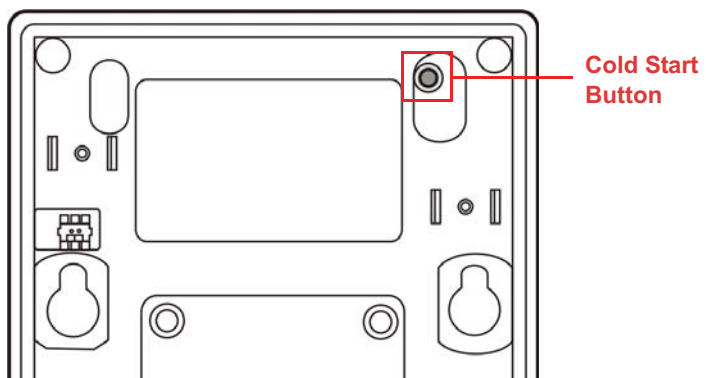

Appendix A

System Specification

Processing/Memory	CPU	520MHz Intel PXA270 Bulverde
	Memory	SDRAM: 128 MB Flash ROM: 64 MB
OS	Microsoft Windows CE 5.0	
Keypad	17-key (numeric and function keys)	
Display	3.5" QVGA (240 x 320) Pixels Backlight Touch-screen, TFT-LCD	
Communication	Full RS232 support (Optional Housing 9pin to D-Sub 9pin cable) Half RS232 support (Optional RJ45 to D-Sub 9pin cable)/ Half RS485 support (Optional RS485+, RS485-) *RS232/RS485 either one by S2 switch selection One RJ45 with POE (DC5V /2A) USB v1.1 Host (Optional Mini-5P to Type A Female cable) 802.11b/g via SDIO interface	
Multimedia	Camera: 2.0 megapixel CMOS Audio output: 0.8/2-Watt speaker Microphone input	
TASHI Middleware	VoIP Video streaming Access control, time and attendance management	
Connection & Expansion	SD slot for memory expansion Relay Outputs (2) Photo-coupler Inputs (2)	
Power Source	Main	External power
	Backup	3.7V Li-Ion 1200mAh
Enclosure	Weight	485 g. (1.068 lbs.)
	Dimension	228mmL X 35mmH X 100mmW (8.97"H X 3.93"W X 1.37"D)
Environmental	Operating Temperature	-10°C – 50°C (14°F – 122°F)
	Storage Temperature	-20°C – 60°C (-4°F – 140°F)
	Relative Humidity	5% – 95% RH non-condensing
Certification	CE, FCC, BSMI, CCC, RoHS compliant	
Software	Embedded Visual Basic terminal program for T&A C#, VB.NET, C++	
Proximity Reader	EM, 125kHz HID, 125kHz Mifare, 13.56mHz (ISO14443A/B, 15693)	

Appendix B

Worldwide Support

Unitech's professional support team is available to quickly answer questions or technical-related issues. Should an equipment problem occur, please contact the nearest Unitech regional service representative. For complete contact information please visit the Web sites listed below:

Region	Website
Global Operation Center	www.unitech-adc.com
Unitech Asia Pacific & Middle East	www.unitech-utp.com.tw
Greater China Division	www.unitech-sbd.com
Unitech Japan	www.unitech-japan.co.jp
Unitech America	www.ute.com
Unitech Latin America	www.latin.ute.com
Unitech Europe	www.unitech-europe.nl