

# RH767 RFID Handheld Reader



## User's Manual

---



## About This Manual

This manual explains how to install, operate and maintain the RH767.

No part of this publication may be reproduced or used in any form, or by any electrical or mechanical means, without permission in writing from the manufacturer. This includes electronic or mechanical means, such as photocopying, recording, or information storage and retrieval systems. The material in this manual is subject to change without notice.

© Copyright 2007 unitech Electronics Co., Ltd. All rights reserved.

unitech global website address: <http://www.unitech-adc.com>

Bluetooth is a registered trademark of Bluetooth SIG.



Microsoft, Windows and ActiveSync are either registered trademarks or trademarks of Microsoft Corporation. Other product names mentioned in this manual may be trademarks or registered trademarks of their respective companies and are hereby acknowledged.



unitech is a member of Oracle Embedded Software Licensing Program

## Regulatory Compliance Statements

---

### Federal Communication Commission Interference Statement

This equipment has been tested and found to comply with the limits for a Class B digital device, pursuant to Part 15 of the FCC Rules. These limits are designed to provide reasonable protection against harmful interference in a residential installation. This equipment generates, uses and can radiate radio frequency energy and, if not installed and used in accordance with the instructions, may cause harmful interference to radio communications. However, there is no guarantee that interference will not occur in a particular installation. If this equipment does cause harmful interference to radio or television reception, which can be determined by turning the equipment off and on, the user is encouraged to try to correct the interference by one of the following measures:

- Reorient or relocate the receiving antenna.
- Increase the separation between the equipment and receiver.
- Connect the equipment into an outlet on a circuit different from that to which the receiver is connected.
- Consult the dealer or an experienced radio/TV technician for help.

### FCC Caution:

Any changes or modifications not expressly approved by the party responsible for compliance could void the user's authority to operate this equipment.

This device complies with Part 15 of the FCC Rules. Operation is subject to the following two conditions: (1) This device may not cause harmful interference, and (2) this device must accept any interference received, including interference that may cause undesired operation.

This device and its antenna(s) must not be co-located or operating in conjunction with any other antenna or transmitter.

## RoHS Statement



This device conforms to RoHS (Reduction Of Hazardous Substances) European Union regulations that set maximum concentration limits on hazardous materials used in electrical and electronic equipment.

## Laser Information

---

The unitech RH767 series is certified in the U.S. to conform to the requirements of DHHS/CDRH 21CFR Subchapter J and to the requirements of IEC 825-1. Class II and Class 2 products are not considered to be hazardous. The RH767 series contains internally a Visible Laser Diode (VLD) whose emissions do not exceed the maximum limits as set forth in the above regulations. The scanner is designed so that there is no human access to harmful laser light during normal operation, user maintenance or during prescribed service operations.

The laser safety warning label required by the DHHS/IEC for the RH767 series's optional laser scanner module is located on the memory compartment cover, on the back of the unit.

**CAUTION!** Use of controls or adjustments or performance of procedures other than those specified herein may result in hazardous laser light. Use of optical instruments with the scanner will increase eye hazard. Optical instruments include binoculars, microscopes, and magnifying glasses. This does not include eye glasses worn by the user.

## Notices

---

This unit is equipped with battery packs and backup battery. It is possible that the unitech RH767 may not power-on due to battery discharge as a result of storage.

In the above situation, plug the RH767 to the USB charging cable which is with DC in port, and recharge the unit for 16 hours in order to fully charge its backup battery.

The backup battery will charge from external power or the main battery (if the main battery still has enough power to turn on). In the event the main battery is fully charged, refrain from using the RH767 for 16 hours in order for the main battery to fully charge the backup battery.

Backing-up data by backup battery only without the main battery installed in battery compartment may take as long as 6 hours. Therefore, in order to prevent data protection failure due to backup battery failure, do not leave the RH767 without the rechargeable battery pack installed, or without connection to AC power for an extended period of time.

### NOTE:

- The first time you use the RH767, you must turn on the backup battery switch. **See turn on the backup battery & grip battery switch on page 6 for more information.**

## **Battery Charge Notice**

It is important to consider the environment temperature whenever you are charging the Lithium-Ion battery pack. The process is most efficient at normal room temperature or slightly cooler. It is essential that you charge batteries within the stated range of 0°C to 40° C. Charging batteries outside of the specified range could damage the batteries and shorten their charging life cycle.

## **Storage and Safety Notice**

Although charged Lithium-Ion batteries may be left unused for several months, their capacity may be depleted due to build up of internal resistance. If this happens they will require recharging prior to use. Lithium-Ion batteries may be stored at temperatures between -20° C to 60°C, however they may be depleted more rapidly at the high end of this range. It is recommended to store batteries within normal room temperature ranges.

## **IMPORTANT NOTE**

FCC Radiation Exposure Statement: This equipment complies with FCC radiation exposure limits set forth for an uncontrolled environment. This equipment should be installed and operated with minimum distance **20cm** between the radiator & your body.

# Table of Contents

- Preface** ..... i
  - About This Manual ..... i
  - Regulatory Compliance Statements** ..... i
    - FCC Statement ..... i
    - RoHS Statement ..... i
  - Laser Information** ..... i
  - Notices** ..... ii
    - Battery Charge Notice ..... ii
    - Storage and Safety Notice ..... ii
  
- Chapter 1** ..... 1
  - Getting Started ..... 1
    - Introducing the RH767** ..... 1
      - Features ..... 1
    - Package Contents** ..... 2
    - A Tour of the RH767** ..... 3
      - Back View ..... 4
      - Bottom View ..... 5
    - Setting up the RH767** ..... 5
      - Installing the Battery ..... 5
      - Charging the Battery ..... 8
        - Charging the Battery using the Synchronization Power Cable* ..... 8
        - Checking the Battery Status* ..... 9
      - Connecting the RH767 to a PC ..... 9
      - Turning the RH767 on for the First Time ..... 10
        - Powering On* ..... 10
        - Calibrating the RH767 Screen* ..... 11
        - Setting the Time and Date* ..... 12
        - Adjusting the Screen Brightness* ..... 12

**Chapter 2** ..... 13

    Using the Hardware ..... 13

        Using Function keys ..... 13

        Toggle to Alpha Mode and CAPS ..... 14

**Adjusting Settings** ..... 15

**Checking the Main and Backup Battery Status** ..... 16

**Using the Stylus** ..... 17

**Using the Laser Scanner** ..... 17

**Scanner Settings** ..... 18

**Scan2Key** ..... 19

**Using the RFID** ..... 19

        Launching UHF RFID Demo Program ..... 19

**Chapter 3** ..... 21

    Getting Connected ..... 21

**Establishing Device-PC Connection** ..... 21

            Installing Microsoft ActiveSync ..... 21

            Connecting the Device to Your Computer ..... 21

**Using ActiveSync to Exchange Files** ..... 22

**Using the WLAN** ..... 23

            Setting up the Wireless Local Area Network Card ..... 23

*Obtaining an IP Address via DHCP Server* ..... 23

*Specifying an IP Address* ..... 24

*WiFi Connection* ..... 25

            Using the WiFi Tool ..... 25

**Appendix**

    System Specifications ..... 27





## Getting Started

### Introducing the RH767

---

**Thank you for purchasing the RH767 handheld terminal. Your RH767 was designed for RFID mobile application.**

#### **RH767 UHF**



Unitech's RH767 UHF handheld terminal is a rugged dual technology multi-tag UHF RFID and barcode reader. It can read both EPC Gen 1 and Gen 2 RFID tags and comes with embedded RFID middleware and Windows CE 5.0 for easy integration. The RH767 has a battery life of up to 12 hours – long enough for operation. Connectivity options include WLAN 802.11b/g and Bluetooth. It has an IP54 rated and 1.2 meter drop tested rugged PDA construction.

#### **Features**

- Dual technology barcode scanner & RFID (UHF) reader
- Embedded RFID Middleware
- Built in Barcode Scanner
- IP54 rated and 1.2m drop tested
- Lightest in its class
- Windows WinCE 5.0 Professional Plus operating system
- WLAN 802.11b/g and Bluetooth connectivity built-in

# Package Contents

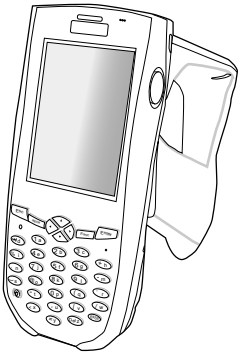
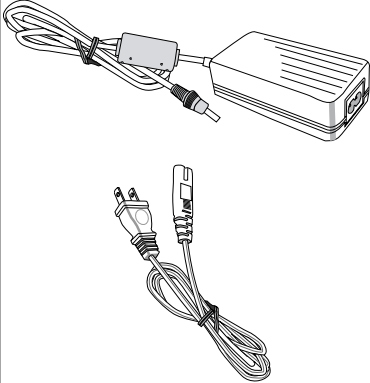
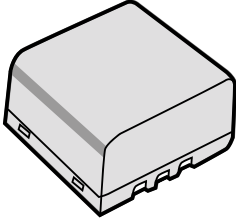
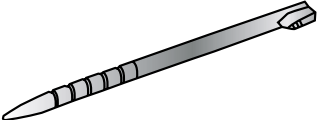
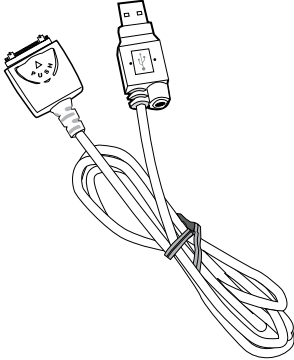
After opening the box, ensure the following accessories for the RH767 are present:

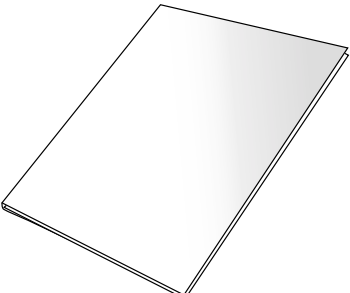
		
<p>RH767 Terminal</p>	<p>Power Adapter and Cable</p>	<p>Battery Pack</p>
		
<p>Stylus</p>	<p>Synchronization and Power Cable</p>	<p>CD-ROM</p>
		
<p>Quick Reference Guide</p>		

If anything is missing or appears damaged in any way, please contact your unitech service team.

# A Tour of the PA982

The following sections describe the main components and features of the RH767.

## Front Right View

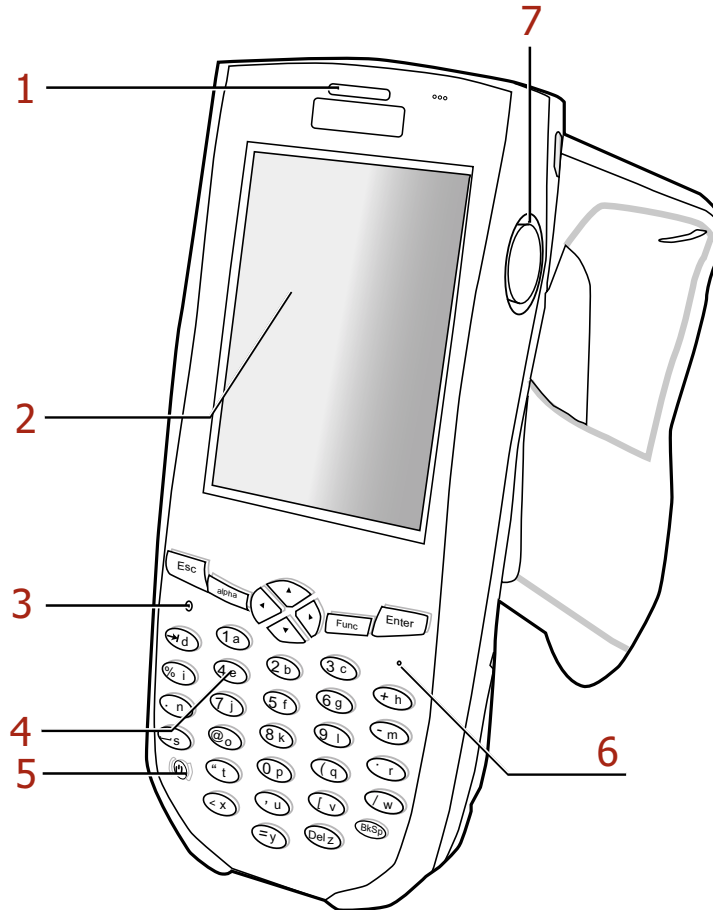

No.	Component	Description
1.	Status Indicator	Indicates the battery charging and barcode scanning status. <b>Green</b> - Battery is fully charged or barcode scanning process is completed without error. <b>Red</b> - Battery is charging, barcode scanner is activated and processing.
2.	LCD Touch Screen	Displays the applications and data stored on your device. It is touch-sensitive and responds to the stylus or finger.
3.	Alpha Mode Indicator	Indicates the Alpha Mode status.
4.	Keypad	Keypad interface for controlling the RH767. See Using the Hardware on page 13 for more information.
5.	Power Button	If the device is off, press this button to turn it on. Alternatively, when the unit is on, this key must be pressed and held down for about two seconds in order to turn the device off.

6.	Microphone	Used to receive sound.
7.	Right scanner trigger button	Press to activate the barcode laser scanner.

## Back View

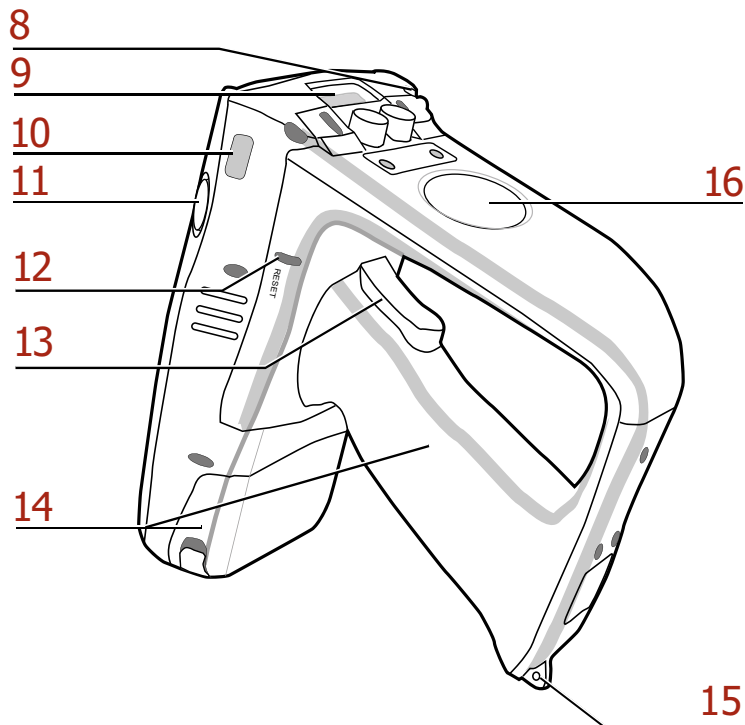

No.	Component	Description
8.	Stylus	Enables you to interact with the operating system. To use the stylus, remove it from its holder and hold it the same way you hold a pen or pencil.
9.	Barcode Scanner Window	Used to scan barcodes.
10.	Infrared (IR) Port	Uses infrared technology to transmit and receive data from other IR-enabled devices.
11.	Left Scanner Trigger Button	Press to activate the barcode laser scanner.
12.	Reset Button	Uses paper clip press into the button to reset your device.
13.	Bar Code Scanner Trigger	Press to activate the barcode scanner.
14.	Battery Compartment	Houses the removable and rechargeable 7.4V 4050mAh lithium-ion battery pack
15.	Strap Lug	Attach the strap with the terminal.
16.	RFID Antenna	Used to receive data from RFID tag.

## Bottom View

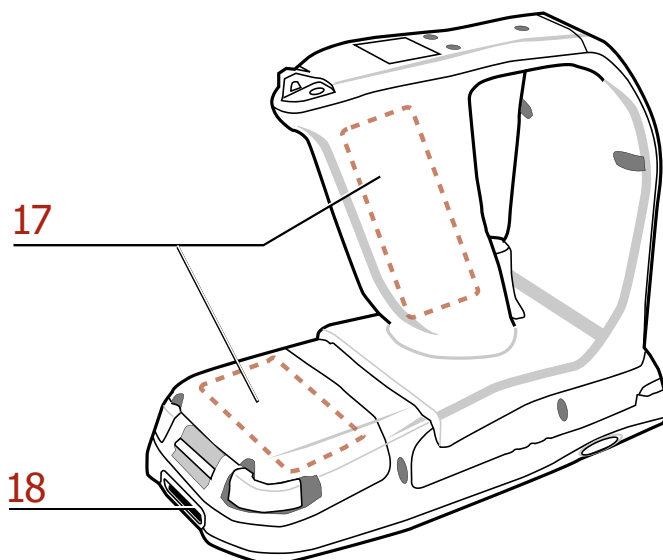

No.	Component	Description
17.	Battery Pack	Houses the rechargeable lithium-ion battery pack
18.	Universal connector	Connects your device to a synchronization power cable, which in turn connects to the computer's USB port and through the AC adapter to an electrical outlet. This allows you to recharge your device and perform an ActiveSync operation.

## Setting up the RH767

This section explains how to install and charge the battery, how to check battery status, how to connect the RH767 to a PC, how to turn on the RH767 for the first time, how to install an optional Wireless Local Area Network PCMCIA card, and how to calibrate the screen.

### Installing the Battery

**WARNING!** There is a risk of fire and burns if the battery pack is handled improperly. DO NOT disassemble, crush, puncture, short external contacts, or dispose the battery pack in fire or water. DO NOT attempt to open or service the battery pack. Dispose of used batteries according to local recycling guidelines in your area.

A backup battery cell is embedded into your device to prevent data loss in instances when the removable battery pack is removed or completely discharged. This backup battery cell will only support the system for a maximum of 72 hours.

#### NOTE:

- To enable the internal battery cell to provide backup power supply, charge your device with the main battery pack for at least 16 hours.
  - The first time you use the RH767, you must turn on the backup battery switch. **See turn on the backup battery & grip battery switch on page 6 for more information.**
  - The first time you use the RH767, you must activate the LCD heater switch. When activated, LCD heater will turn on automatically when the temperature is lower than -10°C.
1. Open the battery compartment using the slide tabs in the direction shown in the illustration.

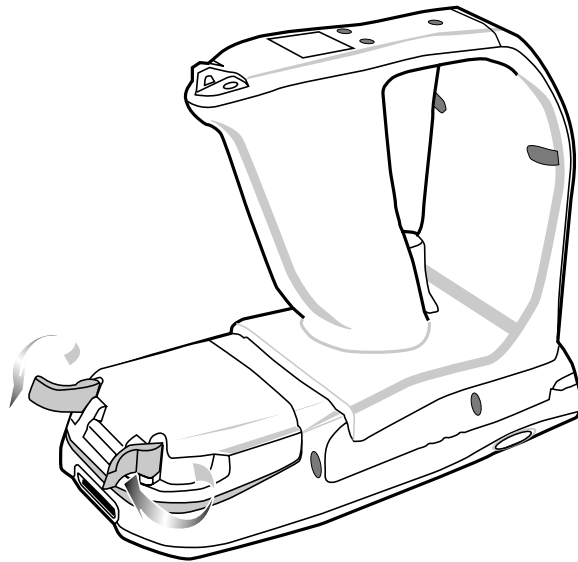

2. Locate the backup battery and grip battery switch and turn left to power on.

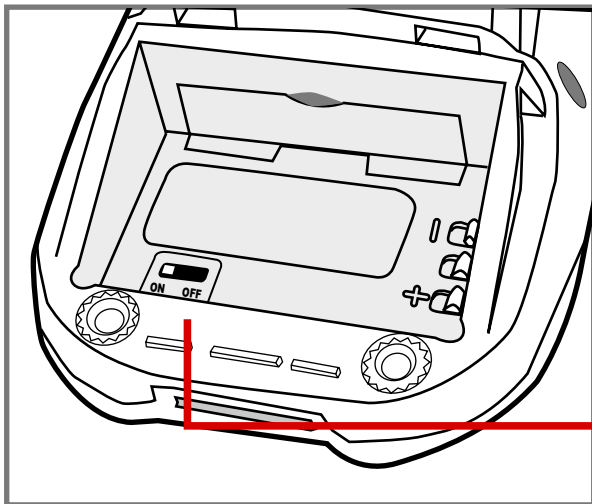

Backup battery & grip battery switch

3. Position the battery pack, making sure the battery contacts are aligned with the contacts in the compartment, as shown in the following illustration.

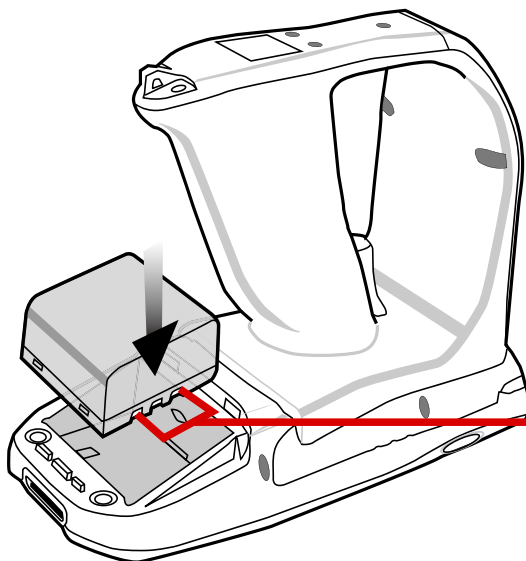

Battery contacts

4. Place the battery pack into the battery bay and press the battery securely into the compartment.

5. Replace the battery compartment cover, push down the tabs and slide them back into place as shown in the illustration.

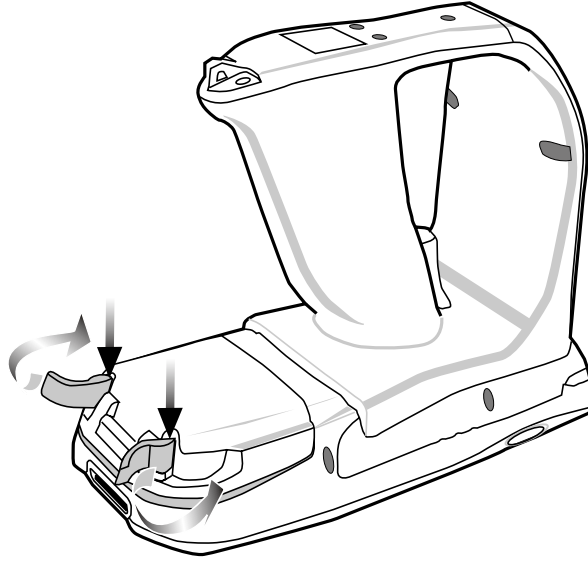

## Charging the Battery

Before using the RH767 for the first time, you need to charge it for about 16 hours. After that, you can charge the RH767 every day to recharge the battery to full capacity. Charge the RH767 using the synchronization power cable.

**CAUTION!** Operating the RH767 for the first time without the AC adapter, and without fully charging the backup battery may result in loss of data stored in RAM memory. When the main battery is removed, the backup battery retains RAM data in memory for 72 hours; charge the battery as soon as possible to avoid the data loss in RAM memory.

### ***Charging the Battery using the Synchronization Power Cable***

1. Connect the synchronization power cable connector to the RH767 (1).
2. Plug the AC adapter cable into the power jack on the USB connector (2).
3. Connect the AC adapter into an electrical outlet (3).

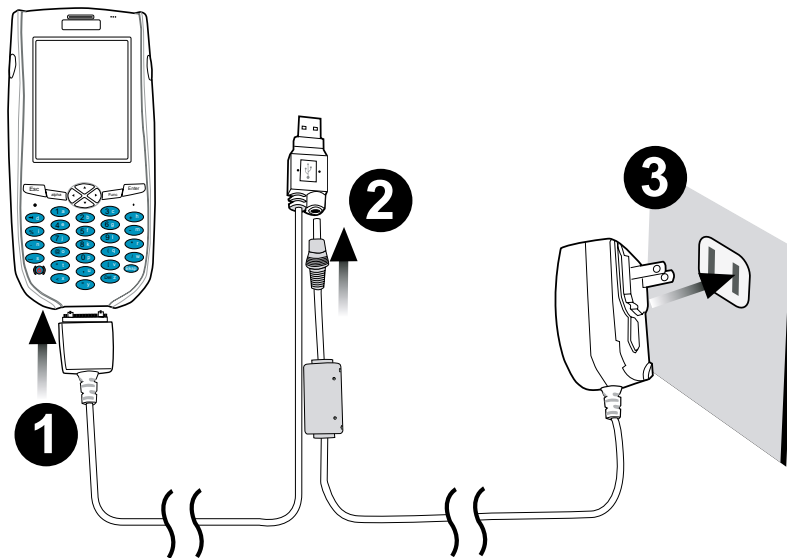



## Checking the Battery Status

If the main battery level becomes low in the course of normal use, a status icon  appears on the device screen system tray indicating low or very low battery status. In both cases, perform an ActiveSync operation to back up your data, then recharge your device as soon as possible. If the battery level reaches low status, the device will enter suspend mode; if the battery level reaches very low status, the device will enter deep sleep mode. In this case, you have about 72 hours to recharge your device after which you risk losing all data on your device's internal memory.

When the backup battery charge is low, an icon  appears in the system tray indicating that you should replace the backup battery as soon as possible.

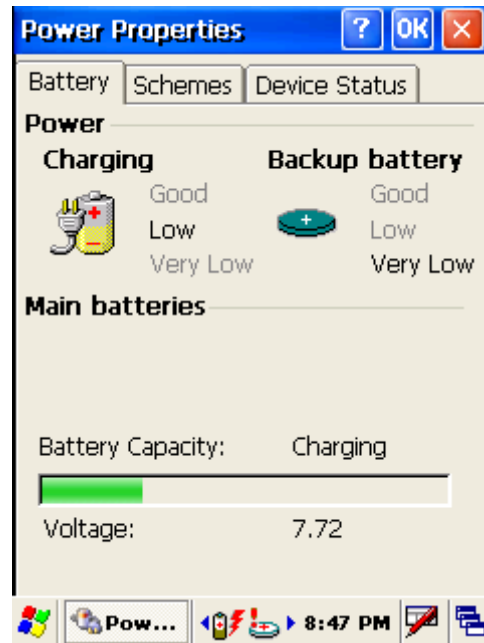

## Connecting the RH767 to a PC

Use the synchronization power cable to connect the RH767 to a PC to use with ActiveSync.

1. Connect the USB connector jack to the RH767 (1).
2. Plug the USB connector into a serial port on the PC and connect the AC adapter into the USB connector (2).
3. Connect the AC adapter into an electrical outlet (3).

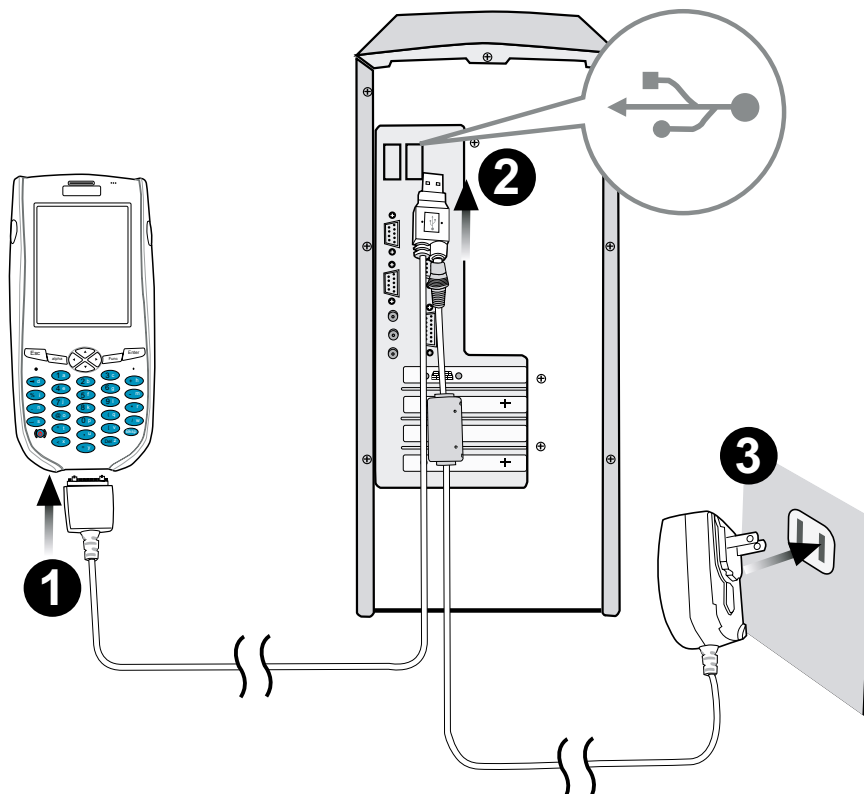

## Turning the RH767 on for the First Time

After you have initially charged your device for about 16 hours, the device is ready to be used. You can now start up your device where you'll adjust the screen brightness, calibrate the display, and set up the system time zone, date and time.

### Powering On

1. Turn on your device by pressing the power button on the front panel.
2. The unitech RH767 welcome screen appears for a moment followed by the calibration screen.

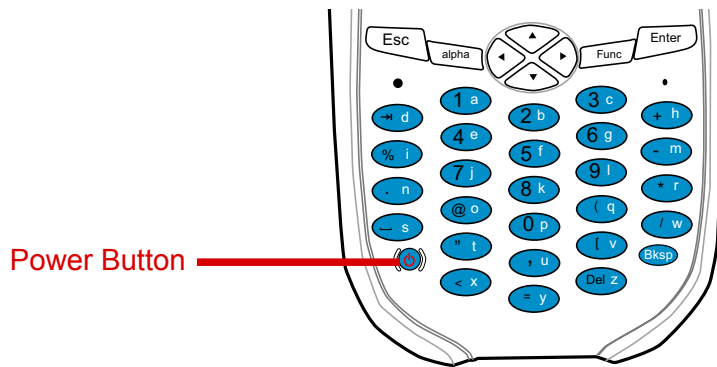

## Calibrating the RH767 Screen

The calibrate screen automatically appears when the unit is powered-on for the first time or after the system is reset.

This screen will automatically appear when the unit is powered-on for the first time or after the system is reset. This screen can also be accessed at any time by pressing the hot key [FUNC] and the [ESC] key.

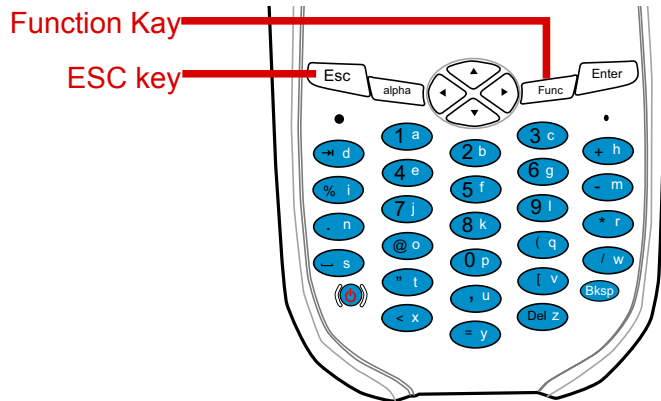

The RH767 prompts you to calibrate the unit by tapping a sequence of screen locations. Tap gently but firmly.

Carefully press and briefly hold stylus on the center of the target. Repeat as the target moves around the screen. Press the Esc key to cancel.



When you have completed the series of taps, press the [ENT] key to confirm calibration or press the [ESC] key to cancel it. After confirming calibration, the Date/Time Properties screen appears prompting you to set the date and time.

Carefully press and briefly hold stylus on the center of the target. Repeat as the target moves around the screen. Press the Esc key to cancel.

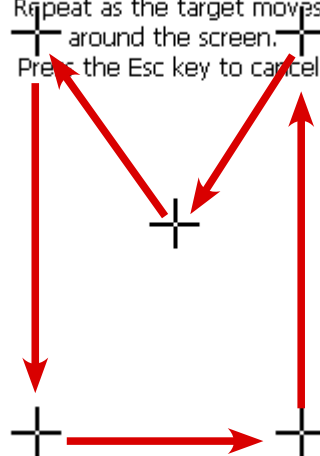

## Setting the Time and Date

In the Date/Time Properties window, use the stylus to select the current date and time, time zone, and daylight saving time option.

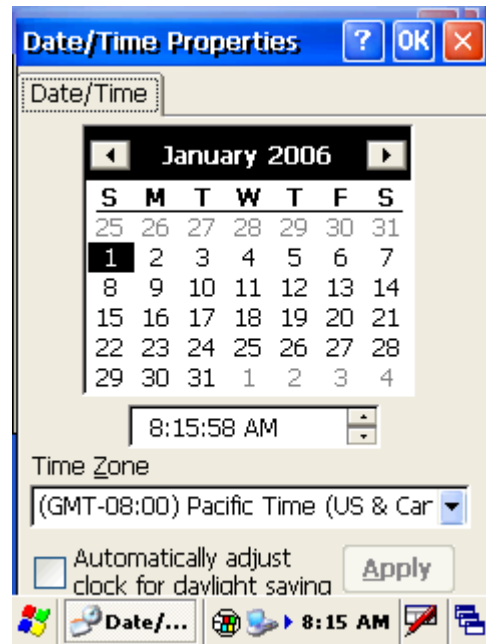

## Adjusting the Screen Brightness



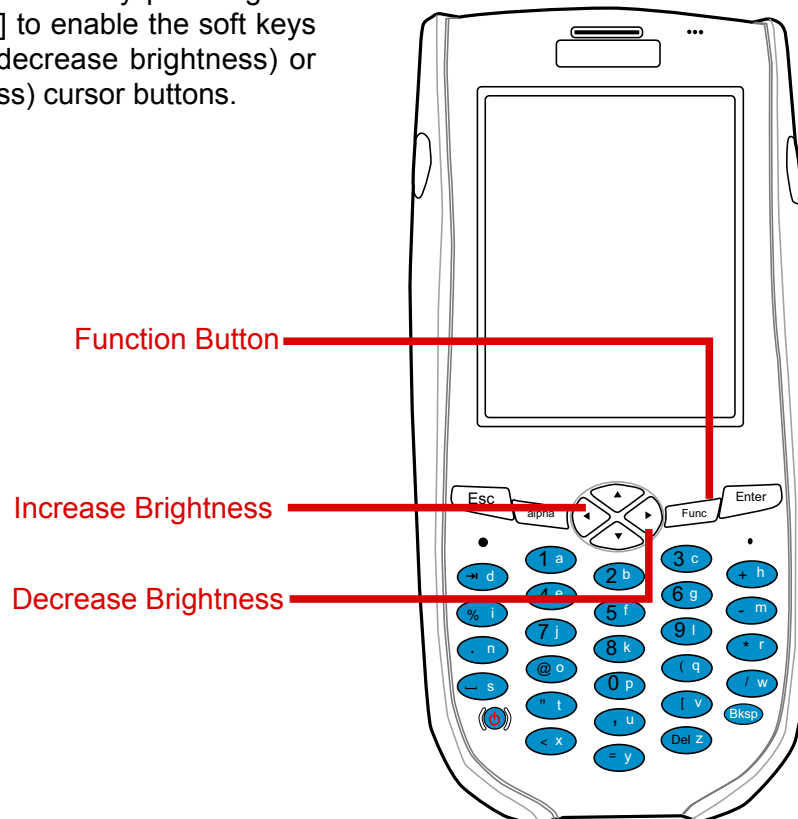





Adjust the screen brightness by pressing the Function button [FUNC] to enable the soft keys and pressing the left (decrease brightness) or right (increase brightness) cursor buttons.

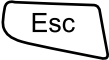

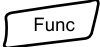
## Chapter 2

## Using the Hardware

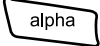
The following table describes the main keypad keys.

Key	Main Function
	Press this button to turn the RH767 on. Press and hold this button for two seconds to turn the RH767 off.
	Pressing this button corresponds to tapping the cancel or X button on the screen.
	Press the backspace key to erase characters.
	Press the function key to perform alternative key functions. This key is also used to toggle between upper and lower case alphabetic characters. Refer to Using Hotkeys on page 13.
	Use the tab key to toggle between fields or to tab forward in word processing applications.
	Press the enter key to confirm an action or entry by the user.
	Use the cursor keys to navigate in applications. Press and hold the Function key and then press the right and left arrows to raise and lower the screen brightness.
	Press the alpha key to toggle between numeric and alphabetic entry modes.
	Press these keys to enter numbers or characters depending on whether the Alpha key has been pressed. Press the 0 key to enter a space.
	Press this key to add punctuation.

### Using Function keys

The RH767 provides many combination hot keys to activate specified screen setting functions or programs. These hotkeys are useful for calibrating the touch screen, toggling the backlight, and adjusting screen contrast when the menu-driven operation is disabled. Below is the list of hotkeys. To use them, Press and hold the [FUNC] key in combination with the corresponding second key.

Key	Function
[FUNC]+ ▲	Toggle Display Backlight
[FUNC]+ ▼	Toggle Keypad LED Backlight
[FUNC]+ ►	Increase screen brightness
[FUNC]+ ◀	Decrease screen brightness

## Toggle to Alpha Mode and CAPS

When the RH767 boots, the default condition is Numeric Mode on. When you toggle to Alpha Mode, the default condition is CAPS mode off. Please use the alpha Key and Function key to toggle to CAPS.

Key	Alpha OFF		Alpha ON	
	FUNC UP	FUNC DOWN	FUNC UP	FUNC DOWN
ESC	ESC	ESC	ESC	ESC
Backspace	Backspace	Backspace	Backspace	Backspace
Enter	Enter	Enter	Enter	Enter
1/F1/a	1	F1	a	A
2/F2/b	2	F2	b	B
3/F3/c	3	F3	c	C
TAB/d	TAB	`	d	D
4/F4/e	4	F4	e	E
5/F5/f	5	F5	f	F
6/F6/g	6	F6	g	G
+/^/h	+	^	h	H
%/BL/i	%	Backlight	i	I
7/F7/j	7	F7	j	J
8/F8/k	8	F8	k	K
9/F9/l	9	F9	l	L
-/_/m	-	_	m	M
./;/n	.	;	n	N
@/!/o	@	!	o	O
0/\$/p	0	\$	p	P
(/)/q	(	)	q	Q
*/#/r	*	#	r	R
SPACE/s	SPACE	SPACE	s	S
"/'/t	"	'	t	T
,/?/u	,	?	u	U
[/]/v	[	]	v	V
/\w	/	\	w	W
</>/x	<	>	x	X
=/&/y	=	&	y	Y
DEL/z	DEL	~	z	Z

# Adjusting Settings

This section describes how to adjust the settings of your device to accommodate your work habits.

To access Settings, tap  
**Start** → **Settings** → **Control Panel**



The Control Panel appears.

From here you can adjust such user configurable items as the backlight, auto power off timer, system volume, and processor speed. You can also assign functions to buttons, configure menus, enter owner information, and set up connections.

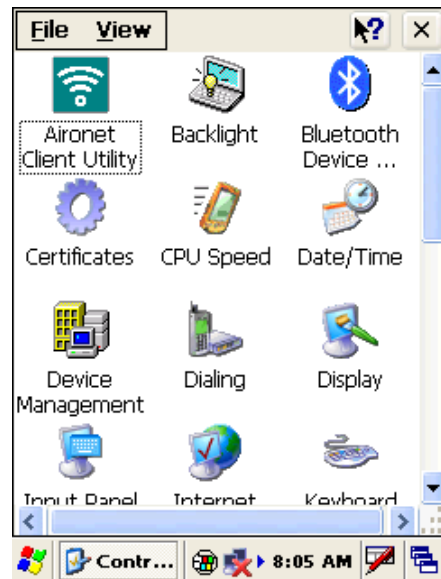

# Checking the Main and Backup Battery Status

This section describes how to view the power level for both the main and backup battery. To minimize power consumption, you can define settings for the auto-off function and the processor's operation speed.

To check the main and backup battery status:

1. Tap **Start** → **Settings** → **Control Panel** → **Power**:



The Power Properties screen appears.

2. The battery menu item displays the status of the main and backup batteries.

On the screen shown here, the main battery is good, but the backup battery charge is very low. You should charge the backup battery as soon as possible in this case.

**NOTE:** It is necessary to charge the battery when the battery charge reaches below 10%. If the battery does not accept a charge, contact unitech Technical Support.

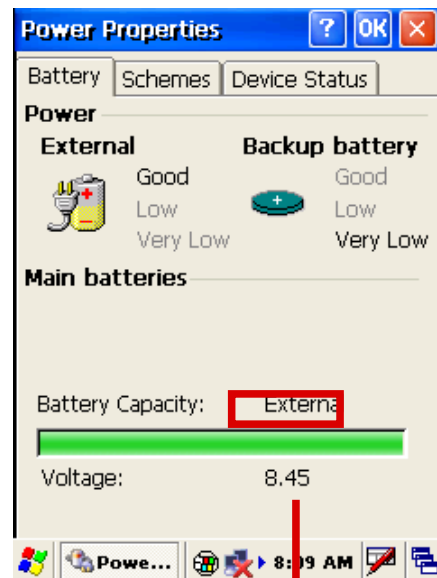

Main battery voltage



### Using the Stylus

---

**CAUTION!** Never use anything other than the RH767 stylus on the screen. Otherwise this could cause a permanent damage.

1. Remove the stylus from its holder.
2. Hold the stylus as you would a pencil.
3. To make a choice from a menu, lightly tap the tip of the stylus on that choice.
4. To write data into a field on a form, use the stylus to print the letters or numbers. Use very light pressure.

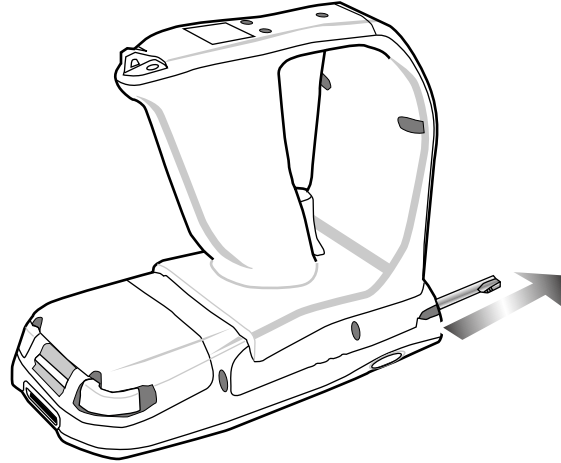

### Using the Laser Scanner

---

The RH767 has an integrated laser scanner which reads all major bar code labels with excellent performance.

**NOTE:** Reading software must be enabled in order to operate the scanner. This can be a userloaded application or a pre-loaded utility such as Scanner Setting.

Activate the laser scanner by pressing either one of the trigger keys located on the left and right side of the unit.

The RH767 has a built-in Scanner Setting utility that allows you to test the device's barcode scan function.

1. To launch Scanner Settings, press [FUNC] + [7].

**NOTE:** Alternatively, tap **Start** → **Settings** → **System** → **Scanner Settings**.

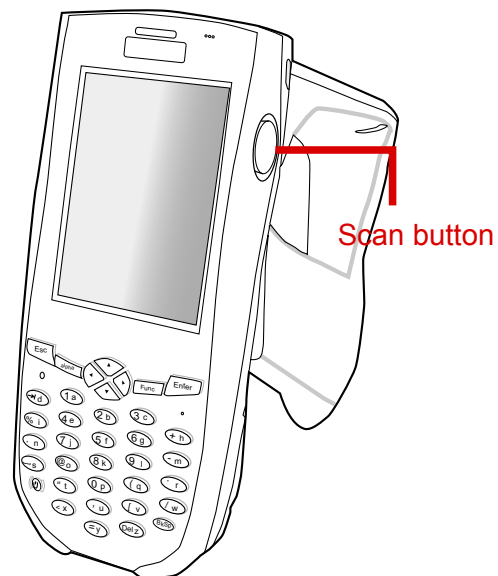

2. The Scanner Control Panel opens.

From here you can configure barcode scanner parameters such as enabling or disabling barcode symbologies, setting data transmission options, configuring magnetic and proximity reading options, and setting power management options.

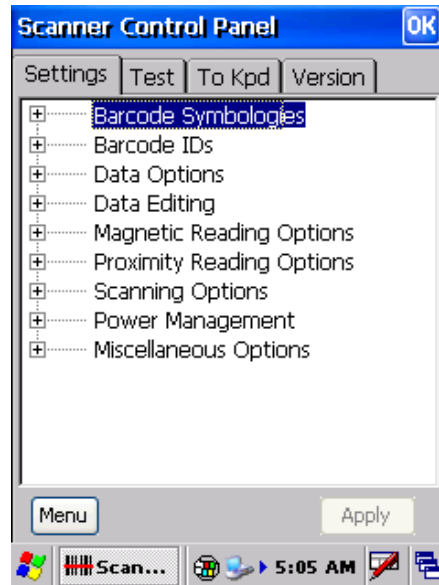

3. To test the barcode scanner, tap the Test tab and press one of the scanner buttons on a barcode. The screen will display the results of the scan.

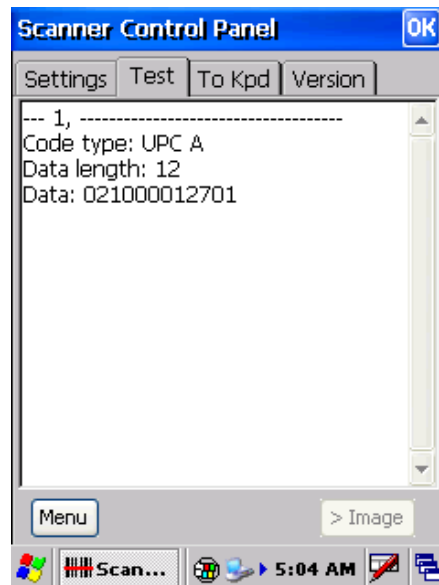

## Scanner Settings

When it is necessary for the user to change the default barcode symbology for a different application, the Scanner Control Panel provides the ability to change default symbology, place delimiter characters behind scanned data, and save the settings.

Press [FUNC] + 7 to display the Scanner Control Panel.

**NOTE:** Alternatively, tap **Start** → **Settings** → **System** → **Scanner Settings** to display the Scanner Control Panel.

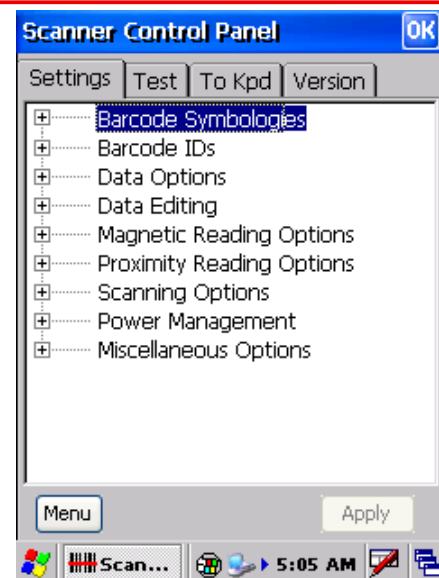

## Scan2Key

The Scan2Key application routes input from a scanner port to a keypad buffer, making all input from the scanner emulate input from the keypad. Using Scan2Key, scanned data can be directly input into a scanner port aware application such as MS Mobile Word.

Press [FUNC] + [7] to display the Scanner Control Panel, then tap **To Kpd** to access Scan2Key settings.

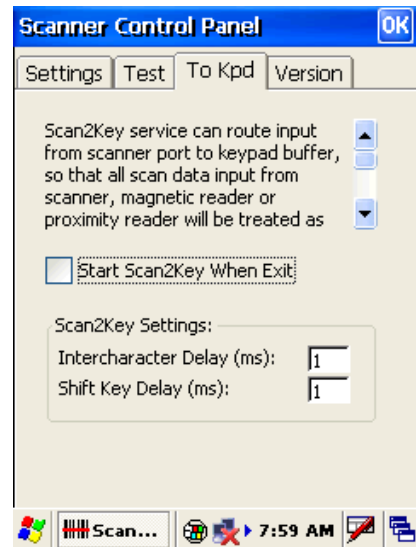

## Using the RFID

The RH767 RFID sample application is provided for reading RFID Class 0 and Class 1 Gen2 RFID tags. The RFID demo program is pre-loaded in the Flash Storage.

### Launching UHF RFID Demo Program

To launch the UHF RFID sample application,

1. Double-tap **My Device**, then double-tap **Flash Storage**.
2. Double-tap the **RFID&Scanner** folder, then double-tap the **UnitechRFID Demo** icon.

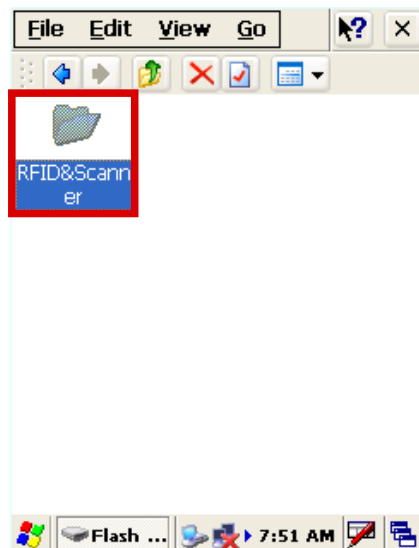
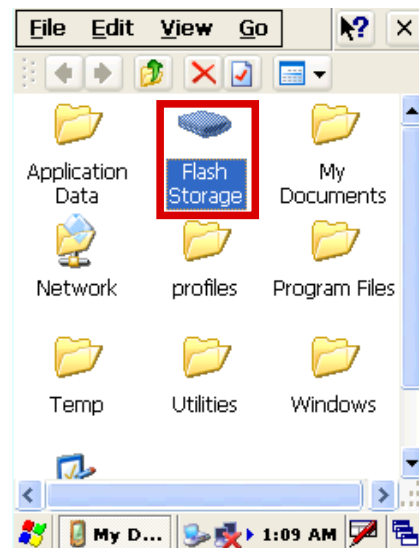

3. Tap the RFID tab, tap the **Setting** button.

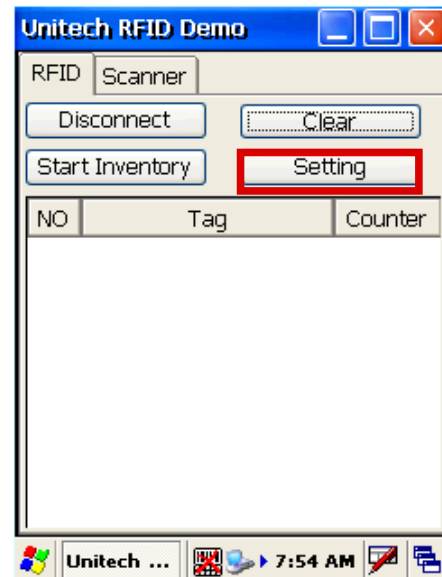

4. Select the Antenna **A**,

5. Select the Tag type check box to enable reading of Class0, Class1 and UHF Gen2 tags.

6. Set the RF Power by moving the slide bar to 27db (1W). Then close the setting window.

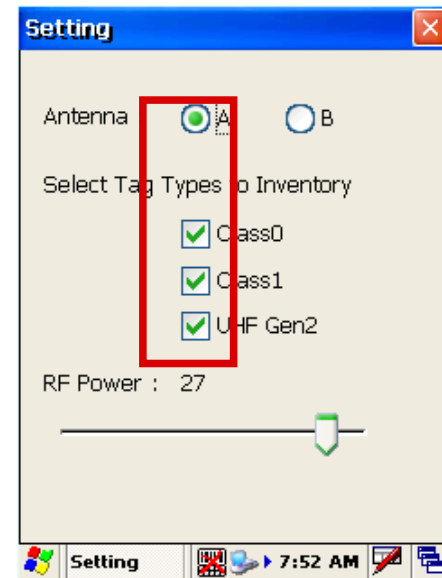

7. Select the **Start Inventory** button, The counter indicates incidents of continuous reading by the reader.

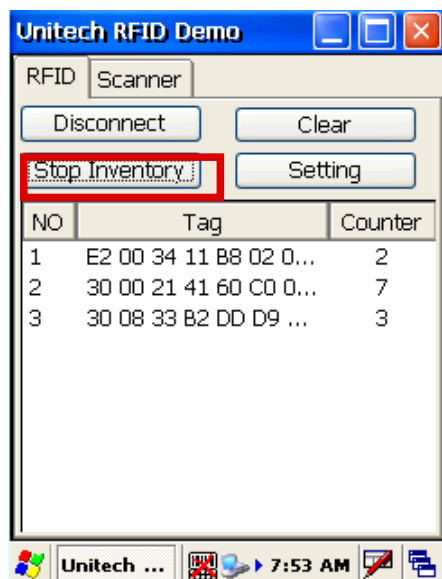

## Getting Connected

The unitech RH767 enables users to link to a host computer using an RS-232, IrDA, or WLAN connection for data communication. This chapter provides an overview of RH767 communication options.

### Establishing Device-PC Connection

#### Installing Microsoft ActiveSync

In order to exchange data between your computer and the RH767, Microsoft ActiveSync must be installed on your computer. Use the RS232 serial/charging cable that comes with your device to connect the device to your computer.

**NOTE:** If you have a previous version of the Microsoft ActiveSync installed in your computer, uninstall it first before installing the latest version of Microsoft ActiveSync. The RH767 Ultra Rugged Mobile Computer requires ActiveSync version 4.2 or higher.

To install Microsoft ActiveSync on your computer:

1. Close any open programs, including those that run at startup, and disable any virus-scanning software.
2. Download the ActiveSync software from the Microsoft ActiveSync Download page at <http://www.microsoft.com/windowsmobile/downloads/activesync42.msp>.
3. Browse to the location of the downloaded file, and double-click it. The installation wizard begins.
4. Follow the instructions on the screen to install Microsoft ActiveSync.

#### Connecting the Device to Your Computer

1. After ActiveSync has been installed, connect the RH767 to your PC as described in *Connecting the RH767 to a PC* on page 9.
2. Turn the RH767 on.
3. ActiveSync starts automatically and configure the USB port to work with the RH767. The New Partnership setup wizard automatically starts.



**NOTE:** If ActiveSync doesn't start automatically, click **Start** → **Programs** → **Microsoft ActiveSync**.

If a message appears indicating that it is unable to detect a connection, click the Cancel button and manually configure the communication settings.

4. Follow the onscreen instructions.

5. When the configuration process is complete, the ActiveSync window appears.

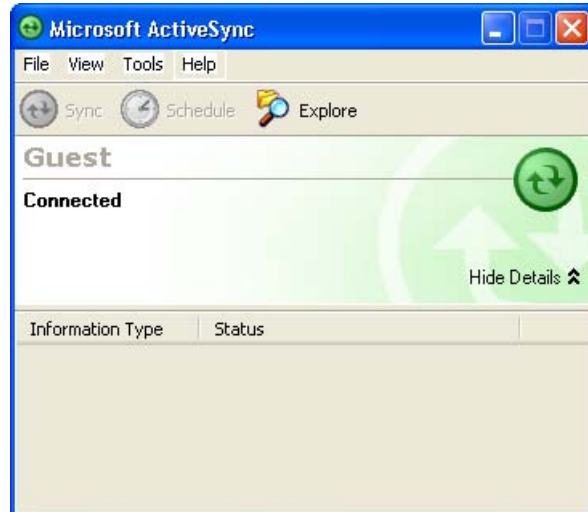

6. Synchronization will be initialized and will take place if you've chosen to synchronize periodically or upon connection.

**NOTE:** Your computer can create a partnership with multiple RH767s. Also, a RH767 can create a partnership with up to two computers.

## Using ActiveSync to Exchange Files

You can use ActiveSync to exchange information from your device your computer and vice versa. Changes you make to the information on one location will not affect the information on the other one. If you want to automatically update information on both your device and computer, synchronize the information instead.

You can copy two types of information to your device: files and Pocket Access Windows CE Store information.

The following procedure only applies to copying files. Refer to the ActiveSync Help on your computer for instructions on how to copy Pocket Access Windows CE Store information.

**NOTE:** Files created on your computer may need to be converted by ActiveSync so that they can be viewed and edited on your device, and vice versa.

To copy files:

1. Connect your device to your computer.
2. In ActiveSync on your computer, click Explore.



Windows Explorer opens the Mobile Device window for your device.

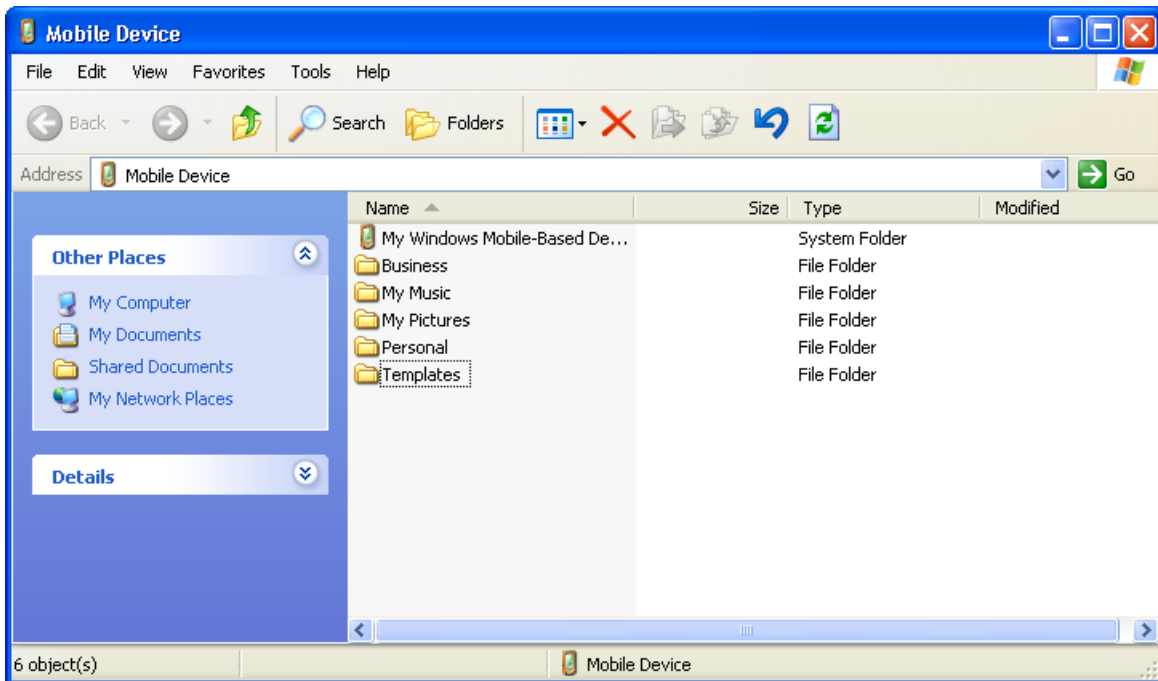

3. Locate the file that you want to copy on your device or computer.
4. Do either one of the following:
  - To copy the file to your device, right-click the file and click Copy. Place the cursor in the desired folder for your device, right-click, then click Paste.
  - To copy the file to your computer, right-click the file and click Copy. Place the cursor in the desired folder for your computer, right click, then click Paste.

## Using the WLAN

### Setting up the Wireless Local Area Network Card

The RH767 is pre-loaded with connection software. The RH767 automatically detects RF cards and then displays this screen during the first-time installation. Note that you can use one of the following two ways to set the IP address:

- Obtaining an IP Address via DHCP Server
- Specifying an IP Address

#### ***Obtaining an IP Address via DHCP Server***

Check with your MIS department to determine whether a DHCP server is available in your LAN environment. If available, tap the radio button next to Obtain an IP address via DHCP, and then tap the OK button.



## Specifying an IP Address

If there is no DHCP server in your LAN environment, assign IP addresses to each RH767 as follows:

1. Tap **Start** → **Settings** → **Control Panel** and then double-tap **Network and Dial-up Connections**.

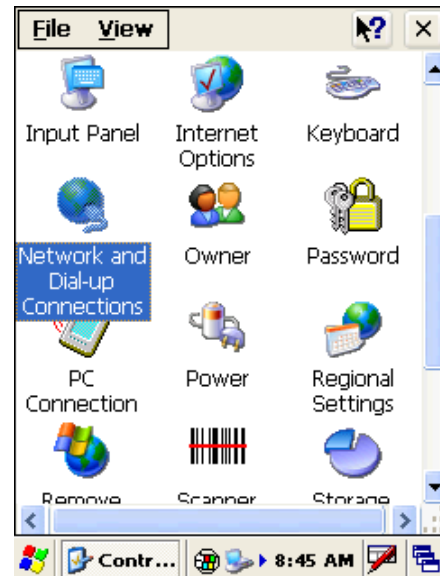

2. Tap the **BCMCF1** icon next to Specify IP Address.



3. Input the proper IP address, Subnet Mask, and Default Gateway.



4. Tap the Name Servers tab, and then input the proper Primary DNS, Secondary DNS, Primary WINS, and Secondary WINS.

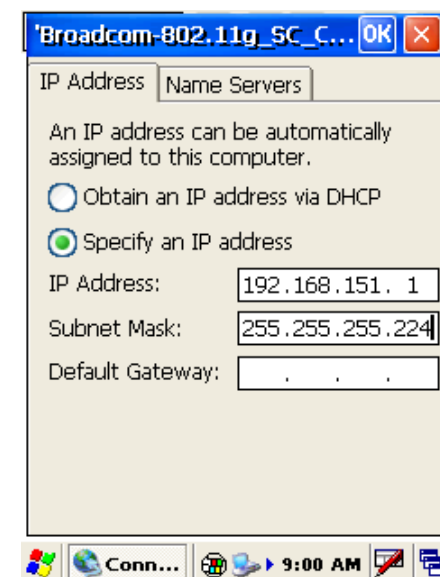

To avoid conflict with your LAN environment, consult with your MIS department for the correct TCP/IP setting.



## WiFi Connection

With the embedded WLAN module, you can send and receive signals to a WiFi network then synchronize files.

**NOTE:** WiFi access requires a separate purchase of a service contract with a wireless service provider. Contact a wireless service provider for more information.

A wireless network can be added either when the network is detected or by manually entering settings information. Before doing these steps, determine if authentication information is needed.

1. If present, double-tap the WIFI icon in the notification area to open the WIFI Properties screen.
2. Select the Wireless Information Tab.

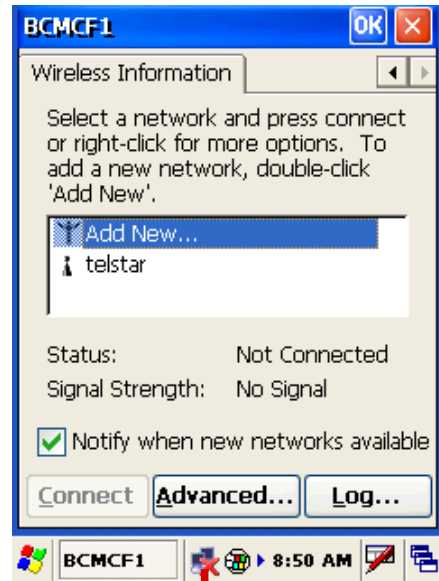

WiFi icon

3. If there are networks already detected, double-tap the network name to open the Wireless Properties dialog.
4. Type the SSID in the Network Name text box. An SSID (Service Set Identifier) is the name assigned to a wireless (Wi-Fi) network. All devices must use the same case-sensitive name to communicate. The name is a text string up to 32 bytes long.
5. Configure the remaining Wireless Properties, and tap OK.
6. Tap and hold the network name, then tap Connect.
7. When finished, tap OK.

For more information on how to configure the wireless network settings, tap Start → Help.



## Using the WiFi Tool

The WiFi tool enables you to get, renew, and release IP addresses, monitor the WiFi signal strength, and enable RF power saving mode.

1. Tap **Start** → **Programs** → **Communications** → **WiFiTool**.

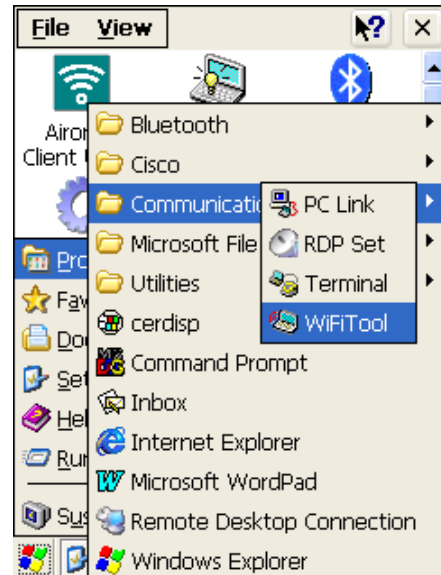

The WiFiTool screen appears.

The following tools are available in the utility.

- Info Tab: displays the wireless card's signal strength, and enables you to enable logging at specified intervals.
- IP Tab: enables you to assign an IP address to the RH767, renew an IP address, or release the RH767's IP address.
- AP List: shows AP information.
- RF Power Tab: enables you to set the wireless card's power saving mode:
  - CAM
  - MAX\_PSP
  - Fast\_PSP (\*)
  - MAX
- Ping: allows you to use the ping function to test the network.

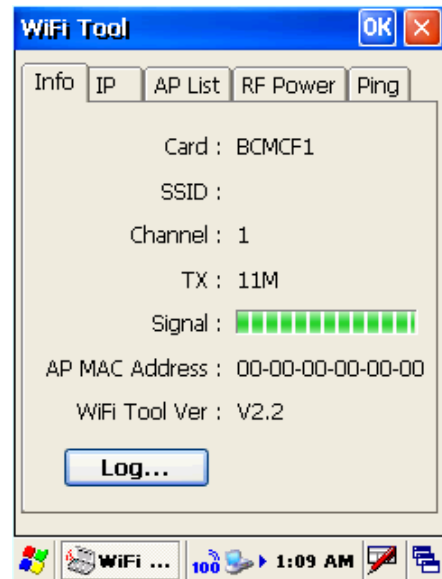

# Appendix

## Middleware Supporting List

- Oracle Sensor Edge Server
- Oracle Sensor Edge Mobile
- Oracle Database Lite
- Microsoft BizTalk R2

\*\* Please contact your unitech service team for detailed information of middleware supporting.

## System Specifications

<b>Hardware</b>	
Memory:	64 MB ROM / 64MB SDRAM
Microprocessor:	Intel X-Scale 400MHz
Display:	NEC 240*320 Transflective TFT Color LCD, support 256K color, with backlight, with touch screen.
<b>Operating System</b>	
	Microsoft Windows CE.NET5.0 Professional Plus
<b>Power</b>	
Battery Type:	Rechargeable Lithium-Ion
Battery System:	7.4V 4050mAh (double cell)
Battery Life:	RH767 UHF: Up to 16 hours
Recharging Time:	Within 6 hours when power status is very low
<b>Keypad with LED backlight</b>	
	36 key keypad with numeric key, alpha key and function key
<b>Standard Communications</b>	
	Bluetooth, 802.11b/g, USB 1.0, IrDA
<b>Scanner Engine</b>	Integrated SE950 laser scanner
<b>RFID Reader</b>	UHF 902~928MHz, EPCG1C0,C1, Gen 2
<b>Physical Characteristics</b>	Lx W x H: 7.17"3.46"5.91" Weight: RH767 UHF 26.81oz
<b>Environment</b>	
Operating Temp	-5° to 50°C
Storage Temp	-20° to 60°C
Relative Humidity:	5% to 95% (non-condensing)

<b>Key Accessories</b>	2 Slot Battery Charger 4 Slot Battery Charger 4 Slot Multi-bay Charging & Communication Cable
<b>Software Development Kit</b>	Unitech RH767SDK, RFID middleware SDK Microsoft Embedded Visual Tool
<b>Software</b>	Unitech RFID Middleware support Oracle Sensor Edge Server, Microsoft BizTalk RFID, IBM WebSphere
<b>Regulatory</b>	CE, FCC, VCCI, NCC, CCC