

ERS-7

Entertainment Robot AIBO

• User's Guide (Basic)



For Customers in the U.S.A.

Safety Information

Owner's Record

The model number and serial number are located inside the cover of the unit and on the side of the supplied AC adapter. Record the serial number in the space provided below. Refer to the model and serial number whenever you call upon your Sony® AIBO® Customer Link (customer service).

Model No. ERS-7

Serial No. _____

Warning

- To prevent fire or shock hazard, do not expose the robot to rain or moisture.
- To avoid electrical shock, do not open the enclosure. Refer servicing to qualified personnel only. (Contact the AIBO Customer Link for customer service.) (page 5)
- Periodically examine the AC adapter for conditions that may result in the risk of fire, electrical shock, or injury to persons (such as damage to the cords, blades, housing) and in the event of such conditions, the AC adapter should not be used until properly repaired or replaced.
- Not intended for children under 8 years old.
- This device complies with Part 15 of the FCC Rules. Operation is subject to the following two conditions: (1) This device may not cause harmful interference, and (2) this device must accept any interference received, including interference that may cause undesired operation.

Regulatory Information

This equipment has been tested and found to comply with the limits for a Class B digital device, pursuant to Part 15 of the FCC Rules. These limits are designed to provide reasonable protection against harmful interference in a residential installation. This equipment generates, uses, and can radiate radio frequency energy and, if not installed and used in accordance with the instructions, may cause harmful interference to radio communications. However, there is no guarantee that interference will not occur in a particular installation. If this equipment does cause harmful interference to radio or television reception, which can be determined by turning the equipment off and on, the user is encouraged to try to correct the interference by one or more of the following measures:

- Reorient or relocate the receiving antenna.
- Increase the separation between the equipment and receiver.
- Connect the equipment into an outlet on a circuit different from that to which the receiver is connected.
- Consult the dealer or an experienced radio/TV technician for help.

You are cautioned that any changes or modifications not expressly approved in this manual could void your authority to operate this equipment.

The shielded interface cable recommended in this manual must be used with this equipment in order to comply with the limits for a digital device pursuant to Subpart B of Part 15 of FCC Rules.

Note

FCC RF Radiation Exposure Statement: This equipment complies with FCC RF radiation exposure limits set forth for an uncontrolled environment. This device and its antenna must not be co-located or operating in conjunction with any other antenna or transmitter.

DISPOSAL OF LITHIUM-ION BATTERY

LITHIUM-ION BATTERY DISPOSE OF PROPERLY

You can return your unwanted Lithium-Ion batteries to your nearest Sony® Service Center.

Caution

In some areas the disposal of Lithium-Ion batteries in household or business trash may be prohibited.

For the Sony AIBO® Customer Link call 1-800-427-2988 in the United States or contact us via e-mail at aibosupport@info.sel.sony.com.

- ! Do not handle damaged or leaking Lithium-Ion batteries.
- ! Danger of explosion if the battery is incorrectly replaced. Replace only with the ERA-7B1. Use of another battery may present a risk of fire or explosion. Discard used batteries according to the manufacturer's instructions.
- ! The battery used in this device may present a fire or chemical burn hazard if mistreated. Do not disassemble, heat above 140°F (60°C) or incinerate. Dispose of used battery promptly. Keep away from children.

RECYCLING LITHIUM-ION RECHARGEABLE BATTERIES



Lithium-Ion batteries are recyclable. You can help preserve our environment by returning your used rechargeable batteries to the collection and recycling location nearest you.

For more information regarding recycling of rechargeable batteries, call toll free 1-800-822-8837, or visit <http://www.rbrc.org/>

Caution: Do not handle damaged or leaking Lithium-Ion batteries.

For Customers in Europe

Safety Information

WARNING

- To prevent fire or shock hazard, do not expose the robot to rain or moisture.
- To avoid electrical shock, do not open the enclosure. Refer servicing to qualified personnel only. (Contact the AIBO Customer Link for customer service.) (page 5)
- Periodically examine the AC adapter for conditions that may result in the risk of fire, electric shock, or injury to persons (such as damage to the cords, blades, housing) and in the event of such conditions, the AC adapter should not be used until properly replaced.
- The robot is not intended or recommended for children under 8 years old.
- The robot must be used only with the recommended AC adapter (ERA-201P1).
- The AC adapter is not a toy.
- Small parts can be swallowed.
- If the external flexible cable or cord is damaged, it must be replaced or repaired only by the manufacturer, an authorized service agent or a similar qualified person in order to avoid a hazard.
- All material for fastening or packing purposes are not part of the robot and should be discarded for children's safety.
- Rechargeable batteries are only to be charged under adult supervision.

Regulatory Information

This product has been tested and found to conform to the following Safety Standards.

Toy Directive 88/378/EEC

EMC Directive 89/336/EEC

LVD Directive 73/23/EEC

R&TTE Directive 1999/5/EC

We, Sony® Corporation, hereby declare that AIBO® Entertainment Robot, model ERS-7 is in compliance with the essential requirements and other relevant provisions of Directive 1999/5/EC.

For details, please access the following URL:
<http://www.compliance.sony.de/>



CE (EMC) Marking Conformity Remarks

- a) This equipment complies with EN55022. Class B digital for use in following areas: residential, business, and light-industrial.
- b) This product conforms with the following European Directive:
89/336/EEC (EMC directive)

DISPOSAL OF LITHIUM-ION BATTERY

- ! Do not handle damaged or leaking Lithium-Ion batteries.
- ! Danger of explosion if the battery is incorrectly replaced. Replace only with the ERA-7B1. Discard used batteries according to the manufacturer's instructions.
- ! The battery used in this device may present a fire or chemical burn hazard if mistreated. Do not disassemble, heat above 60 °C (140 °F) or incinerate. Dispose of used battery promptly. Keep away from children.

Voor de Klanten in Nederland (For customers in the Netherlands)



Gooi de batterij niet weg maar lever deze in als klein chemisch afval (KCA).

Opmerking betreffende de geheugen-backupbatterij

(Note on a battery for memory backup)



Dit apparaat bevat een vast ingebouwde batterij die niet vervangen hoeft te worden tijdens de levensduur van het apparaat. Raadpleeg uw leverancier indien de batterij toch vervangen moet worden.

De batterij mag alleen vervangen worden door vakbekwaam servicepersoneel.

Gooi de batterij niet weg maar lever deze in als klein chemisch afval (KCA).

Lever het apparaat aan het einde van de levensduur in voor recycling, de batterij zal dan op correcte wijze verwerkt worden.

Für Deutsch Kunden und Kundinnen (For customers in Germany)

Entsorgungshinweis: Bitte werfen Sie nur entladene Batterien in die Sammelboxen beim Handel oder den Kommunen. Entladen sind Batterien in der Regel dann, wenn das Gerät abschaltet und signalisiert „Batterie leer“ oder nach längerer Gebrauchsdauer der Batterien „nicht mehr einwandfrei funktioniert“. Um sicherzugehen, kleben Sie die Batteriepole z.B. mit einem Klebestreifen ab oder geben Sie die Batterien einzeln in einen Plastikbeutel.

Customer Support

How can you contact the AIBO Customer Link (customer service)?

In the U.S.A.:

Call 1-800-427-2988

E-mail address: aibosupport@info.sel.sony.com

In Europe:

English line: +44(0)-20-7365-2937

German line: +49(0)-69-9508-6309

French line: +33(0)-1-5569-5117

© 2003 Sony Corporation.

Reproduction in whole or in part without written permission is prohibited. All rights reserved.

Opening the package (Checking the supplied items)

Check to see if you have the following items before starting to play with the AIBO[®] Entertainment Robot.

- AIBO Entertainment Robot ERS-7

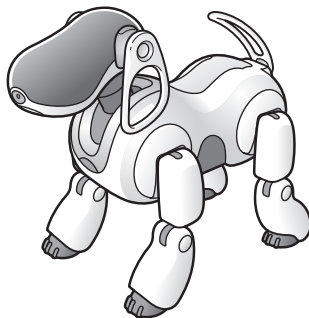

- AIBO-ware “Memory Stick™” media

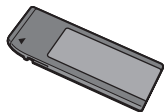

- Lithium-ion battery pack

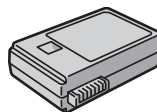

- Energy Station

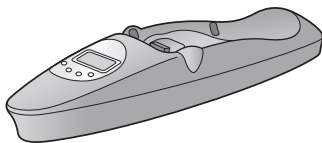

- Energy Station AC adapter

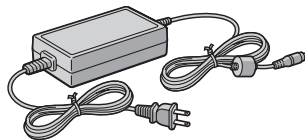

- Self-charge markers (must be mounted on the Energy Station)

- Station marker



- Station pole

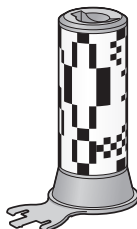

- Foot stopper

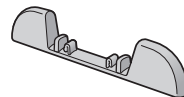

- AIBOne toy



- Pink ball



- AIBO[®] cards (15)

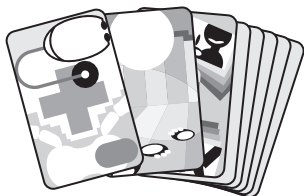

- “User’s Guide (PC·Network)” for the AIBO robot ERS-7/AIBO WLAN Manager CD-ROM*



- Printed materials



- “User’s Guide (Basic)” for the AIBO robot ERS-7 (this document)
- Other brochures
- Quick Guide
- Software License Agreement
- Limited Warranty Card

* The “User’s Guide (PC·Network)” for the AIBO robot ERS-7 is included on the supplied CD-ROM in PDF format. Adobe[®] Acrobat[®] Reader[®] 5.0, or Adobe Reader 6.0 or later is required to view the PDF files on the supplied CD-ROM.

Before using this product, be sure to read the supplied “Software License Agreement”.



“OPEN-R” is the standard interface for the AIBO[®] Entertainment Robot system that Sony[®] is actively promoting. This interface expands the capability of the entertainment robot through a flexible combination of hardware and interchangeable software to suit various applications. The AIBO Entertainment Robot ERS-7 conforms to OPEN-R version 1.1.5.

“AIBO”, the AIBO logo , “OPEN-R” and the OPEN-R logo , “Memory Stick”, “” and “MEMORY STICK” are trademarks or registered trademarks of Sony Corporation.

Adobe Acrobat, and Reader are registered trademarks of Adobe Systems Incorporated.



The visual pattern recognition software used for “AIBO MIND” incorporates technology developed by Evolution Robotics, Inc. The logo shown on the left is a trademark of Evolution Robotics, Inc.



**Vegetable
based
Plastic**

The toes, station pole, and foot stopper of the AIBO robot are manufactured using environment-friendly vegetable-based plastics.

Other information about the AIBO robot is available on the Internet at the following site:
<http://www.aibo.com>

Table of contents

Introduction

What is an Autonomous Robot?	14
What is the AIBO® Entertainment Robot?	14
Autonomous activities of the AIBO robot	14
Emotions and instincts of the AIBO Entertainment Robot	15
It's a robot, but it develops	15
About the AIBO Entertainment Robot ERS-7	16
Features of the AIBO robot	16
Features of the AIBO MIND software	17
Guide to parts and their functions	20
The AIBO Entertainment Robot ERS-7 parts	20
The AIBO Entertainment Robot (stomach)	22
Energy Station	24

Playing with the AIBO Entertainment Robot

Getting started	28
Preparing the AIBO robot	28
Preparing the Energy Station	30
Playing with the AIBO Entertainment Robot	33
Various interactions	34
Let the AIBO Entertainment Robot rest on the Energy Station	35
Placing the AIBO robot on the Energy Station	35
Removing the AIBO robot from the Energy Station	35
Stopping the AIBO Entertainment Robot activity	36

Modes and Conditions of the AIBO Entertainment Robot

Modes and conditions	38
The AIBO Entertainment Robot feature and mode map	40
Changing modes	42

Living with the AIBO® Entertainment Robot

Determining the AIBO Entertainment Robot's lifestyle rhythm	44
Determining the AIBO robot's period of activity	44
Switching the AIBO robot's chime ON and OFF	47
Enabling/Disabling the AIBO Entertainment Robot's alarm clock	49
Charging	51
How to charge the AIBO robot	51
The AIBO Entertainment Robot charges on its own (self-charge)	52
When the AIBO robot recharge is not successful	55

Communicating with the AIBO Entertainment Robot

From you to the AIBO Entertainment Robot	58
Sight	58
Touch	58
Talking to the AIBO robot	59
Giving the AIBO Entertainment Robot its own name	60
Teaching the AIBO Entertainment Robot to recognize your name and face	61
Using AIBO cards	63
From the AIBO Entertainment Robot to you	64
Having the AIBO Entertainment Robot take a pictures	66

Raising the AIBO Entertainment Robot

Enjoying the AIBO Entertainment Robot's development	70
Learning and acquiring skills	75
The AIBO Entertainment Robot's feelings and personality development	76

Playing in Game mode

Playing Game 1, the AIBO Entertainment Robot's "Function Demo"	78
--	----

Settings

Setting the volume level of the AIBO® Entertainment Robot	82
Adjusting the volume with an AIBO card	82
Adjusting the volume with the control switch on the AIBO Entertainment Robot	83
Adjusting the volume using the Energy Station	84
Changing the date and time	85
Setting the date and time	85
Setting the time zone	86
Changing the date and time display format	88
Turning the wireless LAN function ON and OFF	89

Additional Information

Notes on use	92
Handling the AIBO robot	92
“Memory Stick” media handling	93
Energy Station handling	94
AC adapter handling	95
Battery handling	95
Cleaning	95
Troubleshooting	96
Check this first	96
Checking with Clinic mode	101
Limited warranty (for the U.S.A. only)	107
Service procedure (for the U.S.A. only)	109
Specifications	110

Reference Material

AIBO card at a glance	114
Front and back	114
List of AIBO cards	115
Words understood by the AIBO Entertainment Robot	116
Time zone table	118

Introduction

Welcome to the world of the AIBO® Entertainment Robot ERS-7!

Living together with you, the AIBO robot ERS-7 will develop into a pet that is uniquely yours.

Before beginning your life together with the AIBO robot, please familiarize yourself with the following.

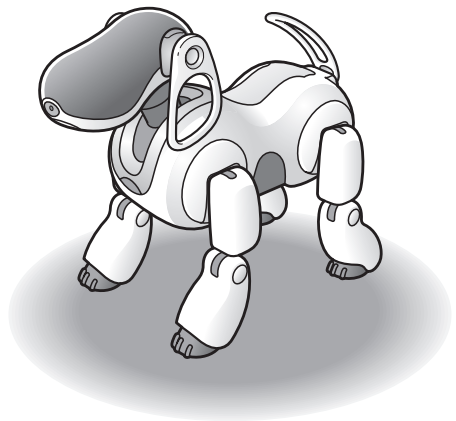

What is an Autonomous Robot?

.....

What is the AIBO[®] Entertainment Robot?



The AIBO robot is the name which Sony[®] has given to its family of entertainment robots, robots that are designed with the goal of presenting a vision for a new type of lifestyle in which human beings derive enjoyment from mutual existence with robotic creatures. The name itself is a play on the words “artificial intelligence” (AI) and “robot”, or a robot with eyes. In its home country, Japan, the word “AIBO” also means “partner” or “sidekick”.

For the latest information on the AIBO robot, visit the following Web site:
<http://www.aibo.com>

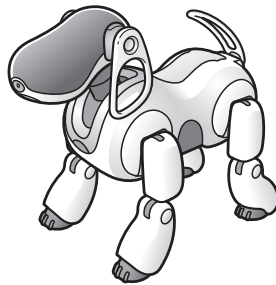

Autonomous activities of the AIBO robot

The AIBO robot combines a body (hardware) and mind (the AIBO MIND software) that allow it to move, think, and display the lifelike attributes of emotion, instinct, learning, and growth.

It establishes communication with people by displaying emotions, and assumes various behaviors (autonomous actions) based on information which it gathers from its environment. The AIBO robot is not only a robot, but an autonomous robot with the ability to complement your life.

While living with you, the AIBO robot’s behavioral patterns will develop as it learns and grows. When it finds you, it will approach you joyfully, perhaps bringing its “AIBOne toy” along in an attempt to get you to play. On the other hand, when its attention is elsewhere, you may find that the AIBO robot ignores you even when you talk to it. By understanding such autonomous behavior, you will get even more enjoyment out of your life with the AIBO robot.

Emotions and instincts of the AIBO[®] Entertainment Robot

Emotions and instincts form the basis for the AIBO robot's autonomous behavior.

Based on all sorts of factors which it picks up from its surroundings, the AIBO robot undergoes changes in spirit that display themselves in the form of emotional expression. The AIBO robot possesses the following five basic instincts:

- Love instinct:** This instinct displays itself as a desire to communicate with people.
- Search instinct:** This instinct displays itself as a desire to satisfy its curiosity.
- Movement instinct:** This instinct displays itself as a desire to move about.
- Recharge instinct:** This instinct displays itself as a desire to find a source of electricity to power its operation—just like the human instinct to eat.
- Sleep instinct:** This instinct displays itself as sleepy behavior.

For example:

Sometimes it will want to do things on its own, and sometimes it will seek your help.

Sometimes it will think deeply before acting, and sometimes it will act on the spur of the moment.

Sometimes its mood will be happy, and sometimes it will display all the signs of annoyance.

Ultimately, the convergence of these instincts becomes noticeable as the AIBO robot's personality.

It's a robot, but it develops

When the AIBO robot is first adopted, it is set to wake up and act as an adult. However, you can also choose to have the AIBO robot begin life with you as a newborn puppy for you to raise and watch as it develops.

How can the AIBO robot develop, even though it's a robot?

That is because the AIBO robot is an "Entertainment Robot", designed to live with people.

Upon joining your household, the AIBO robot adjusts itself to your life; that is the nature of the AIBO robot's "development".

We hope that the AIBO robot will become your faithful companion.

About the AIBO[®] Entertainment Robot ERS-7

The AIBO robot ERS-7 consists of the combination of the AIBO robot itself, and software (“AIBO-ware”) that is recorded on a Sony[®] “Memory Stick[™]” media. The “AIBO-ware” software is what constitutes the AIBO robot’s character and personality.

The present guide explains how the AIBO robot will develop and act with the AIBO MIND software.

Features of the AIBO robot

The AIBO robot has all the functions and capabilities needed to move about by itself.

A variety of senses

The AIBO robot is equipped with a variety of sensors that give it “senses”, used to make judgments about its conditions in its surroundings.

- Sense of touch: The AIBO robot has touch sensors on its head, back, chin, and paws, allowing it to feel human contact.
- Sense of hearing: The AIBO robot detects sounds in its environment through a pair of stereo microphones. This makes it possible for it to respond to your voice.
- Sense of sight: The AIBO robot is equipped with a color camera and distance sensors. This allows it to seek colors it likes, and to avoid obstacles. It can also recognize your face.
- Sense of balance: The AIBO robot keeps its balance by means of acceleration sensors.

Natural, varied, and expressive movements

The AIBO robot has a vast range of natural and expressive movements. Integrated control over the operation of the 20 joints in the AIBO robot’s body (20 degrees of freedom), makes it possible for the AIBO robot to achieve a rich variety of natural-looking movements.

The AIBO robot is also equipped with face lights and the ability to generate musical tones, which it uses to express its emotional and physical condition.

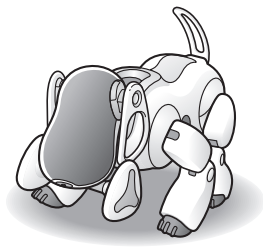

Features of the AIBO[®] MIND software

When the AIBO MIND software is installed in the AIBO Entertainment Robot, it learns from you and its environment, acting on its free will as it develops into your very own AIBO robot.

The AIBOne toy and pink ball are its favorite toys!

The AIBO robot really loves its AIBOne toy and pink ball! Since it regards them as its favorite toys, if it doesn't see them for a while, it will begin to search for them. If you use them to play with AIBO, you may be surprised by some of the tricks it performs!

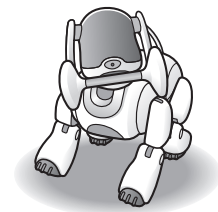

Communication by AIBO card

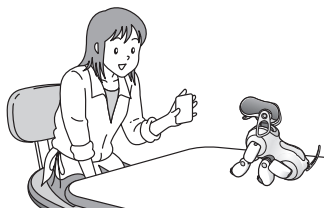

The AIBO robot is capable of understanding the meaning of the graphics on AIBO cards. By showing an AIBO card to the AIBO robot, you can easily make various settings, have the AIBO robot perform tricks, and enjoy a variety of activities. Using AIBO cards, you can be sure of smooth communication with the AIBO robot even when your surroundings are noisy.

* Some AIBO cards serve dual functions, depending on how they are presented when you show them to the AIBO robot.

In this guide, the things you can do with AIBO cards are noted with the  icon. For a full list of available AIBO cards, see “List of AIBO cards” (page 115).

Each AIBO robot is unique

The AIBO robot will develop into a pet that is uniquely yours.

Whether it develops into an AIBO robot with a deep love of communication, or becomes accomplished at playing by itself will depend on how you interact with AIBO.

By using AIBO Custom Manager (supplied separately)*, you can play new games with the AIBO robot and have it dance and sing according to your wishes.

Note

To be able to use AIBO Custom Manager (supplied separately. For available updates, visit <http://www.aibo.com>)*, your computer must meet the following requirements.

- Operating system: Windows[®] XP Home Edition or Professional, Windows[®] 2000 Professional, Windows[®] Me, or Windows[®] 98 SE
- CPU: MMX Pentium 300 MHz or faster
- Memory: 64 MB or more
- Available hard disk space: 120 MB or more
- Display: 16-bit color display or higher; 800x600 pixels or more
- Equipped with a CD-ROM drive
- Capable of reading “Memory Stick[™]” media

* AIBO Custom Manager (supplied separately. For available updates, visit <http://www.aibo.com>) is software that runs on a computer.

The AIBO[®] Entertainment Robot matches your lifestyle.

The AIBO robot matches the rhythm of its life to yours.

It will wake you in the morning, and at night, go to bed at the same time you do. (For details, see page 44.) When it is “hungry”, it will self-charge on the Energy Station, which it locates by recognizing the station's pole and markers, and when it is “tired”, it simply relaxes. The AIBO robot also loves playing with you, but is perfectly capable of amusing itself with its AIBOne toy and pink ball. When you go out, it will take pictures upon your command, and can spend time alone at home on the Energy Station.

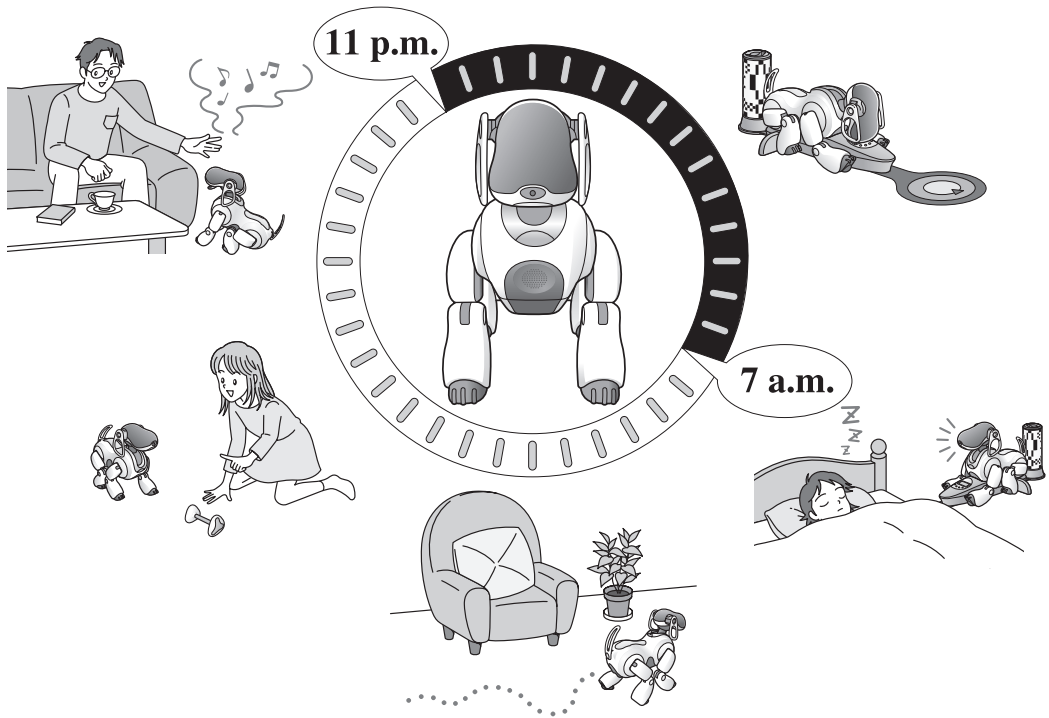

Game mode

In Game mode, you can enjoy playing any of three different games with the AIBO[®] Entertainment Robot. Game Mode 1 is AIBO robot's demo function. This is the only game provided with the AIBO robot when you first take it home. In the future, you will be able to add more games to the AIBO robot, using AIBO Custom Manager (supplied separately)* when more content is released from Sony[®].



Notes

- Customization is the process of adding new functions to AIBO-ware, modifying it to suit your preferences.
- For the latest information on AIBO Custom Manager (supplied separately)* and available content, visit our Web site at <http://www.aibo.com>.

* AIBO Custom Manager (supplied separately) is software that runs on a computer.

Use your mobile communication device*¹ and the Internet for even greater enjoyment

You can use your PC, mobile communication device*¹ or the Internet to mail commands to the AIBO robot and have it take pictures while you are away, or have it convey messages to nearby family or friends. You can view pictures that the AIBO robot takes using a Web browser. The following facilities are required in order to take advantage of the AIBO robot through a mobile communication device*¹ or the Internet.

For details on how to use the AIBO robot through a mobile communication device*¹ or the Internet, refer to the “User’s Guide (PC-Network)” for the AIBO robot ERS-7 (PDF) on the supplied CD-ROM. Note that Adobe[®] Acrobat[®] Reader[®] 5.0, or Adobe Reader 6.0 or higher is required to view the User’s Guide.

The following are required to give commands to the AIBO robot through your PC, mobile communication device*¹, or the Internet.

- A “Memory Stick[™]” media reader/writer (Sony brand is recommended.)
- When connecting your computer and Access Point by wireless LAN, the PC side must conform to IEEE 802.11b.
- In order to use the AIBO EYES feature, you must have an e-mail account that allows POP*² reception and SMTP transmission.

*¹ Caution: Your PC or mobile communication device must be able to receive JPEG e-mail.

*² The POP server must support the UIDL command (the command that displays a listing of IDs attached to individual mail messages). Check with your provider to determine whether support is available for your e-mail account.

Guide to parts and their functions

.....

The AIBO[®] Entertainment Robot ERS-7 parts

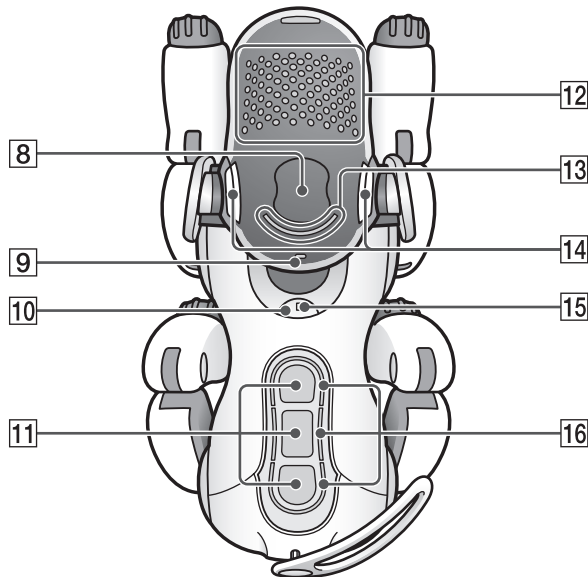
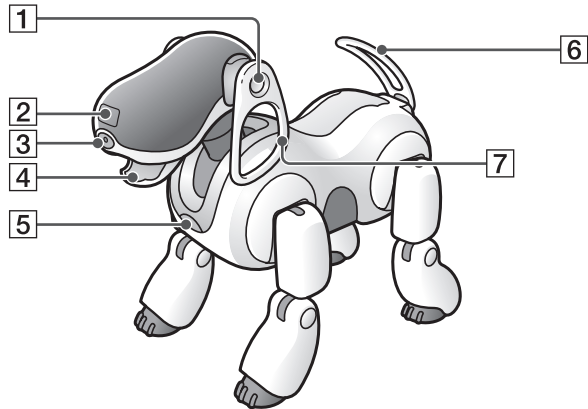

Caution

- Do not cover the color camera lens or distance sensors with stickers or similar objects.
- Do not limit the AIBO robot's freedom of movement by affixing stickers to the AIBO robot's joints or inserting objects into moving parts.
- When lifting the AIBO robot, be sure to handle it by its body (page 33). To avoid damage to the AIBO robot, never lift it by its head, ears, legs, tail, or any other part.

1 Stereo microphones

Allow the AIBO[®] Entertainment Robot to listen to the surrounding environment.

2 Head distance sensor

Measures the distance between the AIBO robot and other objects.

3 Color camera

Detects the color, shape, and movement of nearby objects.

4 Mouth

Picks up the AIBOne toy and expresses emotions.

5 Chest distance sensor

Measures the distance between the AIBO robot and other objects.

6 Tail

Moves up, down, left, and right to express the AIBO robot's emotions.

7 Ears

Indicate the AIBO robot's emotions and condition.

8 Head sensor

Detects and turns white when you gently stroke the AIBO robot's head.

9 Wireless light (on the back of the AIBO robot's head)

Blue light for use with the Wireless LAN function.

10 Pause button

When pressed, the AIBO robot's activity will pause or resume.

11 Back sensors (front, middle, and rear)

Detect and turn white when you gently stroke the AIBO robot's back.

12 Face lights

These lights turn various colors to show the AIBO robot's emotions and conditions.

13 Head light

Detects and turns white when you touch the head sensor.

Turns orange when an AIBO robot's joint is jammed (page 39).

14 Mode indicators (inner side of ears)

These indicate the present mode and condition of the AIBO robot (page 38).

15 Operation light

During operation: turns green.

During preparation for shutdown: flashes green.

During charging: turns orange.

When a charging error occurs: flashes orange.

When operation stops: turns off.

16 Back lights (front, middle, and rear)

Detect and turn white when you gently touch the AIBO robot's back sensors.

These lights also turn blue (front), orange (middle), and red (rear) to indicate a variety of actions.

The AIBO[®] Entertainment Robot (stomach)

This shows the AIBO robot with its stomach compartment cover off.

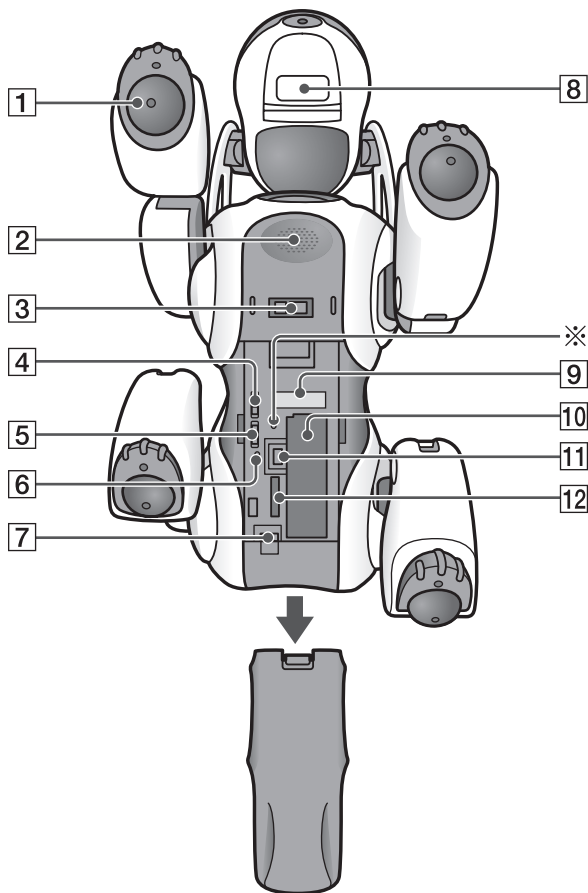

Caution

Do not touch the charging contacts with your bare hands. Touching the contacts will reduce contact quality.

1 Paw sensors

These are located on the bottom of the AIBO[®] robot's paws, and detect contact with any surface it touches. When the AIBO robot extends one of its paws, it will react with happiness if you touch it.

2 Speaker

Emits music, sound effects, and voice guide.

3 Charging terminal

When you place the AIBO robot on the Energy Station, this part makes contact with the station to allow charging of the AIBO robot's battery.

4 Volume control switch (VOLUME)

Adjusts the volume of the speaker to one of four levels (including mute).

5 Wireless LAN switch (WIRELESS)

This turns the AIBO robot's wireless LAN function ON or OFF.

6 "Memory Stick™" media access indicator

This indicator turns on while the AIBO robot is reading or writing to a "Memory Stick" media. While the indicator is ON, you cannot remove the "Memory Stick" media or battery by means of the "Memory Stick" media eject button (▲) or the battery latch (▲). Under this circumstance, never attempt to forcibly remove the "Memory Stick" media.

7 Battery pack latch (BATT ▲)

Flip this latch to the rear when you want to remove the battery.

8 Chin sensor

Senses when you touch the AIBO robot's chin.

9 FCC ID/MAC address label

Indicates the FCC ID and MAC address of the AIBO robot's wireless unit.

10 Battery slot

Holds the AIBO robot's lithium-ion battery.

11 "Memory Stick" media eject button (▲)

Press to eject the "Memory Stick" media.

12 "Memory Stick" media slot

This is where you insert the provided AIBO-ware "Memory Stick" media.

*** Emergency eject hole**

If you experience difficulties ejecting the "Memory Stick" media or battery because of a malfunction or operation problems, place the AIBO robot in Pause mode, and then insert an object such as a paper clip into the emergency eject hole.

(Do not use fragile objects, such as toothpicks, into the emergency eject hole as they may break.)

Under normal circumstances, you do not need to use the emergency eject hole.

Energy Station

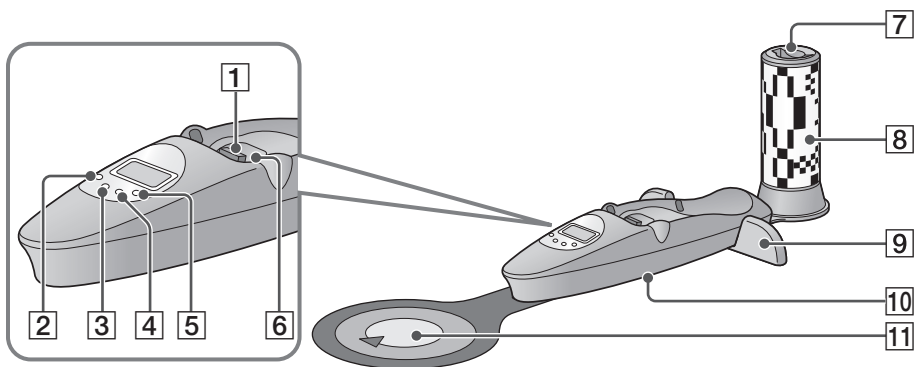

LCD Panel

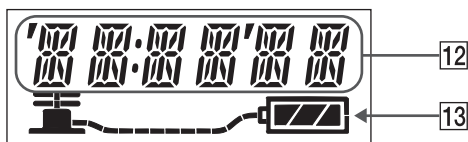

1 Charging Contacts

When you place the AIBO[®] Entertainment Robot on the Energy Station, the charging contacts on the AIBO robot's stomach connect to the station and the AIBO robot's battery is charged.

2 SET/CANCEL button

Press this button to put the display panel into the setting mode. Press it a second time to return the display to the normal mode.

3 MODE/NEXT button

Press to change the indication in the display panel. In the setting mode, pressing this button changes the item you are setting.

4 DISPLAY/- (minus) button

When the date or time indication is displayed, press this button to change the display format. In the setting mode, each press of the button decreases the value. Hold down the button to decrease the value continuously.

5 LIGHT/+ (plus) button

In the normal mode, press this button to turn ON the backlight. In the setting mode, press this button to increase the value that is displayed. Holding down the button increases the value continuously.

6 Placement detection switch

Detects when the AIBO robot is positioned on the Energy Station.

- 7 AIBO® card pocket**
This holds the provided AIBO cards.
- 8 Station pole**
The AIBO robot uses this as a reference guide to determine the position of the Energy Station when self-charging.
- 9 Foot stopper**
These guides help the AIBO robot to correctly position itself when sitting on the Energy Station to self-charge. (The AIBO robot mounts the Energy Station by backing on to it.)
- 10 AC Adapter terminal (on the base of the Energy Station)**
Connect this terminal to the AC adapter supplied with the AIBO robot or the optional AC adapter ERA-201P1.
- 11 Station marker**
The AIBO robot uses this as a reference guide to determine the position of the Energy Station when self-charging.
- 12 Date / Time / Time zone / Volume level indication**
- 13 Battery indicator**
Indicates the AIBO robot's battery level.

In this guide, the Energy Station (ERA-7P1) is referred to as the “Energy Station”.

Playing with the AIBO[®] Entertainment Robot

Now, let's try playing with the AIBO robot. At first, the AIBO robot will come to life as a mature robot.

Here we will describe how to prepare and play with the AIBO robot, and provide further information, such as how to place the AIBO robot on the Energy Station.

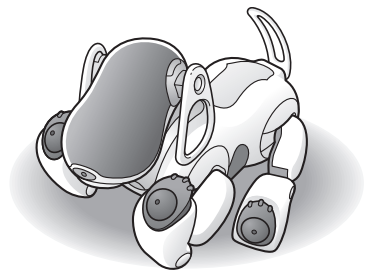

Getting started

To start out, you will need the AIBO[®] Entertainment Robot and the Energy Station. The supplied battery is delivered with minimal charge. Before you begin playing with the AIBO robot, you must fully charge the battery. See page 51 for detailed instructions on charging the battery.

First insert the battery and AIBO MIND software “Memory Stick[™]” media into the AIBO robot and set up the Energy Station. Charge the battery.

Preparing the AIBO robot

Insert the battery and AIBO MIND software “Memory Stick” media into the AIBO robot.

- 1** Securely hold the body of the AIBO robot from above, turn it upside down, and open the stomach compartment cover.

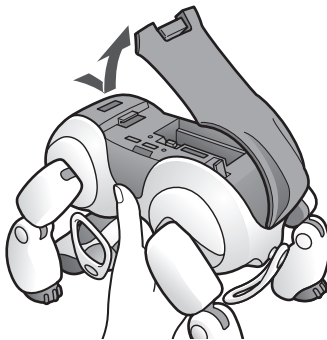

Caution

- Always lift the AIBO robot by its body, not by its extremities.
- Do not touch the charging contacts located on the AIBO robot with your hand. Touching the contacts will reduce contact quality.

- 2** Take out the AIBO MIND software “Memory Stick” media from its plastic case.

Slide the lid toward the ◀ mark.

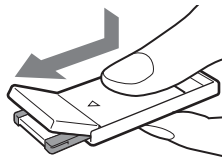

3 Insert the AIBO MIND software “Memory Stick™” media into the AIBO® Entertainment Robot.

With the arrow pointing down and the angled corner facing the AIBO robot’s tail, insert the AIBO MIND software “Memory Stick” media into the AIBO robot until it is flush with the body.

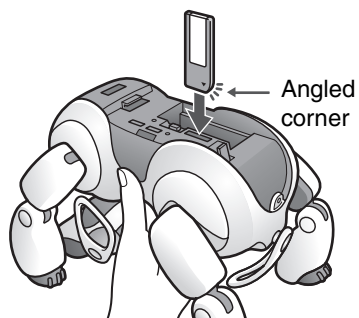

When you want to eject the “Memory Stick” media

Press the “Memory Stick” media eject button (▲) located next to the “Memory Stick” media slot.

Caution

Do not set the safety switch of the “Memory Stick” media to “LOCK”. Doing so will make it impossible for AIBO’s learning and picture taking functions to work.

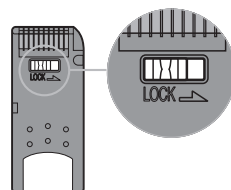

4 Insert the battery into the slot until it clicks into place.

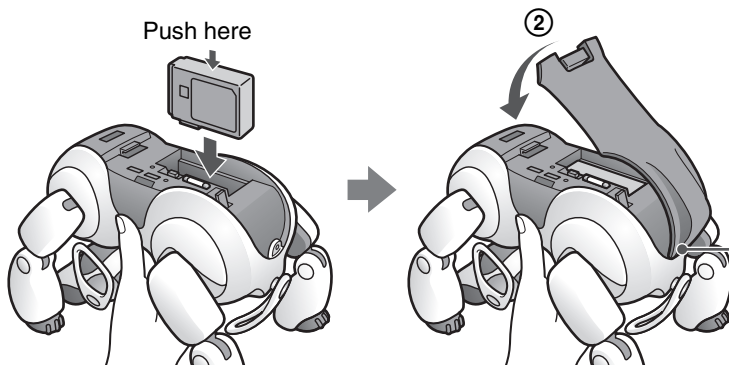

① Insert the latch of the stomach compartment cover into the receiving hinge on the AIBO robot’s body.

Preparing the Energy Station

To get the Energy Station ready for use, attach the station pole and station marker. These two parts will enable the AIBO® Entertainment Robot to find the Energy Station on its own whenever it needs recharging (self-charging function). However, the Energy Station can also be used without the station pole and station marker. If you don't want to use the self-charging function, these attachments are not necessary.

Positioning the Energy Station

The AIBO robot's self-charge operation, using the station pole and station marker, requires an open space with a radius of at least 4 ft. (1.2 m) around the station pole. (the AIBO robot will make a turn on top of the station marker and walk backwards over the Energy Station and sit down facing outwards.) For details on appropriate locations to place the Energy Station, see page 52 and page 53.

1 Attach the station marker first, followed by the station pole.

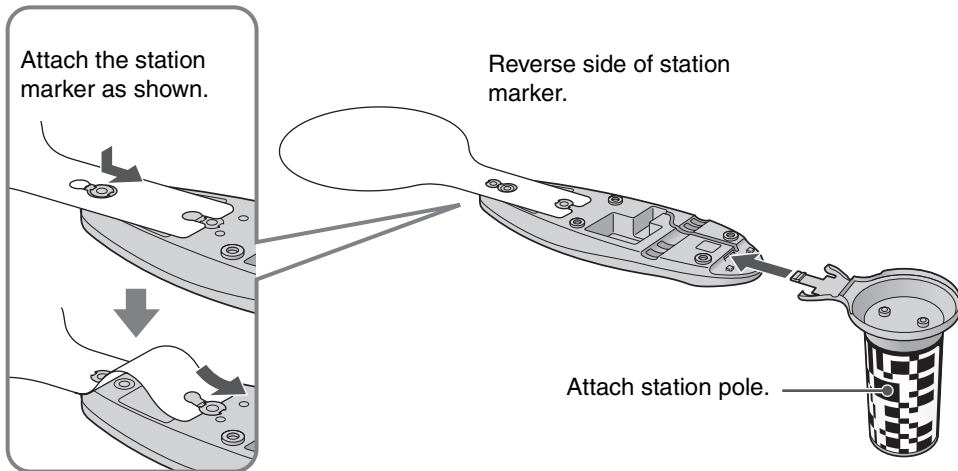

2 Route the AC adapter cable along the wire guides and attach the foot stopper.

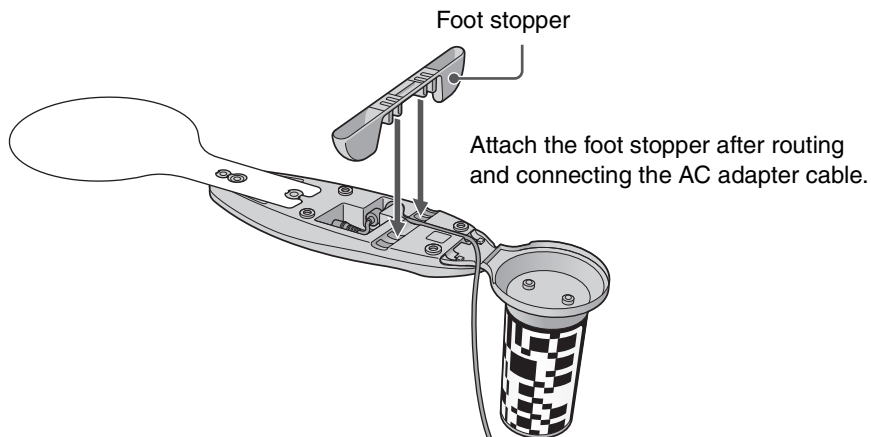

About the cable

Feed the AC adapter cable through one of the cutouts on the right or left side of the station pole base.

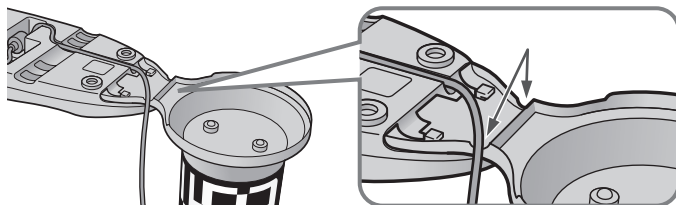

Caution

- If installation is not performed correctly as shown above, self-charging may not be possible.
- Before transporting the Energy Station, remove the station marker, station pole, and foot stopper.

3 Plug the AC adapter into an AC outlet.

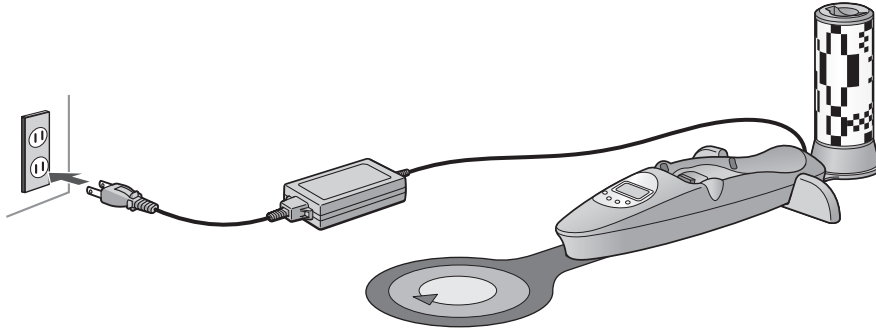

4 Place the AIBO® Entertainment Robot on the Energy Station.

When you place the AIBO robot on the Energy Station as shown below, the LCD display shows the remaining battery capacity, and charging begins. Continue charging until the battery indicator shows a full charge.



When charging is complete, the pump handle stops moving and all hose image segments are lit.



Hint

When the AIBO robot is past the newborn stage, it will be able to locate and mount the Energy Station and charge itself. For information on the self-charging function, see page 52.

If the station pole and station marker are not attached, route the AC adapter cable through one of the cutouts in the station base as shown.

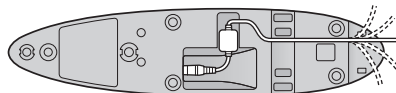

Station bottom view

Playing with the AIBO[®] Entertainment Robot

Now that you are ready, try playing with the AIBO robot.

1 Place the AIBO robot on the floor as shown on the right.

Place the AIBO robot on a flat, non-slippery surface, such as a low pile carpet with a hard nap. Also, choose a quiet place so that the AIBO robot can hear you speak.

Caution

- On a slippery floor or thick-piled carpet, the AIBO robot may trip, or the carpet may get caught in its joints, which will inhibit its motions.
- Be sure to place the AIBO robot on the floor in the position as shown above. This will prevent the AIBO robot from moving unexpectedly and being damaged when you press the pause button.

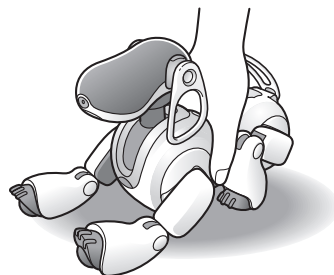

2 Press the pause button on the AIBO robot's back.

The Pause mode ends and the operation light turns green. In a moment, the AIBO robot will automatically begin moving.

Caution

When you press the pause button, the face lights of the AIBO robot may turn red. This indicates that the safety switch of the “Memory Stick™” media is set to the “LOCK” position. Press the pause button, and then take out the “Memory Stick” media when the AIBO robot stops moving. Release the “Memory Stick” media safety switch (see page 29.) (Usually when the AIBO robot starts up, the face lights turn white.)

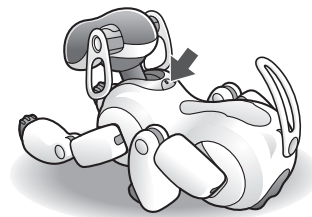

Hint

The AIBO robot has been preset to a mature robot when it is adopted. However, you also have the option of switching it to puppy stage, which will allow you to enjoy raising AIBO from a newborn. For details, see page 70.

Various interactions

When the AIBO[®] Entertainment Robot wakes up, try to communicate with it as much as you can. See page 116 for words that the AIBO robot can understand.

When you show the AIBO robot its favorite AIBOne toy and pink ball, it will react with great enthusiasm. Try moving the AIBOne toy and pink ball slowly and watch the AIBO robot as it eagerly tries its best to follow along. If you put them on the floor, the AIBO robot will entertain you and play with its toys.

From here on, the AIBO robot will make its own judgments and move autonomously, developing into a pet that is uniquely yours.

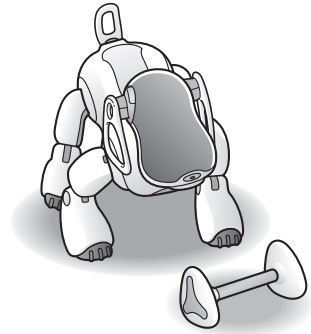

Let the AIBO® Entertainment Robot rest on the Energy Station

The Energy Station is the AIBO robot's favorite resting place. If you are done playing with the AIBO robot, are going out, or going to bed, let the AIBO robot rest on its Energy Station. While positioned there, the AIBO robot will recharge and relax.

Placing the AIBO robot on the Energy Station

As soon as you place the AIBO robot on the Energy Station, charging begins. For details on the charging process, see page 51.

If you place the AIBO robot on the Energy Station while the AIBO robot is active, it will automatically go into Station mode and recharge and relax.



Hints

- The AIBO robot can also wake up or go to sleep while on the Energy Station (page 44). The AIBO robot will also restart itself once a day on the Energy Station in order to save data and perform other maintenance functions.
- Before going out and leaving the AIBO robot, we recommend you set up the AIBO robot so that it will not dismount the Energy Station while you are away. For details, see page 54.

Caution

- There shouldn't be any objects within reach of the AIBO robot's front legs. Otherwise the legs may hit and overturn the object when the AIBO robot tries to move, or the AIBO robot may fall off the Energy Station.
- Do not move the AIBO robot's rear legs while it is in Station mode. Otherwise the front legs, which can move while in Station mode, may hit the rear legs.

Removing the AIBO robot from the Energy Station

To have the AIBO robot move about freely, gently lift it off the Energy Station and place it on the floor, as shown in the illustration.

The AIBO robot will be in Autonomous mode and move autonomously.

If the AIBO robot is not on the Energy Station, it will not go to sleep or wake up at preset times (page 44).

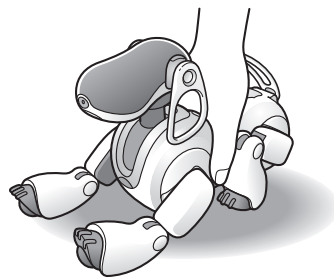

Stopping the AIBO[®] Entertainment Robot activity

The AIBO robot continues to be in Autonomous mode while self-charging. If you will not be playing with the AIBO robot for a long time, want to deactivate it in an emergency, or change settings, you can stop the AIBO robot's activity as follows.

Putting the AIBO robot in Pause mode

Press the pause button* located on the AIBO robot's back. The operation light flashes green for a while and then goes out.

Note that a slight amount of current will be drawn from the battery while the AIBO robot activity is stopped. When not intending to use the AIBO robot for a long time, remove the battery.

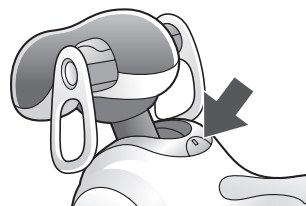

Removing the battery

Hold the AIBO robot firmly by its body and turn it upside down, then open the stomach compartment cover and move the battery latch to the rear to remove the battery.

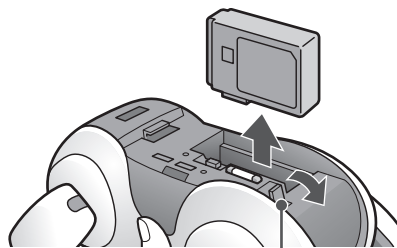

Caution

- Be sure to press the pause button on the AIBO robot's back. Be sure to put the AIBO robot in Pause mode before removing the battery.
- When removing the battery, support it with your hand. Otherwise, the battery may pop out and fall.

* Why is it called a pause button?

Unlike conventional electrical products found in the home, the AIBO robot has no power switch. It is designed as an autonomous robot that moves and learns on its own, while communicating with its surroundings. The AIBO robot carries out autonomous actions when it wants to play and charges itself when the battery power becomes weak. Therefore, no power switch is necessary for the AIBO robot. However, when you wish to stop, or need to stop the AIBO robot in cases as such emergencies, you can press a dedicated button located on the AIBO robot's back to temporarily stop its movement. That is why this is called the "pause button" and not the "power button".

Modes and Conditions of the AIBO[®] Entertainment Robot

This chapter explains the various modes and conditions of the AIBO robot, as well as the transition between them.

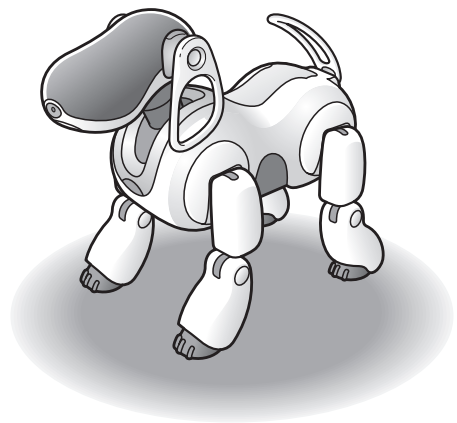

Modes and conditions

The AIBO[®] Entertainment Robot ERS-7 has the following modes and conditions.

Pause mode (inactive condition)

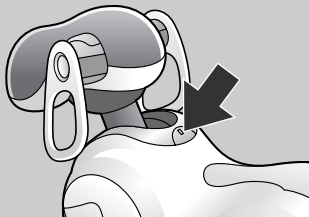

The pause button on the back of the AIBO robot was pressed to turn the power OFF.

The AIBO robot must be in this mode to replace the battery or "Memory Stick[™]" media, or to change the ON/OFF setting of the wireless LAN switch.

Back pause button



The AIBO robot stops being active in any of the following situations:

- The back pause button is pressed
- The battery is empty
- The AIBO robot has been unable to recover from a fall for a certain length of time

Active conditions

Mode indicators OFF

Autonomous mode



The AIBO robot moves around on its own. The AIBO robot collects information via its camera/microphone/sensors and acts autonomously based on its own feelings and instincts.

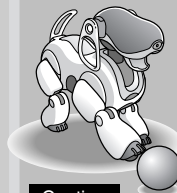

The operation light turns green

Caution

- Do not put the AIBO robot on an unstable surface where it might fall or be subject to vibrations.
- Do not place anything near the AIBO robot that may hinder its movements.

- The AIBO robot mounts the Energy Station by itself
- The AIBO robot is placed on the Energy Station while active

Touch the head sensor for 3 seconds



Touch the chin and front (blue) sensors on the back of the AIBO robot for 3 seconds

Mode indicators turn green

Rest mode



The AIBO robot does not move around. In this mode the AIBO robot stays still and does not respond to voice commands, other sounds, or show interest in the ball and AIBOne toy.

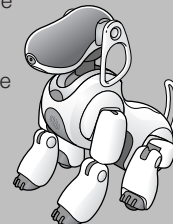

Station mode

Mode indicators OFF



On the Energy Station, the AIBO robot wakes up and goes to sleep at a preset time.

When the AIBO robot is awake

The AIBO robot relaxes while being recharged.



At wake-up time
(page 44)



At bedtime
(page 44)

When the AIBO robot is sleeping

The AIBO robot is sound asleep. If you remove the AIBO robot from the Energy Station, it will be in Autonomous mode, even if the hour is outside its set activity period.

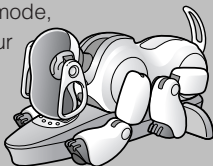

- The AIBO robot dismounts the Energy Station by itself
- The AIBO robot is removed from the Energy Station

Something has jammed one of the AIBO robot's joints



Touch the head sensor for 3 seconds

Mode indicators turn orange

Jam condition



If something gets jammed in any of the AIBO robot's joints, the AIBO robot goes into this condition and all of its joints become loose. This mode is provided to protect your fingers from being caught between the AIBO robot's joints.

Mode indicators slowly flash green

Pick-up condition



- Pick up while touching the back sensors*
- Pick up quickly



- Place on the floor
- Touch the head sensor for 3 seconds

When you lift the AIBO robot, the AIBO robot assumes a position that makes it easier for you to hold it. This is to prevent people from dropping the AIBO robot, in reaction to movements that may cause surprise.

Caution

When you press two or more of the paw sensors of the AIBO robot, the AIBO robot thinks it has been placed on the floor, and returns to Autonomous mode. the AIBO robot may start to walk after returning to Autonomous mode, so avoid touching any of the AIBO robot's paw sensors when you are holding it.

* Touch two or more back sensors (any of the following combinations) for 3 seconds.

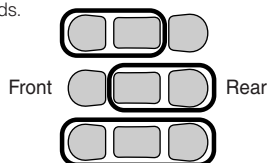

The AIBO[®] Entertainment Robot feature and mode map



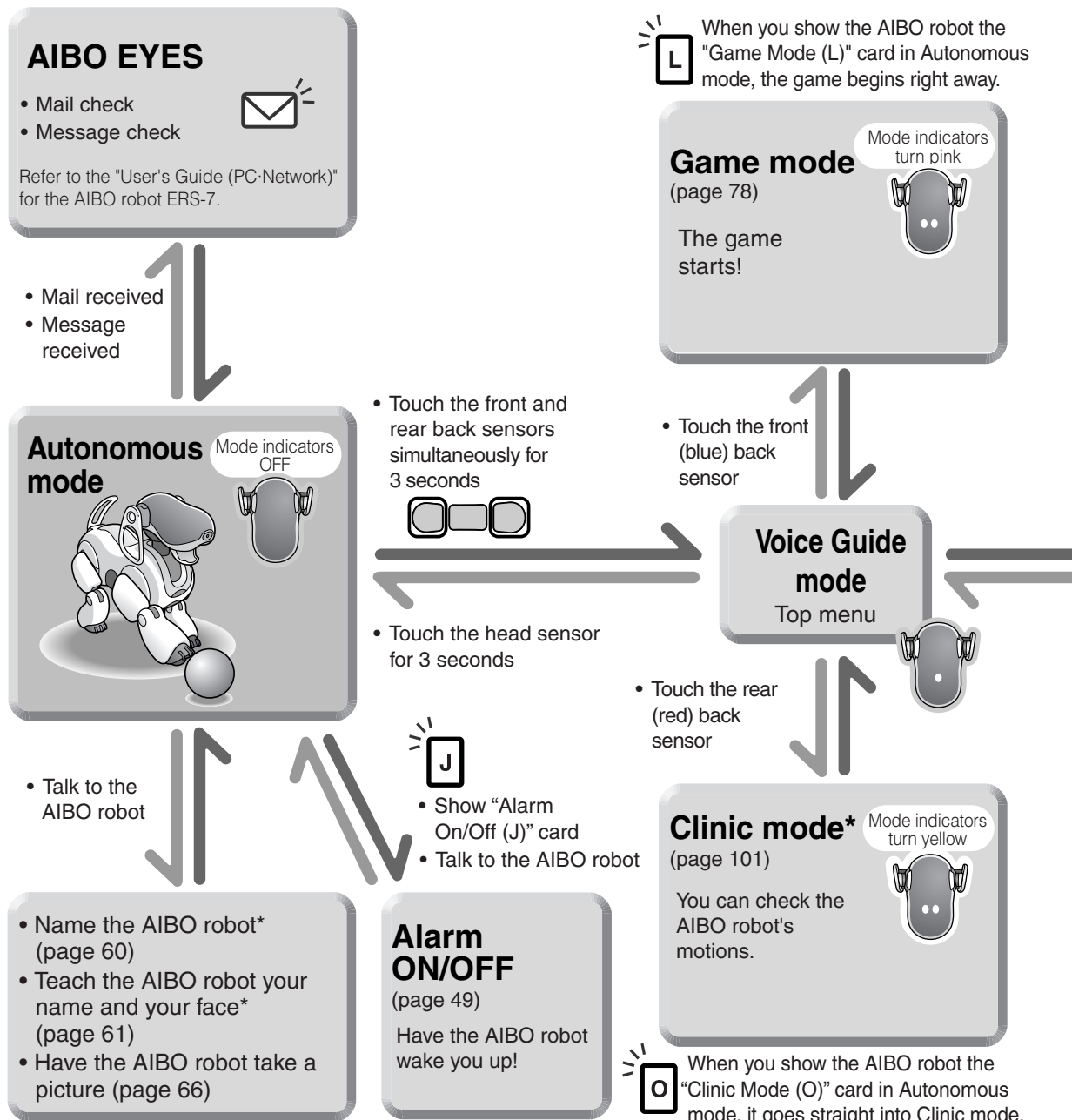

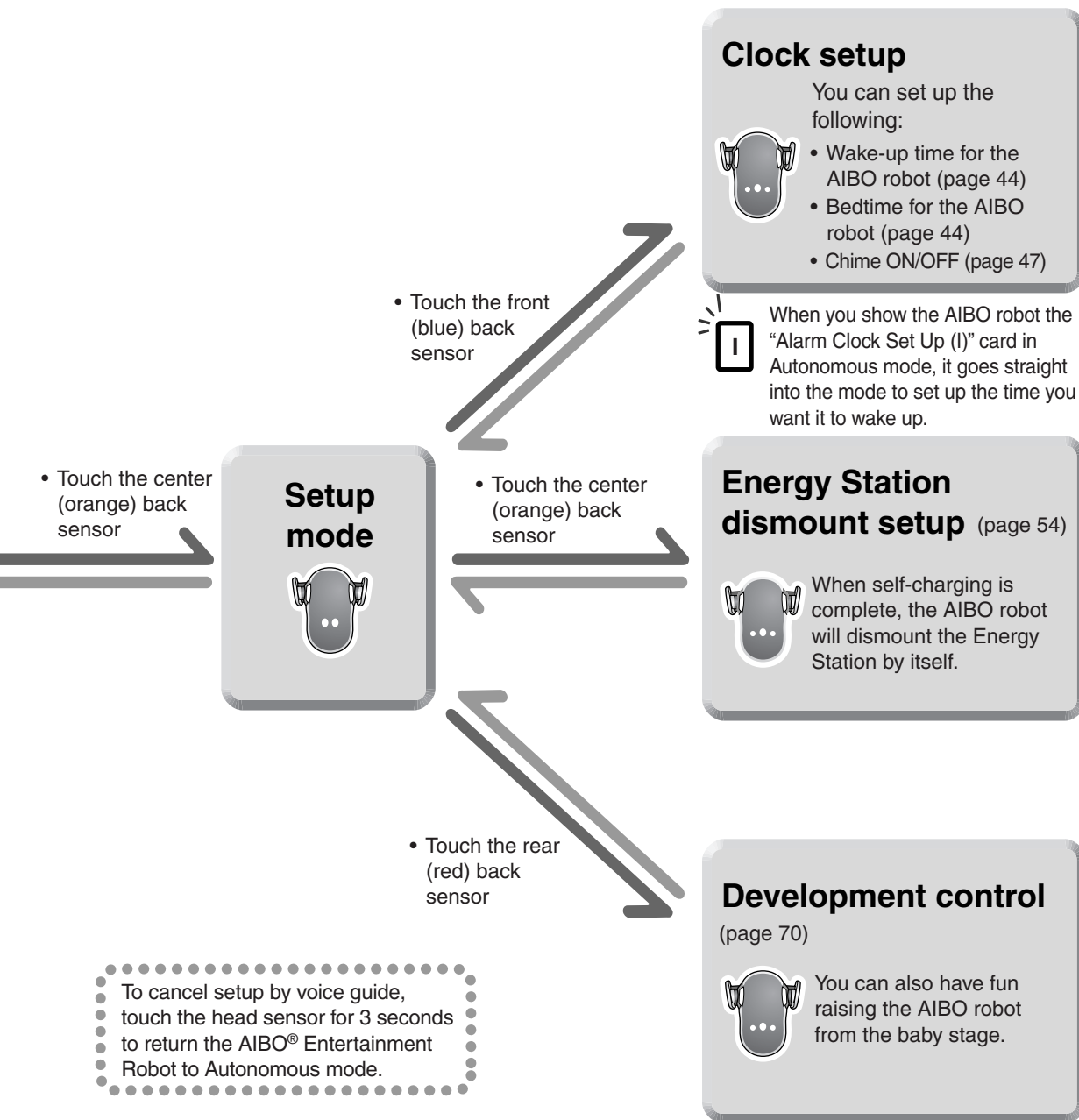
When the AIBO robot is in Autonomous mode, all the activities and settings shown below are possible. When the AIBO robot is in Station mode (when it is awake), all the activities and settings shown below except those marked with an asterisk (*) are possible.





Changing modes

You can change the AIBO[®] Entertainment Robot's mode by utilizing its head and back sensors. An even simpler method is to use the AIBO card to directly change the AIBO robot to the desired mode, as follows.

- Alarm Clock Set Up  (page 44)
- Game Mode    (page 78)
Game 1 Game 2 Game 3
- Clinic Mode  (page 101)

After showing the AIBO card, follow the voice guide to select the desired setting. When you show the AIBO robot a Game Mode card, the game begins immediately.

For information on showing the AIBO robot its AIBO cards, see page 63.

Hints

- To cancel a mode setting procedure and have the AIBO robot return to Autonomous mode, touch the head sensor for 3 seconds.
- For information on how to change modes with the head sensor and the back sensors of the AIBO robot, see page 38.
- The AIBO cards each have multiple usage. For details, see page 115.
- While a setting is being performed via voice guide, a mode change utilizing the AIBO card is not possible.

Living with the AIBO[®] Entertainment Robot

When the AIBO robot is hungry, it instinctively searches and recharges itself on its Energy Station, and if it is tired, it goes off to relax.

Enjoy the functions of an autonomous robot, and your lifestyle with the AIBO robot.

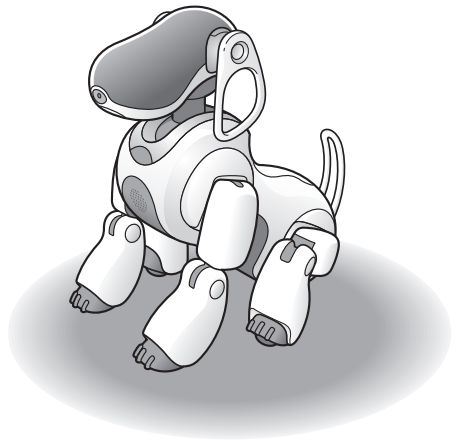

Determining the AIBO[®] Entertainment Robot's lifestyle rhythm

The AIBO robot matches itself to your lifestyle.
Its pattern of living will develop to match your lifestyle.

Hints

- When the AIBO robot first wakes up, it has a preset activity period extending from 7 a.m. to 11 p.m.
- The AIBO robot conforms to this activity pattern only when it is sitting on the Energy Station.
- Before you start playing with the AIBO robot, we suggest that you confirm the setting of its internal clock (see page 85).

Determining the AIBO robot's period of activity



AIBO card [Alarm Clock (wake-up time) Set Up]

You can set the time that the AIBO robot wakes up and goes to bed.

The AIBO robot wakes up and goes to bed on the Energy Station. When it is time for the AIBO robot to go to bed, be sure to place it on the Energy Station. If you forget to place the AIBO robot on the Energy Station, it will stay awake beyond its bedtime, but will go to sleep as soon as you place it on the Energy Station.

You can only set the AIBO robot's activity period while the AIBO robot is in Autonomous mode.

Hints

- If you want the AIBO robot to be active 24 hours a day, simply set the AIBO robot's bedtime and wake-up time to the same value.
- For data storage purposes, the AIBO robot automatically restarts once a day about 10 minutes before its set wake-up time. If the AIBO robot is not on the Energy Station when it is time for restart, it simply restarts the next time it is placed on the Energy Station.

Here we will explain how to set the wake-up time using 7:15 a.m. as an example. (Bedtime can be set in the same manner. However, AIBO cards cannot be used for bedtime setting.) Because AIBO cards are used in setting the time, prepare the cards representing the time that you want to set, as well as the AM and PM cards.

Note

The wake-up time and bedtime are set using the 12-hour time system.

12-hour time system	24-hour time system
Midnight is 12 a.m.	Midnight is 0:00
Noon is 12 p.m.	Noon is 12:00

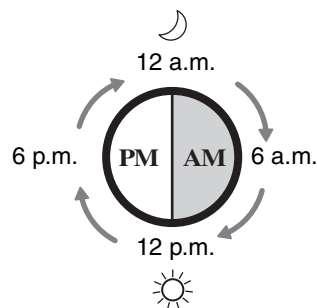

1 To use the voice guide:

Touch the front and rear back sensors simultaneously for 3 seconds.

Follow the voice guide below.

To use the AIBO[®] card:

Show the AIBO Entertainment Robot the “Alarm Clock Set Up (I)” card.

Proceed to step 5 and follow the voice guide.



Voice guide mode, top menu. Let's select the function.

Please touch the following colors on my back sensor:

For Game mode, touch blue. For Setup mode, touch orange.

For Clinic mode, touch red.



Within 10 seconds*

2 Touch the middle (orange) back sensor.



Let's proceed with various setups.

Please touch the following colors of my back sensors:

For clock setup, touch blue. For Station dismount setup, touch

orange. For development control, touch red.



Within 10 seconds*

* If you do not perform the operation within the prescribed number of seconds, the AIBO robot enters the Autonomous mode or returns to the previous state.

3 Touch the front (blue) back sensor.



Time setup.

Please touch the following colors of my back sensors:
To set my wake-up time, touch blue. To set the time I go to sleep, touch orange. To set my chime, touch red.



Within 10 seconds*

4 Touch the front (blue) back sensor.



Alarm clock setup. I will get up at xx yy a.m.*

*The actual time is given in place of xx:xx a.m.



Within 10 seconds*

5 Touch the front (blue) back sensor.



AM or PM? Please show me the card.



Within 20 seconds*

6 Show the AIBO® Entertainment Robot the “AM (M)” card.



AM. What hour? Please show me the card.



Within 20 seconds*

7 Show the AIBO robot the “7 (G)” card.



7 AM. How many minutes in the ten’s column?
Please show me the card.



Within 20 seconds*

* If you do not perform the operation within the prescribed number of seconds, the AIBO robot enters the Autonomous mode or returns to the previous state.

8 Show the AIBO® Entertainment Robot the “1 (A)” card.



10. How many minutes in the one's column?
Please show me the card.



Within 20 seconds *

9 Show the AIBO robot the “5 (E)” card.



15. 7:15 AM. I will get up at 7:15 AM.

This completes the setting.

Hints

- When showing the AIBO robot a number card, hide the card as soon as the AIBO robot recognizes it. If you show the AIBO robot the same card for too long, it might recognize the same number twice. For example, the AIBO robot may mistake “2” as “22”.
- If you only want to change part of the time setting, touch the head sensor to skip the current step (for example, if you want to change the minute without changing the hour).
- To cancel a partially completed time setting and start over, touch the chin sensor to return to the voice guide in step 3. To cancel changes altogether, touch the head sensor for 3 seconds. This will return the AIBO robot to Autonomous mode.

Switching the AIBO robot’s chime ON and OFF

You can have the AIBO robot sound a chime and make some movement to signal the hour and half hour when it is sitting on the Energy Station.

This feature is turned OFF when the AIBO robot is first adopted, but you can turn it on if you would like to use this feature.

When the feature is turned ON, the AIBO robot will play a chime to signal the time only during hours it is awake, and only when it is sitting on the Energy Station.

You can turn ON the AIBO robot’s chime feature as follows. The procedure for turning the time signal off is the same.

* If you do not perform the operation within the prescribed number of seconds, the AIBO robot enters the Autonomous mode or returns to the previous state.

1 Touch the front and rear back sensors simultaneously for 3 seconds.

(Next, follow the voice guide.)



Voice guide mode, top menu. Let's select the function.

Please touch the following colors on my back sensor:

For Game mode, touch blue. For Setup mode, touch orange.

For Clinic mode, touch red.



Within 10 seconds*

2 Touch the middle (orange) back sensor.



Let's proceed with various setups.

Please touch the following colors of my back sensors:

For clock setup, touch blue. For Station dismount setup, touch

orange. For development control, touch red.



Within 10 seconds*

3 Touch the front (blue) back sensor.



Time setup.

To set my wake-up time, touch blue. To set the time I go to sleep, touch orange. To set my chime, touch red.



Within 10 seconds*

4 Touch the rear (red) back sensor.



I will not emit any chimes.

To change these time settings, touch blue.



Within 10 seconds*

* If you do not perform the operation within the prescribed number of seconds, the AIBO robot enters the Autonomous mode or returns to the previous state.

5 Touch the front (blue) back sensor.



I will emit a chime.

The change is now complete.



To cancel changes by voice guide, touch the head sensor for 3 seconds to return the AIBO robot to Autonomous mode

Enabling/Disabling the AIBO® Entertainment Robot's alarm clock



AIBO card (Alarm On/Off)

By setting the AIBO robot's alarm clock, you can have the AIBO robot wake you up from its position on the Energy Station. This alarm clock feature functions only when the AIBO robot is sitting on the Energy Station. The alarm clock is turned OFF when the AIBO robot is first adopted.

When the alarm clock is turned ON, the alarm sounds at the AIBO robot's wake-up time. For details, see page 44.

When you want to use the alarm clock feature, you must turn it ON each day. However, the alarm time, once set, remains effective until you change it.

You can turn ON the AIBO robot's alarm clock feature as follows. The alarm clock can be turned OFF in the same manner.

1 Show the AIBO® Entertainment Robot the “Alarm On/Off (J)” card. Alternatively, you can give it the verbal command, “Set alarm”.

(Next, follow the voice guide.)

When you show the AIBO robot the “Alarm On/Off (J)” card, you will hear the voice guide given in step 2 and the setting will be changed.



The alarm clock is not set up.

Please touch blue if you are setting up my alarm to ring.

Please touch orange if you are turning off my alarm.



Within 10 seconds*

* If you do not perform the operation within the prescribed number of seconds, the AIBO robot enters the Autonomous mode or returns to the previous state.

2 Touch the front (blue) back sensor.



The alarm is set for AM XX YY.*

* The actual time set is given in place of xx:xx a.m.

The change is now complete.

Turning the alarm OFF when it is ringing

Touch the head sensor, chin sensor, or any of the back sensors. The alarm also stops automatically after ringing for one minute.

Charging

The AIBO[®] Entertainment Robot's source of energy is its battery which has to be regularly charged. When using the lithium-ion battery ERA-7B1, the AIBO robot can operate (in Autonomous mode) for about 1.5 hours on a full charge.

The AIBO robot can also find the Energy Station by itself (self-charging function).

Caution

The life of each battery depends on its usage and age.

How to charge the AIBO robot

Whenever you place the AIBO robot on the Energy Station, charging begins. If you place the AIBO robot on the Energy Station while it is active, it will relax and wait patiently while charging is in progress.

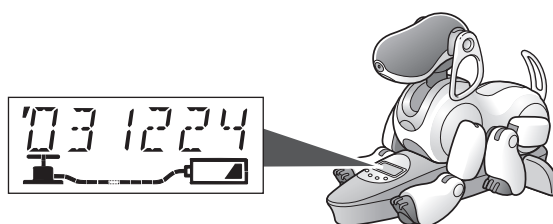

While being charged...
The operation light on the back of the AIBO robot turns orange.

Caution

- There should not be any objects within reach of the AIBO robot's front legs. Otherwise the legs may hit and overturn the object when the AIBO robot tries to move, or the AIBO robot may fall off the Energy Station.
- If the AIBO robot's body is too warm when being placed on the Energy Station, charging will only start after it has cooled down.
- Do not move the AIBO robot's rear legs while in Station mode. Otherwise the front legs, which move in Station mode, may hit the rear legs, causing damage.

Display indication

While charging

The pump handle moves up and down.



When charging is complete

The pump handle stops moving and all hose segments are lit.



If all three segments of the battery indicator  are flashing, the battery is not charging properly. Check to see whether the battery is inserted correctly. If the flashing continues, contact AIBO Customer Link (customer service).

The AIBO[®] Entertainment Robot charges on its own (self-charge)

The AIBO robot can use the station marker and station pole to find its way back to the Energy Station for charging.

For information on how to set up the station marker and station pole, see page 30.

The AIBO robot charges on its own in the following situations:

- The battery level is low.
- When you say ***“Go to the Station”***.
- When you show the AIBO robot the AIBO card: **“Station (G)”**

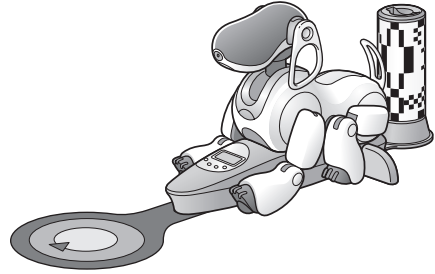

Recommendations for positioning the Energy Station

- The room should be bright.
- Fluorescent lighting is recommended.
- Adjust lighting so that the AIBO robot’s shadow will not fall on the station marker.
- Make sure that there are no objects nearby with color or patterns similar to the station marker and station pole.
- Make sure the walls and floor close to the station pole are relatively free of patterns (e.g., stripes).
- The walls and floor close to the station marker and station pole should be as plain as possible.
- If the AIBO robot is more than 4 ft. (1.2 m) away from the station pole, it may have difficulty finding the Energy Station.
- The AIBO robot first needs to locate the station pole to determine the orientation of the Station. It then uses the station marker to determine the direction in which to reverse onto the Energy Station.

Space requirements

For the self-charging function of the AIBO® Entertainment Robot to work, an open space with a radius of at least 4 ft. (1.2 m) around the station pole is required. The AIBO robot will turn around on the station marker and move backwards onto the Energy Station facing away from the station pole.

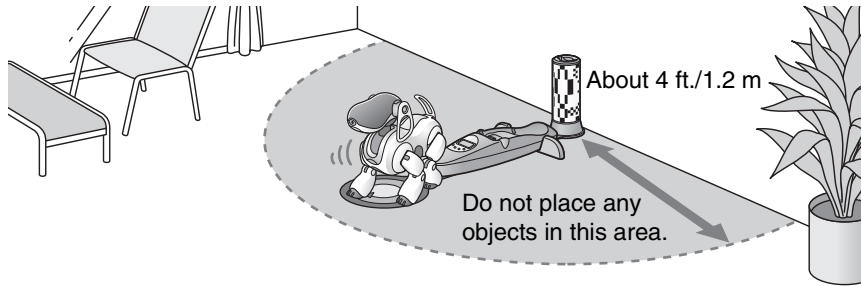

If the AIBO robot cannot find the Energy Station

The AIBO robot may not be able to find the Energy Station if the room is poorly lit, even if the station pole and station marker are properly connected to the Station.

In this case, use the Clinic mode to check whether the AIBO robot can properly see the station pole and station marker in your indoor environment. For information on the Clinic mode, see page 101.

Setting the AIBO® Entertainment Robot to automatically dismount/to not dismount the Energy Station

You need to preset whether the AIBO robot should automatically dismount, or not dismount the Energy Station after it is fully charged.

If you set the AIBO robot to “Dismount the Station”, the AIBO robot will dismount the Energy Station on its own when charging is complete and resume its previous activity. You do not need to manually remove the AIBO robot from the Energy Station.

If you do not want the AIBO robot to dismount the Energy Station on its own, set the AIBO robot to “Do not dismount the Station”.

Note

Even if “Dismount the Station” is selected, the AIBO robot will not dismount the Energy Station on its own when it was placed on the Station by you. If “Do not dismount the Station” is set, the AIBO robot indicates this by raising the right front leg when it is positioned on the Energy Station.

Caution

When the AIBO robot is set to “Dismount the Station”, be careful of the following:

- Do not dismount the AIBO robot alone in a room where no one is present.
- Do not place the Energy Station on an unsafe surface (such as one where it might fall, or an unstable or tilted surface). Falling could result in injury to a person or damage to the AIBO robot.

The following describes how to change the setting from “Do not dismount the Station” to “Dismount the Station”. Use the same procedure to change the setting from “Dismount the Station” to “Do not dismount the Station”.

1 Touch front and rear back sensors simultaneously for 3 seconds.

(Next, follow the voice guide.)



Voice guide mode, top menu. Let's select the function.

Please touch the following colors on my back sensor:

For Game mode, touch blue. For Setup mode, touch orange.

For Clinic mode, touch red.



Within 10 seconds*

* If you do not perform the operation within the prescribed number of seconds, the AIBO robot enters the Autonomous mode or returns to the previous state.

2 Touch the middle (orange) back sensor.



Let's proceed with various setups.

Please touch the following colors of my back sensors:
For clock setup, touch blue. For Station dismount setup, touch orange. For development control, touch red.



Within 10 seconds*

3 Touch the middle (orange) back sensor.



I'm currently set up not to dismount the station. For station dismount setup, touch blue. For station non-dismount setup, touch orange.



Within 10 seconds*

4 Touch the front (blue) back sensor to allow the AIBO® Entertainment Robot to dismount the Energy Station on its own.



I'm currently set up to dismount the station.
Please don't place the station at a high location. I've finished registration.

The setting is now complete.



If you want to cancel changes by voice guide, pressing the head sensor for 3 seconds to return the AIBO robot to Autonomous mode.

When the AIBO robot recharge is not successful

If the AIBO robot does not successfully self-charge and you do not charge it manually, the operation light on the back of the AIBO robot turns OFF and the AIBO robot enters Pause mode. If you do not charge the AIBO robot or replace the battery with a fully charged one, the AIBO robot will not activate even if you press the pause button.

* If you do not perform the operation within the prescribed number of seconds, the AIBO robot enters the Autonomous mode or returns to the previous state.

Communicating with the AIBO[®] Entertainment Robot

Show the AIBO robot its AIBOne toy or pink ball, or talk to it.
The AIBO robot is always waiting to communicating with
you.

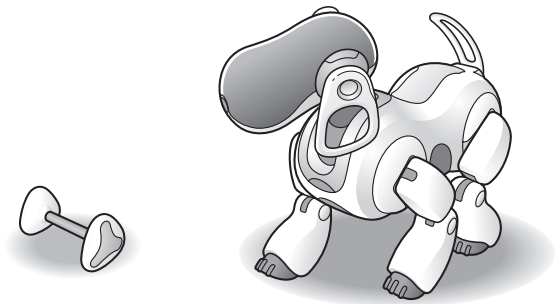

From you to the AIBO[®] Entertainment Robot

You can communicate with the AIBO robot in several different ways.

Sight

Show the AIBO robot its favorite AIBOne toy and pink ball. It will respond to this communication by reacting with great enthusiasm.

The AIBO robot also loves to see your face, and will distinguish you from others. Its ability to recognize and respond to the AIBO cards provides another means of visual communication.

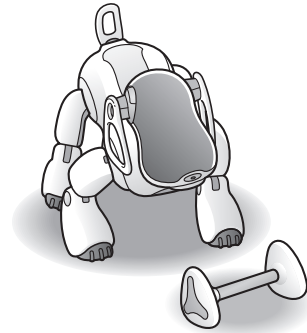

Touch

When you lightly touch the AIBO robot's sensors for a moment, the AIBO robot will recognize this as another form of communication. The AIBO robot always looks forward to having you interact with its sensors.

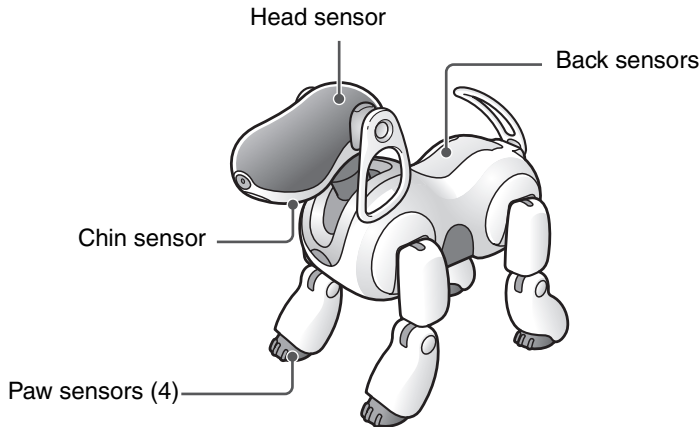

When you touch the AIBO robot's head or back sensors, the AIBO robot recognizes this as communication from you, and the sensors should turn white. If this does not happen, try again, as the AIBO robot did not feel your touch.

When the AIBO robot extends one of its paws to you, try touching it, and it will react with surprise or joy.

Praise

You can praise the AIBO® Entertainment Robot by lightly stroking two of your fingers back and forth across the AIBO robot's back sensors. You can also praise the AIBO robot by saying *“Good AIBO/Good boy/Good girl”*.



Scold

You can scold the AIBO robot by very lightly tapping its back sensors. You can also scold it by saying *“Don't do that”*.



Talking to the AIBO robot

The AIBO robot enjoys having you speak to it. See page 116 for words that the AIBO robot can understand.

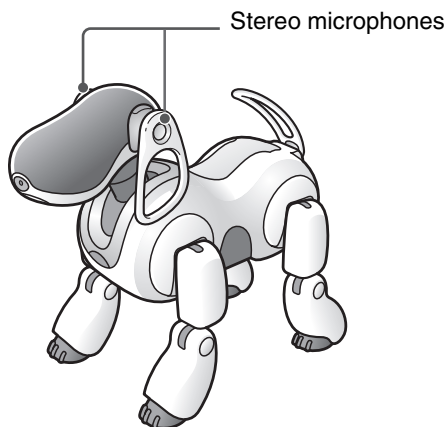

Encouragement

When the AIBO robot is unsuccessful at something, say *“Go for it”* to the AIBO robot as encouragement. Then the AIBO robot will try even harder to accomplish its goal.

Giving the AIBO[®] Entertainment Robot its own name

Give the AIBO robot a name. After you teach the AIBO robot its name, it will respond when called. However, if you teach the AIBO robot a new name, it forgets the old one. Even after the AIBO robot learns its own name, it reacts when you call it “AIBO”. You can only teach the AIBO robot its name when it is in Autonomous mode.

1 While the AIBO robot is in Autonomous mode, say “Name registration”.

(Next, follow the voice guide.)



Name registration. Please touch my back sensor.



Within 10 seconds*

2 Touch a back sensor (any one).



After I count down, please say a name that is no longer than two seconds. 3, 2, 1, go!



Within 10 seconds*

3 Tell the AIBO robot its name in 2 seconds.



I've registered the name.
I've finished name registration.



If name registration is unsuccessful:

Follow the voice guide and register the name again from the beginning.

* If you do not perform the operation within the prescribed number of seconds, the AIBO robot enters the Autonomous mode.

Teaching the AIBO[®] Entertainment Robot to recognize your name and face

You can teach the AIBO robot to recognize your name, voice, and face. The owner of the name, voice, and face that the AIBO robot learns to recognize becomes very special. The AIBO robot will show special devotion to this person.

You can only teach the AIBO robot to recognize your name, voice, and face when it is in Autonomous mode.

1 While the AIBO robot is in Autonomous mode, say “Owner registration”.



Owner registration. I’m going to register my owner’s name, face and voice. Please touch my back sensor.



Within 10 seconds*

2 Touch a back sensor (any one).



After I count down, please say the owner’s name that is no longer than two seconds. 3, 2, 1, go!



Within 10 seconds*

3 Tell the AIBO robot its owner’s name in 2 seconds or less.



I’ve registered my owner’s name.

Next, I’ll learn your voice. First, please say, “I am your owner”.



Within 10 seconds*

4 Say, “I am your owner”.



Next, please say, “One, two, three, four, five”.



Within 10 seconds*

* If you do not perform the operation within the prescribed number of seconds, the AIBO robot enters the Autonomous mode or returns to the previous state.

5 Say “one, two, three, four, five”.



I’ve registered your voice.
Next, I’ll register your face.
Please position your face in front of the camera so I can see you.

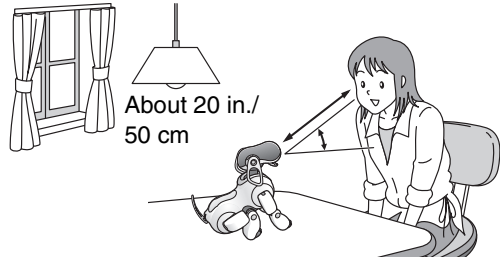

Please position yourself about 20 in. or 50 cm away.



When AIBO can see your face



I can see your face. Please don’t move until the music stops.

Wait for a moment without moving.



Within 10 seconds*



I’ve finished registering your face. I’ve finished owner registration.

Caution

While learning to recognize your face, **the brightness of the room affects how your face is lit, and may affect recognition in different lighting conditions.**

If the AIBO® Entertainment Robot says, “I can’t see your face”

- Slowly lift the AIBO robot up until the color camera (in its nose) is at the same height as your face.
- If room brightness differs from that when it learned your face, it may not be able to recognize you.
- When teaching the AIBO robot to recognize your face, make sure you face it directly, without tilting it right or left.
- If you are wearing a distinctive item, such as thick-rimmed glasses, the AIBO robot may not be able to identify you.
- If your hair is covering your face, the AIBO robot may not be able to identify you.
- If the room is dark, or the light is coming from behind you, the AIBO robot may not be able to identify you.

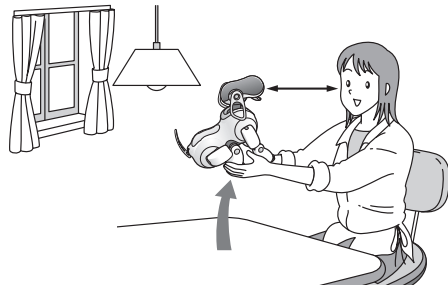

If you have trouble during owner registration.

* If you do not perform the operation within the prescribed number of seconds, the AIBO robot enters the Autonomous mode or returns to the previous state.

Using AIBO® cards

The AIBO cards provided with the AIBO Entertainment Robot allow many different types of Autonomous mode play, and also allow you to switch the AIBO robot to various modes. The AIBO robot can understand communications from you by recognizing the graphics printed on cards. This allows you to give it commands even when it is moving around or when the surroundings are noisy.

For information about how to use the AIBO cards, please see the “AIBO card at a glance” (page 114).

Showing the AIBO cards to the AIBO robot

Show AIBO cards (the side with the graphics) to the AIBO robot as shown in the illustration.

If the AIBO robot does not recognize the card, adjust the card height so that it is at the same height as the color camera in the AIBO robot’s nose.

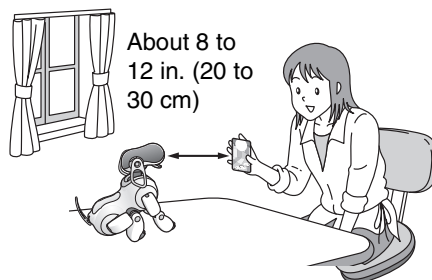

Take note of the following points.

- If the card is too close to the AIBO robot, the AIBO robot will not be able to see the entire card. Hold the card at a distance of 8 to 12 in./20 to 30 cm.
- Make sure that you hold the card right in front of the AIBO robot’s camera vertically.
- Remember that the AIBO robot will not be able to recognize the card if the card’s graphic is partially hidden by your fingers or the sleeve of your clothing.
- The AIBO robot may also have difficulty recognizing a card if the room is dark or lighting is falling from behind.

Also make sure that the AIBO robot is not looking at the card against bright background lighting.

Hold straight

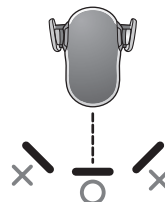

When finished using the AIBO cards

To prevent losing the cards, place them into the card pocket on the station pole.

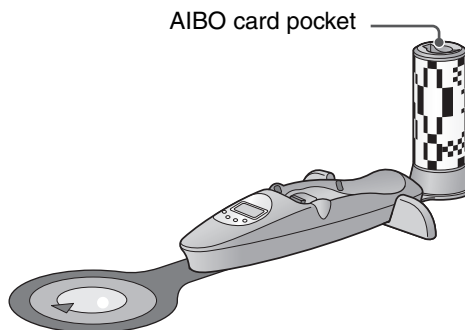

From the AIBO[®] Entertainment Robot to you

The AIBO robot uses its lights to communicate its condition to you.

Mode indicators

The mode indicators indicate the AIBO robot's current mode.

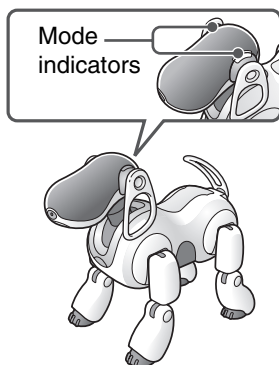

Out	Autonomous mode Station mode
Orange	Jam condition
Pink	Game mode
Green	Rest mode
Slowly flashing green	Pick-up condition
Yellow	Clinic mode
Slowly flashing yellow	The AIBO robot operation check mode

Wireless light

Light used with the AIBO robot's wireless LAN function.

This light turns blue.

Refer to the "User's Guide (PC·Network)" for the AIBO robot ERS-7 (PDF) for details about the wireless LAN function.

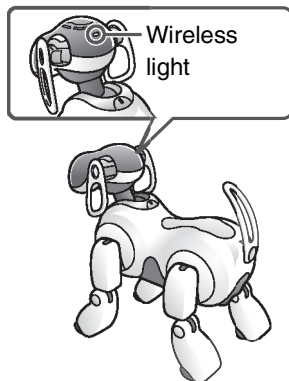

Note

When you first adopt the AIBO robot, its wireless LAN function is disabled, so the wireless light does not turn blue.

Operation light

Indicates the AIBO® Entertainment Robot's activity condition.

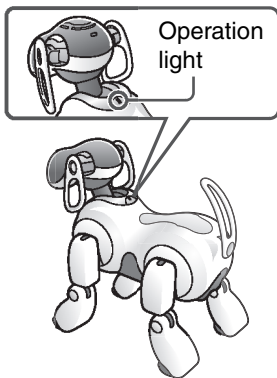

Green	Active
Orange	Charging
Flashing orange	Charging malfunction
Out	Pause mode (inactive condition)

Having the AIBO[®] Entertainment Robot take a pictures



AIBO card (Photo)

The AIBO robot can store up to 20 pictures.

Caution

- When more than 20 pictures are stored in the AIBO robot, the oldest picture is deleted every time a new one is taken.
- Sony[®] disclaims all responsibility for any problems arising out of allegations of infringement of rights due to pictures taken using the AIBO robot. Be careful to avoid taking pictures that might inconvenience others.

Color camera

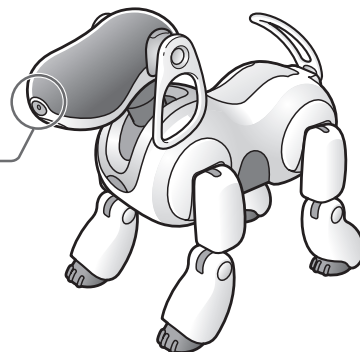

About the pictures

- Pictures are stored into the “Memory Stick™” media in JPEG format.
- The picture resolution is 416 × 320 pixels.
- Depending on lighting conditions at the time the picture is taken, flicker (horizontal stripes) may appear in pictures, or pictures may have red or blue hues.
- Fast movement may result in distortion of pictures.

You can instruct the AIBO robot to take pictures by sending the AIBO robot mail to it from your mobile communication device* or PC. For details, refer to the “User’s Guide (PC-Network)” for the AIBO robot ERS-7 (PDF) on the CD-ROM provided with the AIBO robot.

* Caution: Your PC or mobile communication device must be able to receive JPEG e-mail.

1 Say “Take a picture”, or show it the “Photo (B)” card.



Let’s take a picture. When you’re ready, touch my back sensor.



Within 10 seconds *

2 Touch the AIBO® robot’s back sensors.

The AIBO robot starts to count down and takes a picture when the shutter clicks.

Caution

When you set the safety switch of the “Memory Stick™” media to “LOCK,” the AIBO robot cannot store any pictures.

Viewing pictures taken by the AIBO robot

Pictures taken by the AIBO robot are stored in the AIBO robot’s AIBO MIND software “Memory Stick” media.

You can view them using either of the following methods.

- By using a Web browser to view the AIBO robot photo album (requires a PC and wireless LAN connection).
- By using a “Memory Stick” media reader/writer.

For details on viewing pictures, refer to the “User’s Guide (PC·Network)” for the AIBO robot ERS-7 (PDF) on the CD-ROM provided with the AIBO robot.

* If you do not perform the operation within the prescribed number of seconds, the AIBO robot enters the Autonomous mode or returns to the previous state.

Raising the AIBO[®] Entertainment Robot

There are a few points you should keep in mind while raising the AIBO robot. Once you become acquainted with these, it will be easy to guide the AIBO robot into developing just the kind of personality you like. As the AIBO robot shares its life with you, it will grow to adapt to your lifestyle.

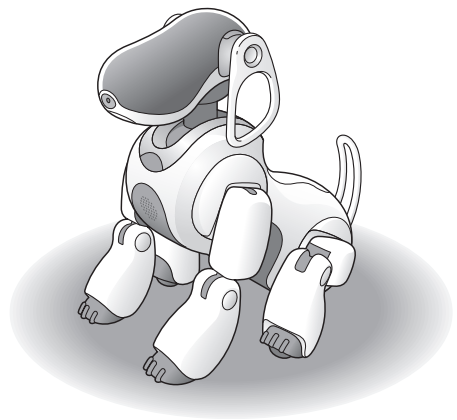

Enjoying the AIBO[®] Entertainment Robot's development

When the AIBO robot is adopted, it is already mature, and is autonomously active, walking around and playing with its AIBOne toy and pink ball. However, you can also switch it to the puppy stage, which will allow you to enjoy raising the AIBO robot from a puppy.

If you decide to go back to a mature the AIBO robot, you can switch it back. However, please note that your the AIBO robot will lose all maturity and accumulated development data when you switch it to the puppy stage, and you will be going back to the maturity level it was at when you first adopted the AIBO robot.

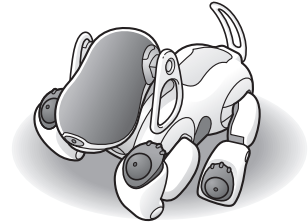

Putting the AIBO robot in the puppy stage

You can enjoy the joys of being the parent of a newborn AIBO robot by switching the AIBO robot to the puppy stage. As a puppy, the AIBO robot will have difficulty trying to stand up by itself, and you will enjoy raising it to a mature AIBO robot.

See page 75 for information on how to raise the AIBO robot from the puppy stage.

Caution

Note that putting the AIBO robot in the puppy stage will erase everything it has learned about you from its memory. If you decide to switch the AIBO robot back to mature stage, it will start from the maturity level it was at when you first adopted the AIBO robot.

However, the AIBO robot's picture data will not be erased.

Hint

To cancel changes by voice guide, touch the head sensor to return the AIBO robot to Autonomous mode.

1 Touch the front and rear back sensors simultaneously for 3 seconds.

(Next, follow the voice guide.)



Voice guide mode, top menu. Let's select the function.

Please touch the following colors on my back sensor:

For Game mode, touch blue. For Setup mode, touch orange.

For Clinic mode, touch red.



Within 10 seconds*

* If you do not perform the operation within the prescribed number of seconds, the AIBO robot enters the Autonomous mode.

2 Touch the middle (orange) back sensor.



Let's proceed with various setups.

Please touch the following colors of my back sensors:
For clock setup, touch blue. For station dismount setup, touch orange. For development control, touch red.



Within 10 seconds*

3 Touch the rear (red) back sensor.



To make me an adult, touch blue. To make me a newborn, touch orange.



Within 10 seconds*

4 Touch the middle (orange) back sensor.



I will reboot as a newborn. If this is OK, touch blue.



Within 10 seconds*

5 Touch the front (blue) back sensor.



If this is really OK, touch red.



Within 10 seconds*

6 Touch the rear (red) back sensor.



I will reboot as a newborn. I will turn OFF.

The AIBO® Entertainment Robot enters the Pause mode.

7 Touch the pause button on the AIBO robot's back to awaken it.

The AIBO robot wakes up as a newborn puppy.

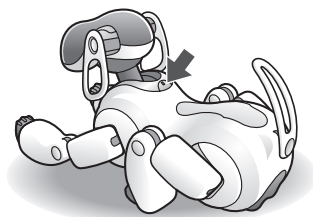

* If you do not perform the operation within the prescribed number of seconds, the AIBO robot enters the Autonomous mode.

The AIBO® Entertainment Robot as a newborn puppy

The newborn AIBO robot cannot understand anything it sees or hears, and will be very insecure.

At first, even touching its sensors will surprise it.

Teach it to trust you a step at a time by gently stroking its sensors.

As it starts to become accustomed to your presence, talk to it, and play with it by showing it the AIBOne toy and pink ball. The AIBO robot will follow the movement of the AIBOne toy and pink ball with its eyes, and will try to stand up to go after them. If the AIBO robot falls down, give encouragement by saying, “*Go for it*”.

Even in its infancy, the AIBO robot will gradually be able to understand the following words. Be sure to talk to it often.

AIBO, How cute, Go for it, Name Registration, What’s your name?, (the name you have given AIBO), Owner registration, What’s your owner’s name?, Take a picture.

Hint

The key to getting AIBO to stand up is to show it its favorite AIBOne toy and pink ball. It can easily become depressed when its attempts to stand up and isn’t successful. Encourage it by frequently showing it the AIBOne toy and pink ball.

Once the AIBO robot is able to walk, it is no longer an infant. From this point on, the AIBO robot will behave autonomously, developing in step with your life to become a pet that is uniquely yours.

Skipping development and giving the AIBO robot a mature personality

You can also skip raising the AIBO robot from the puppy stage, and have it immediately assume its mature personality.

When mature, the AIBO robot is fully capable of carrying its AIBOne toy, kicking the pink ball in various ways, and walking certain distances on its own.

Note

Even if you skip part of its development, the AIBO robot will remember everything it has learned to that point.

Hint

To cancel changes by voice guide, touch the head sensor to return the AIBO robot to Autonomous mode.

1 Touch the front and rear back sensors simultaneously for 3 seconds.

(Next, follow the voice guide.)



Voice guide mode, top menu. Let's select the function.

Please touch the following colors on my back sensor:
For Game mode, touch blue. For Setup mode, touch orange.
For Clinic mode, touch red.



Within 10 seconds*

2 Touch the middle (orange) back sensor.



Let's proceed with various setups.

Please touch the following colors of my back sensors:
For clock setup, touch blue. For Station dismount setup, touch orange.
For development control, touch red.



Within 10 seconds*

3 Touch the rear (red) back sensor.



To make me an adult, touch blue. To make me a newborn, touch orange.



Within 10 seconds*

4 Touch the front (blue) back sensor.



I will reboot as an adult. If this is OK, touch blue.



Within 10 seconds*

5 Touch the front (blue) back sensor.



If this is really OK, touch red.



Within 10 seconds*

* If you do not perform the operation within the prescribed number of seconds, the AIBO robot enters the Autonomous mode.

6 Touch the rear (red) back sensor.



I will reboot as an adult. I will turn OFF.

The AIBO[®] Entertainment Robot enters the Pause mode.

7 Touch the pause button on the AIBO robot's back to awaken it.

The AIBO robot wakes up as an adult.

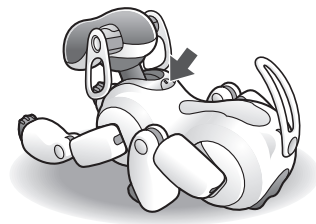

Learning and acquiring skills

The AIBO[®] Entertainment Robot learns from you and its surroundings, becoming capable of many different activities. If the AIBO robot paces back and forth, show it its AIBOne toy or pink ball. It will chase after the AIBOne toy or pink ball, becoming capable of walking longer distances.

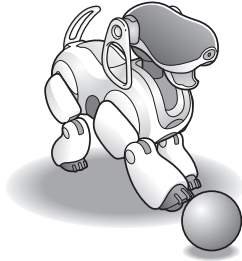

By praising the AIBO robot, you give it encouragement. If you praise it when it kicks the pink ball well, it practices hard to please you, becoming quite skilled in playing with the pink ball. On the other hand, if you don't praise its efforts, the AIBO robot may lose interest in the pink ball.

You can judge the degree of the AIBO robot's development from how it carries the AIBOne toy, the number of different ways in which it kicks the pink ball, and the distance it is able to walk around. When it shows tricks that are surprising, and walks longer distances, you will know that the AIBO robot has matured.

You can also check the degree of the AIBO robot's development directly.

Try asking it, *“What's your AIBOne skill level?”*, *“What's your pink ball skill level?”*, or *“What's your walking skill level?”*.

The AIBO robot will tell you how it's doing by indicating its progress with its face lights. Once it has mastered these skills... your AIBO robot is a proud grown-up!



The more white face lights, the higher the AIBO robot's skill level.

The AIBO[®] Entertainment Robot's feelings and personality development

The AIBO robot's feelings shift as it interacts with you, and are expressed through its face lights.

For example, the face lights shine green when it is happy, blue when it is sad, and red when it is angry.

The AIBO robot is also capable of a variety of other forms of expression, which on occasions can be quite complex. Watch it closely, and try to understand the shades of its feelings.

The AIBO robot's personality is formed through the accumulation of such heart-to-heart interactions.

When the AIBO robot falls down and can't get up, it will appreciate if you lend a helping hand. In return, it will make every effort possible to right itself on its own from the next fall. On the other hand, if you do not help it, it may become somewhat rebellious and come to depend on your help.

The personality that the AIBO robot forms can also change through learning at later stages. By closely watching its behavior and treating it with love and respect, a "spoiled" AIBO robot can reform itself into a strong and independent character, and a chronic fretting whiner can change into a deep-thinker that is capable of sure and steady action.

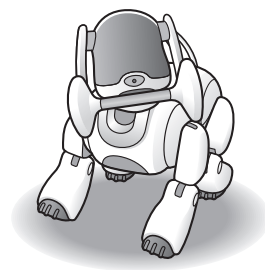

Playing in Game mode

The AIBO MIND software features a Game mode in which you can enjoy playing games with the AIBO[®] Entertainment Robot.

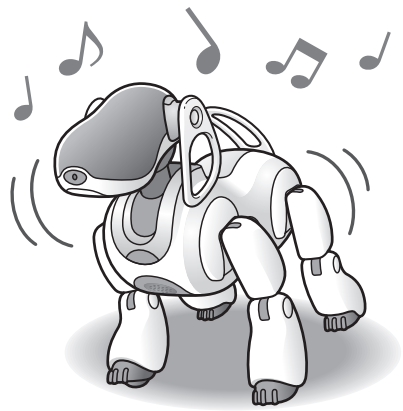

Playing Game 1, the AIBO[®] Entertainment Robot's "Function Demo"

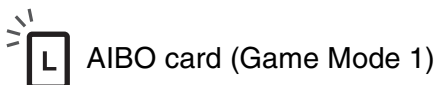

You can enjoy playing games with the AIBO robot when it is in Game mode. When the AIBO robot is first adopted, it only possesses one game, the Function Demo. However, using the AIBO Custom Manager (see the cautions below), you can obtain content and have the AIBO robot play up to 3 games.

Caution

- The AIBO robot's function demo game is not available while the AIBO robot is on the Energy Station. Take the AIBO robot off of the Energy Station before playing.
- To add games to the AIBO robot, you must have the AIBO Custom Manager software (supplied separately). (For the latest information on the AIBO Custom Manager (supplied separately) and available Game mode content, visit our Web site at <http://www.aibo.com>.)

Game 1 is a Function Demo that provides an entertaining introduction to the features of the AIBO MIND software.

To end Game mode and return the AIBO robot to Autonomous mode, touch the head sensor for 3 seconds.

1 Simultaneously touch the AIBO robot's front and rear back sensors for 3 seconds, or show it the "Game Mode 1 (L)" card.

(Next, follow the voice guide.)

When you show the AIBO robot the "Game Mode 1 (L)" card, it starts playing the game immediately.



Voice guide mode, top menu. Let's select the function.

Please touch the following colors on my back sensor:

For Game mode, touch blue. For Setup mode, touch orange.

For Clinic mode, touch red.



Within 10 seconds*

* If you do not perform the operation within the prescribed number of seconds, the AIBO robot enters the Autonomous mode or returns to the previous state.

2 Touch the front (blue) back sensor.



Let's select the game.

For #1, touch blue. For #2, touch orange. For #3, touch red.



Within 10 seconds*

3 Touch the front (blue) back sensor.

The AIBO® Entertainment Robot shows that it is ready for the demonstration by performing a happy little dance.

Prepare an AIBO card.

4 Show the AIBO robot an AIBO card, the AIBOne toy, or the pink ball.

The AIBO robot determines which demonstration and explanation it will show you, according to the card you show.

Card name	Demos & explanations
A	Dancing
B	Taking pictures
D	Sensors
F	Explanation of visual pattern recognition (AIBO cards)
H	Continuous demonstration of dances, expressions, and sensors
I	Clock functions
K	Explanation of growth and personality
L	Expression (face lights).
M	Explanation of the AIBO robot's photo album
N	Explanation of the AIBO EYES feature

If you show the AIBO robot its AIBOne toy or pink ball, and place it on the floor during the Function Demo, the AIBO robot will show you a variety of tricks.

To stop the demo, hide the AIBOne toy or pink ball from the AIBO robot, then touch the AIBO robot's head sensor.

* If you do not perform the operation within the prescribed number of seconds, the AIBO robot enters the Autonomous mode or returns to the previous state.

Notes

- In Game mode, the AIBO® cards have different meanings than in Autonomous mode. (When Game 1 starts, the AIBO Entertainment Robot interprets the cards as shown in step 4 on the previous page.)
- In Game mode 1, the AIBO robot will only respond to the following phrases.
AIBO, Shake hands, Good morning, Hello, Bye Bye, Sit down.

To end Game 1

Touch the head sensor for three seconds.

Settings

This chapter explains how to set various items that you may occasionally want to change.

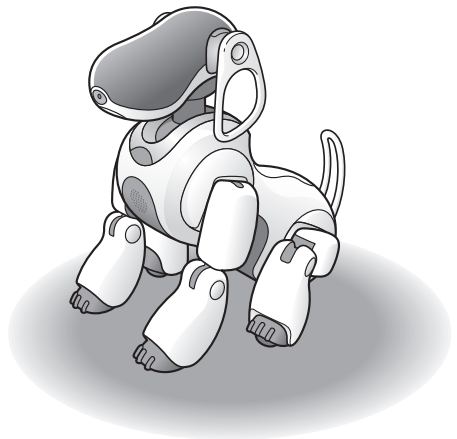

Setting the volume level of the AIBO[®] Entertainment Robot

You can set the volume level with an AIBO card, with the volume switch on the AIBO robot, or with the Energy Station.
Using an AIBO card is quick and simple.

Adjusting the volume with an AIBO card Volume

Show the AIBO robot the “Volume (K)” card.
The volume level is controlled by the direction in which the card is pointing.

To increase the volume, show the card like this:



To reduce the volume, show the card like this:



Volume adjustment is not possible if you hold the AIBO card sideways.

The volume can be adjusted in four steps, including mute. Each time you show the card, the volume changes by one step. Repeat the process until the desired volume level is set.

Adjusting the volume with the control switch on the AIBO[®] Entertainment Robot

Be sure to press the pause button on the AIBO robot's back to stop the AIBO robot's movements before performing the following steps.

- 1 Hold AIBO firmly by its body, turn it upside down, and remove the stomach compartment cover.**

Caution

- Always lift the AIBO robot by its body, not by its extremities.
- Do not touch the charging contacts located on the AIBO robot with your hand. Touching the contacts will reduce contact quality.

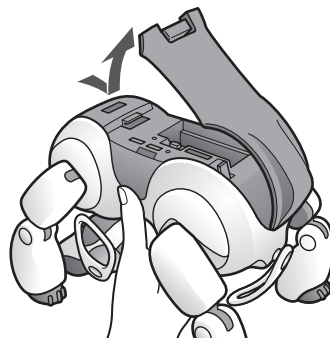

- 2 Use the volume control switch to set the volume.**

Slide the switch towards the + side to increase and towards the - side to reduce the volume. When you release the switch, it will return to the center position. The volume can be adjusted in four steps, including mute.

Each time you slide the switch, the volume changes by one step.

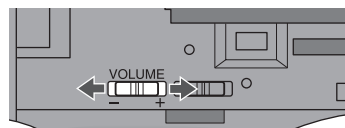

Adjusting the volume using the Energy Station

You can adjust the AIBO[®] Entertainment Robot's volume while the AIBO robot is on the Energy Station.

Caution

- When the AIBO robot is not on the Energy Station, you cannot change the setting. If you attempt to change this setting when the AIBO robot is not on the Energy Station, the pump and battery indicators on the LCD display will flash for several seconds to indicate that the AIBO robot is not on the Energy Station.
- To turn ON the display panel backlight, press the LIGHT/+ button. The backlight stays on for about 60 seconds when the AIBO robot is on the Energy Station, and for about four seconds when the AIBO robot is not on the Energy Station.

1 Place the AIBO robot on the Energy Station.

2 Press the MODE/NEXT button repeatedly until the volume level indication appears.

Each push of the MODE/NEXT button cycles through the display indications for date → time → time zone → volume.



3 Press the SET/CANCEL button.

The current volume level setting starts to flash.

4 Use the DISPLAY/- or LIGHT/+ buttons to change the volume level. Then press the MODE/NEXT button.

The volume level indication appears again, and the setting is transferred to the AIBO robot.

The volume level can be set from “0” to “3”. If you select “0”, the AIBO robot's sound is muted.

Caution

To cancel the setting process, press the SET/CANCEL button. The initial indication appears again, and the volume setting is not changed.

Changing the date and time

The AIBO[®] Entertainment Robot has a built-in clock.

To change the date and time settings, the AIBO robot must be on the Energy Station.

Caution

- When the AIBO robot is not on the Energy Station, you cannot change the setting. If you attempt to change this setting when the AIBO robot is not on the Energy Station, the pump and battery indicators on the LCD display will flash for several seconds to indicate that the AIBO robot is not on the Energy Station.
- To turn ON the display panel backlight, press the LIGHT/+ button. The backlight stays on for about 60 seconds when the AIBO robot is on the Energy Station, and for about four seconds when the AIBO robot is not on the Energy Station.

Setting the date and time

The following procedure assumes that the date display format is “Year/Month/Day”.

1 Place the AIBO robot on the Energy Station.

2 Press the MODE/NEXT button repeatedly until the date or time indication appears.

Each push of the MODE/NEXT button cycles through the display indications for date → time → time zone → volume.

3 Press the SET/CANCEL button.

The year indication starts to flash.

Caution

Only the last two digits of the year are shown (such as “03” for 2003).



4 Use the DISPLAY/- or LIGHT/+ buttons to set the year. Then press the MODE/NEXT button.

The month indication starts to flash.

5 Use the DISPLAY/- or LIGHT/+ buttons to set the month. Then press the MODE/NEXT button.

The day indication starts to flash.

6 Use the **DISPLAY/-** or **LIGHT/+** buttons to set the day of the month. Then press the **MODE/NEXT** button.

The hour indication starts to flash.

7 Use the **DISPLAY/-** or **LIGHT/+** buttons to set the hour. Then press the **MODE/NEXT** button.

The minute indication starts to flash.

8 Use the **DISPLAY/-** or **LIGHT/+** buttons to set the minute. Then press the **MODE/NEXT** button.

Caution

To cancel the setting process, press the SET/CANCEL button. The initial indication appears again, and the date/time setting is not changed.

Setting the time zone

Time zones indicate the difference to UTC (Coordinated Universal Time) in the range from -12 to +12 (in 1-hour increments).

The time zones for the continental United States are “-8”, “-7”, “-6”, and “-5”. For details on the time zones of the world, see “Time zone table” on page 118.

Caution

- When the AIBO[®] Entertainment Robot is not on the Energy Station, you cannot change the setting. If you attempt to change this setting when the AIBO robot is not on the Energy Station, the pump and battery indicators on the LCD display will flash for several seconds to indicate that the AIBO robot is not on the Energy Station.
- To turn ON the display panel backlight, press the LIGHT/+ button. The backlight stays on for about 60 seconds when the AIBO robot is on the Energy Station, and for about four seconds when the AIBO is not on the Energy Station.

1 Place the AIBO[®] Entertainment Robot on the Energy Station.

2 Press the MODE/NEXT button repeatedly until the date or time indication appears.

Each push of the MODE/NEXT button cycles through the display indications for date → time → time zone → volume.



3 Press the SET/CANCEL button.

The time zone indication starts to flash.

4 Use the DISPLAY/- or LIGHT/+ buttons to set the time zone. Then press the MODE/NEXT button.

The setting is entered and the time zone indication appears again.

Caution

- The time zone function does not support daylight savings.
 - To cancel the setting process, press the SET/CANCEL button. The initial indication appears again, and the time zone setting is not changed.
-

Changing the date and time display format

You can change the format in which the date and time are shown on the LCD display of the Energy Station.

Caution

- When the AIBO® Entertainment Robot is not on the Energy Station, you cannot change the setting. If you attempt to change this setting when the AIBO robot is not on the Energy Station, the pump and battery indicators on the LCD display will flash for several seconds to indicate that the AIBO robot is not on the Energy Station.
- To turn ON the display panel backlight, press the LIGHT/+ button. The backlight stays on for about 60 seconds when the AIBO robot is on the Energy Station, and for about four seconds when the AIBO is not on the Energy Station.

1 Place the AIBO robot on the Energy Station.

2 With the date or time indication being displayed, press the DISPLAY/- button.

Each press of the button changes the display format as follows.

- Date: Year/Month/Day → Month/Day/Year → Day/Month/Year
- Time: 12-hour clock → 24-hour clock

Caution

- The date and time formats return to their default settings when the AC adapter of the Energy Station is disconnected. Set the formats again when you reconnect the AC adapter.
 - The default setting is Year/Month/Day and 12-hour clock.
 - Also when you have set the Energy Station to the 24-hour clock format, the units for setting the time with the AIBO cards remain the same. When setting the time with AIBO cards always uses the 12-hour format.
-

Turning the wireless LAN function ON and OFF

Be sure to press the pause button on the AIBO[®] Entertainment Robot's back to stop the AIBO robot's movements before performing the following steps.

Caution

Turning switch to ON does not by itself make the wireless LAN function usable. Refer to the "User's Guide (PC-Network)" for the AIBO robot ERS-7(PDF) for instructions on how to configure the network.

- 1 Hold the AIBO robot firmly by its body, turn it upside down, and remove the stomach compartment cover.**

Caution

- Always lift the AIBO robot by its body, not by its extremities.
- Do not touch the charging contacts located on the AIBO robot with your hand. Touching the contacts will reduce contact quality.

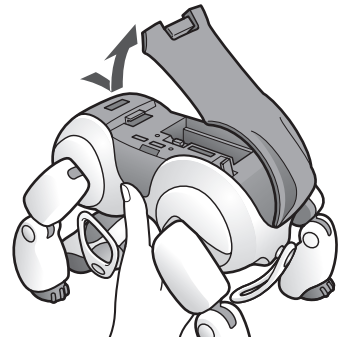

- 2 Set the wireless LAN switch to ON or OFF.**

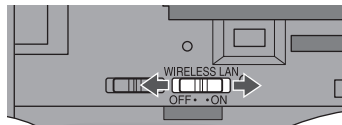

Additional Information

This chapter provides notes on use, a troubleshooting guide, and other information related to the AIBO[®] Entertainment Robot.

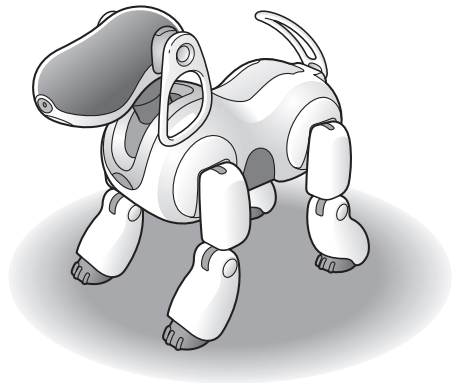

Notes on use

.....

To prevent damage to and malfunction of the AIBO[®] Entertainment Robot, Energy Station, AC adapter, and “Memory Stick[™]” media, carefully read and follow these precautions.

Handling the AIBO robot

- Do not use the AIBO robot in locations where there is a danger of falling objects, where the AIBO robot may be subject to vibrations, where there are stairs or steps, and where there is no firm support.
- Do not exert strong forces on the AIBO robot, such as pushing with hands or elbows.
- Do not subject the AIBO robot to shocks, and protect it from falls. Otherwise data may be lost and damage may occur.
- Do not touch the charging contacts. Otherwise contact problems may occur.
- Do not lift the AIBO robot by its head, ears, tail, or legs and do not twist these parts.
- Do not forcibly place the AIBO toy or any other object in the AIBO robot’s mouth.
- Do not subject the AIBO robot to extreme temperatures, such as by leaving it in direct sunlight or in a closed car.
- Do not insert paper clips or any other foreign objects into the AIBO robot’s body or in any joints.
- Do not use the AIBO robot outdoors. Otherwise, it may be damaged by water or foreign objects.
- Do not use the AIBO robot on concrete floors or similar hard surfaces. Otherwise it may be damaged and malfunction may occur.
- Do not use the AIBO robot on slippery floors or on thick-piled carpets. Otherwise it may be damaged by falling over or by carpet hair getting caught in the joints, which prevents the AIBO robot from moving forward.
- Do not let the AIBO robot get wet.
- Do not block the AIBO robot’s movements or exert force on the AIBO robot.
- Do not touch the color camera lens or distance sensors.
- Do not cover the color camera lens or distance sensors with stickers or similar objects.
- Never point the color camera at the sun, regardless of whether the power is turned OFF or on. Otherwise the camera may be damaged.
- Do not lubricate any of the joints or other moving parts of the AIBO robot.
- Do not attach any stickers on any of the moving parts of the AIBO robot and do not let anything get caught in them which could block movement.
- Do not attempt to disassemble or modify the AIBO robot. Your manufacturer’s limited warranty will not be honored if you modify your AIBO robot.
- When transporting the AIBO robot, use the original packing or another suitable box that will protect the body, head, tail, and legs from external force and shocks.

- If you are away from home for an extended period, disconnect the Energy Station’s AC adapter power cord from the wall outlet.
- Do not expose the AIBO® Entertainment Robot to strong magnetic fields or X-rays.
- Use only AIBO-ware compatible with the AIBO Entertainment Robot ERS-7. To verify whether your version of AIBO-ware is compatible with your AIBO robot model, refer to the AIBO-ware “Memory Stick™” media label.

Condensation

When the AIBO robot is brought from a cold to a warm location, moisture may form on its surface and on the inside. If the AIBO robot is used in this condition, damage may occur. Leave the AIBO robot in the new location for about an hour without starting it up, until the moisture has evaporated.

“Memory Stick” media handling

To protect the saved data on the “Memory Stick” media, note the following:

- The AIBO MIND software “Memory Stick” media is designed only for use with the AIBO robot ERS-7. It cannot be used with any other version of the AIBO robot.
- Do not use the AIBO-ware “Memory Stick” media to save data on PCs or camcorders, or for any purpose other than for the AIBO robot. Doing so may result in damage to the AIBO robot.
- Do not touch the terminal **A** with your hand or metal objects.
- If the “Memory Stick” media is used in a location subject to static electricity or electric noise, data may be lost or corrupted.
- Do not attach anything other than the dedicated label in the areas indicated by **B**.
- A label has already been attached to the AIBO-ware “Memory Stick” media at the factory.
- Do not bend or drop the “Memory Stick” media or subject it to strong shock.
- Do not attempt to disassemble or modify the “Memory Stick” media.
- To remove the “Memory Stick” media from the AIBO robot while it is still operating, first press the pause button to stop the AIBO robot’s movements.
- Keep the “Memory Stick” media away from water and other liquids.
- Do not use or store the “Memory Stick” media in places subject to:
 - Excessively high temperatures, such as in a car parked in the sun,
 - Direct sunlight, or
 - High humidity or corrosive gas.
- When carrying or storing the “Memory Stick” media, keep it in the supplied case.

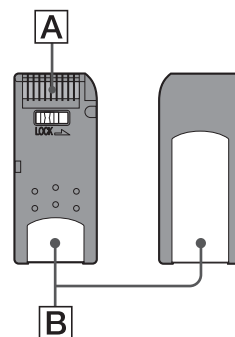

- The contents of the AIBO-ware “Memory Stick™” media cannot be copied to another “Memory Stick” media. Doing so contravenes with the clauses of the End-User License Agreement and may void your authority to use this product.
- Sony® assumes no responsibility for any malfunctions that may occur as a result of using the AIBO® Entertainment Robot in a way not specified in this manual.
- The specifications of the AIBO MIND software are subject to change without notice.

What is an AIBO-ware “Memory Stick” media?

It is a media produced by Sony exclusively for use with the AIBO robot, that contains application software that can only be executed on an AIBO robot.

Caution

- Do not set the safety switch of the “Memory Stick” media to “LOCK”. Doing so will make it impossible for the AIBO robot’s learning and picture taking functions to work.
- If the safety switch on the “Memory Stick” media is set to “LOCK”, the AIBO robot’s face lights will turn red to warn you when you press the pause button to start the AIBO robot up. Press the pause button once more to put the AIBO robot in Pause mode, then unlock the safety switch on the “Memory Stick” media.
When the AIBO robot starts up normally, the face lights turn white.

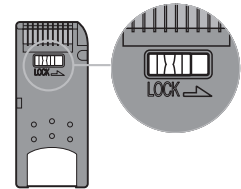

Energy Station handling

- While the AIBO robot is on top of the Energy Station, do not place any object near it that might interfere with its movements.
- Do not touch the charging contacts directly with your hand. Touching the contacts will reduce contact quality.
- Before moving the Energy Station, detach the station marker, station pole, and foot stopper.
- Do not press down hard on the Energy Station with your hand or elbow.
- Do not drop or shake the Energy Station as this may damage it.
- To prevent deformation and other damage, do not dismount the Energy Station in very hot places, such as in a car parked in the sun.
- Do not allow the Energy Station to get wet.
- Do not bend the station marker or subject it to strong force as this may damage it.

AC adapter handling

- Use only the supplied AC adapter or a separately available AC adapter designed specifically for this product. Otherwise damage may occur.
- The supplied AC adapter is designed only for use in the specific regions as follows. Do not use it in other regions at different voltages.

AC adapter input rating

U.S.A. model: 120 V AC, 50-60 Hz, 0.75 A

Other country models: 100 - 240 V AC, 50 - 60 Hz, 0.85 - 0.46 A

- Do not connect the AC adapter to electronic transformers, such as international travel converters/adapters. Otherwise overheating or damage may occur.

Battery handling

- Do not expose the battery to temperatures above 113°F (45°C). Doing so may result in performance degradation and damage.
- Take care that no dust or foreign objects enter the terminals of the battery.
- When not intending to use the AIBO[®] Entertainment Robot for a long time, remove the battery and store it in a cool location.
- Also when not in use, the battery will be subject to natural discharge. You should therefore charge it before using it again.
- Take care not to drop the battery or subject it to force or shocks.

Cleaning

- Clean the AIBO robot, the Energy Station, station pole, and station marker only by wiping with a dry, soft cloth.
- Do not use solvents that may damage the surface finish.
- If you are using a chemical dust cloth or a similar product, follow its usage instructions.

Troubleshooting

If you experience any difficulties, use this troubleshooting guide to check for possible causes before contacting AIBO Customer Link (customer service). For problems when using AIBO EYES feature and “AIBO Photo Album”, also refer to the troubleshooting section of the “User’s Guide (PC·Network)” for the AIBO robot ERS-7 (PDF). Should the problem persist, contact AIBO Customer Link (customer service). (See the front matter for details on AIBO Customer Link.)

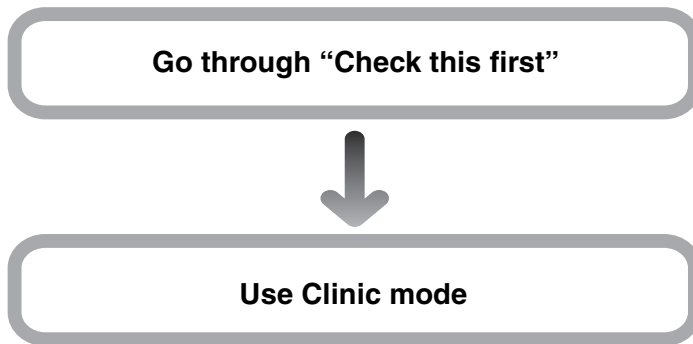

Check this first

Symptom	• Cause → Remedy (see page)
The AIBO® Entertainment Robot does not move even when you press the pause button.	<ul style="list-style-type: none">• The battery* is not inserted. → Insert the battery in the AIBO robot. Then press the pause button again to end Pause mode.• The battery* power is low. → Recharge the battery or replace the battery with a charged one.
When you press the pause button, the operation light alternately flashes green and orange, and a warning sound is emitted.	<ul style="list-style-type: none">• The temperature of the battery is abnormally high. → Wait until the battery* cools down.

* Only use a battery specifically designed for the AIBO® Entertainment Robot ERS-7.

Symptom	Cause → Remedy (see page)
The AIBO® Entertainment Robot emits a sad melody and does not move when you press the pause button.	<ul style="list-style-type: none"> • A “Memory Stick™” media without application software for the AIBO robot has been installed. <ul style="list-style-type: none"> → Insert a “Memory Stick” media compatible with software specifically designed for the AIBO Entertainment Robot ERS-7. • The “Memory Stick” media is defective. <ul style="list-style-type: none"> → Check the AIBO robot movements with the AIBO robot Operation Check mode. When you remove the “Memory Stick” media from the AIBO robot, it enters the AIBO robot Operation Check mode. If there is no problem with the AIBO robot itself, it will repeat the “Stand up” → “Sit down” → “Lay down” routine. (In this condition, the mode indicators flash yellow.)
The battery cannot be removed even when you operate the battery eject lever (BATT ▲).	<ul style="list-style-type: none"> • A program is running. Press the pause button to stop the program, and then remove the battery.
It takes a long time for the AIBO robot to start moving.	<ul style="list-style-type: none"> • Data is being read from the “Memory Stick” media. Wait a while.
The AIBO robot tries to walk but it does not move forward.	<ul style="list-style-type: none"> • The floor may be too slippery. <ul style="list-style-type: none"> → Place the AIBO robot on a surface that is not too slippery, such as low pile carpet.
The AIBO robot falls often.	<ul style="list-style-type: none"> • The floor may be too slippery, inclined, or unstable. <ul style="list-style-type: none"> → Place the AIBO robot on a flat surface that is not too slippery.
After you pick the AIBO robot up, it moves only slowly without any hand or leg motions.	<ul style="list-style-type: none"> • The AIBO robot is designed to stop moving whenever it is picked up from the floor. <ul style="list-style-type: none"> → Check to see if the mode indicators slowly flash green. If they do, place the AIBO robot on the floor. If it does not move after a while, touch the head sensor for 3 seconds. The AIBO robot will enter Autonomous mode again.
The mode indicators are lit orange, the AIBO robot does not move and its joints are limp.	<ul style="list-style-type: none"> • Something is jammed in one of the AIBO robot’s joints. <ul style="list-style-type: none"> → Place the AIBO robot on the floor and touch the head sensor for 3 seconds.

Symptom	Cause → Remedy (see page)
The operation light is flashing orange.	<ul style="list-style-type: none"> • Cause → Remedy (see page) • There may be a problem with the battery. <ul style="list-style-type: none"> → Check to see if the battery is inserted correctly into the AIBO® Entertainment Robot. If the flashing continues even though the battery is inserted correctly, contact the AIBO Customer Link (customer service).
The AIBO robot asks to be charged even with a fully charged battery.	<ul style="list-style-type: none"> • With a fully charged battery, the AIBO MIND software can normally operate for about 1.5 hours (in Autonomous mode). If the actual operating period is much shorter, the battery may be reaching the end of its service life. Replace it with a new battery specifically designed for the AIBO Entertainment Robot ERS-7 (battery model: ERA-7B1).
The AIBO robot emits no sound.	<ul style="list-style-type: none"> • The volume setting may be set to “Mute”. <ul style="list-style-type: none"> → Change the volume setting (page 82).
When the AIBO robot is placed on the Energy Station, its activity stops after a while.	<ul style="list-style-type: none"> • The AIBO robot is overheated. <ul style="list-style-type: none"> → Wait for the AIBO robot to cool down. Activity will resume automatically after an hour or so.
The AIBO robot does not self-charge.	<ul style="list-style-type: none"> • The station pole and station marker are not mounted correctly. <ul style="list-style-type: none"> → Attach these parts correctly (page 30). • The AIBO robot cannot recognize the station marker due to its surroundings. <ul style="list-style-type: none"> → Make the room brighter (fluorescent lighting is recommended), and remove any objects from around the Energy Station that are similar in color to those of the station pole and/or station marker. Next, perform a sensor check in Clinic mode (page 101) to test whether the AIBO robot can find the Energy Station.
Cannot perform owner registration.	<ul style="list-style-type: none"> • The AIBO robot cannot clearly identify your face. <ul style="list-style-type: none"> → Hold your head straight without tilting it to the side. If you are wearing a distinctive item, such as thick-rimmed glasses, hair is covering your face, the room is poorly lit, or if there is a light source behind you, the AIBO robot may not be able to identify you.

Symptom	Cause → Remedy (see page)
The AIBO® Entertainment Robot does not respond to AIBO cards.	<ul style="list-style-type: none"> • The AIBO robot cannot easily identify the card. <ul style="list-style-type: none"> → Make sure that you hold the card at right angles to the AIBO robot's line of vision, so that it can see the entire card. Remember that the AIBO robot will not be able to recognize the card if it is partially hidden by fingers or parts of your clothing, or if the room is too dark or the AIBO card is lit from the rear. • The AIBO robot does not respond to AIBO cards while you are making settings using the voice guide. • The AIBO robot may also ignore AIBO cards when it is looking for the Energy Station in order to charge itself. • The AIBO robot will not respond to AIBO cards if it is at the puppy stage.
The AIBO robot goes into Stop mode when placed on Energy Station.	<ul style="list-style-type: none"> • There is a problem with the connection between the Energy Station and the AC adapter, or between the AC adapter and the AC outlet. <ul style="list-style-type: none"> → Make sure that all connections are correctly established (page 32).
When a button is pressed, the battery level indicator on the Energy Station LCD display flashes.	<ul style="list-style-type: none"> • The AIBO robot is not correctly positioned on the Energy Station. <ul style="list-style-type: none"> → Press the button again after correctly positioning the AIBO robot on the Energy Station (page 32).
The battery level indicator is not shown on the LCD display.	<ul style="list-style-type: none"> • No battery is inserted in the AIBO robot. <ul style="list-style-type: none"> → Insert the battery before placing the AIBO robot on the Energy Station.
All three segments of the battery level indicator () on the LCD display are flashing simultaneously.	<ul style="list-style-type: none"> • Charging could not be carried out correctly. <ul style="list-style-type: none"> → Check to see if the battery is inserted correctly into the AIBO robot. If the flashing continues even though the battery is inserted correctly, contact the AIBO Customer Link (customer service).

Symptom	Cause → Remedy (see page)
<p>The AIBO® Entertainment Robot does not go into Clinic mode.</p>	<ul style="list-style-type: none"> • Cause → Remedy (see page) • There is a problem with the front (blue) or rear (red) sensor on the back of the AIBO robot. <ul style="list-style-type: none"> → Check the touch sensors on the AIBO robot's back in the AIBO robot Operation Check mode. <ol style="list-style-type: none"> 1 Remove the “Memory Stick™” media from the AIBO robot and press the pause button to start the AIBO robot. The AIBO robot goes into Operation Check mode. (In this condition, the mode indicators flash yellow.) 2 The AIBO robot repeats the “Stand up” → “Sit down” → “Lay down” routine. While the routine is in progress, simultaneously touch the front (blue) and rear (red) back sensors for 3 seconds. <p>The face and back lights should turn ON, and a sound should be heard.</p> <p>If the above response is observed, the touch sensors on the AIBO robot's back are functioning normally. The “Memory Stick” media may be defective.</p> <p>If the above response is not observed, one or more of the touch sensors on the AIBO robot's back may be defective. Contact the AIBO Customer Link (customer service).</p>
<p>No response when the sensors on the AIBO robot's back are touched. (The back sensors do not light when touched.)</p>	<ul style="list-style-type: none"> • See “The AIBO Entertainment Robot does not go into Clinic mode” above and check the touch sensors on the back of the AIBO robot.
<p>When in Game mode or Clinic mode, the mode light goes out and the AIBO robot returns to Autonomous mode.</p>	<ul style="list-style-type: none"> • When in modes other than Autonomous mode (such as Game mode and Clinic mode), the following situations may cause the AIBO robot to cease current activity and lie down with its legs spread in Autonomous mode. <ul style="list-style-type: none"> – Application of excessive external force to the AIBO robot. – Extended period of intense movement by the AIBO robot. – Having the AIBO robot perform intense movements for an extended period with AIBO cards, etc. → Please wait for a few minutes without changing the AIBO robot's mode. You will be able to switch from Autonomous mode to another mode (such as Game mode) after a few minutes.
<p>The AIBO robot's LEDs' light and/or color is irregular.</p>	<ul style="list-style-type: none"> • The AIBO robot ERS-7 is equipped with several LEDs, and a certain level of irregularity in the light and/or color of the LEDs is to be expected. This does not constitute a malfunction.

Checking with Clinic mode

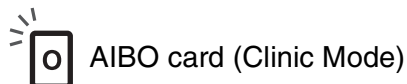

Using the “Clinic Mode (O)” card, you can check all of the basic AIBO MIND software functions (modes/actions, sensors, and recognition).

Once you enter the Clinic mode, the various checking steps are carried out by voice guide. When Clinic mode has started, observe the AIBO® Entertainment Robot’s movements and follow the voice guide instructions. When you operate the touch sensors and the expected reaction does not take place, note which parts are having problems and contact the AIBO Customer Link (customer service).

This section describes how to perform the “modes/actions check” → “sensor check” → “recognition check” in sequence. If you want to carry out only a specific check, you can briefly touch the head sensor to skip the current check and proceed to the next one. To return to Autonomous mode after the checks are completed, or during a check, touch the head sensor for 3 seconds.

-
- 1 While the AIBO robot is in Autonomous mode, simultaneously touch the front (blue) and rear (red) back sensors for 3 seconds. Alternatively, show the AIBO robot the “Clinic Mode (O)” card.**

(Next, follow the voice guide.)

If you have used the “Clinic Mode (O)” card, the voice guide of step 2 is heard immediately, and you can proceed to step 3.



Voice guide mode, top menu. Let’s select the function.

Please touch the following colors on my back sensor:
For Game mode, touch blue. For Setup mode, touch orange.
For Clinic mode, touch red.



Within 10 seconds*

-
- 2 Touch the rear (red) back sensor.**



Clinic mode.

Please touch the following colors on my back sensor:
For condition and motion, touch blue. To check sensors, touch orange. For recognition check, touch red.



Within 10 seconds*

* If you do not perform the operation within the prescribed number of seconds, the AIBO robot repeats the voice guide instructions. Without user input, the AIBO robot enters the Autonomous mode after repeating its instructions five times.

3 Touch the front (blue) back sensor.

The AIBO® Entertainment Robot assumes the “sit” position.



I'm going to check my conditions and motions.

■ Modes/actions check

Following the voice guide, the AIBO robot reports current modes and settings, and performs various actions.

■ “Follow the ball” check

This checks whether the AIBO robot can recognize and follow the pink ball.



Ball tracking check. Please show me my pink ball.

1 When you show the AIBO robot its pink ball, it will approach it.



If you wish to continue with ball tracking check, please move the ball. If you're finished, touch my head sensor.

2 Touch the head sensor to end the check.



I'm finished with the condition and motion check.

Please touch the following colors on my back sensor:
For condition and motion, touch blue. To check sensors, touch orange. For recognition check, touch red.



Within 10 seconds*

4 Touch the middle (orange) back sensor.



I'm going to check my sensors.

The AIBO robot lies down with its legs spread out.

* If you do not perform the operation within the prescribed number of seconds, the AIBO robot repeats the voice guide instructions. Without user input, the AIBO robot enters the Autonomous mode after repeating its instructions five times.

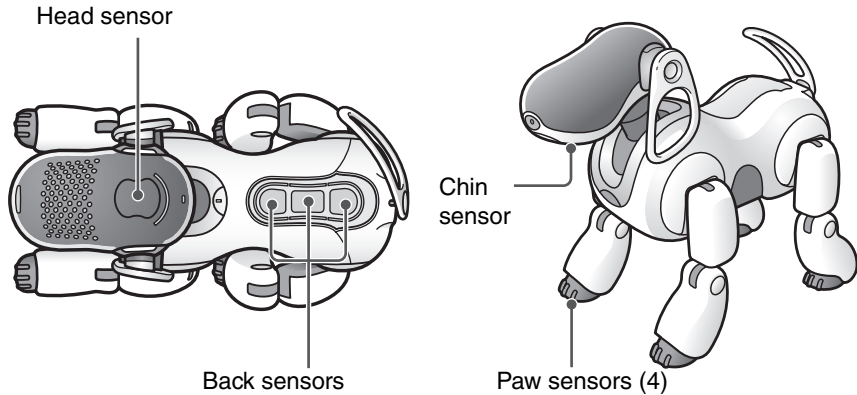

■ Paw sensor check



Please touch the paw pad of the leg I'm lifting.

When you press the paw sensor of the raised leg, a sound should be heard and the face lights turn ON. Then the AIBO® Entertainment Robot lowers the leg. (The AIBO robot should raise its legs in this order: left front, right front, left rear, right rear.)

■ Chin sensor check



Please touch my chin sensor.

When you touch the chin sensor, a sound should be heard and the face lights turn ON.

■ Head sensor check



Please touch my head sensor.

When you touch the head sensor, a sound should be heard and the head light turns ON.

■ Back sensor check



Please touch the lit up area of my back sensor.

When you touch the lit sensor, a sound should be heard and the back lights turn ON.

The back sensors should light in this order: front (blue), middle (orange), rear (red).

■ Head distance sensor check

The AIBO® Entertainment Robot assumes the “sit” position.



If you place your hand in front of my nose and move it forward and backwards you can change the sound, please confirm.

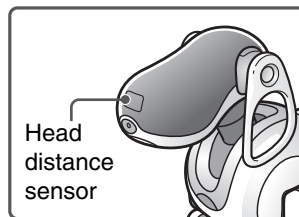

1 When you hold your hand in front of the head distance sensor in the AIBO robot's nose, a sound should be heard, unless the volume setting is set to mute.

The sound changes according to the distance between your hand and the sensor. The check will not work properly if your hand is too far or too close. Keep within the sensor range.

2 Touch the head sensor to end the check when prompted.

■ Chest distance sensor check



If you place your hand in front of my chest and move it forward and backwards you can change the sound, please confirm.

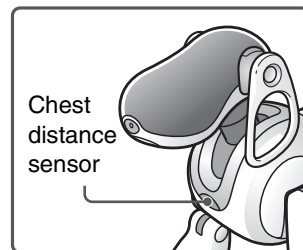

1 When you hold your hand in front of the chest distance sensor on the AIBO robot's chest, a sound should be heard, unless the volume setting is set to mute.

The sound changes according to the distance between your hand and the sensor. The check will not work properly if your hand is too far or too close. Keep within the sensor range.

2 Touch the head sensor to end the check when prompted.

■ Microphone check

 The sound I emit now will be recorded.

(AIBO[®] Entertainment Robot makes a sound and records it.)

 I will playback the sound I recorded.

The recorded sound is played back.

Because ambient sounds will also be picked up during recording, the playback sound may contain some noise. (The audio quality of the recording is about the same as sound from an AM radio.)

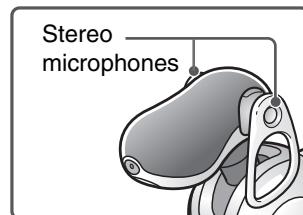

 I'm finished checking the sensors.

Please touch the following colors on my back sensor:
For condition and motion, touch blue. To check sensors, touch orange. For recognition check, touch red.

5 Touch the rear (red) back sensor.

 I will start the recognition check.

■ Voice recognition check

 Voice recognition check.
Please say "AIBO".

Say "**AIBO**". When voice recognition is successful, a sound should be heard and the face lights turn ON.

■ Ball recognition check

 Please show me my pink ball.

Show the pink ball to the AIBO robot. When pink ball recognition is successful, a sound should be heard and the face lights turn ON.

■ AIBOne toy recognition check

 Please show me my AIBOne.

Show the AIBOne toy to the AIBO robot. When the AIBOne toy recognition is successful, a sound should be heard and the face lights turn ON.

■ AIBO card recognition check



Please show me an AIBO card.

Show any AIBO card to the AIBO® Entertainment Robot. When the AIBO card recognition is successful, a sound should be heard and the face lights turn ON.

■ Station pole and station marker recognition check



I will check the station pole and station marker.

Please place my body about 8 in. or 20 cm away from the station marker. When you're ready, touch my head sensor.

Place the AIBO robot on the floor about 8 in. or 20 cm from the station marker. When the station pole and station marker recognition is successful, a sound should be heard and the face lights turn ON.

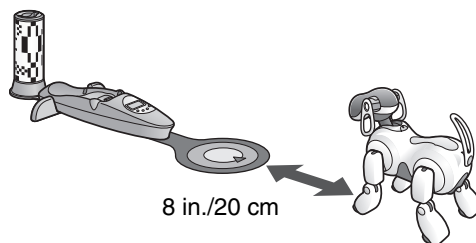

■ Face recognition check



Please show me your face.

Show the AIBO robot your face. When face recognition is successful, a sound should be heard and the face lights turn ON.



I've finished the recognition check.

Please touch the following colors on my back sensor:
For condition and motion, touch blue. To check sensors, touch orange. For recognition check, touch red.

6 Touch the head sensor for 3 seconds.



I'm finished with Clinic mode.

Hints

Clinic mode will also end if:

- The AIBO robot is placed on the Energy Station.
 - The AIBO robot is picked up.
 - Something has jammed in one of the AIBO robot's joints.
 - The AIBO robot has fallen over.
-

Limited warranty (for the U.S.A. only)

.....

SONY® ELECTRONICS INC. (“SONY”) warrants this Product and its accessories against defects in material or workmanship as follows:

1. **PRODUCTS:** For a period of one (1) year from the date of purchase, SONY will, at its option, either repair or replace the defective parts and/or the Product (i.e., AIBO® Entertainment Robot) with new or rebuilt replacements. After this one (1) year period, you must pay all parts and labor charges.
2. **ACCESSORIES:** For a period of thirty (30) days from the date of purchase, SONY will, at its option, either repair or replace defective parts and/or accessories (i.e., AC adapter and battery) with new or rebuilt replacements. After this thirty (30) day period, you must pay all parts and labor charges.
3. **REPAIRS:** For a period equal to the longer of (a) the remainder of the original limited warranty period on the original Product or accessory, or (b) for 90 days after the date of repair/replacement of Products or for 30 days after the date of repair/replacement of accessories, SONY will repair or replace defective parts, accessories and/or Products used in the repair or replacement of Products or accessories under this limited warranty with new or rebuilt replacements.

To obtain this limited warranty service, you must first obtain an event number from AIBO Customer Link (customer service) (page 5). You will need to return the Product and all accessories to SONY in the original carton, using the original packaging materials. All supplied accessories must be returned with the Product. SONY is not responsible for any damage during shipment arising from the failure to properly pack the Product or accessory being returned to SONY or from any damage caused by or resulting from the carrier’s handling. For information on returning your Product or accessories for limited warranty repair, please contact the AIBO Customer Link (customer service) at 1-800-427-2998 (USA) or e-mail to aibosupport@info.sel.sony.com.

This limited warranty does not cover customer instruction, installation or setup adjustments.

This limited warranty does not cover the cost of removal or reinstallation, cosmetic damage or damage due to acts of God, accident, misuse, abuse, negligence of, or to any part of the Product. This limited warranty does not cover lost profits, lost sales, loss of use of the Product, or other consequential loss or damage due to improper operation or maintenance, installation, connection to improper voltage supply, or attempted repair by anyone other than a facility authorized by SONY to service the Product. This limited warranty does not cover Products sold AS IS or WITH ALL FAULTS, or consumable (such as fuses). This limited

warranty does not apply when the malfunction results from use of the Product in conjunction with accessories, products or ancillary or peripheral equipment not manufactured by SONY®, and where it is determined by SONY that there is no fault with the Product itself.

SONY will pay shipping charges for all in-warranty service. However, if no malfunction is found with the Product or accessory, if the malfunction is from a non-covered charge or if it is determined that the limited warranty period has expired, you will be billed for the cost of shipping and handling.

This limited warranty is valid only in the United States.

Proof of purchase in the form of a bill of sale, receipt, or invoice (which is evidence that the unit is within the limited warranty period) must be presented to obtain the limited warranty service.

This limited warranty is invalid if the factory applied serial number has been altered or removed from the Product.

REPAIR OR REPLACEMENT AS PROVIDED UNDER THIS LIMITED WARRANTY IS THE EXCLUSIVE REMEDY OF THE CONSUMER. SONY SHALL NOT BE LIABLE FOR ANY INCIDENTAL OR CONSEQUENTIAL DAMAGES FOR BREACH OF ANY EXPRESSED OR IMPLIED WARRANTY ON THIS PRODUCT. EXCEPT TO THE EXTENT PROHIBITED BY APPLICABLE LAW, ANY IMPLIED WARRANTY OF MERCHANTABILITY OR FITNESS FOR A PARTICULAR PURPOSE ON THIS PRODUCT IS LIMITED IN DURATION TO THE DURATION OF THIS LIMITED WARRANTY

Some states do not allow the exclusion or limitation of incidental or consequential damages, or allow limitations on how long an implied warranty lasts, so the above limitations or exclusions may not apply to you. This limited warranty gives you specific legal rights, and you may have other rights which vary from state to state.

For your convenience, SONY ELECTRONICS INC. has established telephone numbers for product information regarding AIBO® Entertainment Robot. Please call:

AIBO CUSTOMER LINK (customer service)
1-800-427-2988

or write to: aibosupport@info.sel.sony.com

Other information about AIBO is also available on the internet site at:
<http://www.aibo.com>

Service procedure (for the U.S.A. only)

.....

- 1. Contact the AIBO[®] Customer Link (customer service). The e-mail address is aibosupport@info.sel.sony.com and its toll free number is 1-800-427-2988.**
- 2. If the AIBO Customer Link (customer service) determines that your unit needs repair, follow the procedure described below.**
 - a. The AIBO Customer Link (customer service) will give you the event number, which is valid for ten days.
 - b. Following the procedure described on the label attached to the box, put the AIBO robot and the designated accessories into the original box. If you did not keep the original box, the AIBO Customer Link (customer service) will send a new box to you free of charge within the limited warranty period. The actual shipping and material cost will be charged to you after the limited warranty period.
 - c. Mark your event number on the top of the box and send it to the designated address. The AIBO Customer Link (customer service) will designate the shipping method and pay the shipping charges within the limited warranty period; after the limited warranty period, you must pre-pay the shipping charges.
 - d. As soon as the repair is completed, your AIBO robot will be sent back to you. After the limited warranty period has expired, the actual shipping cost will be charged to you together with the repair cost.
- 3. Please understand that the AIBO Customer Link (customer service) only accepts credit cards for all the charges of repair, shipping and material after the limited warranty period has expired.**

User registration

All users are registered based on information from the purchaser.

If a different person takes over this AIBO Entertainment Robot unit, please inform the AIBO Customer Link (customer service) of the change.

Specifications

The AIBO[®] Entertainment Robot

CPU 64-bit RISC processor

RAM 64 MB

Program media

Dedicated the AIBO robot

“Memory Stick[™]” media

Moveable parts

Head: 3 degrees of freedom

Mouth: 1 degree of freedom

Legs: 3 degrees of freedom × 4

Ears: 1 degree of freedom × 2

Tail: 2 degrees of freedom

(Total 20 degrees of freedom)

Input section

Charging contacts

Setting switches

Volume control switch

Wireless LAN switch

Image input

350,000-pixel CMOS image sensor

Audio input

Stereo microphones

Audio output

Speaker

Integrated sensors

Infrared distance sensors × 2

Acceleration sensor

Vibration sensor

Input sensors

Head sensor

Back sensors

Chin sensor

Paw sensors

Power consumption

Approx. 7 W (in standard mode)

Operating time

Approx. 1.5 hours

(With fully charged ERA-7B1, in standard mode)

Dimensions

Approx. $7 \frac{1}{16} \times 10 \frac{15}{16} \times 12 \frac{9}{16}$ in.

(180 × 278 × 319 mm) (w × h × d)

Weight

Approx. 3 lb. 8 oz. (1.6 kg)

(including battery pack and “Memory Stick” media)

Operating temperature

41°F to 95°F (5°C to 35°C)

Operating humidity

10 to 80% (no condensation)

Operating wet-bulb temperature

Max. 84°F (29°C)

Storage temperature

14°F to 140°F (-10°C to 60°C)

Storage humidity

10 to 90% (no condensation)

Storage wet-bulb temperature

Max. 84°F (29°C)

Wireless LAN function

Wireless LAN module

(Wi-Fi certified)

Internal standard compatibility:

IEEE 802.11b/IEEE 802.11

Frequency band: 2.4 GHz

Wireless channels: 1 - 11

Modulation: DS-SS (IEEE 802.11-compliant)

Encryption: WEP 64 (40 bits), WEP

128 (104 bits)

The AIBO® Entertainment Robot ERS-7 incorporates a Wi-Fi certified wireless LAN module compliant with IEEE 802.11b.

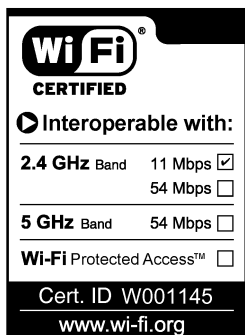

Energy Station

Power requirements

16 V DC

Power consumption

30 W

Output voltage

1.5 A at 16 V DC (for charging the AIBO robot's internal battery)

Charging time

Approx. 2 hours* (see page 51)

Display

LCD with back-lighting

Display size

Approx. 0.6 × 1.6 in.
(15 × 40 mm)

Dimensions

Approx. 15 ⁹/₁₆ × 3 ⁵/₈ × 2 ⁵/₈ in.
(396 × 92 × 66 mm) (w × h × d)
(Energy Station only)

Weight

Approx. 9 oz. (260 g) (Energy Station only)

Color

Black

Operating temperature

41°F to 95°F (5°C to 35°C)

Operating humidity

20 to 80%

Storage temperature

-4°F to 140°F (-20°C to +60°C)

Storage humidity

10 to 90%

* Charging time may differ, depending on the AIBO robot's operating conditions, ambient temperature, and other factors.

AC adapter

Input rating

US model:

120 V AC, 50-60 Hz, 0.75 A

Europe model:

100 - 240 V AC, 50 - 60 Hz,

0.85 - 0.46 A

Output

16 V DC, 2.5 A

Operating temperature

41°F to 95°F (5°C to 35°C)

(temperature change less than 50°F
(10°C)/h)

Operating humidity

20 to 80% (no condensation)

At 95°F (35°C), max. humidity

65% (wet-bulb thermometer
reading of less than 84°F (29°C))

Storage temperature

-4°F to 140°F (-20°C to +60°C)

(temperature change less than 50°F
(10°C)/h)

Storage humidity

10 to 90% (no condensation)

At 140°F (60°C), max. humidity

20% (wet-bulb thermometer
reading of less than 95°F (35°C))

Max. dimensions

Approx. $2 \frac{3}{8} \times 1 \frac{3}{16} \times 4 \frac{3}{4}$ in.

(60 × 30 × 120 mm) (w × h × d)

Weight

Approx. 11.5 oz. (325 g)

Cable length

DC cable approx. $70 \frac{7}{8}$ in. (1.8 m)

Power cord approx. $70 \frac{7}{8}$ in. (1.8 m)

Lithium-ion battery

Battery type

Lithium-ion

Rated voltage

7.4 V DC

Capacity

2200 mAh

Operating temperature

41°F to 104°F (5°C to 40°C)

(temperature change less than 50°F
(10°C)/h)

Operating humidity

10 to 80% (no condensation)

Operating wet-bulb temperature

Max. 84°F (29°C)

Storage temperature

-4°F to 140°F (-20°C to +60°C)

(temperature change less than 50°F
(10°C)/h)

Storage humidity

10 to 90% (no condensation)

Storage wet-bulb temperature

Max. 95°F (35°C)

Dimensions

Approx. $2 \frac{7}{8} \times 2 \frac{1}{8} \times 2 \frac{7}{32}$ in.

(72 × 53.6 × 21 mm) (w × h × d)

Weight

Approx. 4 oz. (112 g)

Design and specifications are subject to
change without notice.

Supplied items

See page 6.

Reference Material

- AIBO® card at a glance
- Words understood by the AIBO Entertainment Robot
- Time zone table

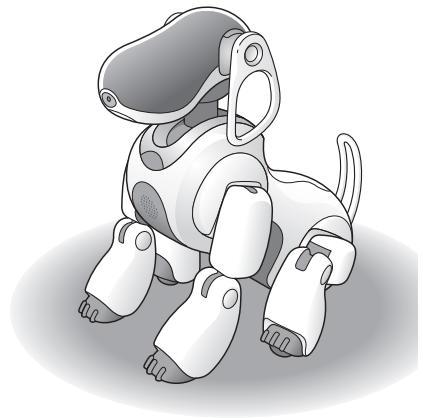

AIBO[®] card at a glance

Front and back

Front side

Show the AIBO Entertainment Robot the side with the graphic.

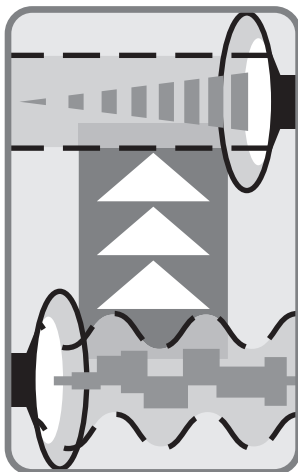

Back side

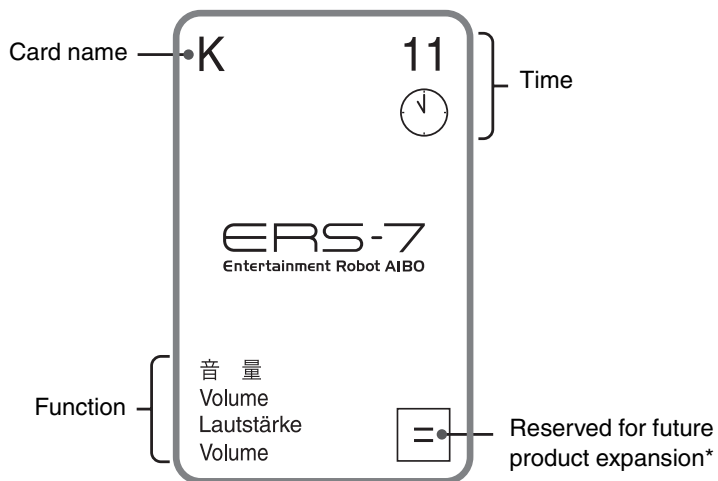

* For the latest information on future Game mode content, visit our Web site at <http://www.aibo.com>.

List of AIBO[®] cards

The following AIBO cards are supplied with the AIBO Entertainment Robot ERS-7.

Card name	Function	Time setting function	Expanded function
A	Dance : The AIBO Entertainment Robot dances.	1	1
B	Photo : The AIBO robot takes a picture (page 66).	2	2
C	U-turn : The AIBO robot makes a 180° turn.	3	3
D	Sit : The AIBO robot sits.	4	4
E	Lay down : The AIBO robot lays down.	5	5
F	Turn : When you show the ← or → direction, the AIBO robot makes a 90° turn in that direction. When you show ↑ or ↓ direction, the AIBO robot only moves its head up or down.	6	6
G	Station : The AIBO robot looks for the Energy Station and charges itself.	7	7
H	Follow : When you move slowly while showing this card, the AIBO robot will follow the card.	8	8
I	Alarm Clock Set Up : The AIBO robot lets you set the wake-up time and the clock time (page 44)	9	9
J	Alarm On/Off : Switches the wake-up function ON and OFF (page 49)	10	10
K	Volume : The AIBO robot lets you adjust its volume. When you show the card pointing up Δ, the volume increases. When you show the card pointing down ∇, the volume decreases (page 82)	11	=
L	Game Mode 1 : The AIBO robot starts game 1 (page 78).	12	×
M	Game Mode 2 : The AIBO robot starts game 2 (not set by factory default condition).	AM	÷
N	Game Mode 3 : The AIBO robot starts game 3 (not set by factory default condition).	PM	-
O	Clinic Mode : The AIBO robot goes into Clinic mode (page 101)	0	+

Words understood by the AIBO[®] Entertainment Robot

This section contains all the words understood by the AIBO robot. Use them to praise, scold, teach, or play with the AIBO robot.

In the following cases, the AIBO robot may not understand what you say.

- The AIBO robot may not be able to hear you easily when it is emitting sounds or moving around.
- The AIBO robot may not recognize several words depending on its mode or condition.
- Even though the AIBO robot understands you, it may choose not to respond or do as you say.
- The AIBO robot cannot hear you if its surroundings are noisy. Speak to the AIBO robot under quiet conditions.
- If your pronunciation of a word is unclear, the AIBO robot cannot recognize it. Speak very clearly.
- When the AIBO robot is at the puppy stage, it can only understand a limited number of words. For details about the words that the AIBO robot can understand when it is at the puppy stage, see page 72.

● Calling the AIBO robot's name

AIBO./Registered name (the name you gave AIBO).

The AIBO robot reacts when it is called. Even after the AIBO robot learns its own name, it reacts when you call it "*AIBO*".

● Teaching the AIBO robot

Name registration.

Give a name to the AIBO robot (page 60).

What's your name?

The AIBO robot says the name you gave it in its own voice.

Owner registration.

You can teach the AIBO robot its owner's (your) name (page 61).

What's your owner's name?

The AIBO robot says its owner's name (your name) in its own voice.



● Praising, scolding, or encouraging the AIBO robot

Good AIBO./Good boy./Good girl.

These words are for praising the AIBO robot. They have the same effect as when you praise the AIBO robot by touching the sensors on the back of the AIBO robot.

Don't do that.

These words are for scolding the AIBO robot. They have the same effect as when you scold the AIBO robot by tapping the sensors on the back of the AIBO robot.

Go for it./How cute.

These words are for encouraging the AIBO robot.

● Greetings

Good morning./Hello./Good night./Bye bye./Good bye./I'm here./Say hello./Shake hands.

● Self-charge

Go to the Station.

The AIBO® Entertainment Robot starts the procedure for self-charging.

● Taking a picture

Take a picture.

The AIBO robot takes a picture with its built-in camera (page 66).

● Playing with the AIBOne toy

Find your AIBOne.

The AIBO robot looks for the AIBOne toy.

Bring me your AIBOne.

When you say this while the AIBO robot is holding the AIBOne toy in its mouth, the AIBO robot comes to you.

● Playing with the ball

Find your ball.

The AIBO robot looks for the ball

● Wake-up setting

Set alarm.

Lets you set the wake-up function ON or OFF (page 49).

● Moving

Come here./Over here./Sit down./Stand up./Lay down./Turn right./Turn left./Walk around./Go forward./Go back.

● Questions for the AIBO robot

Are you sleepy?/Are you tired?/Are you bored?/How are you?

The AIBO robot shows its current condition with its face lights.

Are you hungry?

The AIBO robot shows the remaining battery power level by the number of face lights. The more lights are lit, the more power is still left.

What's your AIBOne skill level?/What's your pink ball skill level?/What's your walking skill level?

The AIBO robot shows its state of progress with the face lights.

● Special actions

Let's dance.

The AIBO robot shows you its dance repertoire.

- * For information on words understood by the AIBO robot when you are using the wireless LAN function, refer to the "User's Guide (PC-Network)" for the AIBO robot ERS-7.

Time zone table

.....

Use this table to enter the appropriate time zone. Time zones indicate the difference to UTC (Coordinated Universal Time) in the range from -12 to +12 (in 1-hour increments). The time zones for the continental United States are “-8”, “-7”, “-6”, and “-5”.

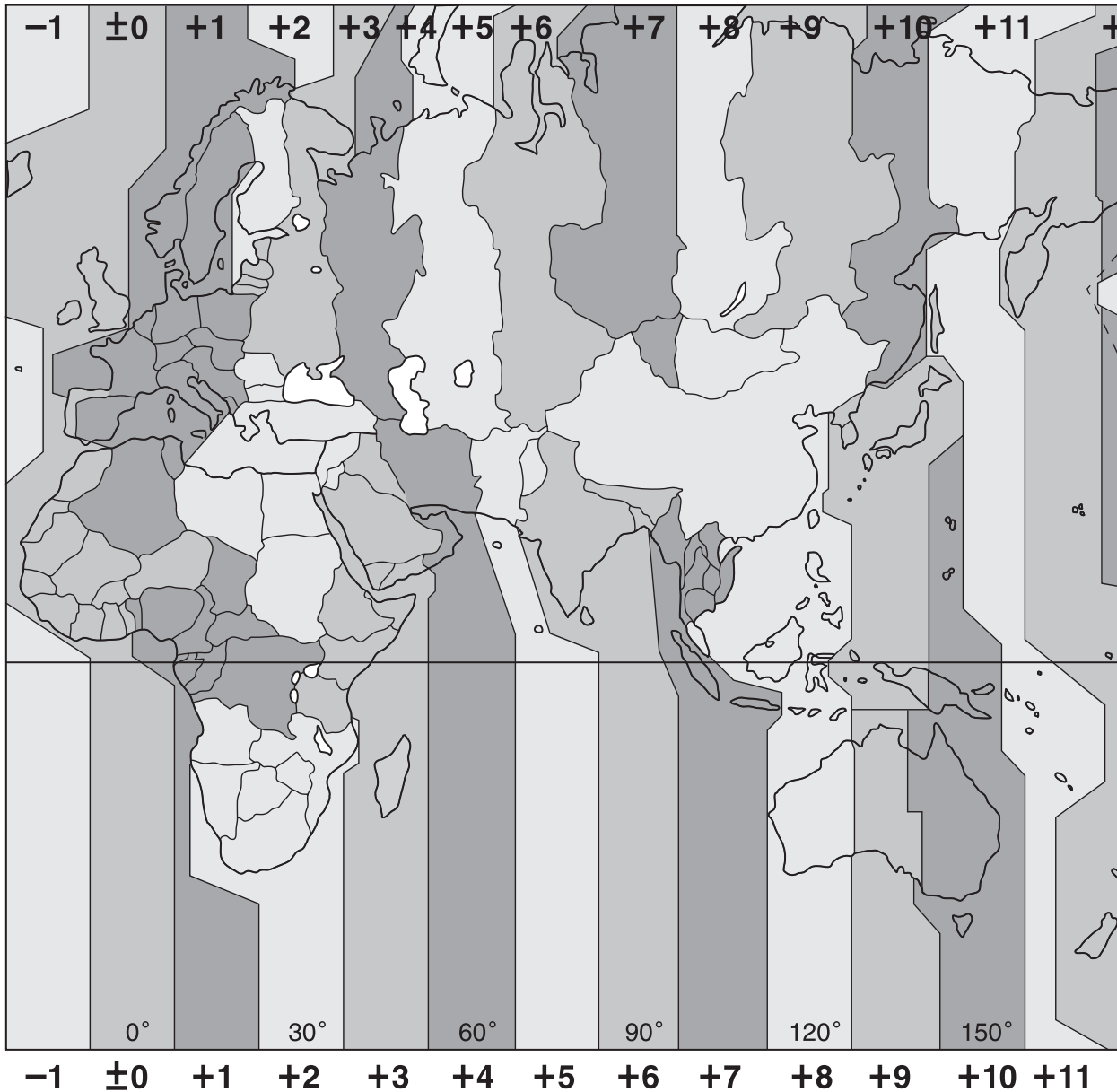

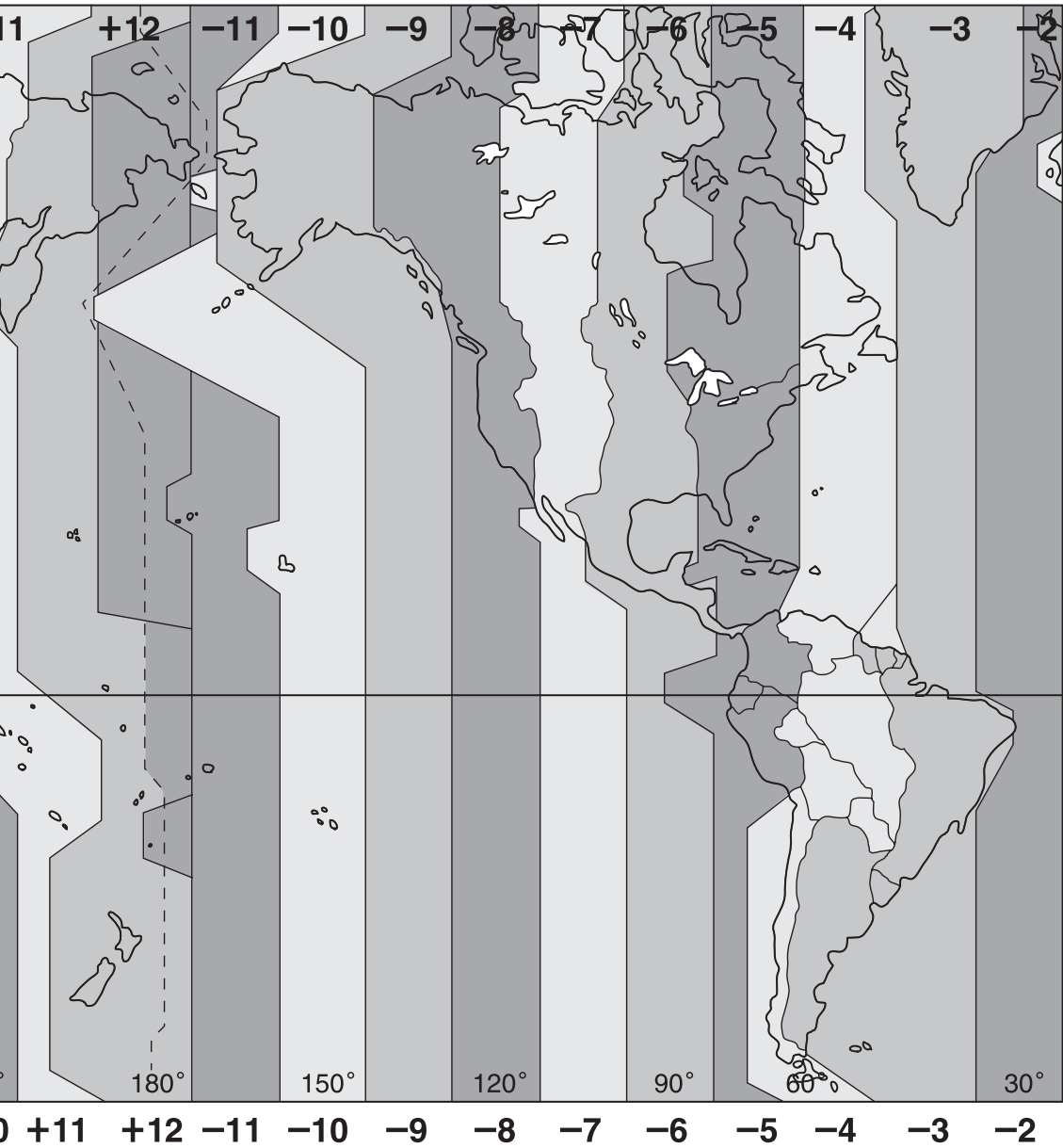

Reference Material



Printed on 100% recycled paper using
VOC (Volatile Organic Compound)-
free vegetable oil based ink.

Printed in Japan © 2003 Sony Corporation



* 4 6 7 8 7 9 3 1 2 * (1)