



# BLUETOUCH<sup>®</sup>

## MUSIC

ENGLISH

### Operating manual

BLUETOUCH<sup>®</sup> software 1.04.00

 TOUCHSCREEN DISPLAY



 VOICEDIALING

 iPod<sup>®</sup> Connection

 individualcolour

 SOFTWARE UPDATE

[www.bluetouch.de](http://www.bluetouch.de)

# OPERATING MANUAL

Introduction / Contents / Accessories / Notes.....02  
 Touch screen / Status display / Mounting.....03  
 Overview of the function keys.....04 / 05  
 Bluetooth® connection.....06  
 Music playback / SD card / USB.....07  
 iPod® / A2DP.....08  
 3.5 mm plug / Telephony.....09  
 Telephony / Speech recognition.....10  
 Speech recognition / Speech prompts.....11  
 Trouble shooting / Legal references.....12

## Introduction

BLUETOUCH® offers you the capability to connect mobile sources of music such as Apple™ iPod®, SD-cards, USB sticks, audio streaming via Bluetooth®-A2DP and MP3 telephones and players. At the same time, BLUETOUCH® is a convenient hands-free system for Bluetooth® telephones.

## Bluetooth® Technology

With the help of the wireless Bluetooth® technology, you can transfer data (telephone contacts, music) from your mobile phone to BLUETOUCH®. Thus hands-free telephony and playback of your music files are possible in the vehicle. To use these functions, read the operating manual of your mobile phone and the notes on this page and the last page.

## Contents

The following elements are included as standard equipment:

- Touch screen
- Ball joint support
- Display cable
- Electronic box (CIB-Box)
- External microphone
- 3.5 mm plug

Further connection cables are specific to the vehicle and the radio. You will find the exact contents listed on the label of the product packaging.

02

## Optimal mounting in the vehicle

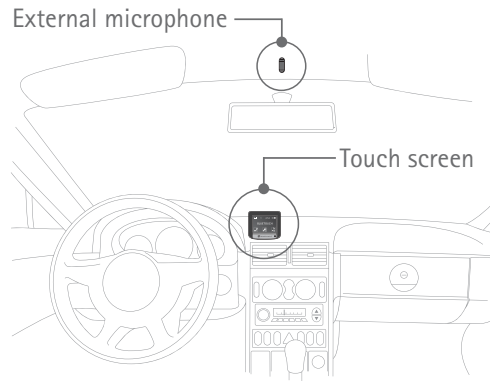

## Optional accessories

- iPod connection cable
- Mobile phone specific adapter cable (to connect a music capable mobile phone, see page ??).
- Mobile phone specific charging cradle (charging function and antenna connection).

Information concerning accessories and the current product range can be found at [www.bluetouch.de](http://www.bluetouch.de)

**!** Road safety is the highest priority. Operate the BLUETOUCH® system only when traffic permits. Make yourself familiar with the system before you leave.

**!** BLUETOUCH® was developed for subsequent installation in vehicles therefore only qualified technical personnel are permitted to install the system.

**!** If BLUETOUCH® does not start with ignition of engine touch the display for one second.

**!** Position the screen so that you are able to glance at the display quickly and easily. The device should also be positioned in a way that avoids reflections and glare from the screen. The screen should also not be positioned within the area directly in front of the airbag as this may prevent the airbag from inflating. Make sure the device is sufficiently secure so that it will not become dislodged even in the event of emergency braking or a collision.

**!** Please do not use any cleaning agents or detergents to clean the screen and case of the device. The best method is to use a soft, damp cloth.

03

## Mounting of the touch screen

Select a place for installation where the touch screen is both easy to read and operate. Mount the ball joint (B) with the screw (A) on the display. Press both firmly onto the ball unit (C), which must be mounted beforehand. Now attach the connection cable (D) to the touch screen so that the plug fits in the housing. Due to the ball joint any view can be set individually.

## Overview of the touch screen

The control of all functions takes place via the touch screen. There are readouts and keys (framed) on the touch screen. Only keys can be pressed in order to activate an action or switch into another menu.

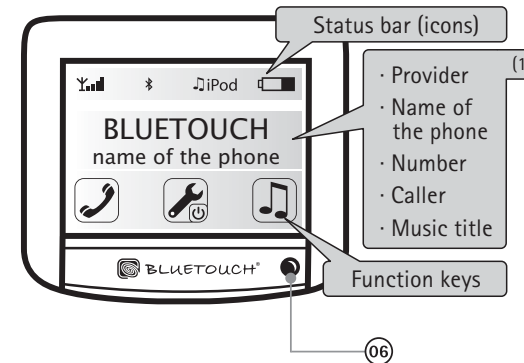
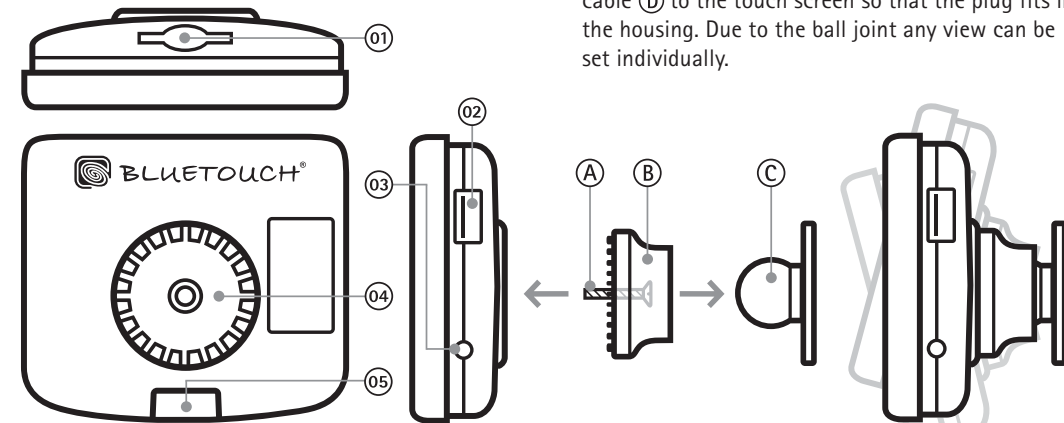

- 01 SD / MMC memory card port
- 02 Software update via USB link
- 03 3.5 mm stereo audio input
- 04 Mounting surface for the ball joint mounting
- 05 Port for attaching the connection cable to the electronic box
- 06 Light sensor for the automatic adjustment of the display brightness

- (A) (B) (C) Elements of the ball joint
- (D) Connection cable to the electronic box

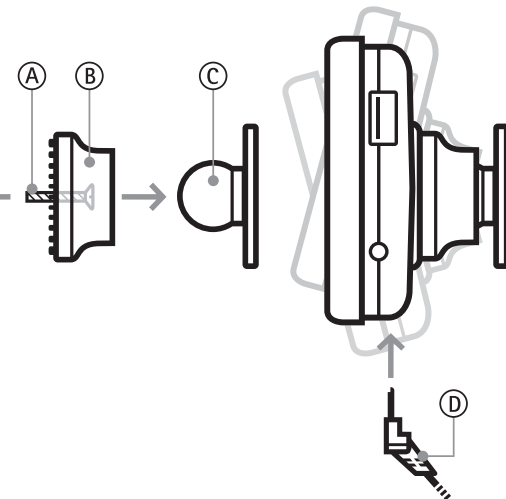

## Icons in the status bar

- Signal strength of the mobile phone (1)
- 88,0 Frequency setting (optional)
- Bluetooth® connection established
- Connection via HFP-profile
- Connection via A2DP-profile
- Connection via HFP + A2DP-profile
- Establish Bluetooth® connection
- Bluetooth® download of the contacts
- iPod iPod as an active music source
- SD/MMC card as an active music source
- USB USB stick as an active music source
- 3.5 mm plug as an active music source
- Bluetooth®A2DP Bluetooth®A2DP as an active music source
- Battery level of the mobile phone (1)

(1) The transfer of these signals depends on the mobile phone.

## Operation of the function keys

All keys (framed) trigger a function or lead into a further menu. Some keys have double functions in order to reach a certain function faster. This double function is activated by holding the res-

04

pective key (hold 1 second, then release). If a key has a double function (hold 1 second, then release) this is briefly explained below in *italics*.

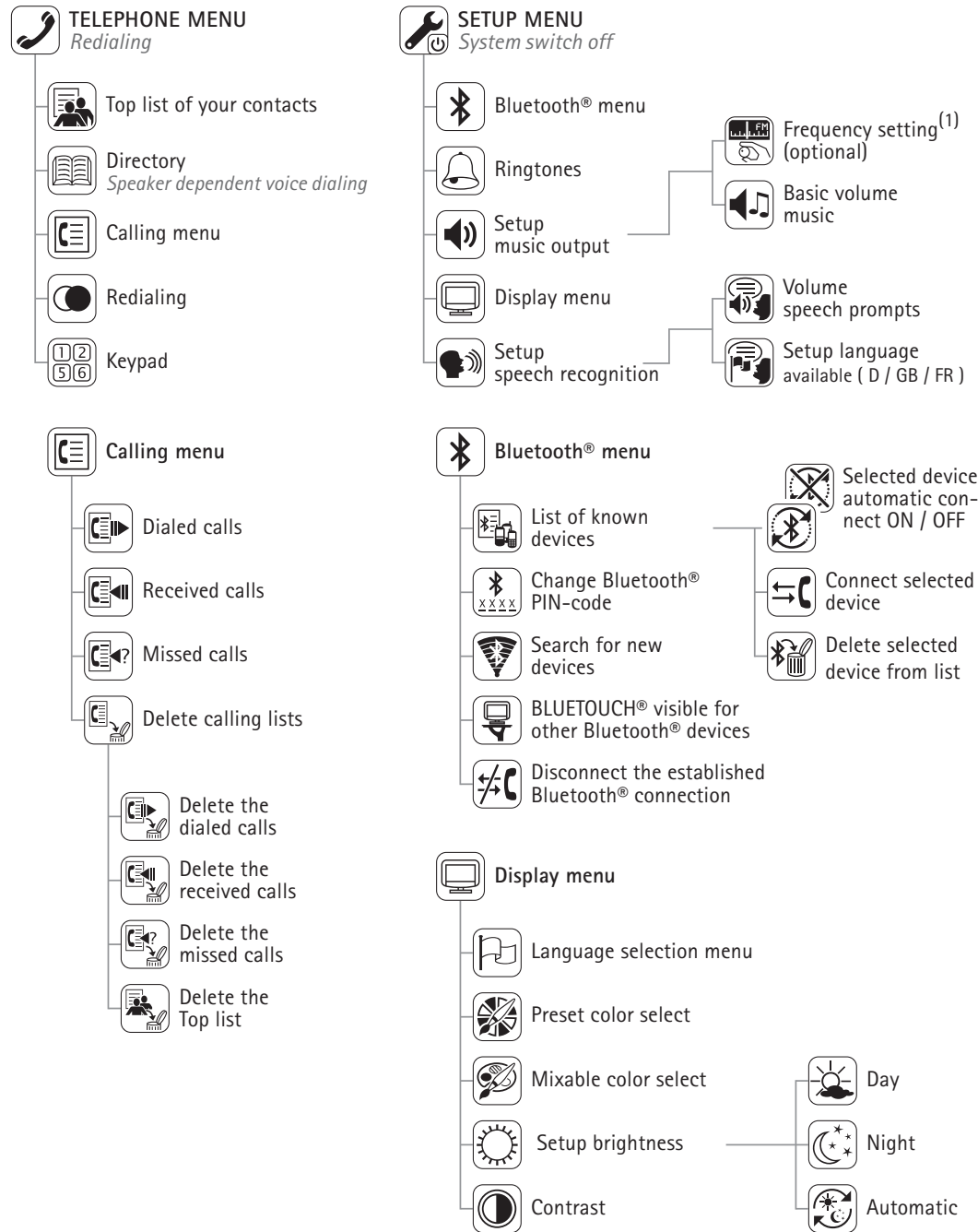

05

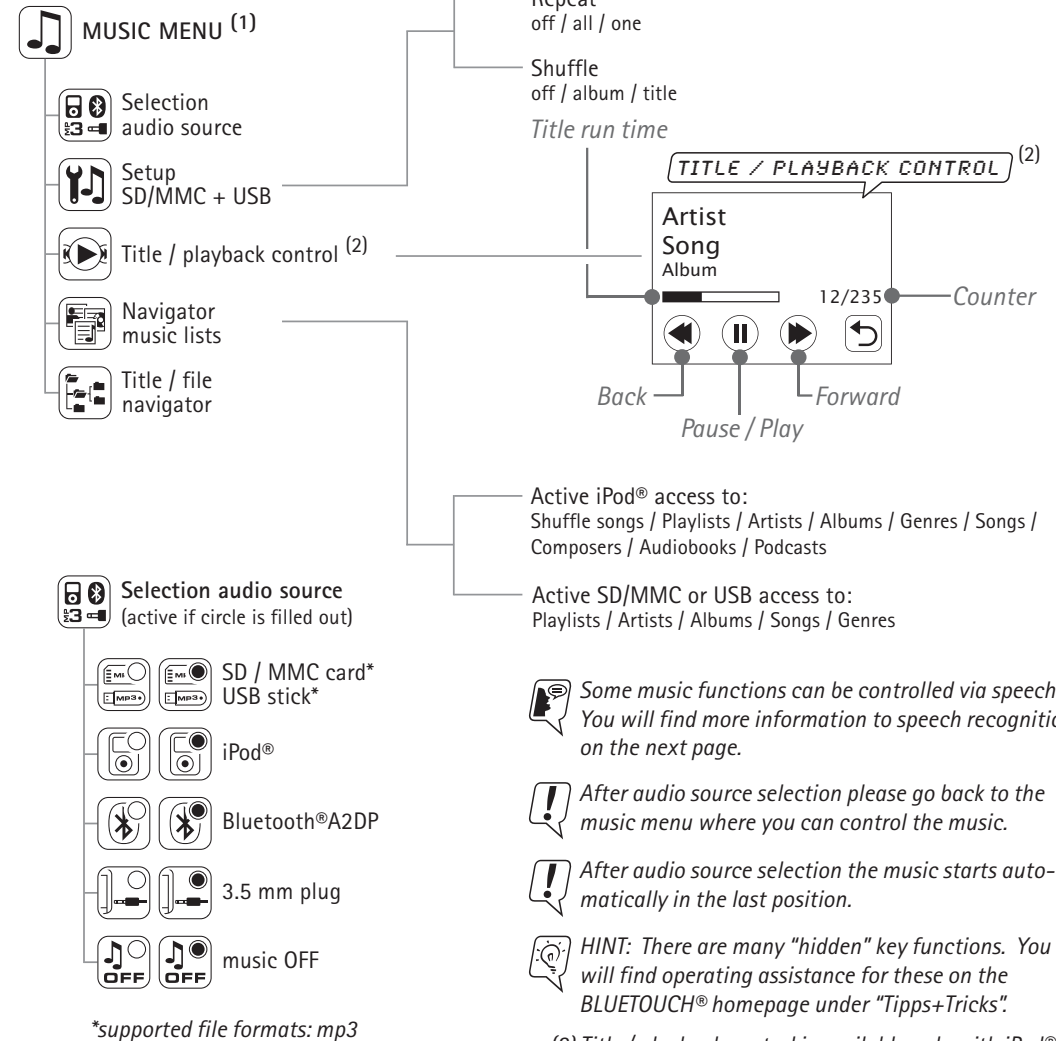

### Additional keys

- Back  
*To the main menu*
- Digit 0  
*Plus symbol*
- Delete last digit  
*Delete the whole input*

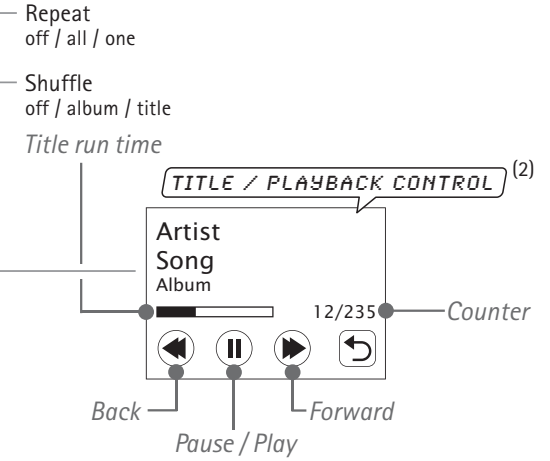

- Repeat off / all / one
- Shuffle off / album / title
- Title run time
- Active iPod® access to:  
Shuffle songs / Playlists / Artists / Albums / Genres / Songs / Composers / Audiobooks / Podcasts
- Active SD/MMC or USB access to:  
Playlists / Artists / Albums / Songs / Genres

Some music functions can be controlled via speech. You will find more information to speech recognition on the next page.

After audio source selection please go back to the music menu where you can control the music.

After audio source selection the music starts automatically in the last position.

HINT: There are many "hidden" key functions. You will find operating assistance for these on the BLUETOUCH® homepage under "Tips+Tricks".

(2) Title / playback control is available only with iPod®, SD/MMC or USB connection. Music playback via Bluetooth®A2DP doesn't support the title menu.

**(1) Concerning the music menu**

If this key appears on your touch screen, please follow the directions on the attached card (FM-modulation). The functions are identical to those of the music menu.

## Bluetooth® connection

In order to use the hands-free function as well as the music transfer via Bluetooth®A2DP, the following requirements must be fulfilled:

- BLUETOUCH® has been correctly mounted and is switched on.
- Bluetooth® is activated on your mobile phone.
- Your mobile phone was paired with BLUETOUCH®.

### First pairing of your mobile phone

- Press the **search key** in the Bluetooth® menu.
- When the search procedure is finished, select your mobile phone shown on the display.
- BLUETOUCH® now demands a PIN-code. Enter this PIN (0000 is preset) on your mobile phone.
- BLUETOUCH® and the mobile phone are now paired and your directory of contacts is downloaded automatically. The download is finished when the Bluetooth® symbol is displayed.
- Your mobile phone is now in the list of known devices.

### Pairing and deleting a mobile phone from the list of known devices

- Select the desired mobile phone from the list of known devices.

You can now do the following with the selected mobile phone:

- **Automatic pairing** so that the selected device is paired to BLUETOUCH® as soon as you approach the system.
- **Manual coupling.**
- **Delete from list.**

### Changing the PIN-code

- Press the **PIN-code key** to read the keypad.
- Enter a combination of at least 4 digits and confirm by pressing **OK**.

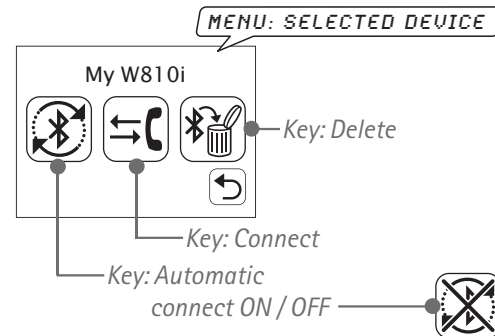
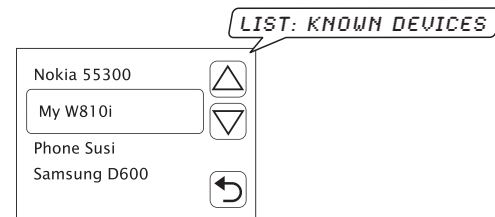
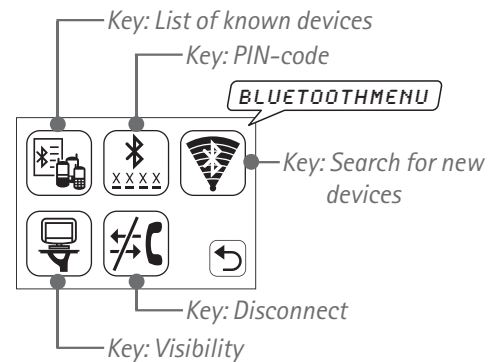

 You can also establish a connection to BLUETOUCH® from your mobile phone. In order to do so set BLUETOUCH® to "visible" and follow the operating manual of your mobile phone.

 A multiple pairing of up to five mobile phones is possible.

 **ADVISE:** Give your mobile phone a special name in order to find it more easily in the selection list (see page ??) among same mobile phones. Look in the operating manual of your mobile phone for further information.

 With all described Bluetooth® functions please consult the operating manual of your mobile phone first. Inform yourself which Bluetooth® profiles and functions your mobile telephone supports. Signal level, battery status, provider, directory entries and downloads are mobile phone specific, and how they are supported depending on the individual mobile phone.

## Music playback

BLUETOUCH® offers you the connection of mobile sources of music such as Apple™ iPod®, SD cards, USB sticks, audio streaming via Bluetooth®A2DP and MP3 telephones and players.

The touch screen allows for the easy and convenient operation of all music functions.

### Selection of the desired music source

- In the music menu, press the **key select music source**.
- Now activate the desired source (the audio source is activated when the circle is filled out).
- Using the **back key**, you will return to the music menu. From there you will be able to use the various functions of this menu for music navigation.

### Management of music using music lists

This function is only available with SD/MMC card, USB storage medium and iPod®!

- Press the **key navigator music lists** in the music menu.
- You now have convenient access to all titles with information about the artists, genre etc. as well as to all possible saved playlists.

### Management of music using music files

This function is only available with SD/MMC card, USB storage medium and iPod®!

- Press the **key title / file navigator** in the music menu.
- You have now access to all music files.

## Playback of the music from SD/MMC card and USB stick

BLUETOUCH® supports the music playback of SD/MMC cards and USB storage media, e.g. USB stick. Connect the desired audio source with the touch screen as illustrated on the right; then activate this in the music menu, as described above. You now have access to all music lists or to the saved music files.

 Be sure to connect only one audio source to the touch screen in each case; otherwise, delays can occur during playback.

 SD/MMC cards and USB storage media support the playback of MP3 files.

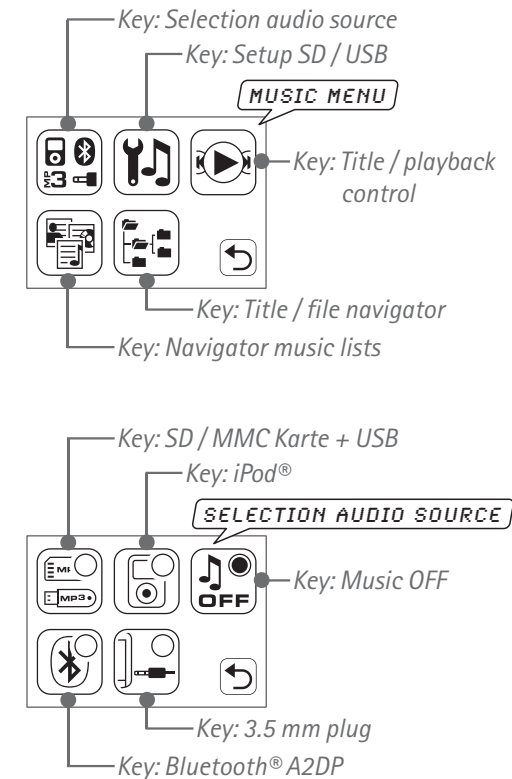

 You will get more information on connection and operation of the various audio sources from the following articles.

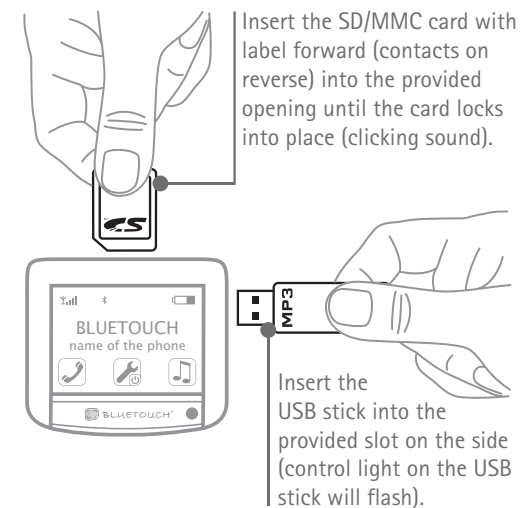

## 08 Playback and connection of an iPod®

BLUETOUCH® was developed for the use with all iPods with dock connector. The touch screen offers the possibility of operating the iPod menu. You can browse through your tracks, artists, albums and play lists to the full extent, just as you are used to doing with your iPod.

- Connect your iPod with the connection cable.
- Start BLUETOUCH®, switch to the music menu, and using the iPod key you will reach the iPod menu navigation familiar to you.

### Disconnecting the iPod

- Slightly press both sides of the locking mechanism (A) of the cable jack in order to remove the cable from the iPod.

When connected with the cable the iPod is in charge mode.

As soon as the iPod is connected to the cable, the BLUETOUCH® logo appears in the display of the iPod. Now you operate only via BLUETOUCH®.

08

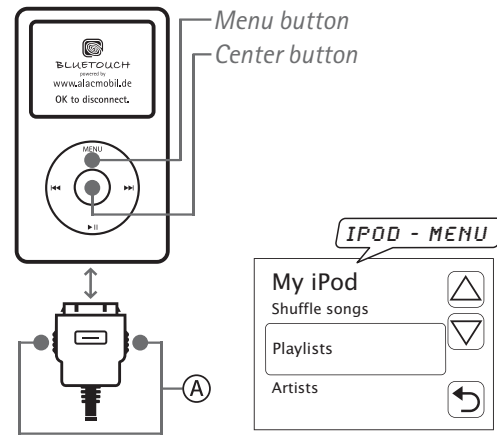

After disconnecting the iPod from the connection cable, operating errors can occur on the iPod. Simply RESET the iPod by pressing and holding the "MENU" and the "SELECTION" button at the same time until the BLUETOUCH® logo disappears and the iPod switches off.

## Speech recognition for iPod®

BLUETOUCH® offers the possibility to control the iPod® via speech recognition.

- Activate the speech recognition in the main menu. (for this, see section "speech recognition" starting from page ??).
- Now give one of the speech prompts specified on the right.

You will find further speech prompts and information on the way they function beginning on page ??.

## Speech prompts for iPod®

- IPOD HELP
- IPOD ARTISTS
- IPOD PLAYLISTS
- IPOD ALBUMS
- IPOD SONGS
- IPOD COMPOSERS
- IPOD GENRE

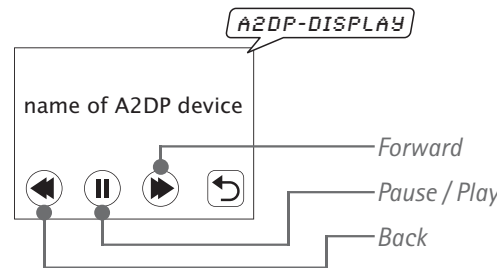

Further information concerning this function can be found in the corresponding section of the operating manual of your mobile phone.

Music playback via Bluetooth®A2DP doesn't support the title menu.

## Musik via Bluetooth® A2DP

BLUETOUCH® unterstützt die Übertragung von Musik via Bluetooth® Audiostreaming (A2DP). Falls Ihr Mobiltelefon diese Funktion unterstützt, können Sie ganz einfach die Musik von Ihrem Handy auf die Fahrzeuglautsprecher übertragen.

- Pair your phone with BLUETOUCH®.
- Activate in the music menu the Bluetooth®A2DP key.
- Press the title / playback control key and you can then operate the tracks: FORWARD, BACK, PLAY / PAUSE

## 09 Connection of audio sources (e.g. MP3 player) via 3.5 mm plug.

BLUETOUCH® offers the option to connect numerous audio sources with the included stereo audio cable.

- Connect the 3.5 mm-stereo audio cable (01) with BLUETOUCH® and your audio source.
- Activate the plug key.
- Now you can listen to your music.

The volume can be set on both your audio device and your radio. Control of the entire music operation (play, track, pause, ...) is conducted through your audio device.

With a mobile phone specific adapter cable\* (02) you can connect your music-capable mobile phone, which does not support Bluetooth®A2DP, to BLUETOUCH®.

The connection via the stereo audio cable does not support a charging function.

09

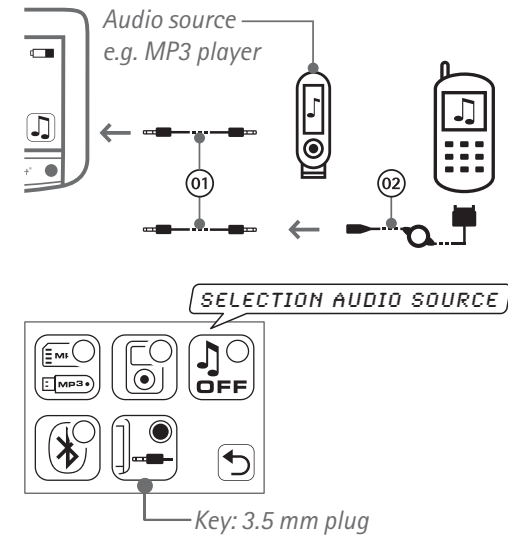

\*All available mobile phone specific adapter cables can be found on [www.bluetouch.de](http://www.bluetouch.de)

## Telephoning

After pairing your mobile phone with BLUETOUCH® (see page ??), you can accept and make calls using the hands-free system, provided that the system is switched on and the mobile phone is within range. When a call is received or you make a call, the stereo system of the vehicle automatically switches itself on mute.

### Functions during a telephone call

- Adjust the volume using + and - keys.
- End the call with the hang-up key.
- If you want to transmit key tones (e.g. mailbox), press the DTMF key and you will reach the keypad. Now enter your desired numbers or press Back if you have completed your input.
- During a call press the microphone key in order to switch the microphone off; press again in order to continue the call.
- Press the private key (1), in order to continue the conversation discreetly on your mobile phone; pressing it again allows you to speak freely again.

(1) The transfer of this function is mobile phone dependent.

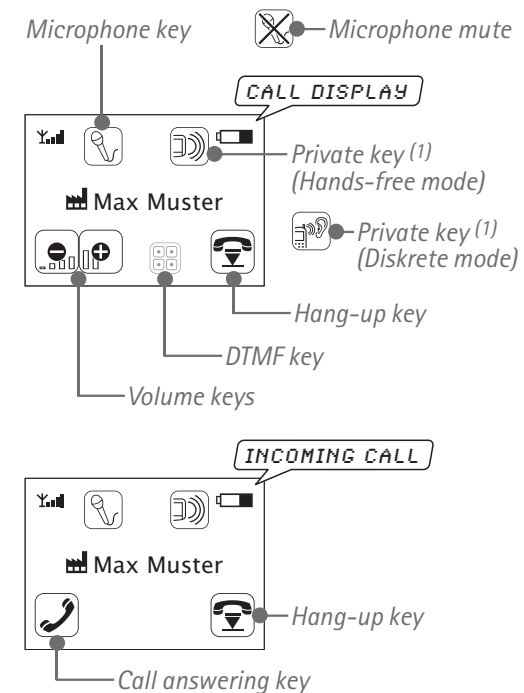

## Answering calls

Depending on the mobile phone, the name and/or the number is displayed on the touch screen.

- Press the *call answering key*.

## Making a call

- Press the *toplist key* (your most frequent contacts are calculated) and select the desired number or the dialogue partner from the list.
- Press the *directory key* to display your mobile phone book entries and select your desired contact from the list.
- Press the *call list key* to display the call lists (dialed, received, missed) and select the desired number.
- Press *re-dial*.
- Press the *keypad* and you can dial as usually. After dialing press the *call key* and the call is made.

## Voice dialing (mobile phone dependent)

- In order to use voice dialing you must first record the commands on your mobile phone (comply with the operating manual of your mobile phone).
- Hold the *directory key* (long click) and follow the instructions on the display.

## Speech recognition

BLUETOUCH® offers the possibility of controlling telephone and music functions by speech. At present, speech recognition for the German, English and French languages is available.

### Setup speech recognition

- Select the *key setup speech recognition* in the setup menu.
- You can now set the volume of the voice output and the country language.

### Activation of speech recognition

The speech recognition can be started only using the start display:

- Press onto the upper half of the touch screen and hold for a longer interval; after the beep, give the desired speech prompt. (see page ??).

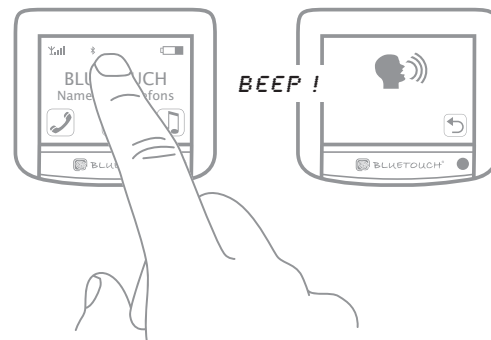
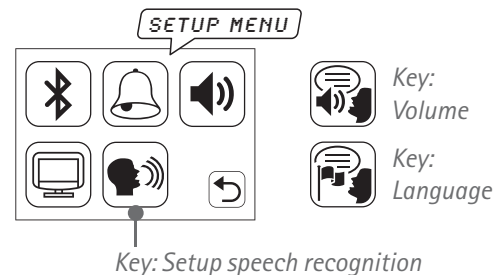
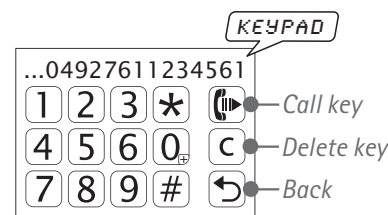
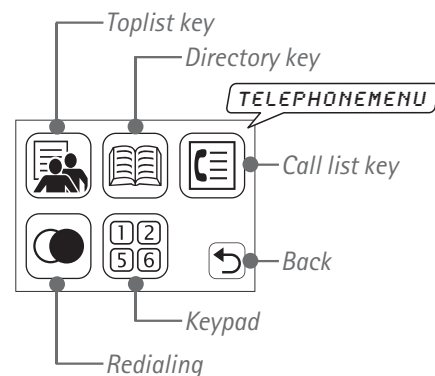

All speech prompts can be activated ONLY from the start display!!

## Speech recognition for names

In order to use the voice selection for names, you must record the speech prompts to BLUETOUCH®.

- Select your desired contact from the telephone directory.
- Press the *key speech recognition for names*, and in the following menu the speech prompt can be recorded, played and deleted.
- Follow the announced instructions.

The speech recognition for names can now be started from the start display. Use the appropriate speech prompts, as specified below:

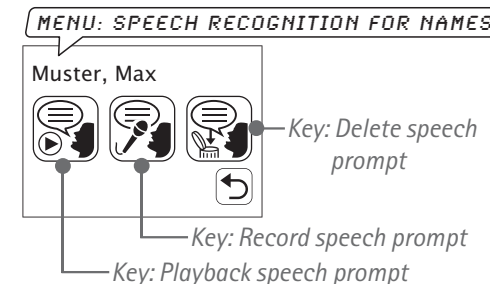
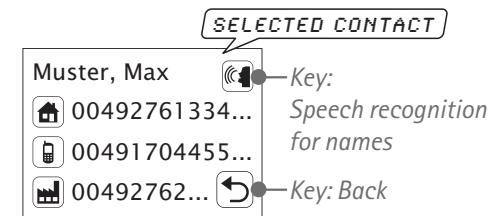

## Speech prompts for telephone

- **HELP**  
(help prompt with all possible commands)
- **TELEPHONE HELP**  
(help prompt with all possible commands for telephone handling)
- **READ PHONEBOOK or READ OUT PHONEBOOK**  
(read out phonebook if existing, report missing phonebook else)
- **DIAL NUMBER or DIAL PHONENUMBER**  
(start dialog for number entering)  
Within this dialog you can say:
  - Numbers 0 - 9 (and "PLUS" at the very beginning) (when pausing, last block will be repeated)
  - **HELP**  
(give possible commands for this dialog)
  - **DELETE or CLEAR**  
(delete number and start over number entering)
  - **CORRECT or CORRECT NUMBER**  
(delete last block, repeat last remaining block)
  - **CANCEL**  
(cancel this dialog, go back to main)
  - **READ OUT NUMBER**  
(read out complete number)
  - **DIAL NUMBER**  
(dial number)
- **CANCEL**  
(cancel current speech recognition, discarding everything you might have entered already)
- **REDIAL**

- **DIAL NAME**  
(prompt to enter name or report error if not possible. If more than one number is available for this name additional dialog for category:)
  - HOME
  - OFFICE
  - MOBILE
 plus final step whether numbered should be dialed:
  - YES
  - NO
  - CANCEL

## Speech prompts for music

- **NEXT TITLE/SONG/TRACK or NEXT**  
(play next title)
- **PREVIOUS TITLE/SONG/TRACK or BACK**  
(play previous title)
- **IPOD HELP**  
(help prompt with all possible commands for iPod®)
- **IPOD ARTISTS**
- **IPOD PLAYLISTS**
- **IPOD ALBUMS**
- **IPOD SONGS**
- **IPOD COMPOSERS**
- **IPOD GENRE**  
(go directly to this iPod® menu if possible)

## Trouble shooting and other steps

Before you consult your installation service please follow these simple checking steps. More steps and information may be found on [www.bluetouch.de](http://www.bluetouch.de)

### BLUETOUCH® cannot be paired

- The Bluetooth® function on the mobile phone must be activated.
- BLUETOUCH® must be switched on.
- No solid objects should be between the mobile phone and BLUETOUCH®.
- BLUETOUCH® is possibly paired with another mobile phone. Cut the connection to the other device (page 17).
- Possibly another hands-free system is paired with the mobile phone. Some mobile phones can only manage one hands-free system in the list of paired mobile phones. Consult the operating manual of the mobile phone.
- Clear the list of known devices in BLUETOUCH® and pair your mobile phone again.
- Clear the list of Bluetooth® devices on your mobile phone and couple again.

### Some functions of BLUETOUCH® cannot be used.

- Check the operating manual of your mobile phone to determine whether it supports the respective function or the corresponding Bluetooth® profile. A list of all mobile phones which support Bluetooth®A2DP at present can be found on [www.bluetouch.de](http://www.bluetouch.de)

### The dialogue partner hears an echo.

- Increase the distance between microphone and the vehicle loudspeakers (distance should be at least 80 cm).
- Reduce the volume of BLUETOUCH®.

### iPod cannot be accessed.

- Make sure that the iPod connection cable is attached correctly.

### No music playback via 3.5 mm plug.

- Make sure that no calls are being conducted via BLUETOUCH®.
- Check that the cables are firmly mounted.
- Switch the AUX key on.

 **Restore to factory configuration (all modifications and adjustments you have made will be lost): Go to the telephone menu and enter the following in the keypad:**

\*#000# 

12

 **Using mobile phones reception interference can occur which can impair the system performance. Therefore we recommend an additional cradle with an external antenna. This considerably improves the transmission and reception properties of the mobile phone, and your mobile phone is always fully charged.**

 **BLUETOUCH® SOFTWARE UPDATES**  
*You can easily conduct necessary software updates via the USB interface. Additional information on this can be found under: [www.bluetouch.de](http://www.bluetouch.de)*

 **Regulate the music volume as usual via your car hi-fi system.**  
*Note the volume preset (optional).*

Apple™ and iPod® are registered trademarks of Apple™ Computer, Inc.

Bluetooth® is a registered trademark of Bluetooth® SIG, Inc.

We reserve the right to make unannounced modifications of all capability characteristics and specifications.

Under no circumstances are we responsible for data loss or for any special, accompanying, indirect or direct damages, however these may have come about.

Certain components in the software used in BLUETOUCH® are subject to conditions of the GPL or LGPL license. A copy of these licenses and further information can be found on [www.bluetouch.de/gpl.html](http://www.bluetouch.de/gpl.html)

We expressly point out that in case of any type of modification to the BLUETOUCH® system, the warranty claim is voided.

BLUETOUCH® is a joint development of the companies PEIKER acustic GmbH & CO.KG and ALAC GmbH.

For further information visit the homepage [www.bluetouch.de](http://www.bluetouch.de)

### DECLARATION OF CONFORMITY

We, PEIKER acustic GmbH & CO.KG, declare fully responsibly that the product BLUETOUCH®Music complies with the terms of Guideline 94/54 EC of the Council of the European Union. You can find the complete text of the declaration of conformity under [www.bluetouch.de](http://www.bluetouch.de)



## Conformity to FCC-Rules:

13

This device contains Transmitter Module

FCC-ID: QWY-BLUETOUCH

### RF exposure:

The max sourcebased time-averaged output of 0.48 mW is below the low threshold of 24mW for  $d < 2.5$  cm. This is very low power configuration. The antenna shown in this filing can be co-located or operated in conjunction with any other antenna or transmitter. For portable applications installer need no additional testing or SAR evaluation.

### USA only:

Statement according to FCC part 15.19:

This device complies with Part 15 of the FCC Rules. Operation is subject to the following two conditions:

- (1) this device may not cause harmful interference, and
- (2) this device must accept any interference received, including interference that may cause undesired operation.

Statement according to FCC part 15.21:

Modifications to this device not expressly approved by this company could void the user's authority to operate the equipment.

Statement according to FCC part 15.105:

Note: This equipment has been tested and found to comply with the limits for a Class A digital device, pursuant to part 15 of the FCC Rules. These limits are designed to provide reasonable protection against harmful interference when the equipment is operated in a commercial environment. This equipment generates, uses, and can radiate radio frequency energy and, if not installed and used in accordance with the user manual, may cause harmful interference to radio communications. Operation of this equipment in a residential area is likely to cause harmful interference in which case the user will be required to correct the interference at his own expense.

Statement according to FCC part 15.27:

With this device will no additional special accessories be shipped or marketed. This equipment (BLUETOUCH) has to be assembled by professional installing personnel of the vehicle manufacturer. It is the responsibility of the installer to install the equipment in that way that the resulting system complies with the regulations.

### Canada only:

Statement according to RSS-210:

This device complies with RSS-210 of Industry Canada. Operation is subject to the following two conditions:

- (1) this device may not cause harmful interference, and
- (2) this device must accept any interference received, including interference that may cause undesired operation.

Modifications to this device not expressly approved by this company could void the user's authority to operate the equipment.

