

VERZO KINZO

User Manual

Revision 1.0.1
2011/03/15

Revision History

Revision	Released Date	Comments/Remark	Author
V0.1.0	02/14/2011	Draft	Nicole
V1.0.0	3/07/2011	Official release	Nicole
V1.0.1	3/15/2011	Modification	

You are cautioned that changes or modifications not expressly approved by the party responsible for compliance could void your authority to operate the equipment.

This device complies with Part 15 of the FCC Rules. Operation is subject to the following two conditions: (1) this device may not cause harmful interference and (2) this device must accept any interference received, including interference that may cause undesired operation

This equipment has been tested and found to comply with the limits for a Class B digital device, pursuant to part 15 of the FCC rules. These limits are designed to provide reasonable protection against harmful interference in a residential installation. This equipment generates, uses and can radiate radio frequency energy and, if not installed and used in accordance with the instructions, may cause harmful interference to radio communications. However, there is no guarantee that interference will not occur in a particular installation. If this equipment does cause harmful interference to radio or television reception, which can be determined by turning the equipment off and on, the user is encouraged to try to correct the interference by one or more of the following measures:

- Reorient or relocate the receiving antenna.
- Increase the separation between the equipment and receiver.
- Connect the equipment into an outlet on a circuit different from that to which the receiver is connected.
- Consult the dealer or an experienced radio/TV technician for help.

TABLE OF CONTENT

GENERAL INFORMATION	6
BATTERY CARE	6
CARE AND MAINTENANCE.....	6
IMPORTANT SAFETY INFORMATION	7
BASIC INFO	9
GETTING TO KNOW YOUR PHONE AND ACCESSORIES.....	9
<i>Your Phone</i>	<i>9</i>
<i>Inside the box.....</i>	<i>9</i>
INSTALLING THE SIM CARD, BATTERY, AND STORAGE CARD	9
<i>SIM card</i>	<i>10</i>
<i>Storage card.....</i>	<i>10</i>
<i>Battery.....</i>	<i>11</i>
CHARGING THE BATTERY.....	11
<i>Earphone jack.....</i>	<i>12</i>
PHONE CONTROLS	12
<i>Soft Key functions.....</i>	<i>12</i>
<i>Settings.....</i>	<i>12</i>
<i>Search.....</i>	<i>12</i>
GETTING AROUND YOUR PHONE	13
<i>Touch.....</i>	<i>13</i>
<i>Touch and hold.....</i>	<i>13</i>
<i>Swipe or slide.....</i>	<i>13</i>
<i>Drag.....</i>	<i>13</i>
<i>Rotate.....</i>	<i>13</i>
GETTING STARTED.....	14
TURN YOUR PHONE ON AND OFF	14
HOME SCREEN	14
<i>Extended Home screen.....</i>	<i>15</i>
<i>Customizing the Home screen.....</i>	<i>15</i>
PHONE STATUS AND NOTIFICATIONS	17
<i>Status bar</i>	<i>17</i>
<i>Notification icons</i>	<i>17</i>

<i>Status icons</i>	18
<i>Notifications panel</i>	18
SETTINGS	19
ADJUSTING THE VOLUME	19
USING THE ONSCREEN KEYBOARD	20
<i>Input method</i>	21
<i>Adjusting Android default keyboard settings</i>	21
USING PHONE FEATURES AND MANAGING CONTACTS	23
MAKING CALLS	23
ANSWERING OR REJECTING CALLS	24
USING THE CALL LOG	27
ADJUSTING PHONE SETTINGS	29
TURNING THE PHONE FUNCTION ON/OFF	29
CREATING AND MANAGING YOUR CONTACTS	29
MANAGING YOUR TIME	33
USING CLOCK	33
EXCHANGING MESSAGES	35
SENDING TEXT AND MULTIMEDIA MESSAGES	35
USING EMAIL	41
USING GMAIL	42
GETTING CONNECTED	43
CONNECTING TO THE INTERNET	43
USING WIFI	47
USING BLUETOOTH	48
ENTERTAINING THROUGH MULTIMEDIA FUNCTIONS	51
USING CAMERA AND CAMCORDER	51
USING GALLERY	53
USING MUSIC	57
MANAGING YOUR PHONE	60
CHANGING BASIC SETTINGS	60
<i>Set the date, time zone, and time</i>	60
<i>Display settings</i>	60
<i>Ringer settings</i>	61
<i>Phone services</i>	61
<i>Language settings</i>	62

SYNCHRONIZING YOUR DATA 62

PROTECTING YOUR PHONE AND PERSONAL DATA 62

MANAGING MEMORY 63

RESETTING THE PHONE 64

General information

Battery care

Your phone is powered by a rechargeable battery.

- The battery can be charged and discharged hundreds of times but it will eventually wear out. When the operating time (talk-time and standby time) is noticeably shorter than normal, you should buy a new battery at the time.
- Unplug the charger when not in use, and don't leave the battery connected to a charger for longer than a week, since overcharging may shorten its lifetime.
- Overcharging may shorten its lifetime, and if left unused a fully charged battery may discharge itself over time.
- Temperature extremes can affect the ability of your battery to charge.
- Do not use any charger or battery that is damaged in any way.
- Use the battery only for its intended purpose.
- Extreme temperatures will affect the charging capacity of your battery.
- Do not leave the battery in hot or cold places, such as in a car in summer or winter condition.
- Do not short-circuit the battery. Short-circuiting the terminals may damage the battery or the connecting object.
- Dispose of batteries according to local regulations. Always recycle. Do not dispose of batteries in a fire.

Care and Maintenance

Read this information before using your mobile phone.

Your mobile phone is a highly sophisticated electronic device. When using your phone, battery, charger or any accessory, please read this first.

Product care

- Keep your mobile phone and all its parts out of young children's reach.
- Keep your mobile phone dry.
- Avoid exposing your mobile phone to extreme hot or cold temperatures.
- Avoid placing your mobile phone close to lit cigarettes, naked flames or any heat source.
- Do not attempt to disassemble it. Non-expert handling of the device may damage it.
- Do not drop, knock or shake it. Rough handling can break internal circuit boards.
- Do not paint your mobile phone as the paint could obstruct the earphone, microphone or any moveable parts and prevent normal use.
- Treat your mobile phone with care, keep it in a clean and dust free place.
- Do not use the phone if the antenna is damaged. If a damaged antenna contacts skin, it may cause a light burn.

- Do not touch the antenna unnecessarily when the phone is switched on. Contact with the antenna affects call quality and may cause the phone to operate at a higher power level than needed and shorten talk and standby times.
- Hold the phone as you speak to any other telephone. While speaking directly into the microphone, angle the antenna in a direction up and over your shoulder. If the antenna is extendable/retractable, it should be extended during the call.

Important safety information

Radio frequency energy

Your mobile phone is a radio transmitter and receiver. When the phone is turned on, it receives and transmits radio frequency (RF) energy. Depending on the type of mobile phone you possess, it operates on different frequency ranges and employs commonly used modulation techniques. The system that handles your call when you are using your phone controls the power level at which your phone transmits.

Specific Absorption Rate (SAR) information.

Your phone has been designed to comply with applicable safety requirements for exposure to radio waves. This requirement is based on scientific organizations through periodic and thorough evaluation of scientific studies. These guidelines include safety margins designed to assure this safety of all persons, regardless of age and health.

- The radio wave exposure guidelines employ a unit of measurement known as the Specific Absorption Rate, or SAR. Tests for SAR are conducted using standardized methods with the phone transmitting at this highest certified power level in all used frequency bands.
- While there may be differences between the SAR levels of various other phone models, they are all designed to meet the relevant guidelines for exposure to radio waves.
- The SAR limit recommended by the International Commission on Non-Ionizing Radiation Protection (ICNIRP), which is 2W/kg averaged over then (10) gram of tissue.

This highest SAR value for this model phone tested by atl Lab for use at the ear is 0.754 W/Kg Head SAR and 0.683 W/Kg Body SAR.

SAR data information for residents in countries/regions that have adopted the SAR limit recommended by the Institute of Electrical and Electronics Engineers (IEEE), which is 1.6 W/kg averaged over one (1) gram of tissue.

Electronic devices

Most modern electronic equipment is shielded from RF energy. However, certain electronic equipment may not be shielded against the RF signals from your wireless phone, therefore:

- Don not use your mobile phone near medical equipment without requesting permission.

Pacemaker

Mobile phones may affect the operation of some implanted cardiac pacemakers and other medically implanted equipment. Pacemaker manufacturers recommend that a minimum separation of 20 cm (6 inches) be maintained

between a hand-held wireless phone and a pacemaker to avoid potential interference with the pacemaker. These recommendations are consistent with the independent research by and recommendations of Wireless Technology Research.

Persons with pacemakers:

- Should always keep the phone more than 20 cm (6 inches) from their pacemaker when the phone is switched on;
- Should not carry the phone in a breast pocket;
- Should use the ear opposite the pacemaker to minimize the potential for interference.
- If you have any reason to suspect that interference is taking place, switch off your phone immediately.

Hearing aids

Some hearing aids might be disturbed by mobile phones. In the event of such disturbance, you may want to consult your service provider, or call the customer services line to discuss alternatives.

Aircraft

- Turn off your mobile phone before boarding any aircraft.
- Do not use it on the ground without crew permission

To prevent interference with communication systems, you must not use your mobile phone while the plane is in the air.

Potentially explosive atmospheres

Switch off your phone when in any area with a potentially explosive atmosphere and obey all signs and instructions. It is rare, but your phone or its accessories could generate sparks. Sparks in such areas could cause an explosion or fire resulting in bodily injury or even death. Areas with a potentially explosive atmosphere are often, but not always, clearly marked. They include fuelling areas, such as petrol station, below deck on boats, fuel or chemical transfer or storage facilities, and areas where the air contains chemicals or particles, such as grain, dust, or metal powders.; and any other area where you would normally be advised to turn off your vehicle engine.

Driving

Check the laws and regulations on the use of mobile phones in the areas where you drive. If you are going to use your phone while driving, please:

- Give full attention to driving
- Use handsfree. Law in many countries requires vehicle handsfree.
- Pull off the road and park before making or answering a call if driving conditions so require.

RF energy may affect some electronic systems in motor vehicles such as car stereo, safety equipment etc. in addition, some vehicle manufacturers do not allow use of mobile phones, unless the installation is supported by a handsfree kit with an external antenna in their vehicles. Check with your vehicle manufacturer's representative to be sure that your mobile phone will not affect the electronic systems in your vehicle.

Basic Info

Getting to Know Your Phone and Accessories

Your Phone

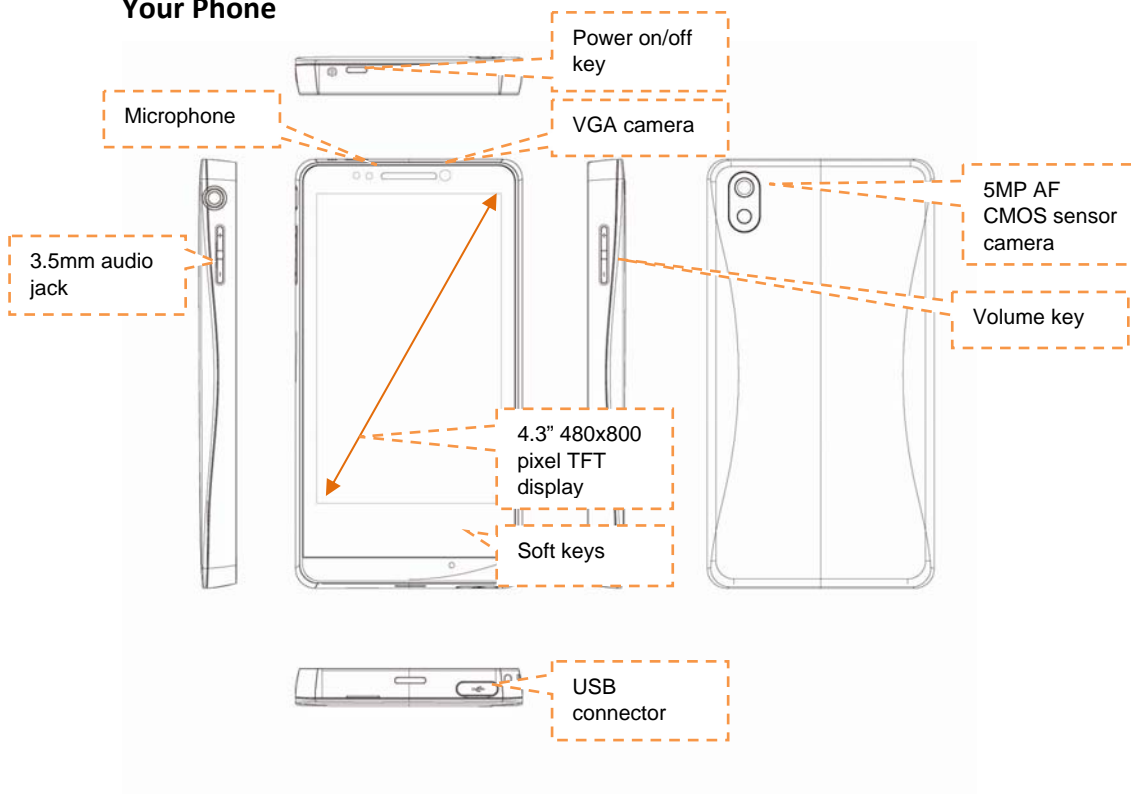

Inside the box

The product package includes the following items and accessories:

- Battery
- USB cable
- AC adapter
- Car charger
- Wired stereo headset
- microSD™ card (Optional)
- User manual

Installing the SIM Card, Battery, and Storage Card

Always turn off your phone before installing or replacing the SIM card, battery, and storage card. You also need to remove the back cover before you can install the SIM card and battery.

To remove the back cover

1. Make sure the phone is turned off.
2. Firmly hold the phone with both hands and the front panel facing down.
3. Use the fingernail to push the back cover latch down and open the cover by thumb nail.

SIM card

The SIM card contains your phone number, service details, and phone book/message memory. Your phone supports both 1.8V and 3V SIM cards.

Note Some legacy SIM cards may not function with your phone. You should consult your service provider for a replacement SIM card. There may be fees for this service.

To install the SIM card

1. Make sure the phone is turned off
2. Insert the SIM card with its gold contacts facing down
3. Slide the SIM card completely into the slot

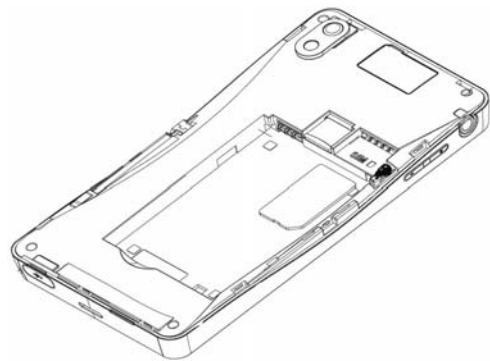

To remove the SIM card

1. Make sure the phone is turned off
2. Push the SIM card out of the slot with your fingernail.

Storage card

To store your pictures, music, and applications, must install the supplied microSD card into your phone. This phone can support up to 32GB microSD card.

To install the storage card

1. Make sure the phone is turned off.
2. Insert the microSD card into the slot with its gold contacts facing down.

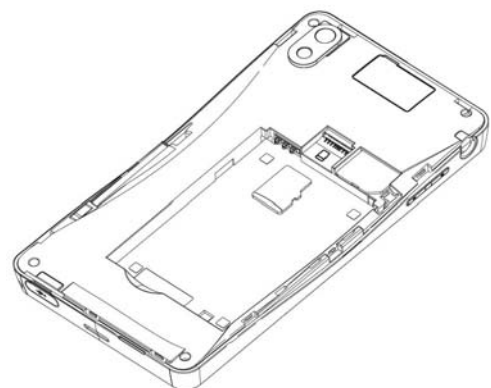

To remove the storage card

1. Make sure the phone is turned off or unmount the microSD card from **Settings>SD card & phone storage>Unmout SD card**
2. Push the microSD card to eject it from the slot with your fingernail.

Note If you want to remove the storage card while the phone is on, see “To safely remove the storage card while the phone is on” on page xx.

Battery

Your phone comes with a rechargeable Lithium-ion battery and is designed to use only manufacturer-specified original batteries and accessories. Battery performance depends on many factors, including network configuration, signal strength, the temperature of the environment in which you operate your phone, the features and/or settings you select and use, items attached to connecting ports, and your voice, data, and other program usage patterns.

Battery life estimates (approximations): Talk time:

- Up to 3 hours for WCDMA
- Up to 6 hours for GSM

Standby time:

- Up to 168 hours for WCDMA
- Up to 168 hours for GSM

Note Battery life is subject to network and phone usage.

Warning ! To reduce risk of fire or burns:

- Do not attempt to open, disassemble, or service the battery pack.
- Do not crush, puncture, short external contacts, or dispose of in fire or water.
- Do not expose to temperatures above 60°C (140°F).
- Replace only with the battery pack designated for this product.
- Recycle or dispose of used battery as stipulated by local regulations.

To install the battery

1. Align the battery's exposed copper contacts with the battery connectors
2. Insert the contact side of the battery first then gently push the battery into place.
3. Replace the back cover.

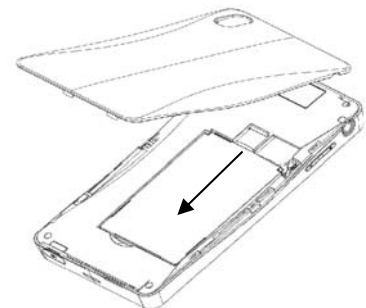

To remove the battery

1. Make sure the phone is turned off.
2. Remove the back cover.
3. The top side of battery has a half round sharp hold. Pushing down the battery from the hold to remove it by thumb nail.

Charging the Battery

New batteries are not charged when shipped. Before start using your phone, please charge the battery for eight hours at least.

To charge the battery

1. Plug the USB connector of the AC adapter to the USB connector at the bottom of your phone.

2. Plug in the AC adapter to an electrical outlet to start charging the battery.

Note You can also charge your phone via USB cable as well.

As the battery is being charged while the phone is on, the charging battery icon  is displayed in the status bar of the Home screen.

After the battery has been fully charged, a full battery icon  displays in the status bar of the Home screen.

Warning:

- Do not remove the battery from the phone while you are charging it using the AC or car adapter.
- As a safety precaution, the battery stops charging when it overheats.

Earphone jack

To listen to music and video, you might use the embedded earphone to listen privately or you can use your own headset.

To insert headset

Insert the headset into the audio jack carefully on the left side of your phone beside the SIM card and memory card slot.

Phone Controls

Soft Key functions

Touch the control keys on the front panel of your phone to do the following:

<i>Key</i>	<i>Function</i>
HOME	<ul style="list-style-type: none"> • While on any application or screen, touch to return the main Home screen • Touch and hold to open the recent-used applications window
MENU	<ul style="list-style-type: none"> • Touch to open a list of options you can do on the current screen or selection
BACK	<ul style="list-style-type: none"> • Touch to go back to the previous screen, or to close a dialog box, options menu, or close the Notifications panels. • Touch and hold to return to the main screen of the current application • When the onscreen keyboard is open, touch to close the onscreen keyboard
SEARCH	<ul style="list-style-type: none"> • When the onscreen keyboard is open,

Settings

- Press **HOME**, then open the Applications tab, and then touch **Settings**.

Search

Press **Search** bar while in the Home screen or Browser to launch Google Search™ and search information on the web. Or, press **Menu** and select **Browser** to launch Google Search™ and search information from the web

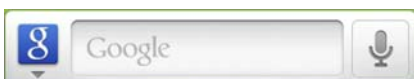

Getting Around Your Phone

There are different ways to navigate around the Home screen, menus and application screens on your phone. You can also change the screen orientation of the phone.

Touch

When you want to type using the onscreen keyboard, select items onscreen such as application and settings icons and touch them with your finger.

Touch and hold

To open the available options for an item (for example, contact or link in a webpage), simply touch and hold the item.

Swipe or slide

To swipe or slide means to quickly drag your finger vertically or horizontally across the screen.

Drag

Touch and hold your finger with some pressure before you start to drag. While dragging, do not release your finger until you have reached the target position.

Rotate

For most screens, you can automatically change the screen orientation from portrait to landscape by turning the phone sideways. When entering text, you can turn the phone sideways to bring up a bigger keyboard.

Getting Started

Once you've installed your SIM card, battery, and microSD card, you can turn on your phone and start using it.

Turn your phone on and off

To turn on the phone

Press the **POWER** key.

To turn off the phone

- 1 Press and hold the **POWER** key until the options menu opens.
- 2 On the options menu, touch **Power off**.
- 3 Touch **OK** when prompted to turn off the phone.

Enter PIN

If your SIM card is preset with a PIN (personal identification number), you will be prompted to enter the PIN before you can use the phone. Enter the SIM PIN, then touch **OK**.

Important If you entered the wrong PIN three times, the SIM card will be blocked and you will not be able to use your phone. If this happens, you can unblock it with the PUK (PIN Unblocking Key) obtained from your service provider.

Set up your phone for the first time

When you turn on the phone for the first time, you will be prompted to enter your SIM card password and request to sign-in your Google account if any. Please follow the instruction showed on the phone.

Important Usually, the default SIM password is 0000 and you may change the password from Phone setting.

Turn off the screen when not in use

To save battery power, the phone automatically turns off the screen when you leave it idle after a certain period of time. You will still be able to receive messages and calls while the phone's screen is off.

You can also turn off the screen by short pressing the **POWER** key. Pressing the **POWER** key again or incoming calls will turn on your phone screen.

Home Screen

The Home screen is your starting point for using the applications on your phone. You can customize the Home screen to display application icons, shortcuts, folders, and widgets.

To setup the home screen

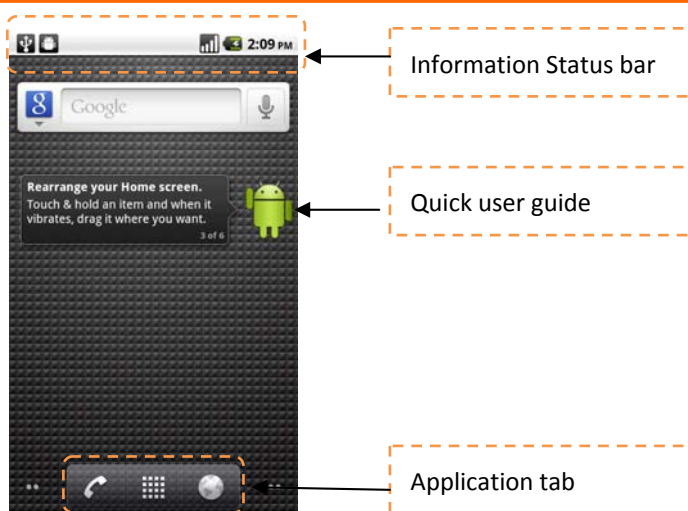

Extended Home screen

The Home screen extends beyond the screen width to provide more space for adding icons, widgets, and more. Slide your finger horizontally across the screen to go to the left or right side of the extended Home screen, then press Home key to back the main screen.

Main Home Screen

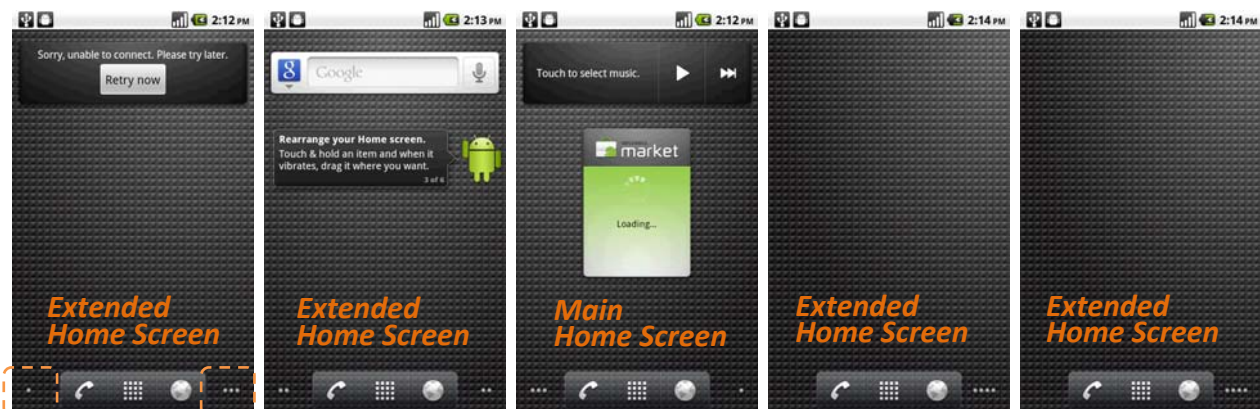

To quick switch to certain home screen extend

1. Touch and hold the icons showed beside **Browser** or **Phone**
2. Screen pop-up the small quick view of each extended home screen
3. Select the one you would like to jump to

Customizing the Home screen

To add a Home screen item

1. Press **HOME**, then touch and hold an empty area on the screen.
2. When the Add to Home options menu opens, select the item you want to add to the Home screen:
 - **Shortcuts.** Add shortcuts such as applications, a bookmarked web page, a favourite contact, a eMail label, a music playlist or FM playlist.

Tip To quickly add an application shortcut that is on the Applications tab to the Home screen, touch and hold an application icon. When the phone vibrates, release the icon on an empty area on the Home screen.

- **Widgets.** Add a wireless manger, profile mode, clock, Facebook, Weather, music player, FM player, a picture frame, the Google Search bar, power control, or a calendar that shows upcoming appointments.
- **Folders.** Add a folder where you can organize Home screen items, a shortcut to all your contacts, contacts with phone numbers, or starred contacts. Add a shortcut to all your contacts, contacts with phone numbers, or starred contacts. Contact details are automatically updated when there are changes in the source.
- **Wallpapers.** Change the Home screen wallpaper.



To reposition a Home screen item

1. Touch and hold the item on the screen you want to reposition to activate Move mode.

Note When Move mode is activated, the item magnifies and the phone vibrates.

2. Without lifting your finger, drag the icon to the desired position on the screen, then release it.

Note To move an item from the Home screen to an extended Home screen, touch and hold the item and then drag it to the left or right edge of the screen until the display shifts to the extended Home screen. Position the item on the screen, then release it.

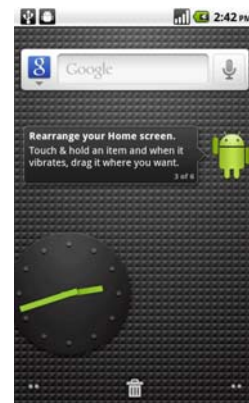

To remove a Home screen item

1. Touch and hold the item on the screen you want to remove to activate Move mode.

Note When Move mode is activated, the item magnifies and the phone vibrates.

2. Drag the icon to the Applications tab (the Application tab will changes to )



To change the Home screen wallpaper

1. While on the Home screen, touch and hold an empty area on the screen and select **Wallpaper**.
2. Touch **Gallery**, **Live wallpapers** or **Wallpaper**.
 - Touch **Gallery** to use a picture that you have captured using the camera or copied to your phone as a wallpaper. You can crop the picture before setting it as a wallpaper.
 - Touch **Live wallpapers** or **Wallpaper** to use preset wallpapers that came with the phone.

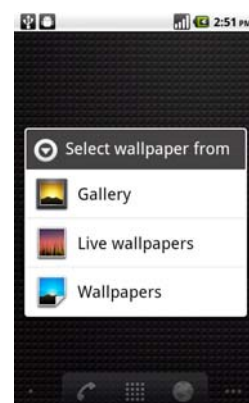

3. Touch **Save** or **Set wallpaper**.

To create a folder and add items to it

You can create folders on the home screen to hold application icons or shortcuts.

1. Press **MENU** in the home screen, and then touch **Add > Folders**. A new folder appears on the screen.
2. Select the folder and drag and pull the applications on the desktop into the folder.

To access the items inside a folder, touch the folder to open it and then touch the icon of the application or shortcut you want to open.

Tip To delete a folder, follow the same procedure when you want to remove a Home screen item.

To rename a folder

1. Touch the folder to open it.
2. Touch and hold the folder's title bar to open the Rename folder dialog box.
3. Enter the Folder name and then touch **OK**.

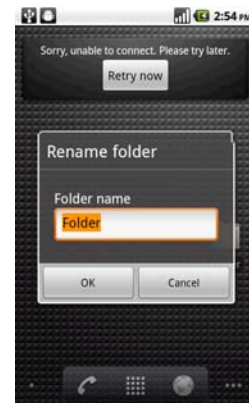

Phone Status and Notifications

Status bar

On top of the phone screen is the status bar. The left side of the status bar displays notification icons while the right side of the status bar displays the phone status.

The bar can be pull down to indicate information, including call log, messages info, ongoing event or notifications. To go back, press **BACK** key to return the home screen.



















Tip When the status bar is full, touch  to display hidden icons/notifications

Notification icons

These are the icons that may appear on the notifications area of the status bar:



Icons showed in the boxed area

	New email message		More (not displayed) notification
	New SMS/MMS		Call in progress
	Problem with SMS/MMS delivery		Missed call
	New instant message		Call on hold
	New voicemail		Call forwarding on
	Upcoming event		Uploading data
	Song is playing		Downloading data
	Problem with sign-in/sync		Content downloaded
	Storage card is full		Phone connected to computer via USB cable
	Wi-Fi is on and wireless networks are available		

Status icons

These are the icons that may appear on the status area of the status bar:

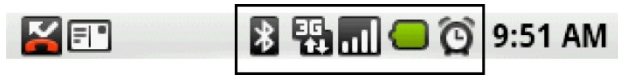

Icons showed in the boxed area

	GPRS connected		Roaming
	GPRS in use		No signal
	EDGE connected		No SIM card installed
	EDGE in use		Vibrate mode
	3G connected		Phone speaker is mute
	3G in use		Phone microphone is mute
	Connected to a Wi-Fi network		Battery is very low
	Bluetooth is on		Battery is low
	Connected to another Bluetooth device		Battery is full
	Airplane mode		Battery is charging
	Alarm is set		GPS is on
	Signal strength		GPS is connected
	Speakerphone on		Data is syncing

Notifications panel

Notification icons report the arrival of new messages, calendar events, alarms set and ongoing settings such as when call forwarding is on or the current call status. You can open the Notifications panel to open the message, reminder, or event notification and see the service provider name.

To open the Notifications panel

When a new notification icon displays in the status bar, touch and hold the status bar, then slide your finger downward to open the Notifications panel.

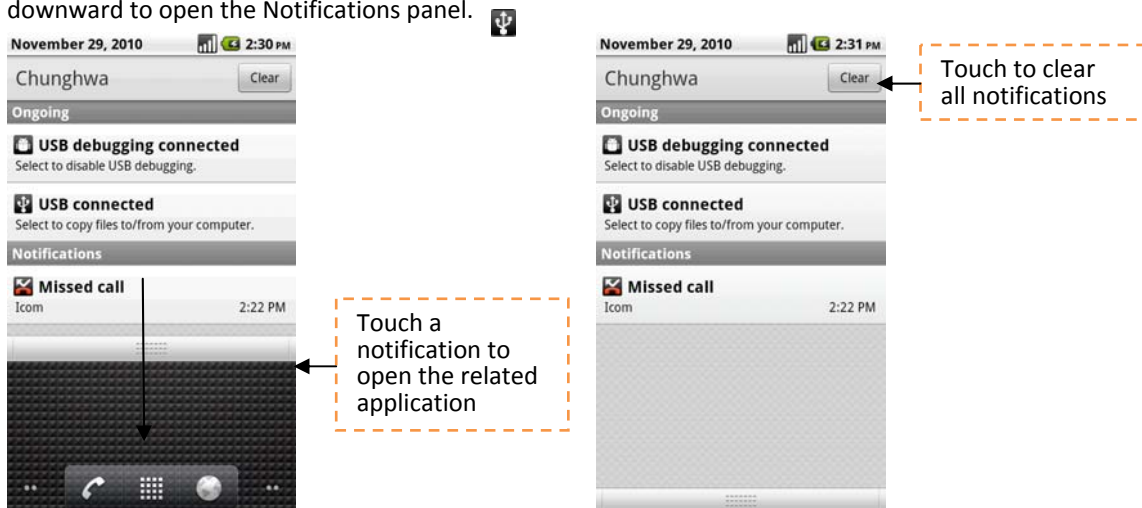

If you have several notifications, you can scroll down the screen to view more notifications.

You can also open the Notifications panel on the Home screen by pressing MENU and then touching Notifications.

To close the Notifications Panel

Touch and hold the bottom bar of the Notifications panel, then slide your finger up the screen or press BACK.

Settings

Control and customize phone settings on the Settings screen.

To open the Settings screen, do one of the following:

- Press **HOME**, then press **MENU**, and then touch **Settings**.
- Press **HOME**, then open the Applications tab, and then touch **Settings**.

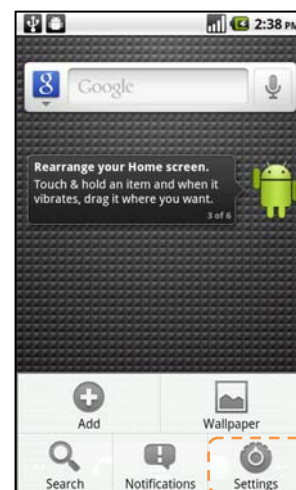

Wireless & networks	Configure your phone's wireless connections, such as Wi-Fi and Bluetooth, enable the Airplane mode, or set the options for roaming, networks, and more.
Call settings	Set up call services such as voicemail, call forwarding, call waiting, and caller ID.
Sound	Set the call and notification ring tones
Display	Set the screen brightness and screen timeout.
Location & security	Select the GPS location source to use, set the screen unlock pattern, or enable the SIM card lock.
Applications	Manage applications and installation of new programs
Accounts & sync	To sync your data with Google services.
SD card & phone storage	Check the available storage card and phone memory, reset the phone to its factory default settings, or format the SD card.
Language & keyboard	Set the operating system language and region. You can also set onscreen keyboard options.
Voice input & output	Set the speech synthesizer controls and default settings. Before using this feature, you are also requested to sign-up your Google account if any. This phone support only English.
Accessibility	
Date & time	Set the date, time, time zone, and date or time format.
About phone	View the phone status such as the network type, signal strength, battery power level, and network name. You can also view the legal information and software version of your phone.

Adjusting the Volume

Adjusting the Ringer volume changes the volume level of the phone ring tone, whereas adjusting the Media volume changes the volume level of sound notifications and music or video playback. The ringer volume and media volume can be separately adjusted.

To adjust the Ringer volume

1. You can adjust the Ringer volume from **MENU>Settings>Sound** menu.
2. Touch the Ringer volume and move the volume scroll bar to adjust the ringer volume
3. If you want to put the ringer on silent mode, touch the silent mode check box.

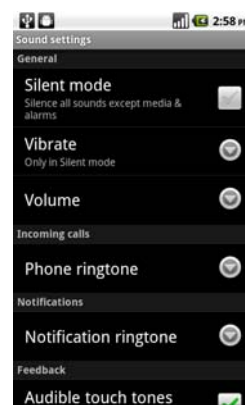



Tip To quickly switch your phone to silent mode, press and hold the **POWER** key, then touch **Silent mode** on the options menu.

You can also adjust the ringer volume through volume keys which located in your left hand side.

To adjust the media volume

When playing music or watching video, touch the volume scroll bar to adjust the media volume or press volume keys directly to adjust. The Music/video volume window appears on the screen to display the volume level.

You can also adjust the media volume on the Settings screen.

1. Press **HOME**, then press **MENU**, and then touch **Settings**.
2. Touch **Sound >Volume**.
3. When the Media volume window appears, move the slider to the left (to lower the volume) or to the right (to increase the volume).
4. Touch **OK** to close the window.

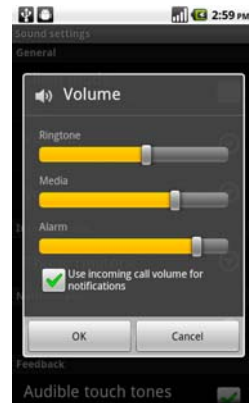

Using the Onscreen Keyboard

When you start a program or select a field that requires text or numbers, the onscreen keyboard becomes available.



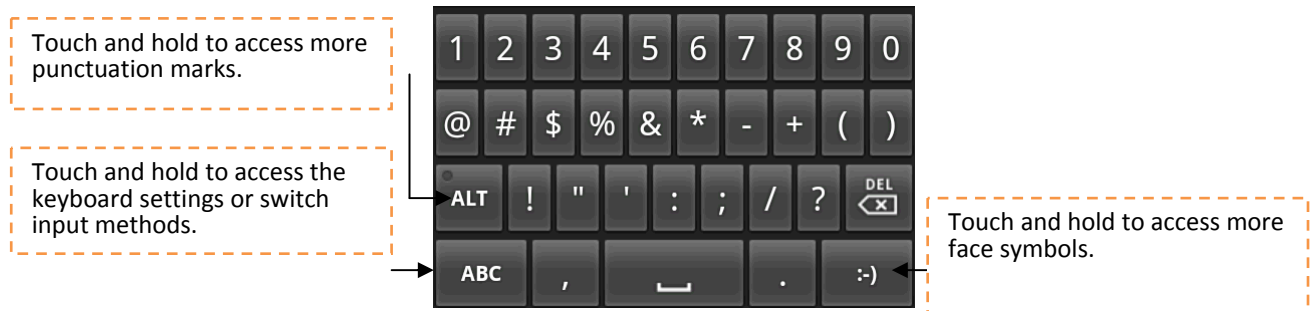

Tips

- When you do not need the keyboard, you can close it by pressing **BACK**. To show the keyboard again, touch a text box onscreen.
- If you need to insert or delete a character, use the finger to position the cursor next to the character you want to edit.

Note The available keys on the keyboard will be different depending on the current text field selected. For example, in Browser, when you are in the URL field, some keys at the bottom row are replaced with alternate keys (for example, .com key) to make it faster for you to type web addresses.

Input method

This phone is designed to support default Android input method and Guobi input method. You may switch either input method by touching and holding the text area and select "Input Method" to choose your favor input method. Guobi input method supports visual keypad & handwriting of your languages.

Adjusting Android default keyboard settings

Set onscreen keyboard options such as vibrate and/or emit a sound when you touch a key, auto-capitalization, auto-complete, and more.

To set onscreen keyboard options

1. Press **HOME**, then press **MENU**, and then touch **Settings > Language & keyboard**.
2. Set the options you want to use for the onscreen keyboard.

Tip If you select the **Quick fixes, Show suggestions, and Auto -complete** options, the phone offers you smart word suggestions as you type, so you can enter text more quickly and accurately on the onscreen keyboard

Using the landscape onscreen keyboard

When entering text, you can choose to use the landscape orientation of the onscreen keyboard, by turning the phone sideways, to use a larger keyboard that lets you type easily using two thumbs.

Note The **Orientation** check box in **HOME > MENU > Settings > Display** needs to be selected for the screen orientation to automatically change.

Entering numbers and symbols

Switch to the numeric and symbol onscreen keyboard to let you enter numbers and common symbols such as parentheses, braces, currency signs, punctuation marks, special characters, and more.

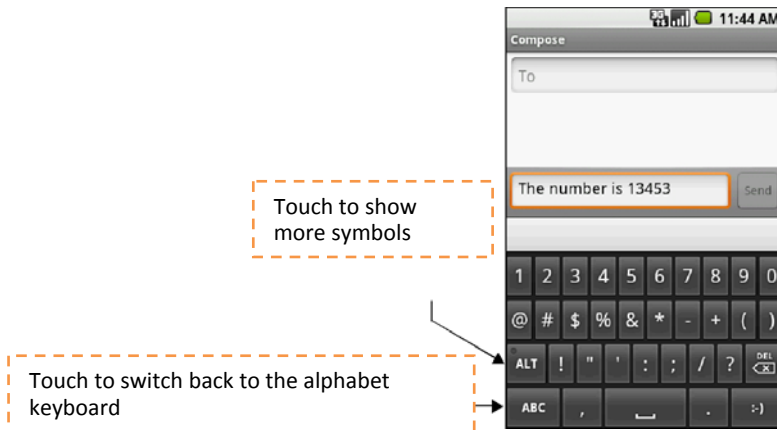

To set the phone's storage card as a USB drive

1. Connect the phone to the computer using the USB cable. A notification icon appears in the status bar.
2. Then, PC and phone will be auto connected.

Note You will not be able to use some of the phone's applications such as Camera. You need to turn off USB storage for the phone to recognize the storage card when the phone is connected to a computer.

To turn off USB storage

1. Open the Notifications Panel. In the Notifications Panel, touch **Turn off USB storage** and then touch **Turn Off**.

To safely remove the storage card while the phone is on

When you need to remove the storage card while the phone is on, you must unmount the storage card first to prevent corrupting or damaging the storage card.

1. Press **HOME**, then press **MENU**, and then touch **Settings**.
2. Scroll down the screen, then touch **SD card & phone storage**.
3. Touch **Unmount SD card**.

To format the SD card

1. Press **HOME**, then press **MENU**, and then touch **Settings**.
2. Scroll down the screen, then touch **SD card & phone storage**.
3. Touch **Unmount SD card**. This enables the **Format SD card** option.
4. Touch **Format SD card** to erase the SD card.

Using Phone Features and Managing Contacts

Making Calls



Use the Dialer to enter and call a phone number.

To open the Dialer

- On the Home screen, touch **Phone** key
- On the Home screen, touch the Applications tab, then touch **Phone** icon.

To make a call on the Dialer

1. Touch the numeric keys on the dialer to enter the phone number.

Tips If you touch a wrong number, touch  to erase digits one by one. To erase the entire number, touch  and hold

2. Touch the  to make a call

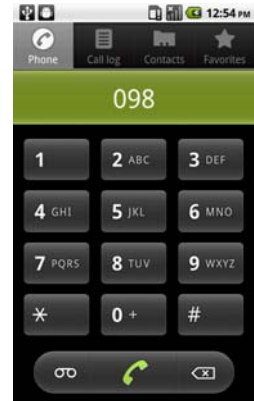

Tip During a call, press the volume keys to adjust the in-call volume.

To make an emergency call

On the **Dialer** tab, enter the international emergency number for your locale (for example, 000), and then press the  on your phone.

Notes

- When the screen is locked, you need to unlock it first before you can make an emergency call. If your phone is in sleep mode, press the power key to wake up the phone and then press the **MENU** key to unlock the screen.
- Additional emergency numbers may be included in your SIM card. Contact your service provider for details.

To make an international call

1. Touch and hold the number 0 key on the **Dialer** tab until the plus (+) sign appears. The plus (+) sign replaces the international prefix of the country that you are calling from.
2. Enter the full phone number that you want to dial, and then touch the phone number area. The full phone number includes the country code, area code (without the leading zero, if any), and phone number.

Make a call from the Call log

While on any application screen, press the **Home** key and touch **Dialer** to directly access the **Call log** tab. You can then touch a missed call, dialed number, or received call that you want to call back.

For more information about the **Call log** tab, refer to [“Using the Call Log” on page xx.](#)

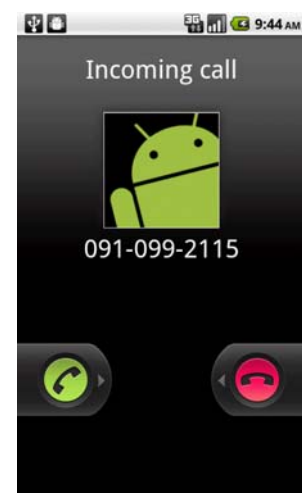

Add and call your contacts

Add the phone numbers of your contacts so you can call them more easily.

1. While on any application screen, press the **Home** key, touch **Phone k key** and then touch the **Contacts** tab. **“Creating and Managing Your Contacts”** on page xx0 describes how to add contacts to this tab.
2. Do one of the following:
 - Touch a contact to access the contact details. Then touch the number you want to call.
 - Touch and hold the contact you want to call and then from the options menu, touch **Call Mobile**, **Call Work**, or **Call Home**.

Add and call favorite contacts

To quickly find and call contacts who you most frequently communicate with, you can add them in the **Favorites** tab.

1. While on any application screen, press the **Home** key, touch the **Dialer** and then touch the **Favorites** tab.
2. You need to have at least one favorite contact to make a call from this tab. See **“Add and call favourite contacts”** on page xx for the instructions.
3. Do one of the following:
 - Touch a **favorite** contact to access the contact details. Navigate to the Dial number section, then touch a phone number that you want to call.
 - Touch and hold the **favorite** contact you want to call and then from the options menu, touch **Call Mobile**, **Call Work**, or **Call Home** to make the call.

Call voicemail

The voicemail icon  appears in the status bar when you have a new voicemail.

To call voicemail

1. Touch and hold the status bar, then slide your finger downward on the screen to open the Notifications panel.
2. Touch **New voicemail** to listen to your voicemail.

To use the Dialer to call voicemail

1. Press the **Home** key, then touch the **Dialer** icon.
2. Touch and hold the number 1 key .



Note If you have not set up your voicemail number, a missing voicemail number error message appears on the screen when you touch and hold the number 1 key. For more information on how to set up your voicemail number, refer to **“Adjusting Phone Settings”** on page xx.

Answering or Rejecting Calls

Answering or Rejecting Calls

When you receive a phone call from someone in Contacts, the Incoming call screen appears and displays the caller's caller ID icon, name, and phone number. When you receive a call from someone who is not stored in Contacts, only the default caller ID icon and phone number appear.

To answer or reject a call

- Press  key to answer the call.
- Press  key to reject the call and redirect the caller to your voice mail.



Call Options

When a call is in progress, press **MENU** to open the call options. Touch a key to put a call on hold, dial another contact for a phone conference, mute the phone microphone, and more.



Note When the phone is dialing, only the **End call** and **Speaker** keys are enabled.

To hold the call

1. Press **MENU**, then touch  to hold the call.
2. Touch this key again to resume the call. When you hold the call, the Hold  callicon appears in the status bar.

To mute the microphone during a call

1. Press **MENU**, then touch **Mute** to turn the microphone on or off.
2. When the microphone is turned off, the **Mute** key indicator lights up green and the mute icon  appears in the status bar.

Note If you are using the wired headset in a call, you can press the key on the wired headset to mute the microphone. Press the key again to unmute the microphone.

To turn the speakerphone on or off

1. Press **MENU**, and then touch **Speaker** to turn the speakerphone on or off during a call.

2. The Speaker key indicator lights up green and the  speakerphone icon appears in the status bar when the speakerphone is on.

Warning! To avoid damage to your hearing, do not hold your phone against your ear when the speakerphone is turned on.



To transfer the call to a Bluetooth headset

When a Bluetooth headset is paired and connected to your phone, you can receive all incoming calls on the Bluetooth headset for hands-free conversation.

Tip Press **MENU**, then touch **Bluetooth** to toggle between the phone speaker and the paired Bluetooth phone.

Note For more information on how to connect a Bluetooth headset or a Bluetooth car kit to your phone, refer to "Using Bluetooth" on page xx.

When the Bluetooth headset is disconnected from your phone, do the following to reconnect it and transfer the current call:

1. Make sure that Bluetooth on your phone and the Bluetooth headset are on. Refer to "Using Bluetooth" on page xx for details.
2. During a call, press **HOME** > **MENU**, then touch **Settings**.
3. Touch **Wireless & network settings** > **Bluetooth settings**.
4. In the **Bluetooth devices** section, touch and hold the name of the Bluetooth headset that you have previously paired and connected to your phone, then touch **Connect** on the options menu. **When connected**, the Bluetooth connected icon  appears in the status bar. The call is automatically transferred to the Bluetooth headset.
5. Press the  key to display the current call screen.
6. To transfer the call back to your phone, on the ongoing call screen, press **MENU**, then touch **Bluetooth**.

To end a call

When a call is in progress, you can do one of the following to hang up:

1. Press  key to end call.
2. If you are using the provided wired headset, press and hold the key to end the call. (Don't know if we have this)

Manage multiple calls

Your phone notifies you when you have another incoming call, and gives you the option of rejecting or accepting the call. If you are already on a call and accept the new call, you can choose to swap between the two callers.

- Slide the **Caller Contact Tab** up to take the second call, and put the first call on hold. You can also press **MENU** and then touch **Hold call** in progress & answer.

- To end the second call and return to the first call, press the **Menu** key and then touch **End call** on your phone.
- To end the first call and take the incoming call, press **MENU**, then touch **End call in progress & answer**.
- To swap between two calls, press **MENU** and then touch **Swap calls**.



Set up a conference call

You can set up a conference call with as many as six participants, including yourself.

Note Not all mobile phone networks support conference calling. Contact your service provider for details.

1. Make a call to the first conference call participant. See "Making Calls" on page xx for details.
2. When connected to the first participant, touch **Add call**.
3. Enter the phone number of the person you want to add to the conference call and touch the number area. Or touch the **Call log**, **Contacts**, or **Favorites** tab and then select the next conference call participant from the list.
4. The first call is automatically put on hold.
5. When connected to the second conference call participant, then touch **Merge calls** to begin the conference call.
6. To add more conference call participants, repeat steps 2 and 3.



7. During a conference call, touch **Manage**  icon showed in the center conference to manage conference call.
8. To end the conference call and disconnect all callers, press End  key to disconnect calls.

Touch this screen to drop this participant from this conference

Touch to rejoin the remaining conference call participants.

Touch this icon to talk privately to the participant and put other participants on hold.

To resume conference, press MENU and touch Merge Calls

Using the Call Log

The **Call log** tab lists all missed calls,  dialed numbers , and received calls 

To use the Call log tab

1. Press the **Home** key, touch the **Dialer** tab, and then touch the **Call log** tab.

2. Do one of the following:
3. Touch a name or number in the list to open a screen that gives you options on what you can do with the contact.
4. Touch and hold a name or number in the list to display the options menu where you can call the contact, view the contact information (if the number is stored in your contacts list), edit the number before you redial, and more.

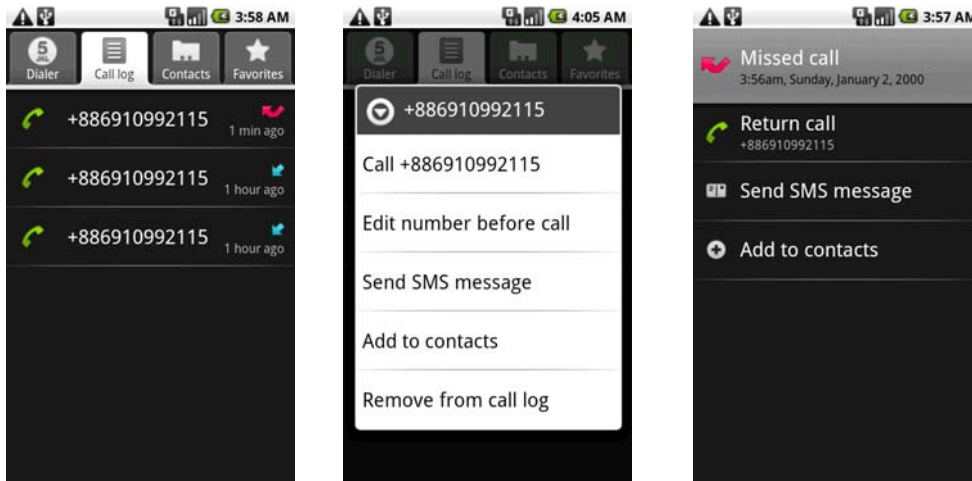

To add a new phone number to Contacts

If the phone number of a person who called is not in your contacts list, you can choose to save the number after you hang up.

1. Press the **Home** key, touch the **Dialer** tab, and then touch the **Call log** tab.
2. Touch and hold the received call that you want to save to your contacts list. Then touch **Add to contacts**.
3. When the Contacts screen appears, touch **Create new contact**. The received call number is automatically added to the **Mobile** phone field in the **Phone numbers** section.
4. Enter other information for the contact, if desired.
5. Scroll down the screen, then touch **Done**.

Note For more information about creating contacts, refer to ["Add a new contact" on page xx](#).

To check a missed call

You will see the missed call icon  in the status bar when you missed a call. To check who the caller was, press the **Home** key, touch the **Dialer** tab, and then touch the **Call log** tab.

Tip You can also touch and hold the status bar, then slide your finger downward on the screen to open the Notifications panel. The missed call number and/or contact name is displayed.

To clear the Call log

Do one of the following when viewing the **Call log**:

- To remove a name or number, touch and hold on the name or number, then touch **Remove from call log**.
- To clear the entire Call log, press **MENU** then touch **Clear call log**.

Adjusting Phone Settings

You can adjust the phone settings of your phone such as your voicemail number, or enable additional call services from your service provider.

To open the **Call settings** screen, press **HOME > MENU**, then touch **Settings > Call settings**.

Options	Description
Fixed Dialing Numbers	Restrict outgoing calls to a fixed set of numbers. To enable this feature you must know your SIM card's PIN2 code. If this feature is supported, obtain your PIN2 code from your service provider.
Voicemail service	Specify the service provider's name
Voicemail settings	Specify another voicemail number aside from the voicemail number on your SIM card
Call forwarding	Select how you want your phone to handle busy, unanswered, and unreachable calls. You can also set the call forwarding option for all incoming calls
Additional call settings	Enable or disable caller ID and call waiting services

Turning the Phone Function On/Off

In many countries, you are required by law to turn off the phone while on board an aircraft. A way to turn off the phone function is to switch your phone to **Airplane mode**. In Airplane mode, all wireless radios on your phone are turned off, including the phone function, Bluetooth, and Wi-Fi.

To enable or disable Airplane mode

1. Long press the power key, quick switch to **Airplane mode**.
2. Or Press **HOME**, then press **MENU**, and then touch **Settings > Wireless & networks**.
3. Touch **Airplane mode** to enable or disable it. When enabled, the Airplane mode icon is displayed in the status bar.

Tip When you disable Airplane Mode, the phone function is turned back on and the previous state of Bluetooth and Wi-Fi is restored.

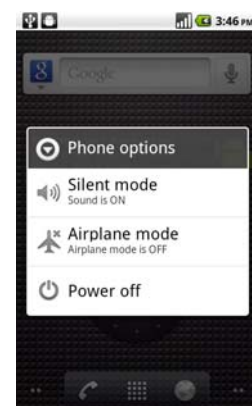

Creating and Managing Your Contacts

Contacts application gives you quick and easy access to the people you want to reach. You can view and create contacts on your phone.

To view your Contacts list

- Press **HOME**, touch  and then touch **Contacts**.

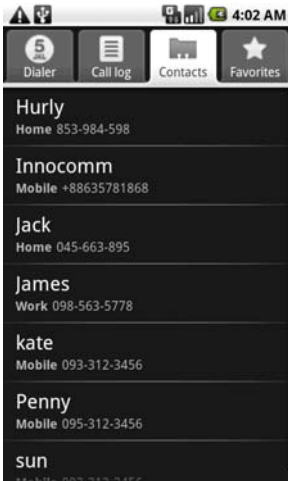

Touch a contact and hold to open the contact info

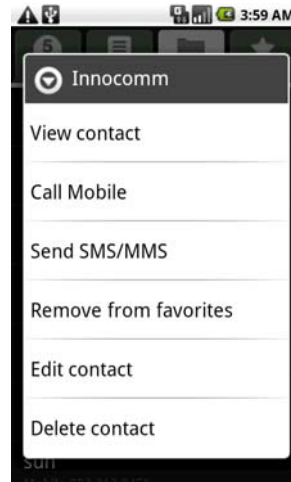

Tip When you reply to or forward an email message to an email address that is not in Contacts, the email address is automatically added to your contacts list.

Add a new contact

To add a new contact

1. In the contacts list, press **MENU**, then touch **New contact**.
2. Enter the contact's name and other contact information such as their mobile phone number, home phone number, or email address. Slide your finger up or down to see more labels.

Note To change a default information label, for example Home email to Work email, touch the information label key, then select another label on the menu. You can also touch **Custom** on the menu to create another information label that is not in the list.

Note If you want all calls from this contact to go directly to your voicemail, select the **Incoming calls** check box.

3. When finished, press **MENU** and then touch **Done**.

To import contacts from the SIM card & SD card



You can add contacts saved on your SIM card to your phone's contacts list.

1. In the contacts list, press **MENU**, then touch **Import/Export contacts**.
2. You might select from SIM card or SD card.

To backup or sync contacts

You can backup contacts in the SD card and cloud by doing one of following.

1. In the contacts list, press **MENU**, then touch **Import/Export contacts** to export contacts and saved on SD card
2. Or, touch **Accounts** from **Account** to sync your contacts with your Google account by selecting **Auto-sync**.

Add favorite contacts

Use the **Favorites** tab as a way to filter your contacts list.

1. In the contacts list, touch the star icon showed on the top right of screen beside the contact's name.
2. Touch star icon turn it from grey to yellow to add into favorite list.
3. The contact will be added to the contacts list on the **Favorites** tab.

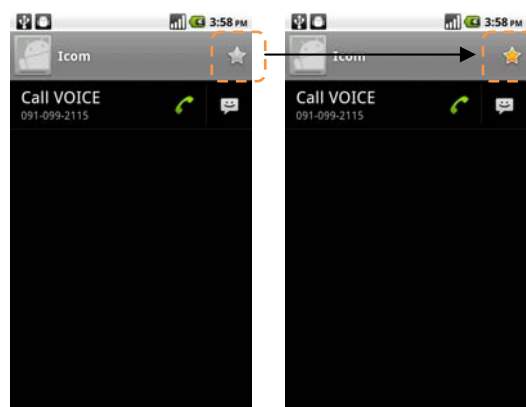

To view favorite contacts

Press the **Home** key, touch the **Dialer** icon, and then touch the **Favorites** tab. You can also see your frequently called contacts or numbers on the **Favorites** tab.

To remove a contact from the Favorites tab

1. On the **Favorites** tab, touch the contact you want to remove.
2. Touch the yellow star showed in the specific contact's information again to turn the star into grey color.

Edit and customize your contacts

To edit contact information

You can always make changes to the information you have stored for a contact.

1. In the contacts list, touch and hold the contact whose information you want to edit, then touch **Edit contact**.
2. Edit the contact information, then touch **Done**. To ignore all changes you made, touch **Revert**.

To change the contact's default phone number

The default phone number of a contact appears below the contact's name in the contacts list. The default phone number is used when you initiate a call or send a text message from the contacts list (by touching and holding a contact). You can change the contact's default phone number.

1. In the contacts list, touch the contact to open the contact details screen.
2. Touch and hold the phone number you want to use as the contact's default phone number, then touch **Make default number**. The default phone number moves on top of the list and appears after the phone number.

3. Press **BACK** when you are done.

Communicate with your contacts

From the contacts list you can quickly call or send a text or multimedia message to a contact's default phone number. However, to view all the information you have stored for a contact, and to initiate other types of communication with that contact, open the contact details screen.

To open the contact's details

- Touch the contact name in the contacts list to read the contact's detail information.

To call a contact

- Touch the contact's name in the contacts list to open the contact details screen, then touch a phone number.

To send a text or multimedia message to a contact

The contact must have a mobile phone number in their contact details for you to send them a text or multimedia message.

Do one of the following:

- When the contact's default number is a mobile phone number, touch and hold the specific contact's icon, then touch **SMS/MMS** icon showed on the screen.
- When the contact details screen opens, touch **Message**. A compose screen opens for your new email.
- Touch the Dialer icon, and then touch the Message icon to send the message. A compose screen opens for your message.



Note For more information about composing and sending text and multimedia messages, refer to **“Exchanging Messages”** on page xx.

To send an email to a contact

The contact must have an email address in their contact details for you to send them an email.

1. In the contacts list, touch and hold the specific contact's icon, then touch **Gmail** icon showed on the screen
2. When the contact details screen opens, touch **Email home**, **Email work**, or another email option. A compose screen opens for your new email.

Note If you have more than one email account set up on your phone, you will be prompted to select which account to use to send the message.

Note For more information about composing and sending email messages, refer to **“Exchanging Messages”** on page xx.

Managing Your Time

Using Clock

You can set Clock as a desktop theme. Clock also support unlimited numbers of alarms

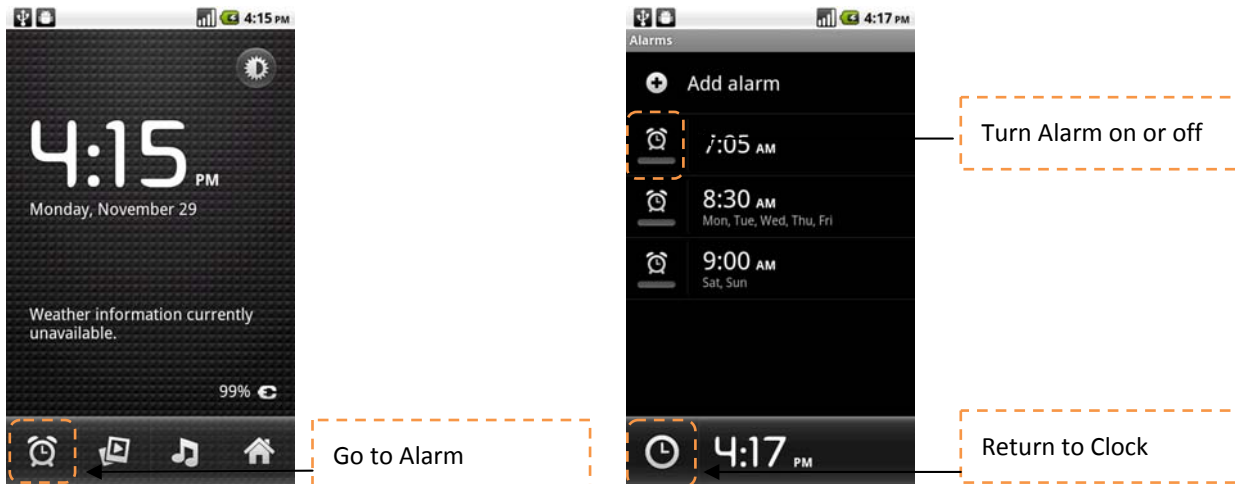

To open Alarm

1. Press **HOME**, then touch the Applications tab and then touch **Clock**.
2. Touch **Alarm** to setup the alarm by touching **Add alarm** or

Note When you open lock for the first time, three alarms are set up by default, ready for you to customize. All three alarms are turned off by default.

Set an alarm

1. Touch one of the available alarms from touch **Alarm** icon or pressing **MENU**
2. Touch **Time** to set the alarm time. Adjust the time by touching **+** or **-**. **Touch AM to change to PM**, then touch **Set when finished**.

3. Touch **Ringtone**, then select the alarm ringtone. The ringtone plays when selected.

Note Touch **Vibrate** if you want the phone to also vibrate when the alarm goes off.

4. Touch **Repeat** to select the days you want the alarm to sound, then touch **OK**.



Note If you do not select any days for the alarm, the word **Never** will show which means that your alarm will only go off once.

Note If you need to set more than 3 alarms, you can add more alarms while on the Alarm Clock screen by touching **Add alarm**.

To customize personal alarm

You can customize the alarm setting based on your need.

1. On the Clock screen, touch the specific alarm with your finger to open the settings.
2. Setup the **Time** to alarm, **Repeat** day, type of **Ringtone**, **Vibrate** or not and rename the alarm from **Label**.
3. Touch **Done** to finish the settings

Note To change the date and time format displayed in your alarms, refer to **"Set the date, time zone, and time"** on page xx.

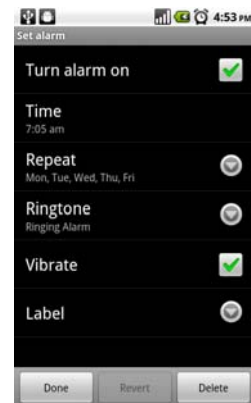

Delete an alarm

1. On the Alarm Clock screen, Touch the alarm you want to delete.
2. On the Set alarm screen, press **MENU** and then touch **Delete alarm**.

Silence all alarms

You can set whether alarms sound even when your phone is in Silent mode.

1. On the Alarms screen, press **MENU** and then touch **Settings**.
2. Touch **Alarm in silent mode** to set whether alarms play when the phone is otherwise in silent mode.
3. When you are done, press **BACK**.

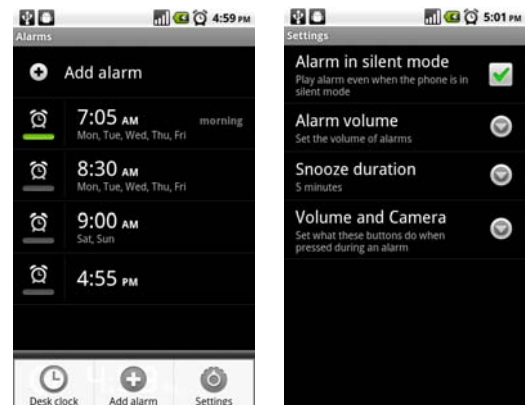

Exchanging Messages

Sending Text and Multimedia Messages

Messaging lets you compose and send text (SMS) and multimedia messages (MMS) to other mobile phones



Open Messaging

1. Press **HOME**, then touch the Applications tab
2. Touch **Messaging** and the message list appears.

Create and send SMS and MMS messages

You can compose text (SMS) messages of up to **160** characters. If you continue to type after the limit is reached, your message will be delivered as one, but count as more than one message. These are called concatenated messages.

Multimedia messages, also known as MMS, can contain text and a picture, a recorded voice, an audio file, or a picture slideshow.

Note Messaging automatically converts a text message into a multimedia message when you entered an email address in the **To** field, added a message subject, or attached an item.

To create and send a text message

1. On the Messaging screen, touch **New message**. The Compose screen opens.
2. Enter the mobile phone number of the message recipient in the **To** field. As you enter the phone number, matching contacts will appear on the screen. Touch a recipient or continue entering the recipient's phone number.

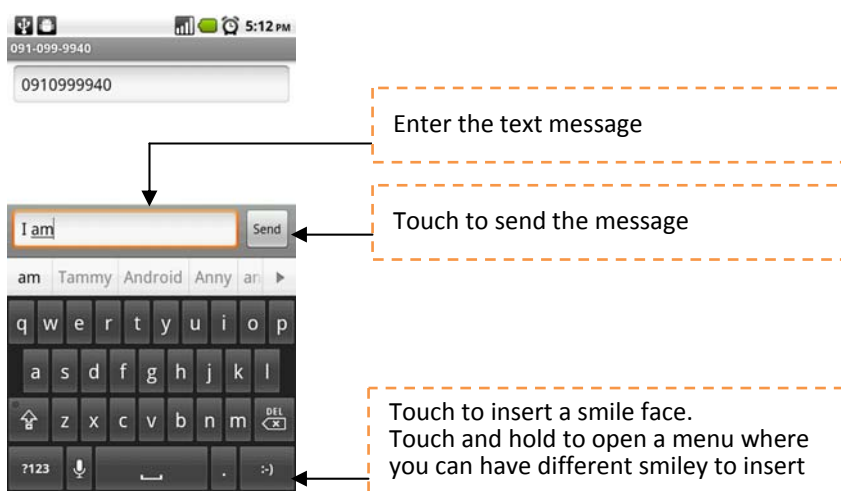
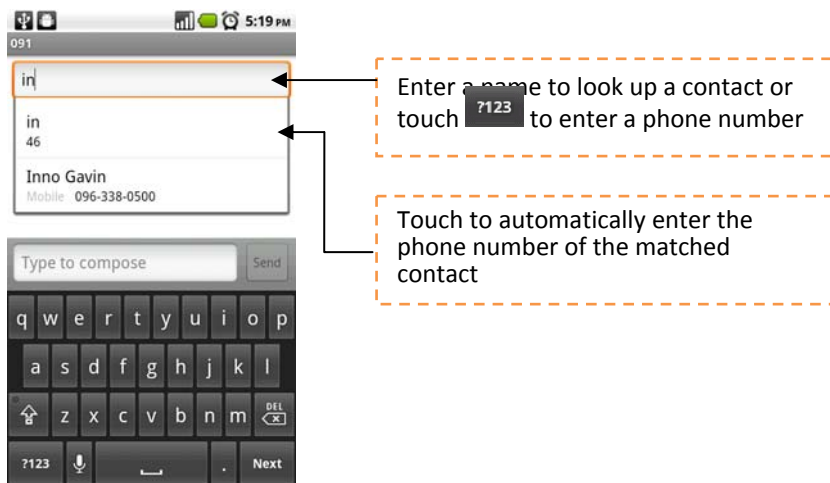

Note The phone number only appears if the number was filed under Mobile in Contacts.

3 Touch the text box that contains the text “**Type to compose**”, then start composing your message.

Note As you near the 160-character limit, a counter will appear in the top right corner of the text box to tell you how much characters are left. Once you go over that limit, a new message is created but automatically joined into one when received.



4 When done, touch **Send** to send the text message. The send progress is displayed at the right side of the message in the message thread or in the message list.

Note To receive delivery reports and know when a text message is received, in the message list, press **MENU** and then touch **Settings**. In the SMS settings section, select the **Delivery reports** check box.

To create and send a multimedia (MMS) message

1. On the Messaging screen, touch **New message**. The Compose screen opens.
2. Enter the mobile phone number or email address of your message recipients in the **To** field. As you enter the phone number or email address, matching contacts will appear on the screen. Touch a recipient or continue entering the recipient’s phone number or email address.

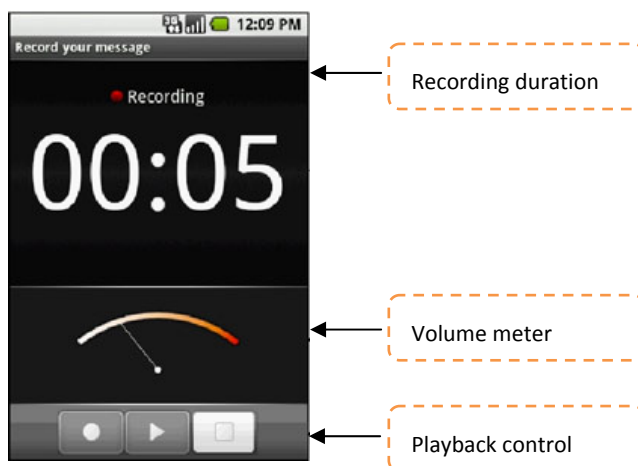

Tip You can add a subject line by pressing **MENU** and then touching **Add subject**.

3. Touch the text box that contains the text "Type to compose", then start composing your message.
Note As you near the 160-character limit, a counter will appear in the top right corner of the text box to let you know how many characters you can still enter before you reach the limit for one message.
4. Press **MENU** and then touch **Attach**.
5. On the Attach window, select from the following file attachments:
 - **Pictures**. Opens the Gallery application. Touch a picture on the screen to attach it to your message.
 - **Capture picture**. Opens the Camera application. Take a picture of your subject, then touch **Attach** to attach it to your message. For more information about the Camera application, refer to "Using Camera and Camcorder" on page xx.
 - **Videos**. Opens the Gallery application. Touch a video on the screen to attach it to your message.
 - **Capture video**. Opens the Camcorder application. Take a video, then touch **Attach** to attach it to your message. For more information about the Video application, refer to "Using Camera and Camcorder" on page xx.
 - **Audio**. Opens the Select audio menu. Touch an audio file to select, then touch **OK** to attach the file into your message.
 - **Record audio**. Touch to open the message recorder. Touch  to start recording your message, and then touch  stop. To listen to your recording, touch . Touch **Use this recording** to attach the recording to your message.

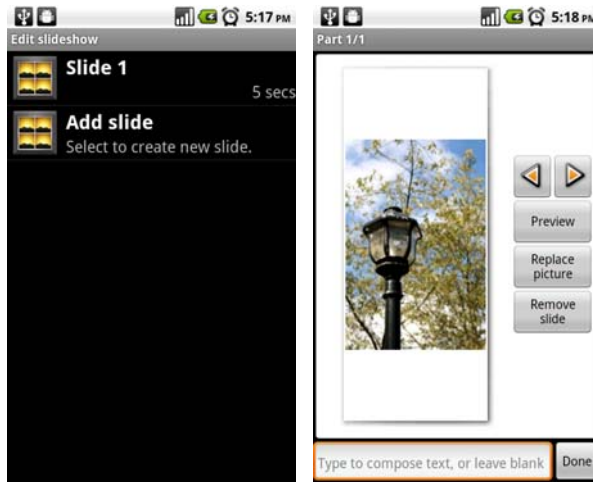

- **Slideshow**. Touch to open the Edit slideshow screen. Touch **Add slide** to create a new slide. Touch the created slide (for example, Slide 1), touch **Add picture**, then select the picture you want to add to the slide. You can also navigate to the text box and enter a caption for the picture. Press **MENU** to preview the slide, remove the picture, add a music, add another slide, or change the slide duration or layout. When finished, touch **Done** to attach the slideshow to your message.



Tip You can create a slideshow of up to ten slides. When editing multiple slides, touch  to edit the next slide or touch  to return to the previous slide.

Notes

- To view the slideshow, touch the **Preview** key while editing the slideshow, or touch the **Play** key on the Compose screen.
 - To remove or replace a picture or an audio attachment, on the Compose screen, touch the **Remove** key beside the attachment. To remove a slideshow attachment, on the Compose screen, touch **Removeslideshow**.
6. When you are finished composing the multimedia message, touch Send. The send progress is displayed at the right side of the message in the message thread or in the message list.

Note To receive delivery reports and know when a picture message is received, in the message list, press **MENU**, then touch **Settings**. Select the **Delivery reports** check box below the MMS settings section.

To save a message as a draft

While composing a text or multimedia message, press **BACK** to automatically save your message as a draft. To resume composing the message, touch the message in the message list. Continue editing the message, then touch **Send** to send it.

Receive text and multimedia messages

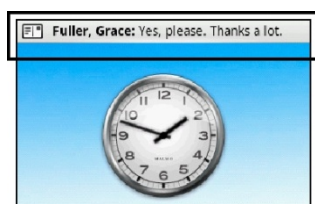

Depending on your notification settings, the phone will play a ring tone, vibrate, or display the message briefly in the status bar when you receive a new text or multimedia message. To change the notification for new text and multimedia messages, refer to **“Adjust text and multimedia message settings”** on page xx.

A new message icon  also appears in the notifications area of the status bar to notify you of a new text or multimedia message. To open the message, refer to the next section.

Manage messages and message threads

Text and multimedia messages that are sent to and received from a contact (or a number) are grouped into conversations or message threads. Threaded text or multimedia messages let you see exchanged messages (similar to a chat program) with a contact on the screen. Message threads are listed in order of when you received them, with the latest message on top of the thread.

To open and read a text message

Do one of the following:

- Press **HOME**, then touch and hold the status bar, and then slide it down to open the Notifications panel. Touch the new message to open and read it.
- On the message list, touch the text message or message thread to open and read it.

To return to the message list from a text message thread, press **MENU** and then touch **All threads**.

Notes

- To view the details of a particular message, in the message thread, touch and hold the message to open the options menu, then touch **View message details**.
- If a message contains a link to a web page, touch the link to open Browser and view the web page.

If a message contains a phone number, touch the message to open Dialer so you can call the number.

To open and view a multimedia message

1. In the message list, touch a multimedia message or message thread to open it.
2. Touch the **Play** key at the right side of a multimedia message to view it.



Notes

- When **Auto-retrieve** in MMS settings is disabled, only the message header is downloaded. To download the entire message, touch the **Download** key at the right side of the message. Once the message has downloaded, touch the **Play** key to view the message. For details, refer to **“Adjust text and multimedia message settings”** on page xx.
- If you are concerned about the size of your data downloads, check the multimedia message size before you download it.

To reply to a text or multimedia message

1. In the message list, touch a text or multimedia message thread to open it.
2. Touch the text box at bottom of the screen, enter your reply message, and then touch **Send**.

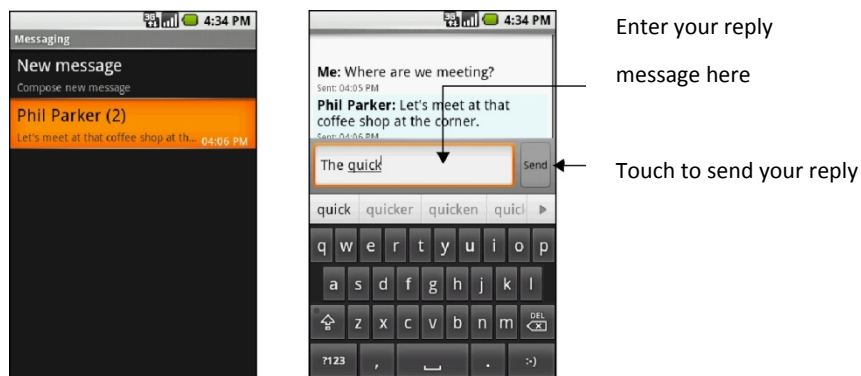

Tip To reply a text message with a multimedia message, open the text message, press **MENU** and then touch **Add subject**, or **Attach**. The text message is automatically converted into a multimedia message.

To delete a message or a message thread

1. In the message list, touch the message thread that you want to delete.
2. Do one of the following:
 - To delete the entire thread, press **MENU** and then touch **Delete thread**. When prompted to confirm, touch **OK**.
 - To delete a message in a thread, touch and hold the message that you want to delete, then touch **Delete message** on the options menu. When prompted to confirm, touch **OK**.

Note To delete all messages on the message list, press **MENU** on the message list and then touch **Delete threads**.

Adjust text and multimedia message settings

In the message list, press **MENU** and then touch **Settings** to adjust the text or multimedia message settings. You can set the following options:

SMS settings	
Delivery reports	Select this option to receive a report on the delivery status of your message.
Manager SIM card messages	Touch to view text messages stored on your SIM card. You can also delete or copy these messages to your phone's memory.
MMS settings	
Delivery reports	Select this option to receive a report on the delivery status of your message.
Read reports	Select this option if you want to receive a report whether each recipient has read or has deleted the message without reading it

Auto-retrieve	Select this option to automatically retrieve all your MMS messages completely. When selected, the MMS message header plus the message body and attachments will automatically download to your phone. If you clear this check box, only the MMS message header will be retrieved and shown in your message list.
Roaming auto-retrieve	Clear this option if you only want the MMS message headers to download while roaming. Select this option to automatically download your complete multimedia messages even while roaming.
<hr/> Notification settings <hr/>	
Notifications	Select this option if you want to receive a notification in the status bar when a new text or multimedia message arrives.
Select ringtone	If you want the phone to ring when a new message arrives, touch this option, then select a ring tone that is specific to new text and multimedia messages. Note that the ring tone briefly plays when selected.
Vibrate	Select this option if you want the phone to vibrate when a new text or multimedia message arrives.

Using EMail

The Email application comes with an email wizard that lets you add external POP3 or IMAP email accounts from popular web-based email service providers such as Hotmail, Gmail, Yahoo!® Mail Plus, AOL, and more, on your phone.

To open Email

Press **HOME**, then touch the Applications tab, and then touch **Email**.

Add an email account

1. Press **HOME**, then touch the Applications tab, and then touch **Email**.
2. In the Your accounts screen, touch **Next**.
3. Enter the email address and password of the email account you want to set up and then touch **Next**.

Notes

- If the email account you want to set up is not in the phone's email database, you will be prompted to manually enter the email account settings, such as the email server, protocol and more after touching **Next**.
- Touch **Manual setup** instead of **Next** to directly enter the incoming and outgoing settings for the email account you are setting up. Enter the name for the account and the name you want displayed in outgoing emails and then touch **Done**.

After creating one email account, you need to press **MENU**, then touch **Add account** to create another email account.

Compose and send emails

1. Press **HOME**, then touch the Applications tab, and then touch **Email**.
2. In the Your accounts screen, touch the email account you want to use.
3. In an email account inbox, press **MENU**, then touch **Compose**.
4. Enter the message recipient's email address in the **To** field. As you enter information, matching contacts will appear on the screen. Touch the recipient or continue entering the email address. If you are sending the email to several recipients, separate the email addresses with a comma. You can add as many message recipients as you want.
5. Enter the subject, then compose your message and touch **Send**.

Note Touch **Save as draft** or press the **BACK** key to save the message as a draft.

Manage emails on your external email account

To delete a message

1. On the email account inbox, touch and hold the email you want to delete.
2. On the options menu, touch **Delete**.

Edit or delete an external email account

You can edit or delete an external email account on your phone.

1. Press **HOME**, touch the Applications tab, then select **Email**.
2. Do one of the following:
 - To delete, touch and hold the account you want to remove, then touch **Remove account** on the options menu. When prompted to confirm deletion, touch **OK**.
 - To edit, touch and hold the account you want to edit, then touch **Account settings** on the options menu.

Add more email accounts

On the Your accounts screen, press **MENU** and then touch **Add account**.

Using Gmail

Google mail is the web-based e-mail service which you may check the email box directly without log-in your mail account every time from web site.

To create and send mail

1. Press **HOME**, then touch Gmail.
2. For 1st time use, you will be requested to create or sign-in your gmail account.
3. After all, you can create the mail box and send mail following the same procedure of in the pervious section: "Using email"

Getting Connected

Connecting to the Internet

Your phone's networking capabilities allow you to access the Internet through one of the following connections:

- GPRS/EDGE /HSPA

GPRS/EDGE/HSPA

Your phone will be automatically configured to use your service provider's GPRS/EDGE/HSPA service when you turn on your phone (if the SIM card is inserted) for the first time.

To turn on the network

1. Press **HOME**, then press **MENU**, and then touch **Settings**.
2. Touch **Wireless & networks > Mobile networks > Data enabled**.
3. Touch the check box to allow the 3G network access.

NOTE Before using the 3G network, please make sure the SIM card has been inserted.

Important Turn on this feature will be charged for extra data link by your service provider.

To check the network connection you are using

4. Press **HOME**, then press **MENU**, and then touch **Settings**.
5. Touch **Wireless & networks > Mobile networks > Network operators** or **Access Point Names**.

To create a new access point

When you need to add another GPRS/EDGE/3G connection on your phone, obtain the access point name and settings (including username and password if required) from your service provider.

1. Press **HOME**, then press **MENU**, and then touch **Settings**.
2. Touch **Wireless & networks > Mobile networks > Access Point Names**.
3. On the APNs screen, press **MENU** and then touch **New APN**.
4. In the Edit access point screen, enter the APN settings. Touch the APN setting item to edit it.
5. Press **MENU** and then touch **Save** when you finish setting up the new APN.

NOTE Your phone will sync automatically with Google service. If you do not want to link the data service, pls turn of the selection of **Data enabled**.

To open Browser

Do one of the following:

- Press **HOME**, then touch **Browser**.
- Press **HOME**, then touch the Applications tab, and then touch **Browser**.

Note Browser automatically opens when you touch a web link in an email or text message.

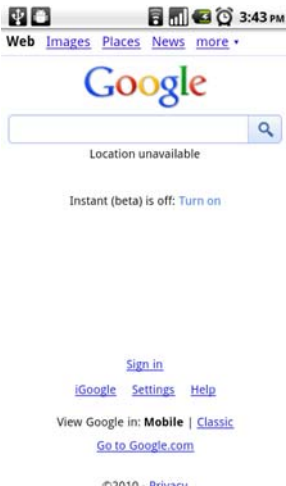

To go to a web page

1. On the Browser screen, press **MENU** and then touch topper side of window.
2. Enter the web page address using the keyboard. As you enter the address, matching web page addresses will appear on the screen. Touch an address to go directly to that web page or continue entering the web page address.
3. Touch  to go.

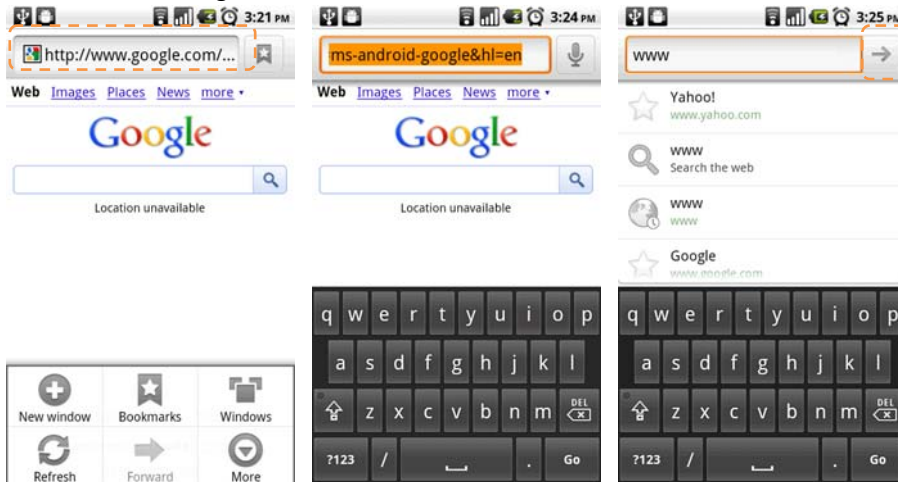

To set your home page

1. Press **MENU** and then touch **More > Settings > Set home page**.
2. Enter the URL of the web site you want to use as your home page and then touch **OK**.

View web pages

Browser offers a host of features that let you view web pages just like on a desktop computer.

To change the screen orientation to landscape view

Turn your phone sideways to view the web page in landscape mode. The screen orientation automatically adjusts to how you hold the phone.

Note The **Auto-rotate screen** checkbox in **HOME > MENU > Settings > Display** needs to be selected for the screen orientation to automatically change.

To navigate on a web page

You can slide your finger on the screen in any direction to navigate and view other areas of the web page.

To zoom in or out on a web page

1. On a web page, touch and hold the webpage to activate the zoom control.
2. You may zoom in/out through the zoom in/out tab  showed in the right corner by sliding down the center down side to activate, or use your two finger to zoom in/out



To open a new browser window

1. Press **MENU** to show the options list
2. Touch **New window** to open. A new browser window opens and goes to the home page that is set.

Note If you have two or more browser windows opened, press **MENU** and then touch **Windows** to let you add more browser windows.

To switch between browser windows

1. On a browser window, press **MENU** and then touch **Windows**.
2. On the Current windows screen, touch the link you want to view.
3. You may also close the browser window by touching  to close the selected browser window.

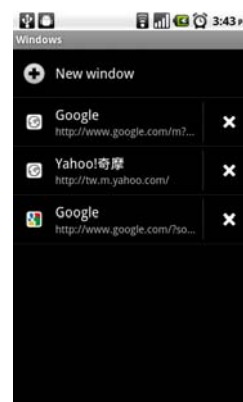

To find text within a web page

1. While viewing a web page, press **MENU** and then touch **More > Find on page**.
2. Enter the search item. As you enter characters, matching characters will be highlighted in green. Touch the left or right arrow to go to the previous or next matching item.

Tip Touch  to close the search bar any time.

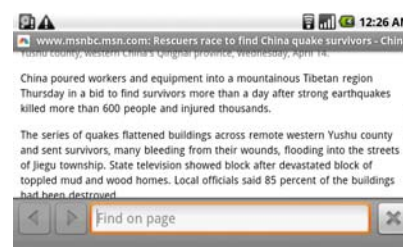

To copy text on a web page

Copy text from web pages and then paste them on emails or your SMS/MMS messages.

1. Open the web page where you want to copy text.
2. Locate the text you want to copy and then press **MENU** and then touch **More > Select text**.

Tip Zoom out of the page before you select text.

3. Position your finger at the start of the text you want to copy and then drag to the end of the text you want to copy. Copied text are highlighted in pink.
4. Release your finger from the screen.

To paste text on a email or SMS/MMS message, touch and hold the text box on a message or email and then touch **Paste** on the options menu.

Manage links, history, and downloads

Always press MEUN key to open the option list. You can adjust your browser's settings from the "Settings" function under browser.

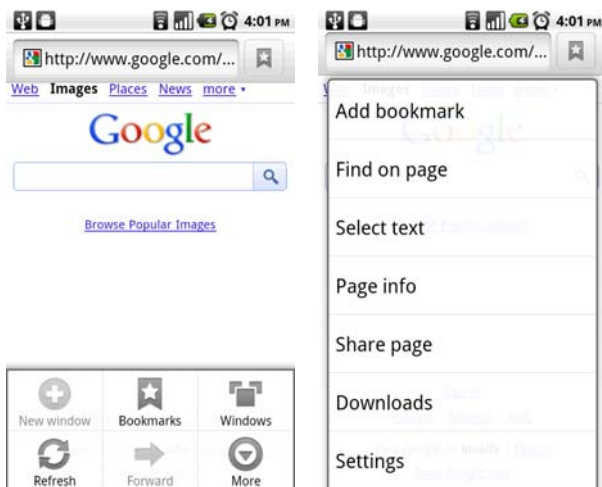

To check Browser history

On the Browser screen, press **MENU** and then touch **Bookmarks > History** tab. Touch an item to open the web page.

Tip You can also check your most visited web pages by pressing **MENU** and then touching **Bookmarks > Most visited** tab.

To allow download of web applications

Before you can download web applications, you must first enable downloading from the phone settings.

1. Press **Home**, then press **MENU**, and then touch **Settings > Applications**.
2. Select the **Unknown sources** check box.
3. When the Attention dialog box opens, touch **OK**.

Note All downloaded applications are saved to the storage card. Before you download an application from the web, make sure that you have installed a storage card on your phone. For information on how to install a storage card, refer to **"To install the storage card"** on page xx.

Note Applications downloaded from the web can be from unknown sources. To protect your phone and personal data, download applications only from trusted sources. Refer to **"Installing an application"** on page xx for details.

Manage bookmarks

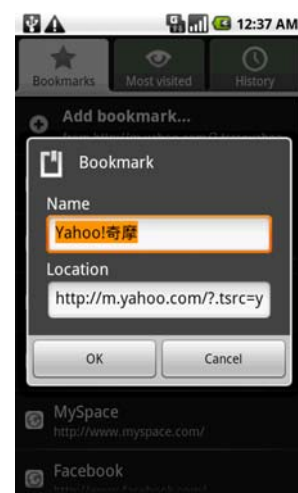

You can store as many bookmarks as you want on your phone. Your browser support two different views: Thumbnail & List view. You can also copy your bookmarks on Chrome browser in your PC to your phone browse. You will be requested to install this add-on feature in your Chrome browser in your PC. Please follow the instruction in your "Chrome to Phone".

To bookmark a web page

1. On a browser screen, go to the web page you want to book mark.
2. Press **MENU** and then touch **Bookmarks**. The bookmarks screen opens.
3. On the **Bookmarks** tab, touch **Add bookmark**.
4. Edit the bookmark **Name** if needed and then touch **OK**.

To open a bookmark

1. On the Browser screen, press **MENU** and then touch **Bookmarks**.
2. On the **Bookmarks** tab, do one of the following:
 - Touch the bookmark you want to open.
 - Touch and hold the bookmark you want to open, then touch **Open** from the options list.

To edit a bookmark

1. On the Browser screen, press **MENU** and then touch **Bookmarks** from the options list.
2. On the **Bookmarks** tab, touch and hold the bookmark you want to edit.
3. Touch **Edit bookmark** on the options menu and the edit bookmark dialog box shows.
4. Type in your changes and confirm by touching **OK**.

Adjust Browser settings

On the Browser screen, press **MENU** and then touch **More > Settings** to set the Browser settings and options.

Using WiFi

WiFi technology is a narrow range of connectivity technology to support wireless local area network based on IEEE 802.11 standard. WiFi provides wireless internet access over distance up to 100 meters. To use your WiFi function, you would need to access the wireless access point.

To turn on WiFi and connect the access point

1. Press **HOME**, then press **MENU**, and then touch **Settings**.
2. Touch **Wireless & networks**, then select the **WiFi** check box to turn on WiFi in the **WiFi Settings**. When on, the WiFi icon  appears in the status bar.
3. Several access points will be showed and displayed in the list under the section of WiFi network.
4. Select the one you would connect and enter the password if required.
5. Touch "Connect" to connect the wireless access point.

To add another WiFi network

1. Press **HOME**, then press **MENU**, and then touch **Settings**.
2. Touch **Wireless & networks**, turn on the WiFi and then select the **Add WiFi**
3. Enter the network SSID and select the security.

Note

Your phone provides four ways of network certificate.

- **Open:** no security.
- **WEP:** Wired Equivalent Privacy. It a security protocol for wireless networks that encrypts transmitted data. The WEP concept of *passphrase* is introduced so that you do not have to enter complicated strings for keys by hand. It required to enter the access key but easy to crack.
- **WPA/WPA2 PSK:** Wi-Fi Protected Access. It is a protocol to secure your wireless network so only you can use it. It is wireless security with greater protection than WEP. WPA or WPA2 must start and electe to replace the WEP to be useful. In order to preserve the integrity of the passphrase needed to be set by the user which to have to provide longer than six to eight characters of the password.
- **802.1x EAP:** 802.1x Extensible Authentication Protocol. The purpose of 802.1x is to accept or reject users who want full access to a network using 802.1x. It is a security protocol that works with 802.11 wireless networks. EAP methods can provide a secure authentication mechanism, and in between the user and the network access server to provide a secure PMK.



To check the network status

1. Press **HOME**, then press **MENU**, and then touch **Settings**.
2. Touch **Wireless & networks**, go to **WiFi Settings** and touch the specific access point you have linked.
3. The status of network will be displayed.

Using Bluetooth

Bluetooth technology is a short-range wireless communications technology that allows Bluetooth devices to exchange information within 5 meters without a physical connection. The phone supports the following Bluetooth profiles:

Headset, Handsfree, A2DP, and AVRCP, OPP.

Bluetooth operates in three different modes:

- **On.** Bluetooth is turned on. Your phone can detect other Bluetooth-enabled devices, but not vice versa.
- **Discoverable.** Bluetooth is turned on, and all other Bluetooth-enabled devices can detect your phone.
- **Off.** Bluetooth is turned off. In this mode, you can neither send nor receive information using Bluetooth.

Notes

- Bluetooth is default turned off. If you turn it on, then turn off your phone, Bluetooth also turns off. When you turn on your phone again, Bluetooth automatically turns on.
- Turn off Bluetooth when not in use to conserve battery power, or in places where using a wireless device is prohibited, such as on board an aircraft and in hospitals.

- To quick turn on Bluetooth, go to HOME>MENU key>Widget> Power Control, your home screen will display a widget with quick control for WiFi, Bluetooth, GPS, Sync and Display lighting.

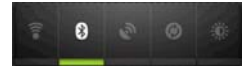

To turn on Bluetooth and make the phone discoverable

6. Press **HOME**, then press **MENU**, and then touch **Settings**.
7. Touch **Wireless & networks**, then select the **Bluetooth** check box to turn on Bluetooth. When on, the Bluetooth icon  appears in the status bar.
8. Touch **Bluetooth settings**, then select the **Discoverable** check box to make the phone discoverable to other Bluetooth devices that are within range.

To edit the phone name

The phone name identifies your phone in a Bluetooth network.

1. Make sure that you have turned Bluetooth on.
2. On the Wireless & networks screen, touch **Bluetooth settings > Device name**.
3. Enter the name for your phone in the dialog box, then touch **OK**.

To pair and connect a Bluetooth hands-free headset or car kit

You can connect your phone to a Bluetooth hands-free headset or a Bluetooth car kit and use those devices to send and/or receive calls. Before you can use a Bluetooth hands-free headset or car kit, you must pair it first with your phone.



1. Press **HOME**, then press **MENU**, and then touch **Settings**.
2. Touch **Wireless & networks > Bluetooth settings** and then select the **Bluetooth** check box. Your phone will start to scan for Bluetooth devices within range and will display all detected devices below the Bluetooth devices section.

Tips

- If you do not find the device in the list, touch **Scan for devices** to scan again.
- Make sure that the Bluetooth device that you want to pair with is set to discoverable mode. Consult the Bluetooth device's documentation to learn how to set it to discoverable mode.

3. Touch the hands-free headset or car kit in the list to start pairing.

Note For some Bluetooth devices, you need to enter a password to pair with the Bluetooth device. You can try "0000" as the password. If that does not work, please check your Bluetooth device for password information.

4. The pairing and connection status  will appear below the hands-free headset or car kit name in the Bluetooth devices list. When the other Bluetooth hands-free headset or car kit is connected to your phone, the Bluetooth connected icon  will appear in the status bar. You can now start using the hands-free headset or car kit to make and/or receive phone calls.

Notes

- Pairing between two Bluetooth devices is a one-time process. Once pairing is created, the devices can recognize the partnership and exchange information without entering a password again.

- If you pair with a second headset while connected to the first, the first headset will be disconnected. To switch connection back to the first headset, you must manually select that headset again in the Bluetooth devices list

To disconnect a Bluetooth hands-free headset or car kit

1. Press **HOME**, then press **MENU**, and then touch **Settings**.
2. Touch **Wireless & networks > Bluetooth settings**.
3. Navigate to the Bluetooth devices section, then touch and hold the connected hands-free headset or car kit.
4. Touch **Disconnect**.

Notes

Touch **Unpair** if you want the phone to erase all pairing information with the hands-free headset or car kit. You will be requested to enter the password again when you connect to that Bluetooth device.

Entertaining through multimedia functions

Using Camera and Camcorder

Your phone design with 5 megapixel camera with auto-focus feature in the rear and VGA camera in the front allows you to take pictures and videos.

Before starting use the camera, please note

- You must insert a storage card before using the Camera or Camcorder. All pictures or videos that you capture are stored on the storage card. For more information on how to install a storage card on your phone, refer to ["To install the storage card"](#) on page xx.

To open the Camera or Camcorder

- Press **HOME**, touch the Applications tab
- Touch **Camera** if you want to capture photos or **Camcorder** if you want to shoot videos. The screen automatically switches to landscape orientation when you open Camera or Camcorder.

Tip You can easily switch to the other capture mode while you are in Camera or Camcorder. Refer to "Take pictures" in this chapter for details.

To close the Camera or Camcorder

On the Camera screen, press **HOME** or **BACK**.

To change the capture mode

On the Camera screen, touch **Switch to video** or **Switch to camera** icons (showed in the below) where display in your left side. Selected mode's icon will change the color from green to red.

Take pictures

- Press **HOME**, touch the Applications tab and then touch **Camera** or if you are in Camcorder, touch **Switch to camera**.
- Frame your subject on the screen.
- This camera is design to support 5megapixel camera which can support many functions described in the below.

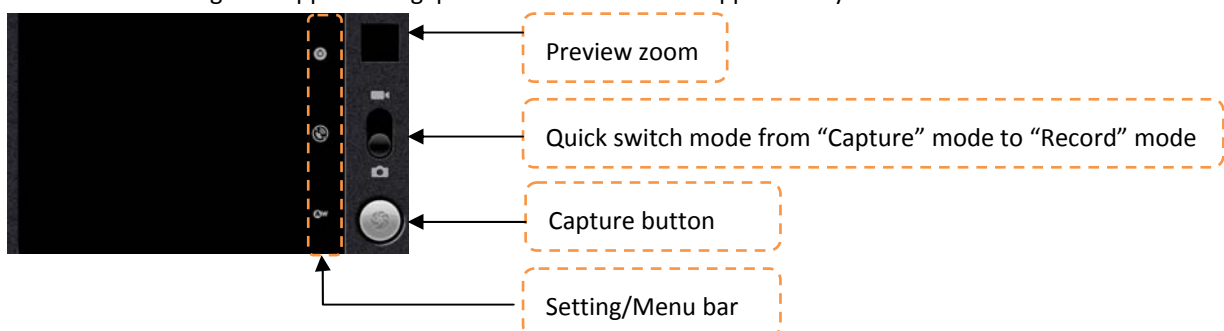

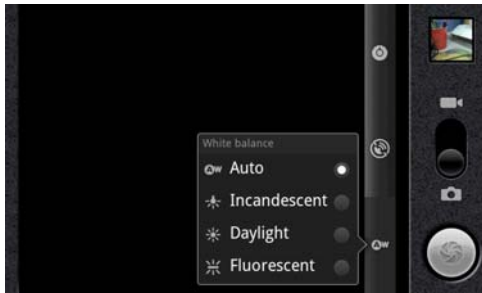

<i>Menu</i>	<i>Function</i>	<i>Options</i>
Setting	Exposure	+2, +1, 0, -1, -2
	Scene mode	Auto, Landscape, Night, Anti-handshaking, Beach, Snow, Sports
	Picture size	5M Pixels, 3M Pixels, 2M Pixels, 1M Pixels, VGA
	Picture quality	Super fine, Fine, Normal
	Color effect	None, Mono, Sepia, Negative
	Auto flicker	Auto, 50hz, 60hz, Off
	Camera Setting	Restore to defaults
Location	On, Off	
White Balance	Auto, Incandescent, Daylight, Fluorescent	

4. Press the camera key to take the picture.

Shoot videos

1. Press **HOME**, touch the Applications tab and then touch **Camcorder** or if you are in Camera, touch **Switch to video**.
2. Frame your subject on the screen.
3. Your video can support many different functions described in the below.

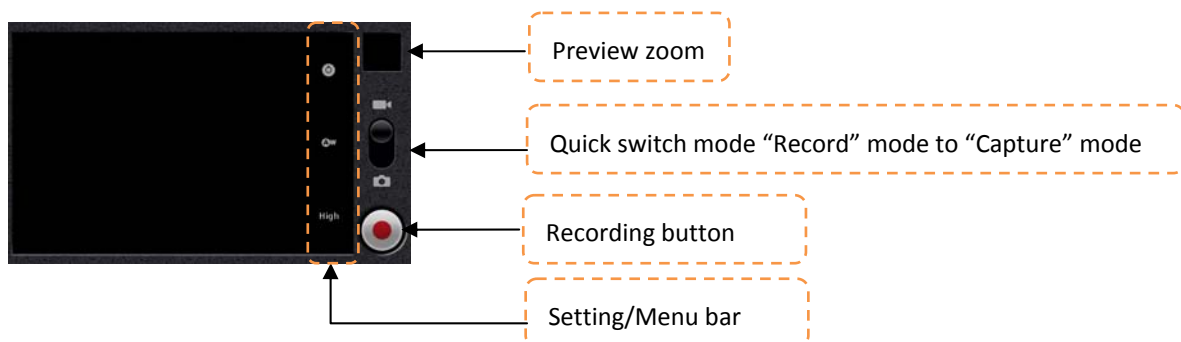

<i>Menu</i>	<i>Function</i>	<i>Options</i>
Setting	Color effect	None, Mono, Sepia, Negative
	Videosettings	Restore to defaults
White balance	Auto, Incandescent, Daylight, Fluorescent	
Video quality	720p, D1, High, Medium, Low, MMS	

4. Press the camera key to start recording video. Touch the same key again to stop recording.

Post capture

After capturing, the image you just captured appears in the preview zoom showed on the top right side of corner..
You might touch the preview zoon and go to the gallery to share the picture.

Copying photos and video to storage

To copy pictures and videos into the storage card

1. Set the phone's storage card as a USB drive. Refer to "Using the Phone's Storage Card as a USB Drive" on page xx for details.
2. On the computer, navigate to the USB drive and open it.
3. Create a folder on the root folder of the storage card.
Tip You can also create and use folders to organize your pictures or videos into albums inside the folder you have created.
4. Copy the files into the folder you have created.
5. After copying the files, unmount or eject the drive as required by your computer's operating system to safely remove the phone.
6. Disconnect the phone from the computer.

Using Gallery

Gallery lets you view photos and play back videos. For photos, you can also do basic editing tasks, set them as your wallpaper or contact picture, and share to your friends.



To open Gallery

- Press **HOME**, touch the Applications tab and then touch **Gallery**.
- While on the Camera screen, touch **Gallery** icon.

If you stored your files in folders (directories) on the storage card, Gallery will display these folders as separate albums.
The top left album contains all the pictures in the storage card.

Note Depending on the number of pictures stored on the storage card, it may take a while to load all your photos on the screen.

To manage Gallery

1. While in the Gallery screen, press **MENU** twice to manage all folders.
2. Touch the check box. When the item is selected, the box will be turned to green color.

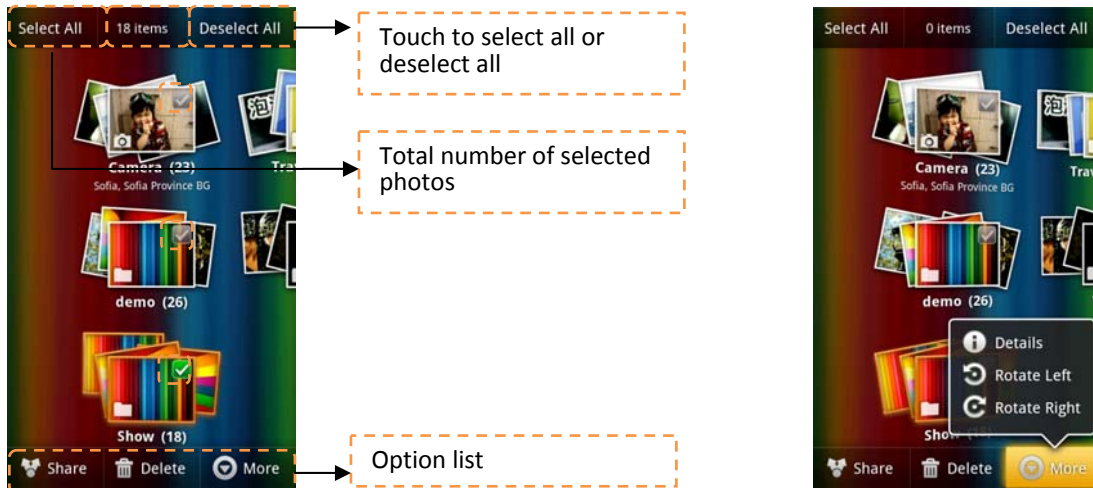

To close Gallery

While in the Gallery screen, press **HOME** or **BACK** to close the application.

Note If you opened Gallery from the Camera application, the screen returns to the Camera screen when you press **BACK**.

Work with pictures

Once you have taken a picture, you can view it or share it with friends through MMS or email.

To view pictures

You can choose to sort your pictures by date of taking photo.

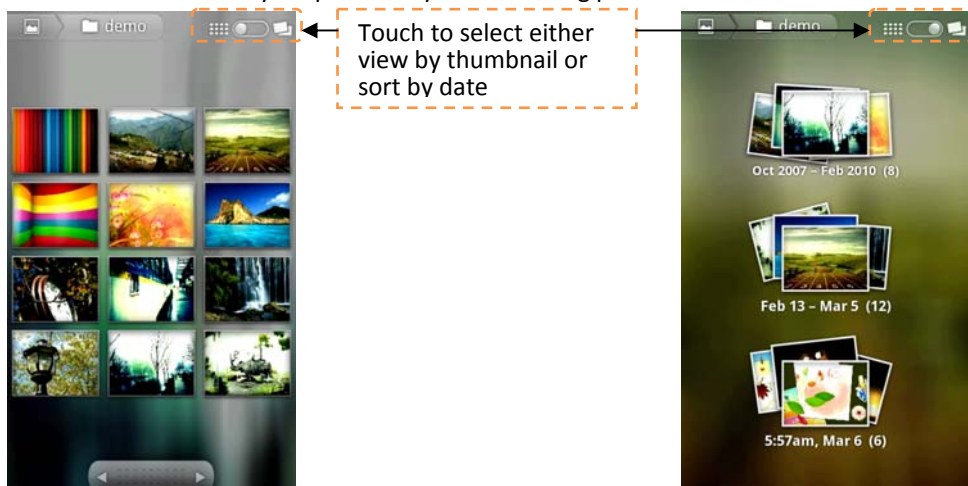

1. On the Gallery screen, touch an album to view the pictures inside the album

Note If there are no picture albums, slide your finger upward or downward the screen.



To zoom in or out on a picture

Do one of following to zoom in or out the picture.

- Touch the screen to activate the zoom in/out bar.
- Use your fingers to zoom in/out by multitouch feature.

To view a picture in landscape orientation

1. Turn your phone sideways to view the picture in landscape mode.
2. The picture orientation automatically adjusts to how you hold the phone.

Notes

- The **Auto-rotate screen** check box in **Home> MENU > Settings > Display** needs to be selected for the screen orientation to automatically change.

To rotate and save the rotated state

- 1 In the Gallery screen, touch and hold the picture you want to rotate or if you are viewing the picture in full screen, press **MENU**.
- 2 In the options menu, touch to either **Rotate left** or **Rotate right**.

Note The Picture rotates 90 degrees counter-clockwise (Rotate left) or 90 degrees clockwise (Rotate right) each time you touch one of the Rotate options.



To crop a picture

- 1 While viewing a picture in full screen, press **MENU > More** then touch **Crop**. The cropper tool appears.
- 2 Do one of the following:
 - To adjust the cropper size, touch and hold the edge of the cropper tool. When the cropper arrows appear, drag your finger inward to or outward from the centre of the cropper to resize it.
 - To keep the aspect ratio of the cropper while resizing, touch and hold one of the 4 corners.
 - To move the cropper to another area on the picture, touch and hold inside the cropper, then drag it with your finger to the desired position.

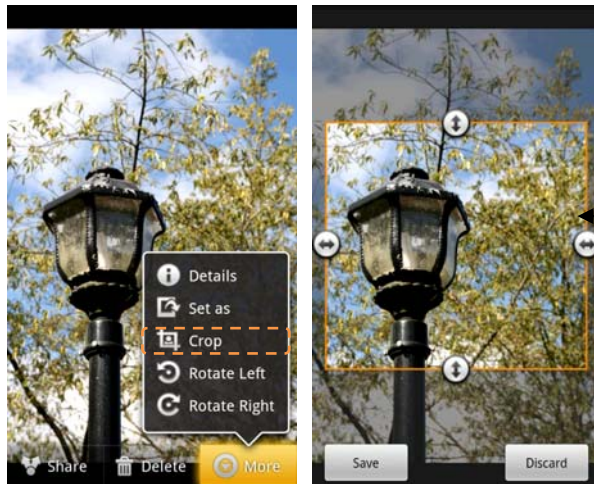

Touch and hold the picture to activate the crop frame

3 Touch **Save** to apply the changes to the picture.

Note The cropped picture is saved in the storage card as a copy. The original picture remains unedited.

To send a picture using Email or Messaging

- 1 While viewing a picture in full screen, press **MENU**, then touch **Share**.
- 2 When prompted, touch **Email or Messaging**.
- 3 The picture is automatically attached to your email. Compose your message, then touch **Send**. For more information on how to create and send emails, refer to "Using eMail" on page xx. For more information on how to create and send messages, refer to "Sending Text and Multimedia Messages" on page xx.



Work with videos

Once you have taken a video, you can view it or share it with friends.

To watch videos

1. On the main **Gallery** screen, touch a video album
2. Touch the video you want to watch to start playing back the video.
3. Touch the screen to show the playback controls.

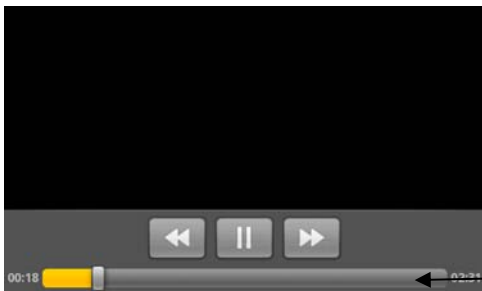

Touch and pull forward and backward

To send a video using Email

1. While viewing videos in a list, press **MENU** to select the video by touching the check box.



2. Touch **Share** to select **Email**
3. The video is automatically attached to your email. Compose your message, then touch **Send**.

To send a video using Messaging

There is a 3MB limitation on the size of a video file that can be shared. If you want to share a video that you captured using the phone, this is approximately 1 minute of high quality or 2 minutes of low quality.

1. While viewing videos in a list, touch and hold the video, and then touch **Share** on the options menu.
2. When prompted, touch **Messaging**.
3. The picture is automatically attached to your message. Compose your message, then touch **Send**.

Tip To save your time, you may select **Video MMS** mode from menu options list which will help to capture the video within limited size.

Using Music

Since Music only plays audio files saved on the storage card of your phone, you must copy your audio files to the storage card before you open Music. Music supports the following music file formats: MP3, AMR, AAC, MIDI, WAV, OGG.

To copy music into the storage card

1. Set the phone's storage card as a USB drive. Refer to "Using the Phone's Storage Card as a USB Drive" on page 32 for details.
2. On the computer, navigate to the USB drive and open it.
3. Create a folder on the root folder of the storage card (for example, Music).

Tip You can also create and use folders to organize your music inside the Music folder you have created.

4. Copy the music into the folder you have created.
5. After copying music, **unmount** or eject the drive as required by your computer's operating system to safely remove the phone.
6. Disconnect the phone from the computer.

To open Music

1. Press **HOME**, touch the Applications tab
2. Touch **Music**. The Music library screen displays.

Play music

Your music is organized into four categories: **Artists**, **Albums**, **Songs**, and **Playlists**. Touch a category to view the list within each. When inside a category, keep touching the screen until you reach the music you want to play.

Music Library

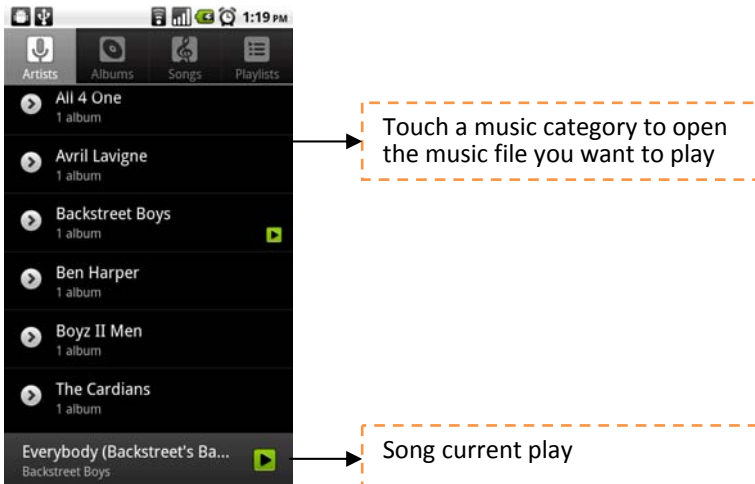

Touch a song to play it back

Notes Press the Volume key to adjust the playback volume as the quick access.

Tip While on the Music playback screen, you can play all songs in your library in random order. Press **MENU**, then touch **Party shuffle**. The first randomly selected song will play. To turn off Party shuffle, press **MENU**, then touch **Party shuffle off**.

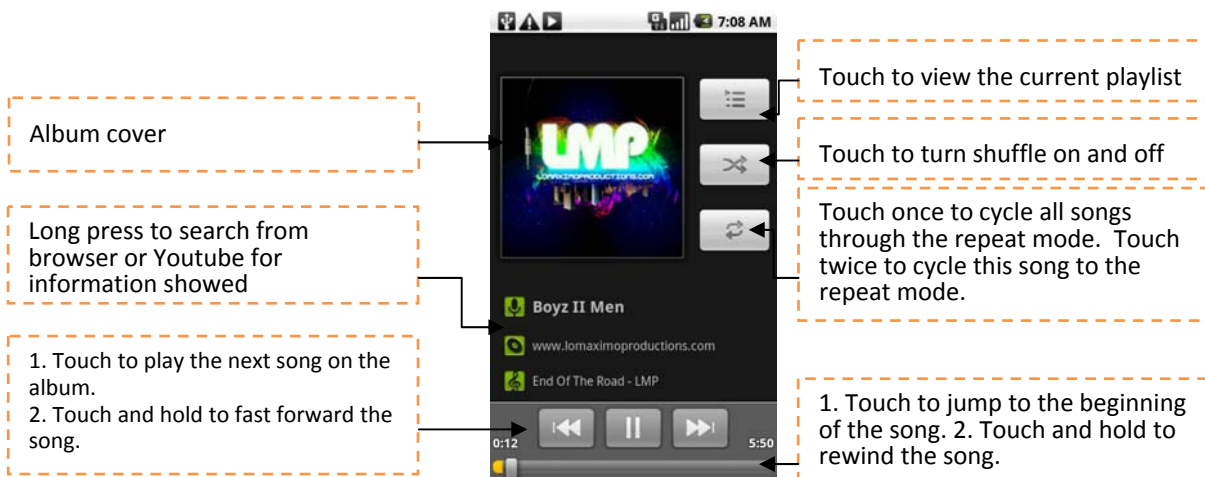

Use playlists

Use playlists to organize your music files. You can create as many playlists as you want on your phone.

To create a playlist

1. Touch a category on the Music library screen.
2. In the list that appears, select the song that you want to add in the playlist.
3. Touch and hold the song, then touch **Add to playlist** on the options menu.
4. In the Add to playlist window, touch **New** and edit the name of new playlist. Touch **Save** to finish.

Tip If you want to add the artist, album, or song to an existing playlist, touch the playlist's name in the Add to playlist options menu..

To manage your playlists

- 1 Go to the Music library screen and then touch **Playlists**.
- 2 Do one of the following:

- To play the songs in a playlist, touch the playlist name.
- To delete a playlist, touch and hold the playlist, then touch **Delete**.
- To rearrange the songs or remove a song in a playlist, touch and hold the playlist, then touch **Edit** on the options menu. Touch and hold before the song you want to move, drag it to its new position, then release.
- To delete a song in a playlist, touch and hold the song, then touch **Remove from playlist**.
- To rename a playlist, touch and hold the playlist, then touch **Rename** on the options menu. Enter the new playlist name, then touch **Save**.

Note The **Recently added** playlist is a system playlist and cannot be deleted or renamed.

To set a song as ring tone

You can use songs as your phone ring tone.

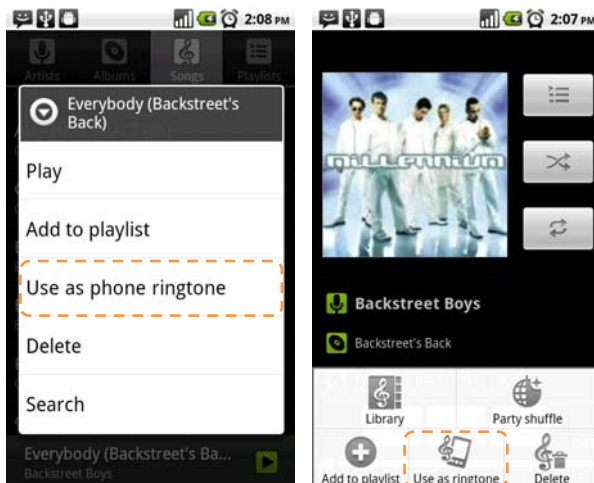

1. From the Music library, navigate to the song that you want to use as ring tone.
2. Touch and hold the song then touch **Use as phone ringtone** on the menu. The song is set as your default incoming call ring tone.
3. Or, you may press MENU key to open the option of “ **Use as ringtone**” in the play mode.
- 4.

To check if the song was added as a ring tone

1. Press **HOME**, press **MENU**, and then touch **Settings**.
2. On the Settings screen, touch **Sound > Phone ringtone**. The song should be listed as an option.

Delete music on the storage card

You can delete music files on the storage card.

- 1 On the Music Library screen, touch **Artists**, **Album**, or **Songs**.
- 2 Touch and hold the artist, album, or song you want to delete, then touch **Delete** on the options menu. When prompted, touch **OK**.
- 3 Or, you may press MENU key to open the option of “**Delete**” in the play mode.

Managing Your Phone

Changing Basic Settings

Set the date, time zone, and time

By default, your phone automatically uses the network-provided date, time zone, and time.

To manually adjust the date, time zone, and time

1. Press **HOME**, then press **MENU**, and then touch **Settings**.
2. Scroll down the screen, then touch **Date & time**.
3. Clear the **Automatic** check box.
4. Touch **Set date**. On the Change date window, touch **+** or **-** to adjust the date, month, and
5. year, then touch **Set** when finished.
6. Touch **Set time zone**, then select the time zone in the list. Scroll down the list to view more time zones.
7. Touch **Set time**. On the time window, touch **AM** to change to **PM** or vice versa. Touch **Set** finished.
8. Select the **Use 24-hour format** check box to toggle between using a 12-hour or a 24-hour format.
9. Touch **Select date format** then select how you want dates to display on your phone. The selected date format also applies to the date displayed in the **Clock**.

Note For details on how to set an alarm, refer to **"Using Clock"** on page xx

Display settings

To adjust the screen brightness

1. Press **HOME**, then press **MENU**, and then touch **Settings**.
2. Touch **Display**, scroll down the screen, then touch **Brightness**.
3. Drag the brightness slider to the left to decrease or to the right to increase the screen brightness.
4. Touch **OK**.

To adjust the time before the screen turns off

After a period of inactivity, the phone screen turns off to conserve battery power. You can set the idle time before the screen turns off.

1. Press **HOME**, then press **MENU**, and then touch **Settings**.
2. Touch **Display**.
3. Scroll down the screen, then touch **Screen timeout**.
4. Touch the time before the screen turns off.

Tip To turn off the screen quickly, press the **POWER** key. You can also select "Never timeout" to keep the screen always on unless pressing **POWER** key.

To prevent the screen rotation from automatically changing

By default, the screen rotates automatically depending on how you hold the phone.

1. Press **HOME**, then press **MENU**, and then touch **Settings**.
2. Touch **Display**.
3. Scroll down the screen, then clear the **Auto-rotate screen** check box.

Ringer settings

To change the ring tone

1. Press **HOME**, then press **MENU**, and then touch **Settings**.
2. Touch **Sound > Phone ringtone**.
3. Touch the ring tone you want to use, then touch **OK**. The ring tone briefly plays when selected.

Tip You can use *.wav, *.mid, *.mp3, or other types of sound files that you downloaded from the Internet or copied from your computer as ring tones. To use MP3 as your ringtone, please go to Music Player. Select the song and touch "Use as ringtone".

To choose the notification ring tone

You can select the ring tone to play when your phone receives new notifications.

1. Press **HOME**, then press **MENU**, and then touch **Settings**.
2. Touch **Sound > Notification ringtone**.
3. Select your preferred notification ring tone in the list and then touch **OK**.

To enable touch tones

You can set the phone to play a sound when you are using Dialer phone pad and/or touching the screen.

1. Press **HOME**, then press **MENU**, and then touch **Settings**.
2. Touch **Sound**, then scroll down the screen.
3. Select the **Audible touch tones**, **Audible selection**, **Screen lock sounds** and/or **Haptic feedback** options.

Phone services

Your phone can directly link to the mobile phone network, and enable you to access and change the settings of various phone services for your phone. Phone services may include voicemail, call forwarding, caller ID, call waiting and more. Please contact your service provider to find out the availability of phone services.

To access and change the phone services settings

1. Press **HOME**, then press **MENU**, and then touch **Settings**.
2. Touch **Call settings**.

Note For more information about the phone services on your phone, refer to "Adjusting Phone Settings" on page xx.

To enable data roaming

Data roaming lets you connect to your service provider's partner networks and access data services when you are out of your service provider coverage area.

1. Press **HOME**, then press **MENU**, and then touch **Settings**.
2. Touch **Wireless & networks > Mobile networks**.
3. Select the **Data roaming** option.

Important Accessing data services while roaming may incur significant charges. Inquire the data roaming tariffs with your service provider before enabling data roaming.

Language settings

You can change the operating system language of the phone.

To change the language of the operating system

1. Press **HOME**, then press **MENU**, and then touch **Settings**.
2. Touch **Language & keyboard > Select language** and then select the language you want to use.

Synchronizing your data

To sync with Google service from internet

1. Press **HOME**, then press **MENU**, and then touch **Accounts & sync**.
2. Select **Background data** and **Auto-sync**
3. Sign-in your Google account to sync your Google service.

To sync with PC

You can sync your contact information through the supplied PC sync tool and USB cable

1. Install the PC sync tool's driver before using the sync tool
2. Plug in USB into PC and your phone
3. Follow the instruction shows in PC and start the synchronization

Protecting Your Phone and Personal Data

You can protect your SIM card from unauthorized use by assigning a PIN (personal identification number). Your phone provides several ways to protect your phone by screen lock and SIM card lock. Also, you might protect your SD card by setting password or install encrypted certificates from SD card.

To enable the SIM card PIN

1. Press **HOME**, then press **MENU**, and then touch **Settings**.
2. Touch **Location & security**, scroll down the screen, then touch **Set up SIM card lock**.
3. Select the **Lock SIM card** option.
4. Enter the default SIM card PIN using the keyboard, then touch **OK**.
5. To change the SIM card PIN at any time, touch **Change SIM PIN**.

Tip Emergency calls can be placed at any time without requiring a PIN.

To restore a SIM card that has been locked out

If you enter the wrong PIN more times than the maximum number of attempts allowed, your SIM card will become "PUK-locked." You need a new PUK code to restore access to the device. This code may have been provided by your operator when you received your SIM card.

Touch **Emergency Dial** and enter the following sequence on the keypad: * * 0 5 * [PUK code] * [new PIN] * [new PIN] #

Protect your phone with a screen lock

You can further secure your data by locking the screen and/or requiring a screen unlock pattern, entering PIN or password every time your phone is turned on or every time it wakes up from sleep mode (screen is off). Locking the screen prevents accidental screen touches when the phone is in your bag, purse, or pocket.

To lock the screen

1. Press the **POWER** key to turn off the display.
2. The screen will be locked automatically.

Note To unlock the screen, slide the "Unlock" icon to left to unlock the screen.

To create and enable the screen unlock pattern

You can increase the security of your phone by creating a screen unlock pattern. When enabled, you have to draw the correct unlock pattern on the screen to unlock the phone's control keys and touch screen. Please follow the instruction in the phone and follow the steps to setup the pattern lock.

Important When you fail to draw the correct unlock pattern on the screen after five attempts, you will be prompted to wait for 30 seconds before you can try again. If you forgot your screen unlock pattern, touch **Forgot pattern**. You will be prompted to sign in using your Google Account name and password, and create a new screen unlock pattern before the Home screen displays.

Backup your data

You can backup your data and restore to the original setting in the **Privacy** setting. Your data and settings will be saved in the SD card. Your contact list will be backup in the gmail by sync function.

Managing Memory

To see how much phone memory is available for use

1. Press **HOME**, then press **MENU**, and then touch **Settings**.
2. Scroll down the screen, then touch **SD card & phone storage**. The available phone memory is displayed in the internal phone storage section.

To see the available storage card space

1. Press **HOME**, then press **MENU**, and then touch **Settings**.
2. Scroll down the screen, then touch **SD card & phone storage**. The total and available storage card space display in the **SD card** section.

To clear application cache and data

1. Press **HOME**, then press **MENU**, and then touch **Settings > Applications > Manage applications**.
2. In the Manage applications list, touch the application whose cache and/or data you want to delete.

Tip Press **MENU** to bring up sort and filter options.

In the Application info screen, touch **Clear data** and/or **Clear cache**.

To uninstall applications

You cannot uninstall applications that are preinstalled on the phone.

1. Press **HOME**, then press **MENU**, and then touch **Settings > Applications > Manage applications**.
2. On the Manage applications screen, touch the application you want to uninstall.
3. On the Application info screen, touch **Uninstall**.

To free up more phone memory or storage card space

If your phone is running low on memory, you can try the following:

- In Browser, clear all temporary Internet files and Browser history information. Refer to **"Using Browser"** on page xx for more details.
- Move the applications to SD card if the select specific application support.

Resetting the Phone

Resetting the phone deletes all data, including downloaded applications, and resets the phone back to its initial state—the state before you turned on the phone for the first time.

Important Make sure to back up important data you have on the phone before you perform a factory data reset.

To reset the phone

1. Press **HOME**, then press **MENU**, and then touch **Settings**.
2. Scroll down the screen, then touch **"Privacy"**.
3. Navigate to the Internal phone storage section, then touch **Factory data reset**.
4. On the Factory data reset screen, touch **Reset phone**. If prompted, enter your screen unlock pattern, then touch **Erase everything**.

Warning! **Factory data reset will erase your Google account information, system and application data and settings, and downloaded applications. Please always backup the important data before resetting.**

To know how to backup the phonebook, please refer to "Phonebook" on page xx for more details.

Tip If your phone hangs or freezes, remove the battery, then wait for a few seconds, and then re-install it. After re-installing the battery, turn on the phone.