



Tentative User Manual V0.1.0

Stretched TFT-LCD Display

Model

VIA P650IVF01.0

VIA Technologies, Inc.

1F, 531 Zhongzheng Rd.,
Xindian Dist. New Taipei City

– 231, Taiwan, R.O.C

Index

Important Product Safety Instructions	1
Safety Precautions and Maintenance	1
To reduce the risk of electric shock or damage to the equipment	2
Declaration of Conformity.....	2
IMPORTANT NOTE.....	2
Federal Communications Commission (FCC) Statement.....	2
Overloading Outlets	3
Other Notices and Precautions	3
Proper Positioning of Display	3
Ventilation	4
Cleaning.....	4
Power Cord Protection	4
Introduction.....	5
Functions and Features	5
Package Content.....	6
Product Overview	6
Connections	7
Firmware Upgrade by Inserting USB Stick.....	7
Connect Signal Cables.....	8
Control Panel.....	8
Installation	9
Install Remote Control Batteries.....	9
Using the Remote Control.....	10
The OSD Functions	11
INPUT SOURCE	11
PICTURE	12
SETUP	12
More Information	13
Supported Timing Mode.....	13
Input Video Pattern Guideline	14
Product Specification	15
Dimensions	17
Other Notices.....	18
Operation and Maintenance Guide	18
MagicView User Guide.....	27
BIOS Setup.....	70



Important Product Safety Instructions



Use for control, adjustments, or procedures other than those specified in this document may result in exposure to shock, electrical hazard and/or mechanical hazards.



Use this product in environments with ambient temperatures of 0°C ~50°C. Do not leave this product in an environment where the storage temperature is below -40° C or above 110° C. The product must be used in a controlled environment.



WARNING

- Do not use this product near water or a heat source.
- Do not spill water or any other liquids on this product.
- Do not place heavy objects on the top of this product.

Safety Precautions and Maintenance

- Read carefully and follow all warnings and instructions in this document and those marked on the product before you operate your display. Failure to follow warnings can result in personal injury or damage to product. Keep this document in a convenient location for future reference.
- This product should be operated from the type of power indicated on the marked label. The attached AC adapter is designed for use with this product.
- To use a different ac adapter, use only a power source and connection compatible with this product. If you are not sure of the type of power available, consult your dealer or local power company.
- An approved power cord greater or equal to H03VV-F or H05VV-F 3G, 0.75 mm² or 18AWG must be used.
- This device must be operated with the original power supply.
- The socket-outlet should be installed near the equipment and should be easily accessible.
- Use a power cable that is properly grounded. Always use the appropriate AC cord that is certified for the individual country. Some examples are listed in below table:

Country	Safety Certificate
USA	UL
Switzerland	SEV
Canada	CSA
Germany	VDE
Britain	BASE/BS
Japan	Electric Appliance Control Act

- Do not place inflammables/volatile matter/liquids near by the product.

To reduce the risk of electric shock or damage to the equipment

- Do not disable the power cord grounding plug. The grounding plug is an important safety feature.

- Plug the power cord into a grounded (earthed) electrical outlet that is easily accessible at all times.
- Disconnect power from the equipment by unplugging the power cord from the electrical outlet.
- Do not place anything on power cords or cables. Arrange them so that no one may accidentally step on or trip over them.
- Do not pull on a cord or cable.
- Always grasp the cord by the plug, while unplugging from the electrical outlet.
- Always plug in the DC connector first, then plug in the AC connector.

Declaration of Conformity

FCC Part 15.19 Caution:

1. This device complies with Part 15 of the FCC Rules. Operation is subject to the following two conditions:

- (1) this device may not cause harmful interference and
- (2) this device must accept any interference received, including interference that may cause undesired operation

2. This device and its antenna(s) must not be co-located or operating in conjunction with any other antenna or transmitter.

3. Changes or modifications to this unit not expressly approved by the party responsible for compliance could void the user authority to operate the equipment.

IMPORTANT NOTE

FCC Radiation Exposure Statement:

This equipment complies with FCC radiation exposure limits set forth for an uncontrolled environment. This equipment should be installed and operated with minimum distance 20cm between the radiator & your body.

Federal Communications Commission (FCC) Statement

This equipment has been tested and found to comply with the limits for a class B digital device, pursuant to Part 15 of the FCC Rules. These limits are designed to provide reasonable protection against harmful interference in a residential installation. This equipment generates uses and can radiate radio frequency energy and, if not installed and used in accordance with the instructions, may cause harmful interference to radio communications. However, there is no guarantee that interference will not occur in a particular installation. If this equipment does cause harmful interference to radio or television reception, which can be determined by turning the equipment off and on, the user is encouraged to try to correct the

interference by one or more of the following measures:

- Reorient or relocate the receiving antenna.
- Increase the separation between the equipment and receiver.
- Connect the equipment into an outlet on a circuit different from that to which the receiver is connected.
- Consult the dealer or an experienced radio/TV technician for help.

Overloading Outlets

Do not overload electrical power sources when installing the display. Overloading wall outlets, circuits, or extension cords can result in overheating, fire, or electric shock. Use only grounded or polarized outlets.

Other Notices and Precautions

- Never remove the rear cover. There are no user serviceable parts inside. Your display contains high-voltage parts. You may be seriously injured if you touch them.
- Do not attempt repairs yourself. Your warranty does not cover repairs or attempted repairs by anyone not authorized by VIA.
- Refer all servicing and repairs to qualified service personnel.
- If smoke, abnormal noise or strange odor is present, immediately unplug the power cord. Contact a qualified service technician.
- If your display will not be used for extended periods of time, unplug the power cord and remove the batteries from the remote control.
- Do not scratch the surface of the display with any sharp objection.

Proper Positioning of Display

- Always handle your display with care. Avoid touching the screen. Skin oils are difficult to remove.
- Always position your display on a stable and level surface or mount it on a wall. Unstable surfaces can cause your display to topple and fall, resulting in possible damage or injury.
- Avoid exposing the display to direct sunlight or high temperatures, which can damage or shorten its useful life.
- Do not place near heat sources such as radiators, heat registers, or other appliances that generate heat.
- Avoid exposing the display to rain, water, moisture or high humidity.
- Do not place your display near basins or sinks where it may come in contact with water.
- Orient your display s away from direct sunlight to reduce glare.
- Never place heavy or sharp objects on the display, video cable, or power cord.

Ventilation

- Slots and openings on the cabinet are provided for ventilation purposes. To ensure reliable operation of the product and to protect it from overheating, these openings must not be blocked or covered.
- Keep the display a minimum of 4 inches/10 cm away from any wall to assure sufficient airflow and ventilation. Increased temperatures may cause fire or device failure.
- To assure proper ventilation, do not block the openings by placing the display on a bed, sofa, rug or other similar surface. Do not place it in a built-in installation, such as a bookcase or an enclosed rack, unless proper ventilation is provided.

Cleaning

Make sure the display is turned off and never spray or pour liquid directly onto the screen or case.

- **To clean the screen:**
 - Wipe the screen with a clean, soft, lint-free cloth. This removes dust and other particles.
 - If it still is not clean, apply a small amount of non-ammonia, non-alcohol based glass cleaner onto a clean, soft, lint-free cloth, and wipe the screen.
- **To clean the enclosure:**
 - Use a soft, dry cloth.
 - If it still is not clean, apply a small amount of non-ammonia, non-alcohol based, mild non-abrasive detergent onto a clean, soft, lint-free cloth, then wipe the surface.

Disclaimer

VIA does not recommend the use of any ammonia or alcohol-based cleaners on the display screen. Some chemical cleaners have been reported to damage the screen and/or display signage box. VIA will not be liable for damage resulting from use of any ammonia or alcohol-based cleaners.

Power Cord Protection

- Minimize wear on power supply cords. Power supply cords should be routed away from foot traffic and contact with other objects.
- Do not route power cord under rugs or carpeting.
- The cord should never be severely bent, pinched, or twisted.
- Periodically inspect power cords for wear or damage, particularly near plug and the point where it exits from the product.
- Unplug cord and discontinue use if damage is discovered.

IMPORTANT NOTICE CONCERNING POWER CORD SELECTION

The power cord set for this unit has been enclosed and has been selected according to the country of destination and must be used to prevent electric shock. Use the following guidelines if it is necessary to replace the original cord set, or if the cord set is not enclosed.

The female receptacle of the cord set must meet IEC-60320 requirements and may look like this:



Introduction

This manual will explain the operation of P650IVF01.0, including functions, features and other important information. Before installing or operation your display, please take time to read the manual, particular the sections on safety.

Functions and Features

- 1920 x 376 image resolution
- 450 nits brightness
- 4000:1 contrast ratio
- LED backlight source
- VGA, Video Graphics Array
- DVI, Digital Visual Interface
- HDMI digital, high –definition multimedia interface
- USB flash disk for monitor firmware upgrade

Package Content

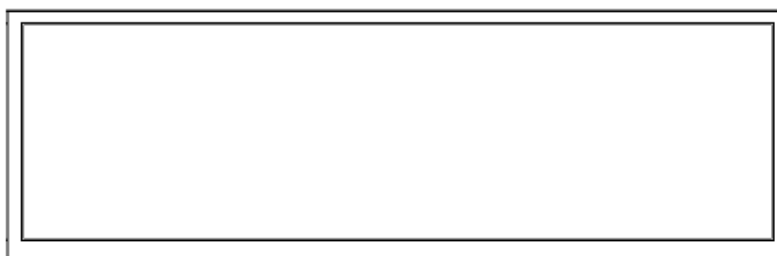

LCD Display

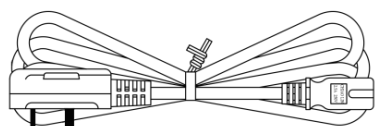

Power Cord

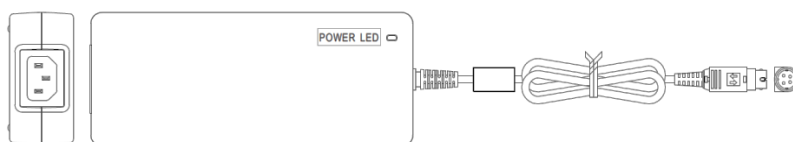

Adapter

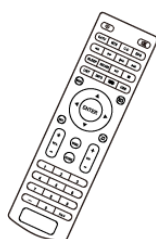

Remote Controller

Product Overview

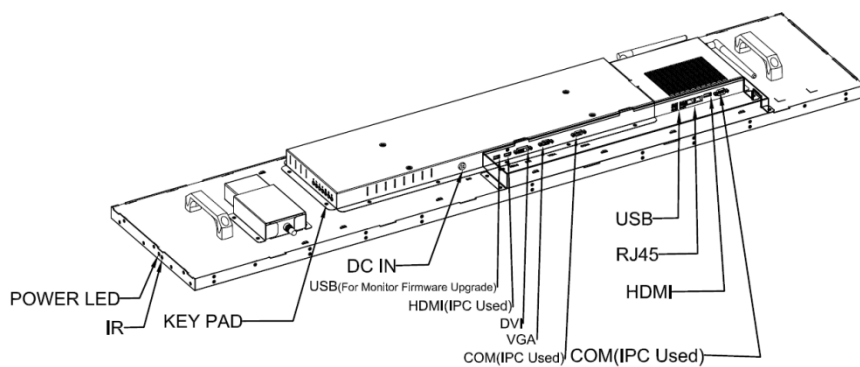
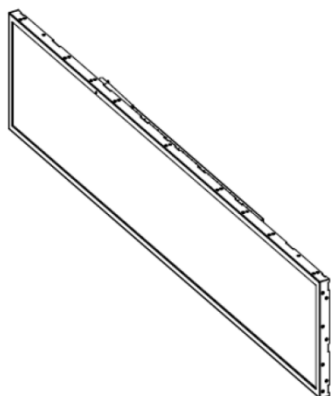

Connections

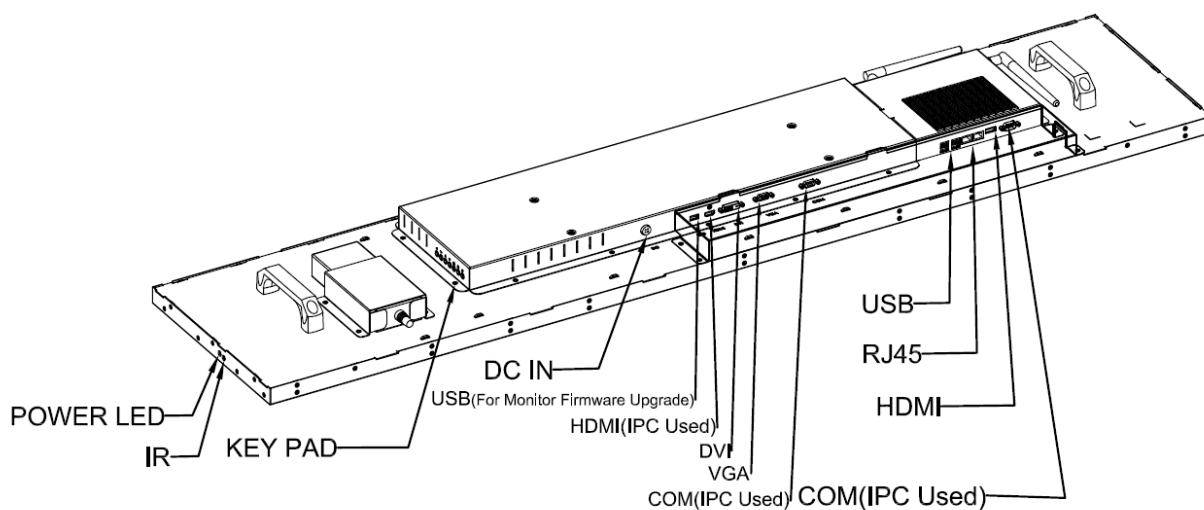

Firmware Upgrade by Inserting USB Stick

You can upgrade the monitor firmware by the steps as follows:

1. Select a empty USB stick, and copy the firmware file (M57ML2DGI81**.bin) into the root in USBstick.
2. Turn on the monitor, select VGA or DVI or HDMI input, plugging in the USB stick.
3. Enter OSD menu, and select software update item.





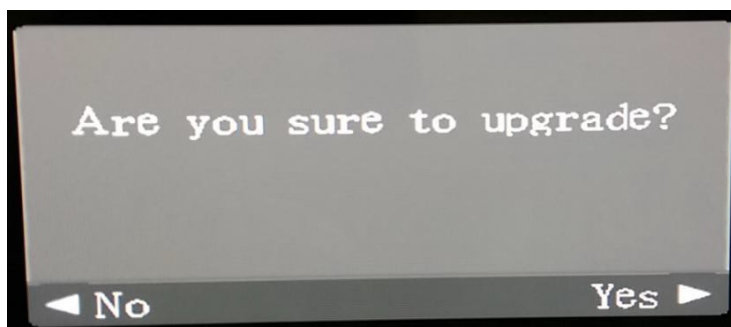



4. Select "Yes" to upgrade.

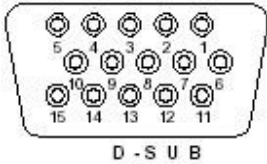



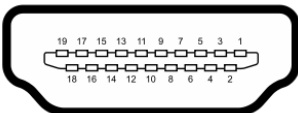

Connect Signal Cables

The connection between the signal source and the display is:

Signal Source	Description	Connection Cable
D-Sub (15-pin) Cable		 <p>Note: This cable is not including in the accessory.</p>
DVI Cable		 <p>Note: This cable is not including in the accessory.</p>
HDMI		 <p>Note: This cable is not including in the accessory.</p>

Control Panel

Item	Function
	Power
EXIT	OSD Exit
MENU	Menu
	Left
	Right
	Down
	Up

Installation

Install Remote Control Batteries

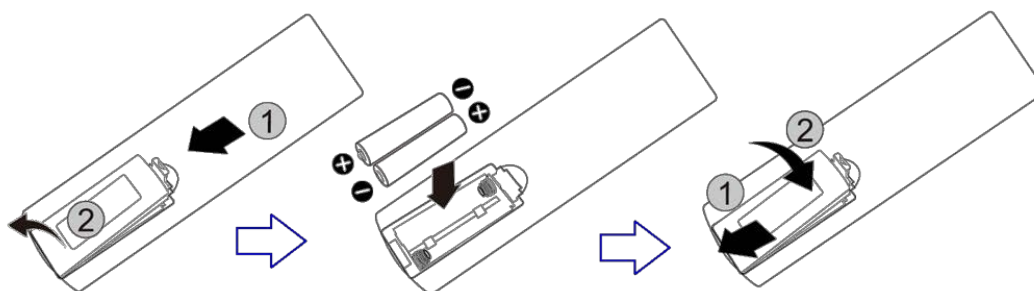

Remove the battery cover.

Install batteries.















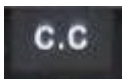

Re-attached the batter support.

Note:AAA batteries need to be purchased by the customers.



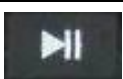













CAUTION

- Dispose of the battery in accordance with local laws and regulations.
- Keep the battery away from children and pets.
- When the remote control will not be used for an extended period, remove the batteries.

Using the Remote Control

Keypad	Function
	Switch power on or power off
	No support
	No support
	No support
	No support
	No support
	No support
	No support
	No support
	No support
	No support
	No support
	No support
	No support
	No support
	information
	Zoom mode setting

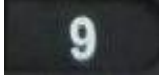

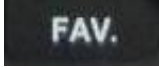
	No support
	Enter setup menu
	Input source setting (Support only for HDMI/VGA/DVI)
	Exit
	No support
	UP
	Left
	Right
	Down
	Enter
	No support
	No support
	No support
	Image mode setting (Support only for HDMI/VGA/DVI)
 	No support
	No support
	No support

The OSD Functions

INPUT SOURCE

Item	Selection	Description
Input Source	HDMI DVI VGA	To select the input signal source.

PICTURE

(Press  to enter Setup page; press  to enter USB page; press  for each item selecting)

Item	Selection	Description
Picture Mode (Support only for HDMI/VGA/DVI) Note: Sharpness, Saturation & Hue and Color can be selected only for video signal	Standard	To select the type of preset picture mode that suit your personal preference or viewing requirement.
	Dynamic	
	Soft	
	Personal	To manual configure following picture setting to suit your personal preference or viewing requirement.
	Contrast	To adjust the contrast level of picture.
	Brightness	To adjust the brightness level of picture.
	Sharpness	To adjust the edge definition of picture.
Color Mode	Hue	To adjust the color hue of picture.
	Saturation	To adjust the color saturation of picture.
	Cool	Color temperature adjustment, you can select cool mode/Normal mode/warm mode/User mode.
	Normal	
Warm		
User		
Auto Adjust (Only for input source is set to VGA)	H-Pos.	To manually adjust the position of display area left or right.
	V-Pos.	To manually adjust the position of display area up or down.
	Clock	To manually adjust the width of display image.
	Phase	To manually sharpen the focus of text or graphic with pixel boundaries.
	Auto	To automatically adjust incoming VGA signal to optimal status for displaying.

Zoom Mode	Full	Set the picture to Full screen.
	Zoom	Set the picture to Zoom mode, for set the display bar position (Top area, Middle Area, Bottom Area.),
	4:3	Set the picture to 4:3 format and put black borders on the left and right of picture.
	16:9	Set the picture to 16: 9 format and put black borders on the left and right of picture.
Backlight	0~100	To adjust the brightness of LED backlight.

SETUP

Item	Selection	Description
Menu Language	English, Chinese Traditional, Chinese Simplified	To select menu displaying language.
SW Version		FW Version
Restore Default	Yes No	To restore all setting of menu to default factory setting.
Auto Wake-up	On Off	
Software Update(USB)	Yes No	To proceed software update via USB driver (Only available for authorized technician).

More Information

Supported Timing Mode

The supported timing modes for VGA signal / HDMI signal are:

Timing Mode	Resolution
VGA	640x480@60Hz 640x480@72Hz 640x480@75Hz
SVGA	800x600@56Hz 800x600@60Hz 800x600@72Hz 800x600@75Hz
XGA	1024x768@60Hz 1024x768@70Hz 1024x768@75Hz
SXGA	1152x864@75Hz 1280x1024@60Hz 1280x1024@75Hz
WXGA	1366x768@60Hz
	1440x900@60Hz
WSXGA+	1680x1050@60Hz
SD	NTSC 480i NTSC 480p
HD	NTSC 720p
Full HD	1080i 1080p

Input Video Pattern Guideline

- Please select FHD pattern and input FHD video signal to the monitor.
- Please allocate the display content such as video/photo on the top area.

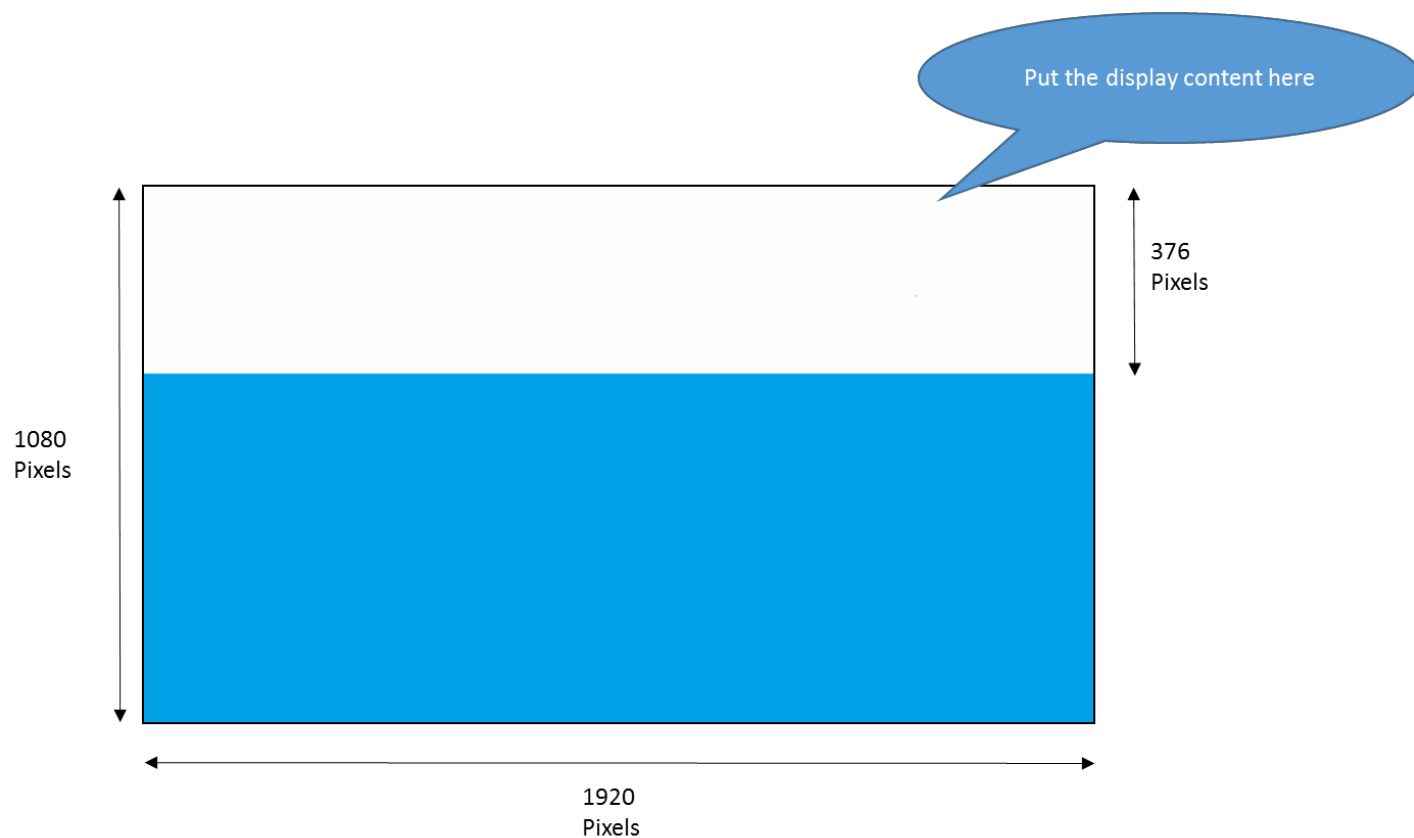

Note: It will be better to input 10 bits signal into the monitor.

Product Specification

	Model	P650IVF01.0
Panel	LCD Size	65"
	LCD Vendor	VIA
	Light Source	LED
	Active Area (mm)	1428.5±1(H) x280±1(V) mm
	Resolution	Special format (1920x376)
	Aspect Ratio	16:3.13
	Brightness (typ)	450 cd/m ²
	Contrast Ratio (typ.)	4000:1
	Response Time (ms)	8 (Typ)
	Frame Rate	60
	Viewing Angle	178 degree (H) / 178 degree (V) with CR ≥ 10
	Light Life	100,000 hrs
	Panel Surface	Anti-Glare, 3H, Haze = 2%
	Color gamut (x% NTSC)	72%
Power	Power supply	AC 100V~240V (50/60Hz)
	DC Input	24V , 6.67 A
	Power consumption (Watt)	≤ 100W (w/o IPC , WiFi)
	Standby Power (Watt)	<0.5W(w/o IPC , WiFi)
Display	IPC IOry	HDMI X 1(IPC Used)/ COM(IPC Used) X 1/ RJ45 X 2/ USB X 4
	Monitor IO	HDMI X 1(IPC Used)/ DVI-D X 1/ VGA X 1/ USB X 1/ COM X 1(IPC Used)
	Audio	-
	Audio W (Amp)	-
	Control	RS232, Keypad and Remote Controller
	Dimension (Lx W x D mm)	1464.5±2 x 316±2 x 60±1(Without Adaptor) mm
	Weight	16.1±0.5 kg
	Border width (U/D/R/L)	16.0/16.0/16.0/16.0 mm
	OSD Control	IR
	OSD Language	繁體中文 / 简体中文 / English
	Wall Mounting	400mmX100mm
	Color	Black
	Display Orientation	Landscape / Portrait (Except OSD)
Packing	Package size (W x H x D)	1642 ±1 (W) x 450 ±1 (H) x 226±1 (D) mm
	Package weight	23.3±1 kg
	AC Adapter	X 1, including AC in power cable (UK Type)

Accessory	Remote Controller	X 1 , w/o battery
	HDMI Cable	X 1
	RS-232 Cable	X 1, (male to female, Tx/Rx non-swap)
	IPC Main Board	X 1 including installed OS inside, Fixed to FHD output on HDMI out
	IPC Main Board Cover	X 1
	Power Wire for IPC	X 1
	WiFi Antenna	X 2, including wire
	Left WiFi Cover	X 1
	HDMI/RS-232 Cover	X 1

Dimensions

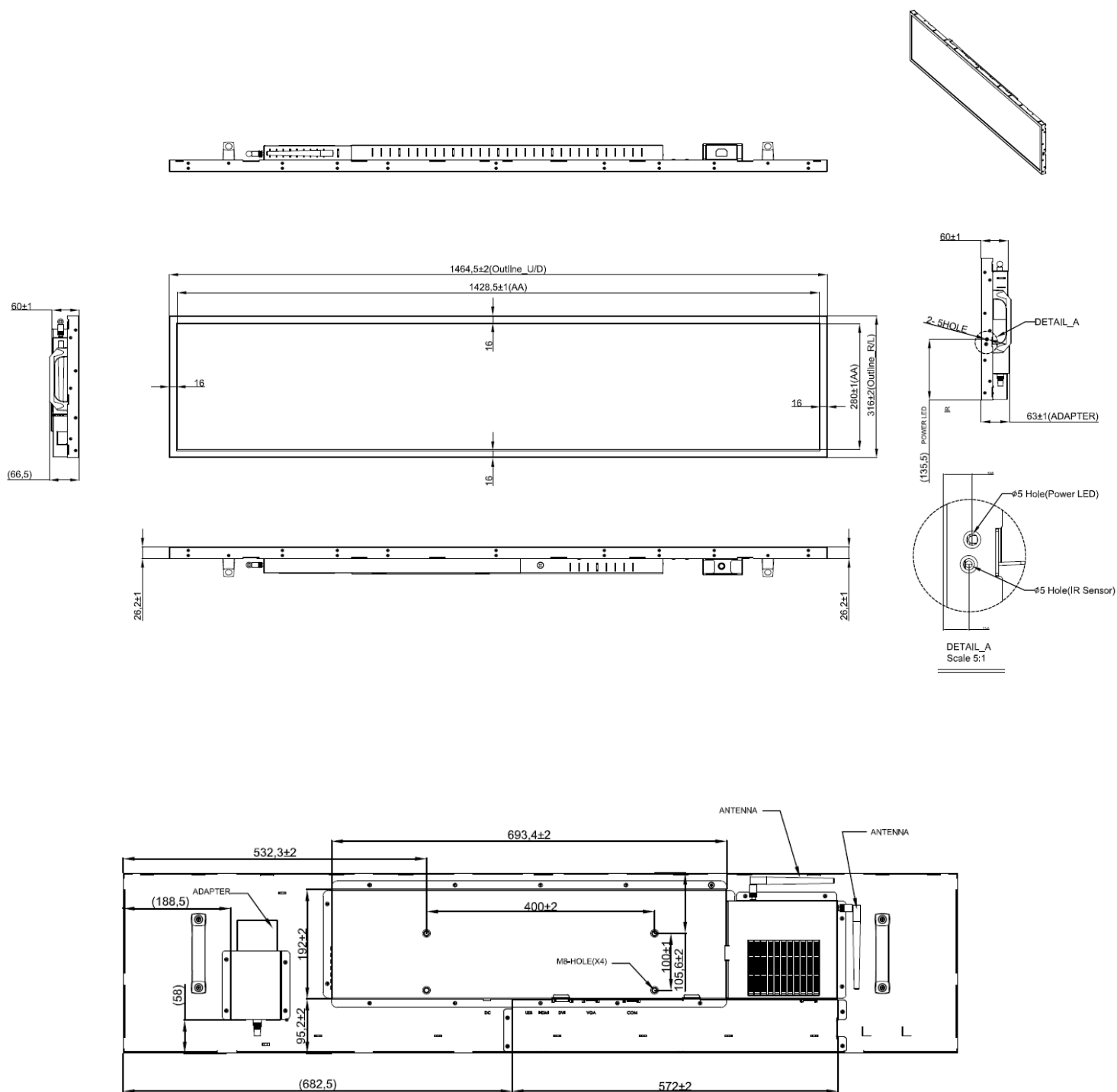

Other Notices

- The display is able to remember the last input source before it is turned off by control panel. Next time when you turn on the display, it will present the last file via the last input directly. If the previous input source has been removed, you need to switch to the new input source manually.
- If a regular image is displayed on the displayed screen for a long period of time, it might occur “imprint”, which may result to permanent defected images on the screen. This is called screen burn-in or imprint, thus this specific issue is not covered within the guarantee scope.
- If the proportional selection’ display screen for a long period of time is 4:3, screen burn-in may appear at the black and image of the screen.
- In order to prevent the occurrence of residual shadow, avoid to display a regular image for a long period of time on the display screen (TFT-LCD more than two hours, Plasma display panel more than one hour)
- Avoid stationary images as much as possible. Stationary images are images that remain onscreen for extended periods of time. Stationary images include onscreen menus, black bars, time displays, etc.
- Please plug in only one source. If multiple source (i.e.VGA/DVI/HDMI & USB stick) are plugged into the I/P ports, the system might be unstable.

Operation and Maintenance Guide

Before Getting Started

- This product is a highly integrated product featuring a LCD and IPC, with building Windows I0 IoT 64bit operating system and VIA MagicView software. Relevant OS configurations have been made in advance so that when you receive the product, simply connect it to power and the system will automatically run the startup process and MagicView Client.
- When you turn on the product for the first time, you will be asked to make a few simple settings in order to fully activate the product and have it connected to the Digital Signage Monitoring System Server to commence online operation. And as such, it is recommended that you complete the following settings before installing the LCD Panel at the designated premise.



I. Connect to keyboard and mouse

USB ports(IPC) are available at the back of the LCD Panel for keyboard and mouse to be connected. The USB ports(IPC) is next to the RJ45 port.

2. Starting up

When the LCD is connected to power, it will automatically run the startup program and show the default logo screen. Please press Ctrl+Q to return to OS desktop.

3. Network configuration

- a. Press  on the keyboard and select  (Settings)
- b. Select "Network and Internet"
- c. Select "Wi-Fi"
- d. Make sure your Wi-Fi is activated
- e. Select "Show available networks"
- f. A list of Wi-Fi networks available will pop up at the lower right of the screen; select your Wi-Fi network to be connected

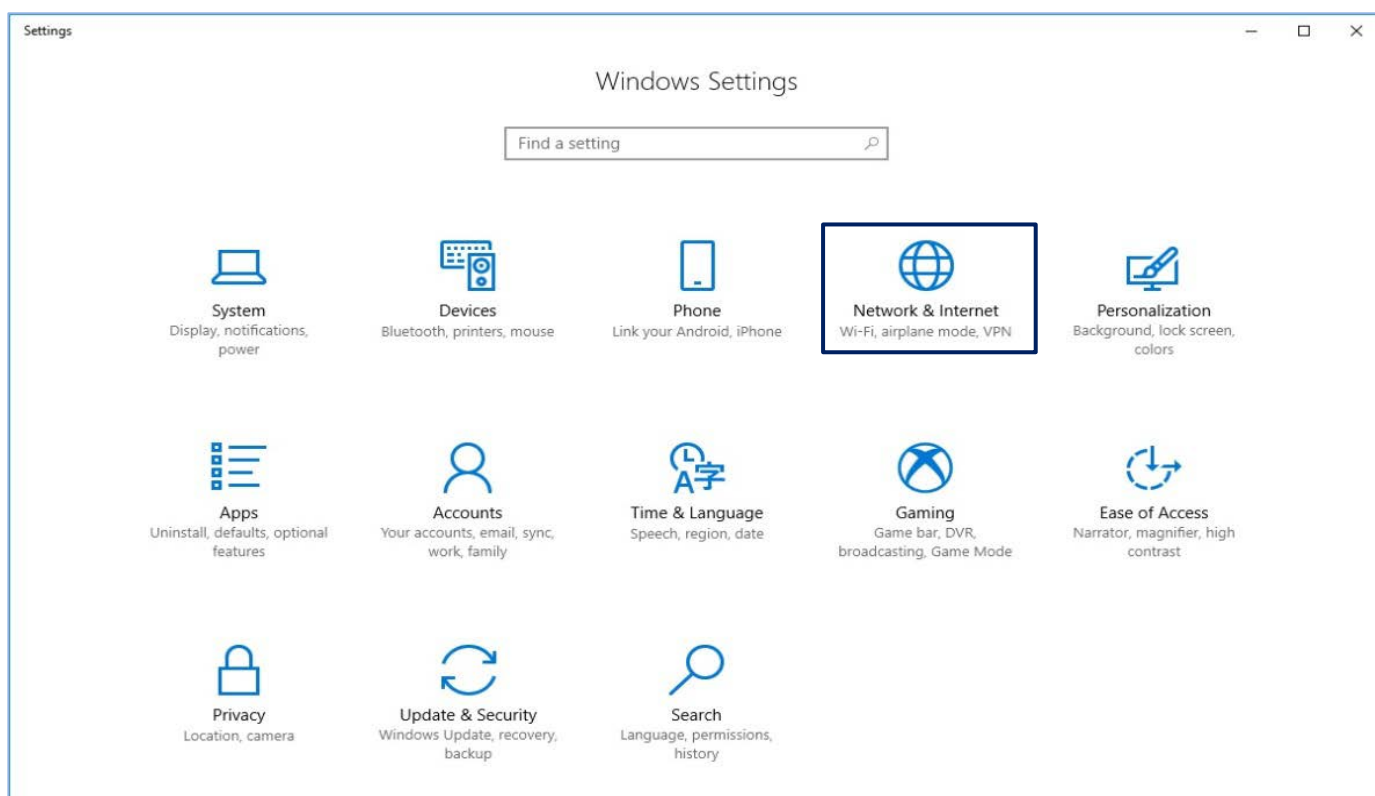

Note: For Wi-Fi connections involving specific settings (i.e. security verification, connection to hidden SSID and so forth), relevant IT specifications will apply.

Please have your IT personnel to resolve relevant connection issues.

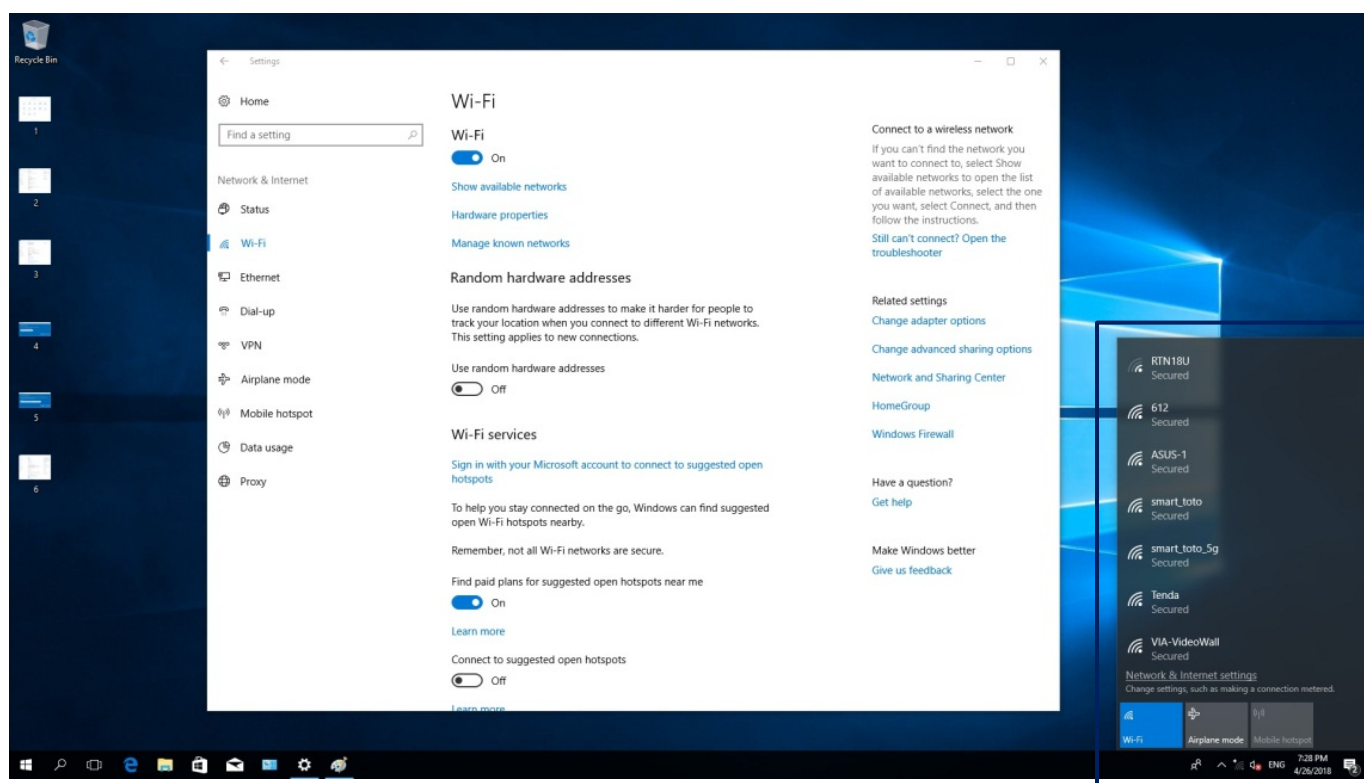
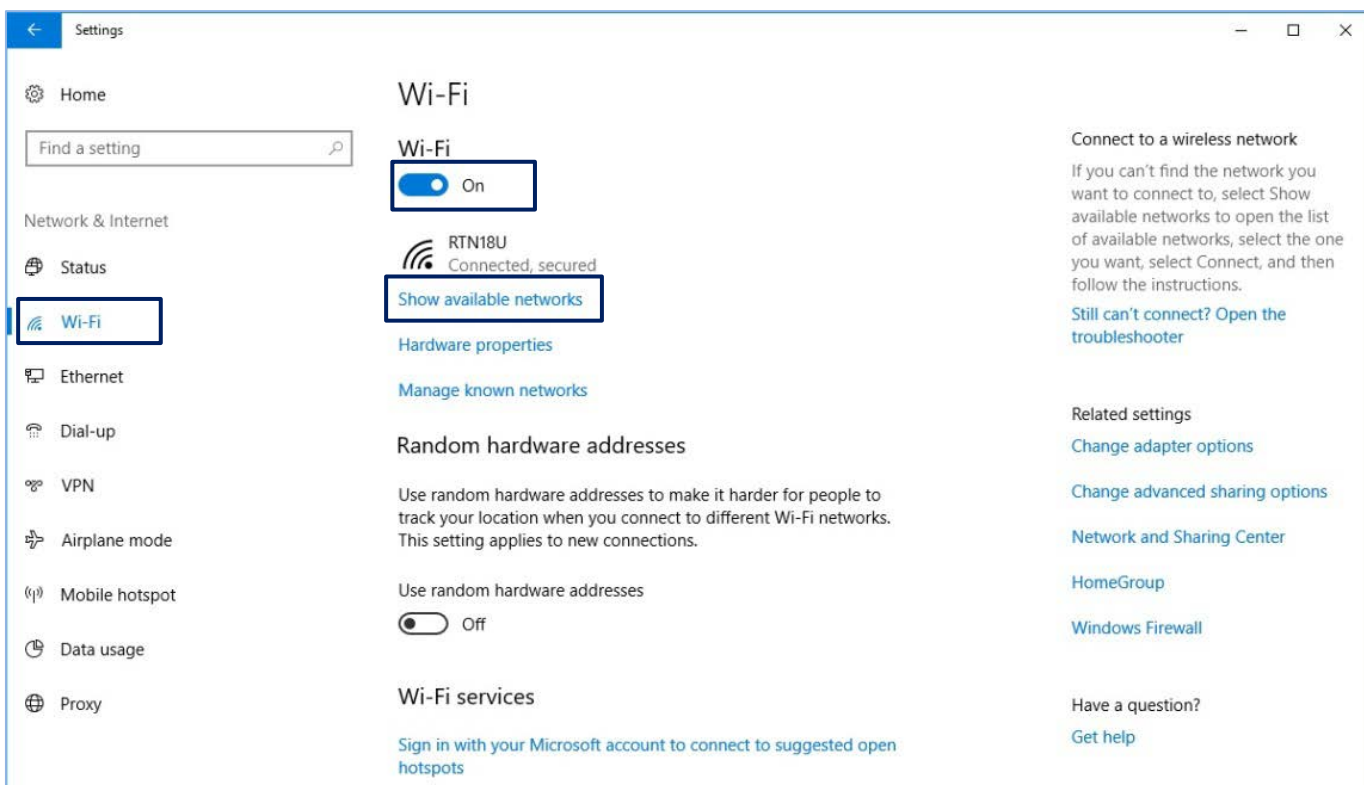



4. Starting Windows / Renaming the computer

- a. Press  on the keyboard and select  (Settings)
- b. Select "System"

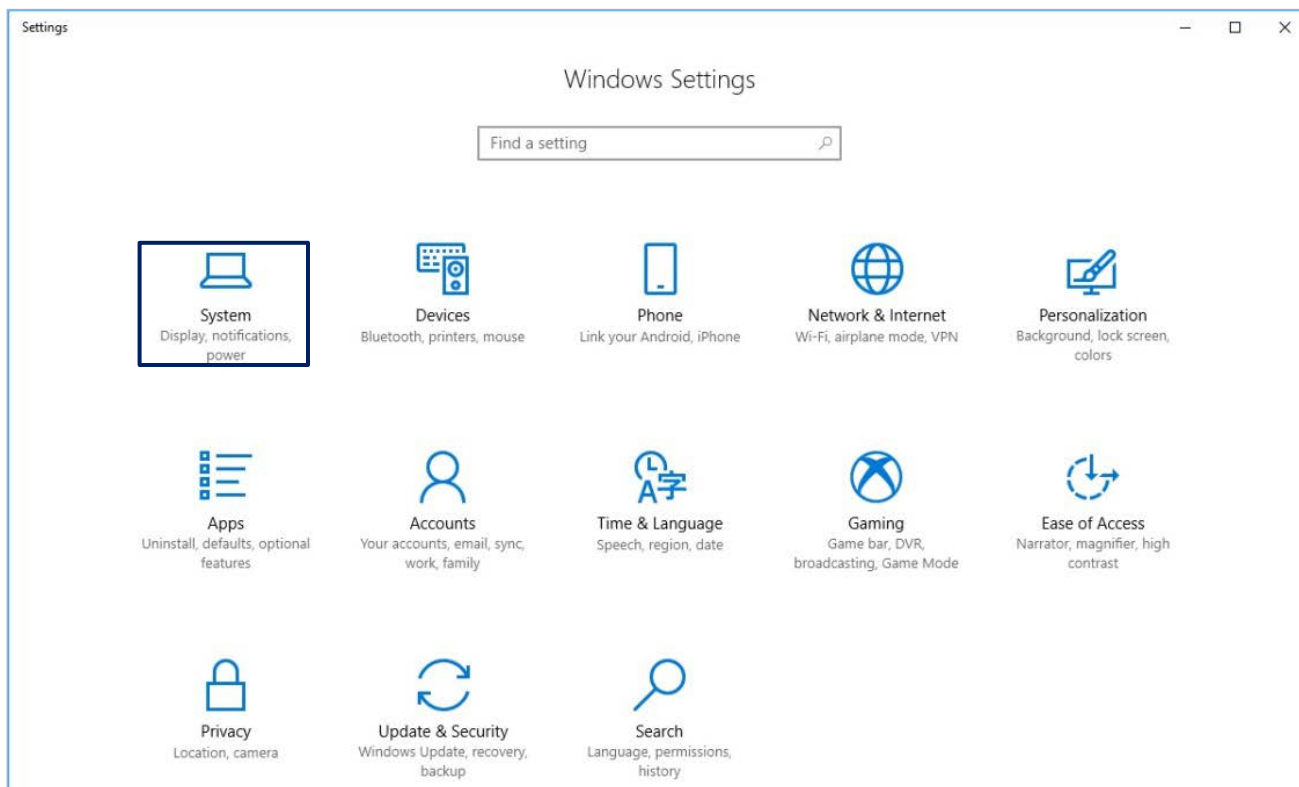

c. Click "About"

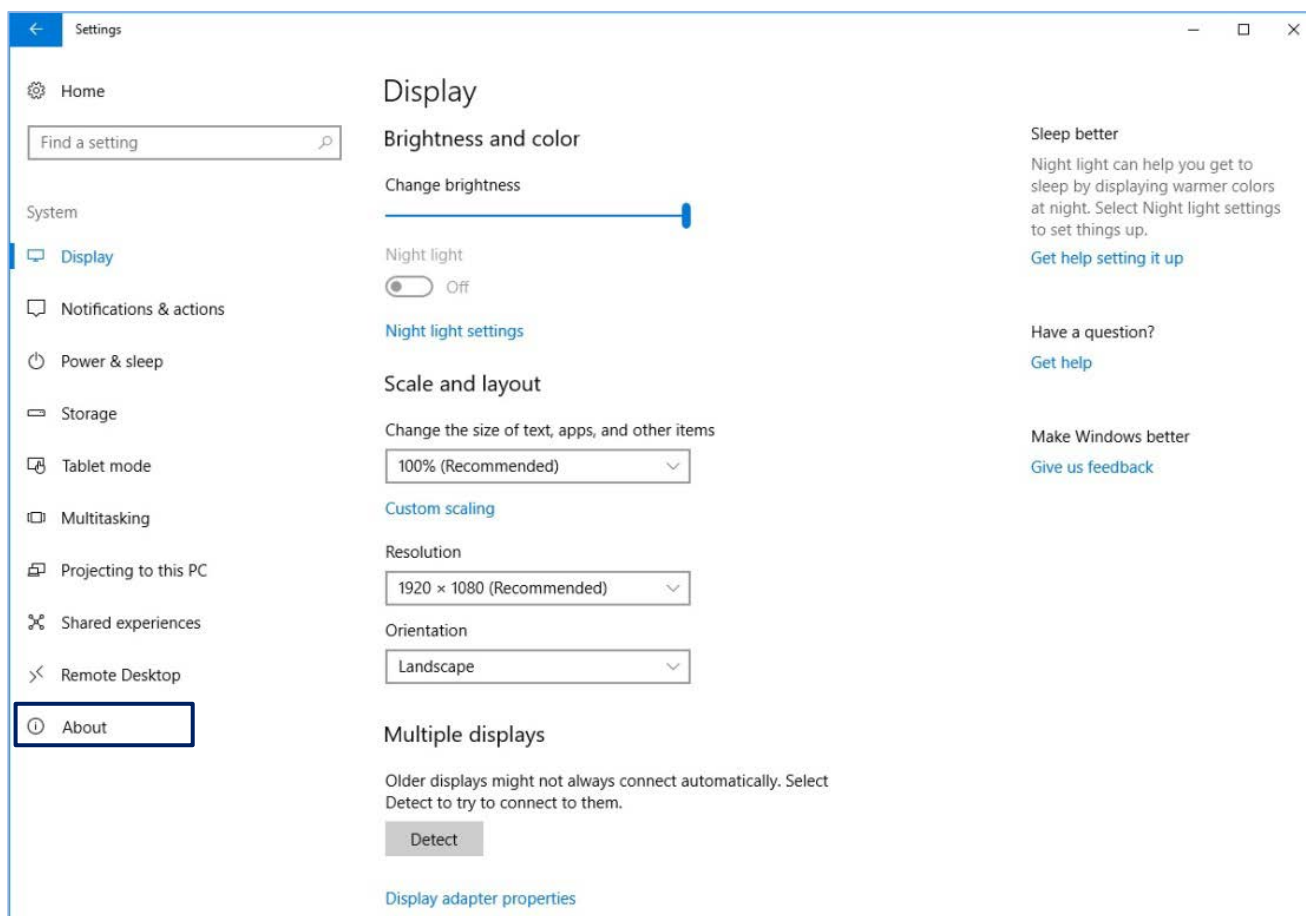

- d. Click “Renaming the computer” to change the name of the computer; click “Change product key or upgrade your edition of Windows” to enter product key

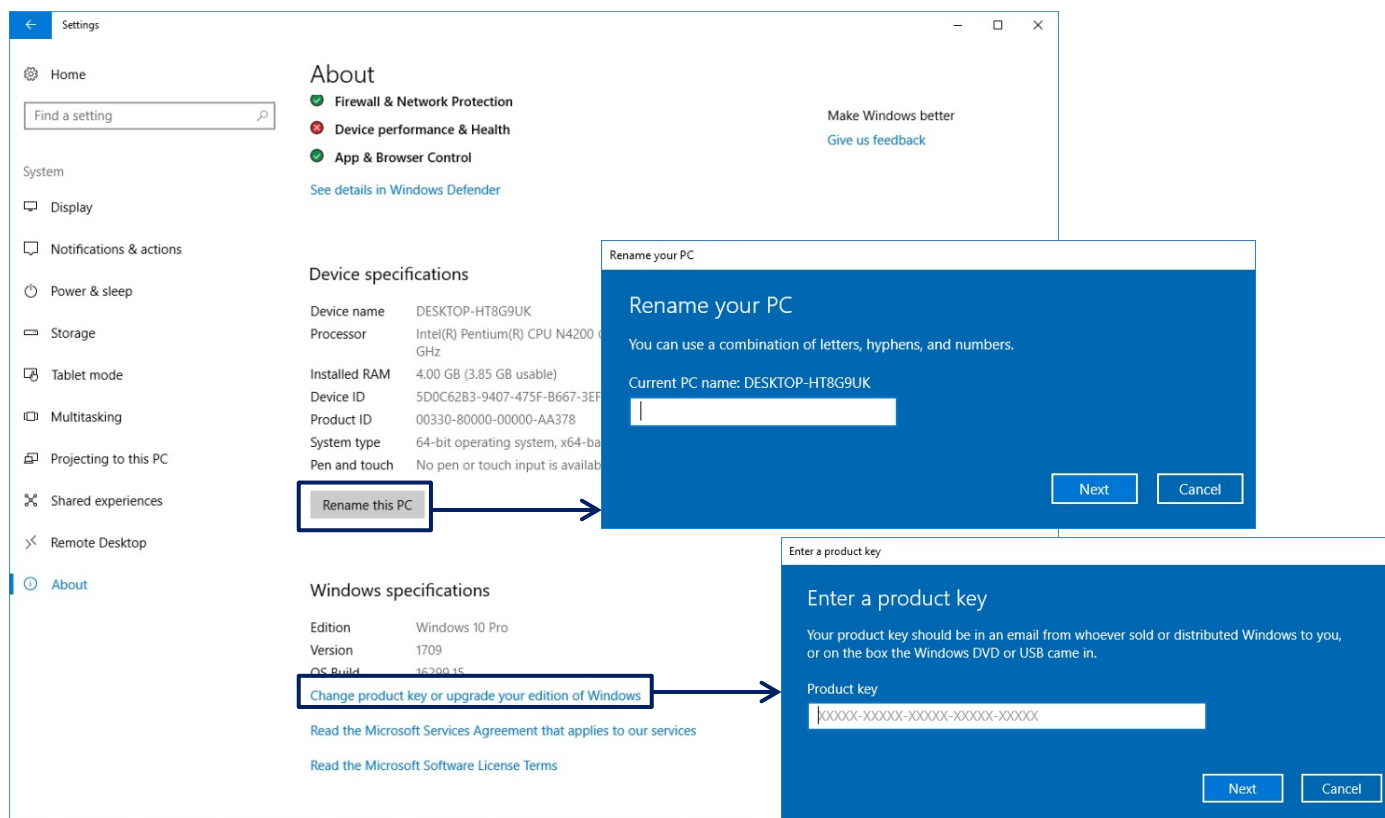

- e. Once you have entered the correct key, Windows will be activated
- f. Once Windows has been activated, it will be bound to the H/W and the key you have used. It is therefore recommended that you put the sticker of the key on the back of the LCD so that you can easily locate it when you need to enter the key again in the future.

5. Registering your MagicView Client on the MagicView Server

- a. Press  on the keyboard → select VIA → select MagicView Client Configure” and you will be taken to the page as shown below:

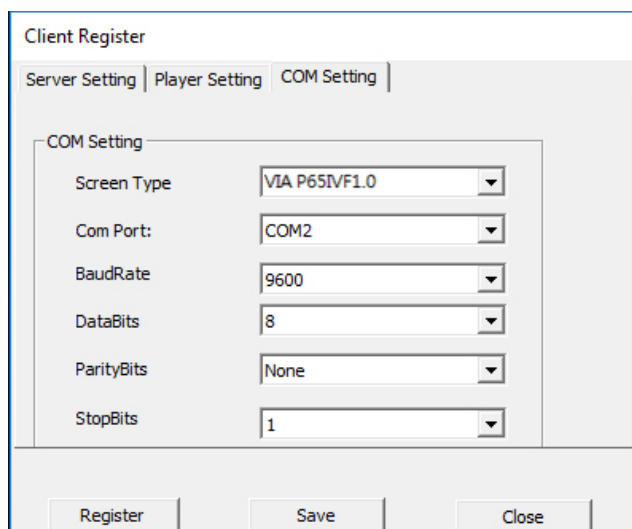



b. COM setting:

1. Screen Type: Refers to below table to select screen type.

LCD Module	Screen Type
VIA P65IVF1.0	VIA P65IVF1.0
VIA P65IVF2.0	VIA P65IVF2.0
VIA VT32LLUM	VIA VT32LLUM
VIA VT55LLUM	VIA VT55LLUM
VIA VT65LLUM	VIA VT65LLUM

c. Player setting

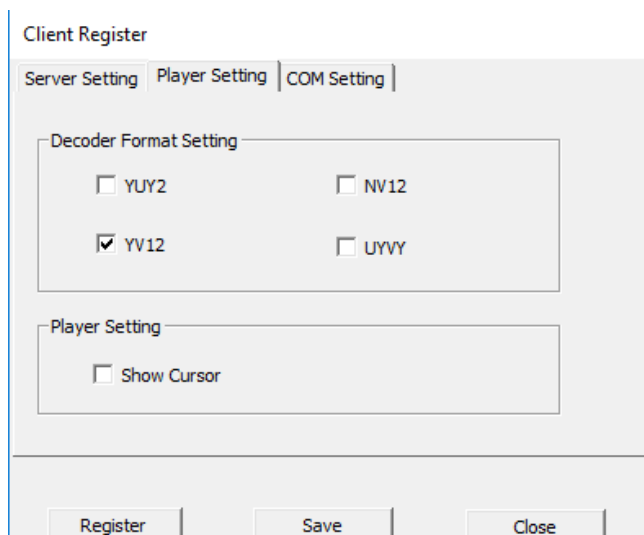
1. Decoder format setting: simply check the YV12 box.



d. Server Setting

1. Client Hardware ID: this cannot be changed (this ID can be used for offline registration in the UI)
2. Server Address: enter the Server IP
3. User name: admin
4. Password: admin
5. Client Name: assign different client name for different LCD panels in order to ensure easy identification in MagicView
6. Click “Save”
7. Click “Register Client”
8. When you see “Register Succeed “(The setting has been saved!),”click “Ok”.
9. Click “Close”

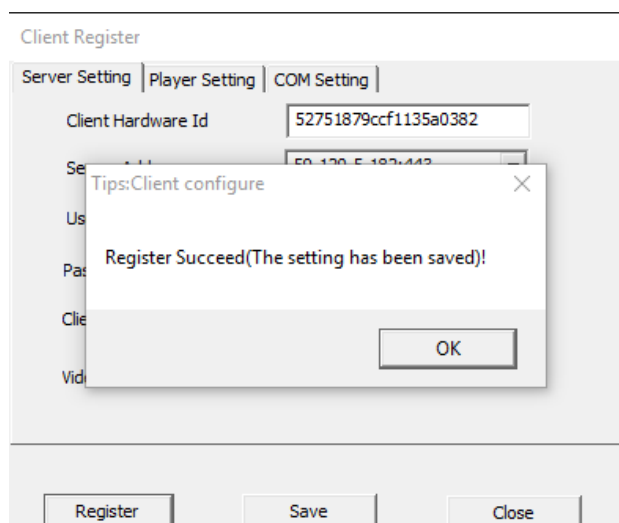

6. Running MagicView Client

Press  on the keyboard → select VIA → select MagicView Client”.

This will get the MagicView Client running officially and when you restart the system, it will automatically run MagicView Client and try to connect to the Server.



Notice: Regarding powering off

- As the IPC in the LCD shares the same power with the LCD's power board, the only way to turn off IPC (i.e. windows shutdown) while LCD power is on is to unplug the power cord from the LCD and plug the power cord back to restart IPC.
- If the windows system freezes during operation, please unplug the power cord from the LCD and plug it back in to restart the IPC.
- Turning the LCD off directly without shutting down the IPC first may damage the windows system. And as such, if you wish to turn off the LCD for purposes of disassembly, be sure to perform the shutdown process for windows.
- Procedure to turn off the Windows:
 - Press Ctrl+Q to return to OS desktop, right-click the Start button, you'll see a lengthy pop-up

shortcut menu -- with "Shut down or sign out" right near the bottom. Mouse over that option and then click "Shut down."

- If you wish to restart IPC but find it difficult to unplug the power cord when the LCD is installed in a suspended configuration, simply restart the relay of the power supply to restart IPC.

MagicView User Guide

The MagicView featured for this product has been custom designed by VIA for Hong Kong International Airport. The following contents are only meant as a reference for users to familiarize themselves with the various features of MagicView. For official SOPs, please refer to the definitions provided by C&R.

Playlist Publish

Upload Media Files

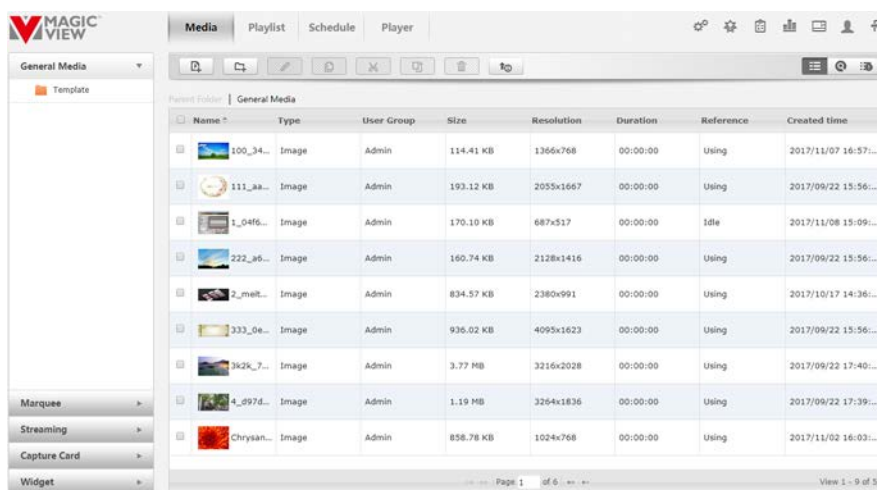

Step 1: click “Media” button;

Step2: choose “General Media” type;

Step3: click  to upload media files:

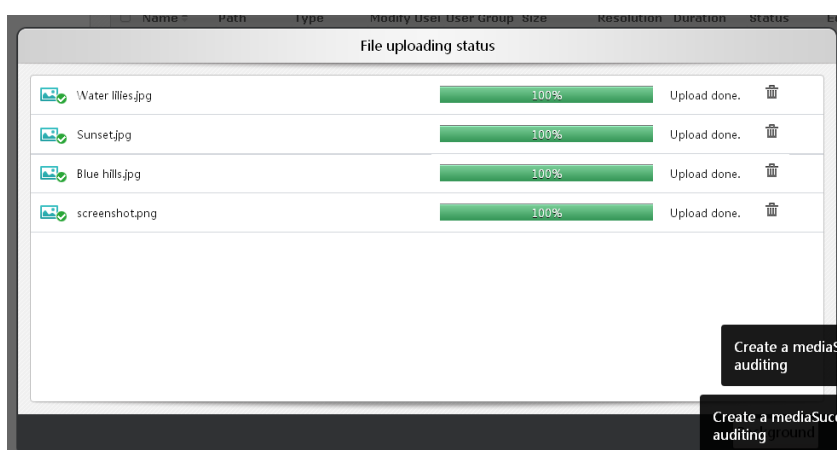

Step 4: The uploaded files are in the audit list. Users need approve them before using:

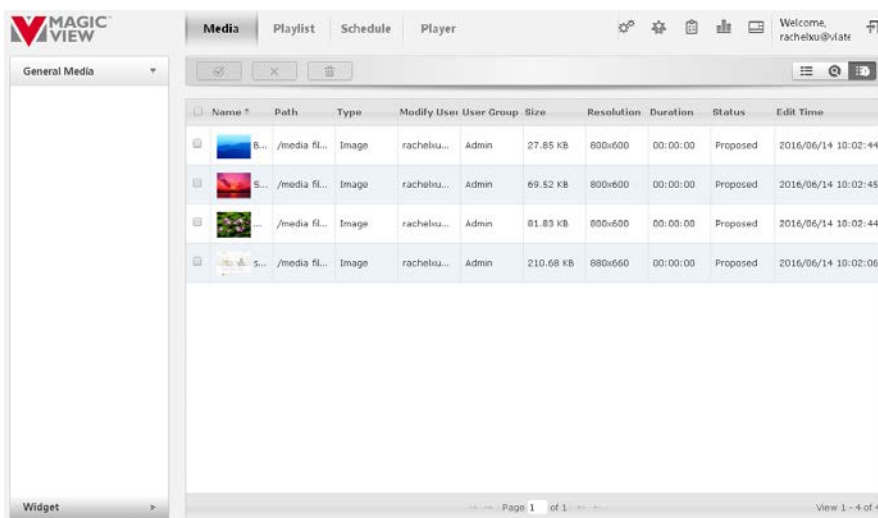

Create Playlist

Step 1: click “Playlist” button.

Step 2: click  and pop-up a dialog, fill in name and select resolution as **Refer to player**:

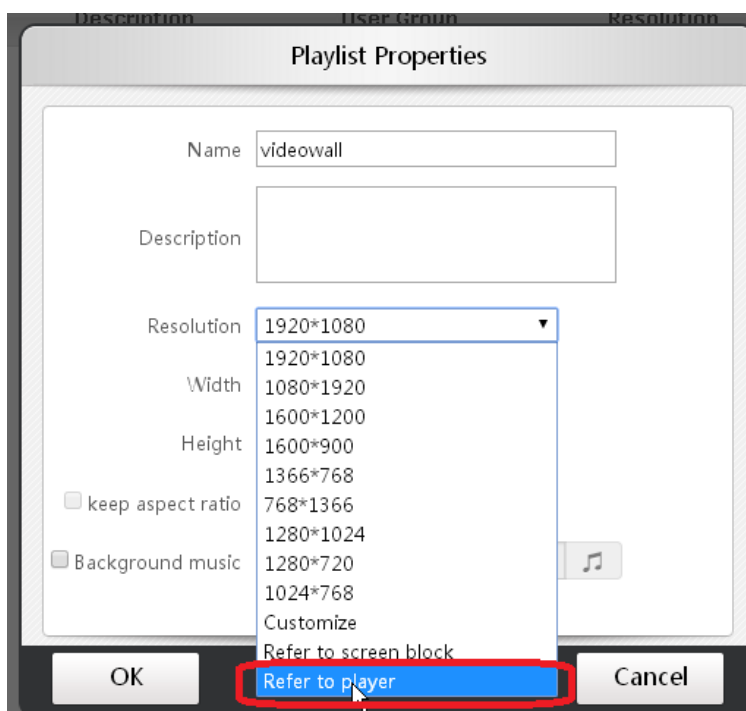

Step 3: Select videowall group and begin to design playlist in the designer area:

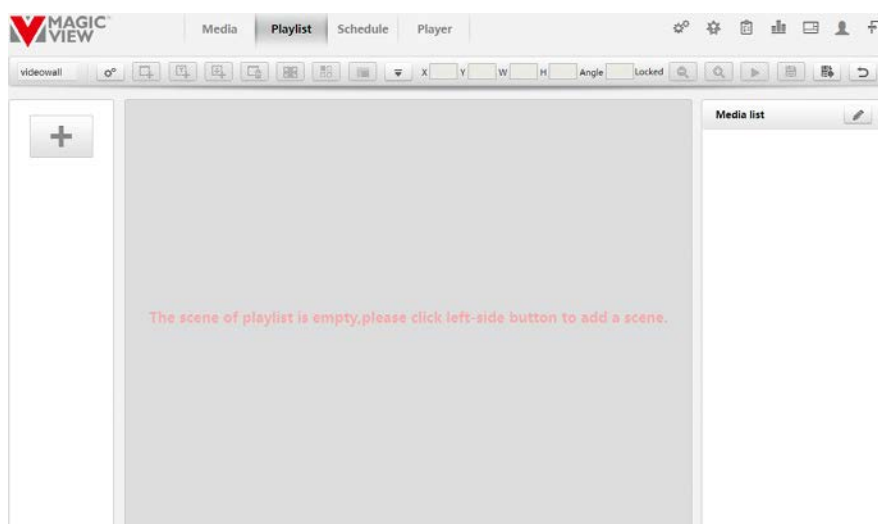
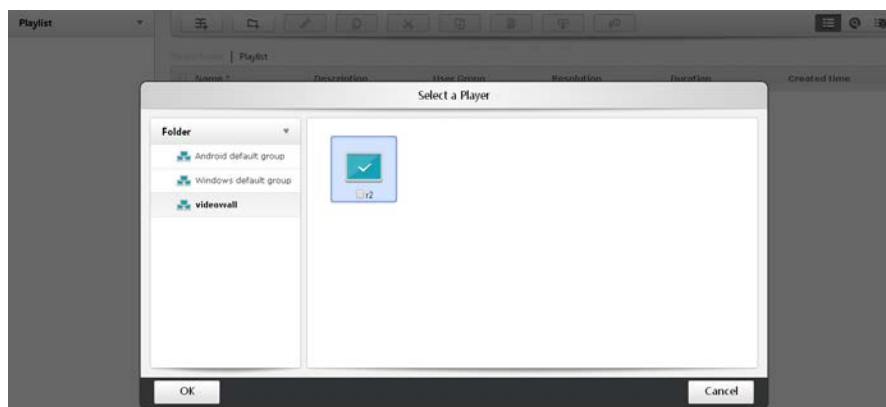

Step 4: click  at left side and choose template to create new scene:

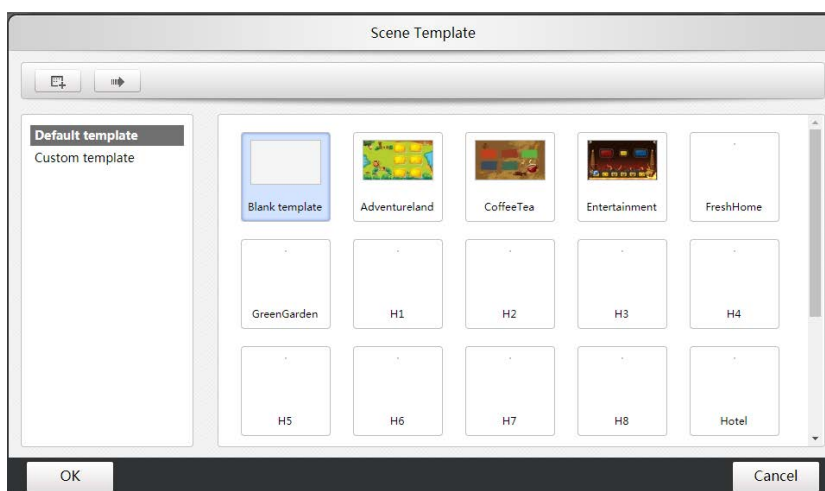

Now users can find the videowall layout in the designer area:

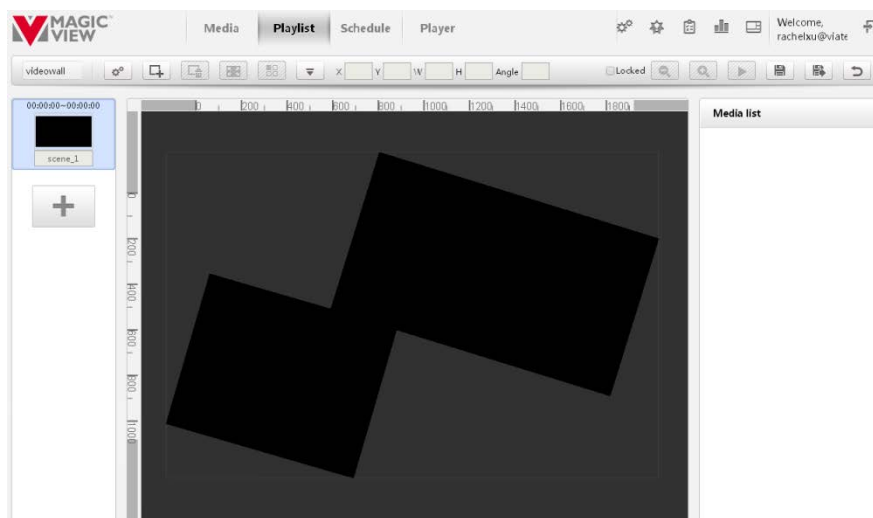

Step 5: click  to create layers:

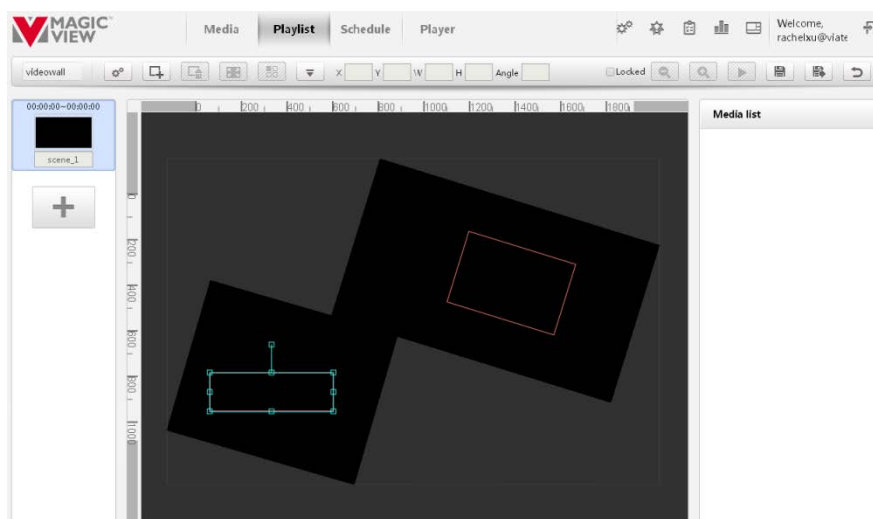

Step 6: Add media files to layers. Select the layer you need to add, and then click  to add the media file in the media list.

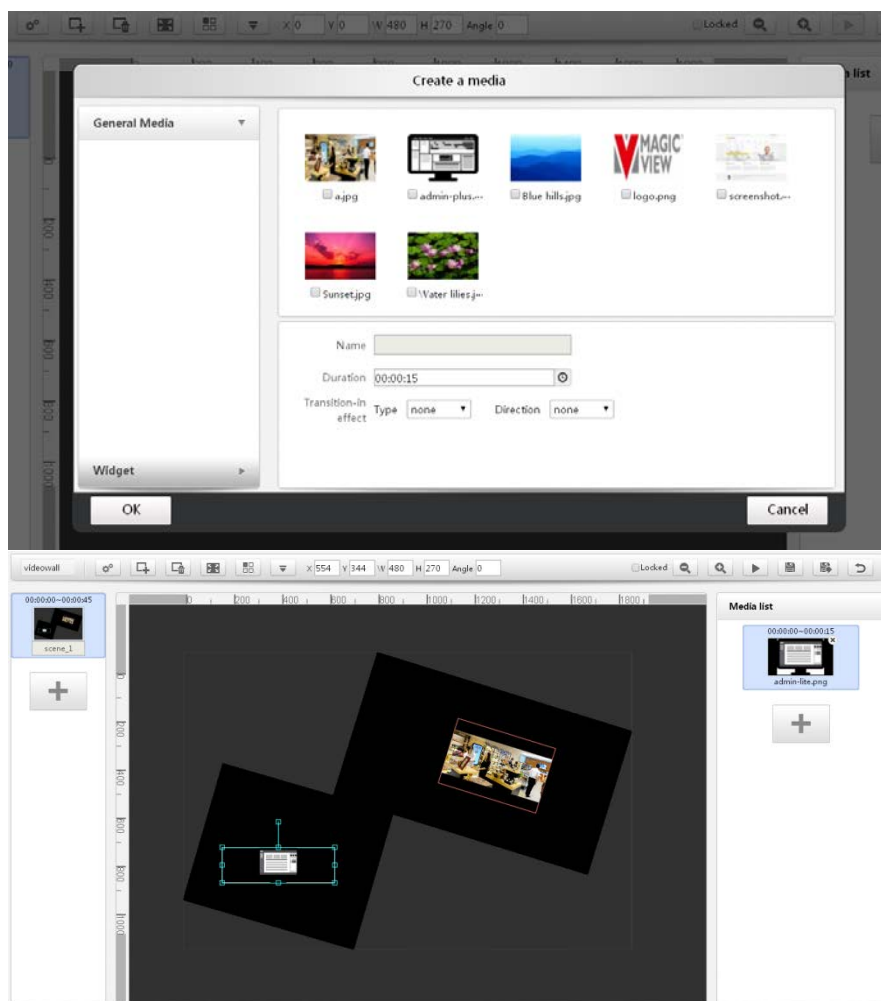

Step 7: Click the button  to save the scene and approve it.
The next step is to schedule the playlist.

Schedule

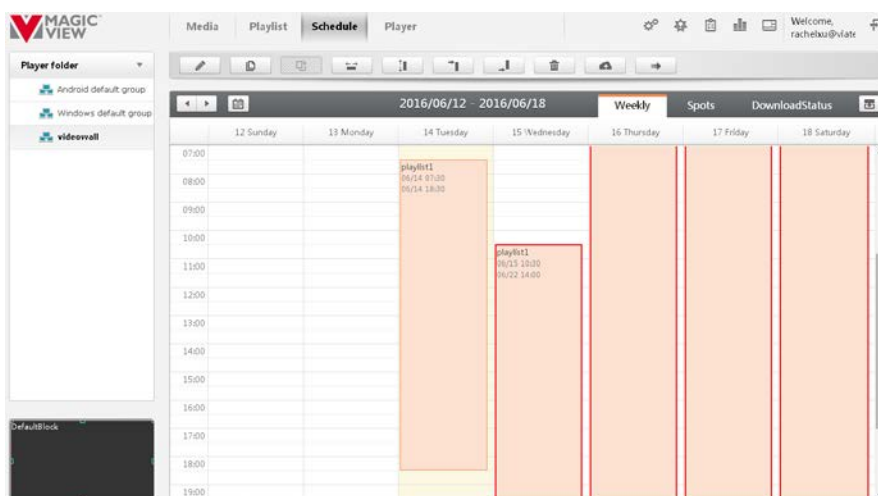

Step 1: Select the player group.

Step 2: Move the pointer to the calendar region. Press the left-button and drag the mouse, the following dialog box will pop up.

Step 3: Set start/end date and time.

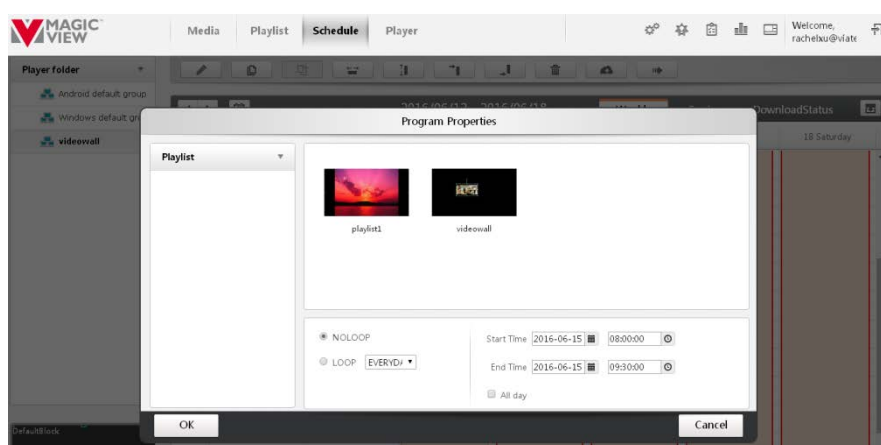

Step 4: Click  to publish program.

After the steps of “upload media files”, “create playlist” and “schedule”, we finish the process of program designing and publishing. If network is working, player will playback the program after downloading the playlists.

Advanced Tutorial

Media

MagicView supports the following formats:

1. Normal:

■ Video

◆ Encoder :

ALTA DS2: H.264

ALTA DS4K/A910: H.264 、 H.265

◆ Container : .mp4 、 .mkv 、 .mov

◆ Max resolution

ALTA DS2: 1x1080P Full HD

ALTA DS 4K/A910: 1x4k Full HD (16:9 only)

■ Image :

◆ .jpg 、 .jpeg 、 .bmp 、 .png

◆ Max resolution : 8kx4k

■ Audio :

◆ Encoder : aac 、 mp3

◆ container : .mp3

2. Marquee

3. PPT 、 pptx 、 pdf (Need install TranscodeEngine and Apache Openoffice)

4. Widget : Weather 、 Clock 、 RSS 、 APK

5. webpage

6. Streaming : RTSP

Create New Folder

Step 1: Click on the left navigation area of a class of media files or directories.

Step 2: Click the button  , the following dialog box will be shown:

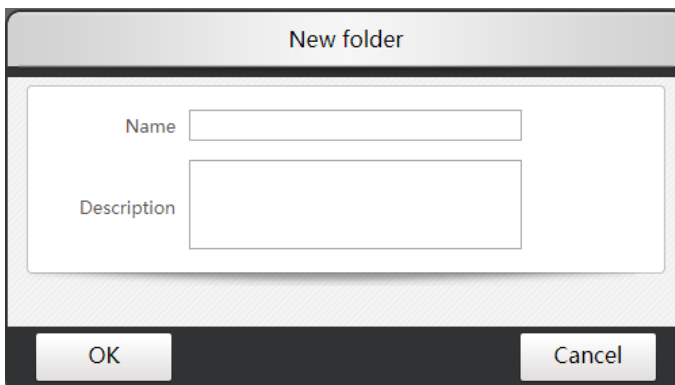

The dialog box is titled "New folder". It contains two input fields: "Name" and "Description". The "Name" field is a single-line text box, and the "Description" field is a multi-line text box. At the bottom of the dialog, there are two buttons: "OK" and "Cancel".

Step 3 : Input the name and description (Description is optional), then click the button “ok”, the new folder is now created.

Create New Media files

For the different type of media, there are three ways to create them.

Note:

After successfully creating a new media file, the message “Success to create media file, it’s needed to be approved” will pop up in the bottom right corner. Only approved media can be used. For details about how to approve, please refer to Approve.

Upload general media file

Step 1 : First, click “General media file” in the left navigation bar, and then click  , the following dialog will be shown:



Step 2: Select the media files.

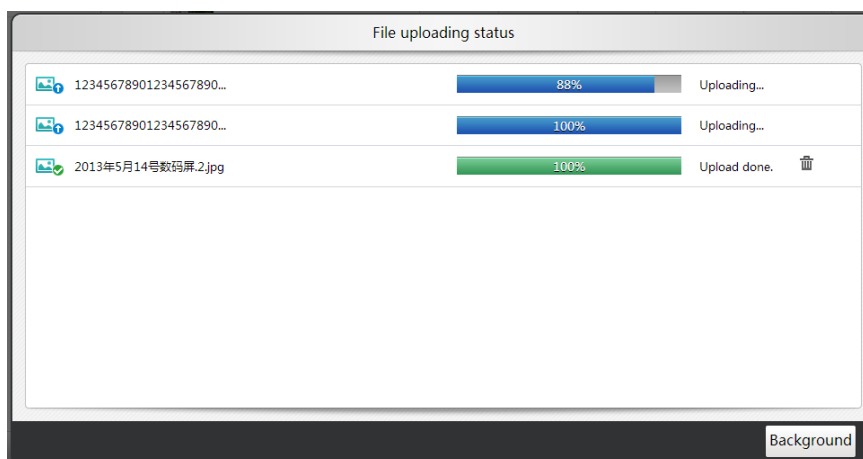

Create Marquee

Step 1: First, click the “Marquee” in the left navigation bar, and then the button , the following dialog box will be shown;

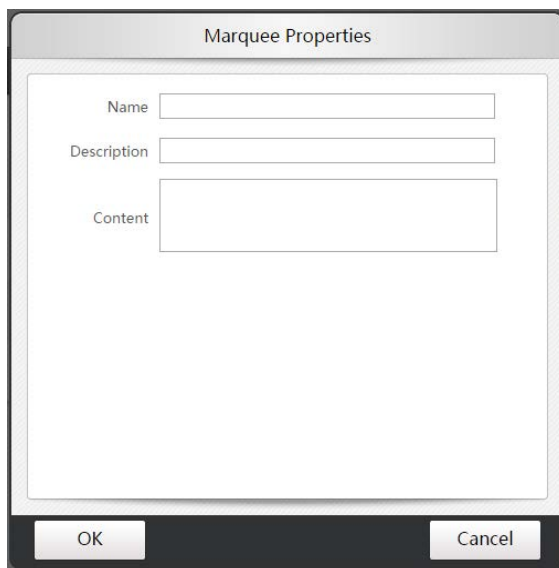

Marquee Properties

Name

Description

Content

OK Cancel

Create streaming/web page

Step 1: First, click the “Streaming” in the left navigation bar, then the button , the following dialog box will be shown;

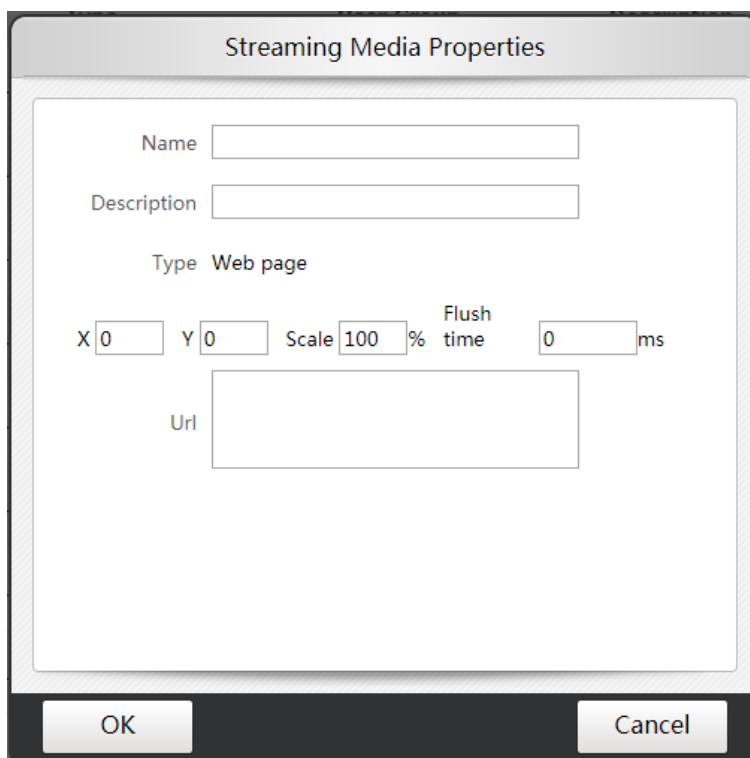

Streaming Media Properties

Name

Description

Type Web page

X Y Scale % Flush time ms

Url

OK Cancel

X Y : the start point of coordinate of the webpage.

Scale % : scaling the webpage.

Create time widget

Step 1: First, click the “Widget” in the left navigation bar, and then the button , the following dialog box will be shown:

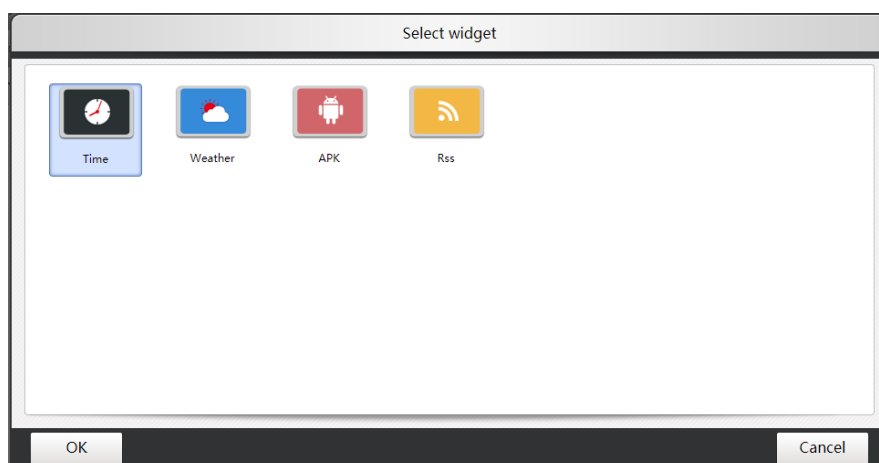

Step 2: Input the name and define the attributes of the widget, then click the button “” to save it.

- Two types of Time: Digital or Analog;
- Language: Simplified Chinese, Traditional Chinese or English;
- Time format: 12 hour or 24 hour;
- Time zone;
- Transparency;
- Date and week.

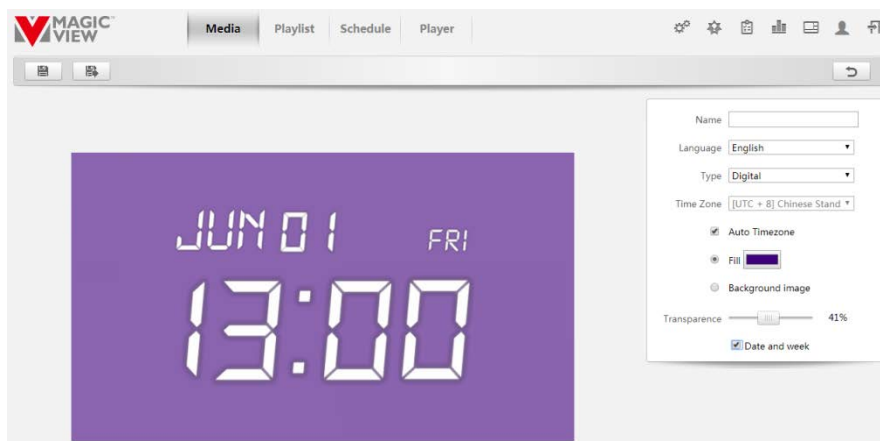

Create Weather Widget

Step 1: Select the widget – Weather:

Step 2: Create city weather and define the attributes of the widget:

- Name;
- Language: Simplified Chinese, Traditional Chinese or English;
- City: click  and search the city;
- Transparency;
- Weather proxy: When the player can not access weather source from internet directly, users need configure a weather proxy to visit weather source.

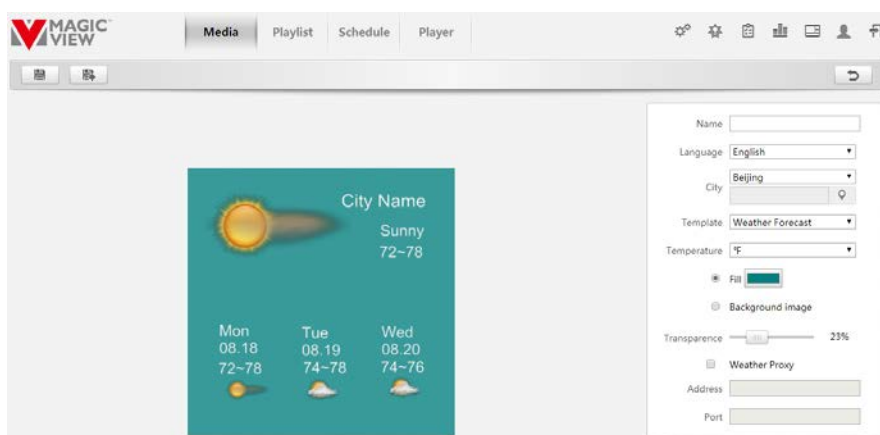

Create APK widget

Step 1: Install the APK which would be played at player side;

Step 2: Find the package name of the APK at player side:

Method:

- At player side, press hotkey of “Ctrl +Q”, Input user name and password (default is admin/admin) and backward to desktop;
- Run Client Configure;
- Click “Show Android Setting “and list the APK package name/

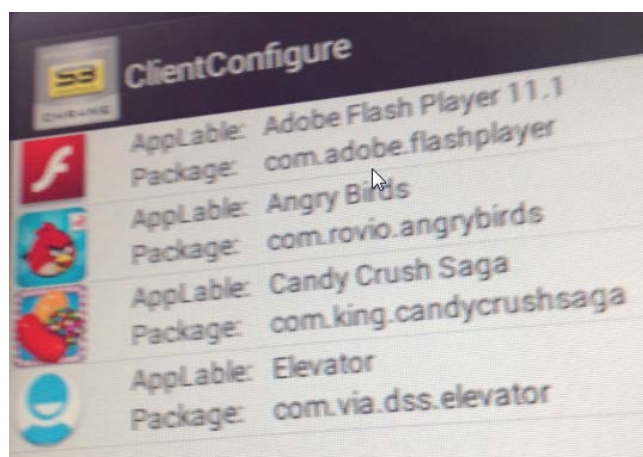

Back to web UI, and begin to create APK.

Step 3: Select the widget – APK:

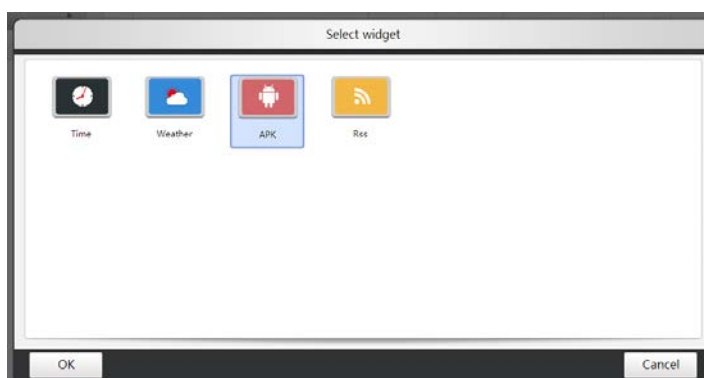

Step 4 : Create APK:

Package name: refer to Figure2-2-2-10. Eg: the package name of APK “angrybirds”is

“com.rovio.angrybirds”.

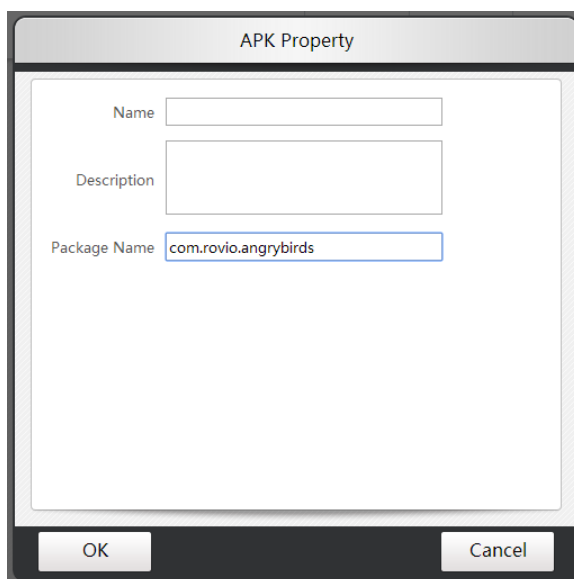

Create RSS Widget

Step 1: Select “RSS” widget;

Step 2: Fill in content:

Source Address: input RSS server’s IP address. Click , the page will display RSS content;

Flush time: time interval that MagicView request content from RSS server;

Switch time: time interval that RSS content are updated at MagicView web UI.

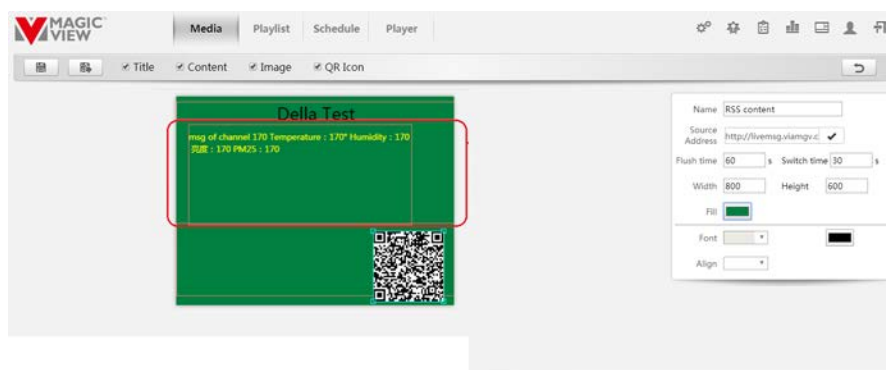

Playlist

Main page:

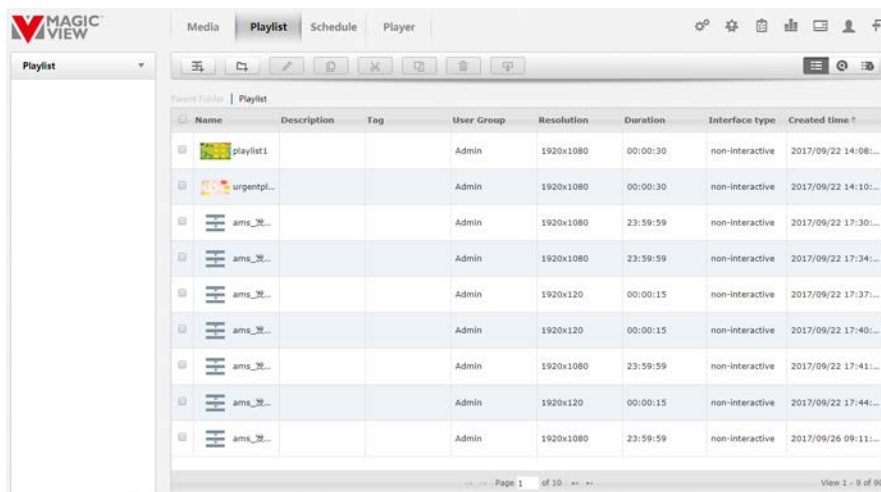

How to Create Playlist

Click the button  , and the following dialog box will pop up.

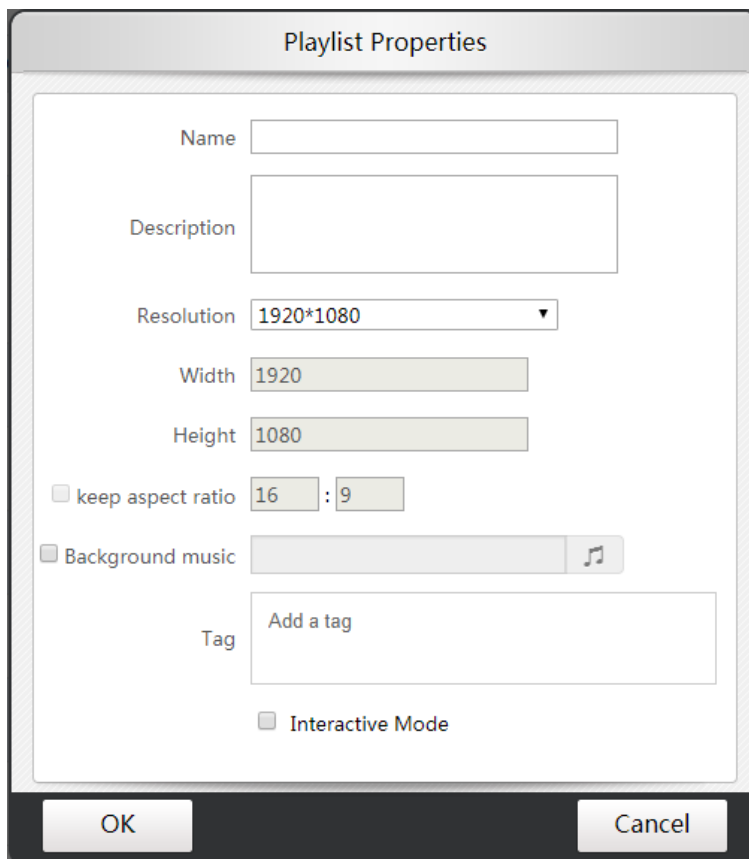

- Resolution: it is the size of block. There are four types for reference:
 - a. Predefined size. For example, 1920x1080,1024x768 etc;
 - b. Customized ;
 - c. Refer to the player layout ;
 - d. Refer to screen block: because the playlist is published to one block of the layout. It usually applies to videowall.
- Add tags.
- For interactive application. Please refer to **Interactive Playlist**.

Edit Playlist

Use designer to edit playlist. The following figure is the designer interface.

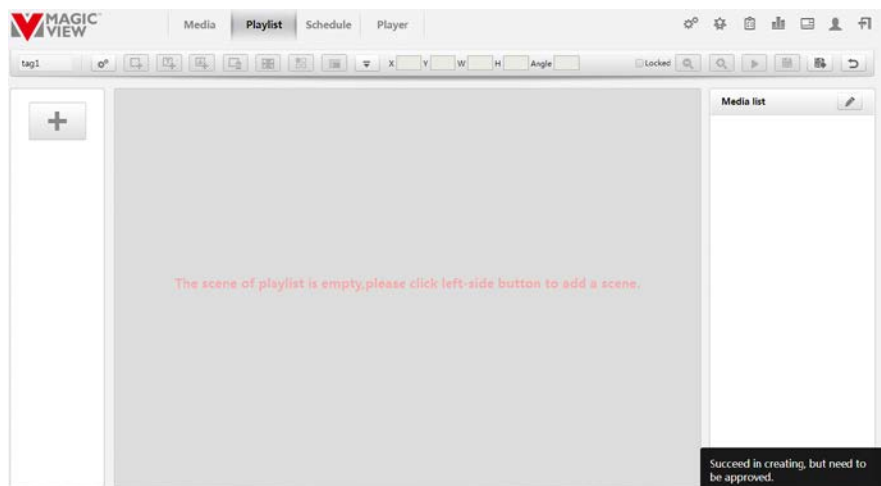

There are four areas of this designer interface:

- Scene area: display scene list;
- Designer area: the main design area, display the effect of the scene, including the layer location, the media
- Media area: display media list of this layer;
- Toolbar area: function icons.

Step 1: Click the button  to create a new scene. One playlist is composed of one or more scenes.

Default is a blank template.

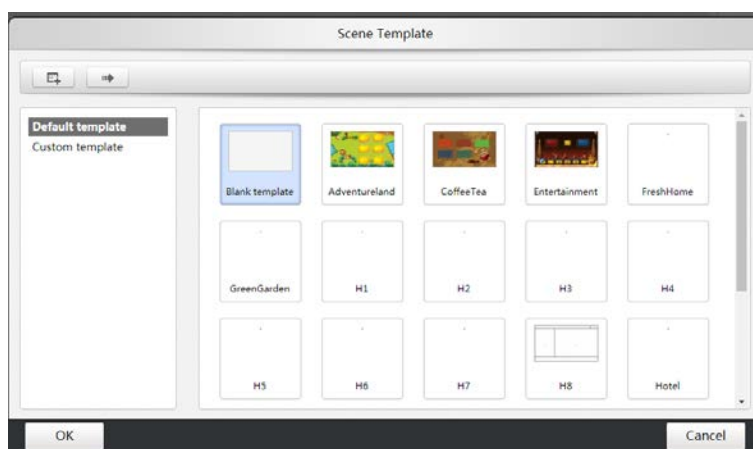

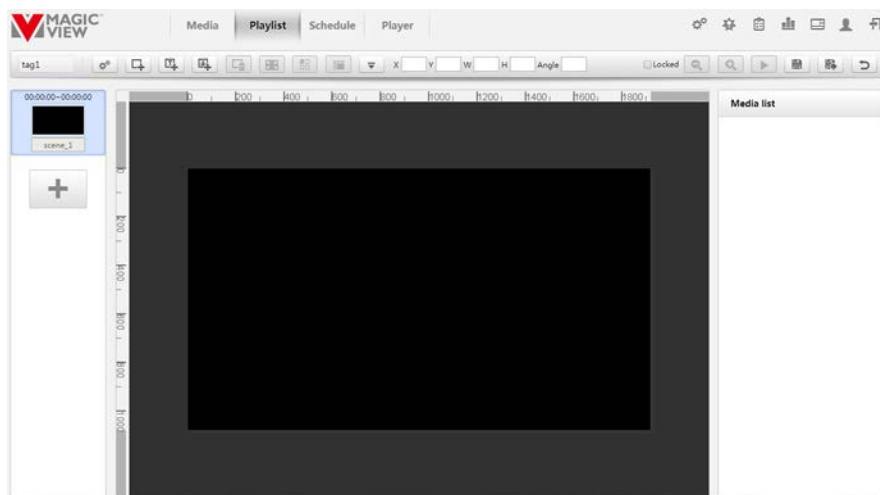

Click  at the left side, users can add more scenes.

Moving the mouse to the scene, users can delete, copy the scene or the scene to save as a template.

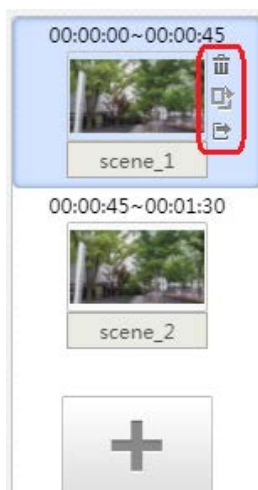

Step 2 : Click the button “” to create a layer. One scene is composed of one or more layers.

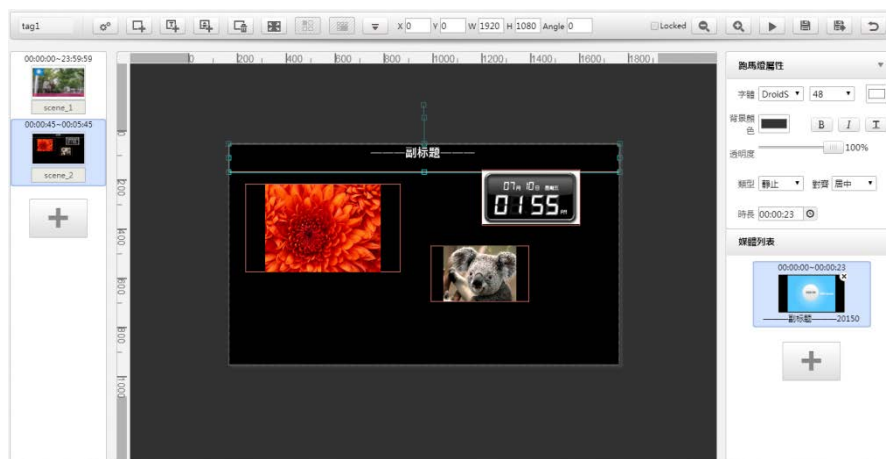

The following is the function icons of the toolbar:

 : Check the attributes of the playlist. Users can modify the playlist name.

Note: Once the playlist is created, the resolution cannot be modified.

X 0 Y 886 W 1920 H 135 角度 0 : Layer's coordinate.

 : Close the design window and return to playlist.

 : Add layer. This layer doesn't support marquee and Android APK types.

 : Add Text layer.

 : Add Android APK layer.



 : Delete layer.

 : List more function buttons as below:

 : Fullscreen of the selected layers.

 : Fill with single screen. Only for videowall.

 : Indicate that the current interface is editable. Press this button to lock the edit interface.

  : The current edit scene can be enlarged or reduced.

 : Preview playlist.



: Save the playlist.



: Save as... the playlist.



: Left aligned for the selected layers(two or more layers)



: Right aligned for the selected layers(two or more layers)



: Top aligned for the selected layers(two or more layers)



: Bottom aligned for the selected layers(two or more layers)



: Two layers close to each other horizontally



: Two layers close to each other vertically



: Move the layer up



: Move the layer down



: Copy layer.



: Paste layer.

Note:

Select two or more layers by hotkey “shift”.

The layer can rotate and zoom in/out with the mouse.

Step 3 : Add media files to layers. Select the layer you need to add, and then click  to add the media file in the media list.

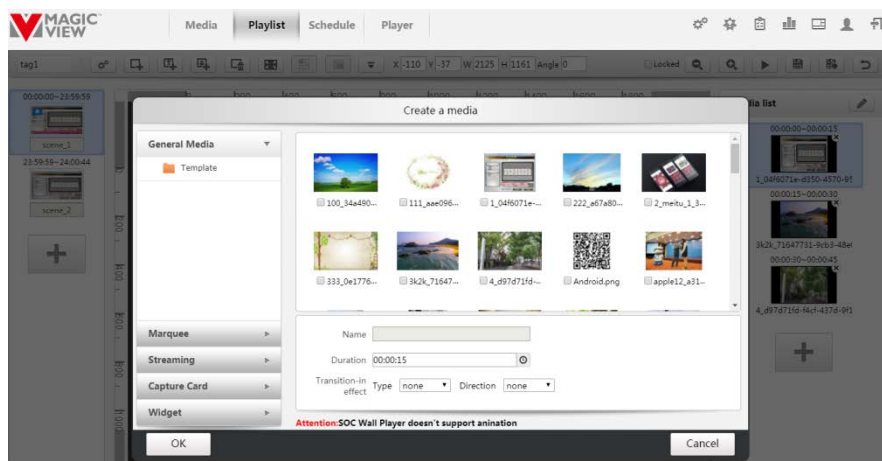

Note:

Media files are available only after they are approved. For details about how to approve, please refer to chapter to **Approve**.

Step 4 : Edit the features of media playback.

- Video:
 - a. Duration. The default duration is 15s. User can modify it.
 - b. The videos in the same directory can be multi-selected, but users cannot modify the duration.

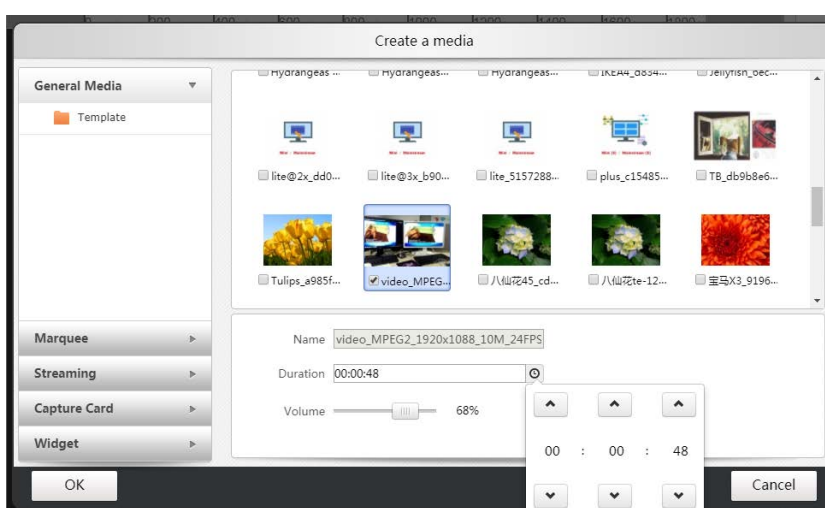

- Picture:
 - a. Duration. The default duration is 15s. User can modify it.

- b. The pictures in the same directory can be multi-selected.
- c. Transition effect. If user selects transition effect, the duration cannot be 0s.

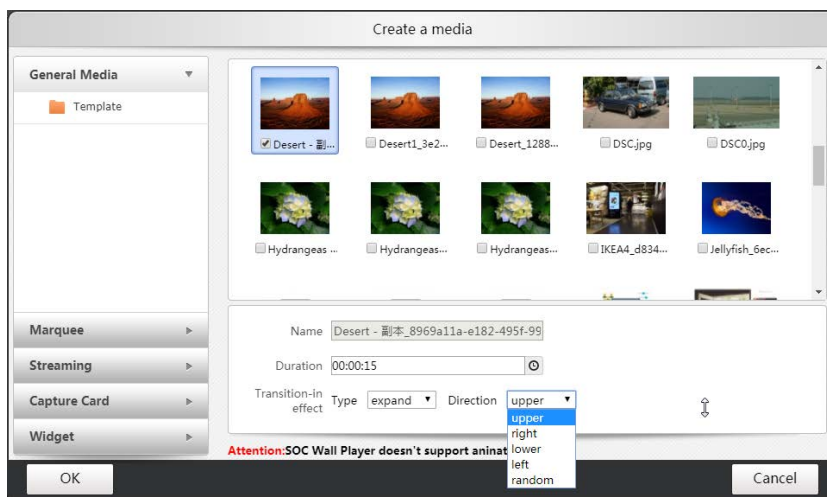

- Text:

- a. Reference file: this option, said the marquee file is not modified. Do not check, said marquee can be modified; the modified file is not synchronized to the media library, only for this playlist.

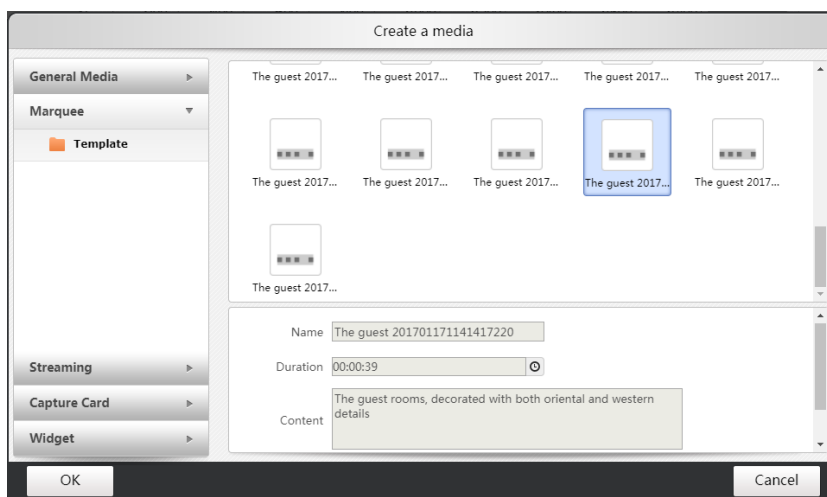

Select the marquee, and edit marquee attributes in the right area:

- a. Two types of Text: static and marquee;
- b. Edit the font type, size and color;

- c. Background color;
- d. Transparency;
- e. The speed of marquee: Slow, Medium and Fast; user can modify the speed according to reference time.

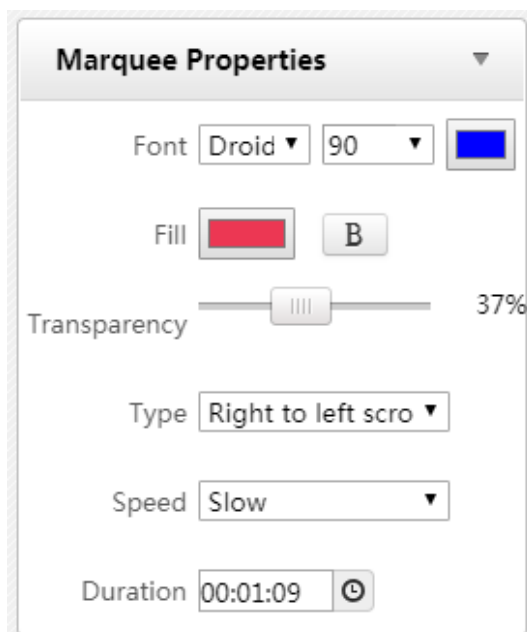

Note:

Change the playback order by dragging the published media file.

Step 5 : Click the button  to save the scene. A new scene is created.

Step 6 : Add other scene again according to the above steps. A new playlist is creatd.

Schedule

Schedule is for player group, it includes layout, media, playback time, etc.

Create the schedule

Step 1 : Select the player group.

Step 2 : Select the block in the layout preview. (If there is only one block in the layout, it is selected by default.)

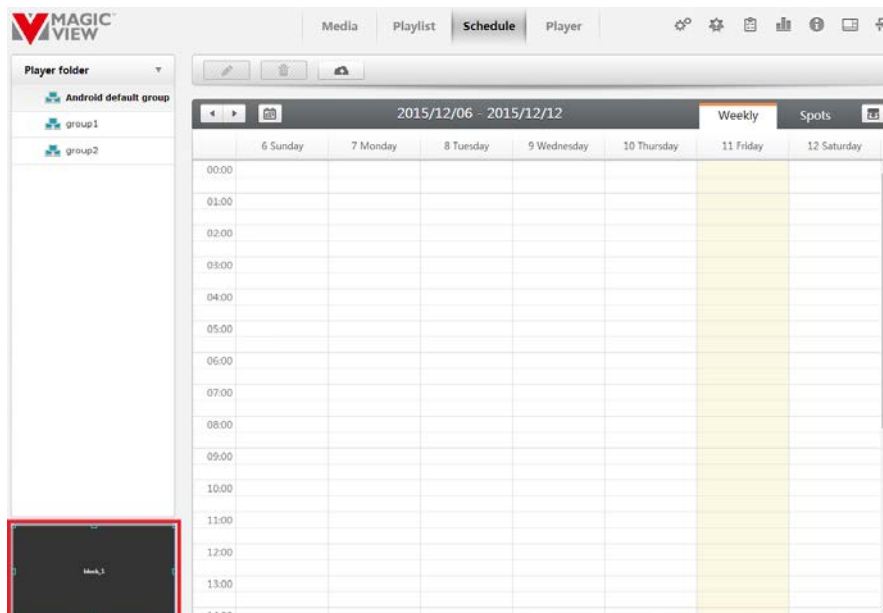

Step 3 : Move the pointer to the calendar region. Press the right-button and drag the mouse, the following dialog box will pop up.

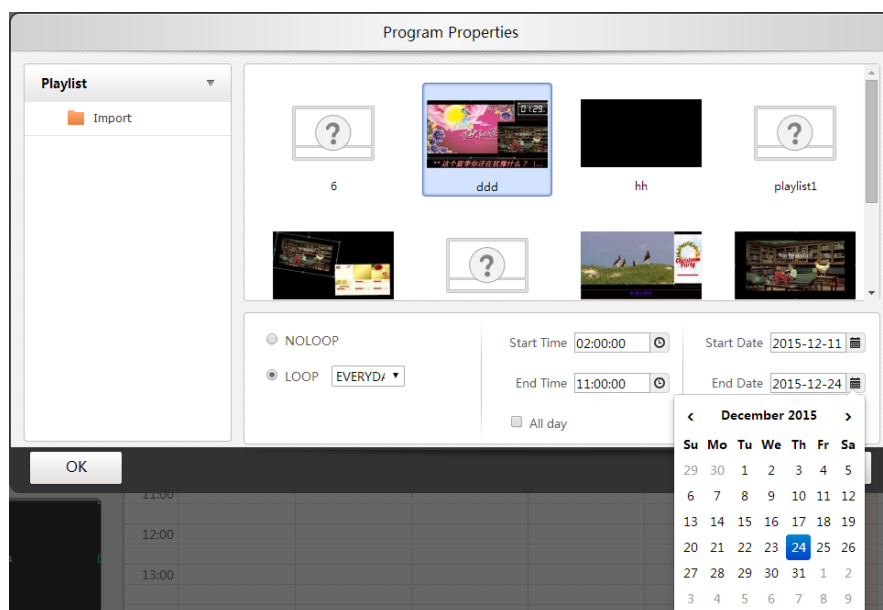

Choose one playlist and set start/end time/date.

The following example is based on the following configuration:

Start time is set to 2:30; end time is 18:45.

Start date is Dec 11, 2015; end date is Dec 24, 2015.

Loop type:

◆ Not loop: it means the playback time is from the start time of the start date to the end time of the end date.

For example: It means the playlist will play from Dec 11, 2015, at 2:30 to Dec 24, 2015, at 18:45.

◆ Loop every day.

Within the selected date, each day is fixed within a fixed time.

For example: Every day from Dec 11, 2015, at 2:30 to Dec 24, 2015, at 18:45.

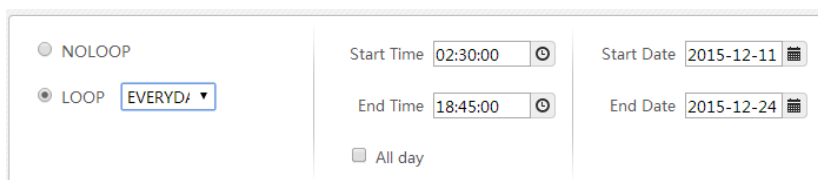

NOLOOP

LOOP **EVERYD**

Start Time 02:30:00

End Time 18:45:00

Start Date 2015-12-11

End Date 2015-12-24

All day

◆ Loop every week.

For example: The playlist will play from 2:30 to 18:45 every Tuesday and Friday from Dec 11, 2015 to Dec 24, 2015.

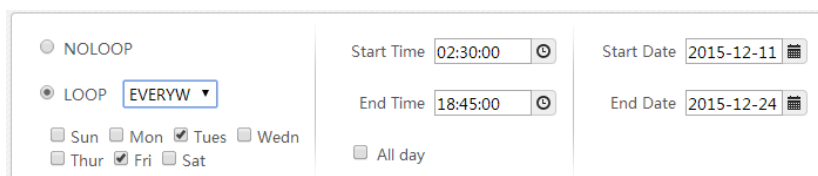

NOLOOP

LOOP **EVERYW**

Start Time 02:30:00

End Time 18:45:00

Start Date 2015-12-11

End Date 2015-12-24

Sun Mon Tues Wedn

Thur Fri Sat

All day

There is a "G" identification of the schedule, which means that the program is a loop mode.

Step 4 : Select the playlist and define the schedule, then click the button "ok" to the main window of schedule.

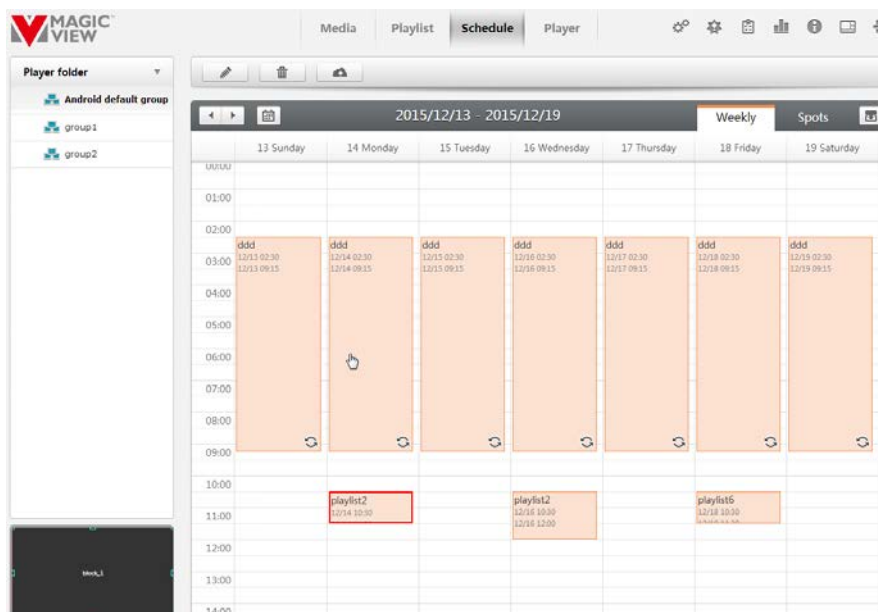

Step 5: Click the button  to publish the schedule. The color in the schedule block will be changed from orange to blue.

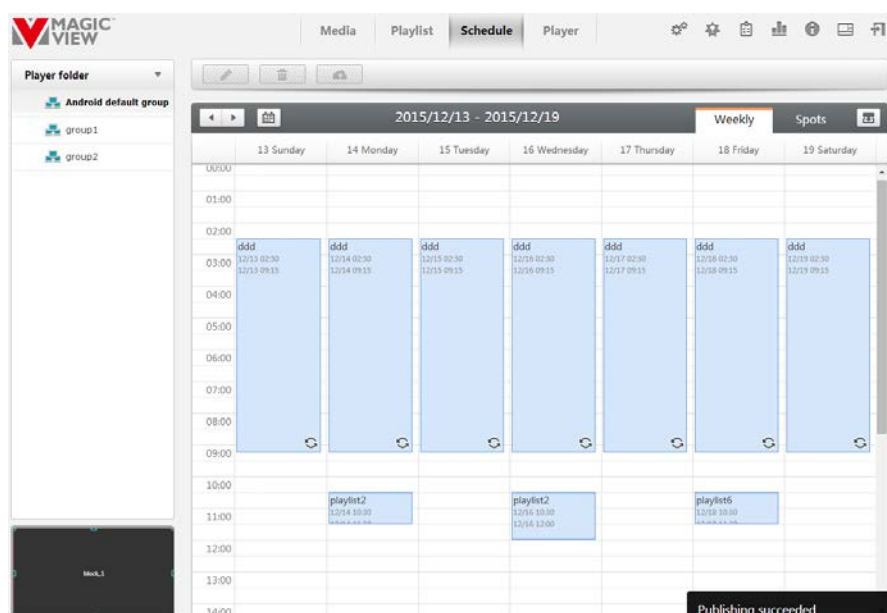

Modify the schedule

There are three ways to modify the schedule.

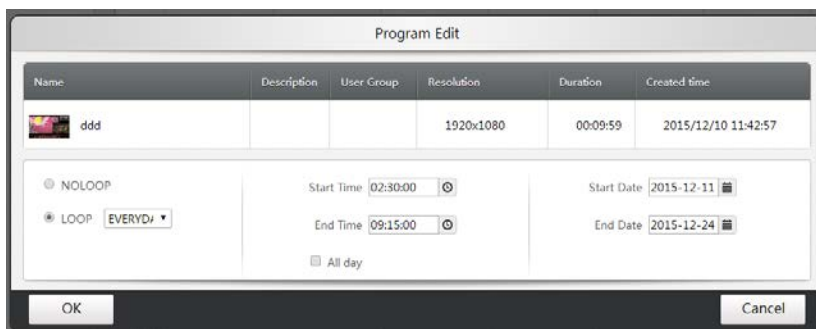

- I. First, select the schedule, then click the button , the following dialog box will pop up;



The way is common one. User can get the accurate schedule by redefining the start time, end time, start date, end date and loop mode.

2. Select the schedule, then hold the left mouse and drag the rectangle to modify the start time, end time, start date and end date. However, the loop mode and the whole playback time will stay.
3. Select the schedule, move the pointer over the top edge or bottom edge of the rectangle, it changes to a two-way arrow. Drag the two-way arrow to modify the start time or end time. However, the start date, end date and loop mode will stay, they cannot be modified.



4. Select the schedule, click  then set another duration, click  to copy:

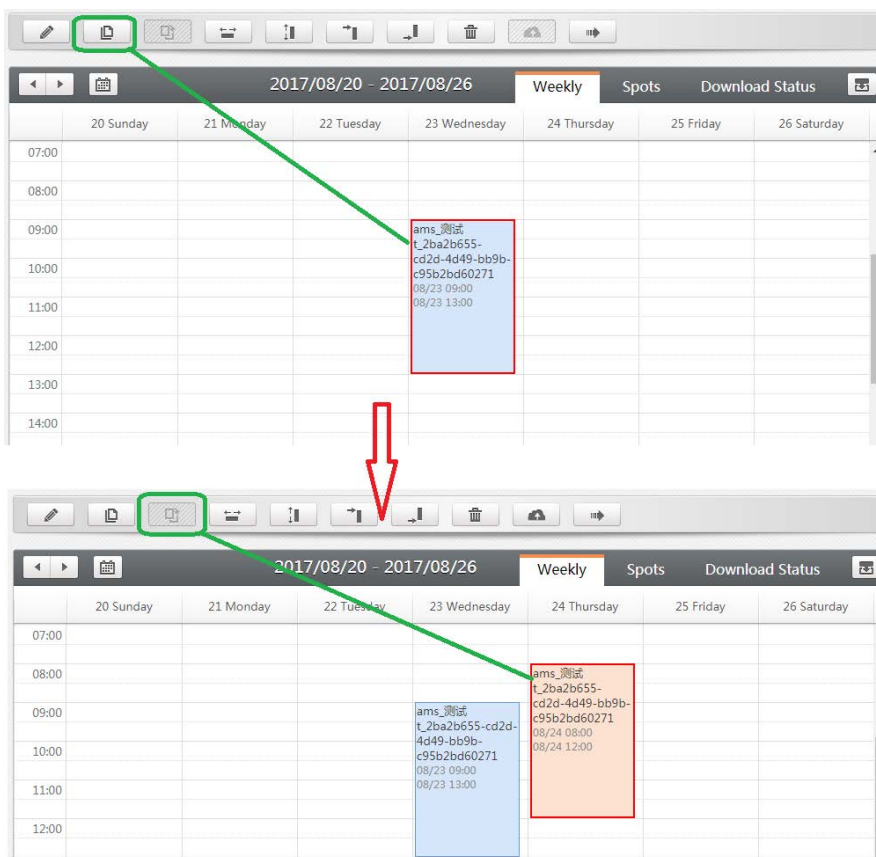

5. Click     to modify schedule:

 : Horizontal copy. User can copy date and loop mode:

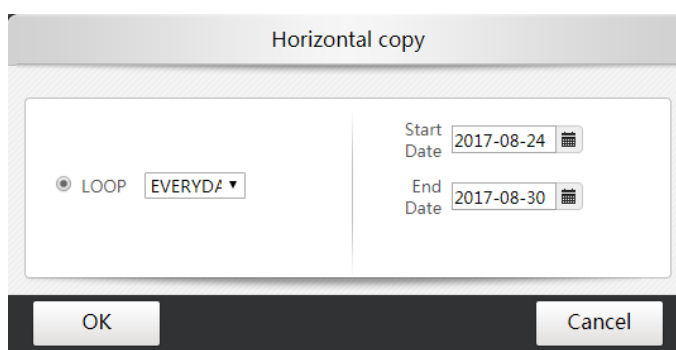

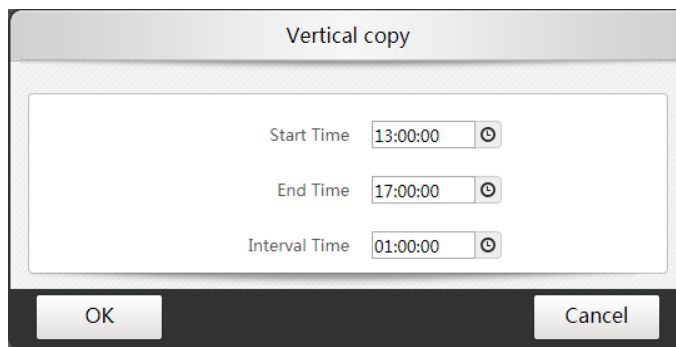

 : Vertical copy. User can copy start and end time.





Vertical copy

Start Time 

End Time 

Interval Time 

 : Align to top. The start time is fixed to 0 a'clock. And can not change start/end date and interval time.

 : Align to bottom. The end time is fixed to 23:59. And can not change start/end date and interval time.

Replace the schedule

Step 1: Select a published playlist, click  :

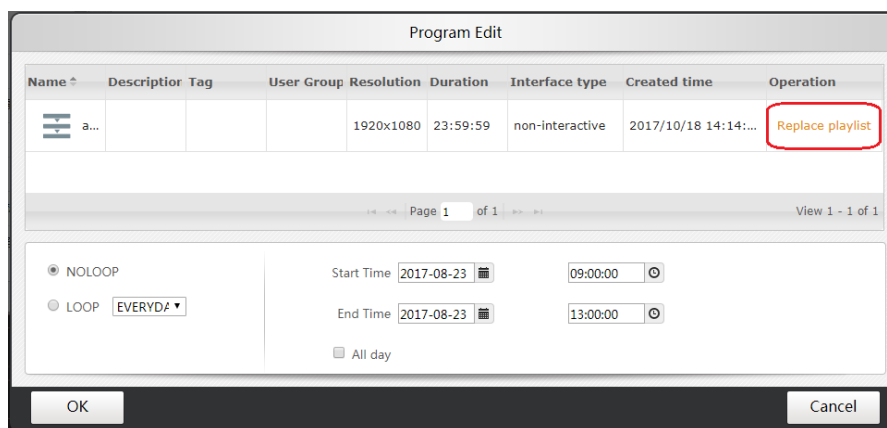





Program Edit

Name	Descriptor	Tag	User Group	Resolution	Duration	Interface type	Created time	Operation
	a...			1920x1080	23:59:59	non-interactive	2017/10/18 14:14:...	Replace playlist

Page 1 of 1 View 1 - 1 of 1

NOLOOP
 LOOP

Start Time  
 End Time  
 All day

Step 2: Click **Replace playlist** to select another playlist:

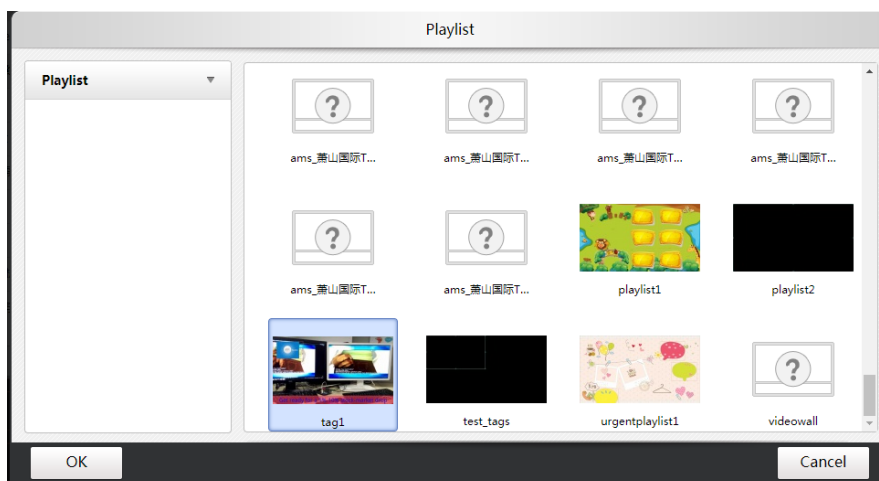

Spots

The priority of the spots is higher than scheduled playlist. At the same time, player will playback spot instead of schedule playlist.

Step 1 : Click the label “spots”;

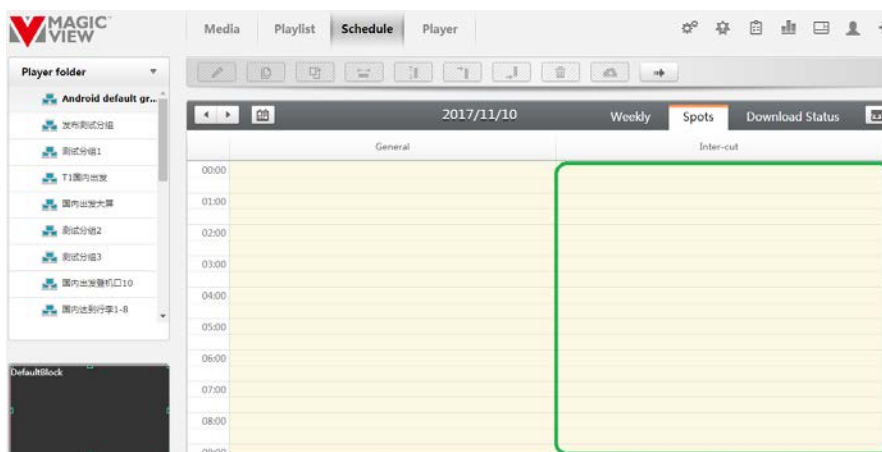

Step 2 : Move the pointer to the calendar region. Press the right-button and drag the mouse, the following dialog box will pop up. Choose playlist and schedule.

Step 3 : Click the button  to publish the project. The color in the project block will be changed from orange to blue.

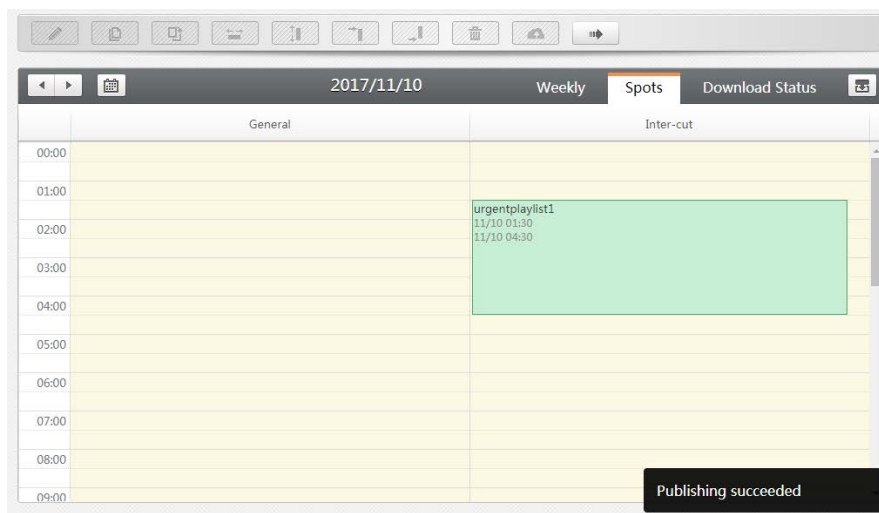

Default playlist

The default program can be played in any idle period to avoid the status that player hasn't program to playback. And users need not define playlist's schedule and loop mode of the default program.

Step 1 : Click  to open the default program page.

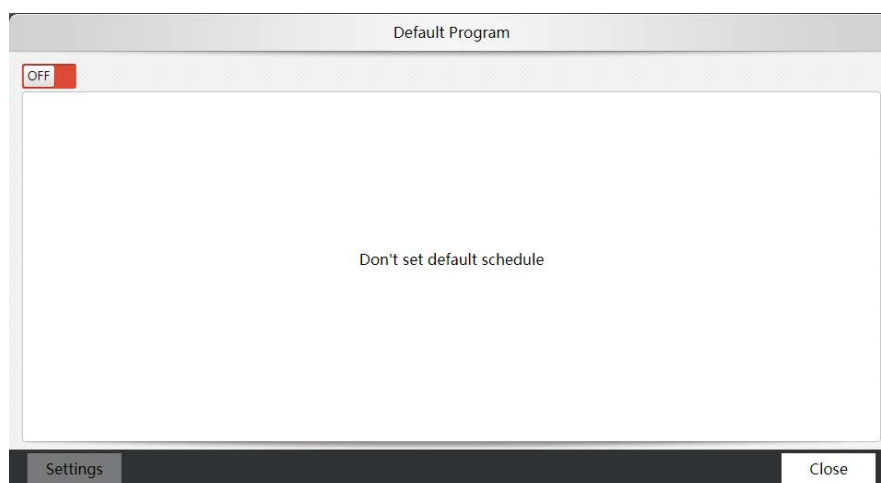

Step 2 : Switch to , click **Settings** and select a playlist.

Publish Off-line Playlist

When player is off-line, users can download a playlist to USB disk and plug-in the player to playback.

Step 1 : At schedule page, click , then all the scheduled playlists will be downloaded to **downloads**

folder at local machine as the zip package. Such as C:\Documents and Settings\[user name]\My Documents\Downloads\mgv_offsch_default.zip.

Step 2 : Copy the zip package to the root directory of a USB disk.

Step 3 : Plug-in the sub disk to player. Player will load the zip package and auto playback according to the schedule.



Playlist Download Status

Click [Download Status](#) to check the download processing of each playlist.

The table does not include urgent cases and preload playlists.

If the playlist's status is "preparing", it can not be deleted.

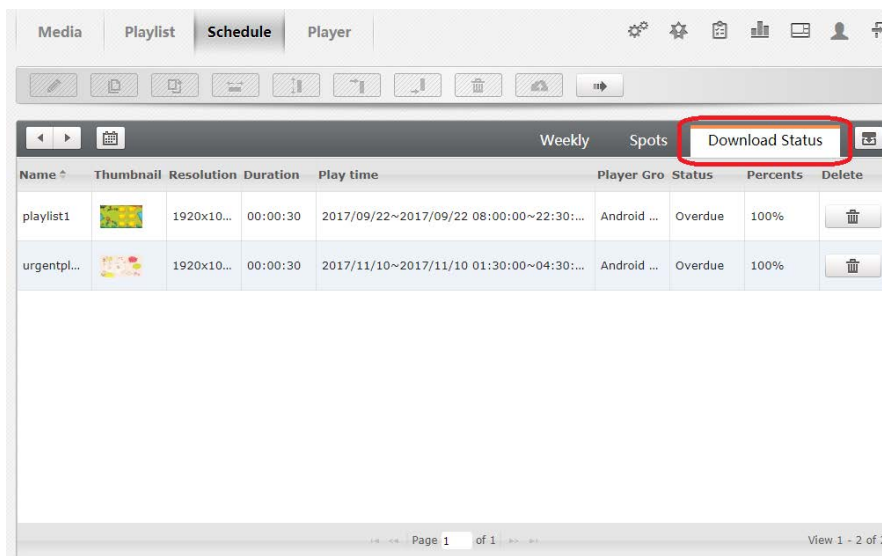

How to create a player group

Step 1 : Click the button , the following dialog box will pop up.

New Group

Name

Description

Type

Note:

1. There is a default group named android default group.
2. Once the player is successfully configured, it will be automatically added into the default group.

Create videowall group(Mainstreams)

If users want to combine the players as a videowall, please refer to **(Mainstreams) Combine VideWall**

Click  to revert to normal group.

Create Synchronized Group

This function implements sync-playing of multi players.

Select a player group, click .

Note :

1. Videowall group can not set to synchronized group.

Player/Player Group remote power management

Choose the players or player groups to set remote power management.



: Remote reboot;



: Remote shutdown;



: WOL.

Player groups power on/off on schedule

Step 1 : Choose a player group:

Step 2 : Click , and set the boot/off time:

Step 3 : Edit power on/off time.

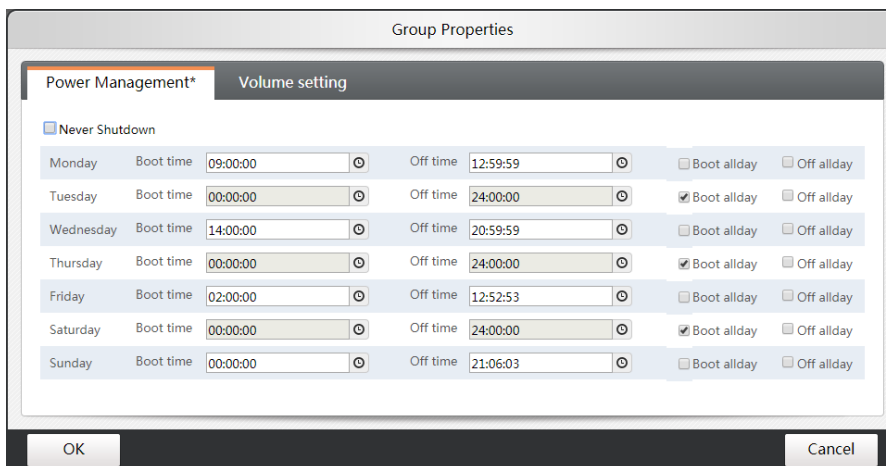

Volume Setting for Player Group

Step 1 : Select a player group;

Step 2 : Click  :

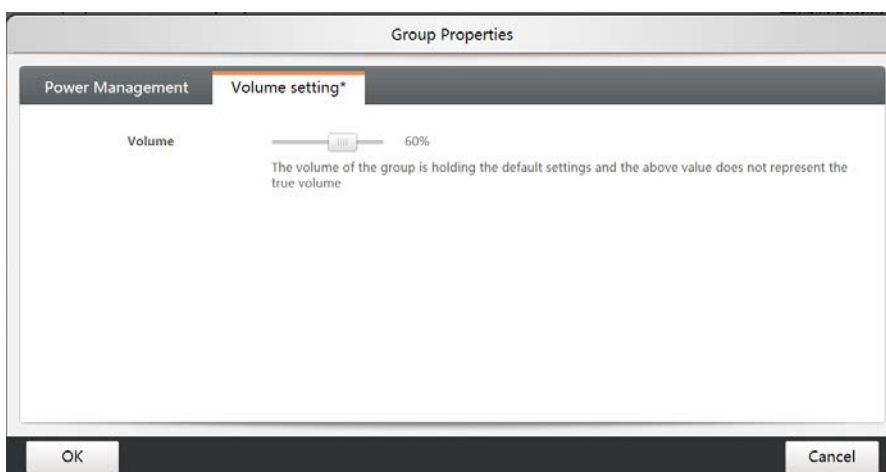

Player Groups' Advanced Properties

You can set more properties of group: screen rotation, time zone, ntp server and mini free space of player. Schedule update time: You can set the time of updating schedule in daily, e.g. Update schedule in 2:00 am in every day.

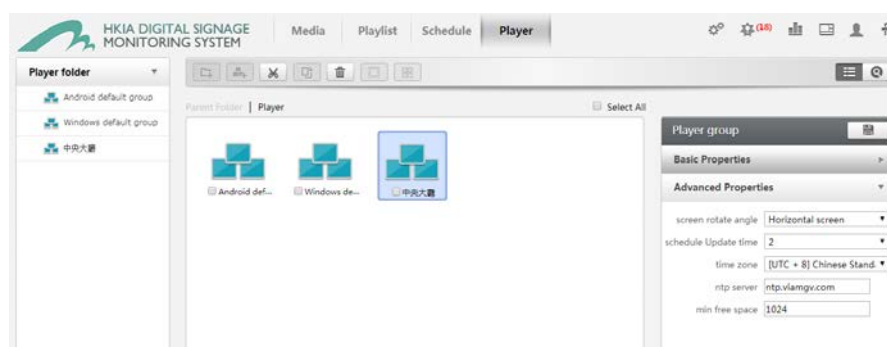



Click  to save.

Player Basic Properties

User can modify player basic properties such as name, description and owner. Click  to save.

Screenshot

Step 1 : Choose the player:

Step 2 : Click  label at right column, then click  to snapshot:

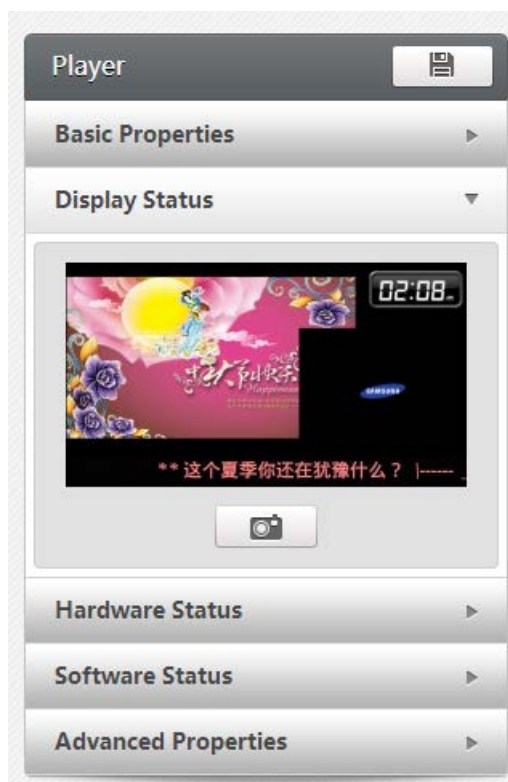

Screen Status

Step 1 : Choose the player:

Step 2 : Click  label at right column, then click  to snapshot:

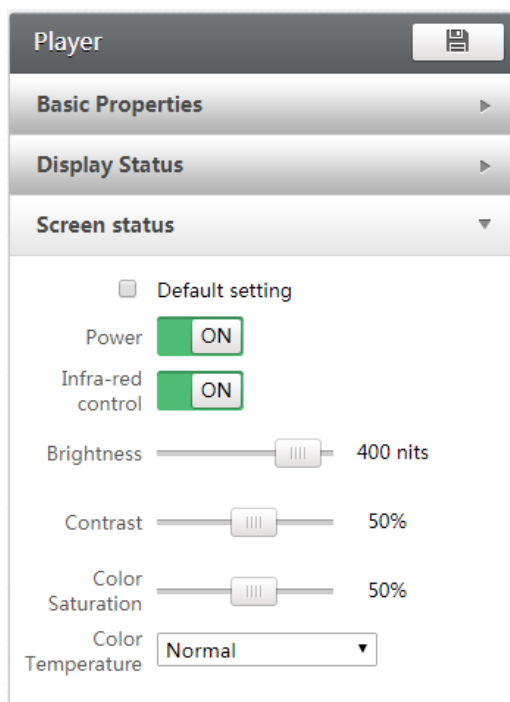

You can get/set screen brightness, contrast, color saturation and temperature, you can power on/off screen and disable/enable infra-red control.

For color temperature, you can set customized value:

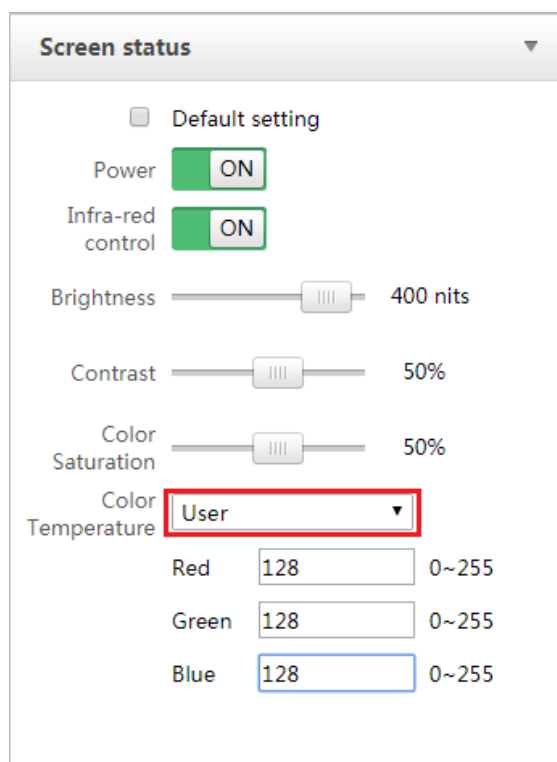

Check Hardware Status

Users can check the usage of player's CPU, memory and Hard Disk.

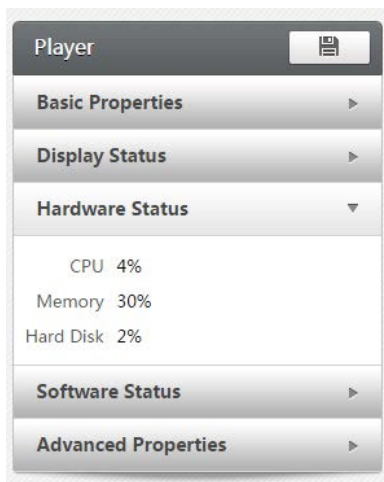

Check Software Status

Users can check player's client version, player version and OS version. If there is a new version of player software, users can upgrade it by pressing update button.

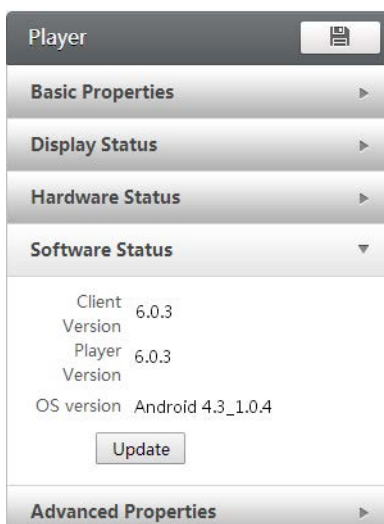

Check Advanced Properties

Player's advanced properties include:

- Mac address;
- Gateway;
- Mask;
- Command Server IP;
- Media Server IP.

System Setting

It sets log query type:

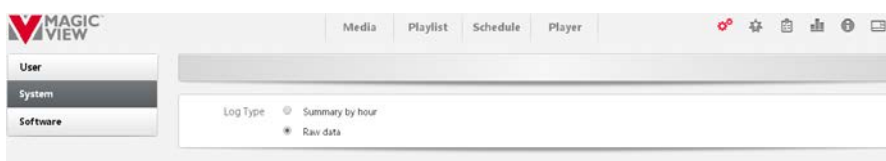

Update Players

Step 1 : Click the button  to open the window of system management.

Step 2 : Click the button  to upload the software package.

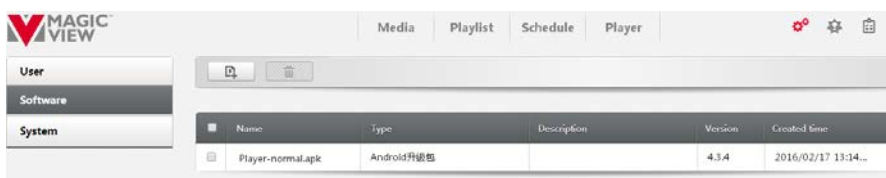

Step 3 : Select the players at Player Management Page to upgrade.

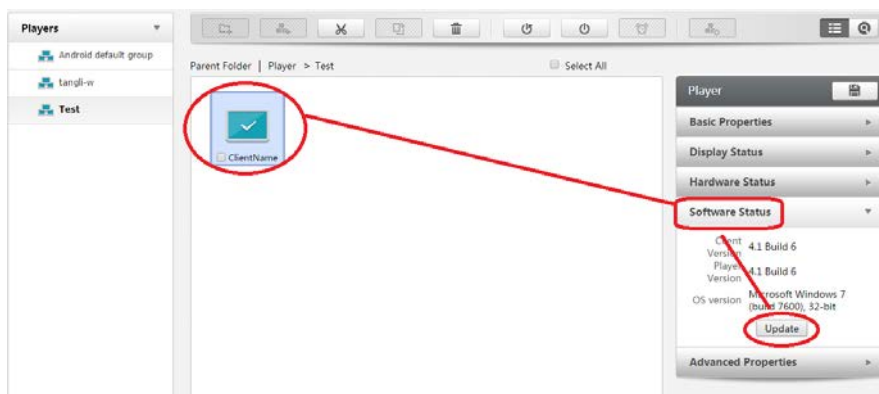

Log

The log includes player log and operation log.

Play log:

Click  to enter log page.

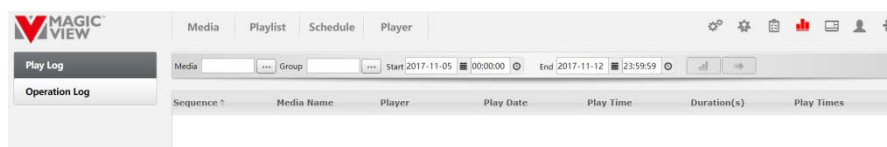

Choose the dedicate media file.

Choose player group.

Select start/end date and time.

Click  to check the search result.

MAGIC VIEW

Media Playlist Schedule Player

Play Log

WeddingBanq... Group Android defa... Start:2015-12-04 00:00:00 End:2015-12-11 23:59:59

Sequence	Media Name	Player	Play Date	Play Time	Duration(s)	Play Times
1	WeddingBanq...	8880	2015/12/10	14:34:17	30	1
2	WeddingBanq...	8880	2015/12/10	14:34:47	30	1
3	WeddingBanq...	8880	2015/12/10	14:35:17	30	1
4	WeddingBanq...	8880	2015/12/10	14:35:47	30	1
5	WeddingBanq...	8880	2015/12/10	14:36:17	30	1
6	WeddingBanq...	8880	2015/12/10	14:36:47	30	1
7	WeddingBanq...	8880	2015/12/10	14:37:17	30	1
8	WeddingBanq...	8880	2015/12/10	14:37:47	30	1
9	WeddingBanq...	8880	2015/12/10	14:38:17	30	1
10	WeddingBanq...	8880	2015/12/10	14:38:47	30	1
11	WeddingBanq...	8880	2015/12/10	14:39:17	30	1
12	WeddingBanq...	8880	2015/12/10	14:39:47	30	1
13	WeddingBanq...	8880	2015/12/10	14:40:17	30	1
14	WeddingBanq...	8880	2015/12/10	14:40:47	30	1
15	WeddingBanq...	8880	2015/12/10	14:41:17	30	1
16	WeddingBanq...	8880	2015/12/10	14:41:47	30	1
17	WeddingBanq...	8880	2015/12/10	14:42:17	30	1

Search success!

Click to export the results to the excel table.

Operation log:

Select user, start/end date and time, click to check the result.

序號	用戶	登錄IP	操作時間	操作	參數
15	rachelxu@viate...	127.0.0.1	2017/03/07 16:34:48	註冊SAAS播放機	{"name":"player2","hardware_id":"2","description":"player2","w...
16	rachelxu@viate...	127.0.0.1	2017/03/07 16:34:56	註冊SAAS播放機	{"name":"player3","hardware_id":"3","description":"player3","w...
17	rachelxu@viate...	127.0.0.1	2017/03/07 16:35:04	註冊SAAS播放機	{"name":"player4","hardware_id":"4","description":"player4","w...
18	rachelxu@viate...	127.0.0.1	2017/03/07 16:38:38	註冊SAAS播放機	{"name":"player5","hardware_id":"5","description":"player5","w...
19	rachelxu@viate...	127.0.0.1	2017/03/07 16:38:46	註冊SAAS播放機	{"name":"player6","hardware_id":"6","description":"player6","w...
20	rachelxu@viate...	127.0.0.1	2017/03/07 17:03:14	創建播放機群組	{"group_name":"videowall","group_desc":"videowall","os_type":...
21	rachelxu@viate...	127.0.0.1	2017/03/08 13:24:04	移動播放機群組	{"client_info_array":[{"id":105,"name":"player1"},{"id":106,"na...
22	rachelxu@viate...	127.0.0.1	2017/03/08 13:24:34	編輯SOC分組的信息	{"id_name":"{"id":42,"name":"videowall"},"req":"{"client_group_j...
23	rachelxu@viate...	127.0.0.1	2017/03/08 13:24:48	編輯SOC分組的信息	{"id_name":"{"id":42,"name":"videowall"},"req":"{"client_group_j...
24	rachelxu@viate...	127.0.0.1	2017/03/08 17:36:30	註冊SAAS播放機	{"name":"wp1","hardware_id":"wp1","description":"wp1","w":19...
25	rachelxu@viate...	127.0.0.1	2017/03/09 09:09:23	增加用戶組	{"name":"general users","description":"general users"}
26	rachelxu@viate...	127.0.0.1	2017/03/09 09:14:24	新增角色	{"info":{"name":"user@VIAP.com","desc":"user@VIAP.com","pri...
27	rachelxu@viate...	127.0.0.1	2017/03/09 09:14:24	新增用戶	{"name":"user@VIAP.com","desc":"user@VIAP.com","admin_info":{"role_id_arra...
28	rachelxu@viate...	127.0.0.1	2017/03/09 09:27:45	新增升級包	{"setup_file":"{"name":"ClientSetup.msi","description":"ClientSetup.msi","file_ty...

Urgent Case

When there is an urgent need to broadcast in time, user can use the function of emergency information. Once publishing, it will playback immediately.

Step I : Click enter the urgent case publish page.



Step 2 : Choose a playlist from the table or click  to open playlist table to add.

Step 3 : Choose an urgent case, click  to publish. Choose a player group or groups and click ok.

 : Stop to playback urgent case.

 : Delete urgent case from table. User can not delete the case which is playing.

BIOS Setup

Introduction

The BIOS (Basic Input/Output System) installed in the ROM of your computer system supports Intel® processors. The BIOS provides critical low-level support for standard devices such as disk drives, serial ports and parallel ports. It also provides password protection as well as special support for detailed fine-tuning of the chipset controlling the entire system.

BIOS Setup

The BIOS provides a Setup utility program for specifying the system configurations and settings. The BIOS ROM of the system stores the Setup utility. When you turn on the computer, the BIOS is immediately activated. Press the key immediately allows you to enter the Setup utility.

BIOS default password : [DS@HCAA](#)

Warning: It is strongly recommended that you avoid making any changes to the defaults.

Main Settings

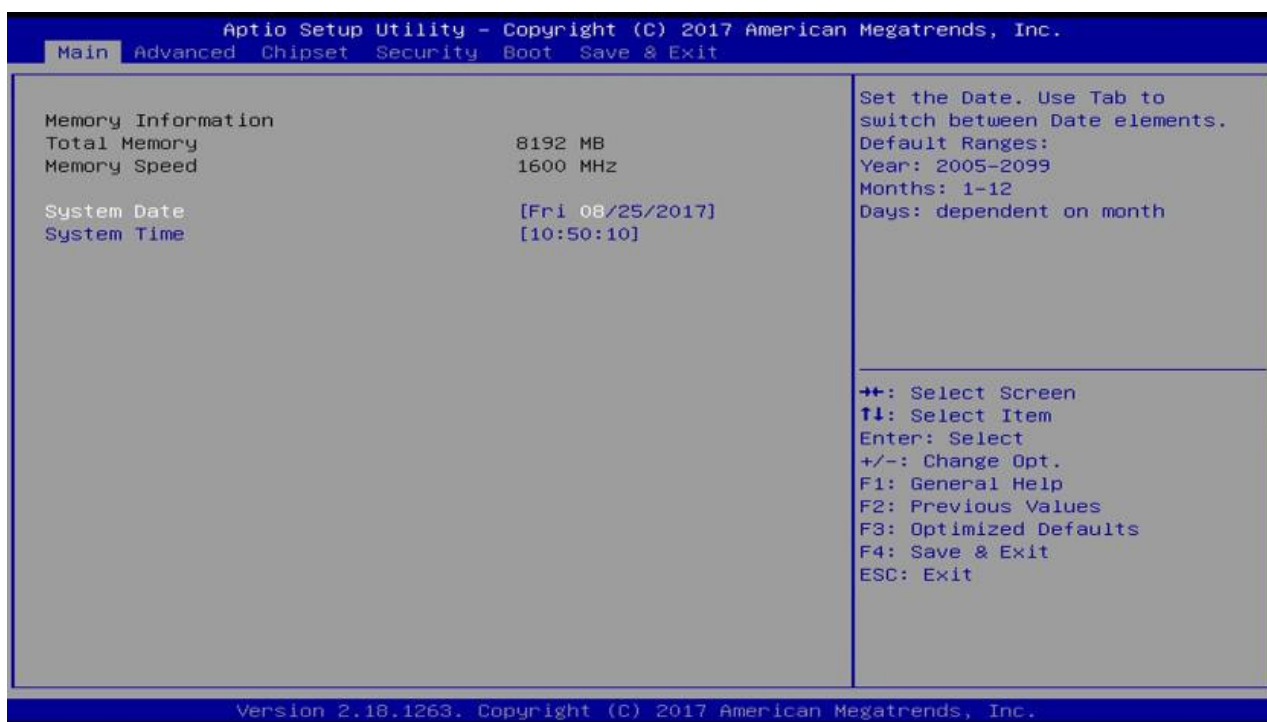

BIOS Setting	Description
System Date	Sets the date. Use the <Tab> key to switch between the data elements.
System Time	Set the time. Use the <Tab> key to switch between the data elements.

Advanced Settings

This section allows you to configure, improve your system and allows you to set up some system features according to your preference.

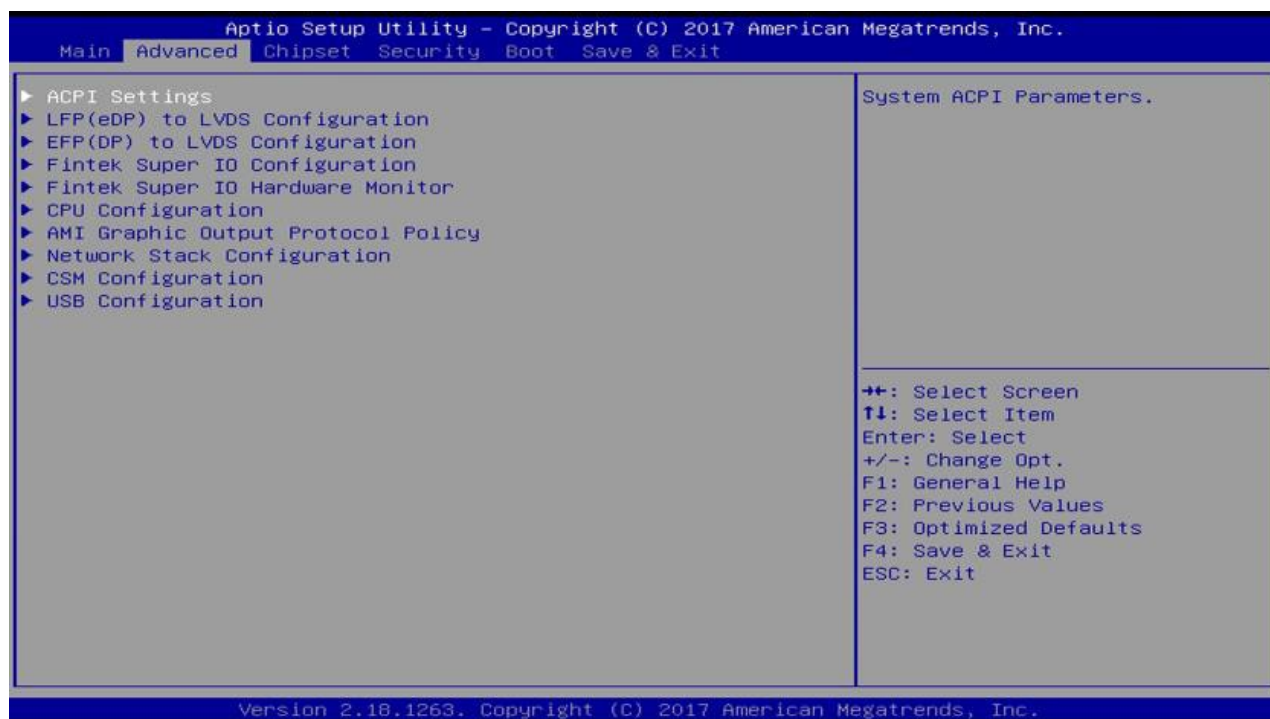

ACPI Computing



BIOS Setting	Description
Enable Hibernation	Enables / Disables the system ability to hibernate (OS/S4 Sleep State). This option may be not effective with some OS.
ACPI Sleep State	Selects an ACPI sleep state (Suspend Disabled or S3) where the system will enter when the Suspend button is pressed.

LFP (eDP) to LVDS Configuration

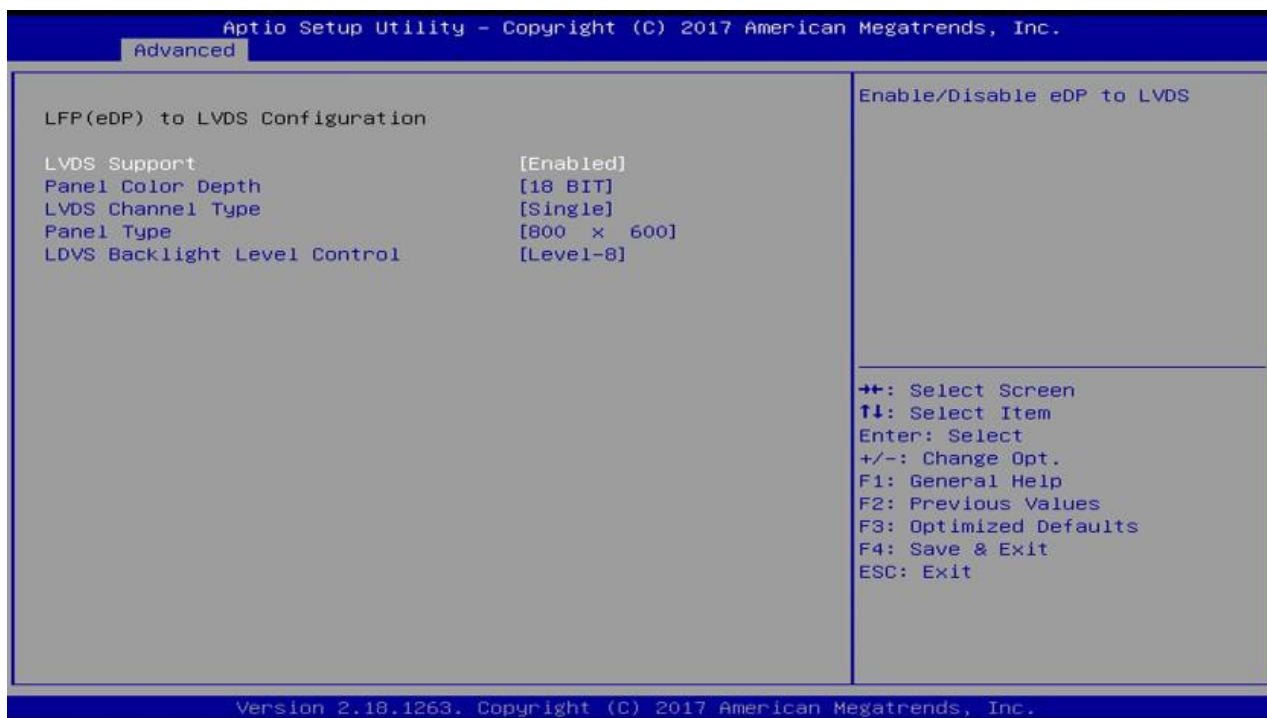

BIOS Setting	Description
LVDS Support	Enables / Disables eDP to LVDS.
Panel Color Depth	Selects a panel color depth as 18 or 24 (VESA or JEIDA) bit.
LVDS Channel Type	Sets the LVDS channel type as single or dual channel.
Panel Type	Selects a resolution that fits your panel. Options: 800 x 600 / 1024 x 768 / 1280 x 1024 / 1366 x 768 / 1440 x 900 / 1600 x 900 / 1920 x 1080
LVDS Backlight Level Control	Selects from Level 1 to Level 8 for the LVDS backlight.

EFP (DP) to LVDS Configuration



BIOS Setting	Description
LVDS Support	Enables / Disables DP to LVDS.
Panel Color Depth	Selects a panel color depth as 18 or 24 (VESA or JEIDA) bit.
LVDS Channel Type	Sets the LVDS channel type as single or dual channel.
Panel Type	Selects a resolution that fits your panel. Options: 800 x 600 / 1024 x 768 / 1280 x 1024 / 1366 x 768 / 1440 x 900 / 1600 x 900 / 1920 x 1080
LVDS Backlight Level Control	Selects from Level 1 to Level 8 for the LVDS backlight.

Fintek Super IO Configuration

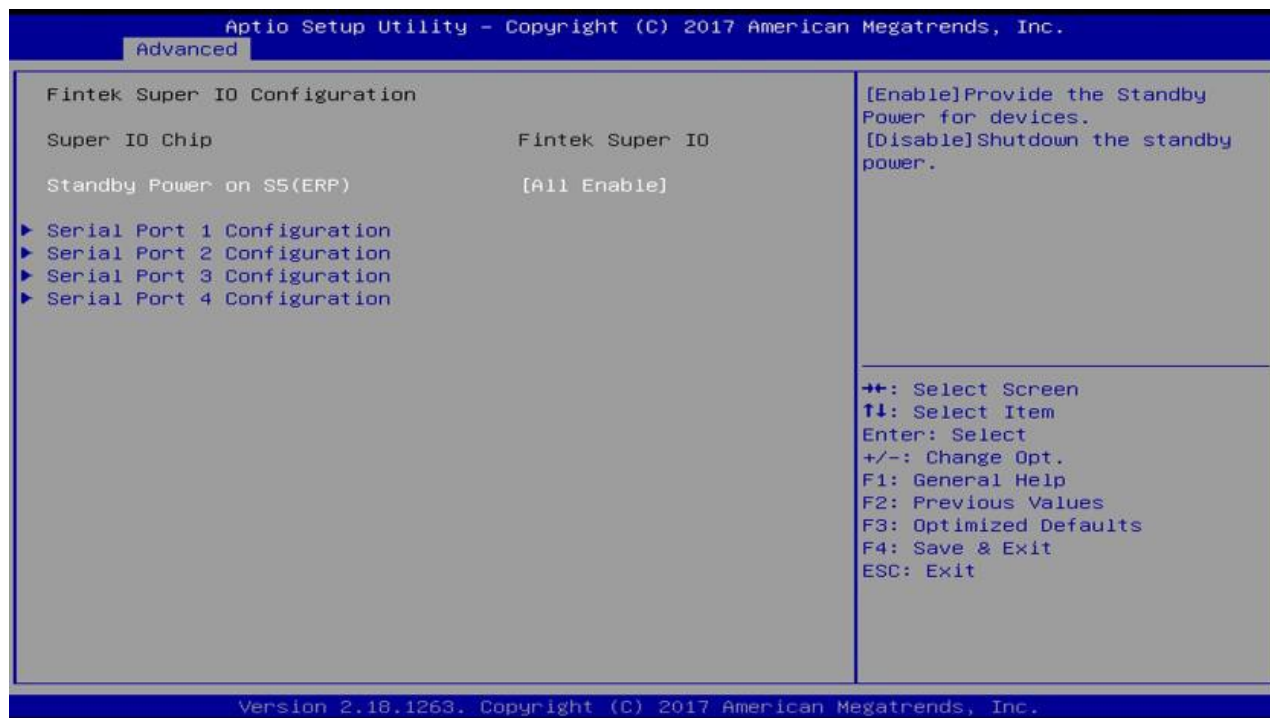

BIOS Setting	Description
Standby Power on S5 (ERP)	Enable the item to provide the standby power for devices. Disable the item to shut down the standby power. Options: All Enable / Enable Ethernet for WOL / All Disable
Serial Ports Configuration	Sets parameters of serial ports. Enables / Disables the serial port and select an optimal setting for the Super IO device.

Serial Port 1 Configuration

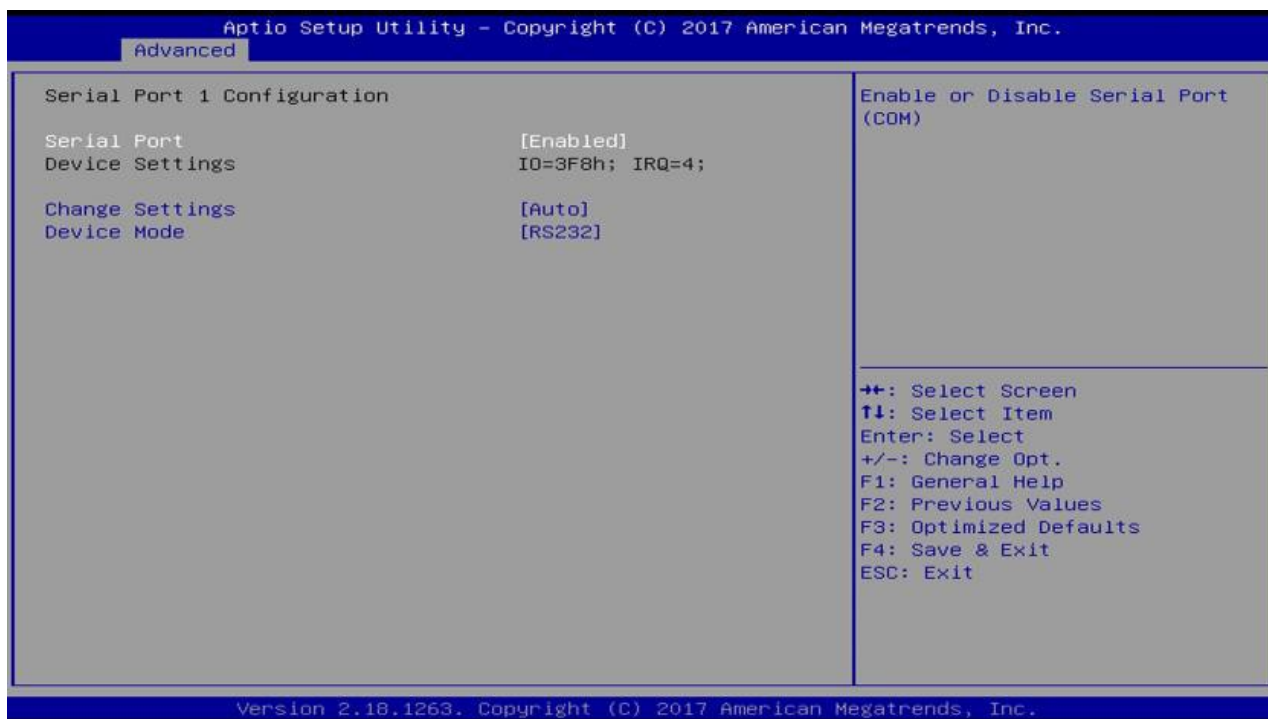

BIOS Setting	Description
Serial Port	Enables / Disables the serial port.
Change Settings	Selects an optimal settings for Super IO device.
Device Mode	Changes the serial port mode to: RS232 RS485 TX Low Active RS485 with Termination TX Low Active RS422 RS422 with Termination

Fintek Super IO Hardware Monitor

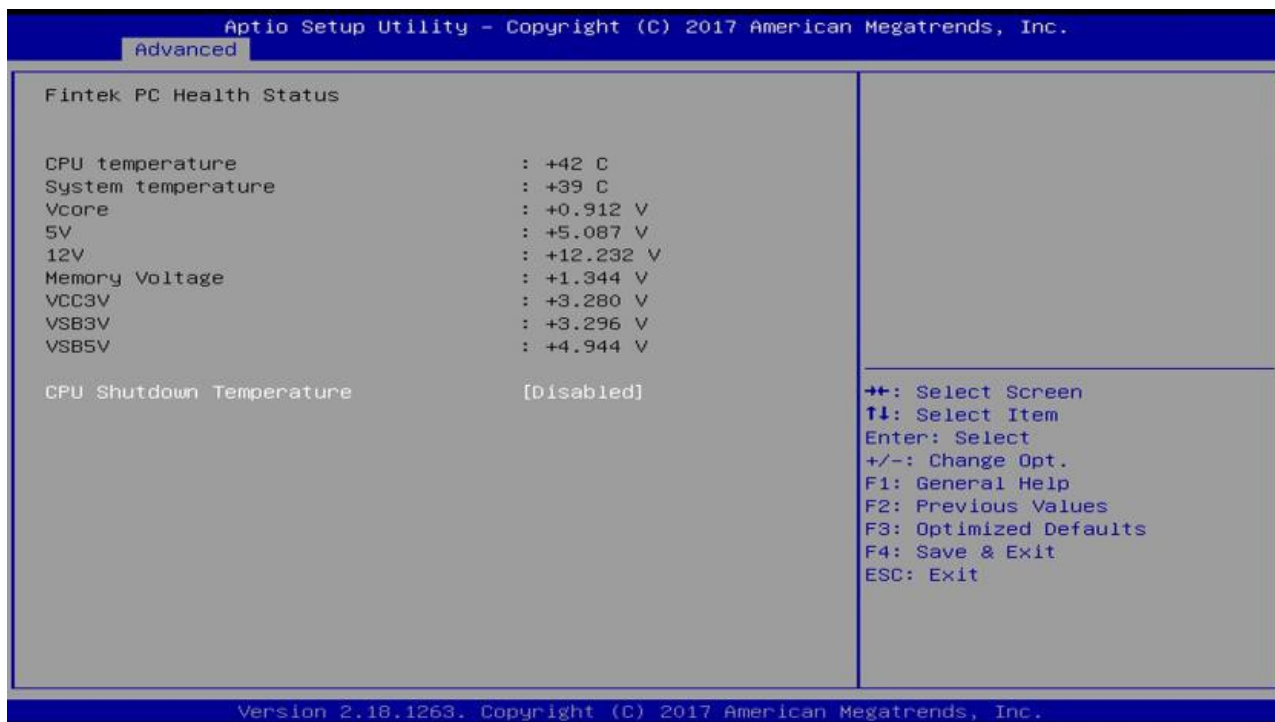

BIOS Setting	Description
Temperatures / Voltages	These fields are the parameters of the hardware monitoring function feature of the motherboard. The values are read-only values as monitored by the system and show the PC health status.
CPU Shutdown Temperature	Sets a threshold of temperature to shut down if CPU goes overheated. Options: Disabled / 70 °C / 75 °C / 80 °C / 85 °C / 90 °C / 95 °C

CPU Configuration



BIOS Setting	Description
Socket 0 CPU Information	Displays the socket specific CPU information.
CPU Power Management	Allows you to enable / disable Turbo Mode.
Active Processor Cores	Enables / Disables the cores in the processor package.
Monitor Mwait	Enables / Disables Monitor Mwait.

Socket 0 CPU Information

Aptio Setup Utility - Copyright (C) 2017 American Megatrends, Inc.

Advanced

Socket 0 CPU Information	
Intel(R) Atom(TM) Processor E3950 @ 1.60GHz	
CPU Signature	506C9
Microcode Patch	28
Processor Cores	4
Intel HT Technology	Not Supported
Intel VT-x Technology	Supported

++: Select Screen
 ↑↓: Select Item
 Enter: Select
 +/-: Change Opt.
 F1: General Help
 F2: Previous Values
 F3: Optimized Defaults
 F4: Save & Exit
 ESC: Exit

Version 2.18.1263. Copyright (C) 2017 American Megatrends, Inc.

CPU Power Management Configuration

Aptio Setup Utility - Copyright (C) 2017 American Megatrends, Inc.

Advanced

CPU Power Management Configuration	
Turbo Mode	[Disabled]

Turbo Mode.

++: Select Screen
 ↑↓: Select Item
 Enter: Select
 +/-: Change Opt.
 F1: General Help
 F2: Previous Values
 F3: Optimized Defaults
 F4: Save & Exit
 ESC: Exit

Version 2.18.1263. Copyright (C) 2017 American Megatrends, Inc.

BIOS Setting	Description
Turbo Mode	Enables / Disables the turbo mode.

AMI Graphic Output Protocol Policy



BIOS Setting	Description
Output Select	Outputs through HDMI interface.

Network Stack Configuration

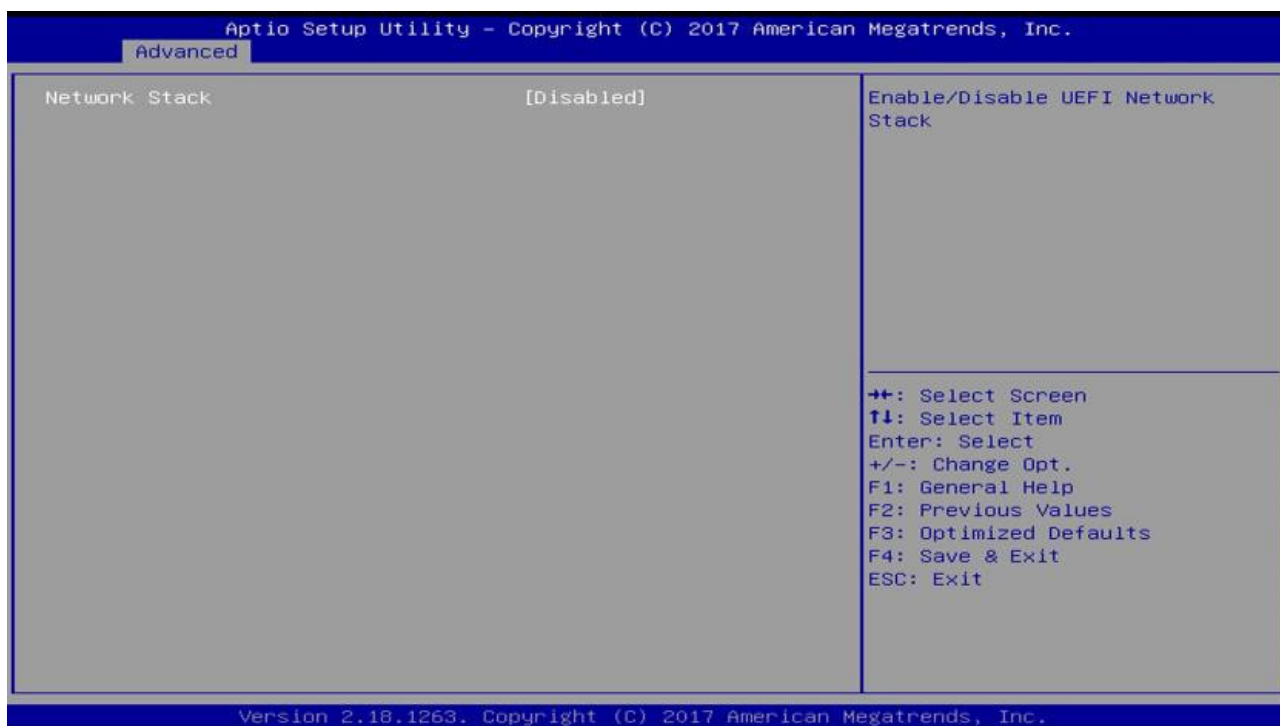

BIOS Setting	Description
Network Stack	Enables / Disables UEFI Network Stack.
IPv4 PXE Support	Enables / Disables IPv4 PXE Boot Support. If disabled, Ipv4 PXE boot option will not be created.
IPv4 HTTP Support	Enables / Disables IPv4 HTTP Boot Support. If disabled, Ipv4 HTTP boot option will not be created.
IPv6 PXE Support	Enables / Disables IPv6 PXE Boot Support. If disabled, Ipv4 PXE boot option will not be created.
IPv6 HTTP Support	Enables / Disables IPv6 HTTP Boot Support. If disabled, Ipv4 HTTP boot option will not be created.
PXE boot wait time	Assigns a period of time to press ESC key to abort the PXE boot.
Media detect count	Assigns a number of times to check the presence of media.

CSM Configuration

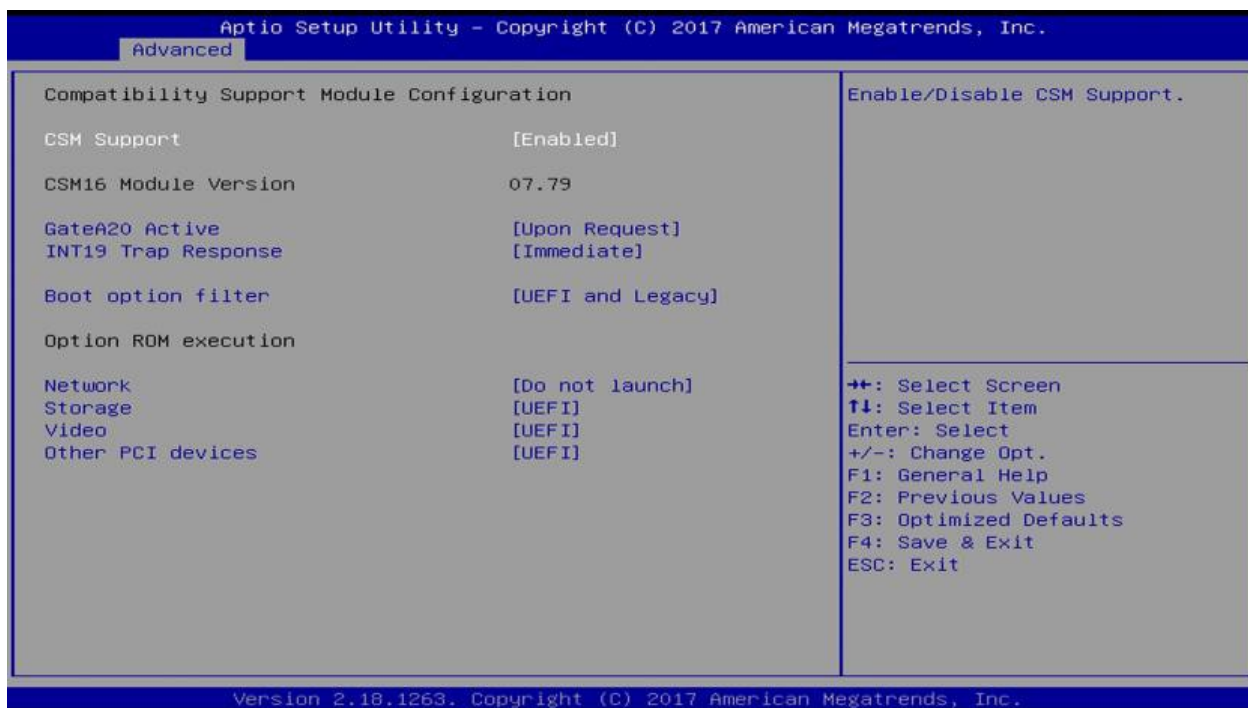

BIOS Setting	Description
CSM Support	Enables / Disables CSM support.
GateA20 Active	Upon Request disables GA20 when using BIOS services. Always cannot disable GA20, but is useful when any RT code is executed above 1 MB.
INT19 Trap Response	Sets how BIOS reacts on INT19 trap by Option ROM. Immediate executes the trap right away. Postponed executes the trap during legacy boot.
Boot option filter	Controls the priority of Legacy and UEFI ROMs.
Network	Controls the execution of UEFI and Legacy PXE OpROM.
Storage	Controls the execution of UEFI and Legacy Storage OpROM.
Video	Controls the execution of UEFI and Legacy Video OpROM.
Other PCI devices	Determines OpROM execution policy for devices other than network, storage or video.

USB Configuration

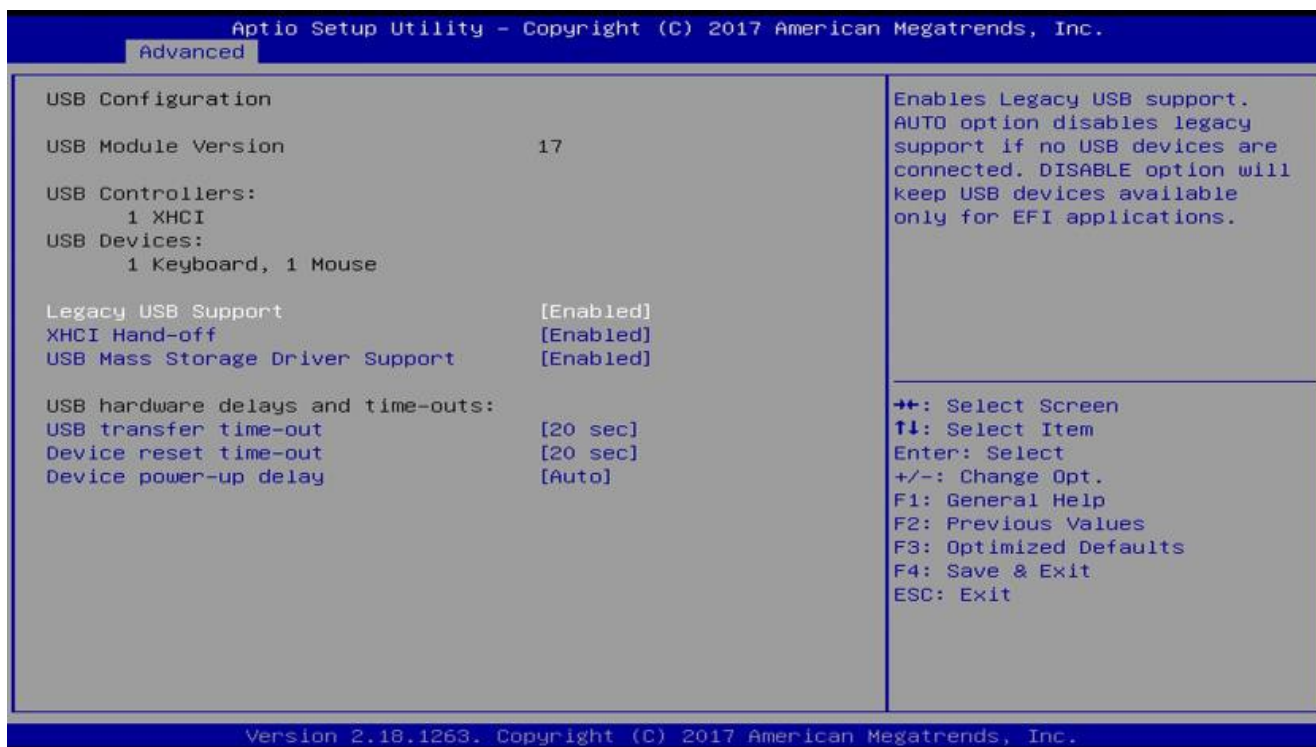

BIOS Setting	Description
Legacy USB Support	Enabled enables Legacy USB support. Auto disables legacy support if there is no USB device connected. Disabled keeps USB devices available only for EFI applications.
XHCI Hand-off	This is a workaround for OSes without XHCI hand-off support. The XHCI ownership change should be claimed by XHCI driver.
USB Mass Storage Driver Support	Enables / Disables the support for USB mass storage driver.
USB Transfer time-out	The time-out value (1 / 5 10 / 20 secs) for Control, Bulk, and Interrupt transfers.
Device reset time-out	Gives seconds (10 / 20 / 30 / 40 secs) to delay execution of Start Unit command to USB mass storage device.
Device power-up delay	The maximum time the device will take before it properly reports itself to the Host Controller. Auto uses default value for a Root port it is 100ms. But for a Hub port, the delay is taken from Hub descriptor.

Chipset Settings

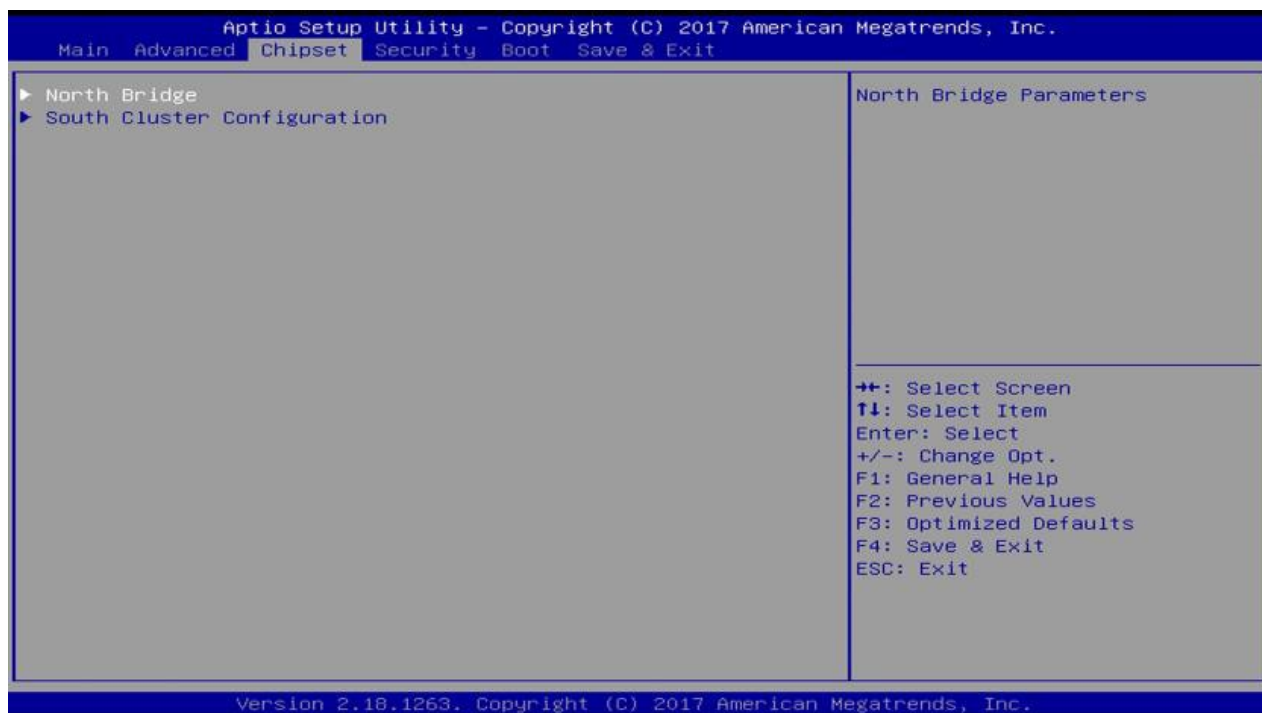

North Bridge



BIOS Setting	Description
Max TOLUD	Sets a maximum value of TOLUD.

South Cluster Configuration

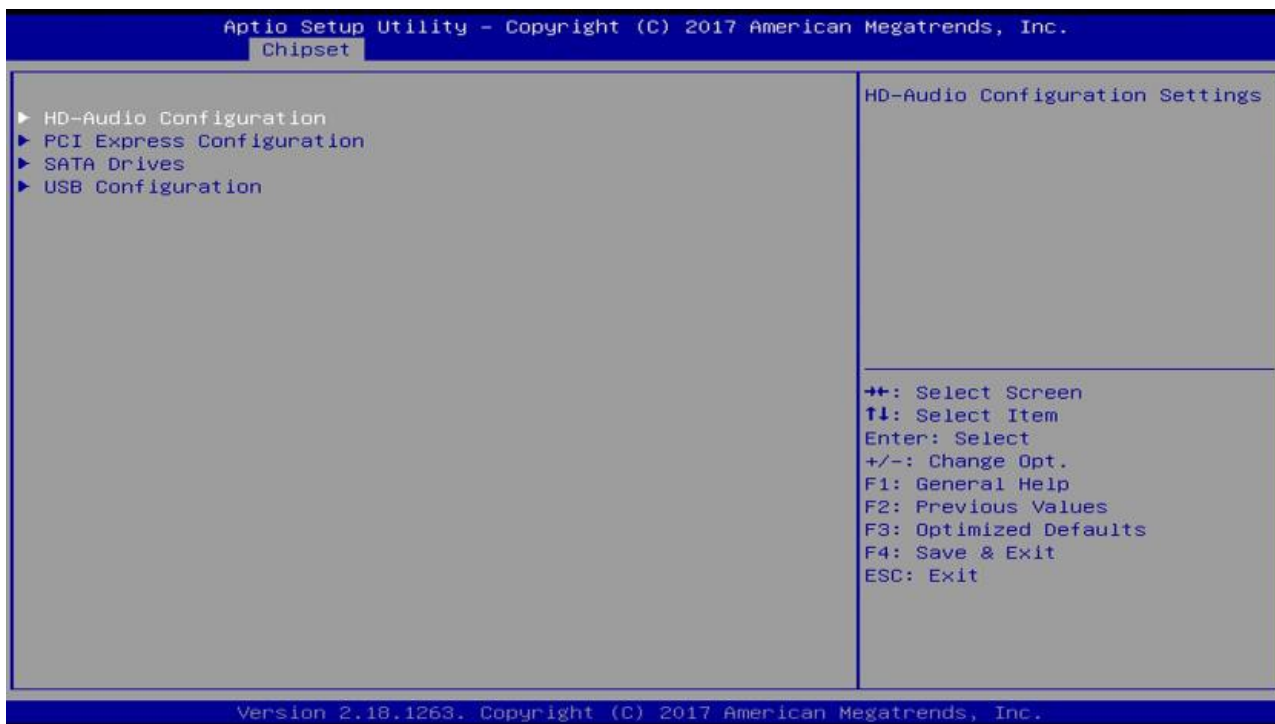

HD Audio Configuration



BIOS Setting	Description
HD-Audio Support	Enables / Disables HD-Audio support.

PCI Express Configuration

Aptio Setup Utility - Copyright (C) 2017 American Megatrends, Inc.

Chipset

PCI Express Configuration ▶ PCI Express Root Port 1 ▶ PCI Express Root Port 2 ▶ PCI Express Root Port 3 ▶ PCI Express Root Port 4 ▶ PCI Express Root Port 5 ▶ PCI Express Root Port 6	Control the PCI Express Root Port. AUTO: To disable unused root port automatically for the most optimum power savings. Enable: Enable PCIe root port Disable: Disable PCIe root port
---	---

++: Select Screen
 ↑↓: Select Item
 Enter: Select
 +/-: Change Opt.
 F1: General Help
 F2: Previous Values
 F3: Optimized Defaults
 F4: Save & Exit
 ESC: Exit

Version 2.18.1263. Copyright (C) 2017 American Megatrends, Inc.

BIOS Setting	Description
PCI Express Root Port 1 ~ 6	Accesses the control of the PCI Express Root Port.

Aptio Setup Utility - Copyright (C) 2017 American Megatrends, Inc.

Chipset

PCI Express Root Port 1 [Enable] If DISABLED, goto ENABLE first the ASPM [Disable] L1 Substates [Disabled] PME SCI [Disable] PCIe Speed [Auto]	Control the PCI Express Root Port. AUTO: To disable unused root port automatically for the most optimum power savings. Enable: Enable PCIe root port Disable: Disable PCIe root port
--	---

++: Select Screen
 ↑↓: Select Item
 Enter: Select
 +/-: Change Opt.
 F1: General Help
 F2: Previous Values
 F3: Optimized Defaults
 F4: Save & Exit
 ESC: Exit

Version 2.18.1263. Copyright (C) 2017 American Megatrends, Inc.

BIOS Setting	Description
PCI Express Root Port	Enables/ Disables the PCIe root port.
ASPM	Auto allows you to disable unused root port automatically for the most optimum power savings.
LI Substates	Sets the PCIe active state power management. Options: Disable / L0s / L1 / L0SL1 / Auto
PME SCI	Sets PCIe L1 substates. Options: Disables / L1.1 / L1.2 / L1.1 & L1.2
PCIe Speed	Enables / Disables PME SCI.
	Configures the PCIe speed. Options: Auto, Gen1, Gen2

SATA Drivers

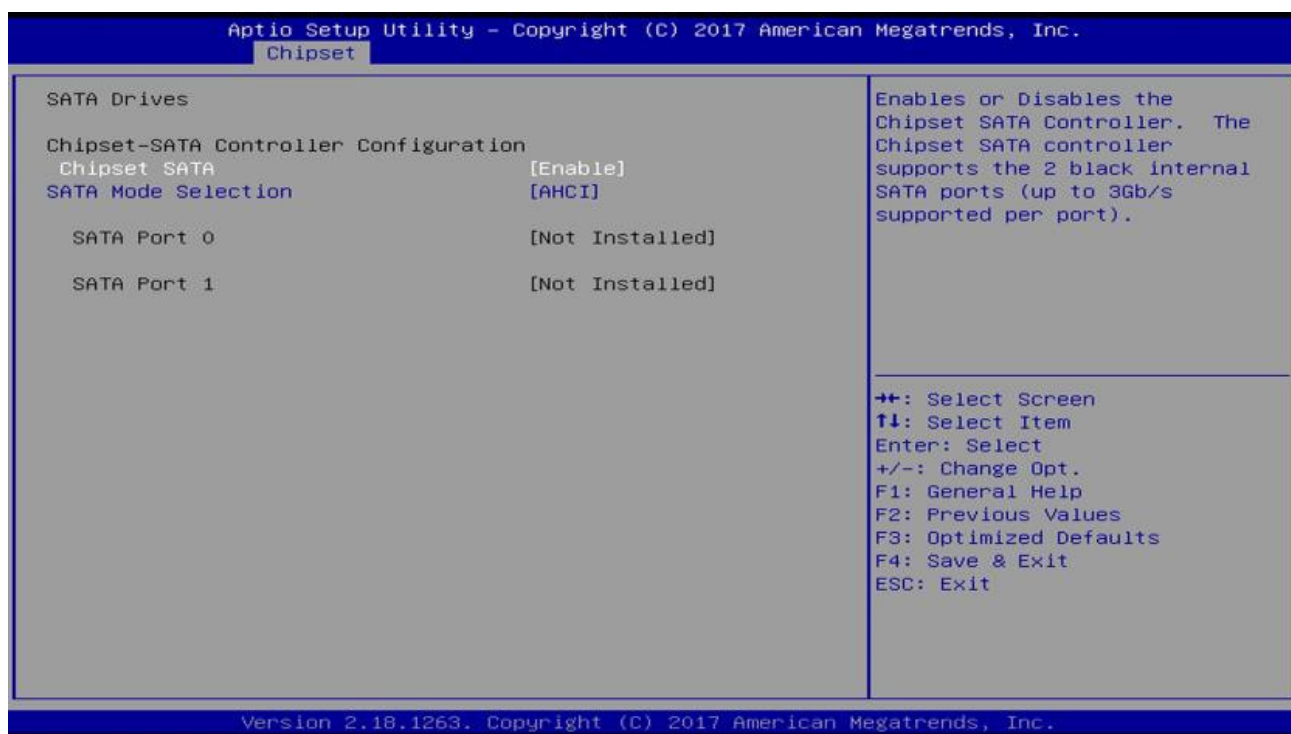

BIOS Setting	Description
Chipset SATA	Enables / Disables the Chipset SATA Controller. The Chipset SATA Controller supports the 2 black internal SATA ports (up to 3Gb/s supported per port).
SATA Mode Selection	Determines how SATA controller(s) operate.

USB Configuration

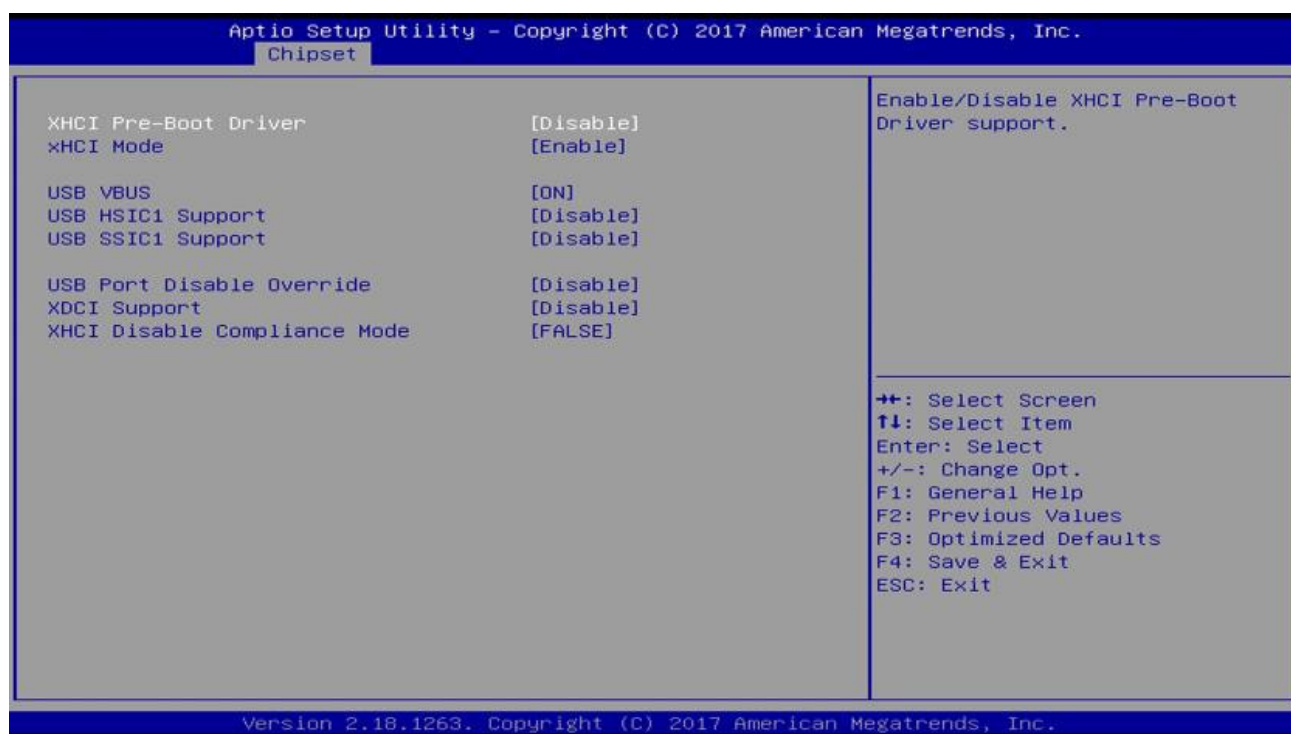

BIOS Setting	Description
XHCI Pre-Boot Driver	Enables / Disables the support for XHCI Pre-Boot Driver.
XHCI Mode	Enables / Disables XHCI mode. If disabled, XHCI controller would be disabled, and none of the USB devices are detectable or usable when system is booted up in OS. Do NOT disable it unless for debug purpose.
USB VBUS	VBUS should be ON in HOST mode. It should be OFF in OTG device mode.
USB HSIC1 Support	Enables / Disables USB HSIC1.
USB SSIC1 Support	Enables / Disables USB SSIC1.
USB Port Disable Override	Selectively enables / disables the corresponding USB port from reporting a device connection to the controller.
XDCI Support	Enables / Disables XDCI.
XHCI Disable Compliance Mode	FALSE makes the XHCI Link Compliance Mode not disabled. TRUE disables the XHCI Link Compliance Mode.

Security Settings

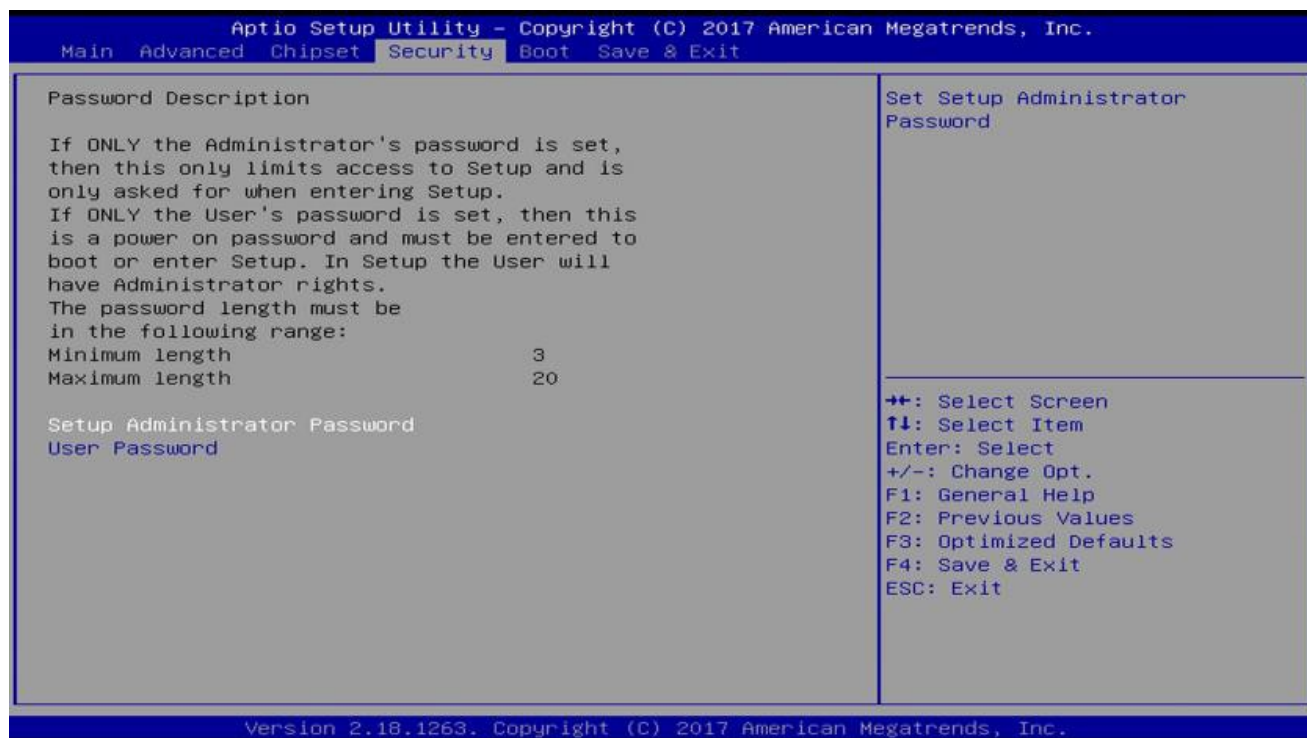

BIOS Setting	Description
Setup Administrator Password	Sets an administrator password for the setup utility.
User Password	Sets a user password.

Boot Settings

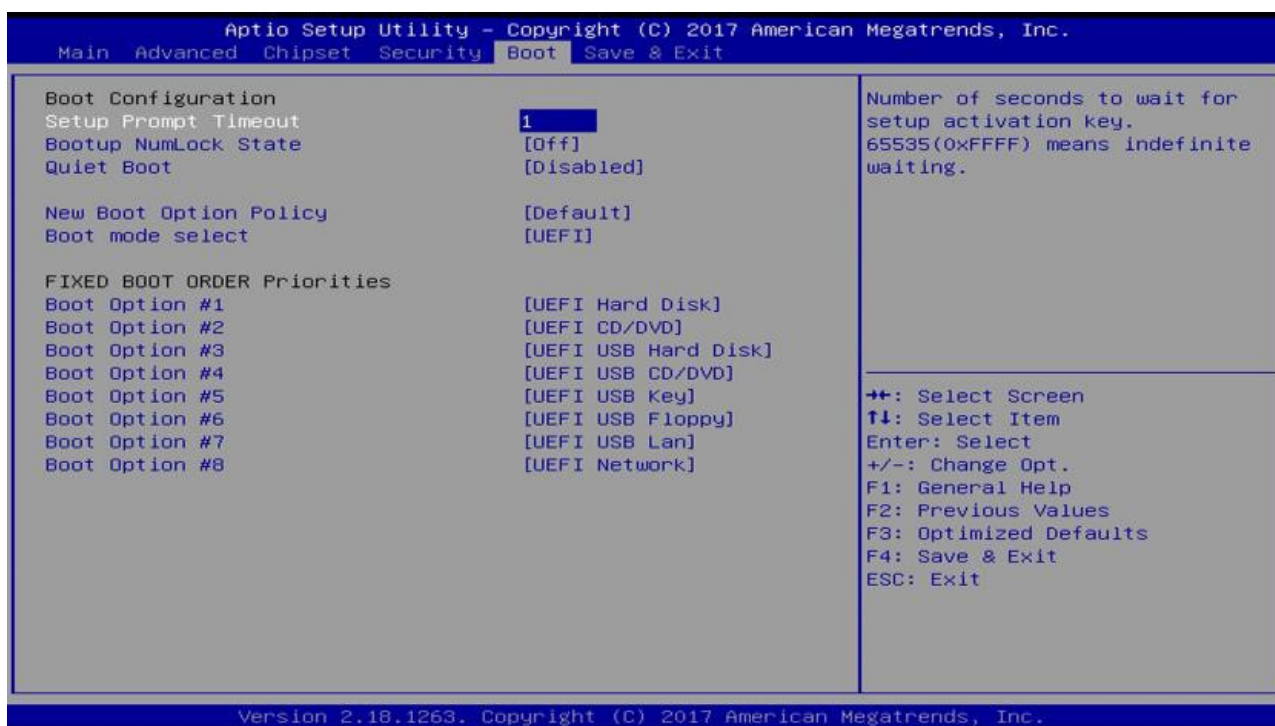

BIOS Setting	Description
Setup Prompt Timeout	Number of seconds to wait for setup activation key. 65535 (0xFFFF) means indefinite waiting.
Bootup NumLock State	Selects the keyboard NumLock state.
Quiet Boot	Enables / Disables Quiet Boot option.
New Boot Option Policy	Controls the placement of newly detected UEFI boot options. Options: Default, Place First, Place Last
Boot mode select	Selects a Boot mode, Legacy / UEFI / Dual.
Boot Option Priorities	Sets the system boot order priorities for hard disk, CD/DVD, USB, Network.

Save & Exit Settings



BIOS Setting	Description
Save Changes and Exit	Exits system setup after saving the changes.
Discard Changes and Exit	Exits system setup without saving any changes.
Save Changes and Reset	Resets the system after saving the changes.
Discard Changes and Reset	Resets system setup without saving any changes.
Save Changes	Saves changes done so far to any of the setup options.
Discard Changes	Discards changes done so far to any of the setup options.
Restore Defaults	Restores / Loads defaults values for all the setup options.
Save as User Defaults	Saves the changes done so far as User Defaults.
Restore User Defaults	Restores the user defaults to all the setup options.

