

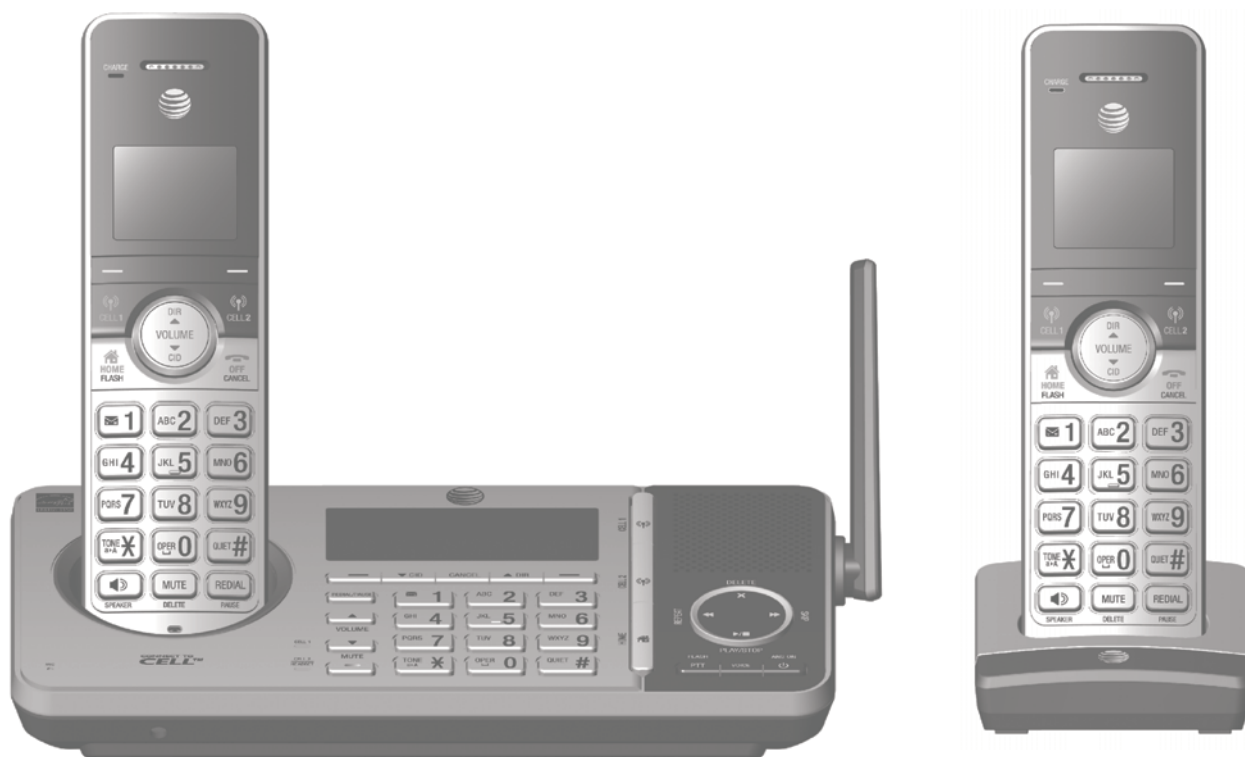

Complete user's manual

TL96276/TL96456

DECT 6.0 cordless telephone/
answering system with
BLUETOOTH® wireless technology



Congratulations

on purchasing your new AT&T product. Before using this AT&T product, please read the **Important safety information** section on pages 160-162 of this manual. Please thoroughly read this Complete user's manual for all the feature operations and troubleshooting information necessary to install and operate your new AT&T product. You can also visit our website at **www.telephones.att.com** or call **1 (800) 222-3111**. In Canada, dial **1 (866) 288-4268**.

This telephone meets the California Energy Commission regulations for energy consumption. Your telephone is set up to comply with the energy-conserving standards right out of the box. No further action is necessary.

This telephone system is compatible with certain AT&T DECT 6.0 cordless headsets and speakerphones. Visit **www.telephones.att.com/accessories** for a list of compatible cordless headsets and speakerphones.

Model number: TL96276 (two handsets)
TL96456 (four handsets)

Type: DECT 6.0 cordless telephone/answering system with
BLUETOOTH® wireless technology

Serial number: _____

Purchase date: _____

Place of purchase: _____

Both the model and serial numbers of your AT&T product can be found on the bottom of the telephone base.

Save your sales receipt and original packaging in case it is necessary to return your telephone for warranty service.



Telephones identified with this logo have reduced noise and interference when used with most T-coil equipped hearing aids and cochlear implants. The TIA-1083 Compliant Logo is a trademark of the Telecommunications Industry Association. Used under license.



The ENERGY STAR® program (www.energystar.gov) recognizes and encourages the use of products that save energy and help protect our environment. We are proud to mark this product with the ENERGY STAR® label indicating it meets the latest energy efficiency guidelines.

The *Bluetooth*® word mark and logos are owned by Bluetooth SIG, Inc. and any use of such marks by Advanced American Telephones and its parent, VTech Holdings Limited, is under license. VTech Holdings Limited is a member of Bluetooth SIG, Inc. Other trademarks and trade names are those of their respective owners.

© 2016 Advanced American Telephones. All Rights Reserved. AT&T and the AT&T logo are trademarks of AT&T Intellectual Property licensed to Advanced American Telephones, San Antonio, TX 78219. Printed in China.

Parts checklist

Your telephone package contains the following items. Save your sales receipt and original packaging in the event warranty service is necessary.

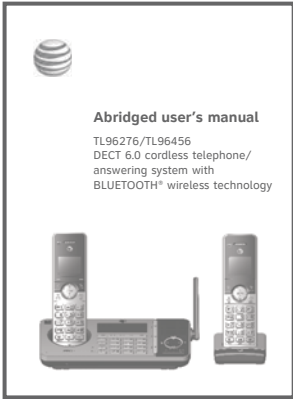

Abridged user's manual

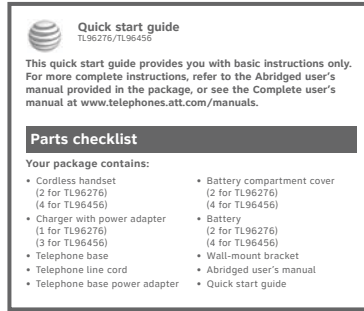

Quick start guide

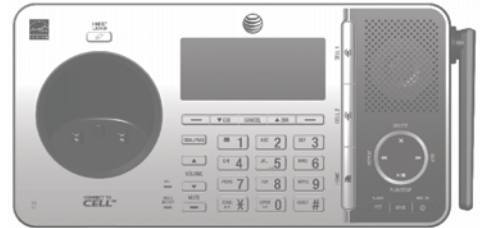

Telephone base



Cordless handset
(2 for TL96276)
(4 for TL96456)

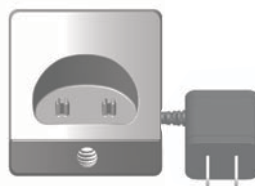

Charger for cordless handset
with power adapter installed
(1 for TL96276)
(3 for TL96456)



Battery for cordless handset
(2 for TL96276)
(4 for TL96456)



Battery compartment cover
(2 for TL96276)
(4 for TL96456)



Power adapter for
telephone base



Telephone line cord

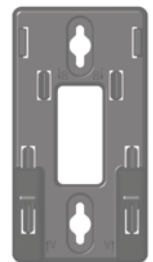

Wall-mount bracket

Complete user's manual

TL96276/TL96456

DECT 6.0 cordless telephone/
answering system with
BLUETOOTH® wireless technology



Table of contents

Getting started

Installation.....	1
Quick reference guide - telephone base.....	2
Quick reference guide - handset.....	6
Telephone base and charger installation.....	9
Telephone base installation.....	9
Charger installation.....	10
Battery installation and charging.....	11
Battery backup mode.....	14
To activate the mode.....	14
Operation.....	14
Installation options.....	15
Tabletop to wall-mount installation.....	15
Wall-mount to tabletop installation.....	16

Bluetooth

Introducing Bluetooth.....	17
Connect to Cell™ application.....	19
Glossary of terms.....	20
Bluetooth setup.....	21
Add a cell phone.....	21
Add a headset.....	23
Auto connection.....	24
Bluetooth connection from idle mode.....	24
Device list and connection.....	25

Review the device list.....	25
Connect/disconnect an active device.....	25
Remove a device.....	26
Replace an active device.....	27
Download directory.....	28
Interruption to directory download.....	30
View the directory download information.....	30
Change PIN.....	31
Cell ringer.....	31
Remote voice control.....	32
Activate remote voice control.....	33

Telephone settings

Handset and telephone base settings.....	35
Ringer volume.....	36
Ringer tone.....	37
LCD language.....	38
Set date and time.....	39
Caller ID announce.....	40
Set speed dial voicemail number.....	41
Voicemail (visual message waiting) indicator.....	42
Clear voicemail indicator/indication.....	42
Key tone.....	43

Use caller ID to automatically set date and time	44
Home area code.....	45
Cell area code.....	46
Dial mode	47
Web address	47
QUIET mode	48
No line alert.....	49
Cell alert	49

Telephone operation

Telephone operation.....	50
Make, answer or end a home call.....	50
Make, answer or end a cell call....	52
Silence the ringer	53
Call waiting on the home line	53
Call waiting on the cell line.....	53
Cell phone voicemail.....	54
Answer an incoming cell call while on a home call.....	54
Answer an incoming home call while on a cell call	55
Conference calls.....	56
Conference home and cell calls...	56
Options while on calls.....	58
Handset speakerphone.....	58
Volume control	58
Mute	59
Temporary tone dialing	59
Hold.....	60
Equalizer.....	60
Chain dialing	61
Redial.....	63
Last number redial.....	63
Dial a redial entry.....	63
Insert the area code to the redial number.....	64
Save a redial entry to the directory	65
Delete a redial entry.....	66
Handset locator.....	67

Multiple handset use

Join a call in progress	68
Intercom.....	69
Initiate an intercom call.....	69
Answer an intercom call.....	71
End an intercom call.....	71
Answer an incoming call during an intercom call.....	72
Call transfer using intercom	73
Push-to-talk (PTT)	76
Turn PTT incoming signal on or off.....	76
PTT call to a single device.....	77
PTT call to multiple devices.....	79
Answer a PTT call.....	81
Change a one-to-one PTT call to an intercom call	82
Answer an incoming call during PTT.....	82
Make an outgoing call during PTT.....	83
End or leave a PTT call.....	83

Directory

About the directory.....	84
Create and review entries.....	85
Create a new entry in the home directory	85
Add a predialed telephone number to the directory.....	88
Review the directory.....	89
Search by name.....	90
Dial a directory entry.....	90
Edit or delete entries	91
Edit a directory entry.....	91
Edit the label of a directory entry	93
Delete a directory entry.....	93
Remove a downloaded directory.....	93

Caller ID

About caller ID	94
Information about caller ID with call waiting.....	94
Caller ID operation	95
How the caller ID log works	95
Missed (new) call indicator	95
Memory match.....	95
Review the caller ID log.....	96
View dialing options.....	97
Dial a caller ID log entry	97
Save a caller ID log entry to the directory.....	98
Delete caller ID log entries	100
Reasons for missing caller ID information	101

Call block

Call block	102
Add a call block entry.....	103
Review the call block list	105
Save a caller ID log entry to call block list.....	105
Edit a call block entry	107
Delete a call block entry	108
Block calls without number	108
Mute first ring.....	108

Answering system

Answering system settings.....	109
Announcement	109
Answer on/off.....	111
Voice guide	112
Call screening.....	113
Number of rings.....	114
Remote access code	115
Message alert tone	116
Message recording time.....	117
About the answering system.....	118
Answering system and voicemail	118

Use the answering system and voicemail together	118
Message capacity	119
Voice prompts	119
Call screening.....	120
Call intercept	121
Temporarily turn off the message alert tone.....	121
Message playback.....	122
Options during playback.....	123
Delete all old messages.....	125
Record and play memos.....	126
Record a memo	126
Playback a memo	126
Remote access.....	127
To remotely access the answering system.....	127

Appendix

Add and register handsets/ headsets/speakerphones.....	129
Register a handset to your telephone base.....	129
Deregister handsets	131
Deregister all handsets from the telephone base	131
Screen icons.....	132
Handset screen icons	132
Telephone base screen icons ...	133
Alert tones.....	134
Handset alert tones.....	134
Telephone base alert tones.....	135
Lights.....	136
Handset indicator lights	136
Telephone base indicator lights	136
Screen messages.....	137
Troubleshooting	142
Maintenance.....	159
Important safety information	160
Safety information.....	160

Especially about cordless telephones	161
Precautions for users of implanted cardiac pacemakers...	162
ECO mode	162
Especially about telephone answering systems.....	162
FCC Part 68 and ACTA.....	163
FCC Part 15.....	164
California Energy Commission battery charging testing instructions.....	165
Limited warranty.....	166
Technical specifications	168
DECT 6.0 digital technology.....	168
Telephone operating range	168
Redefining long range coverage and clarity	168
HD audio	168
Simulated full-duplex handset and base speakerphones.....	168

Index

Index	169
-------------	-----

Getting started Installation

You must install and charge the battery before using the cordless handset.



STOP!

See pages 11-13 for easy instructions.

Install the telephone base close to a telephone jack and a power outlet not controlled by a wall switch. The telephone base can be placed on a flat surface or vertically mounted on the wall (page 15). For optimum range and better reception, place the telephone base in a central and open location.

You may hear interference if your cellular phone is too close to the telephone base during a **CELLULAR** call. Make sure that your Bluetooth enabled cellular phone is within 15 feet of the telephone base in order to maintain a clear and consistent connection between your Bluetooth cell phone, telephone base and cell tower.

If you subscribe to high-speed Internet service (DSL - digital subscriber line) through your telephone line, you must install a DSL filter between the telephone line cord and the telephone wall jack (page 9). The filter prevents noise and caller ID problems caused by DSL interference. Please contact your DSL service provider for more information about DSL filters.

Your product may be shipped with a protective sticker covering the handset or telephone base display - remove it before use.

For customer service or product information, visit our website at **www.telephones.att.com** or call **1 (800) 222-3111**. In Canada, dial **1 (866) 288-4268**.

Avoid placing the telephone base and charger too close to:

- Communication devices such as television sets, VCRs, or other cordless telephones.
- Excessive heat sources.
- Noise sources such as a window with traffic outside, motors, microwave ovens, refrigerators, or fluorescent lighting.
- Excessive dust sources such as a workshop or garage.
- Excessive moisture.
- Extremely low temperature.
- Mechanical vibration or shock, such as on top of washing machine or workbench.

Quick reference guide - telephone base

REDIAL/PAUSE

- Press repeatedly to view the last 10 numbers dialed (page 63).
- While entering numbers, press and hold to insert a dialing pause (page 50).

/HANDSET LOCATOR

- Press the button to page all system handsets (page 67).

1

- While reviewing a caller ID log entry, press repeatedly to add or remove 1 in front of the telephone number before dialing or saving it in the directory (page 97).
- Press and hold to set (page 41) or dial your voicemail number.

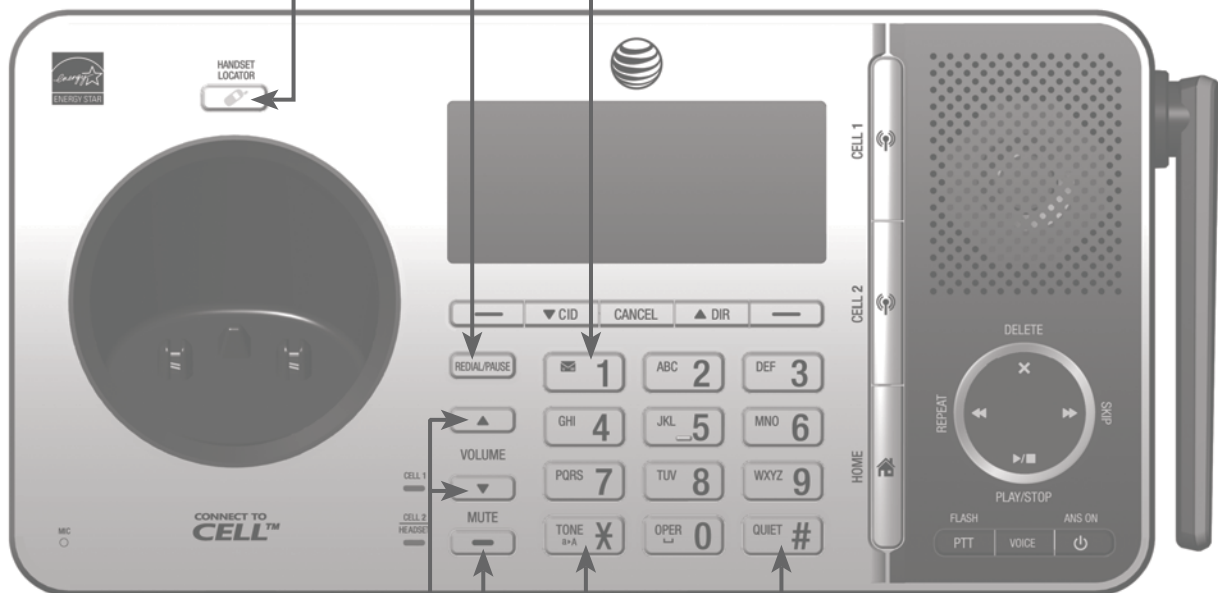

/VOLUME/

- Press to adjust the volume during message playback (page 123).
- Press to adjust the volume during a call (page 58).
- When the phone is not in use, press to adjust the telephone base ringer volume for all lines (page 36).

MUTE

- During a call, press to mute the microphone (page 59).
- While the telephone base is ringing, press to silence the ringer temporarily (page 53).

QUIET # (pound key)

- Press repeatedly to display other dialing options when reviewing a caller ID log entry (page 97).
- Press and hold to enter the **QUIET** mode setting screen, or to deactivate **QUIET** mode (page 48).

tone /a>A

- Press to switch to tone dialing temporarily during a call if you have pulse service (page 59).
- Switch between upper case and lower case while entering characters (page 86).

Quick reference guide - telephone base

CANCEL

- While in a menu, press to exit without making changes or press and hold to return to idle mode.
- Press and hold while the telephone is not in use to erase the displayed messages (**XX Missed calls**, page 95).

▲DIR

- Press to scroll up while in a menu.
- Press to show directory entries when the telephone is not in use (page 89).
- While entering names or numbers, press to move the cursor to the right.

▼CID

- Press to scroll down while in a menu.
- Press to review the caller ID log when the telephone is not in use (page 96).
- While entering names or numbers, press to move the cursor to the left.

CELL 1/ CELL 2/HEADSET lights

- On when the telephone base is paired and connected with a Bluetooth device.
- Flash alternately while pairing a Bluetooth device.
- Flashes quickly when there is an incoming cell call.

Softkeys (2)

- Press to select the menu item displayed above the key (page 5).
- While in a menu, press to select an item or save an entry or setting, cancel an operation, or back up to the previous menu.

CELL 1

- Press to make, answer or end a cell call on CELL 1 line (page 52).
- During a call, press to answer an incoming call on CELL 1 line when you hear a call waiting alert (page 53).

CELL 2

- Press to make, answer or end a cell call on CELL 2 line (page 52).
- During a call, press to answer an incoming call on CELL 2 line when you hear a call waiting alert (page 53).

HOME (Speakerphone)

- Press to make or answer a home call using the speakerphone (page 50).
- Flashes quickly when there is an incoming home call.
- Flashes slowly when a home call is on hold.

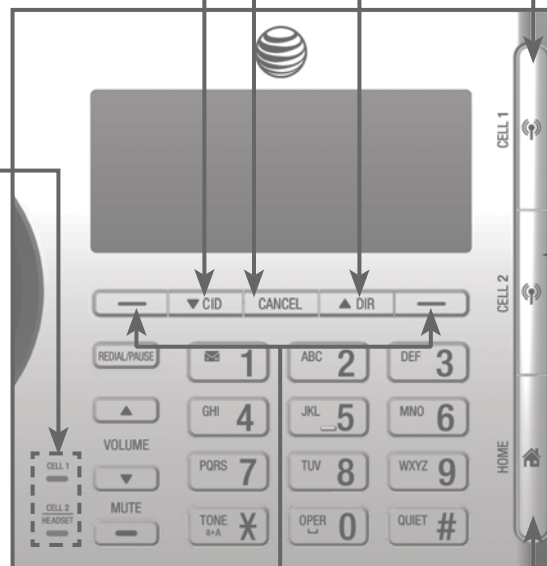

Quick reference guide - telephone base

X/DELETE

- Press to delete the message currently playing (page 123).
- When the phone is not in use, press twice to delete all previously reviewed messages (page 125).
- While entering names or numbers, press to delete a digit or a character.
- While reviewing the redial list, directory, caller ID log or call block list, press to delete an individual entry (pages 66, 93, 100 and 108).
- While predialing, press to delete a digit (page 50).

▶/SKIP

- Press to skip to the next message (page 123).

◀/REPEAT

- Press to repeat a message (page 123).
- Press twice to play the previous message (page 123).

▶/■/PLAY/STOP

- Press to play messages (page 122).
- Press to stop message playback (page 123).

PTT/FLASH

- Press to display the PTT menu to begin a PTT call (page 78).
- Press and hold to begin a one-to-group broadcast (page 80).

⏻/ANS ON

- Press to turn the answering system on or off (page 111).

VOICE

- Press to activate the voice-controlled application of connected cell phone (pages 32-34).



Main menu

The selected menu item is highlighted.

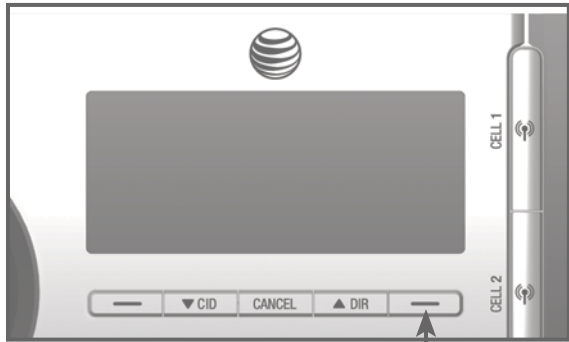

Menu

Feature menu

- Answering sys (page 109)
- Directory (page 84)
- Caller ID log (page 94)
- Intercom (page 69)
- Call block (page 102)
- Bluetooth (page 21)
- Ringers (page 36)
- Set date/time (page 39)
- Caller ID annc (page 40)
- Settings (page 38)
- Web address (page 47)

Using menus

1. Press **MENU** in idle mode (when the telephone is not in use) to enter the main menu.
2. Use **▼CID** or **▲DIR** to scroll through menu items.
3. Press **SELECT** to select or save the highlighted item.

-OR-

Press **BACK** or **CANCEL** to cancel an operation, back up to the previous menu, or exit the menu display.

Quick reference guide - handset

CHARGE light

- On when the handset is charging in the telephone base or charger (page 12).

Softkeys (2)

- Press to select the menu item displayed above the key (page 8).
- While in a menu, press to select an item or save an entry or setting, cancel an operation, or back up to the previous menu.

CELL 1 / CELL 2

- Press to make or answer a cell call (page 52).
- During a call, press to answer an incoming CELL 1/2 call when you hear a call waiting alert (page 53).

HOME/FLASH

- Press to make or answer a home call (page 50).
- During a call, press to answer an incoming home call when you hear a call waiting alert (page 53).
- During message playback, press to call back the caller if the caller's number is available (page 124).

1

- While reviewing a caller ID log entry, press repeatedly to add or remove **1** in front of the telephone number before dialing or saving it in the directory (page 97).
- Press and hold to set (page 41) or dial your voicemail number.

TONE*/a>A

- Press to switch to tone dialing temporarily during a call if you have pulse service (page 59).
- While entering names, press to change the next letter to upper or lower case.

SPEAKER

- Press to make or answer a home call using the speakerphone (page 50).
- Press to answer a cell call using the speakerphone (page 53).
- Press to switch between the speakerphone and the handset (page 58).

REDIAL/PAUSE

- Press repeatedly to view the last 10 numbers dialed (page 63).
- While entering numbers, press and hold to insert a dialing pause (page 50).



Quick reference guide - handset



▲DIR/VOLUME

- Press to show directory entries when the telephone is not in use (page 89).
- Press to scroll up while in menus.
- Press to increase the listening volume when on a call (page 58), or increase the message playback volume (page 124).
- While entering names or numbers, press to move the cursor to the right.

▼CID/VOLUME

- Press to show caller ID log when the telephone is not in use (page 96).
- Press to scroll down while in menus.
- Press to decrease the listening volume when on a call (page 58), or decrease the message playback volume (page 124).
- While entering names or numbers, press to move the cursor to the left.

☎OFF/CANCEL

- During a call, press to hang up (pages 50 or 52).
- While in a menu, press to cancel an operation, back up to the previous menu, or exit the menu display; or press and hold to exit to idle mode.
- When the handset is ringing, press to mute the ringer temporarily (page 53).
- Press and hold while the telephone is not in use to erase the missed call indicator (page 95).

QUIET # (pound key)

- Press repeatedly to display other dialing options when reviewing a caller ID log entry (page 97).
- Press and hold to enter the **QUIET** mode setting screen, or to deactivate **QUIET** mode (page 48).

MUTE/DELETE

- During a call, press to mute the microphone (page 59).
- When the handset is ringing, press to mute the ringer temporarily (page 53).
- While reviewing the redial list, directory, caller ID log or call block list, press to delete an individual entry (pages 66, 93, 100 and 108).
- While predialing, press to delete a digit (page 50).
- During message or announcement playback, press to delete a message or announcement (page 124).

Quick reference guide - handset

Handset side view



PUSH TO TALK

- Press to initiate a one-to-one (page 77) or one-to-group broadcast (page 79).
- Press and hold to broadcast to a group of system devices (page 79).

VOICE

- Press to activate the voice-controlled application of connected cell phone (pages 32-34).

Main menu

The selected menu item is highlighted.



Feature menu

- Play messages (page 122)
- Answering sys (page 109)
- Directory (page 84)
- Caller ID log (page 94)
- Intercom (page 69)
- Call block (page 102)
- Ringers (page 36)
- Set date/time (page 39)
- Caller ID annc (page 40)
- Settings (page 38)
- Web address (page 47)

Using menus:

1. Press **MENU** in idle mode (when the telephone is not in use) to enter the main menu.
2. Press **▼CID** or **▲DIR** to scroll through menu items.
3. Press **SELECT** to select or save the highlighted item.

-OR-

Press **BACK** or **OFF/CANCEL** to cancel an operation, back up to the previous menu, or exit the menu display.

Getting started

Telephone base and charger installation

Install the telephone base and charger, as shown below.

The telephone base is ready for tabletop use. If you want to change to wall-mounting, see **Installation options** on page 15 for details.

Telephone base installation

Plug the large end of the telephone base power adapter into a power outlet not controlled by a wall switch.

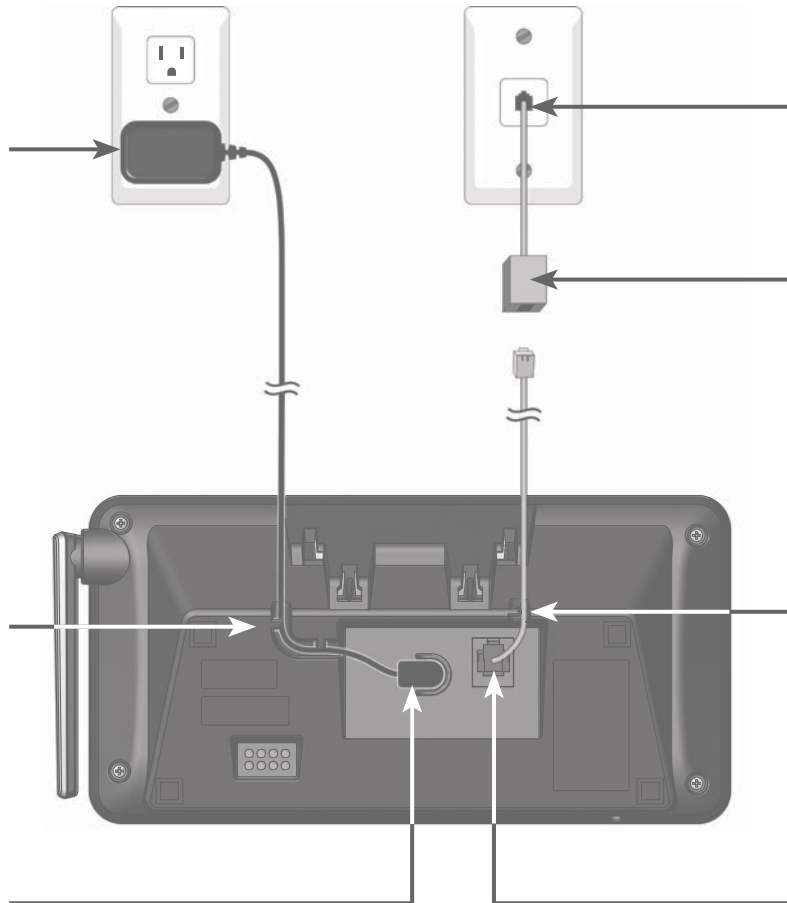

Plug one end of the telephone line cord into a telephone jack or a DSL filter.

If you have DSL high-speed Internet service, a DSL filter (not included) is required.

Route the power adapter cord through this slot.

Route the telephone line cord through this slot.

Plug the small end of the telephone base power adapter into the power adapter jack on the back of the telephone base.

Plug the other end of the telephone line cord into the telephone jack on the back of the telephone base.

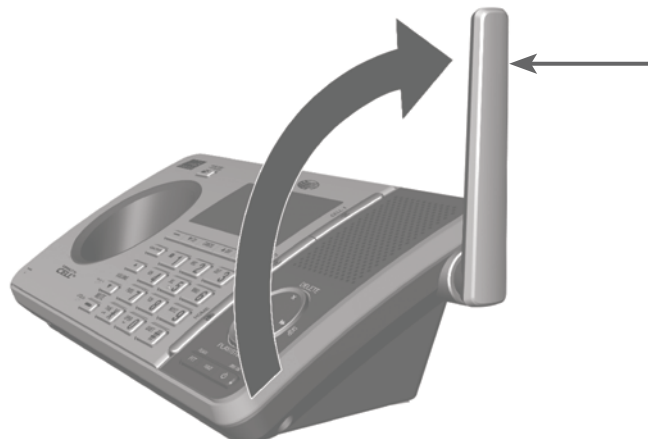

Raise the antenna.

Charger installation

Plug the power adapter into an power outlet not controlled by a wall switch.

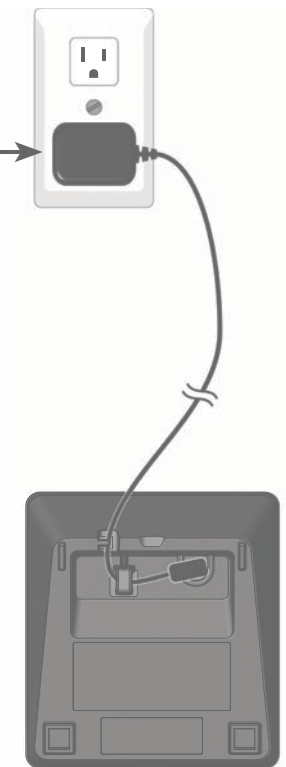



IMPORTANT INFORMATION



- Use only the power adapter(s) provided with this product. To obtain a replacement, visit our website at www.telephones.att.com or call **1 (800) 222-3111**. In Canada, dial **1 (866) 288-4268**.
- The power adapters are intended to be correctly oriented in a vertical or floor mount position. The prongs are not designed to hold the plug in place if it is plugged into a ceiling, under-the-table or cabinet outlet.

Battery installation and charging

Install the battery, as shown below. Once you have installed the battery, the screen indicates the battery status (see the following table). If necessary, place the handset in the telephone base or charger to charge the battery. For best performance, keep the handset in the telephone base or charger when not in use. The battery is fully charged after 11 hours of continuous charging. See the table on page 168 for battery operating times.

If the screen is blank or shows **Place in charger** and a flashing , you need to charge the handset without interruption for at least 30 minutes to give the handset enough charge to use the telephone for a short time. When the battery is low, the handset shows **Low battery** and a flashing . If you are on a call in low battery mode, the handset beeps every minute.

The following table summarizes the battery charge indicators and actions to take.

Battery indicators	Battery status	Action
The screen is blank or shows Place in charger and  flashes.	The battery has no or very little charge. The handset cannot be used.	Charge without interruption (at least 30 minutes).
The screen shows Low battery and  flashes.	Battery has enough charge to be used for a short time.	Charge without interruption (at least 30 minutes).
The screen shows HANDESET X.	Battery is charged.	To keep the battery charged, place it in the telephone base or charger when not in use.

1. Plug the battery connector securely into the socket inside the handset battery compartment. Insert the supplied battery with the label **THIS SIDE UP** facing up, as indicated.

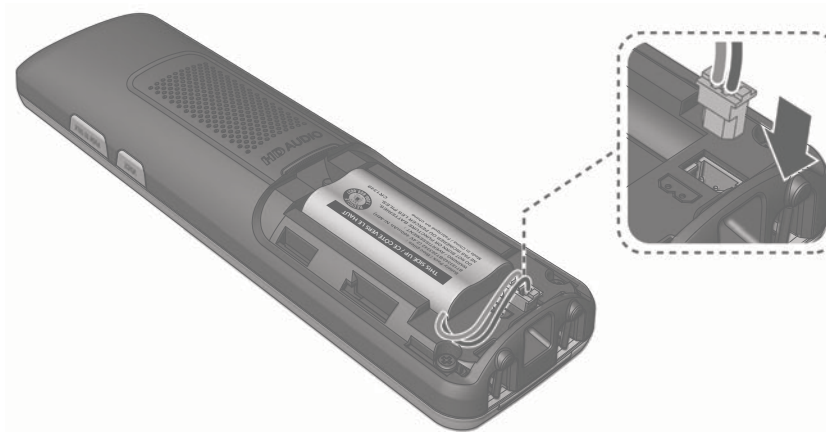

Getting started

Battery installation and charging

- Align the cover flat against the battery compartment, then slide it upwards until it clicks into place.

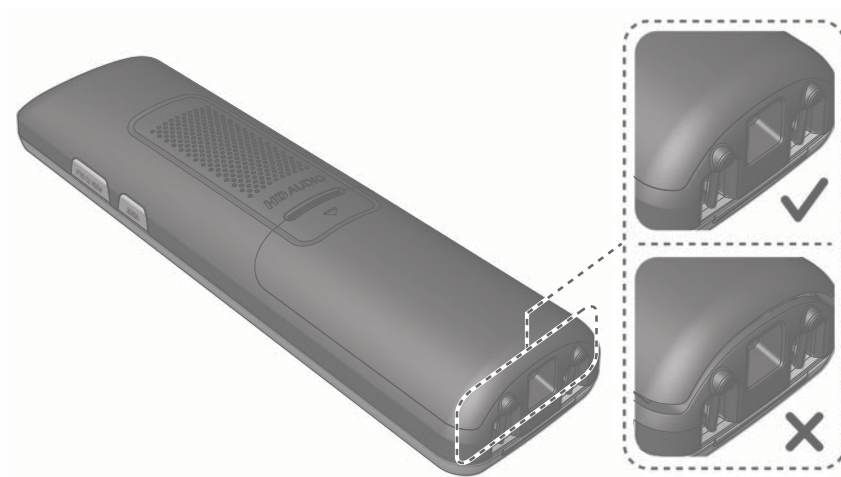
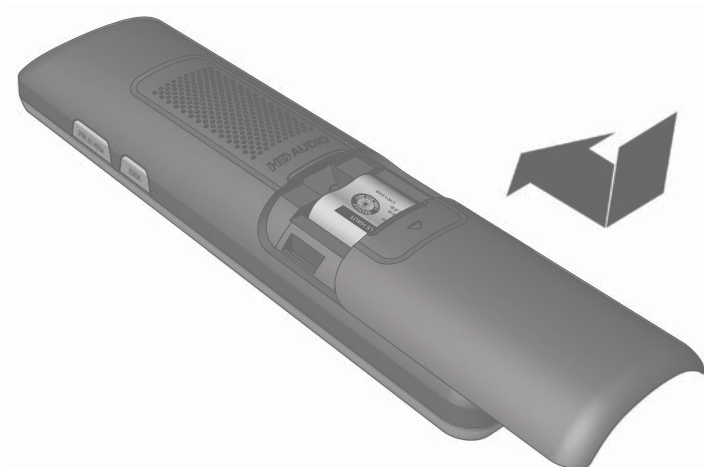

- Charge the handset by placing it face forward in the telephone base or charger. The **CHARGE** light on the top of the handset is on during charging.

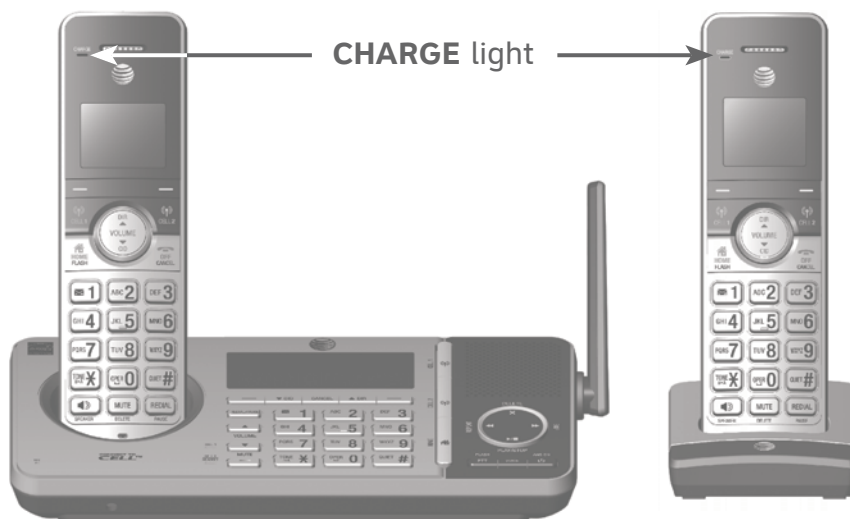

Battery installation and charging

After you install your telephone or power returns following a power outage, the handset and telephone base will prompt you to set the date and time. For instructions, see **Set date/time** on page 39. To skip setting the date and time, press **OFF/CANCEL** on the handset or **CANCEL** on the telephone base.



After the date and time setting is done or skipped, the handset and the telephone base will prompt if you want to set up the answering system. Press **YES** on the handset or telephone base to start the answering system setup via voice guide. For more details, see **Voice guide** on page 112. To skip the setup, press **NO**, or press **OFF/CANCEL** on the handset or **CANCEL** on the telephone base.

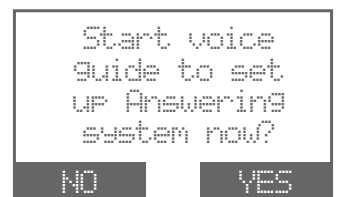
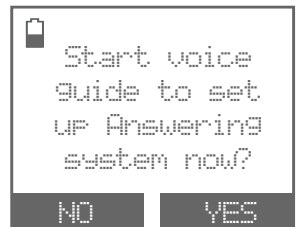

IMPORTANT INFORMATION

- Use only the supplied rechargeable battery or replacement battery (model BT183342/BT283342). To order, visit our website at **www.telephones.att.com** or call **1 (800) 222-3111**. In Canada, dial **1 (866) 288-4268**.
- If you do not use the handset for a long time, disconnect and remove the battery to prevent possible leakage.

Battery backup mode

Battery backup mode allows your telephone system to function in the event of a power outage. The telephone system uses stored power from the handset's battery to operate.

To activate the mode

After the power goes out, if there is already a handset with enough charge placed in the telephone base, the telephone system enters battery backup mode automatically. That handset screen shows **Powering base... Don't pick up**. All other handset screens show **Battery backup mode**.

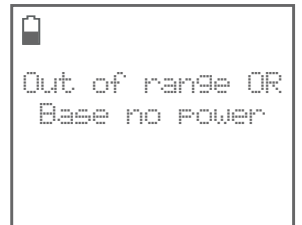

-OR-

If there is no handset placed in the telephone base after the power goes out, all handsets show **Out of range OR no power at base** and **Put HS on base to power base**, alternately. Place any handset with enough charge in the telephone base. Its screen shows **Powering base... Don't pick up**. All other handset screens show **Battery backup mode**.

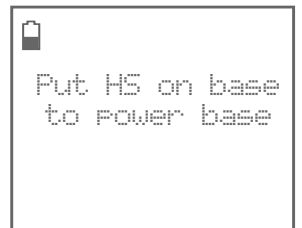

i NOTE: A handset which does not have enough charge to power up the base, its screen shows **Out of range OR no power at base** and **Not enough battery to power base**, alternately, after the power goes out. Find another system handset that has enough charge to activate the mode.

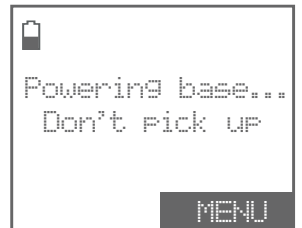

Operation

During battery backup mode, the telephone base, answering system and all Bluetooth related features will be disabled. The operating time is subject to the battery level of the handset placed in the telephone base and the actual usage. For optimal performance, we recommend that you do not use the handset placed in the telephone base when this mode is on.

Using other system handsets (Recommended):

Operate the handsets the same way as usual, except the answering system and all Bluetooth related features which will be disabled.

Using the handset placed in the telephone base:

To maximize the operating time, you are not advised to use this handset. If you do have to use it, make sure you do not lift it from the telephone base. All operations should be done with the handset placed in the telephone base. In this case, calls can only be made and received using the speakerphone.

Installation options

Your telephone base is ready for tabletop use. If you want to mount your telephone on a wall, use the provided wall-mount bracket to attach to a standard dual-stud telephone wall-mounting plate. If you do not have this wall-mounting plate, you can purchase one from many hardware or consumer electronics retailers. You may need a professional to install the wall-mounting plate.

Tabletop to wall-mount installation

1. Unplug the power adapter from the power outlet. Unplug the telephone line cord from the wall jack (or DSL filter). Align the holes on the wall-mount bracket with the standard wall plate and slide the wall-mount bracket down until it locks securely.
2. Plug the telephone line cord (or DSL filter) into the wall jack.
3. Align the slots on the back of the telephone base with the extended tabs of the wall-mount bracket, as shown below. Push the telephone base down until it is securely in place.
4. Plug the power adapter into a power outlet not controlled by a wall switch. Bundle the telephone line cord and power adapter cord neatly with twist ties, if necessary.

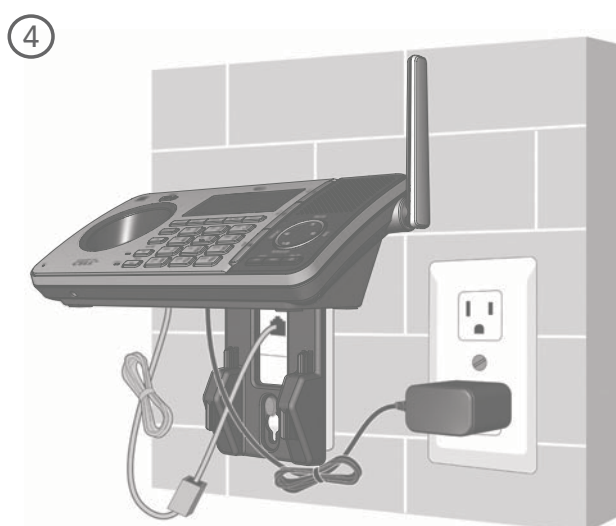
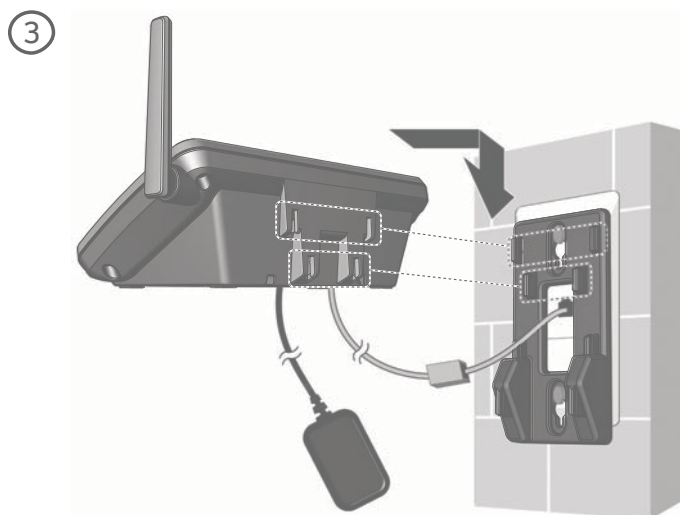
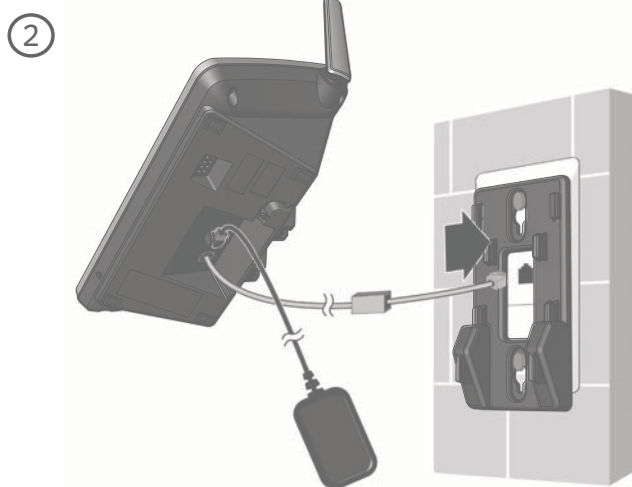
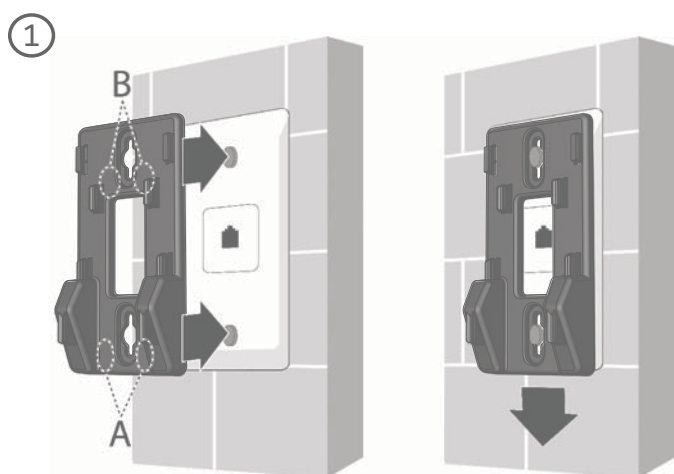

Wall-mount to tabletop installation

To change the telephone base from the wall-mount position to tabletop position, follow the steps, as mentioned below.

1. Unplug the large end of the power adapter from the electrical outlet.
2. If the telephone line cord and power adapter cord are bundled, untie them first. Slide the wall-mount bracket up and remove it from the wall-mounting plate.

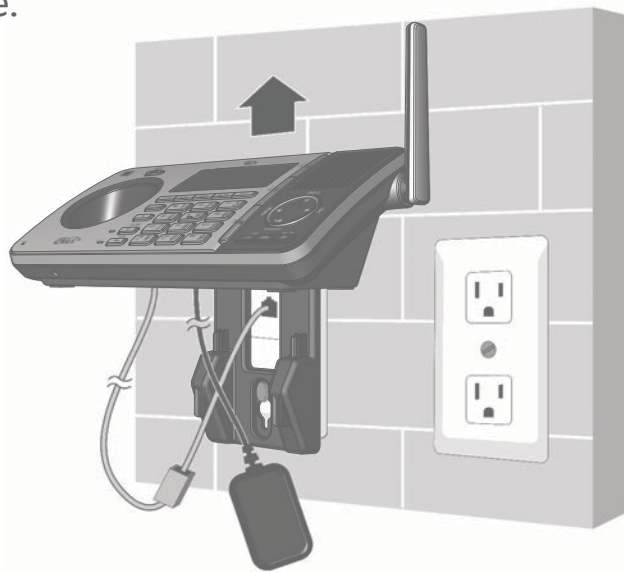

3. Unplug the telephone line cord or the DSL filter from the telephone wall jack. Push the telephone base up and away from the wall-mount bracket to detach it from the wall-mount bracket.

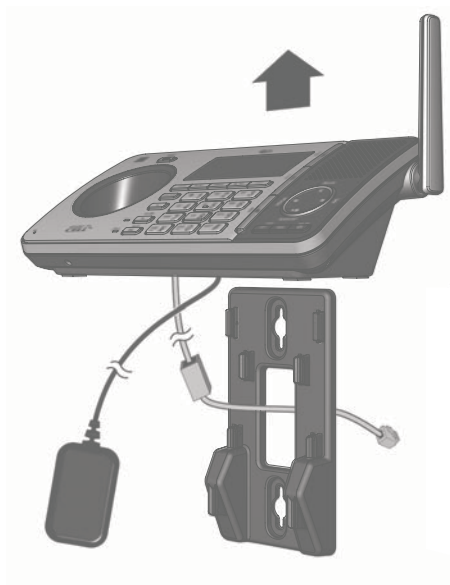

4. See **Telephone base installation** on page 9.

Introducing Bluetooth

Your new AT&T **TL96276/TL96456** telephone system with Bluetooth wireless technology has the following features:

- Pair up to four Bluetooth enabled devices (cell phones or headsets) with the telephone base.
- Connect a maximum of two Bluetooth enabled devices to make and receive cell calls. Both cell phones can be active on a call at a time.
- Connect a Bluetooth enabled headset for making and receiving home calls.
- Conference any combination of cell and home call.
- Make and receive calls using your cell phone service with your telephone base or system handsets.
- Download phonebook entries from your cell phone.
- Ringtone share feature allows you to set your telephone to play your iPhone® (iOS 4.1 or later) ringtone.

IMPORTANT INFORMATION

- After plugging in the telephone base, wait at least 20 seconds before connecting a Bluetooth device. The screen shows **Bluetooth system busy** if you try to connect too soon.
- Refer to the user's manual of your Bluetooth enabled cell phone or headset for more information about how that device uses Bluetooth connectivity.
- Bluetooth wireless technology operates within a short range (up to 30 feet) from the telephone base. Keep connected cell phones and headsets within this range.
- If your cell phone has poor reception in your home, the **TL96276/TL96456** cannot improve the reception. However, if there is a location in your house with better reception, you can leave your cell phone at that location while you use the **TL96276/TL96456** cell line. For optimal performance, the cell phone must be within 15 feet of the telephone base.

Introducing Bluetooth

- If you experience poor sound quality, it may be caused by the distance between your cell phone and the telephone base. To improve the performance, place your cell phone closer to the telephone base (within 15 feet) and make sure that there are no physical obstacles such as large furniture or thick wall in between.

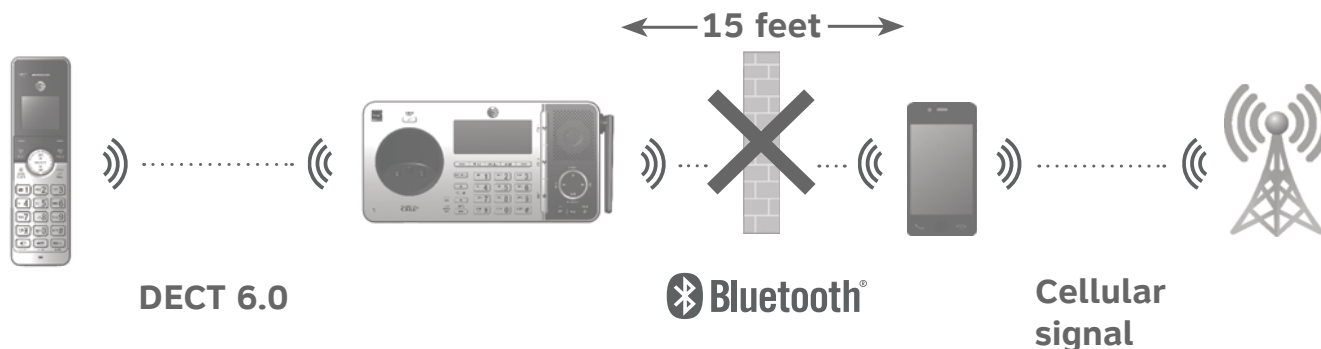

- Charge your cell phone while it is connected to the telephone base. Your cell phone's battery discharges faster while it is connected to the telephone base via Bluetooth wireless technology.
- Monitor your cell phone's usage, because minutes may be deducted from your cellular plan for the duration of all cell calls, depending on the terms of your plan.

Refer to the **Bluetooth setup** section (pages 21-31) to learn how to set up your Bluetooth device. Refer to the **Telephone operation** section (pages 50-67) on how to operate your Bluetooth devices with your new **TL96276/TL96456** AT&T telephone system with Bluetooth wireless technology. Refer to the **Troubleshooting** section (pages 142-158) if you experience difficulty when using the telephone system.

The *Bluetooth*® word mark and logos are owned by Bluetooth SIG, Inc. and any use of such marks by Advanced American Telephones and its parent, VTech Holdings Limited, is under license. VTech Holdings Limited is a member of Bluetooth SIG, Inc. Other trademarks and trade names are those of their respective owners.

Introducing Bluetooth

Connect to Cell™ application

If you are using Bluetooth-enabled cell phones with Android® OS 2.3 or above, you can further extend the flexibility of your telephone system with use of the free **Connect to Cell** application.

Connect to Cell comprises **Caller ID manager** and **Alerts manager** that help integrate your cell phone with the AT&T telephone system.

Caller ID manager (Caller ID share) allows you:

- To view your AT&T phone's caller ID log on your Android cell phone;
- To use your Android cell phone to call back or send messages to individuals who have called your home line on the AT&T telephone;
- To store callers' names and numbers to your Android phone's directory for future use.

Alerts manager (Mobile notification) allows you to extend your Android phone's alerts to your AT&T telephone system. Your AT&T telephone will notify you whenever you receive certain text messages, e-mails or social media updates on your Android phone, so you will always be kept up to date.

To use **Caller ID manager** and **Alerts manager**, you must first download **Connect to Cell** to your Android cell phone using the **Google Play® Store** app. Scan the QR code on the right to download the application.





Glossary of terms

Below are some terms used in this user's manual to help you become familiar with using your Bluetooth devices and your new AT&T telephone system.

Active device slots - the **Device list** has two active slots for two cell phones, or one cell phone and one headset. When a device in the list is active it will have a **D1:** or **D2:** in front of the device name. In order to use a Bluetooth device on a call, it must be in an active slot and be connected.



Bluetooth cell phone - refers to a mobile Bluetooth enabled cellular telephone.

CELL line - the telephone line associated with your cell phone service. On your **TL96276/TL96456** handset or telephone base, press  **CELL 1** or  **CELL 2** to use the cell line.

Connected - when you pair a Bluetooth device to the **TL96276/TL96456**, it is placed in an active slot and automatically connected. When a device is connected, a **1** and/or **2** will display after  on the handset and telephone base screen. Also, the **CELL 1** and/or **CELL 2/HEADSET** light on the telephone base will be on. If a device loses its connection to the telephone base, it must be reconnected before you can use the device with the telephone system.

Disconnected - when a device is disconnected, **1** and/or **2** displays after  on the handset and telephone base screen. The **CELL 1** and/or **CELL 2/HEADSET** light on the telephone base is/are off.

Discoverable mode - before a Bluetooth enabled device can be paired, it must be set to this mode. When pairing your cell phone, the telephone base is in this mode. When pairing a headset, the headset must be set to this mode. Depending on the manufacturer, this mode is sometimes referred to as **Find Me** or **Visibility**.

HOME line - your conventional telephone land line. On your **TL96276/TL96456**, press  **HOME/FLASH** on the handset or  **HOME** on the telephone base to use the home line.

Paired devices - Bluetooth enabled devices (cell phone or headset) that have shared registration information with the telephone base. A total of four Bluetooth enabled devices can be paired with the telephone base. However, only two paired devices can be connected to the base at a time.

Pairing - sometimes refers to as **bonding**. The process of sharing registration information between two Bluetooth enabled devices. Your Bluetooth enabled cell phone or headset must first be paired to the telephone base in order to use it with this cordless phone system.

PIN - by default, the PIN is **0000** for the telephone base and for most Bluetooth devices. PIN information must be exchanged between Bluetooth devices before they can be used. This is also known as a **Passkey** or **Passcode**.

Bluetooth setup

To use a Bluetooth enabled cellular phone or headset with your telephone, you must first pair and connect your Bluetooth cellular phone or headset with the telephone base. Then, the **TL96276/TL96456** can be used to make or answer calls on the cell phone line.

Bluetooth wireless technology operates within a short range (up to 30 feet). When you pair a Bluetooth cell phone or Bluetooth headset to the telephone base, keep the device within 15 feet of the telephone base for optimal performance.

Add a cell phone

Before you begin, make sure that you have cellular coverage and your Bluetooth enabled cell phone is not connected to any other Bluetooth device. Refer to your cell phone user's manual to learn how to search for or add new Bluetooth devices.

To pair and connect a cell phone:

1. Press **MENU** on the telephone base in idle mode.
2. Press **▼CID** or **▲DIR** to highlight **Bluetooth**, then press **SELECT**.
3. Press **SELECT** to choose **Add device**.
4. Press **SELECT** to choose **Add cellular**. The screen displays **Please wait...** followed by **1. If cell is connected to BT device, please disconnect it.**
 - If there are already four paired devices on the device list, the fourth one on the list will be automatically removed, regardless of whether the pairing of the new device is successful or not.
 - If there are already two active devices on the list with prefix **D1:** or **D2:**, the telephone base shows **Cell Phone X is deactivated for adding a new device** (**Cell Phone X** represents the device name of the active cell phone).
5. Press **NEXT**. The screen displays **2. Place cell phone next to base.**
 - All devices that are connected to the telephone base are disconnected until the pairing process completes.



Bluetooth setup

6. Press **NEXT** to turn on the telephone base discoverable mode. The screen displays **Set cell to search base: AT&T DECT 6.0 PIN: 0000**.
7. Promptly turn on the Bluetooth feature of your cell phone and search for or add new devices. Once your cell phone finds your AT&T phone (**AT&T DECT 6.0**), press the appropriate key on your cell phone to continue the pairing process.
 - Your cell phone may require a passcode. In this case, the telephone base displays **Check cellular. ENTER PASSCODE**. Enter the cell phone passcode (typically **0000**) into the telephone base and press **SET**.
 - Enter the PIN of the telephone base (the default PIN is **0000**) into your cell phone to continue the pairing process, if required. The telephone base displays **Adding Cell Phone Y (Cell Phone Y represents the device name of your cell phone)**.

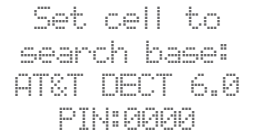

Set cell to
search base:
AT&T DECT 6.0
PIN:0000



Adding
Cell Phone Y

When a device is successfully connected, the telephone base displays **Cell Phone Y is added and connected to base.** and you hear a confirmation tone (**Cell Phone Y** represents the device name of your cell phone). The corresponding status icon (⌘ 1 or ⌘ 2) displays on the handset and telephone base. The corresponding device light on the telephone base (**CELL 1** or **CELL 2/HEADSET**) turns on.

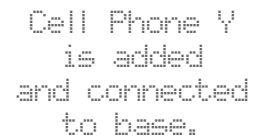

Cell Phone Y
is added
and connected
to base.

If you have trouble pairing your cell phone, it may not be compatible with your TL96276/TL96456. Check the Bluetooth compatibility list at www.telephones.att.com/bluetooth.

NOTES:

- The pairing process may take up to one minute. If the pairing process fails, try again.
- The steps for the pairing process may vary for different cell phones. If this happens, follow the prompts on your cell phone and your **TL96276/TL96456** to complete the pairing process.
- Refer to the user's manual of your cell phone on how to search for or add a new Bluetooth device.

Bluetooth setup

Add a headset

Before you begin, make sure that your Bluetooth enabled headset is not connected to any other Bluetooth device. Refer to your headset user's manual to learn how to search for or add new Bluetooth devices.

To pair and connect a headset:

1. Press **MENU** on the telephone base in idle mode.
2. Press **▼CID** or **▲DIR** to highlight **Bluetooth**, then press **SELECT**.
3. Press **SELECT** to choose **Add device**.
4. Press **▼CID** or **▲DIR** to highlight **Add headset**, then press **SELECT**. The screen displays **Please wait...** followed by **If headset is connected to cell, please disconnect it..**
 - If there are already four paired devices on the device list, the fourth device on the device list will be automatically removed, regardless of whether the new device pairing is successful or not.
 - If there is another headset already active, the screen will show **Only the BT headset in slot 2 can be ready for connection** and then **Headset X is deactivated** (**Headset X** represents the device name of the active Bluetooth headset).
5. Press **NEXT**. The screen displays **Pls set headset to discoverable mode**.
6. Set your headset to discoverable mode (refer to the user's manual of your headset), then press **NEXT**. The screen displays **Searching for Bluetooth headsets...**
 - All devices that are connected to the telephone base are temporarily disconnected.
7. When the screen displays the found devices, press **▼CID** or **▲DIR** to highlight your headset, if necessary, then press **SELECT**.
 - Enter the PIN of your headset, if required. The PIN for most Bluetooth devices is **0000** (refer to the user's manual of your headset). Press **NEXT** to continue.

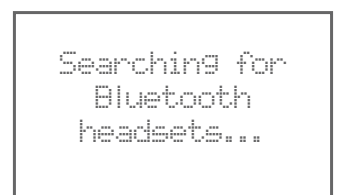

Bluetooth setup

The screen displays **Adding Headset Y** when the base is connecting to your headset (**Headset Y** represents the device name of your Bluetooth headset).

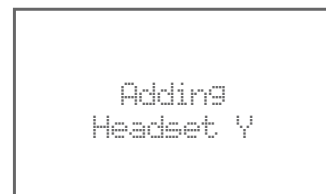

When a device is successfully connected, the telephone base displays **Headset Y is added and connected to base.** and the corresponding status icon  (**Headset Y** represents the device name of your Bluetooth headset). You hear a confirmation tone. The **CELL 2/HEADSET** light on the telephone base turns on.

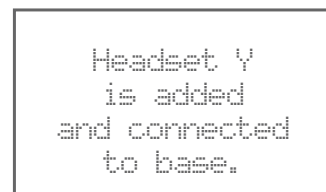

If you have trouble pairing your headset, it may not be compatible with your TL96276/TL96456. Check the Bluetooth compatibility list at www.telephones.att.com/bluetooth.

NOTES:

- The pairing process may take up to one minute. If the pairing process fails, try again.
- When a connected headset is charging, it may disconnect from the telephone base and the **CELL 2/HEADSET** light on the telephone base turns off. For some headset models, you may need to turn on the headset and reconnect it to the telephone base again.

Auto connection

When an active device moves within Bluetooth range of the telephone base, or is turned on within range, the telephone base tries to connect to the device. When the device moves out of range, it is disconnected. Your device might make a connect or disconnect sound.

A connected device could also be disconnected by:

- Turning off the Bluetooth device.
- Turning off the Bluetooth feature of the device.
- Disconnecting through the telephone base **Device list**. If you disconnect through the **Device list**, the telephone base will not attempt to reconnect until your device is moved out of range and then moves back in range again.

Bluetooth connection from idle mode

When you have active devices that are not connected, **CONNECT** appears on idle handsets and telephone base. Press **CONNECT** to start connecting an active device. When there are two active devices, the handset will prompt you to choose one before connection.

Bluetooth setup

Device list and connection

Up to four devices can be paired to the telephone base. All paired devices are shown on the device list. To use a paired device, it must be connected and in an active slot (**D1:** or **D2:**) on the device list. Both active devices can be on a call at a time.

Once you have paired a device with the telephone base, you do not need to repeat the pairing procedure again unless you delete the device from the device list.

i NOTE: When connecting a Bluetooth device to the device list, all connected devices will be temporarily disconnected until the procedure is complete. It may take up to two minutes to reconnect.

Review the device list

1. Press **MENU** on the telephone base in idle mode.
2. Press **▼CID** or **▲DIR** to highlight **Bluetooth**, then press **SELECT**.
3. Press **▼CID** or **▲DIR** to highlight **Device list**, then press **SELECT**.



Connect/disconnect an active device

While in the active device list, you may connect or disconnect your active device.

1. Press **MENU** on the telephone base in idle mode.
2. Press **▼CID** or **▲DIR** to highlight **Bluetooth**, then press **SELECT**.
3. Press **▼CID** or **▲DIR** to highlight **Device list**, then press **SELECT**.
4. Press **▼CID** or **▲DIR** to highlight a device, then press **OPTION**.
5. Press **▼CID** or **▲DIR** to highlight **Connect/Disconnect** (whichever is applicable), then press **SELECT** to confirm. The telephone base displays **Device connected/Device disconnected**. You hear a confirmation tone.



i NOTE: When your active device is connected, you are prompted to select **Disconnect**. When your active device is disconnected, you are prompted to select **Connect**.

Bluetooth Bluetooth setup

Remove a device

When you already have the maximum of four paired devices on the device list and you want to add another device, you must first remove a device from the device list.

To remove a device:

1. Press **MENU** on the telephone base in idle mode.
2. Press **▼CID** or **▲DIR** to highlight **Bluetooth**, then press **SELECT**.
3. Press **▼CID** or **▲DIR** to highlight **Device list**, then press **SELECT**.
4. Press **▼CID** or **▲DIR** to highlight the desired device, then press **X/DELETE**.

-OR-

Press **▼CID** or **▲DIR** to highlight the desired device, then press **OPTION**.

- Press **▼CID** or **▲DIR** to highlight **Remove**, then press **SELECT**.

5. The handset displays **Remove Cell Phone X?** (**Cell Phone X** represents the device name of your cell phone). Press **YES** to confirm. The handset displays **Device removed from device list.** and you hear a confirmation tone.

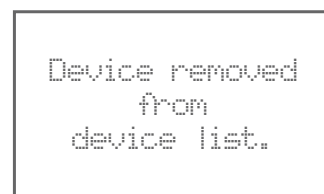
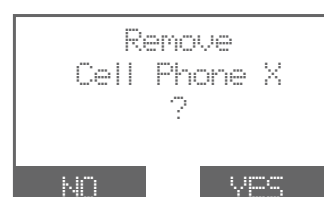

Bluetooth setup

Replace an active device

If you already have two active devices on the device list and you want to activate a different device, you must deactivate one of the two active devices.

To replace an active device:

1. Press **MENU** on the telephone base in idle mode.
2. Press **▼CID** or **▲DIR** to highlight **Bluetooth**, then press **SELECT**.
3. Press **▼CID** or **▲DIR** to highlight **Device list**, then press **SELECT**.
4. Press **▼CID** or **▲DIR** to highlight the device you want to activate without a prefix **D1:** or **D2:**, then press **OPTION**.
5. Press **▼CID** or **▲DIR** to highlight **Connect**, then press **SELECT**. The handset displays **Only BT devices in slot 1 or 2 can be ready for connection** and then a list of devices for deactivation.
6. Press **▼CID** or **▲DIR** to highlight the device to be deactivated, then press **NEXT**. The screen displays **Cell Phone X is deactivated** and you hear a confirmation tone. Then, the screen displays **Connecting Cell Phone Y to the base...** (**Cell Phone X** and **Cell Phone Y** represent the device names of your cell phones).
7. Depending on your cell phone settings, you may need to press a key on your cell phone to confirm the connection.

```

DEVICE LIST
D1:Cell Phone X
D2:Headset X
Cell Phone Y
BACK  ▲  OPTION
  
```

```

Only BT devices
in slot 1 or 2
can be ready
for connection
  
```

```

DEACTIVATE
D1:Cell Phone X
D2:Headset X
BACK  ▲  NEXT
  
```

```

Connecting
Cell Phone Y
to the base...
  
```

```

DEVICE LIST
D1:Cell Phone Y
D2:Headset X
Cell Phone X
BACK  ▲  OPTION
  
```

When the new device is successfully activated and connected, the handset displays **Device connected**. You hear a confirmation tone.

i NOTE: When connecting a Bluetooth device to the device list, all connected devices will be temporarily disconnected until the procedure is complete. It may take up to two minutes to reconnect.

Bluetooth setup

Download directory

You can download up to four cell phone directories (phonebooks) to your **TL96276/TL96456** telephone system via Bluetooth wireless technology. Each downloaded directory can store up to 1,500 entries with up to 30 digits for each phone number and 15 characters for each name.

Before downloading a directory, make sure the cell phone is paired, active, and connected to your **TL96276/TL96456**.

Place your cell phone next to the telephone base when you download a cell phone directory to your **TL96276/TL96456**.

To download a cell phone directory:

1. Press **MENU** on the telephone base in idle mode.
2. Press **▼CID** or **▲DIR** to highlight **Bluetooth**, then press **SELECT**.
3. Press **▼CID** or **▲DIR** to highlight **Download dir**, then press **SELECT**.
 - If there is no cell phone paired to the system, the handset displays **Device list is empty**. Press **OK** to return to the Bluetooth menu.
 - If there are two active devices on the device list, press **▼CID** or **▲DIR** to highlight the desired device, then press **SELECT**.
 - If the selected device is active but disconnected, the handset displays **Cellular phone not connected..** Press **CONNECT**.
4. Press **▼CID** or **▲DIR** to highlight one of the following options:
 - **Phone memory** - download all contacts stored in your phone memory.
 - **SIM card only** - download all contacts stored in your SIM card.
 - **Phone and SIM** - download all contacts stored in both your phone memory and SIM card.



Press **SELECT** to continue. During the download, the telephone base displays the progress. All other idle system handsets display **Downloading....**

Bluetooth setup

- Your cell phone may require you to press a key to confirm the directory download.
 - Your cell phone may require a passcode. In this case the screen displays **Check cellular. ENTER PASSCODE..** Enter the cell phone passcode into the telephone base and press **SET** to save.
 - If the selected device's directory has already been downloaded to **TL96276/TL96456** before, the handset displays the date of the last download from your cell phone. The directory stored on the **TL96276/TL96456** for that cell phone will be erased and replaced with the current cell phone directory. If you have edited the downloaded entries, those changes will be lost. Press **NEXT** to start the download, the screen displays **Erasing directory...**
 - If you already have four downloaded directories, the handset displays **Memory is full. Replace existing directory?.** Press **YES** if you want to replace an existing directory. Highlight the cell phone directory to be replaced and press **SELECT**. The screen displays **Replace Cell Phone X directory? (Cell Phone X represents the device name of your cell phone).** Press **YES** to confirm.
5. When the downloading process completes, the telephone base displays **Download ended XXXX entries saved.** (**XXXX** represents the total number of the downloaded entries). You hear a confirmation tone. Press **OK** to return to the **Bluetooth** menu.



NOTES:

- With certain cell phones, downloading from the SIM card is not supported. If this is the case, try transferring the contacts from your SIM card to your cell phone memory first, then download from your cell phone memory. For more information on how to transfer contacts from your SIM card to your cell phone memory, see the user's manual of your cell phone.
- If **Phone memory** is chosen but with no entries saved, the handset displays **No entries found. Download from SIM only?.** Press **YES** to confirm. If **SIM card only** is chosen but with no entries saved, the handset displays **No entries found. Download from Phone only?.** Press **YES** to confirm. If **Phone and SIM** are chosen but with no entries saved in either or both directories, the handset display **No entries found. Download from Phone only?.** Press **YES** to confirm.
- When downloading the directory from your Bluetooth enabled cell phone, some data may not transfer. For example, if you have home, mobile and work numbers for a particular contact, the three categories may not transfer to your **TL96276/TL96456**.

Bluetooth setup

Interruption to directory download

If you are downloading a directory from a cell phone and the phone receives a call, the download process stops. The telephone base displays **Download failed** and all the handsets display **Download fail**. When you try to view the downloaded directory, the telephone base and handset displays **Last Download failed: MM/DD/YY**. You need to download the directory again (see pages 28-29).

When you are downloading a directory from a cell phone and you wish to stop the download process, you may press **STOP**. The telephone base displays **Download directory cancelled**. The telephone base displays **Download failed** when it returns to idle mode.

i NOTE: During the download process, do not attempt to make changes to your cell phone directory.

View the directory download information

1. Press **MENU** on the telephone base in idle mode.
2. Press **▼CID** or **▲DIR** to highlight **Directory**, then press **SELECT**.
3. Press **▼CID** or **▲DIR** to choose the desired downloaded directory, then press **OPTION**.
4. Press **▼CID** or **▲DIR** to highlight **Last update**, then press **SELECT**.
 - The telephone base displays **Cell phone X Last update: MM/DD/YY Total #XXXX**.

-OR-

 - The telephone base displays **Cell phone X Last Download failed: MM/DD/YY** if there was an interruption during that directory download.

(**Cell Phone X** represents the device name of your cell phone. **XXXX** represents the total number of the downloaded entries.)
5. Press **OK** to exit.

```

Answering sys
Directory
Caller ID log
Intercom
BACK  ▲  SELECT
  
```

```

          DIRECTORY
Home
Cell phone X
OPTION  REVIEW
  
```

```

          CELL PHONE X
Cell area code
Last update
Remove DIR
BACK  ▲  SELECT
  
```

```

          CELL PHONE X
Last update:
12/12/09
Total #0159
OK
  
```

i NOTE: If a handset tries to access the directory while a Bluetooth directory download is in progress, the screen shows **Not available at this time**.

Bluetooth setup

Change PIN

You are required to enter a PIN when establishing a Bluetooth connection. The default PIN of your telephone base is **0000**.

To change the PIN:

1. Press **MENU** on the telephone base in idle mode.
2. Press **▼CID** or **▲DIR** to highlight **Bluetooth**, then press **SELECT**.
3. Press **▼CID** or **▲DIR** to highlight **Change PIN**, then press **SELECT**. The screen displays **ENTER NEW PIN** and the existing PIN.
4. Use the dialing keys to enter a new 4-digit code.
 - Press **▼CID** or **▲DIR** to move the cursor to the right or left.
 - Press **X/DELETE** to erase a digit.
 - Press and hold **X/DELETE** to erase all digits.
5. Press **SET** to save. You hear a confirmation tone.



Cell ringer

If this feature is on and you have connected an iPhone device (iOS 4.1 or later) to your telephone system, the telephone plays your iPhone ringtone when there is an incoming call.

To turn on or off the cell ringer feature:

1. Press **MENU** on the telephone base in idle mode.
2. Press **▼CID** or **▲DIR** to highlight **Bluetooth**, then press **SELECT**.
3. Press **▼CID** or **▲DIR** to highlight **Cell ringer**, then press **SELECT**.
 - If there is more than one paired device on the device list, press **▼CID** or **▲DIR** to highlight the desired device, then press **SELECT**.
4. Press **▼CID** or **▲DIR** to choose **On** or **Off**, then press **SET**.

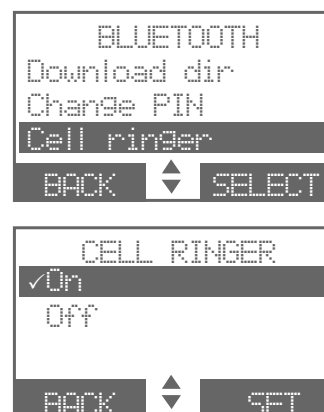

i NOTE: The quality of ringtone played on your telephone is subject to individual ringtone characteristics.

Bluetooth

Remote voice control

If you have connected a cell phone to the **TL96276/TL96456** telephone system, you can activate the voice-controlled application (voice app) of the cell phone, such as Siri®, Google Now™ or S Voice®, using your handset or telephone base.

The remote voice control feature works with:

Voice-controlled application	Siri	Google Now	S Voice
Operation System (Versions supported)	iOS (8 or above)	Android (4 or above)	Android (4 or above)

Before using the remote voice control feature, make sure you checked the following:

- Your cell phone is paired and connected to your telephone system via Bluetooth.
- No Bluetooth applications are running in the background of your cell phone.
- Keep your cell phone within 15 feet of the telephone base.
- Do not lock up your cell phone's screen or set passcode for activating the voice app.
- Make sure you have turned on or logged in to the applications on your cell phone that you will be sending your voice commands, such as GPS, e-mail and social networking accounts.
- Your cell phone's data or Wi-Fi signal is in full strength and your cell phone can connect to the Internet.
- Try to activate the voice app on your cell phone to ensure it is in place.

Siri® is a registered trademark of Apple Inc.

Google Now™ is a trademark of Google Inc.

S Voice® is a registered mark of Samsung Electronics Co., Ltd.

Remote voice control

Activate remote voice control

1. Press **VOICE** on the handset or telephone base.
 - If you have connected two cell phones to the telephone, the telephone shows **Activate remote voice control ...**
1: Cell Phone X 2: Cell Phone Y
 (Cell Phone X and Cell Phone Y represent the device names of your cell phones). Press **CELL 1** or **CELL 2**.

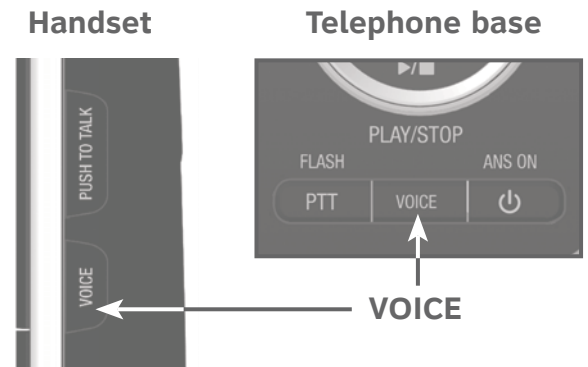

2. The telephone then shows **Activating remote voice control...**
 - If the activation fails, the telephone displays **Connection timeout. Please check cell status..** Press **OK** and try again.

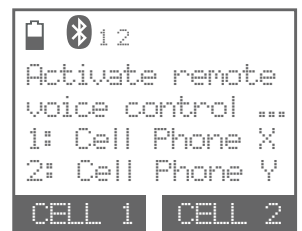

3. When the telephone base or handset plays the confirmation tone as forwarded by the cell phone's voice app, start speaking toward the telephone base or handset, and then wait for feedback. Make reply to the voice app's feedback, if necessary.
 - You can press **)/SPEAKER** on the handset to turn off the speakerphone and listen to the feedback through the handset earpiece.

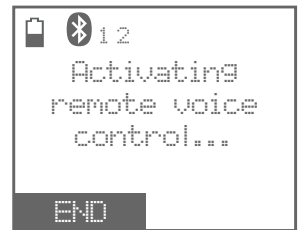

4. To end the current remote voice control session, press **END** on the telephone base or handset. The screen shows **Remote voice control ended.** briefly. You can restart by following Steps 1-3 mentioned above.



Remote voice control

NOTES:

- Once you have activated the remote voice control feature, you are using your cell phone's voice app to operate your cell phone.
- Please check the cell phone user's manual and the voice app's help topics to find out what commands you can use and any limitations of the voice app.
- Some cell phone manufacturers or network carriers may customize the phone's operating system and implement their own voice app. If you want to use Google Now, you need to manually set it as your default voice app. For detailed instructions, refer to your cell phone user's manual, or contact your cell phone's manufacturer or network carrier. You may also go to "Google Product Forums" on the Internet and check the corresponding help topics.
- Due to the settings of certain cell phones and voice apps, your cell phone may not support the remote voice control feature. Contact your cell phone's manufacturer or network carrier, or check the voice app's help topics if you encounter any problems.
- During the remote voice control activation, if your Android cell phone comes with both a dedicated voice app and Google Now, it may prompt you to select which voice app to use, and whether use it for just once or always. Select the desired options. If you do not respond to your cell phone's prompt in time, the telephone displays **Connection timeout. Please check cell status..** Press **OK** and try again.
- If the cell phone is in use, the telephone displays **Bluetooth system busy.**
- If you receive a landline or cell line incoming call when you have activated remote voice control on a connected cell phone, the remote voice control operation will be ended.
- The feature may be ended automatically by your cell phone. For example, a cell call has been established via the remote voice control feature and the call has just ended.
- If you need to press dialing keys (**0-9, TONEX, QUIET#**) during a cell call, please make the call using the cell lines of your telephone system instead of using the voice app via the remote voice control feature (see **Make, answer or end a cell call** on page 52).

Handset and telephone base settings

Use the menu to change the cordless handset or telephone base settings.

1. Press **MENU** on the handset or telephone base when it is not in use to enter the main menu.
2. Press **▼CID** or **▲DIR** on the handset or telephone base to scroll to the feature to be changed. When scrolling through the menu, the selected menu item is highlighted.
3. Press **SELECT** to select the highlighted item.

 **NOTE:** Press **OFF/CANCEL** on the handset, or press **CANCEL** on the telephone base to cancel an operation, back up to the previous menu or exit the menu display. Press and hold **OFF/CANCEL** on the handset, or press **CANCEL** on the telephone base to return to idle mode.

Handset and telephone base settings

Ringer volume

You can select the ringer volume for incoming calls on all lines. A ringer off icon  shows when the volume is set to off.

To set the ringer volume:

1. Press **MENU** in idle mode.
2. Press **▼CID** or **▲DIR** to highlight **Ringers**, then press **SELECT**.
3. Press **SELECT** to select **Ringer volume**.
4. Press **▼CID** or **▲DIR** to sample each ringer volume for all lines.
5. Press **SET** to save. You hear a confirmation tone and the screen returns to the previous menu.



-OR-

1. Press **▼/VOLUME/▲** on the telephone base in idle mode to set the ringer volume of the telephone base.
2. Press **SET** to save. You hear a confirmation tone and the screen returns to the previous menu.

NOTES:

- Changing the handset ringer volume does not affect base ringer volume.
- If the ringer volume is set to off, that handset is silenced for all incoming calls.
- The ringer volume level also determines the ringer levels of intercom calls.
- If the ringer is set to off, the caller ID will not be announced and the screen displays **Caller ID won't be announced** briefly.

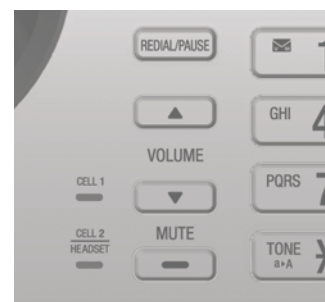

Handset and telephone base settings

Ringer tone

You can select the ringer tones for incoming home and cell calls.

To select the ringer tone:

1. Press **MENU** in idle mode.
2. Press **▼CID** or **▲DIR** to highlight **Ringers**, then press **SELECT**.
3. Press **▼CID** or **▲DIR** to highlight **Ringer tone**, then press **SELECT**.
4. Press **▼CID** or **▲DIR** to highlight **All lines**, **Home**, **Cell 1** or **Cell 2**, then press **SELECT**.
5. Press **▼CID** or **▲DIR** to sample each ringer tone. A sample of each ringer tone plays as you scroll through the choices.
6. Press **SELECT** to save. You hear a confirmation tone and the screen returns to the previous menu.

i **NOTE:** When you turn off the ringer volume, you will not hear ringer tone samples.

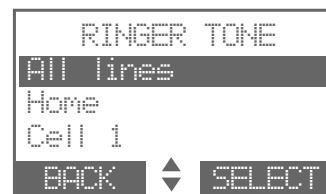

Handset and telephone base settings

LCD language

You can select English, French, or Spanish to be used for all screen displays.

To select the LCD language:

1. Press **MENU** in idle mode.
2. Press **▼CID** or **▲DIR** to highlight **Settings**, then press **SELECT**.
3. Press **SELECT** to select **LCD language**.
4. Press **▼CID** or **▲DIR** to highlight **English**, **Français** or **Español**, then press **SELECT**. The screen prompts **Set English/Français/Español as LCD language?**.
5. Press **YES** to confirm. You hear a confirmation tone and the screen returns to the previous menu.

i **NOTE:** If you accidentally change the LCD language to French or Spanish, you can reset it back to English without going through the French or Spanish menus. Press **MENU** in idle mode, then enter **364#**. There is a confirmation tone.



Handset and telephone base settings

Set date and time

The answering system announces the day and time of each message prior to playing it. Before using the answering system, set the date and time as follows. If you subscribe to caller ID service, the day, month and time are set automatically with each incoming call. If you do not want to set the date and time automatically with caller ID information, turn this feature off (see **Use caller ID to automatically set date and time** on page 44). However, the year must be correct so that the day of the week can be calculated from the caller ID information.

After handset registration or a power failure, the handset or telephone base will prompt you to set the date and time.

To set the date and time manually:

1. Press **MENU** in idle mode.
2. Press **▼CID** or **▲DIR** to highlight **Set date/time**, then press **SELECT**.
3. Press **▼CID** or **▲DIR** to select the month, then press **NEXT**, or enter the 2-digit number using the dialing keys.
4. Press **▼CID** or **▲DIR** to select the day, then press **NEXT**, or enter the 2-digit number using the dialing keys.
5. Press **▼CID** or **▲DIR** to select the year, or enter the 2-digit number using the dialing keys, then press **NEXT** to move on to set the time.
6. Press **▼CID** or **▲DIR** to select the hour, then press **SAVE**, or enter the 2-digit number using the dialing keys.
7. Press **▼CID** or **▲DIR** to select the minute, then press **SAVE**, or enter the 2-digit number using the dialing keys.
8. Press **▼CID** or **▲DIR** to highlight **AM** or **PM**, or press **2** for **AM** or **7** for **PM**, then press **SAVE** to confirm. You hear a confirmation tone and the screen returns to the previous menu.



i NOTE: If the date and time are not set when a message is recorded, the system announces, "Time and day not set," before each message plays.

Handset and telephone base settings

Caller ID announce

The caller ID announce feature lets you know who's calling without having to look at the display. When you have an incoming call, the handset and/or base announces "Call from..." and the name of the caller based on the directory or caller ID information. If the caller's name is private or unknown, the phone number up to the last 11 digits will be announced. If the caller's phone number is also private or unknown, no information will be announced. By default, the caller ID announce feature is **On**.

To turn on or off the caller ID announce feature:

1. Press **MENU** in idle mode.
2. Press **▼CID** or **▲DIR** to highlight **Caller ID annc**, then press **SELECT**.
3. Press **▼CID** or **▲DIR** to select **On** or **Off**, then press **SELECT**. You hear a confirmation tone and the screen shows **CID Annc ON/OFF on all HS & BS** briefly before returning to the previous menu.

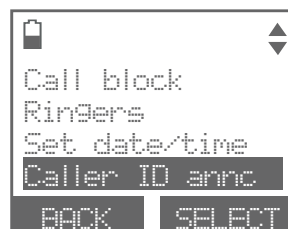
**i NOTES:**

- To use the caller ID announce feature, you must subscribe to caller ID service from your telephone service provider.
- If you have paired an AT&T **TL80133** DECT 6.0 cordless speakerphone to the telephone base, the caller ID announce setting for all devices also applies to the cordless speakerphone. When the setting is **On**, the cordless speakerphone speaks "Call from..." and the name of the caller based on the directory or caller ID information during an incoming call. If the caller's name is unavailable, the phone number up to the last 11 digits will be announced.
- When there are up to five handsets registered, the telephone system supports caller ID announce for all handsets. If six or more handsets are registered, the system supports caller ID announce for the first four registered handsets only.
- This feature does not announce information for call waiting calls.
- When this feature is on, the telephone plays both the caller ID information and the ringer at the same time when there is an incoming call.
- It takes at least two rings for the phone to receive caller ID information and announce it. If the phone is answered before the end of the second ring, the phone will not have time to announce the caller's information.
- Pronunciation of names may vary with this feature. Not all names may be pronounced correctly.
- Caller ID announce is available in English only.



Handset and telephone base settings

Set speed dial voicemail number

This feature lets you save your voicemail number for quick access when you press and hold the  **1** key.

To set your voicemail number:

1. Press **MENU** in idle mode.
2. Press **▼CID** or **▲DIR** to highlight **Settings**, then press **SELECT**.
3. Press **▼CID** or **▲DIR** to highlight **Voicemail #**, then press **SELECT**.
4. Use the dialing keys to enter the voicemail access number provided by your telephone service provider (up to 30 digits) when prompted.
 - Press **▼CID** or **▲DIR** to move the cursor to the left or right.
 - Press **MUTE/DELETE** on the handset, or press **X/DELETE** on the telephone base to erase a digit.
 - Press and hold **MUTE/DELETE** on the handset, or press and hold **X/DELETE** on the telephone base to erase all digits.
 - Press and hold **REDIAL/PAUSE** to enter a three-second dialing pause (a **p** appears).
5. Press **SAVE** to confirm. You hear a confirmation tone and the screen shows **Voicemail # saved** briefly, then returns to the previous menu.

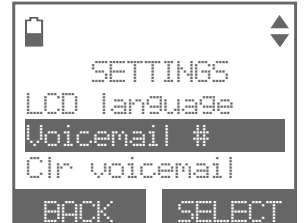

Handset and telephone base settings

Voicemail (visual message waiting) indicator

If you subscribe to a voicemail service offered by your telephone service provider, **New voicemail** and the  icon appear on the handset and telephone base screen when you have new voicemail messages. Contact your service provider for more information and assistance about using your voicemail service.

i NOTES:

- This feature does not indicate new messages recorded on your phone's built-in answering system.
- For more information about the difference between your answering system and voicemail, see page 118.

Clear voicemail indicator/indication

Use this feature when the telephone indicates there is new voicemail but there is none. For example, when you have accessed your voicemail while away from home. This feature only turns off the displayed **New voicemail** and the  icon; it does not delete your voicemail messages. As long as you have new voicemail messages, your telephone service provider continues to send the signal to turn on the indicator.

To manually turn off the new voicemail indicator:

1. Press **MENU** in idle mode.
2. Press **▼CID** or **▲DIR** to highlight **Settings**, then press **SELECT**.
3. Press **▼CID** or **▲DIR** to highlight **Clr voicemail** on the handset or **Clear voicemail** on the telephone base, then press **SELECT**. The screen shows **Reset Voicemail Indicator?** or **Reset Voicemail indication?**
4. Press **YES** to turn the voicemail indicator off. You hear a confirmation tone and the screen returns to the previous menu.

i NOTES:

- Your telephone service provider voicemail might alert you to new messages with a stutter (broken) dial tone. Contact your telephone service provider for more details.
- For information about using your voicemail service, contact your telephone service provider.



Handset and telephone base settings

Key tone

The handset and telephone base are set to beep with each key press. You can adjust the key tone volume or turn it off. If you turn off the key tone, there are no beeps when you press keys.

To set the key tone:

1. Press **MENU** in idle mode.
2. Press **▼CID** or **▲DIR** to highlight **Settings**, then press **SELECT**.
3. Press **▼CID** or **▲DIR** to highlight **Key tone**, then press **SELECT**.
4. Press **▼CID** or **▲DIR** to select the desired volume or **Off**.
5. Press **SET** to confirm. You hear a confirmation tone and the screen returns to the previous menu.

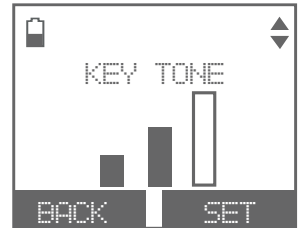
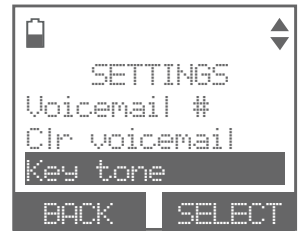

Handset and telephone base settings

Use caller ID to automatically set date and time

The **CID time sync** feature is preset to **On**. If you subscribe to caller ID service, the date and time will be set automatically by the caller ID information. You can turn off this feature if you want to set the date and time manually.

To turn on or off the CID time sync feature:

1. Press **MENU** in idle mode.
2. Press **▼CID** or **▲DIR** to highlight **Settings**, then press **SELECT**.
3. Press **▼CID** or **▲DIR** to highlight **CID time sync**, then press **SELECT**.
4. Press **▼CID** or **▲DIR** to select **On** or **Off**, then press **SELECT** to save. You hear a confirmation tone and the screen returns to the previous menu.



Handset and telephone base settings

Home area code

If you dial seven digits to make a local call (no area code required), enter your area code into the telephone as the home area code. When you receive a call from within your home area code, the caller ID log only displays the seven digits of the telephone number.

This feature makes it easy for you to place a call from the caller ID log. If you dial 10 digits to make a local phone call, do not use this home area code feature. If you do, you cannot place local calls from your caller ID log, as they will have only seven digits.

To set the home area code:

1. Press **MENU** in idle mode.
2. Press **▼CID** or **▲DIR** to highlight **Directory**, then press **SELECT**.
3. When **Home** is highlighted, press **OPTION**.
4. Press **▼CID** or **▲DIR** to highlight **Home area code**, then press **SELECT**. The screen briefly shows **Only for 7 digits dialing from Caller ID log**.
5. Use the dialing keys to enter a three-digit home area code.
 - Press **▼CID** or **▲DIR** to move the cursor to the left or right.
 - Press **MUTE/DELETE** on the handset, or press **X/DELETE** on the telephone base to erase a digit.
 - Press and hold **MUTE/DELETE** on the handset, or press and hold **X/DELETE** on the telephone base to erase all digits.
6. Press **SAVE** to confirm. You hear a confirmation tone and the screen shows **Area code will not show in Caller ID log** briefly before returning to the previous menu.



i NOTE: If, in the future, your telephone service provider requires you to dial 10 digits to make a local call (area code + telephone number), you will need to delete your home area code. With the home area code displayed, press and hold **MUTE/DELETE** on the handset or press and hold **X/DELETE** on the telephone base until the digits are deleted, and then press **SAVE**. The home area code is now restored to its default setting of **___** (empty).

Handset and telephone base settings

Cell area code

Most cell phone entries are stored in a 10-digit format. If all of your cell phone entries are stored this way, you do not need to program your cell area code.

If your cell phone stores entries in a 7-digit format, we recommend that you program your cell area code so that your 7-digit directory entries can be dialed correctly using your home line.

To set the cell area code:

1. Press **MENU** in idle mode.
2. Press **▼CID** or **▲DIR** to highlight **Directory**, then press **SELECT**.
3. Press **▼CID** or **▲DIR** to highlight a desired downloaded directory, then press **OPTION**.
4. Press **SELECT** to choose **Cell area code**. The screen briefly shows **Only for 7 digits dialing from Caller ID log**.
5. Use the dialing keys to enter the desired cell area code.
 - Press **▼CID** or **▲DIR** to move the cursor to the left or right.
 - Press **MUTE/DELETE** on the handset, or press **X/DELETE** on the telephone base to erase a digit.
 - Press and hold **MUTE/DELETE** on the handset, or press and hold **X/DELETE** on the telephone base to erase all digits.
6. Press **SAVE** to confirm. You hear a confirmation tone and the screen shows **Area code will not show in Caller ID log** briefly before returning to the previous menu.



Handset and telephone base settings

Dial mode

The dial mode is preset to tone dialing. If you have pulse (rotary) service, you must change the dial mode to pulse dialing before using the telephone.

To set the dial mode:

1. Press **MENU** in idle mode.
2. Press **▼CID** or **▲DIR** to highlight **Settings**, then press **SELECT**.
3. Press **▼CID** or **▲DIR** to highlight **Dial mode**, then press **SELECT**.
4. Press **▼CID** or **▲DIR** to choose **Touch-tone** or **Pulse**, then press **SELECT**. The screen shows **DIAL MODE is touch-tone/pulse**. You hear a confirmation tone and the screen returns to the previous menu.

**Web address**

You can use this feature to view the AT&T website address.

1. Press **MENU** in idle mode.
2. Press **▼CID** or **▲DIR** to highlight **Web address**, then press **SELECT**. The screen shows the AT&T website address.
3. Press **OK** to return to the main menu.



Handset and telephone base settings

QUIET mode

When **QUIET** mode is turned on, the telephone silences all sounds during the set period of time (1-12 hours). However, the handset locator paging tone and any sound-generating operations initiated by users, such as making calls using the speakerphone or setting ringer volume, will sound as normal. After you turn on **QUIET** mode, this feature activates immediately and the answering system turns on automatically.

When **QUIET** mode is on, the answering system takes calls and records messages without broadcasting them.

To turn QUIET mode on:

1. Press and hold **QUIET #** in idle mode to enter the **QUIET** mode setting screen. The screen shows **SET QUIET MODE DURATION (1 to 12 hours)_ _**.
2. Use the dialing keys to enter the desired number of hours (1-12) you would like to turn on **QUIET** mode, then press **SELECT**. The screen briefly shows **Answering sys is ON during quiet mode** and then **Quiet mode on** on idle screen.

To turn QUIET mode off:

- While **QUIET** mode is on, press and hold QUIET #. Then, the screen shows **Quiet mode is off** and you hear a confirmation tone.

i NOTES:

- If you change the base ringer, handset ringer, ringer volume, key tone, or caller ID announce features when **QUIET** mode is on, the sample plays but the feature is still muted after saving the setting.
- After **QUIET** mode is turned off or the set period of time has expired, all muted features will be activated again.
- The **PTT** function is not available when **QUIET** mode is on.

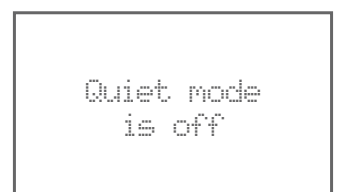
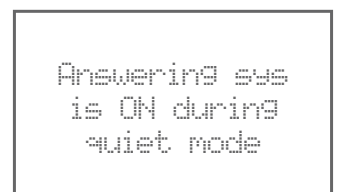
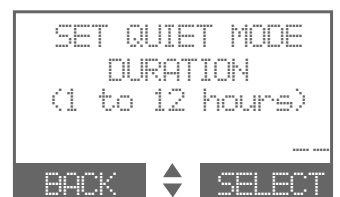
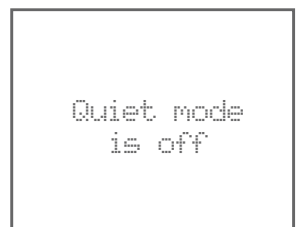
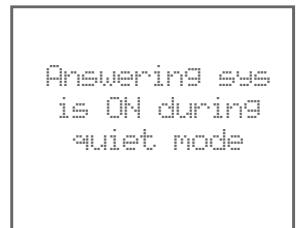

Handset and telephone base settings

No line alert

If there is no telephone line connected to the telephone base, the screens show **No home line**. If you do not want to display this message on the screens (for example, if you use the cell phone only), you can turn the no line alert off using the code, as described below.

To turn off the no line alert:

- Press **MENU** in idle mode, then enter ***662#**. You hear a confirmation tone.

To turn the no line alert back on:

- Press **MENU** in idle mode, then enter ***661#**. You hear a confirmation tone.

Cell alert

If you have downloaded the **Connect to Cell** application and use the **Alerts manager** (page 19), there are message notification sent to your telephone system. Your telephone system beeps once when your Android cell phone receives text messages, e-mails or social media updates. You can turn the alert tone on or off using the code, as described below.

To turn the alert tone off:

- Press **MENU** in idle mode, then enter ***252#**. You hear a confirmation tone.

To turn the alert tone back on:

- Press **MENU** in idle mode, then enter ***251#**. You hear a confirmation tone.

Telephone operation

Make, answer or end a home call

Using a handset:

To make a home call:

- Press **HOME/FLASH** or **SPEAKER**, then enter the telephone number.

To predial a home call:

- Enter the telephone number, then press **HOME/FLASH** or **SPEAKER**.

To answer a home call:

- Press **HOME/FLASH**, **SPEAKER**, **CELL 1**, **CELL 2** or any dialing key (**0-9** or **TONE X**).

To end a home call:

- Press **OFF/CANCEL**, or put the handset in the telephone base or charger.

Using the telephone base:

To make a home call:

- Press **HOME**, then enter the telephone number.

To predial a home call:

- Enter the telephone number, then press **HOME**.

To answer a home call:

- Press **HOME**, **CELL 1**, **CELL 2** or any dialing key (**0-9** or **TONE X**).

To end a home call:

- Press **HOME**.

NOTES:

- The screen shows the elapsed time as you talk (in hours, minutes and seconds).
- When predialing (preview numbers before dialing), press **MUTE/DELETE** on the handset or **X/DELETE** on the telephone base to backspace and delete; press and hold **REDIAL/PAUSE** to insert a dialing pause (a **p** appears).
- You cannot answer a home call using your connected cell phone.

Telephone operation

Using a Bluetooth headset:

You can use a Bluetooth headset for home calls. However, you need to keep the device within 15 feet of the telephone base for optimal performance. Please see the user's manual of your Bluetooth headset for more information.

If you make or answer a home call on the telephone base, you can transfer the call to your headset. The telephone base remains active, but the telephone base speaker and microphone are muted. If you end the call on the telephone base, the call on the headset ends.

To answer or end a home call using a Bluetooth headset:

- Press the call key on your headset.

To transfer a call from the telephone base to a Bluetooth headset:

- Press **OPTION** during a home line call.
- Press **▼CID** or **▲DIR** to highlight **Use BT Headset**, then press **SELECT** twice. The screen displays **Transferring audio to Headset A**, the message disappears if the call is successfully transferred to the Bluetooth headset.

To transfer a call from the Bluetooth headset back to the telephone base:

- Press **OPTION**, then press **▼CID** or **▲DIR** to highlight **Use base** and press **SELECT**.

To end a call that started at the telephone base:

- Press **HOME** on the telephone base.

NOTES:

- If you answer a call from the headset, that call cannot be transferred to a handset.
- You will not see **Use BT Headset** when the Bluetooth headset is already in use, or there are no active Bluetooth headsets in the device list.
- While using the cell line, you cannot choose **Use BT Headset**.
- If you answer a call using a headset, and you lose the Bluetooth connection or the battery is depleted, the call is lost.
- If you are using a headset for a call which is transferred from a **TL96276/TL96456** telephone base, and you lose the Bluetooth connection or the battery of the headset is depleted, the call is lost.

Telephone operation

Make, answer or end a cell call

The **TL96276/TL96456** can be used to make or answer calls on the cell line. You can connect a maximum of two Bluetooth enabled cell phones to the telephone base. Both cell phones can be used on cell calls at the same time.

Using a handset:





To make a cell call:

- Press  **CELL 1** or  **CELL 2**. Enter the telephone number, then press **DIAL**.

To predial a cell call:

- Enter the telephone number, then press  **CELL 1** or  **CELL 2**.

To answer a cell call:

- Press  **HOME/FLASH**,  **/SPEAKER**,  **CELL 1**,  **CELL 2** or any dialing key (**0-9** or **TONE X**).

To end a cell call:

- Press  **OFF/CANCEL**, or put the handset in the telephone base or charger.

Using the telephone base:

To make a cell call:

- Press  **CELL 1** or  **CELL 2**. Enter the telephone number, then press **DIAL**.

To predial a cell call:

- Enter the telephone number, then press  **CELL 1** or  **CELL 2**.

To answer a cell call:

- Press  **HOME**,  **CELL 1**,  **CELL 2** or any dialing key (**0-9** or **TONE X**).

To end a cell call:

- Press  **CELL 1** or  **CELL 2**.

NOTES:

- You can also use your cell phone to answer the call. If you answer with your cell phone, it disconnects from the telephone base.
- If you do not want to answer the call, press **REJECT**.
- When you try to make a cell call but your cell phone is not connected to the base, the telephone base displays **Cellular phone not connected. Please connect to proceed..** Refer to **Bluetooth connection from idle mode** on page 24 and **Connect/disconnect an active device** on page 25.
- Make a cell call using the cell lines of your telephone system instead of the remote voice control feature, if you need to press dialing keys (**0-9**, **TONE X**, **QUIET #**) during a call.

Telephone operation

Silence the ringer

When the telephone is ringing, you can temporarily silence the ringer of the handset or telephone base without disconnecting the call. The next call rings normally at the preset volume.

To silence the handset ringer:

- Press **MUTE** (for home calls), **SILENCE** (for cell calls), **OFF/CANCEL**, **MUTE/DELETE** or **QUIET #** on the handset. The handset screen shows **Ringer muted**.

To silence the base ringer:

- Press **MUTE** (for home calls), **SILENCE** (for cell calls), **MUTE** or **QUIET #** on the telephone base. The telephone base screen shows **Ringer muted**.

Call waiting on the home line

If you subscribe to call waiting service from your telephone service provider, and someone calls while you are already on a call on the home line, you hear two beeps.

- Press **HOME/FLASH** on the handset, or press **PTT/FLASH** on the telephone base to put your current call on hold and take the new call.
- Press the same key at any time to switch back and forth between calls.

Call waiting on the cell line

If you subscribe to call waiting service from your cell phone service provider, and someone calls while you are already on a call on the cell line, you hear two beeps.

Using a handset:

- Press **CELL 1** or **CELL 2** to put your current call on hold and take the new call.
- Press **CELL 1** or **CELL 2** at any time to switch back and forth between calls.

-OR-

- Press **SWAP** to switch. To switch back, press **CELL 1** or **CELL 2**.

Using the telephone base:



- Press **SWAP** on the telephone base. The original call is put on hold and you take the new call.
- To switch back, press **OPTION** on the telephone base. Press **▼CID** or **▲DIR** to highlight **Swap Cell 1** or **Swap Cell 2**. Press **SELECT** to resume the original call. The other incoming cell call is put on hold.

Telephone operation

Cell phone voicemail



If you have voicemail service active on your cell phone, and you do not answer the incoming cell call, the call is answered by your cell phone's voicemail. Contact your cell phone service provider for more information about voicemail service.

Answer an incoming cell call while on a home call

If you are on a home call and you receive an incoming cell call, you hear two beeps and  **1** or  **2** displays on the handset or telephone base you are using. The telephone base and all other handsets ring.

To answer the incoming cell call:

Using a handset:



- Press  **CELL 1** or  **CELL 2** on the handset or telephone base. The home call is automatically placed on hold. All other handsets and the telephone base display **Home call on hold** and **Cell 1/2 line in use**, alternately.

To end the cell call:

Using a handset:

- Press  **OFF/CANCEL** on the handset. The home line is still on hold. All devices display **Home call on hold**.

Using the telephone base:

- Press  **CELL 1** or  **CELL 2** on the telephone base. The home line is still on hold. All devices display **Home call on hold**.

To resume the home call on hold:



- Press  **HOME/FLASH** on the handset, or press  **HOME** on the telephone base.

Telephone operation



Answer an incoming home call while on a cell call

If you are on a cell call and you receive an incoming home call, you hear two beeps and  displays on the handset or telephone base you are using. The telephone base and all other handsets ring.

To answer the incoming home call:

- Press  **HOME/FLASH** on the handset or  **HOME** on the telephone base to answer the incoming home call. The cell call is automatically placed on hold and all devices display **Cell 1/2 call on hold** and **Home line in use**, alternately.

To end the home call:

- Press  **OFF/CANCEL** on the handset or  **HOME** on the telephone base. The cell line is still on hold. All devices display **Cell 1/2 call on hold**.

To resume the cell call on hold:

- Press  **CELL 1** or  **CELL 2**.

 **NOTE:** If you have turned on your answering system and you do not answer the incoming home call, the call is answered by your answering system.

Conference calls

Conference home and cell calls

When you have calls established on the home and cell lines, you can create a 3-way conference.

To conference both home and cell calls:

1. Press **OPTION** on the handset or telephone base.
2. Press **▼CID** or **▲DIR** to highlight **Conference**, then press **SELECT**.
The conferencing device's screen displays **Conf**.

To select an option while on a conference call:

1. Press **OPTION** on the handset or telephone base.
2. Press **▼CID** or **▲DIR** to highlight one of the following options:
 - **End Home line**
 - **End Cell 1/2 line**
 - **Equalizer**
 - **Caller ID log**
 - **Directory**
3. Press **SELECT**.

To end a conference call:

Using a handset:

- Press **OFF/CANCEL** or put the handset back in the telephone base or charger. The call continues until all people hang up.

Using the telephone base:

- Press **HOME**, **CELL 1** or **CELL 2**. The call continues until all people hang up.

Conference calls

Using the home and cell lines together:

- You can be on two different calls at the same time using the cell line and home line and two handsets.
- You can be on a call using the cell line and a Bluetooth headset via the home line at the same time.
- If you are on a call using the cell line, you cannot join the call using your paired cell phone. However, you can join the call using another **TL96276/TL96456** device. Your cell phone is being used for the phone call so only features that are normally available during a call can be used.

Options while on calls

Handset speakerphone

During a call, press **☎/SPEAKER** to switch between the speakerphone and normal handset use.

Press **☎ OFF/CANCEL**, or return the handset to the telephone base or charger to hang up.

Volume control

While on a call, you can adjust the listening volume on the handset or telephone base.

If it is a cell call and the volume is too loud, too quiet or drops out, try changing the volume on your cell phone. On some cell phones, changing the volume on the cell phone affects your cell call volume on the **TL96276/TL96456** handsets and telephone base.

To adjust the listening volume of a handset:

- Press **▼/VOLUME/▲** on the handset while on a call.

To adjust the listening volume of the telephone base:

- Press **▼/VOLUME/▲** on the telephone base while on a call.

Options while on calls

Mute

Use the mute function to turn off the microphone. You can hear the caller, but the caller cannot hear you.

Using a handset:

To mute a call:

- While on a call, press **MUTE/DELETE**. When mute is on, the handset screen shows **Muted** for a few seconds and the **MUTE** icon appears until you end mute the call.

To end mute a call:

- Press **MUTE/DELETE** again and resume speaking. When mute is off, **Microphone ON** appears temporarily on the handset.

Using the telephone base:

To mute a call:

- While on a call, press **MUTE**. When mute is on, the telephone base shows **Muted** for a few seconds. The **MUTE** light turns on and **MUTE** icon appears until you end mute the call.

To end mute a call:

- Press **MUTE** again and resume speaking. When mute is off, **Microphone ON** appears temporarily on the telephone base. The **MUTE** light turns off.

Mute is automatically canceled when you end the call.

Temporary tone dialing

If you have pulse (rotary) service only, you can switch from pulse to touch-tone dialing temporarily during a call. This is useful if you need to send touch-tone signals to access your telephone banking or long distance services.

During a call:

1. Press **TONE X** on the handset or telephone base.
2. Use the dialing keys to enter the relevant number. The telephone sends touch-tone signals.
3. The telephone automatically returns to pulse dialing after you end the call.

Options while on calls

Hold

You can place any call on hold. You hear an alert tone at the telephone base if you have not taken the call off hold after 14 minutes. You hear another alert tone at the telephone base 30 seconds later. At 15 minutes on hold, the call on hold automatically disconnects.

To place a home call on hold:

- Press **HOLD** on the handset or telephone base. **Home call on hold** appears on the handsets and telephone base. **HOME/FLASH** flashes on the handsets and **HOME** flashes on the telephone base.

To resume a home call on hold:

- Press **HOME/FLASH** on the handset or **HOME** on the telephone base.

To place a cell call on hold:

- Press **HOLD** on the handset or telephone base. **Cell 1/2 call on hold** appears on the handsets and telephone base. **CELL 1** or **CELL 2** flashes on the handsets. **CELL 1** or **CELL 2** flashes on the telephone base.

To resume a cell call on hold:

- Press **CELL 1** or **CELL 2** on the handset or telephone base.



Equalizer

The equalizer feature enables you to change the audio quality to best suit your hearing.

1. While on a home call or cell call, press **OPTION**.
2. Press **▼CID** or **▲DIR** to highlight **Equalizer**, then press **SELECT**.
3. Press **▼CID** or **▲DIR** to select **Natural** (the default setting), **Treble 1**, **Treble 2** or **Bass**, then press **SELECT**. There is a confirmation tone and the screen returns to the previous menu.

NOTES:

- If you switch the call between the handset and speakerphone by pressing **◀)/SPEAKER**, the audio setting remains unchanged.
- The current equalizer setting remains unchanged until a new setting is selected.

Options while on calls

Chain dialing

Use this feature to initiate a dialing sequence from numbers stored in the directory, caller ID log or redial list while you are on a call.

Chain dialing is useful if you wish to access other numbers (such as bank account numbers or access codes) from the directory, caller ID log or redial list.

Using a handset:

To access a number in the directory while on a call:

1. Press **OPTION**.
2. Press **▼CID** or **▲DIR** to highlight **Directory**, then press **SELECT**.
3. Press **▼CID** or **▲DIR** to highlight the desired directory, then press **REVIEW**.
4. Press **▼CID** or **▲DIR** to scroll to the desired entry or perform an alphabetical search (page 90).
5. Press **DIAL** to dial the displayed number.

To access a number in the caller ID log while on a call:

1. Press **OPTION**.
2. Press **▼CID** or **▲DIR** to highlight **Caller ID log**, then press **SELECT**.
3. Press **▼CID** or **▲DIR** to scroll to the desired entry.
4. Press **CALL** to dial the displayed number.

To access the redial list while on a call:

1. Press **REDIAL/PAUSE**.
2. Press **▼CID**, **▲DIR**, or **REDIAL/PAUSE** until the desired number displays.
3. Press **DIAL** to dial the displayed number.

Options while on calls

Using the telephone base:

To access a number in the directory while on a call:

1. Press **▲DIR**.
2. Press **▼CID** or **▲DIR** to highlight the desired directory, then press **REVIEW**.
3. Press **▼CID** or **▲DIR** to scroll to the desired entry or perform an alphabetical search (page 90).
4. Press **DIAL** to dial the displayed number.

To access a number in the caller ID log while on a call:

1. Press **▼CID**.
2. Press **▼CID** or **▲DIR** to scroll to the desired entry.
3. Press **CALL** to dial the displayed number.

To access the redial list while on a call:

1. Press **REDIAL/PAUSE**.
2. Press **▼CID**, **▲DIR**, or **REDIAL/PAUSE** until the desired number displays.
3. Press **DIAL** to dial the displayed number.



NOTES:

- You cannot edit a directory entry while on a call. For more details about the directory, see pages 84-93.
- You cannot copy a caller ID log entry into the directory while on a call. For more details about caller ID log, see pages 94-101.
- You can only view the numbers in the directory, caller ID log or redial list while on a call and cannot edit, delete or save entries.
- Press **OFF/CANCEL** on the handset or press **CANCEL** on the telephone base to exit redial list, directory or caller ID log while on a call.

Redial

Last number redial

The telephone base and each handset store the last 10 dialed numbers (up to 30 digits each) in the redial list. The redial entries of each handset and the telephone base are independent.

To view the 10 most recently dialed numbers:

Using a handset:

1. Press **REDIAL/PAUSE** in idle mode.
2. Press **▼CID**, **▲DIR** or **REDIAL/PAUSE** repeatedly to browse until the desired number displays. The handset beeps twice at the end of the list.
3. Press **OFF/CANCEL** to exit.

Using the telephone base:

1. Press **REDIAL/PAUSE** in idle mode.
2. Press **▼CID**, **▲DIR** or **REDIAL/PAUSE** repeatedly to browse until the desired number displays. The telephone base beeps twice at the end of the list.
3. Press **BACK** or **CANCEL** to exit.



Dial a redial entry

Using a handset:

1. Press **REDIAL/PAUSE** in idle mode.
2. Press **▼CID**, **▲DIR** or **REDIAL/PAUSE** repeatedly to browse until the desired number displays. The handset beeps twice at the end of the list.
3. Press **HOME/FLASH** or **)/SPEAKER** to dial using the home line, or press **CELL 1** or **CELL 2** to dial using the cell line.

-OR-

1. Press **HOME/FLASH** or **)/SPEAKER** to dial using the home line, or press **CELL 1** or **CELL 2** to dial using the cell line, then press **REDIAL/PAUSE** to enter the redial list.
2. Press **▼CID**, **▲DIR** or **REDIAL/PAUSE** repeatedly to browse until the desired number displays. The handset beeps twice at the end of the list.
 - If you are using the cell line, press **INSERT** to select the desired number.
3. Press **DIAL** to dial the number displayed.

Redial

Using the telephone base:

1. Press **REDIAL/PAUSE** in idle mode.
2. Press **▼CID**, **▲DIR** or **REDIAL/PAUSE** repeatedly to browse until the desired number displays. The telephone base beeps twice at the end of the list.
3. Press **🏠HOME** to dial using the home line, or press **📶CELL 1** or **📶CELL 2** to dial using the cell line.

-OR-

1. Press **🏠HOME** to dial using the home line, or press **📶CELL 1** or **📶CELL 2** to dial using the cell line, then press **REDIAL/PAUSE** to enter the redial list.
2. Press **▼CID**, **▲DIR** or **REDIAL/PAUSE** repeatedly to browse until the desired number displays. The handset beeps twice at the end of the list.
 - If you are using the cell line, press **INSERT** to select the desired number.
3. Press **DIAL** to dial the number displayed.

Insert the area code to the redial number

You can insert the area code to the redial number before dialing.

1. Enter the area code in idle mode, then press **REDIAL/PAUSE**.
2. Press **▼CID**, **▲DIR** or **REDIAL/PAUSE** repeatedly to browse until the desired number displays, then press **INSERT**. The area code will be added in front of the selected redial number.
3. Press **🏠HOME** to dial using the home line, or press **📶CELL 1** or **📶CELL 2** to dial using the cell line.

Redial

Save a redial entry to the directory

Using a handset:

1. Press **REDIAL/PAUSE** in idle mode.
2. Press **▼CID**, **▲DIR** or **REDIAL/PAUSE** repeatedly to browse until the desired number displays.
3. Press **SAVE**.
4. The screen displays **EDIT NUMBER**. Use the dialing keys to edit the number, if necessary.
 - Press **▼CID** or **▲DIR** to move the cursor to the left or right.
 - Press **BACKSP** or **MUTE/DELETE** to erase a digit.
 - Press and hold **MUTE/DELETE** to erase all digits.
 - Press and hold **REDIAL/PAUSE** to insert a three-second dialing pause (a **p** appears).
5. Press **NEXT**.
6. The screen displays **SELECT LABEL**. Press **▼CID** or **▲DIR** to select one of the following label:
 - Home
 - Cell
 - Work
 - Other
7. The screen displays **ENTER NAME**. Use the dialing keys to enter a name (up to 15 characters). Press a key repeatedly until the desired character shows on the screen (see **Character chart** on page 87).
 - Press **▼CID** or **▲DIR** to move the cursor to the left or right.
 - Press **0** to add a space.
 - Press **BACKSP** or **MUTE/DELETE** to erase a character.
 - Press and hold **MUTE/DELETE** to erase all characters.
 - Press **a>A** to change the next letter to upper or lower case.
8. Press **SAVE** and then **Saved** displays. You hear a confirmation tone.

Redial

Using the telephone base:

1. Press **REDIAL/PAUSE** in idle mode.
2. Press **▼CID**, **▲DIR** or **REDIAL/PAUSE** repeatedly to browse until the desired number displays.
3. Press **SAVE**.
4. The screen displays **EDIT NUMBER**. Use the dialing keys to edit the number, if necessary.
 - Press **▼CID** or **▲DIR** to move the cursor to the left or right.
 - Press **BACKSP** or **X/DELETE** to erase a digit.
 - Press and hold **X/DELETE** to erase all digits.
 - Press and hold **REDIAL/PAUSE** to insert a three-second dialing pause (a **p** appears).
5. Press **NEXT**.
6. The screen displays **SELECT LABEL**. Press **▼CID** or **▲DIR** to select one of the following label:
 - Home
 - Cell
 - Work
 - Other
7. The screen displays **ENTER NAME**. Use the dialing keys to enter a name (up to 15 characters). Press a key repeatedly until the desired character shows on the screen (see **Character chart** on page 87).
 - Press **▼CID** or **▲DIR** to move the cursor to the left or right.
 - Press **0** to add a space.
 - Press **BACKSP** or **MUTE/DELETE** to erase a character.
 - Press and hold **MUTE/DELETE** to erase all characters.
 - Press **a>A** to change the next letter to upper or lower case.
8. Press **SAVE** and then **Saved** displays. You hear a confirmation tone.

Delete a redial entry

1. Press **REDIAL/PAUSE** in idle mode.
2. Press **▼CID**, **▲DIR** or **REDIAL/PAUSE** repeatedly to browse until the desired number displays.
3. Press **MUTE/DELETE** on the handset or **X/DELETE** on the telephone base to delete the displayed number. You hear a confirmation tone.

Telephone operation

Handset locator

This feature helps you find a misplaced handset.

To start paging:

- Press **📞**/**HANDSET LOCATOR** on the telephone base when it is not in use. All idle handsets ring and display **** Paging ****.

To mute the paging tone on a cordless handset:

- Press **MUTE**, **MUTE/DELETE**, **📞 OFF/CANCEL**, or **QUIET#**.

To stop paging to all handsets:

- Press **📞**/**HANDSET LOCATOR**, **CANCEL** or **STOP** on the telephone base.

-OR-

- Press **🏠 HOME/FLASH**, **🔊)/SPEAKER**, or any dialing key (**0-9**, **TONE ✖**) on the handset.

NOTES:

- If the handset ringer volume is set to off, the handset still rings when paged.
- If there is no response after 60 seconds, the paging ends.

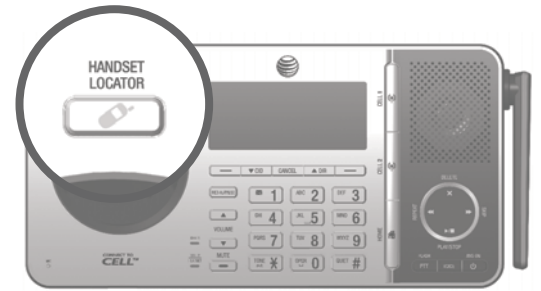

Multiple handset use

Join a call in progress

Another handset or the telephone base can join you on an outside call. The call continues until all people hang up. You can share an outside call with the telephone base and up to four system handsets.

To join a home call:

Using a handset:

- Press HOME/FLASH or /SPEAKER on another handset to join the call.

Using the telephone base:

- Press HOME to join the call.

To join a cell call:

Using a handset:

- Press CELL 1 or CELL 2 on another handset to join the call.

Using the telephone base:

- Press CELL 1 or CELL 2 to join the call.

Intercom

Use the intercom feature for conversations between two handsets, a handset and the telephone base, or a handset/telephone base and a cordless headset/speakerphone (sold separately).

You can buy additional expansion handsets (AT&T model **TL90076**, sold separately), cordless headsets and speakerphones for this telephone system. You can register up to 12 handsets or 10 cordless handsets and two cordless headsets/speakerphones to the telephone base.

Initiate an intercom call

Using a handset:

1. Press **MENU** in idle mode.
 2. Press **▼CID** or **▲DIR** to highlight **Intercom**, then press **SELECT**.
 - If you have one handset and no other registered device, your handset displays **Calling base**.
 - If you have other registered device(s) or more than one handset, your handset displays **INTERCOM TO:** and a list of registered devices.
 - ◆ Press **▼CID** or **▲DIR** to highlight a destination device or all devices, then press **SELECT**.
- OR-**
- ◆ Use the dialing keys to enter a specific device number (**0** for the telephone base, or **1-9** for handset 1-9, **TONEX** followed by **0-2** for handset 10-12, or **#** for a single headset/speakerphone, **#** followed by **1** or **2** for headset/speakerphone 1 or 2, or **TONEX** followed by **#** for all devices).



Your handset displays **Calling HANDSET X**, **Calling BASE 0**, **Calling headset** or **Calling all**. The destination device(s) rings and shows **HANDSET is calling**, **HANDSET X is calling** or **HANDSET X is calling all** (**HANDSET** represents the handset name, **X** represents the handset number).

Intercom

Using the telephone base:

1. Press **MENU** in idle mode.
2. Press **▼CID** or **▲DIR** to highlight **Intercom**, then press **SELECT**.
 - If you have one handset and no other registered device, the telephone base displays **Calling HANDSET 1**.
 - If you have other registered device(s) or more than one handset, the telephone base displays **INTERCOM TO:** and a list of registered devices.
 - ◆ Press **▼CID** or **▲DIR** to highlight a destination device or all devices, then press **SELECT**.

-OR-

 - ◆ Use the dialing keys to enter a specific device number (**1-9** for handset 1-9, **TONEX** followed by **0-2** for handset 10-12, or **#** for a single headset/speakerphone, **#** followed by **1** or **2** for headset/speakerphone 1 or 2, or **TONEX** followed by **#** for all devices).

The telephone base displays **Calling HANDSET X**, **Calling headset** or **Calling all**. The destination handset(s) rings and shows **Base 0 is calling** or **Base 0 is calling all** (**HANDSET** represents the handset name, **X** represents the handset number).

NOTES:

- You can cancel the intercom call before it is answered by pressing **OFF/CANCEL** on the handset, or by pressing **END** or **CANCEL** on the telephone base.
- If you are calling all handsets, only the first handset to pick up can answer the intercom call.
- If the destination device does not answer the intercom call within 100 seconds, or if the device is in use, on a call, or out of range, the initiating device displays **No answer. Try again.** and returns to idle mode.
- To temporarily silence the intercom ringer, press **MUTE**, **OFF/CANCEL** or **MUTE/DELETE** on the handset, or press **MUTE**, **CANCEL** or **MUTE** on the telephone base.
- You can only use one pair of devices at a time to make intercom calls.

Intercom

Answer an intercom call

Using a handset:

- Press **HOME/FLASH**, **SPEAKER**, **CELL 1**, **CELL 2** or any dialing key (**0-9** or **TONE X**). Both devices show **Intercom**.

Using the telephone base:

- Press **HOME**, **CELL 1**, **CELL 2** or any dialing key (**0-9** or **TONE X**). Both devices show **Intercom**.

End an intercom call

Using a handset:

- Press **END** or **OFF/CANCEL**, or place the handset back in the telephone base or charger. The other party hears four beeps. Both devices display **Intercom ended**.

Using the telephone base:

- Press **END**. The other party hears four beeps. Both devices display **Intercom ended**.

 **NOTE:** For cordless headsets and speakerphones, refer to the corresponding user's manual on how to answer and end an intercom call.



Intercom

Answer an incoming call during an intercom call

When you receive an incoming home call or cell call during an intercom call, the two devices on the intercom call hear an alert tone, and their screens display **Incoming call** and then the caller ID. The telephone base and all other handsets ring.

To answer a home call during an intercom call:

Using a handset:



- Press  **HOME/FLASH** to answer the home call and the intercom call ends automatically.
- Press  **OFF/CANCEL**, or press **BACK** and then **END** to end the intercom call without answering the incoming call. The telephone continues to ring.

Using the telephone base:



- Press  **HOME** to answer the home call and the intercom call ends automatically.
- Press **BACK** and then **END** to end the intercom call without answering the incoming call. The telephone continues to ring.

To answer a cell call during an intercom call:

Using a handset:

- Press  **CELL 1** or  **CELL 2** to answer the cell call and the intercom call ends automatically.
- Press  **OFF/CANCEL**, or press **BACK** and then **END** to end the intercom call without answering the incoming call. The telephone continues to ring.

Using the telephone base:

- Press  **CELL 1** or  **CELL 2** to answer the cell call and the intercom call ends automatically.
- Press **BACK** and then **END** to end the intercom call without answering the incoming call. The telephone continues to ring.

 **NOTE:** For cordless headsets and speakerphones, refer to the corresponding user's manual on how to answer an incoming call during an intercom call.

Call transfer using intercom

Use the intercom feature to transfer an outside call to another system handset or the telephone base. You can also share an outside call with another system handset or the telephone base.

To transfer or share an outside call using intercom:

Using a handset:

1. When on an outside call, press **OPTION**.
2. Press **SELECT** to choose **Intercom**. The call is automatically put on hold.



- If you have one handset and no other registered device, your handset displays **Calling base**.
- If you have other registered device(s) or more than one handset, your handset displays **INTERCOM TO:** and a list of registered devices.

- ◆ Press **▼CID** or **▲DIR** to highlight a destination device, then press **SELECT**.

-OR-

- ◆ Use the dialing keys to enter a specific device number (**0** for the telephone base, or **1-9** for handset 1-9, **TONEX** followed by **0-2** for handset 10-12, or **#** for a single headset/speakerphone, **#** followed by **1** or **2** for headset/speakerphone 1 or 2, or **TONEX** followed by **#** for all devices).

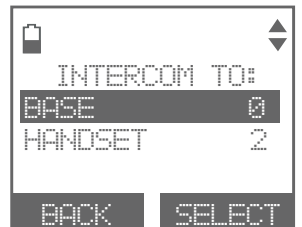

The call is automatically put on hold. Your handset displays **Calling HANDSET X** or **Calling BASE 0**. The destination device(s) rings and shows **HANDSET is calling** or **HANDSET X is calling** (**HANDSET** represents the handset name, **X** represents the handset number).

3. To answer the intercom call on the other device, press **HOME/FLASH**, **SPEAKER**, **CELL 1**, **CELL 2** or any dialing key (**0-9** or **tone X**) on the destination handset or press **HOME** or any dialing key (**0-9** or **tone X**) on the telephone base. Both handsets show **Intercom** and the outside call is still on hold.

Call transfer using intercom

4. From this intercom call, you have the following options:

- You can transfer the call. Press **OPTION** and then press **SELECT** to select **Transfer** on the calling handset. Your screen shows **Call transferred**. The other handset automatically connects to the outside call.
- You can let the other device join you on the outside call in a 3-way conversation. Press **OPTION**, highlight **Share call**, and press **SELECT**.
- You can end the intercom call and continue the outside call with your handset. To continue a home call, press **HOME/FLASH** on your handset. To continue a cell call, press **CELL 1** or **CELL 2** on your handset.
- You can press **OFF/CANCEL** or **END** to hang up the intercom call (the outside call will automatically go off hold and reconnect with your handset).

NOTES:

- If you want to cancel an intercom call and reconnect to the outside call before the destination handset answers, press **OFF/CANCEL** on the originating handset.
- If the called device does not answer the intercom call within 100 seconds, or if the device is in use, on a call or out of range, the calling handset shows **No answer. Try again.** and returns to the outside call.

Using the telephone base:

1. When on an outside call, press **OPTION**.

2. Press **SELECT** to choose **Intercom**. The call is automatically put on hold.

- If you have one handset, the outside call is put on hold and your telephone base displays **Calling HANDSET**. The destination handset rings and displays **BASE is calling**.
- If you have more than one handset, your telephone base displays **INTERCOM TO:** and a list of registered handsets.
 - ◆ Press **▼CID** or **▲DIR** to select a destination handset and then press **SELECT**. Your telephone base displays **Calling HANDSET X**. The destination handset rings and displays **BASE 0 is calling**.

-OR-

- ◆ Press **1-9** for **HANDSET 1-9**, **TONE X** and **0** for **HANDSET 10**, **TONE X** and **1** for **HANDSET 11** or **TONE X** and **2** for **HANDSET 12**.

The destination handset rings and displays **BASE 0 is calling**.

Call transfer using intercom

3. To answer the intercom call on any destination handset, press **HOME/FLASH**, **SPEAKER**, **CELL 1**, **CELL 2** or any dialing key (**0-9** or **TONE X**). Both the handset and telephone base show **Intercom** and the outside call is still on hold.
4. From this intercom call, you have the following options:
 - You can transfer the call. Press **OPTION** and then press **SELECT** to select **Transfer** on the telephone base. Your screen shows **Call transferred**. The other handset automatically connects to the outside call.
 - You can let the handset join you on the outside call in a 3-way conversation. Press **OPTION**, highlight **Share call**, and press **SELECT**.
 - You can end the intercom call and continue the outside call with your telephone base. To continue a home call, press **HOME** on your telephone base. To continue a cell call, press **CELL 1** or **CELL 2** on your telephone base.
 - You can press **CANCEL** or **END** to hang up the intercom call (the outside call will automatically go off hold and reconnect with your telephone base).

NOTES:

- If you want to cancel an intercom call and reconnect to the outside call before the destination handset answers, press **CANCEL** or **END** on the telephone base.
- If the other handset does not answer the intercom call within 100 seconds, or if the other handset is in use, on a call or out of range, the initiating device shows **No answer. Try again.** and returns to the outside call.

Push-to-talk (PTT)

You can directly broadcast messages to the speakerphone of any device. Press and hold **PUSH TO TALK** on a handset or **PTT/FLASH** on the telephone base to begin two-way communication.

- Only one device can talk at a time. While talking to another device, press and hold **PUSH TO TALK** on the handset or **PTT/FLASH** on the telephone base.
- You must release **PUSH TO TALK** on the handset or **PTT/FLASH** on the telephone base, so the other person can respond.
- Only one PTT session can be active at a time.
- While PTT is in use between two devices, other devices cannot use the intercom feature but can access the answering system.
- When you attempt to place a PTT call to another device which is accessing the answering system or on an intercom call or outside call, your device screen shows **Not available at this time**.



i **NOTE:** The PTT function is not available when **QUIET** mode is on.

Turn PTT incoming signal on or off

You can turn PTT incoming signal on or off on each handset or the telephone base.

- When PTT incoming signal is on, the handset can begin and receive PTT calls.
- When PTT incoming signal is off, the handset can begin PTT calls but will not receive PTT calls from other handset(s). The idle handset displays **No Incoming PTT**. The idle telephone base displays **No PTT call**.



To turn on or off the PTT incoming signal:

1. Press **PUSH TO TALK** on the handset or press **PTT/FLASH** on the telephone base in idle mode.
2. Press **▼CID** or **▲DIR** to highlight **PTT On/Off**, then press **SELECT**.
3. Press **▼CID** or **▲DIR** to highlight **On** or **Off**, then press **SELECT**.

i **NOTE:** When you attempt to place a PTT call to handsets or telephone base that have the PTT incoming signal turned off, the screen displays **Not available at this time**.

Push-to-talk (PTT)

PTT call to a single device

Using a handset:

1. There are a few ways to begin a PTT call to a single device. When the handset is not in use:
 - If you have one handset, press and hold **PUSH TO TALK** in idle mode.
 - If you have more than one handset, press **PUSH TO TALK** in idle mode:
 - ◆ Use the dialing keys to enter the destination device number (**0** for telephone base, **1-9** for handsets 1-9, **TONE X** and **0** for handset 10, **TONE X** and **1** for handset 11 or **TONE X** and **2** for handset 12).

-OR-

 - ◆ Press **▼CID** or **▲DIR** to scroll to the destination device, then press **SELECT** or **PUSH TO TALK**.

The handset displays **Connecting to HANDSET X...** (**HANDSET** represents the handset name, **X** represents the destination handset number) or **Connecting to BASE 0...** (**BASE** represents the base name) for a few seconds. When the connection is made, both the initiating handset and the destination device display **Press and hold [PTT] to talk** and beep once.
2. Press and hold **PUSH TO TALK**. A chirp indicates your microphone is on. Speak towards the handset. Your voice is broadcast to the destination device. While you are speaking, the handset displays **PTT To HANDSET X** (**X** represents the destination handset number) or **PTT To BASE 0**.
3. Release **PUSH TO TALK** after speaking. Both devices beep once again and the screens show **Press and hold [PTT] to talk**, then you can press and hold **PUSH TO TALK** to continue speaking or the destination handsets can respond (see **Answer a PTT call** on page 81).
4. To end the PTT call, press **OFF/CANCEL** or **END**, or place the handset in the telephone base or charger. The handset shows **Push to talk Ended** for a few seconds.

 **NOTE:** After **PUSH TO TALK** is released, the PTT call remains open for a short time. If no one presses **PUSH TO TALK** within 10 seconds, the PTT call ends automatically.

Push-to-talk (PTT)

Using the telephone base:

1. There are a few ways to begin a PTT call to a single handset. When the telephone base is not in use:
 - If you have one handset, press and hold **PTT/FLASH** in idle mode.
 - If you have more than one handset, press **PTT/FLASH** in idle mode:
 - ◆ Use the dialing keys to enter the destination handset number (**1-9** for handsets 1-9, **TONE ✕** and **0** for handset 10, **TONE ✕** and **1** for handset 11 or **TONE ✕** and **2** for handset 12).

-OR-

 - ◆ Press **▼CID** or **▲DIR** to scroll to the destination device, then press **SELECT** or **PTT/FLASH**.

Your telephone base displays **Connecting to HANDSET X...** (**HANDSET** represents the handset name, **X** represents the destination handset number) for a few seconds. When the connection is made, both the telephone base and the destination handset display **Press and hold [PTT] to talk** and beep once.
2. Press and hold **PTT/FLASH**. A chirp indicates your microphone is on. Speak towards the telephone base. Your voice is broadcast to the destination handset. While you are speaking, the telephone base displays **PTT To HANDSET X** (**X** represents the destination handset number).
3. Release **PTT/FLASH** after speaking. Both devices beep once again and the screens show **Press and hold [PTT] to talk**, then you can press and hold **PTT/FLASH** to continue speaking or the destination handsets can respond (see **Answer a PTT call** on page 81).
4. To end the PTT call, press **CANCEL** or **END**. The telephone base shows **Push to talk Ended** for a few seconds.

 **NOTE:** After **PTT/FLASH** is released, the PTT call remains open for a short time. If no one presses **PTT/FLASH** within 10 seconds, the PTT call ends automatically.

Push-to-talk (PTT)

PTT call to multiple devices

When there are multiple handsets registered to the phone system, PTT supports one-to-group calls. PTT supports a maximum of one-to-four calls when two to five handsets are registered, and a maximum of one-to-three calls when six or more handsets are registered. The first four registered handsets will be eligible to use this feature. Other handsets can only use PTT for one-to-one calls.

To call multiple devices:

Using a handset:

1. You have two ways to call multiple devices. When the handset is not in use:
 - Press and hold **PUSH TO TALK** until the handset shows **Connecting to group....**
 - OR-
 - Press **PUSH TO TALK** in idle mode. Press **▼CID** or **▲DIR** to highlight **Group**, then press **SELECT** or **PUSH TO TALK**. Your handset shows **Connecting to group....**

When the connection is made, the initiating handset and all destination devices display **Press and hold [PTT] to talk** and beep once.
2. Press and hold **PUSH TO TALK** on your handset. A chirp indicates your microphone is on. Speak towards the handset. Your voice is broadcast to all devices.
3. Release **PUSH TO TALK** after speaking. All devices beep once again and the screens show **Press and hold [PTT] to talk**, then you can press and hold **PUSH TO TALK** to continue speaking or the destination devices can respond (see **Answer a PTT call** on page 81).
4. To end the PTT call, press **OFF/CANCEL** or **END**, or place the handset in the telephone base or charger. The handset shows **Push to talk Ended** for a few seconds.

 **NOTE:** After **PUSH TO TALK** is released, the PTT call remains open for a short time. If no one presses **PUSH TO TALK** within 10 seconds, the PTT call ends automatically.

Push-to-talk (PTT)

Using the telephone base:

1. You have two ways to call multiple handsets. When the telephone base is not in use:
 - Press and hold **PTT/FLASH** until the telephone base shows **Connecting to group....**
 - OR-
 - Press **PTT/FLASH** in idle mode. Press **▼CID** or **▲DIR** to highlight **Group**, then press **SELECT** or **PTT/FLASH**.

Your telephone base displays **Connecting to group...** for a few seconds. When the connection is made, the telephone base and all destination handsets display **Press and hold [PTT] to talk** and beep once.
2. Press and hold **PTT/FLASH** on the telephone base. A chirp indicates your microphone is on. Speak towards the telephone base. Your voice is broadcast to all devices.
3. Release **PTT/FLASH** after speaking. All devices beep once again. After the telephone base beeps, you can press and hold **PTT/FLASH** to continue speaking or the destination handsets can respond (see **Answer a PTT call** on page 81).
4. Press **CANCEL** or **END** to end the PTT call. All devices display **Push to talk Ended** for a few seconds.

 **NOTE:** After **PTT/FLASH** is released, the PTT call remains open for a short time. If no one presses **PTT/FLASH** within 10 seconds, the PTT call ends automatically.

Multiple handset use Push-to-talk (PTT)

Answer a PTT call

You can respond to a PTT call, as described below.

1. When your device receives a PTT call, it beeps and shows **Press and hold [PTT] to talk**.
2. When the other party is speaking, your speakerphone light is on, and your device shows:
 - **PTT From HANDSET X To devices: X** (the first **X** represents the initiating handset number, and the second **X** represents your handset number; a maximum of four handset numbers appear).

-OR-

 - **PTT From Base 0 To devices: X** (the **X** represents your handset number; a maximum of four handset numbers appear).
3. When your speakerphone light is off (the screen shows **Press and hold [PTT] to talk**), press and hold **PUSH TO TALK** on your handset or **PTT/FLASH** on your telephone base. You will hear a chirp. Speak towards the device.
 - While you are speaking, your device shows **PTT To BASE 0** or **PTT to HANDSET X** (**X** represents the destination handset number) or **PTT To devices: X** (**X** represents the handset numbers of one or more destination handsets; a maximum of four handset numbers appear).
 - Your voice is broadcast to all destination devices.

After speaking, release **PUSH TO TALK** on your handset or **PTT/FLASH** on your telephone base. Your device will beep. After the beep, if your speakerphone light is off, you can press and hold **PUSH TO TALK** on your handset or **PTT/FLASH** on your telephone base to continue speaking, or the destination device can respond.

Push-to-talk (PTT)

Change a one-to-one PTT call to an intercom call

You can convert a one-to-one PTT conversation to an intercom call.

1. When your device displays **Press and hold [PTT] to talk**, press **INTCOM**. The screen displays **Switch to Intercom?**
2. Press **SELECT** to confirm. Your device displays **Calling BASE 0** or **Calling HANDSET X**. The destination device briefly shows **Push to talk Ended** and then **HANDSET X is calling** or **BASE 0 is calling**. The destination device rings.
3. Press **HOME/FLASH** or any dialing key (**0-9** or **TONE X**) on the destination handset, or press **HOME** or any dialing keys (**0-9** or **TONE X**) on the telephone base to answer the intercom call. Both devices now show **Intercom**.
4. To end the intercom call, press **OFF/CANCEL** or **END** on your handset or place the handset in the telephone base or charger, or press **END** on the telephone base. Both screens show **Intercom ended**.

Answer an incoming call during PTT

When you receive an incoming outside call during PTT, there is an alert tone. The caller ID is displayed with PTT screen, alternately.

During a one-to-one PTT call:

- To answer an incoming home call, press **HOME/FLASH** on the initiating or destination handset, or press **HOME** on the telephone base.
- To answer an incoming cell call, press **CELL 1** or **CELL 2** on the initiating or destination handset or the telephone base.

The PTT call ends automatically and the outside call is answered.

During a one-to-group PTT call:

- To answer an incoming home call, press **HOME/FLASH** on the initiating handset, or press **HOME** on the telephone base.
- To answer an incoming cell call, press **CELL 1** or **CELL 2** on the initiating handset or the telephone base.

The PTT call ends automatically and the outside call is answered.

Push-to-talk (PTT)

During a one-to-group PTT call:

- To answer an incoming home call, press **HOME/FLASH** on any one of the destination handsets, or press **HOME** on the telephone base.
- To answer an incoming cell call, press **CELL 1** or **CELL 2** on any one of the destination handsets or the telephone base.

That handset or telephone base answers the outside call. The PTT call continues for the rest of the PTT participants.

To leave the PTT call without answering the incoming call:

- Press **OFF/CANCEL** on the handset, or press **CANCEL** on the telephone base. The telephone continues to ring.

Make an outgoing call during PTT

- During a one-to-one PTT call, press **HOME/FLASH** on your handset or press **HOME** on the telephone base to get a dial tone. The PTT call ends automatically.
- During a one-to-group PTT call, press **HOME/FLASH** on the initiating handset, or press **HOME** on the telephone base. The PTT call ends automatically and you get a dial tone.
- During a one-to-group PTT call, press **HOME/FLASH** on any one of the destination handsets, or press **HOME** on the destination telephone base. That handset or telephone base gets a dial tone. The PTT call continues for the rest of the PTT participants.

End or leave a PTT call

For a one-to-one PTT call, both the initiating and destination devices can end the PTT call. For one-to-group PTT calls, the initiating devices can end the PTT call for the group of devices on that PTT call. If any one of the destination devices leaves the PTT call, the call continues until all participants or the initiator hangs up.

- Press **OFF/CANCEL** or **END** on the handset, or press **CANCEL** or **END** on the telephone base. The screen shows **Push to talk Ended**.

-OR-

- Place the handset in the telephone base or charger, then the handset return to idle mode.

i NOTE: After **PUSH TO TALK** on the handset or **PTT/FLASH** on the telephone base is released, the PTT call remains open for a short time. If no one presses **PUSH TO TALK** on the handset or **PTT/FLASH** on the telephone base within 10 seconds, the PTT call ends automatically.

About the directory

The home directory stores up to 200 entries with up to 30 digits for each phone number and 15 characters for each name. Each of the downloaded directories stores up to 1,500 entries with up to 30 digits for each phone number and 15 characters for each name.

- Directory entries are stored at the telephone base and shared by all system handsets. Any changes made on one handset apply to all.
- Only one handset can review the directory at a time. If another handset tries to enter the directory, its screen shows **Not available at this time**.
- When there are no records in the directory, the screen shows **Directory empty**.
- When the directory is full and you try to save an entry, the screen shows **Directory full**.
- When you try to save a number already stored in the directory, the screen shows **Number already saved**.

You cannot create new entries in your downloaded directories from the **TL96276/TL96456** handset. Entries must be downloaded from your cell phone (see **Download directory** on pages 28-29).

Create and review entries

Create a new entry in the home directory

Using a handset:

1. Press **MENU** in idle mode.
 2. Press **▼CID** or **▲DIR** to highlight **Directory**, then press **SELECT**.
 3. When **Home** is highlighted, press **OPTION**.
 4. Press **SELECT** to choose **Add contact**.
 5. The screen displays **ENTER NUMBER**. Use the dialing keys to enter a telephone number (up to 30 digits).
 - Press **▼CID** or **▲DIR** to move the cursor to the left or right.
 - Press **BACKSP** or **MUTE/DELETE** to erase a digit.
 - Press and hold **MUTE/DELETE** to erase all digits.
 - Press and hold **REDIAL/PAUSE** to insert a three-second dialing pause (a **p** appears).
- OR-**
- When the screen displays **ENTER NUMBER**, press **REDIAL/PAUSE** to copy a number from the redial list. Press **▼CID** or **▲DIR**, or press **REDIAL/PAUSE** repeatedly to locate the desired number. Press **INSERT** to copy the displayed number.
6. Press **NEXT**.
 7. The screen displays **SELECT LABEL**. Press **▼CID** or **▲DIR** to highlight one of the following label:
 - Home
 - Cell
 - Work
 - Other
 8. Press **NEXT** to move on to the name.
 9. The screen displays **ENTER NAME**. Use the dialing keys to enter a name (up to 15 characters). Press a key repeatedly until the desired character shows on the screen (see **Character chart** on page 87).
 - Press **▼CID** or **▲DIR** to move the cursor to the left or right.
 - Press **0** to add a space.
 - Press **BACKSP** or **MUTE/DELETE** to erase a character.
 - Press and hold **MUTE/DELETE** to erase all characters.
 - Press **a>A** to change the next letter to upper or lower case.
 10. Press **SAVE** to store your new directory entry. There is a confirmation tone and the screen shows **Saved**. To change the entry later, see pages 91-93.

Create and review entries

Using the telephone base:

1. Press **MENU** in idle mode.
2. Press **▼CID** or **▲DIR** to highlight **Directory**, then press **SELECT**.
3. When **Home** is highlighted, press **OPTION**.
4. Press **SELECT** to choose **Add contact**.
5. The screen displays **ENTER NUMBER**. Use the dialing keys to enter a telephone number (up to 30 digits).
 - Press **▼CID** or **▲DIR** to move the cursor to the left or right.
 - Press **BACKSP** or **X/DELETE** to erase a digit.
 - Press and hold **X/DELETE** to erase all digits.
 - Press and hold **REDIAL/PAUSE** to insert a dialing pause (a **p** appears).
- OR-
- When the screen displays **ENTER NUMBER**, press **REDIAL/PAUSE** to copy a number from the redial list. Press **▼CID** or **▲DIR**, or press **REDIAL/PAUSE** repeatedly to locate the desired number. Press **INSERT** to copy the displayed number.
6. Press **NEXT**.
7. The screen displays **SELECT LABEL**. Press **▼CID** or **▲DIR** to highlight one of the following label:
 - Home
 - Cell
 - Work
 - Other
8. Press **NEXT** to move on to the name.
9. The screen displays **ENTER NAME**. Use the dialing keys to enter a name (up to 15 characters). Press a key repeatedly until the desired character shows on the screen (see **Character chart** on page 87).
 - Press **▼CID** or **▲DIR** to move the cursor to the left or right.
 - Press **BACKSP** or **X/DELETE** to erase a character.
 - Press and hold **X/DELETE** to erase all characters.
 - Press **0** to add a space.
 - Press **a>A** to change the next letter to upper or lower case.
10. Press **SAVE** to store your new directory entry. There is a confirmation tone and the screen shows **Saved**. To change the entry later, see pages 91-93.

Create and review entries

Character chart:

Dialing keys	Characters by number of key presses										
	1	2	3	4	5	6	7	8	9	10	11
1	1	.	-	'	()	*	#	&	/	,
2	A	B	C	a	b	c	2				
3	D	E	F	d	e	f	3				
4	G	H	I	g	h	i	4				
5	J	K	L	j	k	l	5				
6	M	N	O	m	n	o	6				
7	P	Q	R	S	p	q	r	s	7		
8	T	U	V	t	u	v	8				
9	W	X	Y	Z	w	x	y	z	9		
0	Space	0									
*											
#											

 **NOTES:**

- When entering a name in the directory, the first letter of each word is automatically capitalized.
- You cannot create new entries in your downloaded directories from your **TL96276/TL96456** handsets. Entries must be downloaded from your cell phone (see **Download directory** on pages 28-29).

Create and review entries

Add a predialed telephone number to the directory

You can save a predialed telephone number to the directory.

1. Enter the telephone number in idle mode (up to 30 digits).
2. Press **SAVE** to move on to edit the number and then press **NEXT**.
3. The screen displays **SELECT LABEL**. Press **▼CID** or **▲DIR** to select one of the following label:
 - Home
 - Cell
 - Work
 - Other
4. Press **NEXT** to move on to the name.
5. The screen displays **ENTER NAME**. Use the dialing keys to enter the name (up to 15 characters).
 - Press **▼CID** or **▲DIR** to move the cursor to the left or right.
 - Press **0** to add a space.
 - Press **BACKSP**, **MUTE/DELETE** on the handset, or **X/DELETE** on the telephone base to erase a character.
 - Press and hold **MUTE/DELETE** on the handset or **X/DELETE** on the telephone base to erase all digits.
 - Press **a>A** to change the next letter to upper or lower case.
6. Press **SAVE** and the screen shows **Saved**. You hear a confirmation tone.

Create and review entries

Review the directory

Entries are sorted alphabetically.

1. Press **▲DIR** in idle mode.
2. Press **▼CID** or **▲DIR** to highlight a directory, then press **REVIEW**.
3. Press **▼CID** or **▲DIR** to browse.

-OR-

1. Press **MENU** in idle mode.
2. Press **▼CID** or **▲DIR** to highlight **Directory**, then press **SELECT**.
3. Press **▼CID** or **▲DIR** to highlight a directory, then press **REVIEW**.
4. Press **▼CID** or **▲DIR** to browse.

-OR-

1. Press **OPTION** while on call.
2. Press **▼CID** or **▲DIR** to highlight **Directory**, then press **SELECT**.
3. Press **▼CID** or **▲DIR** to highlight a directory, then press **REVIEW**.
4. Press **▼CID** or **▲DIR** to browse.

NOTES:

- When the desired entry displays, press **#** repeatedly to show different dialing options.
- Only one handset or the telephone base can review the directory at time. If another handset tries to enter the directory, caller ID log or call block list, it shows **Not available at this time**.

Create and review entries

Search by name





You can use the enhanced 3-character search to find your contacts quickly and efficiently.

1. Follow the steps in **Review the directory** on the previous page to enter the directory.
2. When an entry appears, use the dialing keys to enter the letters associated with the name (see page 87). You can enter up to three letters for the search. The letters will show at the top left hand corner of the screen. After you have entered one to three letters, the system starts searching in the directory. If there is no name matching the letter(s) entered, the next closest match in alphabetical order appears. If necessary, press ▼**CID** or ▲**DIR** to browse.

 **NOTE:** The cursor automatically moves to the next position two seconds after you enter a letter. If you do not enter another letter in the coming two seconds, the system starts searching in the directory.

Dial a directory entry

You can dial a directory entry on either a home or cell line.

1. Search for the desired entry in the directory (see **Review the directory** on page 89 and **Search by name** on this page).
2. When the desired entry appears, press # (pound key) repeatedly to show different dialing options, if necessary.
3. When the displayed number is in the correct format, press **HOME/FLASH** or **/SPEAKER** on the handset or **HOME** on the telephone base to dial with the home line. Press **CELL 1** or **CELL 2** on the handset or telephone base to dial with the cell line.

Edit or delete entries

Edit a directory entry

You can edit any directory entry. However, be aware that if you download a directory from a cell phone again, the directory is erased and replaced with the current cell phone directory. If you have edited the downloaded entries on the **TL96276/TL96456**, those changes are lost. To avoid losing changes made to the downloaded directory, we suggest that you edit numbers in your cell phone, then download the directory.

Using a handset:

1. Search for the desired entry in the directory (see **Review the directory** on page 89 and **Search by name** on page 90).
2. When a desired directory entry displays, press **EDIT**.
3. The screen displays **EDIT NUMBER**. Use the dialing keys to edit the number.
 - Press **▼CID** or **▲DIR** to move the cursor to the left or right.
 - Press **BACKSP** or **MUTE/DELETE** to erase a digit.
 - Press and hold **MUTE/DELETE** to erase all digits.
 - Press and hold **REDIAL/PAUSE** to insert a three-second dialing pause (a **p** appears).
4. Press **NEXT**.
5. The screen displays **SELECT LABEL**. Press **▼CID** or **▲DIR** to highlight one of the following label:
 - Home
 - Cell
 - Work
 - Other
6. Press **NEXT** to move on to the name.
7. The screen displays **EDIT NAME**. Use the dialing keys to edit the name.
 - Press **▼CID** or **▲DIR** to move the cursor to the left or right.
 - Press **0** to add a space.
 - Press **BACKSP** or **MUTE/DELETE** to erase a character.
 - Press and hold **MUTE/DELETE** to erase all characters.
 - Press **a>A** to change the next letter to upper or lower case.
8. Press **SAVE** to confirm. There is a confirmation tone and the screen shows **Saved**.

Directory

Directory

Using the telephone base:

1. Search for the desired entry in the directory (see **Review the directory** on page 89 and **Search by name** on page 90).
2. When the desired directory entry displays, press **EDIT**.
3. The screen displays **EDIT NUMBER**. Use the dialing keys to edit the number.
 - Press **▼CID** or **▲DIR** to move the cursor to the left or right.
 - Press **BACKSP** or **X/DELETE** to erase a digit.
 - Press and hold **X/DELETE** to erase all digits.
 - Press and hold **REDIAL/PAUSE** to insert a three-second dialing pause (a **p** appears).
4. Press **NEXT**.
5. The screen displays **SELECT LABEL**. Press **▼CID** or **▲DIR** to highlight one of the following label:
 - Home
 - Cell
 - Work
 - Other
6. Press **NEXT** to move on to the name.
7. The screen displays **EDIT NAME**. Use the dialing keys to edit the name.
 - Press **▼CID** or **▲DIR** to move the cursor to the left or right.
 - Press **0** to add a space.
 - Press **BACKSP** or **X/DELETE** to erase a character.
 - Press and hold **X/DELETE** to erase all characters.
 - Press **a>A** to change the next letter to upper or lower case.
8. Press **SAVE** to confirm. There is a confirmation tone and the screen shows **Saved**.

Edit the label of a directory entry

If you only want to edit the label of a directory entry:

1. Search for the desired entry in the directory (see **Review the directory** on page 89 and **Search by name** on page 90).
2. When the desired entry appears, press **LABEL**.
3. Enter the corresponding shortcut keys shown on the screen.

-OR-

Press **CLEAR** to erase the assigned label.



Delete a directory entry

1. Search for the desired entry in the directory (see **Review the directory** on page 89 and **Search by name** on page 90).
2. When the desired entry displays, press **MUTE/DELETE** on the handset or **X/DELETE** on the telephone base. The screen displays **Delete contact?** and the name of the entry. Press **YES** to confirm.
3. The screen displays **Contact deleted** and then the next alphabetical entry in the directory. You hear a confirmation tone.

i **NOTE:** Once a directory entry is deleted, it cannot be retrieved.

Remove a downloaded directory

1. Search for the desired downloaded directory in the directory menu (see **Review the directory** on page 89).
2. When the desired downloaded directory is highlighted, press **OPTION**.
3. Press **▼CID** or **▲DIR** to highlight **Remove dir**, then press **SELECT**.
4. The screen displays **Directory Cell Phone X will be erased..** Press **YES** to confirm (**Cell Phone X** represents the device name of your cell phone).
5. The screen displays **Erasing directory....** You hear a confirmation tone.

About caller ID

This product supports caller ID services provided by most telephone service providers. Caller ID allows you to see the name, number, date and time of calls. The available caller ID information will appear after the first or second ring. Caller ID from the home line allows you to see the name, number, date and time of the incoming calls. The caller ID may appear differently if the caller is matched to a directory entry (see **Memory match** on page 95).

Information about caller ID with call waiting

Caller ID with call waiting lets you see the name and telephone number of the caller before answering the telephone, even while on another call.

It may be necessary to change your telephone service to use this feature. Contact your telephone service provider if:

- You have both caller ID and call waiting, but as separate services (you may need to combine these services).
- You have only caller ID service, or only call waiting service.
- You don't subscribe to caller ID or call waiting services.

There are fees for caller ID services. In addition, services may not be available in all areas.

This product can provide information only if both you and the caller are in areas offering caller ID service and if both telephone service providers use compatible equipment. The time and date, along with the call information, are from the telephone service provider.

Caller ID information may not be available for every incoming call. Callers may intentionally block their names and/or telephone numbers. You can only view a maximum of 15 digits of every caller ID log entry.

 **NOTE:** You can use this product with regular caller ID service, or you can use this product's other features without subscribing to caller ID or combined caller ID with call waiting service.

Caller ID operation

How the caller ID log works

The telephone stores caller ID information about the last 50 incoming calls in the telephone base. Entries are stored in reverse chronological order. The phone deletes the oldest entry when the log is full to make room for new calls. This information is common to the telephone base and all handsets, so changes made using any handset or the telephone base are reflected in all other devices. If you answer a call before the information appears on the screen, it does not show in the caller ID log.

 **NOTE:** Each entry may have up to 24 digits for the phone number and 15 characters for the name.

Missed (new) call indicator

When a cordless handset or the telephone base is in idle mode and has new or missed calls, its screen shows **XX Missed calls**.

All new and missed entries are counted as missed calls. Each time you review a new caller ID log entry (indicated by **NEW** on the screen), the missed calls message goes away. When there is a new unanswered call, the missed calls message displays again. The number of missed calls includes all new and missed entries that have not been reviewed.

If you do not want to review the missed calls one by one, but still want to keep them in the caller ID log, you can press and hold  **OFF/CANCEL** on the handset or **CANCEL** on the telephone base for four seconds when the handset or telephone base is idle. You will hear a confirmation tone. All the entries in the caller ID log become old (reviewed already), and the missed calls message goes away.

Memory match

If the incoming telephone number matches the last 7 digits of a telephone number in your directory, the name that appears on the screen matches the corresponding name in your directory.

For example, if **Christine Smith** calls, her name appears as **Chris** if this is how you entered it into your directory.

 **NOTE:** The number you see on your caller ID is in the format sent by the telephone service provider. It usually delivers 10-digit telephone numbers (area code plus telephone number). If the last 7 digits of the incoming telephone number do not match a number in your directory, the name appears as it is delivered by the telephone service provider.

Caller ID operation

Review the caller ID log

Review the caller ID log to find out who called, to easily return a call, or to copy the caller's name and number into your directory. **Caller ID log empty** appears if there are no records in the caller ID log.

To review the caller ID log:

1. When a handset or the telephone base is in idle mode, press **▼CID** to review the caller ID log in reverse chronological order starting with the most recent call.

-OR-

Review the caller ID log by pressing **MENU**.

Press **▼CID** or **▲DIR** to scroll to **Caller ID log**, then press **SELECT** twice to select **Review**.

2. Press **▼CID** or **▲DIR** to scroll through the list.

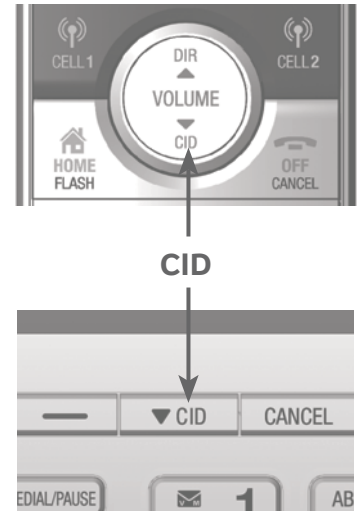

i NOTE: Only one handset or the telephone base can review the caller ID log at time. If another handset tries to enter the directory, caller ID log or call block list, it shows **Not available at this time**.

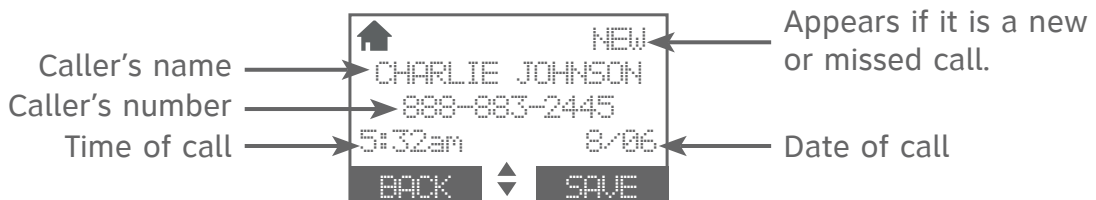
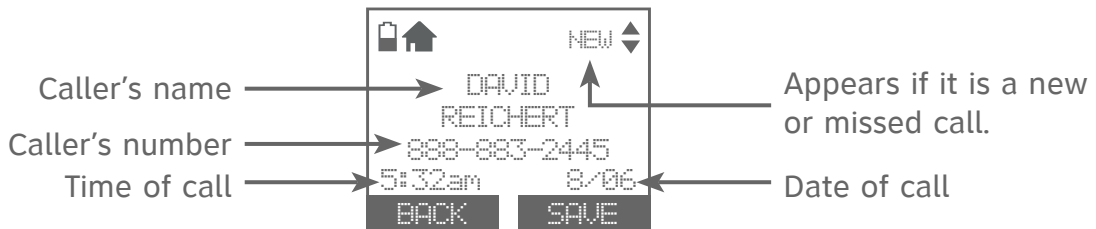

Caller ID operation

View dialing options

Although the caller ID log entries may contain 10 digits (the area code plus the 7-digit number), in some areas, you may need to dial only the seven digits, or 1 plus the seven digits, or 1 plus the area code plus the seven digits. You can change the number of digits that you dial from the caller ID log or store to the directory.

While reviewing the caller ID log, press **#** (pound key) repeatedly to show different dialing options for local and long distance numbers before dialing or saving the telephone number in the directory.

Press **1** repeatedly if you need to add or remove 1 in front of the telephone number before dialing or saving it in the directory.

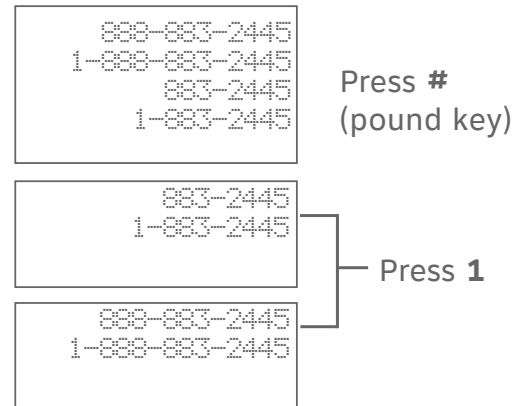

When the number shows the correct format for dialing:

- Press **HOME/FLASH** or **SPEAKER** on the handset or **HOME** on the telephone base to call the number using the home line.

-OR-

- Press **CELL 1** or **CELL 2** on the handset or on the telephone base to call the number using the cell line.

Dial a caller ID log entry

1. Search for the desired entry in the caller ID log (see **Review the caller ID log** on page 96).
2. When the desired entry is displayed and is in the correct format for dialing, press **HOME/FLASH** or **SPEAKER** on the handset or **HOME** on the telephone base to dial with the home line.

-OR-

Press **CELL 1** or **CELL 2** on the handset or on the telephone base to dial with the cell line.

Caller ID operation

Save a caller ID log entry to the directory

Caller ID log entries can only be saved to the **Home** directory.

Using a handset:

1. Search for the desired entry in the caller ID log (see **Review the caller ID log** on page 96).
2. When the desired entry appears, press **#** (pound key) repeatedly to show different dialing options, if necessary.
3. When the number is in the correct format, press **SAVE**.
4. Press **SELECT** to select **Directory**.
5. The screen displays **EDIT NUMBER**. Use the dialing keys to edit the number, if necessary.
 - Press **▼CID** or **▲DIR** to move the cursor to the left or right.
 - Press **BACKSP** or **MUTE/DELETE** to erase a digit.
 - Press and hold **MUTE/DELETE** to erase all digits.
 - Press and hold **REDIAL/PAUSE** to insert a three-second dialing pause (a **p** appears).
6. Press **NEXT**.
7. The screen displays **SELECT LABEL**. Press **▼CID** or **▲DIR** to highlight one of the following label:
 - Home
 - Cell
 - Work
 - Other
8. Press **NEXT** to move to the name.
9. The screen displays **EDIT NAME**. Use the dialing keys to edit the name.
 - Press **▼CID** or **▲DIR** to move the cursor to the left or right.
 - Press **BACKSP** or **MUTE/DELETE** to erase a character.
 - Press and hold **MUTE/DELETE** to erase all characters.
 - Press **0** to add a space.
 - Press **#** (pound key) to move the last word to the front. For example, **Johnson Charlie** becomes **Charlie Johnson** when you press **#** (pound key).
10. Press **SAVE** to confirm. The screen shows **Saved**. You hear a confirmation tone.

Caller ID operation

Using the telephone base:

1. Search for the desired entry in the caller ID log (see **Review the caller ID log** on page 96).
2. When the desired entry appears, press **#** (pound key) repeatedly to show different dialing options, if necessary.
3. When the number is in the correct format, press **SAVE**.
4. Press **SELECT** to select **Directory**.
5. The screen shows **EDIT NUMBER**. Use the dialing keys to edit the number, if necessary.
 - Press **▼CID** or **▲DIR** to move the cursor to the left or right.
 - Press **BACKSP** or **X/DELETE** to erase a digit.
 - Press and hold **X/DELETE** to erase all digits.
 - Press and hold **REDIAL/PAUSE** to insert a three-second dialing pause (a **p** appears).
6. Press **NEXT**.
7. The screen displays **SELECT LABEL**. Press **▼CID** or **▲DIR** to highlight one of the following label:
 - Home
 - Cell
 - Work
 - Other
8. Press **NEXT** to move to the name.
9. The screen shows **EDIT NAME**. Use the dialing keys to edit the name.
 - Press **▼CID** or **▲DIR** to move the cursor to the left or right.
 - Press **BACKSP** or **X/DELETE** to erase a character.
 - Press and hold **X/DELETE** to erase all characters.
 - Press **0** to add a space.
 - Press **#** (pound key) to move the last word to the front. For example, **Johnson Charlie** becomes **Charlie Johnson** when you press **#** (pound key).
10. Press **SAVE** to confirm. The screen shows **Saved**. You hear a confirmation tone.

Caller ID operation

NOTES:

- If the name received from the telephone service provider is in all capital letters, the first letter of every word remains a capital letter. However, the next letter after the prefix “Mac”, “Mc”, or “O”, is kept as a capital letter. For example, the “D” in “MacDonald” is kept as a capital letter.
- When you try to save a caller ID entry without any caller ID information, the telephone base or handset displays **Unable to save**.
- If the telephone number from the caller ID information has already been saved in the directory under a different name, the new name will overwrite the old one.

Delete caller ID log entries

To delete an entry:

1. Search for the desired entry in the caller ID log (see **Review the caller ID log** on page 96).
2. When the desired entry is displayed, press **MUTE/DELETE** on the handset or **X/DELETE** on the telephone base. The screen shows the previous caller ID log entry. You hear a confirmation tone.

To delete all entries:

1. Press **MENU** in idle mode.
2. Press **▼CID** or **▲DIR** to highlight **Caller ID log**, then press **SELECT**.
3. Press **▼CID** or **▲DIR** to highlight **Del all calls**, then press **SELECT**.
4. When the screen shows **Delete all calls?**, press **YES** to confirm. There is a confirmation tone and the screen returns to the previous menu.



Reasons for missing caller ID information

There are occasions when other information or no information shows for various reasons:

On-screen message	Reason
PRIVATE NAME	The caller prefers not to show the name.
PRIVATE NUMBER	The caller prefers not to show the phone number.
PRIVATE CALLER	The caller prefers not to show the phone number and name.
UNKNOWN NAME	Your telephone service provider cannot determine the caller's name.
UNKNOWN NUMBER	Your telephone service provider cannot determine the caller's number.
UNKNOWN CALLER	Your telephone service provider cannot determine the caller's name and telephone number. Calls from other countries may also generate this message.

Call block

Call block

If you have subscribed to caller ID service, you can use the call block feature to reject certain calls automatically. The call block list stores up to 20 entries. The telephone system can reject calls automatically according to:

- Numbers saved into the call block list
- Incoming calls without numbers

 **NOTE:** The blocked calls are displayed as **Blocked call** in the caller ID log.



Add a call block entry

Using the handset:

1. Press **MENU** in idle mode.
2. Press **▼CID** or **▲DIR** to highlight **Call block**, then press **SELECT**.
3. Press **SELECT** again to select **Block list**.
4. Press **▼CID** or **▲DIR** to highlight **Add new entry**, then press **SELECT**.
5. The screen displays **ENTER NUMBER**. Use the dialing keys to enter a telephone number (up to 30 digits).
 - Press **▼CID** or **▲DIR** to move the cursor to the left or right.
 - Press **BACKSP** or **MUTE/DELETE** to erase a digit.
 - Press and hold **MUTE/DELETE** to erase all digits.
 - Press and hold **REDIAL/PAUSE** to insert a three-second dialing pause (a **p** appears).

-OR-

When the screen displays **ENTER NUMBER**, press **REDIAL/PAUSE** to copy a number from the redial list. Press **▼CID** or **▲DIR**, or press **REDIAL/PAUSE** repeatedly to locate the desired number. Press **INSERT** to copy the displayed number.

6. Press **NEXT** to move on to the name.
 - The display shows **Number already saved** if the number is already in the call block list. You cannot save the same number twice.
7. The screen displays **ENTER NAME**. Use the dialing keys to enter a name (up to 15 characters). Press a key repeatedly until the desired character shows on the screen (see **Character chart** on page 87).
 - Press **▼CID** or **▲DIR** to move the cursor to the left or right.
 - Press **0** to add a space.
 - Press **BACKSP** or **MUTE/DELETE** to erase a character.
 - Press and hold **MUTE/DELETE** to erase all characters.
 - Press **a>A** to change the next letter to upper or lower case.
8. Press **SAVE** to store your call block entry.

Call block Call block

Using the telephone base:

1. Press **MENU** in idle mode.
2. Press **▼CID** or **▲DIR** to highlight **Call block**, then press **SELECT**.
3. Press **SELECT** again to select **Block list**.
4. Press **▼CID** or **▲DIR** to highlight **Add new entry**, then press **SELECT**.
5. The screen displays **ENTER NUMBER**. Use the dialing keys to enter a telephone number (up to 30 digits).
 - Press **▼CID** or **▲DIR** to move the cursor to the left or right.
 - Press **BACKSP** or **X/DELETE** to erase a digit.
 - Press and hold **X/DELETE** to erase all digits.
 - Press and hold **REDIAL/PAUSE** to insert a three-second dialing pause (a **p** appears).



-OR-

When the screen displays **ENTER NUMBER**, press **REDIAL/PAUSE** to copy a number from the redial list. Press **▼CID** or **▲DIR**, or press **REDIAL/PAUSE** repeatedly to locate the desired number. Press **INSERT** to copy the displayed number.

6. Press **NEXT** to move on to the name.
 - The display shows **Number already saved** if the number is already in the call block list. You cannot save the same number twice.
7. The screen displays **ENTER NAME**. Use the dialing keys to enter a name (up to 15 characters). Press a key repeatedly until the desired character shows on the screen (see **Character chart** on page 87).
 - Press **▼CID** or **▲DIR** to move the cursor to the left or right.
 - Press **BACKSP** or **X/DELETE** to erase a character.
 - Press and hold **X/DELETE** to erase all characters.
 - Press **0** to add a space.
 - Press **a>A** to change the next letter to upper or lower case.
8. Press **SAVE** to store your call block entry.

Call block

Review the call block list

1. Press **MENU** in idle mode.
2. Press **▼CID** or **▲DIR** to highlight **Call block**, then press **SELECT**.
3. Press **SELECT** to choose **Block list**.
4. Press **SELECT** again to choose **Review**.
5. Press **▼CID** or **▲DIR** to browse through the call block entries.

**i NOTES:**

- **Call block list is empty. Add new entry?** appears if there are no call block entries.
- Only one handset or the telephone base can review the caller ID log at time. If another handset tries to enter the directory, caller ID log or call block list, it shows **Not available at this time**.

Save a caller ID log entry to call block list**Using the handset:**

1. Search for the desired caller ID log entry (see **Review the caller ID log** on page 96).
2. When the desired entry displays, press **SAVE**.
3. Press **▼CID** or **▲DIR** to highlight **Call block**, then press **SELECT**.
4. The screen displays **EDIT NUMBER**. Use the dialing keys to edit the number, when necessary.
 - Press **▼CID** or **▲DIR** to move the cursor to the left or right.
 - Press **BACKSP** or **MUTE/DELETE** to erase a digit.
 - Press and hold **MUTE/DELETE** to erase all digits.
 - Press and hold **REDIAL/PAUSE** to insert a three-second dialing pause (a **p** appears).
5. Press **NEXT** to move to the name.
6. The screen displays **EDIT NAME**. Use the dialing keys to add or edit the name.
 - Press **▼CID** or **▲DIR** to move the cursor to the left or right.
 - Press **0** to add a space.
 - Press **BACKSP** or **MUTE/DELETE** to erase a character.
 - Press and hold **MUTE/DELETE** to erase all characters.
 - Press **#** (pound key) to move the last word to the front. For example, **Johnson Charlie** becomes **Charlie Johnson** when you press **#** (pound key).
7. Press **SAVE** when done and the screen displays **Saved**.

Call block

Using the telephone base:

1. Search for the desired caller ID log entry (see **Review the caller ID log** on page 96).
2. When the desired entry displays, press **SAVE**.
3. Press **▼CID** or **▲DIR** to highlight **Call block**, then press **SELECT**.
4. The screen displays **EDIT NUMBER**. Use the dialing keys to edit the number, when necessary.
 - Press **▼CID** or **▲DIR** to move the cursor to the left or right.
 - Press **BACKSP** or **X/DELETE** to erase a digit.
 - Press and hold **X/DELETE** to erase all digits.
 - Press and hold **REDIAL/PAUSE** to insert a three-second dialing pause (a **p** appears).
5. Press **NEXT** to move to the name.
6. The screen displays **EDIT NAME**. Use the dialing keys to add or edit the name.
 - Press **▼CID** or **▲DIR** to move the cursor to the left or right.
 - Press **0** to add a space.
 - Press **BACKSP** or **X/DELETE** to erase a character.
 - Press and hold **X/DELETE** to erase all characters.
 - Press **#** (pound key) to move the last word to the front. For example, **Johnson Charlie** becomes **Charlie Johnson** when you press **#** (pound key).
7. Press **SAVE** when done and the screen displays **Saved**.

Edit a call block entry

1. Search for the desired entry in the call block list (see **Review the call block list** on page 105).
2. When the desired entry displays, press **EDIT**.
3. The screen displays **EDIT NUMBER** along with the phone number to be edited. Use the dialing keys to edit the number. If you only want to edit the name, skip to Step 4.
 - Press **▼CID** or **▲DIR** to move the cursor to the left or right.
 - Press **BACKSP**, **MUTE/DELETE** on the handset, or **X/DELETE** on the telephone base to erase a digit.
 - Press and hold **MUTE/DELETE** on the handset or **X/DELETE** on the telephone base to erase all digits.
 - Press and hold **REDIAL/PAUSE** to insert a three-second dialing pause (a **p** appears).
4. Press **NEXT** to move to the name.
5. The screen displays **EDIT NAME** along with the name to be edited. Use the dialing keys to edit the name.
 - Press **▼CID** or **▲DIR** to move the cursor to the left or right.
 - Press **0** to add a space.
 - Press **BACKSP**, **MUTE/DELETE** on the handset, or **X/DELETE** on the telephone base to erase a character.
 - Press and hold **MUTE/DELETE** on the handset or **X/DELETE** on the telephone base to erase all digits.
 - Press **a>A** to change the next letter to upper or lower case.
6. Press **SAVE** to save the entry. The screen displays **Saved**.

Call block

Call block

Delete a call block entry

1. Search for the desired entry in the call block list (see **Review call block list** on page 105).
2. When the desired entry displays, press **MUTE/DELETE** on the handset or **X/DELETE** on the telephone base.
3. The screen shows **Delete contact?**. Press **YES** to confirm. The screen displays **Deleted**, and then the next entry displays. You cannot retrieve a deleted entry.

Block calls without number

You can use this feature to reject all incoming calls which are “out of area” or with numbers set to “Private”.

1. Press **MENU** in idle mode.
2. Press **▼CID** or **▲DIR** to highlight **Call block**, then press **SELECT**.
3. Press **▼CID** or **▲DIR** to highlight **Calls w/o num**, then press **SELECT**.
4. Press **▼CID** or **▲DIR** to choose **Block** or **Not block**, then press **SELECT**.

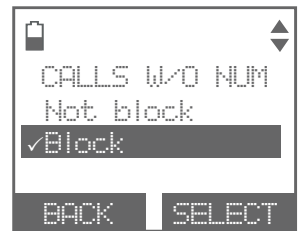

Mute first ring

Your telephone rings once for blocked calls. You can choose to mute the first ring for all incoming calls, so that there will be no ring for blocked calls. By default, the mute first ring feature is set to **Off**.

1. Press **MENU** in idle mode.
2. Press **7464#**.
3. Press **▼CID** or **▲DIR** to choose **On** to mute the first ring, or **Off** to keep the first ring, then press **SELECT**.



i NOTE: If you have muted the first ring, you will hear one ring less before the answering system and voicemail answer the incoming calls.

Answering system settings

Use the answering system menu of a system handset or the telephone base to set up the announcement message, turn on or off the answering system or message alert tone, activate call screening, or change the number of rings, remote access code or message recording time.

If you turn off the answering system and you change any setting in the answering system setup menu, the answering system automatically turns on again.

Announcement

Your outgoing announcement plays when calls are answered by the answering system.

The telephone has a default outgoing announcement, *“Hello, please leave a message after the tone.”* You can use this announcement, or record your own.

You can record an announcement up to 90 seconds. The system does not record any announcement shorter than two seconds.

To play your current outgoing announcement:

1. Press **MENU** in idle mode.
2. Press **▼CID** or **▲DIR** to highlight **Answering sys**, then press **SELECT**.
3. Press **SELECT** again to select **Announcement**.
4. Press **▼CID** or **▲DIR** to highlight **Play annc**, then press **SELECT**.

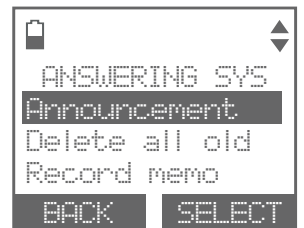

Answering system settings

To record a new outgoing announcement:

1. Press **MENU** in idle mode.
2. Press **▼CID** or **▲DIR** to scroll to **Answering sys**, then press **SELECT**.
3. Press **SELECT** to select **Announcement**.
4. Press **SELECT** again to select **Record annc**. The system announces, *"Record after the tone. Press STOP when you are done."*
5. After the tone, speak towards the microphone of the handset or the telephone base. Press **STOP** to end recording.
6. The newly recorded announcement automatically plays. Press **STOP** to stop the playback at any time, or **RECORD** to record again, if desired.

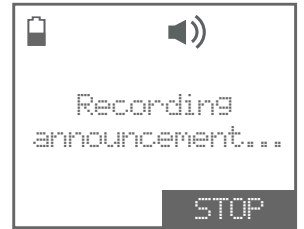

To listen to the recorded announcement again, wait after playback has completed, then scroll to **Play annc** and press **SELECT**.

NOTES:

- Your announcement can be up to 90 seconds in length.
- Announcements shorter than two seconds are not recorded.

To delete or reset your outgoing announcement:

1. Press **MENU** in idle mode.
2. Press **▼CID** or **▲DIR** to scroll to **Answering sys**, then press **SELECT**.
3. Press **SELECT** again to select **Announcement**.
4. Press **▼CID** or **▲DIR** to scroll to **Reset annc** and press **SELECT**. The screen prompts **Reset to default annc?**. Press **YES** to confirm. The system announces, *"Announcement deleted."* and the screen shows **Annc. reset to default** before returning to the previous menu.

-OR-

Press **▼CID** or **▲DIR** to scroll to **Play annc** and play the announcement. While the announcement is playing, press **MUTE/DELETE** on a handset or **X/DELETE** on the telephone base to reset the announcement. The system announces *"Announcement deleted."* and the screen shows **Annc. Deleted** before returning to the previous menu.

When your announcement is reset, the system answers calls with the default announcement, as described on page 109. You cannot delete the default announcement.

Answering system settings

Answer on/off

If you turn the answering system on, it answers calls and records messages only on the home line. If your paired cell phone has voicemail, callers can leave messages with that voicemail service.

If your answering system is turned off and you change any of its settings, the answering system automatically turns on again.

When the answering system is turned on, the **🔌/ANS ON** light on the telephone base is on. Both the handsets and telephone display **ANS ON**.

To turn the answering system on or off:

Using a handset:

1. Press **MENU** in idle mode.
2. Press **▼CID** or **▲DIR** to highlight **Answering sys**, then press **SELECT**.
3. Press **▼CID** or **▲DIR** to highlight **Answer ON/OFF**, then press **SELECT**.
4. Press **▼CID** or **▲DIR** to highlight **On** or **Off**, then press **SELECT** to save. You hear a confirmation tone.

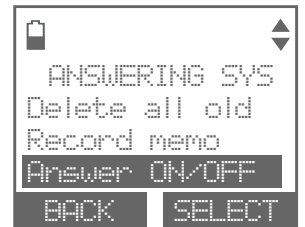

Using the telephone base:

- Press **🔌/ANS ON** to turn the answering system on or off. When the answering system is turned on, it announces, "Calls will be answered." When the answering system is turned off, it announces, "Calls will not be answered."



-OR-

1. Press **MENU** in idle mode.
2. Press **SELECT** to select **Answering sys**.
3. Press **▼CID** or **▲DIR** to highlight **Answer ON/OFF**, then press **SELECT**.
4. Press **▼CID** or **▲DIR** to highlight **On** or **Off**, then press **SELECT** to save. You hear a confirmation tone.

i NOTE: If the answering system is off and there is an incoming call, the system answers after ten rings and announces, "Please enter your remote access code." For more information about remote access, see pages 127-128.

Answering system settings

Voice guide

This feature is an alternative way for you to do the basic setup of the answering system. You can follow the voice guide to record your own announcement, set the number of rings, and set the message alert tone.

To use the voice guide feature:

1. Press **MENU** in idle mode.
2. Press **▼CID** or **▲DIR** to highlight **Answering sys**, then press **SELECT**.
3. Press **▼CID** or **▲DIR** to highlight **Voice guide**, then press **SELECT**. You hear a voice prompt, *"Hello! This voice guide will assist you with the basic setup of your answering system."*
4. Set up your answering system by inputting designated numbers, as instructed in the voice guide.

NOTES:

- You can press **OFF/CANCEL** on the handset or press **CANCEL** on the telephone base to quit the voice guide at any time.
- If the system does not receive any input, it will play an alert message. If there is still no input, it will announce *"Sorry, I still have not received any input. If you want to restart the voice guide, please enter the menu and select Voice guide under Answering system. Good bye."*
- After a power outage, the system prompts you to set the date and time. After the date and time setting is done or skipped, the system prompts if you want to set up the answering system via voice guide. Press **YES** to start the setup.



Answering system settings

Call screening

Use this feature to choose whether incoming messages can be heard over the speaker when they are being recorded. If you turn call screening on, you hear the incoming message. While monitoring an incoming message, you can answer the call by pressing **HOME/FLASH** or **SPEAKER** on the handset, or **HOME** on the telephone base.

To turn on or off the call screening feature:

1. Press **MENU** in idle mode.
2. Press **▼CID** or **▲DIR** to highlight **Answering sys**, then press **SELECT**.
3. Press **▼CID** or **▲DIR** to highlight **Ans sys setup**, then press **SELECT** twice to select **Call screening**.
4. Press **▼CID** or **▲DIR** to choose between **On** and **Off**, then press **SELECT** to save. You hear a confirmation tone.

i NOTE: For more information on call screening, see page 107.

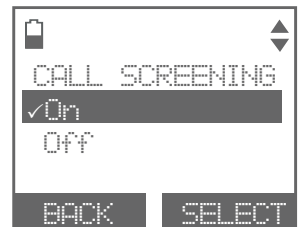
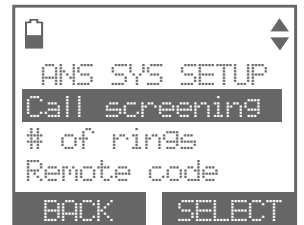

Answering system settings

Number of rings

You can set the answering system to answer an incoming call after two, three, four, five, or six rings. You can also select toll saver, which is explained below. By default, the answering system answers an incoming call after four rings.

To set the number of rings:

1. Press **MENU** in idle mode.
2. Press **▼CID** or **▲DIR** to highlight **Answering sys**, then press **SELECT**.
3. Press **▼CID** or **▲DIR** to highlight **Ans sys setup**, then press **SELECT**.
4. Press **▼CID** or **▲DIR** to highlight **# of rings**, then press **SELECT**.
5. Press **▼CID** or **▲DIR** to choose from **6, 5, 4, 3, 2** or **Toll saver**.
 - Toll saver - the answering system answers a call after two rings when you have new messages, or after four rings when there are no new messages. This feature allows you to check for new messages and avoid paying long distance charges when calling from out of your local area.
6. Press **SELECT** to save. You hear a confirmation tone.

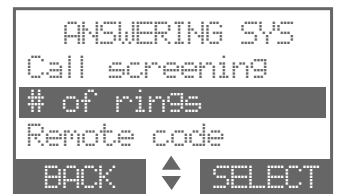
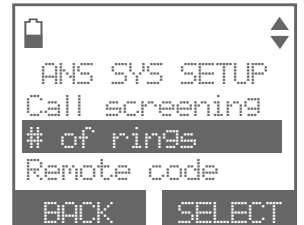

i NOTES:

- If you set the number of rings for the answering system as 2 or 3 rings, the caller ID announce feature may not have enough time to announce the caller's full information.
- If you have muted the first ring, you will hear one ring less before the answering system answers the incoming calls.

Answering system settings

Remote access code

To access your answering system remotely from any touch-tone phone, you need to enter a two-digit number (**00-99**). By default, the remote access code is **19**.

To change the remote access code:

1. Press **MENU** in idle mode.
2. Press **▼CID** or **▲DIR** to highlight **Answering sys**, then press **SELECT**.
3. Press **▼CID** or **▲DIR** to highlight **Ans sys setup**, then press **SELECT**.
4. Press **▼CID** or **▲DIR** to highlight **Remote code**, then press **SELECT**.
5. Use the dialing keys to enter a two-digit number.
Press **MUTE/DELETE** on the handset or **X/DELETE** on the telephone base to erase a digit.
6. Press **SAVE** to confirm. You hear a confirmation tone.

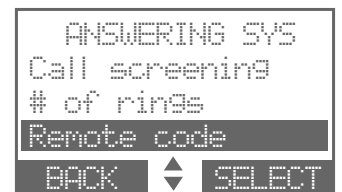
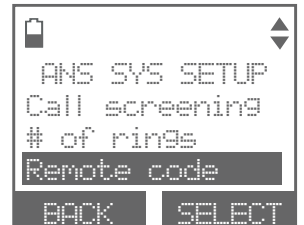

Answering system settings

Message alert tone

When the message alert tone is set to **On**, and there is at least one new message, the telephone base beeps every 10 seconds. The tone stops when all new messages have been reviewed. By default, the message alert tone is **Off**.

To turn on or off the message alert tone:

1. Press **MENU** in idle mode.
2. Press **▼CID** or **▲DIR** to highlight **Answering sys**, then press **SELECT**.
3. Press **▼CID** or **▲DIR** to highlight **Ans sys setup**, then press **SELECT**.
4. Press **▼CID** or **▲DIR** to highlight **Msg alert tone**, then press **SELECT**.
5. Press **▼CID** or **▲DIR** to choose **On** or **Off**, then press **SELECT**. You hear a confirmation tone.

NOTES:

- To temporarily turn off the message alert tone, see page 121.
- The message alert tone beeps only if all the following conditions are met.
 - Answering system is on.
 - Message alert tone setting is on.
 - There are new messages.

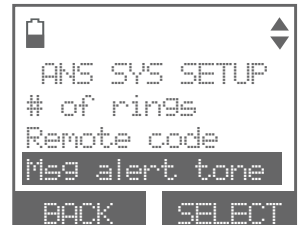

Answering system settings

Message recording time

You can set the recording time limit for each incoming message. The default setting is three minutes.

To set the message recording time:

1. Press **MENU** in idle mode.
2. Press **▼CID** or **▲DIR** to highlight **Answering sys**, then press **SELECT**.
3. Press **▼CID** or **▲DIR** to highlight **Ans sys setup**, then press **SELECT**.
4. Press **▼CID** or **▲DIR** to highlight **Recording time**, then press **SELECT**.
5. Press **▼CID** or **▲DIR** to choose **3 minutes**, **2 minutes**, or **1 minute**, then press **SELECT**. You hear a confirmation tone.

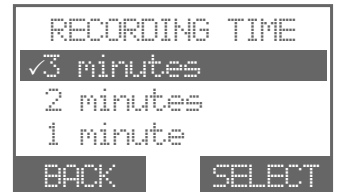
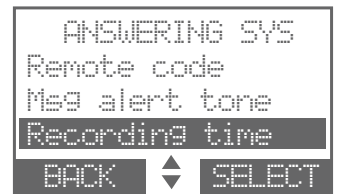
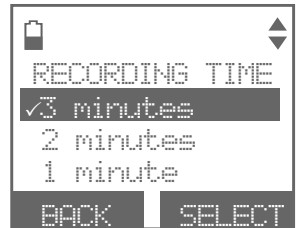
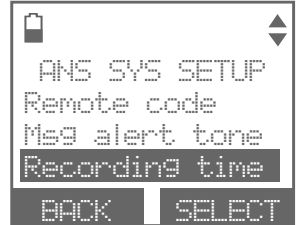

About the answering system

Answering system and voicemail

Your telephone has separate indicators for two different types of voice messages: those recorded on its built-in digital answering system and those recorded in your telephone service provider's voicemail (fees may apply). Your telephone's built-in digital answering system messages and voicemail messages are separate. Each alerts you to new messages differently.

- If **OO** and **XX New messages** display on the telephone base and handsets, there are new messages in the built-in answering system. To listen to messages recorded on your digital answering system, press **▶/■/PLAY/STOP** on the telephone base. To listen to messages with a handset, see **To listen to messages on a cordless handset** on page 122.
- If **✉** and **New voicemail** display on the handset and the telephone base, your telephone service provider is indicating that it has new voicemail for you. To listen to your voicemail, dial an access number provided by your telephone service provider, followed by a security code or PIN.

Some service providers bundle or combine multiple services like voicemail and call waiting, so you may not be aware that you have voicemail. To check what services you have and how to access them, contact your telephone service provider.

To use your voicemail service rather than the answering system, turn off the answering system. To use the answering system rather than your voicemail service, contact your telephone service provider to deactivate the voicemail service.

Use the answering system and voicemail together

You can also use the telephone answering system and voicemail together by setting your built-in answering system to answer before voicemail answers, as described below. To learn how to program your voicemail settings, contact your telephone service provider. Then, if you are on a call, or if the answering system is busy recording a message and you receive another call, the second caller can leave a voicemail message.

Set the answering system to answer calls at least two rings earlier than your voicemail is set to answer. For example, if your voicemail answers after six rings, set the answering system to answer after four rings. Some voicemail providers may program the delay before answering calls in seconds instead of rings. In this case, allow six seconds per ring when determining the appropriate setting.

About the answering system

Message capacity

The answering system can record and store up to 99 messages. Each message can be up to 3 minutes in length depending on the message length set. The total storage capacity for the announcement, messages and memos is approximately 22 minutes. The actual recording time depends on individual message characteristics. Messages remain available for replay until you delete them.

When there are new messages (including memos) on the answering system, the number of messages stored shows in the message counter.

If the answering system has less than three minutes of recording time left, it announces, *"Less than three minutes to record,"* before message playback at the handset or the telephone base. **Rec mem low** displays on the device screen in idle mode. When you turn on the answering system at the telephone base, it announces, *"Calls will be answered. Less than three minutes to record."*

If the memory is full, the answering system announces, *"Memory is full,"* before message playback. The device screen displays **Rec mem full** in idle mode. Once the memory is full, you cannot turn the answering system back on if it has been turned off, nor can you record new messages until old ones have been deleted. **Memory full** displays if you want to turn on the answering system on the handset but there is no memory.

Voice prompts

The system provides voice prompts to guide you through the setup procedures at the telephone base or handset, message playback, remote access and recording outgoing announcements.

About the answering system

Call screening

To screen calls at the telephone base:

If the answering system and call screening are on, the announcement and the incoming message broadcast at the telephone base when a call is answered by the answering system.

Options while a message is being recorded:

- Press **▼/VOLUME/▲** on the telephone base to adjust the call screening volume.
- Press **▶/■/PLAY/STOP** or **SILENCE** to temporarily silence the call screening.
- Press **▶/■/PLAY/STOP** or **SCREEN** to temporarily turn on the call screening if call screening is set to off.
- Press **🏠HOME** to answer the call.

To screen calls at the cordless handset:

If the answering system is on and your answering system is recording a message, press **SCREEN** to screen the call on your handset and the handset displays the caller ID information. If you do not subscribe to caller ID service, the handset shows **Home Incoming call**.

Options while a message is being recorded:

- Press **▼CID/VOLUME** or **▲DIR/VOLUME** on the handset to adjust the call screening volume.
- Press **📞OFF/CANCEL** or **SILENCE** to temporarily silence the call screening.
- Press **SCREEN** to temporarily turn on the call screening if call screening is set to off.
- Press **🔊/SPEAKER** to broadcast the announcement and the incoming message through the speakerphone. Press again to turn off the speakerphone.

About the answering system

Call intercept

When a caller is leaving a message on your answering system, you can stop recording and talk to the caller by pressing **🏠HOME/FLASH** or **🔊/SPEAKER** on the handset, or pressing **🏠HOME** on the telephone base.

Temporarily turn off the message alert tone

If the message alert tone is turned on, the telephone base beeps every ten seconds when there are new messages. Pressing any telephone base key (except **🔍/HANDSET LOCATOR**) temporarily silences the message alert tone.

If you press **X/DELETE** when in idle mode to temporarily turn off the message alert tone, there is a voice prompt directing you to press **X/DELETE** again to delete all old messages. The message alert tone is temporarily off. Only press **X/DELETE** a second time if you wish to erase all old messages in your answering system.

The message alert tone resumes when you receive another message.

Message playback

On the telephone base, if you have new messages, the telephone plays only the new messages in chronological order. If there are no new messages, the telephone plays back all messages in chronological order.

On the handset, if you have both new and old messages, you can play either new or old messages. The caller ID information displays on the handset screen when you play messages and you can call back the caller.

When playback begins, the handset screen displays the message status, caller ID information, and time and date of the message recorded. You hear the total number of messages followed by the day and time of the message. After the last message, the telephone announces, *"End of messages."* and the screen displays **End of messages**.

To listen to messages at the telephone base:

- Press ►/■/**PLAY/STOP** on the telephone base to listen to the messages. If you have either new or old messages, the messages play automatically.
 - If you have both new and old messages, press ▼**CID** or ▲**DIR** to select **Play new msgs** or **Play old msgs**, then press **SELECT** or ►/■/**PLAY/STOP**.

To listen to messages on a cordless handset:

1. Press **MENU** in idle mode.
2. Press **SELECT** to select **Play messages**. If you have either new or old messages, the messages play automatically.
 - If you have both new and old messages, press ▼**CID** or ▲**DIR** to select **Play new msgs** or **Play old msgs**, then press **SELECT**.

When the system is playing a message, the screen shows **[2]-Call info** and the caller's name or number. If the caller's information is unavailable, the handset shows **No caller info**.

The system announces the number of messages, then begins playback. The message sequence is shown on screen. If there are no recorded messages, the screen shows **No messages** and you hear, *"You have no messages."*

Message playback

Options during playback

When a message is playing, you can adjust the playback volume, skip, repeat, pause or delete the message.

When messages are playing on the telephone base:

- Press **▼/VOLUME/▲** to adjust the message playback volume.
- Press **▶/SKIP** or **SKIP** to skip to the next message.
- Press **◀/REPEAT** or **REPEAT** to repeat the message currently playing. Press **◀/REPEAT** or **REPEAT** twice to listen to the previous message.
- Press **X/DELETE** to delete the current message. The system advances to the next message.
- Press **2** to pause the playback and show the caller ID information.
 - Press **HOME** or **CALL** to use the home line, or press **CELL 1** or **CELL 2** to use the cell line to call back the caller. If necessary, press **#** (pound key) or **1** to show different dialing options.
 - Press **CANCEL** or **BACK** to restart the playback. If you do not call back within 10 seconds, message playback restarts.
- Press **HOME** or **CELL 1** or **CELL 2** to pause the message playback. The telephone base screen displays **Call back?** with the caller ID information. Press **CALL** to call back the caller, or **BACK** to restart the message playback. If the dialing format used is not correct, then use the option, as mentioned above, to choose the correct dialing format before calling back the caller.
- Press **▶/■/PLAY/STOP** or **CANCEL** to stop the playback.

Message playback

When messages are playing on a handset:

- Press **◀)/SPEAKER** to play the messages through the handset earpiece. Press **◀)/SPEAKER** again to return to playing messages through the speakerphone.
- Press **▼CID/VOLUME/▲DIR** to adjust the message playback volume.
- Press **SKIP** to skip to the next message.
- Press **REPEAT** to repeat the message currently playing. Press **REPEAT** twice to listen to the previous message.
- Press **MUTE/DELETE** to delete the current message.
- Press **2** to pause the playback and show the caller ID information.
 - Press **HOME/FLASH, CALL** or **◀)/SPEAKER** to use the home line, or press **CELL 1** or **CELL 2** to use the cell line to call back the caller. If necessary, press **#** (pound key) or **1** to show different dialing options.
 - Press **OFF/CANCEL** or **BACK** to restart the playback. If you do not call back within 10 seconds, message playback restarts.
- Press **HOME/FLASH, CELL 1** or **CELL 2** to pause the message playback. The handset displays **Call back?** with the caller ID information. Press **CALL** to call back the caller, or **BACK** to restart the message playback. If the dialing format used is not correct, then use the option, as mentioned above, to choose the correct dialing format before calling back the caller.
- Press **OFF/CANCEL** to stop the playback.

NOTES:

- When the answering system has less than three minutes of recording time left, it announces, *"Less than three minutes to record."* and the handset displays **Rec mem low**.
- When the telephone is not in use, if the handset or telephone base displays **Rec mem full**, the memory is full. Delete some messages to make room for more.

Delete all old messages

You can only delete old (reviewed) messages. You cannot delete new messages until you review them. You cannot retrieve deleted messages.

Using the telephone base:

1. Press **X/DELETE** in idle mode. The telephone announces, *"To delete all old messages, press DELETE again."*
2. Press **X/DELETE** again. All previously reviewed messages are erased and the telephone announces, *"All old messages deleted."*

-OR-

1. Press **MENU** in idle mode.
2. Press **SELECT** to select **Answering sys.**
3. Press **▼CID** or **▲DIR** to highlight **Delete all old**, then press **SELECT**. The screen shows **Delete all old messages?**.
4. Press **YES** to confirm. The screen displays **Deleting...** and then **All old msgs deleted!**. There is a confirmation tone.

Using a handset:

1. Press **MENU** in idle mode.
2. Press **▼CID** or **▲DIR** to highlight **Answering sys**, then press **SELECT**.
3. Press **▼CID** or **▲DIR** to highlight **Delete all old**, then press **SELECT**. The screen shows **Delete all old messages?**.
4. Press **YES** to confirm. The screen displays **Deleting...** and then **All old msgs deleted!**. There is a confirmation tone..

Record and play memos

Memos are your own recorded messages used as reminders for yourself or others using the same answering system. You can record your own memos using a system handset or the telephone base. Play and delete them the same way as incoming messages.

Record a memo

1. Press **MENU** in idle mode.
2. Press ▼**CID** or ▲**DIR** to highlight **Answering sys**, then press **SELECT**.
3. Press ▼**CID** or ▲**DIR** to highlight **Record memo**, then press **SELECT**. The system announces, *"Record after the tone. Press STOP when you are done."*
4. Speak towards the microphone of the handset or the telephone base.
5. Press **STOP** to stop recording. The system announces, *"Recorded."* and then returns to the previous menu. The system does not save memos shorter than two seconds.

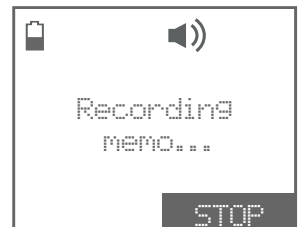

Playback a memo

Play memos the same way as messages. See **Message playback** on pages 122-124.

NOTES:

- The system announces *"Memory is full,"* if you attempt to record a memo when the memory is full.
- Each memo can be up to four minutes in length.
- Memos shorter than two second are not recorded.

Remote access

You can reach your answering system remotely by dialing your home telephone number from any touch-tone telephone.

To remotely access the answering system

1. Dial your telephone number from any touch-tone telephone.
2. Once the system plays your announcement, enter the two-digit remote access code (**19** is the default code, see page 115 to change it).
 - The system automatically announces the number of new or old messages (if any), and then begins to play them.
3. You can also enter the following remote commands.

Remote commands

1	Press to listen to all messages.
2	Press to listen to new messages only.
3	Press to delete the current message (during playback).
33	Press twice to delete all old messages.
4	Press to repeat the current message (during playback).
44	Press twice to listen to the previous message.
5	Press to stop.
*5	Press to listen to a list of remote commands.
6	Press to skip to the next message (during playback).
*7	Press to record a new announcement.
8	Press to hang up the call.
0	Press to turn the answering system on or off.

4. Hang up or press **8** to end the call.

Answering system Remote access

Print out and carry the remote access wallet card at the back of this user's manual for quick reference.



NOTES:

- If you do not press any keys after you enter the remote access code, all new messages play. If there are no new messages, all old messages play.
- Once the new messages have played, the telephone announces the help menu options. If you do not press any key within 20 seconds, the remote access call automatically disconnects.
- When the answering system is turned off, the telephone answers after 10 rings, and announces, *"Please enter your remote access code."*
- When the memory is full, the answering system answers incoming calls after 10 rings and announces, *"Memory is full. Enter the remote access code."*

Add and register handsets/headsets/speakerphones

Your telephone can support up to 12 DECT 6.0 cordless handsets (AT&T model **TL90076**, sold separately) or up to 10 cordless handsets and two cordless headsets and speakerphones (sold separately). Visit www.telephones.att.com/accessories for a list of compatible DECT 6.0 cordless headsets and speakerphones. Each new handset, headset or speakerphone must be registered to the telephone base before use. You must register each handset, headset or speakerphone separately.

To register a cordless headset or speakerphone to this telephone system, please refer to the corresponding user's manual for more details. To register a cordless handset, see the following.

The handsets provided within your product box are already registered as **HANDSET 1**, and so forth. Additional handsets are assigned numbers in the sequential order they are registered (up to **HANDSET 12**).

Register a handset to your telephone base

Method 1:

1. Before you begin registration, make sure the handset is out of the telephone base or charger and shows **To register, see user manual**.
2. Put the handset you wish to register on the telephone base cradle.

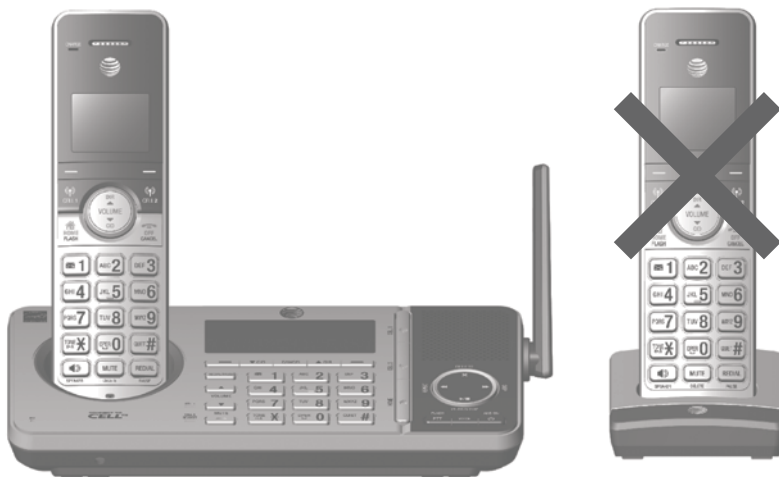



For registration, put the handset on the telephone base, not the handset charger.

3. The handset and the telephone base show **Registering... Please wait**. If the registration is successful, both the handset and the telephone base screens display **HANDSET X Registered** (**HANDSET** represents the handset name, **X** represents the handset number). Both the handset and the telephone base beep. The handset is now registered with the telephone base.

Add and register handsets/headsets/speakerphones

If registration fails, the system will automatically try to register again. If registration fails after the third try, **Registration failed** appears on both screens. The handset shows **To register, see user manual** and the telephone base returns to idle mode. This may take up to five minutes to occur. Please start again from Step 1.

Method 2:

1. Press and hold /**HANDSET LOCATOR** on the telephone base for about four seconds and it shows **Registering... Please wait**. Release /**HANDSET LOCATOR**.
2. Press **QUIET #** on the handset. The handset shows **Registering... Please wait**. If the registration is successful, both the handset and the telephone base screens display **HANDSET X Registered** (**HANDSET** represents the handset name, **X** represents the handset number). Both the handset and the telephone base beep. The handset is now registered with the telephone base.

If registration fails, **Registration failed** appears on both screens. The handset shows **To register, see user manual** and the telephone base returns to idle mode. This may take up to five minutes to occur. Please start again from Step 1.



NOTES:

- You cannot register a handset if any other system handset is in use.
- If you try to register more than 12 handsets to the telephone base, the telephone base shows **Registration slots are full** and sounds two beeps.

Deregister handsets

You may need to deregister your handsets if:

- You have 12 registered handsets and need to replace a handset.

-OR-

- You wish to change the designated handset number of your registered handsets.

You must first deregister ALL handsets, and then register each handset you wish to use again, one at a time.

Please read carefully through all the instructions on this page before beginning the deregistration process.

Deregister all handsets from the telephone base

In addition to the cordless handsets, this operation will also deregister all cordless headsets and speakerphones registered to your telephone base.













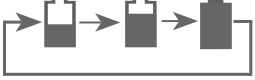

1. Make sure that all handsets are out of the telephone base and chargers before you begin deregistration.
2. Press and hold **📞/HANDSET LOCATOR** on the telephone base for about 10 seconds. The telephone base screen shows **Registering... Please wait** for five seconds, then it shows **Deregister all devices?**. Release **📞/HANDSET LOCATOR**.
3. Quickly press **📞/HANDSET LOCATOR** again or press **YES**. You must press **📞/HANDSET LOCATOR** or **YES** within five seconds. If the telephone base returns to idle screen, start again with Step 1.
4. The telephone base shows **Deregistered all devices** when the registration completes. It takes up to 10 seconds to complete the deregistration process. Before registering the handset again, wait for the cordless handset screen to display **To register, see user manual**.
5. To register the handset(s) to the telephone base again, follow the registration instructions on pages 129-130.

NOTES:

- If the deregistration process fails, you may need to reset the system and try again. To reset, unplug the power from the telephone base and plug it back in.
- You cannot deregister the handsets if any other system handset is in use.
- Even if the battery is depleted, you can still deregister the handsets by following the steps. After the handset is charged for at least 10 minutes, the screen shows **To register, see user manual**.













Appendix
Screen icons

Handset screen icons

	HOME line - On steadily when the home line is in use or there is an incoming home call.
	Search - you can perform 3-character alphabetical search to find entries quickly.
	CELL line- On steadily when a cell line is in use or there is an incoming cell call.
	Bluetooth connected devices - There are Bluetooth connected devices on the active devices list.
	Bluetooth disconnected devices - There are Bluetooth disconnected devices on the active devices list.
	Wireless Bluetooth headset - On steadily when a wireless Bluetooth headset is in use on the home line.
	Battery status - Battery is low; place handset in telephone base or charger to recharge.
	Battery status - Battery is charging.
	Speakerphone - The speakerphone is in use.
	Ringer off - The handset ringer is off.
	New voicemail - New voicemail received from your telephone service provider.
	Answering system on - The answering system is turned on.
	New answering system message - New message in the answering system.
	New caller ID log - Missed and new calls.
	Mute - Microphone is muted.

Appendix
Screen icons

Telephone base screen icons

	HOME line - On steadily when the home line is in use or there is an incoming home call.
	Search - you can perform 3-character alphabetical search to find entries quickly.
	CELL line- On steadily when a cell line is in use or there is an incoming cell call.
	Bluetooth connected devices - There are Bluetooth connected devices on the active devices list.
	Bluetooth disconnected devices - There are Bluetooth disconnected devices on the active devices list.
	Wireless Bluetooth headset - On steadily when a wireless Bluetooth headset is in use on the home line.
	Ringer off - The handset ringer is off.
	New voicemail - New voicemail received from your telephone service provider.
	Answering system on - The answering system is turned on.
	New answering system message - New message in the answering system.
	New caller ID log - Missed and new calls.
	Mute - Microphone is muted.

Appendix Alert tones

Handset alert tones

One short beep	Tone of each key press, if key tone is turned on.
One long beep	Indication to begin recording a message, memo or announcement.
Two short beeps	You are pressing ▼ CID or ▲ DIR when the volume is already at its highest or lowest setting. -OR- You have reached the end of the caller ID log. -OR- Call waiting tone. -OR- Error tone.
Confirmation tone (Three rising tones)	The telephone has completed the command successfully.
Four beeps	The other party has ended your intercom call. -OR- Out of range while the handset is on a call.
Four short beeps	Low battery warning.
Four rising tones	Your Android cell phone has received mobile notifications.

Appendix Alert tones

Telephone base alert tones

One short beep	Tone of each key press, if key tone is turned on.
One long beep	Indication to begin recording a message, memo or announcement. Indicates the start of message recording during call screening or the end of a message playback session.
Two short beeps	You are pressing ▼/ VOLUME /▲ on the telephone base when the volume is already at its highest or lowest setting. -OR- Call waiting tone. -OR- Error tone. -OR- Registration slots are full.
Confirmation tone (Three rising tones)	The system has completed the command successfully.
Four beeps	The other party has ended your intercom call.
Four short beeps	Registration failure tone.
Four rising tones	Your Android cell phone has received mobile notifications.
Beeps every 10 seconds	Message alert.

Handset indicator lights



CHARGE light

- On when the handset is charging in the telephone base or charger.

High contrast lighted display

Lighted keypad

- On when the handset is lifted from the telephone base or charger.
- On when a key is pressed.

)/SPEAKER light

- On when the speakerphone is in use.

Telephone base indicator lights

CELL 1/CELL 2

- On when the telephone base is on a cell call.
- Flashes slowly when the cell call is on hold.
- Flash quickly when there is an incoming cell call.

CELL 1/ CELL 2/HEADSET lights

- On when the telephone base is paired and connected with a Bluetooth device.
- Flash alternately while pairing a Bluetooth device.
- Flashes quickly when there is an incoming cell call.

MUTE

- On when the microphone is muted.

▶/■/PLAY/STOP

- On when the answering system is playing recorded messages.
- Flashes when there are new messages.

ANS ON

- On when the answering system is turned on.

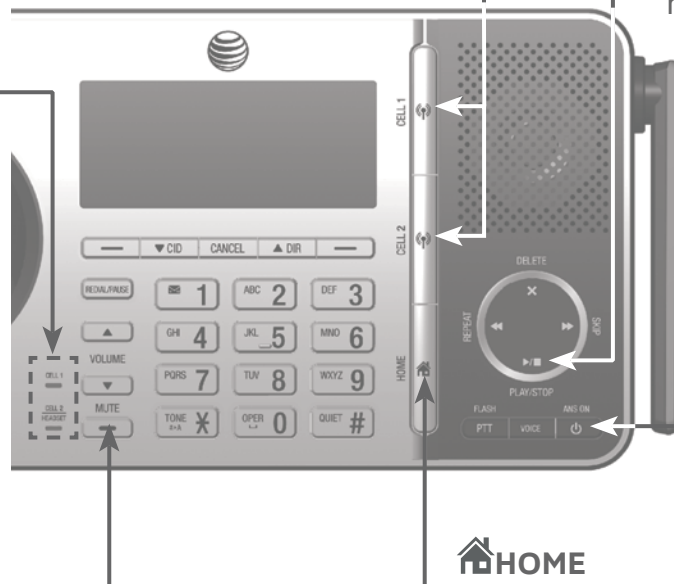

HOME

- On when the home line is in use.
- Flashes quickly when there is an incoming home call.
- Flashes slowly when the home call is on hold.

Appendix Screen messages



Activating remote voice control...	The telephone base is activating remote voice control.
Base 0 is calling	The telephone base is calling (for intercom calls).
Base 0 is calling all	The telephone base is calling all devices (for intercom calls).
Battery backup mode	Another handset is powering the telephone base during power outage.
Blocked call	An incoming call is blocked.
Bluetooth system busy	You are trying to make a cell call or access the Bluetooth menu when the Bluetooth link is already being used.
Call block list is empty. Add new entry?	There are no call block entries.
Call transferred	An outside call from one handset is transferred to another handset.
Caller ID log empty	There are no entries in the caller ID log.
Calling base / BASE 0	The handset is calling the telephone base (for intercom calls).
Calling HANDSET X	The handset or telephone base is calling another handset (for intercom calls). The telephone base is transferring an outside call to a handset.
Calling headset	The handset or telephone base is calling a headset (for intercom calls).
Cell	The cell line is on a call.
Cell 1/2 alert: XXX	The Android phone that you paired with this telephone received a mobile notification.
Cell 1/2 call on hold	A call on the cell line has been put on hold.

Appendix

Screen messages

Cell 1/2 line in use	Another system handset is using the cell line.
Cell 1/2 low batt	Message received from Alerts manager that your cell phone's battery is low.
Connecting Device X to the base...	The telephone base is trying to establish connection with a Bluetooth device.
Connection failed	A Bluetooth device in the paired or active devices list fails to establish connection with your telephone system.
Connection timeout. Please check cell status.	The telephone has failed to activate remote voice control.
Contact deleted	A directory entry is deleted.
Directory empty	There are no directory entries.
Directory full	The directory is full. You cannot save any new entries unless you delete some current entries.
Downloading...	The system is downloading a directory from a cell phone.
Ended	You have just ended a call.
HANDSET X is calling	Another system handset is calling (for intercom calls).
HANDSET X is calling all	The handset is calling all devices (for intercom calls).
Home	The home line is on a call.
Home call on hold	A call on the home line has been put on hold.
Home & cell calls on hold	Calls on the home and cell lines have been put on hold.
Home & cell lines in use	Calls on the home and cell lines are being used.
Home line in use	A system handset or another telephone on the same home line is in use.

Appendix Screen messages

Incoming call	There is a call coming in.
Intercom	The device is on an intercom call.
Intercom ended	The intercom call has just ended.
Low battery	The battery needs to be charged.
Microphone ON	Mute is off so the other party can hear your voice.
Muted	The microphone is off. The other party cannot hear you, but you can hear the other party.
New voicemail	There are new voicemail messages from your telephone service provider.
No answer. Try again.	You tried to make an intercom call, but the handset you are calling is busy, out of range, or has no power.
No battery	The battery is not properly installed and the handset is in the telephone base or charger.
No bluetooth device is ready for connection.	There is no Bluetooth device paired to the telephone system when you press  CELL 1 or  CELL 2 on the handset or telephone base.
No caller info	The caller information is not available.
No entries found. Download from SIM only?	There are no entries found when you download a cell phone directory from the cell memory.
No entries found. Download from Phone only?	There are no entries found when you download a cell phone directory from your SIM card. There are no entries found in either the cell or SIM card when you download a cell phone directory from both memories.
No home line	There is no telephone line connected.
No Incoming PTT	The incoming PTT function of the handset is turned off. The handset will not receive PTT calls.
No messages	There are no messages recorded on the answering system.
No PTT call	The incoming PTT function of the telephone base is turned off. The telephone base will not receive PTT calls.

Appendix

Screen messages

No signal, call ended	The phone lost connection with the telephone base or does not have a strong enough signal and the phone call ended.
Not available at this time	Someone else is already using the directory or caller ID log on another handset. When a handset tries to access the answering system or Bluetooth menu during battery backup mode.
Number already saved	The telephone number you have entered is already in the directory.
Out of range OR Base no power Put HS on base to power base	The telephone base has lost power, or the handset is out of range.
** Paging **	The cordless handset is paged by the telephone base.
Paging all devices	The telephone base is paging all devices.
Place in charger	The battery is very low. The handset should be charged.
Powering base... Don't pick up	The handset is powering the telephone base during power outage.
PTT From BASE 0 To devices: X	The telephone base has started a PTT session to another handset.
PTT From HANDSET X To devices: X	One handset has started a PTT session to another handset.
PTT To BASE 0	You have started the PTT process with the telephone base.
PTT To HANDSET X	You have started the PTT process with a handset.
Push to talk Ended	The PTT session is ended.
Quiet mode on	QUIET mode is on.

Appendix

Screen messages

Quiet mode is off	QUIET mode is turned off.
Rec mem full	The system recording time is full.
Rec mem low	The system recording time is low.
Registering... Please wait	The handset is registering to the telephone base.
Registration slots are full	The telephone base has the maximum of 12 handsets registered to it.
Registration failed	The handset registration is not successful.
Remote voice control ended.	The remote voice control operation is ended.
Ringer off	The ringer is turned off.
Ringer muted	The ringer is off temporarily while the device is ringing.
Saved	An entry has been successfully saved in the directory.
Setting up Answering system	The telephone is playing voice guide.
To register, see user manual	Screen display before handset registration.
Unable to call. Try again.	You try to join a call when there are already four handsets on that call. You try to make an outside call when another device is transferring a call with the intercom feature.
XX Missed calls	There are new calls in the caller ID log.
XX New messages	There are new messages in the answering system.

Troubleshooting

If you have difficulty with your telephone, please try the following suggestions. For customer service, or to purchase accessories or replacement parts, visit our website at **www.telephones.att.com**, or call **1 (800) 222-3111**. In Canada, dial **1 (866) 288-4268**.

I cannot pair my cell phone to the telephone base.

- Make sure you have cellular coverage.
- Make sure your cell phone is compatible with your **TL96276/TL96456**. Check the Bluetooth compatibility list at **www.telephones.att.com/bluetooth**.
- Make sure the Bluetooth function of your cell phone is turned on. See the user's manual of your cell phone for more information.
- Make sure that you set your cell phone to search for devices.
- If the **TL96276/TL96456** is in your cell phone device history list, delete it and try pairing again.
- Carefully follow the pairing instructions on pages 18-19 and make sure that your cell phone is not connected to any other Bluetooth device.
- Turn off your cell phone, then turn it on again.
- Reset the telephone base. Unplug the unit's electrical power. Wait for approximately 15 seconds, then plug it back in. Repeat the suggestions mentioned above.

I cannot pair my headset to the telephone base.

- Make sure that your Bluetooth headset is in discoverable mode when pairing with the telephone base. See the user's manual of your headset for more information on how to set your headset to discoverable mode.
- Make sure your headset is compatible with your **TL96276/TL96456**. Check the Bluetooth compatibility list at **www.telephones.att.com/bluetooth**.
- Carefully follow the pairing instructions on pages 20-21. Make sure that your headset is not connected to any other Bluetooth device.
- Reset the telephone base. Unplug the unit's electrical power. Wait for approximately 15 seconds, then plug it back in. Repeat the suggestions mentioned above.

Troubleshooting

I cannot connect my cell phone with the telephone base.

- Make sure that the Bluetooth function of your cell phone is turned on. See the user's manual of your cell phone for more information.
- Make sure that your Bluetooth cell phone is not connected to any other Bluetooth device.
- Turn off your cell phone, then turn it on again.
- Make sure that your cell phone is on the active devices list.
- For some cell phones, you must authorize the **TL96276/TL96456** device in your cell phone's Bluetooth feature. See the user's manual of your cell phone for more information.
- Manually connect your cell phone to the **TL96276/TL96456**. Refer to the user's manual of your cell phone for more information.

I cannot connect my headset with the telephone base.

- Make sure that your Bluetooth headset is not connected to any other Bluetooth device.
- Make sure that your headset is on the active devices list.

I cannot put my headset in discoverable mode.

- Refer to the user's manual of your headset for information on how to set your headset to discoverable mode.
- Make sure that the headset is not connected to any other Bluetooth device in order to successfully pair and connect to the telephone base.
- Carefully follow the pairing process on pages 20-21.
- Reset the telephone base. Unplug the unit's electrical power. Wait for approximately 15 seconds, then plug it back in. Repeat the suggestions mentioned above.

I don't know how to search for or add new devices on my cell phone.

- Most cell phones have the Bluetooth feature in the connection or setup menus. Please refer to the user's manual of your cell phone.
- In general, press the menu key on your cell phone, then look for the Bluetooth menu in the settings or connection menu. In the Bluetooth menu, select the option to search for or add new devices.

Troubleshooting

My cell phone disconnects with the telephone base.

- Turn off your cell phone, then turn it on again.
- Make sure that you are not using your cell phone when on a cell call.

My cell phone is connected to the telephone base, but I cannot make a cell call.

- Make sure that your cell phone is not in use when you are trying to make a cell call.
- For some smartphones, make sure that the cellular function is turned on.

Bluetooth system busy appears on the display.

- Make sure that your cell phone is not in use when connected and on the active devices list.
- Make sure that your cell phone or headset is not connected to any other Bluetooth device.
- **TL96276/TL96456** can only use one Bluetooth device at a time.

The PIN on the telephone base does not work.

- The default PIN is **0000**.
- If you have changed the PIN, it will appear on the telephone base in the pairing process.

I cannot hear any audio on my telephone system when on a cell call.

- Reset the telephone base. Unplug the unit's electrical power. Wait for approximately 15 seconds, then plug it back in.
- Turn off your cell phone, then turn it on again.

The listening volume of my cell call is too loud or quiet.

- During a cell call, if the listening volume is too loud or quiet, try changing the volume on your cell phone. On some cell phones, changing the volume on the cell phone affects your cell call volume on the **TL96276/TL96456** handset.

Troubleshooting

I cannot download contacts from my cell phone to my TL96276/TL96456.

- Make sure that your cell phone is paired and connected to the base.
- Make sure you place your cell phone next to the base while downloading.
- If your cell phone does not support the download, you can send the directory from your cell phone. The system can receive the directory automatically. See the user's manual of your cell phone for more information.

I see duplicate entries in my downloaded directory.

- If you see duplicate directory entries, you can delete them manually. Another option is to download again from either your SIM card or phone memory, but not both.

Some of my cell phone contacts were not imported to my TL96276/TL96456.

- Make sure to try copying the contacts from your SIM card to your cell phone memory first, then download from your phone memory. If that doesn't work, try copying the contacts from your cell phone memory to your SIM card, then download from your SIM card. For more information on how to transfer contacts between your SIM card and your phone memory, refer to the user's manual of your cell phone.

Can the TL96276/TL96456 help the poor cell phone reception in my house?

- If your cell phone has poor reception in your home, the **TL96276/TL96456** cannot improve the reception. However, if you have a location in your house with better reception, you can leave your cell phone in that location while you use **TL96276/TL96456** cell line. In order for this to work, the cell phone must be within 30 feet of the telephone base for optimal performance.

The phone doesn't play my iPhone ringtone when there is an incoming call.

- Make sure your iPhone operating system is iOS 4.1 or later.
- Make sure you have turned on the **Cell ringer** feature (page 31).

The iPhone ringtone played is unclear or too loud with noise.

- The quality of ringtone played on your telephone is subject to individual ringtone characteristics.
- Try using another iPhone ringtone to test the quality.

Troubleshooting

My phone doesn't work at all.

- Make sure the power cord is securely plugged in.
- Make sure that the battery connector is securely plugged into the handset.
- Make sure the telephone line cord is securely and firmly plugged into the telephone base and the telephone wall jack.
- Charge the battery in the handset for at least 11 hours. For optimum daily performance, return the handset to the telephone base or charger when not in use.
- If the battery is depleted, charge the handset for at least 30 minutes before you use it. Refer to page 10 for details.
- Reset the telephone base. Unplug the electrical power. Wait for approximately 15 seconds, then plug it back in. Allow up to one minute for the handset and telephone base to reset.
- You may need to purchase a new battery. Please refer to **Battery installation and charging** (pages 11-13) in this user's manual.

The remote voice control feature does not work.

- Make sure the operating system of your cell phone is iOS 8 or later, or Android 4 or later.
- Make sure your cell phone is paired and connected to your telephone system via Bluetooth.
- Make sure no Bluetooth applications are running in the background of your cell phone.
- Keep your cell phone within 15 feet of the telephone base.
- Do not lock up your cell phone's screen or set passcode for activating the voice-controlled application (voice app).
- Make sure you have turned on or logged in to the applications on your cell phone that you will be sending your voice commands, such as GPS, e-mail and social networking accounts.
- Make sure your cell phone's data or Wi-Fi signal is in full strength and your cell phone can connect to the Internet.
- Try to activate the voice app on your cell phone to ensure it is in place.

Troubleshooting

- Once you have activated the remote voice control feature, you are using your cell phone's voice app to operate your cell phone. If the voice commands do not work, please check the cell phone user's manual and the voice app's help topics to find out what commands you can use and any limitations of the voice app.
- Some cell phone manufacturers or network carriers may customize the phone's operating system and implement their own voice app. If you want to use Google Now, you need to manually set it as your default voice app. For detailed instructions, refer to your cell phone user's manual, or contact your cell phone's manufacturer or network carrier. You may also go to "Google Product Forums" on the Internet and check the corresponding help topics.
- Due to the settings of certain cell phones and voice apps, your cell phone may not support the remote voice control feature. Contact your cell phone's manufacturer or network carrier, or check the voice app's help topics if you encounter any problems.

The remote voice control feature ends unexpectedly while it is in use.

- The Bluetooth function of your cell phone may be off, or you may have moved your cell phone out of Bluetooth range of the telephone base. Make sure the Bluetooth function of your cell phone is turned on and keep your cell phone within 15 feet of the telephone base.
- The data or Wi-Fi connection of your cell phone may be lost. Make sure your cell phone's data or Wi-Fi signal is in full strength.
- The feature may be ended automatically by your cell phone. For example, a cell call has been established via the remote voice control feature and the call has just ended.
- If you receive a landline or cell line incoming call when you have activated remote voice control on a connected cell phone, the remote voice control operation will be ended.
- The voice-controlled application of your cell phone may be affected by other cell phone operations in the background. If the problem persists, contact your cell phone's network carrier.

Troubleshooting

I cannot press any dialing keys (0-9, TONE X, QUIET #) when I am on a cell call using the remote voice control feature.

- When you press the dialing keys on the handset or telephone base during a cell call using the remote voice control feature, the telephone system may have no response and the call may be ended. Please use the cell lines of your telephone system for calls that require using the dialing keys during the call (see **Make, answer or end a cell call** on page 52).

The display shows No home line. I cannot get a dial tone.

- First try all the suggestions mentioned above.
- If the previous suggestions do not work, disconnect the telephone line cord from your telephone and connect the telephone line cord to another telephone.
 - If there is no dial tone on that other telephone either, your telephone line cord may be defective. Install a new telephone line cord.
 - If changing the telephone line cord does not help, the wall jack (or the wiring to this wall jack) may be defective. Try using a different wall jack in your home to connect your **TL96276/TL96456** telephone, or contact your telephone service provider (charges may apply).

I cannot dial out.

- Try all the suggestions in **The display shows No home line. I cannot get a dial tone** on page 148.
- Make sure you have a dial tone before dialing. The handset may take a second or two to find the telephone base and produce a dial tone. This is normal. Wait an extra second before dialing.
- Eliminate any background noise. Noise from a television, radio or other appliances may cause the phone to not dial out properly. If you cannot eliminate the background noise, first try muting the handset before dialing, or dialing from another room in your home with less background noise.
- Disconnect the telephone base from the telephone wall jack and plug in a working telephone. If the other phones in your home are having the same problem, the problem is in your wiring or telephone service. Contact your telephone service provider (charges may apply).

Troubleshooting

During power outage, I put a handset in the telephone base but the system fails to power up.

- Make sure the handset you placed in the telephone base has enough charge to power up the system.
- Try removing and re-installing the handset's battery. Place the handset in the telephone base again.

My handset isn't performing normally.

- Make sure the power cord is securely plugged into the telephone base. Plug the power adapter into a different working electrical outlet not controlled by a wall switch.
- Move the handset closer to the telephone base. You might have moved out of range.
- Reset the telephone base. Unplug the electrical power. Wait for 15 seconds, then plug it back in. Allow up to one minute for the handset and telephone base to reset.
- Other electronic products such as HAM radios and other DECT phones, can cause interference to your cordless telephone. Try installing your telephone as far away as possible from these types of electronic devices.

Out of range OR Base no power appears on my cordless handset.

- Ensure that the telephone base is powered up.
- Place the cordless handset in the telephone base for one minute to allow the cordless handset and base to synchronize.
- Move the cordless handset closer to the telephone base. You might have moved out of range.
- Reset the telephone base. Unplug the electrical power. Wait for 15 seconds, then plug it back in. Allow up to one minute for the cordless handset and telephone base to reset.
- Other electronic products such as HAM radios and other DECT phones, can cause interference to your cordless telephone. Try installing your telephone as far away as possible from these types of electronic devices.

Troubleshooting

The batteries do not hold a charge.

- If the handset is in the charger and the charge light does not turn on, refer to **The charge light is off** (page 154) in this **Troubleshooting** guide.
- Charge the battery in the handset for at least 11 hours. For optimum daily performance, return the handset to the telephone base or charger when not in use.
- If the battery is depleted, it may take approximately 30 minutes to charge the handset before it shows **Low battery**, refer to page 11 for details.
- You may need to purchase a new battery. Please refer to **Battery installation and charging** (pages 11-13) in this user's manual.

I get noise, static, or a weak signal even when I'm near the telephone base.

- If you subscribe to high-speed Internet service (digital subscriber line - DSL) through your telephone lines, you must install a DSL filter between the telephone line cord and the telephone wall jack (see page 9). The filter prevents noise and caller ID problems caused by DSL interference. Please contact your DSL service provider for more information about DSL filters.
- You may be able to improve the performance of your cordless phone by installing your new telephone base as far as possible from any other existing cordless telephone system that may already be installed.
- Other electronic products such as HAM radios and other DECT phones, can cause interference to your cordless telephone. Try installing your telephone as far away as possible from these types of electronic devices.
- Do not install this phone near a microwave oven or on the same electrical outlet. You may experience decreased performance while the microwave oven is operating.
- If your phone is plugged in with a modem or a surge protector, plug the phone (or modem/surge protector) into a different location. If this doesn't solve the problem, relocate your phone or modem farther apart from one another, or use a different surge protector.
- Relocate your phone to a higher location. The phone may have better reception when installed in a high area.
- Disconnect the telephone base from the telephone wall jack and plug in a working telephone. If the other phones in your home are having the same problem, the problem is in your wiring or telephone service. Contact your telephone service provider (charges may apply).

Troubleshooting

I experience poor sound quality when using the speakerphone.

- For increased sound quality while using the speakerphone, place the handset on a flat surface with the dial pad facing up.
- When using a speakerphone, controlling background noise in your environment is essential. While you are listening to your party, press **MUTE/DELETE** to temporarily turn your microphone off. When it is your turn to speak, remember to press **MUTE/DELETE** again to turn the microphone on.
- Excessive background noise will cause a speakerphone to fade in and out. Try controlling the background noise by turning off any audio devices near the speakerphone. Also, try to avoid interrupting the person at the other end of the conversation while they are speaking. If background noise cannot be controlled, you should terminate speakerphone operation and return to normal handset mode.

I hear other calls while using my phone.

- Disconnect the telephone base from the telephone wall jack and plug in a working telephone. If the other phones in your home are having the same problem, the problem is in your wiring or telephone service. Call your telephone service provider (charges may apply).

Troubleshooting

My cordless handset does not ring when I receive a call.

- Make sure that the ringer is not turned off. Refer to **Ringer volume** on page 36 in this user's manual.
- Make sure the telephone line cord is plugged securely into the telephone base and the telephone jack. Make sure the power cord is securely plugged in.
- The cordless handset may be too far from the telephone base.
- Charge the battery in the cordless handset for at least 11 hours. For optimum daily performance, return the cordless handset to the telephone base or charger when not in use.
- You may have too many extension phones on your telephone line to allow all of them to ring simultaneously. Try unplugging some of the other phones.
- The layout of your home or office might be limiting the operating range. Try moving the telephone base to another location, preferably to a higher location.
- Disconnect the telephone base from the telephone wall jack and plug in a working telephone. If the other phones in your home are having the same problem, the problem is in your wiring or telephone service. Contact your telephone service provider (charges may apply).
- Test a working phone at the phone jack. If another phone has the same problem, the problem is the phone jack. Contact your telephone service provider (charges may apply).
- Other electronic products such as HAM radios and other DECT phones, can cause interference to your cordless telephone. Try installing your telephone as far away as possible from these types of electronic devices.
- Completely remove the battery. Replace the battery and place the cordless handset in the telephone base. Wait for the cordless handset to reestablish its connection with the telephone base. Allow up to one minute for this to take place.
- Your line cord might be defective. Try installing a new line cord.

Troubleshooting

My calls cut in and out while I'm using my cordless handset.

- Other electronic products such as HAM radios and other DECT phones, can cause interference to your cordless telephone. Try installing your telephone as far away as possible from these types of electronic devices.
- Do not install this phone near a microwave oven or on the same electrical outlet. You may experience decreased performance while the microwave oven is operating.
- If you plug your phone in with a modem or surge protector, plug the phone (or modem/surge protector) into a different location. If this doesn't solve the problem, relocate your phone or modem farther apart from one another, or use a different surge protector.
- Relocate your telephone base to a higher location. The phone may have better reception when installed in a high area.
- Disconnect the telephone base from the telephone wall jack and plug in a working telephone. If the other phones in your home are having the same problem, the problem is in your wiring or telephone service. Contact your telephone service provider (charges may apply).
- Excessive background noise will cause a speakerphone to fade in and out. Try controlling the background noise by turning off any audio devices near the speakerphone. Also, try to avoid interrupting the person at the other end of the conversation while they are speaking. If background noise cannot be controlled, you should stop speakerphone operation and return to normal handset mode.
- When using a speakerphone, controlling background noise in your environment is essential. While you are listening to your party, press **MUTE/DELETE** to temporarily turn your microphone off. When it is your turn to speak, remember to press **MUTE/DELETE** to turn the microphone on.

Troubleshooting

The charge light is off.

- Make sure the power and line cords are plugged in correctly and securely.
- Unplug the electrical power. Wait for 15 seconds, then plug it back in. Allow up to one minute for the handset and telephone base to reset.
- Clean the handset and telephone base charging contacts each month using a pencil eraser or cloth.

My caller ID isn't working.

- Caller ID is a subscription service. You must subscribe to this service from your telephone service provider for this feature to work on your phone.
- The caller must be calling from an area that supports caller ID.
- Both your and your caller's telephone service providers must use caller ID compatible equipment.
- If you subscribe to high-speed Internet service (digital subscriber line - DSL) through your telephone lines, you must install a DSL filter between the telephone line cord and the telephone wall jack (see page 9). The filter prevents noise and caller ID problems caused by DSL interference. Please contact your DSL service provider for more information about DSL filters.

System does not receive caller ID when on a call.

- Make sure you subscribe to caller ID with call waiting features provided by your telephone service provider. Caller ID features work only if both you and the caller are in areas offering caller ID service, and if both telephone companies use compatible equipment.

An icon and New voicemail show on the display and I don't know why.

- Your telephone has voicemail indication that is separate from the built-in answering system. If  appears on the display, then your telephone has received a signal from your telephone service provider that you have a voicemail message waiting for you to retrieve from your telephone service provider. Contact your telephone service provider for more information on how to access your voicemail.

Troubleshooting

I cannot retrieve voicemail messages.

- Your telephone has both a built-in answering system and voicemail indication. They are independent features and each alerts you to new messages differently (page 118). If you subscribe to voicemail service from your telephone service provider (charges may apply), contact your telephone service provider for more information on how to access your voicemail.

I am receiving incomplete messages.

- If a caller leaves a very long message, part of it may be lost when the system disconnects the call after the maximum recording time you have set (page 105).
- If the caller pauses for longer than seven seconds, the system stops recording and disconnects the call.
- If the system's memory becomes full during a message, the system stops recording and disconnects the call.
- If the caller's voice is very soft, the system may stop recording and disconnect the call.

I am having difficulty hearing messages.

- Press **VOLUME▲** to increase speaker volume on the telephone base.
- Press **VOLUME▲** to increase the listening volume on a handset.

Troubleshooting

The answering system does not answer after the correct number of rings.

- Make sure the answering system is on. When the answering system is on, **ANS ON** should show on the handset and the telephone base. The **ANS ON** light is lit on the telephone base.
- If toll saver is selected (page 114), the number of rings changes to two when there are new messages waiting.
- If the memory is full or the system is off, the system answers after 10 rings.
- In some cases, the answering system is affected by the ringing system used by the telephone service provider.
- If you subscribe to voicemail service, change the number of rings so that your answering system answers before your voicemail (page 118). To determine how many rings activate your voicemail, please contact your telephone service provider.
- If there is a fax machine connected to the same telephone line, try disconnecting the fax machine. If that solves the problem, consult your fax machine documentation for information on compatibility with answering systems.

The answering system announces *"Time and day not set."*

- You need to set the date and time (page 39).

System does not respond to remote commands.

- Make sure to enter your remote access code correctly (page 115).
- Make sure you are calling from a touch-tone phone. When you dial a number, you should hear tones. If you hear clicks, the phone is not a touch-tone telephone and cannot activate the answering system.
- The answering system may not detect the remote access code while your announcement is playing. Try waiting until the announcement is over before entering the code.
- There may be interference on the phone line you are using. Press the dial pad keys firmly.

Troubleshooting

The answering system does not record messages.

- Make sure the answering system is on.
- Make sure the memory of the answering system is not full. When the answering machine memory is full, it does not record new messages until some old messages are deleted.
- If you subscribe to voicemail service, change the number of rings so that your answering system answers before your voicemail (page 118). To determine how many rings activate your voicemail, please contact your telephone service provider.
- If there is a fax machine connected to the same telephone line, try disconnecting the fax machine. If that solves the problem, consult your fax machine documentation for information on compatibility with answering systems.

The outgoing announcement is not clear.

- When you record your announcement, make sure you speak in a normal tone of voice towards the microphone of the handset.
- Make sure there is no background noise (TV, music, etc.) while recording.

I subscribe to a nontraditional telephone service that uses my computer to establish connections, and my telephone doesn't work.

- Make sure your computer is powered on.
- Make sure your Internet connection is working properly.
- Make sure that the software is installed and running for your nontraditional telephone service.
- Make sure to plug your USB telephone adapter into a dedicated USB port on your computer. Do not plug into a multiple port USB hub (USB splitter) that is not powered.
- In a few rare instances, the USB port on your computer may not have enough power. In these instances, try using a USB hub with its own external power supply.
- If you are using a firewall, it may prevent access to your nontraditional telephone service provider. Contact your service provider for more information.

Troubleshooting

I've set my LCD language to Spanish or French and I don't know how to change it back to English.

- Press **MENU** on your handset or base in idle mode, then enter **364#** on the handset or base. You hear a confirmation tone.

The handset registration is unsuccessful.

Follow the steps, as mentioned below, to register the handset again.

1. Make sure the handset is out of the telephone base or charger and shows **To register, see user manual** before you begin registration.
2. Place the handset you wish to register on the telephone base cradle. The handset displays **Registering... Please wait** on the handset. It takes about 90 seconds to complete the registration process. The handset displays **HANDSET X Registered** (X represents the registered handset number) and the beeps when registration completes.

Refer to the **Add and register handsets/headsets/speakerphones** section on pages 129-130 for details.

Common cure for electronic equipment:

If the telephone is not responding normally, try resetting the telephone. Do the following in the order listed:

1. Disconnect the power to the telephone base.
2. Disconnect the handset battery, and spare battery, if applicable.
3. Wait a few minutes.
4. Connect power to the telephone base.
5. Completely remove the battery. Replace the battery and place the handset into the telephone base.
6. Wait for the handset to reestablish its connection with the telephone base. Allow up to one minute for this to take place.

Maintenance

Taking care of your telephone

- Your cordless telephone contains sophisticated electronic parts, so it must be treated with care.
- Avoid rough treatment.
- Place the handset down gently.
- Save the original packing materials to protect your telephone if you ever need to ship it.

Avoid water

- Your telephone can be damaged if it gets wet. Do not use the handset in the rain, or handle it with wet hands. Do not install the telephone base near a sink, bathtub or shower.

Electrical storms

- Electrical storms can sometimes cause power surges harmful to electronic equipment. For your own safety, take caution when using electric appliances during storms.

Cleaning your telephone

- Your telephone has a durable plastic casing that should retain its luster for many years. Clean it only with a soft cloth slightly dampened with water or mild soap.
- Do not use excess water or cleaning solvents of any kind.

Remember that electrical appliances can cause serious injury if used when you are wet or standing in water. If the telephone base should fall into water, DO NOT RETRIEVE IT UNTIL YOU UNPLUG THE POWER CORD AND TELEPHONE LINE CORDS FROM THE WALL. Pull the telephone out by the unplugged cords.

Important safety information



This symbol is to alert you to important operating or servicing instructions that may appear in this user's manual. Always follow basic safety precautions when using this product to reduce the risk of injury, fire, or electric shock.

Safety information

- Read and understand all instructions in the user's manual. Observe all markings on the product.
- Avoid using a telephone during a thunderstorm. There might be a slight chance of electric shock from lightning.
- Do not use a telephone in the vicinity of a gas leak. Under certain circumstances, a spark may be created when the adapter is plugged into the power outlet, or when the handset is replaced in its cradle. This is a common event associated with the closing of any electrical circuit. The user should not plug the phone into a power outlet, and should not put a charged handset into the cradle, if the phone is located in an environment containing concentrations of flammable or flame-supporting gases, unless there is adequate ventilation. A spark in such an environment could create a fire or explosion. Such environments might include: medical use of oxygen without adequate ventilation; industrial gases (cleaning solvents; gasoline vapors; etc.); a leak of natural gas; etc.
- Do not use this product near water, or when you are wet. For example, do not use it in a wet basement or shower, or next to a swimming pool, bathtub, kitchen sink, or laundry tub. Do not use liquids or aerosol sprays for cleaning. If the product comes in contact with any liquids, unplug any line or power cord immediately. Do not plug the product back in until it has dried thoroughly.
- Install this product in a protected location where no one can trip over any line or power cords. Protect cords from damage or abrasion.
- If this product does not operate normally, read the **Troubleshooting** section on pages 142-158 of this user's manual. If you cannot solve the problem, or if the product is damaged, refer to the **Limited warranty** section on pages 166-167. Do not open this product except as may be directed in your user's manual. Opening the product or reassembling it incorrectly may expose you to hazardous voltages or other risks.
- Replace batteries only as described in your user's manual (pages 11-13). Do not burn or puncture batteries — they contain caustic chemicals.
- The power adapters are intended to be correctly oriented in a vertical or floor mount position. The prongs are not designed to hold the plug in place if it is plugged into a ceiling, under-the-table or cabinet outlet.
- For pluggable equipment, the socket-outlet shall be installed near the equipment and shall be easily accessible.



CAUTIONS:

- Use only the power adapters provided with this product. To obtain a replacement, visit our website at **www.telephones.att.com**, or call **1 (800) 222-3111**. In Canada, dial **1 (866) 288-4268**.
- Use only the supplied rechargeable battery or replacement battery (model BT183342/BT283342). To order, visit our website at **www.telephones.att.com** or call **1 (800) 222-3111**. In Canada, dial **1 (866) 288-4268**.
- To prevent risk of fire or battery explosion, replace with the correct battery type. Dispose of used batteries according to the instructions.

Important safety information

Especially about cordless telephones

- **Privacy:** The same features that make a cordless telephone convenient create some limitations. Telephone calls are transmitted between the telephone base and the handset by radio waves, so there is a possibility that your cordless telephone conversations could be intercepted by radio receiving equipment within range of the cordless handset. For this reason, you should not think of cordless telephone conversations as being as private as those on corded telephones.
- **Electrical power:** The telephone base of this cordless telephone must be connected to a working electrical outlet which is not controlled by a wall switch. Calls cannot be made from the handset if the telephone base is unplugged, switched off or if the electrical power is interrupted.
- **Potential TV interference:** Some cordless telephones operate at frequencies that may cause interference to TVs and VCRs. To minimize or prevent such interference, do not place the telephone base of the cordless telephone near or on top of a TV or VCR. If interference is experienced, moving the cordless telephone farther away from the TV or VCR will often reduce or eliminate the interference.
- **Rechargeable batteries:** This product contains nickel-metal hydride rechargeable batteries. Exercise care in handling batteries in order not to create a short circuit with conductive material such as rings, bracelets, and keys. The battery or conductor may overheat and cause harm. Observe proper polarity between the battery and the battery charger.
- **Nickel-metal hydride rechargeable batteries:** Dispose of these batteries in a safe manner. Do not burn or puncture. Like other batteries of this type, if burned or punctured, they could release caustic material which could cause injury.



The RBRC® Seal means that the manufacturer is voluntarily participating in an industry program to collect and recycle nickel-metal hydride rechargeable batteries when taken out of service within the United States. These batteries may be taken to a participating local retailer of replacement batteries or recycling center. You may call 1-800-8-BATTERY® for locations accepting spent Ni-MH batteries.

RBRC® and 1-800-8-BATTERY® are registered trademarks of the Rechargeable Battery Recycling Corporation.

Important safety information

Precautions for users of implanted cardiac pacemakers

Cardiac pacemakers (applies only to digital cordless telephones):

Wireless Technology Research, LLC (WTR), an independent research entity, led a multidisciplinary evaluation of the interference between portable wireless telephones and implanted cardiac pacemakers. Supported by the U.S. Food and Drug Administration, WTR recommends to physicians that:

Pacemaker patients:

- Should keep wireless telephones at least six inches from the pacemaker.
- Should NOT place wireless telephones directly over the pacemaker, such as in a breast pocket, when it is turned ON.
- Should use the wireless telephone at the ear opposite the pacemaker.

WTR's evaluation did not identify any risk to bystanders with pacemakers from other persons using wireless telephones.

ECO mode

This power conserving technology reduces power consumption for optimal battery performance. The ECO mode activates automatically whenever the handset is synchronized with the telephone base.

Especially about telephone answering systems

Two-way recording: This unit does not sound warning beeps to inform the other party that the call is being recorded. To ensure that you are in compliance with any federal or state regulations regarding recording a telephone call, you should start the recording process and then inform the other party that you are recording the conversation.

SAVE THESE INSTRUCTIONS

Appendix

FCC Part 68 and ACTA

This equipment complies with Part 68 of the FCC rules and with technical requirements adopted by the Administrative Council for Terminal Attachments (ACTA). The label on the back or bottom of this equipment contains, among other things, a product identifier in the format US:AAAEQ##TXXXX. This identifier must be provided to your telephone service provider upon request.

The plug and jack used to connect this equipment to premises wiring and the telephone network must comply with the applicable Part 68 rules and technical requirements adopted by ACTA. A compliant telephone cord and modular plug is provided with this product. It is designed to be connected to a compatible modular jack that is also compliant. An RJ11 jack should normally be used for connecting to a single line and an RJ14 jack for two lines. See Installation Instructions in the user's manual.

The Ringer Equivalence Number (REN) is used to determine how many devices you may connect to your telephone line and still have them ring when you are called. The REN for this product is encoded as the 6th and 7th characters following the US: in the product identifier (e.g., if ## is 03, the REN is 0.3). In most, but not all areas, the sum of all RENs should be five (5.0) or less. For more information, please contact your telephone service provider.

This equipment must not be used with Party Lines. If you have specially wired alarm dialing equipment connected to your telephone line, ensure the connection of this equipment does not disable your alarm equipment. If you have questions about what will disable the alarm equipment, consult your telephone service provider or a qualified installer.

If this equipment is malfunctioning, it must be unplugged from the modular jack until the problem has been corrected. Repairs to this telephone equipment can only be made by the manufacturer or its authorized agents. For repair procedures, follow the instructions outlined under the Limited Warranty.

If this equipment is causing harm to the telephone network, the telephone service provider may temporarily discontinue your telephone service. The telephone service provider is required to notify you before interrupting service. If advance notice is not practical, you will be notified as soon as possible. You will be given the opportunity to correct the problem and the telephone service provider is required to inform you of your right to file a complaint with the FCC. Your telephone service provider may make changes in its facilities, equipment, operation, or procedures that could affect the proper functioning of this product. The telephone service provider is required to notify you if such changes are planned.

If this product is equipped with a corded or cordless handset, it is hearing aid compatible.

If this product has memory dialing locations, you may choose to store emergency telephone numbers (e.g., police, fire, medical) in these locations. If you do store or test emergency numbers, please:

- Remain on the line and briefly explain the reason for the call before hanging up.
- Perform such activities in off-peak hours, such as early morning or late evening.

Industry Canada

This device complies with Industry Canada licence-exempt RSS standard(s).

Operation is subject to the following two conditions: (1) this device may not cause harmful interference, and (2) this device must accept any interference received, including interference that may cause undesired operation.

Privacy of communications may not be ensured when using this telephone.

The term "IC:" before the certification/registration number only signifies that the Industry Canada technical specifications were met.

The Ringer Equivalence Number (REN) for this terminal equipment is 1.0. The REN indicates the maximum number of devices allowed to be connected to a telephone interface. The termination of an interface may consist of any combination of devices subject only to the requirement that the sum of the RENs of all the devices not exceed five.

This product meets the applicable Innovation, Science and Economic Development Canada technical specifications.

Appendix FCC Part 15

NOTE: This equipment has been tested and found to comply with the requirements for a Class B digital device under Part 15 of the Federal Communications Commission (FCC) rules.

These requirements are intended to provide reasonable protection against harmful interference in a residential installation. This equipment generates, uses and can radiate radio frequency energy and, if not installed and used in accordance with the instructions, may cause harmful interference to radio communications. However, there is no guarantee that interference will not occur in a particular installation.

If this equipment does cause harmful interference to radio or television reception, which can be determined by turning the equipment off and on, the user is encouraged to try to correct the interference by one or more of the following measures:

- Reorient or relocate the receiving antenna.
- Increase the separation between the equipment and receiver.
- Connect the equipment into an outlet on a circuit different from that to which the receiver is connected.
- Consult the dealer or an experienced radio/TV technician for help.

WARNING: Changes or modifications to this equipment not expressly approved by the party responsible for compliance could void the user's authority to operate the equipment.

This device complies with Part 15 of the FCC rules. Operation is subject to the following two conditions: (1) this device may not cause harmful interference, and (2) this device must accept any interference received, including interference that may cause undesired operation. Privacy of communications may not be ensured when using this telephone.





To ensure safety of users, the FCC has established criteria for the amount of radio frequency energy that can be safely absorbed by a user or bystander according to the intended usage of the product. This product has been tested and found to comply with the FCC criteria. The handset may be safely held against the ear of the user. The telephone base shall be installed and used such that parts of the user's body other than the hands are maintained at a distance of approximately 20cm (8 inches) or more.

This Class B digital apparatus complies with Canadian requirement:
CAN ICES-3 (B)/NMB-3(B)

California Energy Commission battery charging testing instructions

This telephone is set up to comply with the energy-conserving standards right out of the box. These instructions are intended for California Energy Commission (CEC) compliance testing only. When the CEC battery charging testing mode is activated, all telephone functions, except handset battery charging, will be disabled.

To activate the CEC battery charging testing mode:

1. Unplug the telephone base power adapter from the power outlet. Make sure all handsets are plugged with charged batteries before proceeding.
2. While you press and hold  /**HANDSET LOCATOR**, plug the telephone base power adapter back to the power outlet.
3. After about 20 seconds, when the  **HOME** light starts flashing, release  /**HANDSET LOCATOR** and then press it again within two seconds. You hear a confirmation tone. The  **HOME** light turns off and all handsets display **To register, see user manual**. Allow up to one minute for the process to complete.



If the phone fails to enter this mode, repeat Step 1 through Step 3.

The telephone base will be powered up as normal if you fail to press  /**HANDSET LOCATOR** within two seconds in Step 3.

To deactivate the CEC battery charging testing mode:

1. Unplug the telephone base power adapter from the power outlet, then plug it back in. The telephone base is powered up as normal.
2. Register your handsets back to the telephone base. See pages 129-130 for handset registration instructions.



Limited warranty

The AT&T brand is used under license - any repair, replacement or warranty service, and all questions about this product should be directed to our website at

www.telephones.att.com or call **1 (800) 222-3111**. In Canada, dial **1 (866) 288-4268**.

1. What does this limited warranty cover?

The manufacturer of this AT&T branded product warrants to the holder of a valid proof of purchase ("CONSUMER" or "you") that the product and all accessories provided in the sales package ("PRODUCT") are free from defects in material and workmanship, pursuant to the following terms and conditions, when installed and used normally and in accordance with the PRODUCT operating instructions. This limited warranty extends only to the CONSUMER for products purchased and used in the United States of America and Canada.

2. What will be done if the PRODUCT is not free from defects in materials and workmanship during the limited warranty period ("materially defective PRODUCT")?

During the limited warranty period, the manufacturer's authorized service representative repairs or replaces at the manufacturer's option, without charge, a materially defective PRODUCT. If the manufacturer repairs the PRODUCT, they may use new or refurbished replacement parts. If the manufacturer chooses to replace the PRODUCT, they may replace it with a new or refurbished PRODUCT of the same or similar design. The manufacturer will retain the defective parts, modules, or equipment. Repair or replacement of the PRODUCT, at the manufacturer's option, is your exclusive remedy. The manufacturer returns the repaired or replacement products to you in working condition. You should expect the repair or replacement to take approximately 30 days.

3. How long is the limited warranty period?

The limited warranty period for the PRODUCT extends for ONE (1) YEAR from the date of purchase. If the manufacturer repairs or replaces a materially defective PRODUCT under the terms of this limited warranty, this limited warranty also applies to repaired or replacement PRODUCT for a period of either (a) 90 days from the date the repaired or replacement PRODUCT is shipped to you or (b) the time remaining on the original one-year limited warranty; whichever is longer.

4. What is not covered by this limited warranty?

This limited warranty does not cover:

- PRODUCT that has been subjected to misuse, accident, shipping or other physical damage, improper installation, abnormal operation or handling, neglect, inundation, fire, water, or other liquid intrusion; or
- PRODUCT that has been damaged due to repair, alteration, or modification by anyone other than an authorized service representative of the manufacturer; or
- PRODUCT to the extent that the problem experienced is caused by signal conditions, network reliability or cable or antenna systems; or
- PRODUCT to the extent that the problem is caused by use with non-AT&T accessories; or
- PRODUCT whose warranty/quality stickers, PRODUCT serial number plates or electronic serial numbers have been removed, altered or rendered illegible; or
- PRODUCT purchased, used, serviced, or shipped for repair from outside the United States of America or Canada, or used for commercial or institutional purposes (including but not limited to products used for rental purposes); or
- PRODUCT returned without a valid proof of purchase (see item 6); or
- Charges for installation or setup, adjustment of customer controls, and installation or repair of systems outside the unit.

Limited warranty

5. How do you get warranty service?

To obtain warranty service in the United States of America, visit

www.telephones.att.com or call **1 (800) 222-3111**. In Canada, please dial **1 (866) 288-4268**.

NOTE: Before calling for service, please review the user's manual. A check of the PRODUCT's controls and features might save you a service call.

Except as provided by applicable law, you assume the risk of loss or damage during transit and transportation and are responsible for delivery or handling charges incurred in the transport of the PRODUCT(s) to the service location. The manufacturer will return repaired or replaced PRODUCT under this limited warranty. Transportation, delivery or handling charges are prepaid. The manufacturer assumes no risk for damage or loss of the PRODUCT in transit. If the PRODUCT failure is not covered by this limited warranty, or proof of purchase does not meet the terms of this limited warranty, the manufacturer notifies you and requests that you authorize the cost of repair prior to any further repair activity. You must pay for the cost of repair and return shipping costs for the repair of products that are not covered by this limited warranty.

6. What must you return with the PRODUCT to get warranty service?

You must:

- a. Return the entire original package and contents including the PRODUCT to the service location along with a description of the malfunction or difficulty; and
- b. Include "valid proof of purchase" (sales receipt) identifying the PRODUCT purchased (PRODUCT model) and the date of purchase or receipt; and
- c. Provide your name, complete and correct mailing address, and telephone number.

7. Other limitations

This warranty is the complete and exclusive agreement between you and the manufacturer of this AT&T branded PRODUCT. It supersedes all other written or oral communications related to this PRODUCT. The manufacturer provides no other warranties for this PRODUCT. The warranty exclusively describes all of the manufacturer's responsibilities regarding the PRODUCT. There are no other express warranties. No one is authorized to make modifications to this limited warranty and you should not rely on any such modification.

State/Provincial Law Rights: This warranty gives you specific legal rights, and you might also have other rights that vary from state to state or province to province.

Limitations: Implied warranties, including those of fitness for a particular purpose and merchantability (an unwritten warranty that the PRODUCT is fit for ordinary use) are limited to one year from date of purchase. Some states/provinces do not allow limitations on how long an implied warranty lasts, so the above limitation might not apply to you. In no event shall the manufacturer be liable for any indirect, special, incidental, consequential, or similar damages (including, but not limited to lost profits or revenue, inability to use the PRODUCT or other associated equipment, the cost of substitute equipment, and claims by third parties) resulting from the use of this PRODUCT. Some states/provinces do not allow the exclusion or limitation of incidental or consequential damages, so the above limitation or exclusion might not apply to you.

Please retain your original sales receipt as proof of purchase.

Technical specifications

RF frequency band	1921.536MHz — 1928.448MHz
Channels	5
Telephone base voltage (AC voltage, 60Hz)	96 — 129 Vrms
Telephone base voltage (AC adapter output)	6VDC @600mA
Handset voltage	2.4 VDC, AAA x 2, Ni-MH
Charger voltage (AC adapter output)	6VDC @400mA
Operating times*	Talk time (handset): up to 7 hours Talk time (speakerphone): up to 5 hours Standby: up to 7 days

* Operating times vary depending on your actual use and the age of the battery.

DECT 6.0 digital technology

The AT&T DECT 6.0 products offer unsurpassed range performance and sound clarity. This is achieved through a unique antenna design and advances in noise-filtering technology. An independent laboratory has confirmed that AT&T DECT 6.0 products perform up to 45% better in range competitions against similarly equipped phones of the leading competition. Now, calls can be taken in the basement, backyard and garage with exceptional sound quality.

Telephone operating range

This cordless telephone operates within the maximum power allowed by the Federal Communications Commission (FCC). Even so, this handset and telephone base can communicate over a certain distance — which can vary with the locations of the telephone base and handset, the weather, and the construction of your home or office.

Redefining long range coverage and clarity

This telephone base comes with an antenna which gives much better clarity and covers a longer range than before.

HD audio

HD audio improves sound quality by expanding and rebuilding frequencies that are lost with traditional phone calls. There is no additional telephone service requirement to use HD audio. It is designed to work with standard telephone service. Your system will automatically enhance all received sound with HD audio.

Simulated full-duplex handset and base speakerphones

The simulated full-duplex speakerphones on your handset and telephone base allow both ends of a call to speak and be heard at the same time. Optimal performance is subject to external factors and individual usage.

Index

A

- Active devices, 24, 25, 27
- Add a Bluetooth headset, 23
- Add a cell phone, 21
- Add a handset, 129
- Alerts manager, 19
- Alert tones
 - handset, 134
 - telephone base, 135
- Announcement, 109–110
- Answer a cell call, 52
- Answer a home call, 50
- Answer an incoming call
 - during an intercom call, 72
 - during PTT, 82
- Answering system and voicemail, 118
- Answering system settings, 109–117
- Answer on/off, 111

B

- Battery backup mode, 14
- Battery charging, 11–12
- Battery installation, 11–13
- Bluetooth connection
 - from idle mode, 24
- Bluetooth features, 17–18
- Bluetooth glossary, 20
- Bluetooth setup, 21–31

C

- Call block
 - block calls without number, 108
 - delete entries, 108
 - edit entries, 107
 - mute first ring, 108
 - new entries, 103–104, 105–106
 - review entries, 105
- Call intercept, 121
- Call screening, 113, 120
- Call transfer, 73–75

Caller ID (CID)

- add entries to
 - phone directory, 98–99
- delete entries, 100
- dial entries, 97
- review entries, 96
- Caller ID announce, 40
- Caller ID manager, 19
- Cell alert, 49
- Cell call, 52
- Cell phone download directory, 28
- Cell ringer, 31
- Change a one-to-one PTT
 - to intercom call, 82
- Change PIN, 31
- Charger installation, 10
- Charging, 11–12
- Clear voicemail indicator/
 - indication, 42
- Clock, 39
- Conference calls, 56–57
- Connect an active device, 25
- Connect to Cell, 19

D

- Date, 39
- Delete
 - a call block entry, 108
 - a caller ID log entry, 100
 - a directory entry, 93
 - a redial entry, 66
- Delete a message, 123–125
- Directory
 - delete entries, 93
 - dial entries, 90
 - edit entries, 91–93
 - name search, 90
 - new entries, 85–88
 - review entries, 89–90

Index

Disconnect an active device, 25
Download directory, 28
DSL, 9

E

Edit the label of a directory entry, 93
Elapsed time, 50
End a cell call, 52
End a home call, 50
Equalizer, 60
Expand your telephone system, 129–130

F

Find handset, 67
Flash (switch hook flash), 53

H

Handset icons, 132
Handset lights, 136
Handset locator, 67
HD audio, 168
Headset, 23, 51
Home directory, 84

I

Icons
 handset, 132
 telephone base, 133
Important safety information, 160–162
Indicator lights, 136
Intercom, 69–75
Interruption to directory download, 30

L

Last number redial, 63
LCD language, 38
Lights, 136
Limited warranty, 166–167
Listening volume, 58, 123–124

M

Maintenance, 159
Make a cell call, 52
Make a home call, 50
Memory match, 95
Memos, 126
Message alert tone, 116
Message capacity, 119
Message playback, 122–125
Missed calls, 95
Mute, 59

N

No line alert, 49
Number of rings, 114

O

Operating range, 168
Outgoing announcement, 109–110

P

Paging, 67
Phonebook (directory), 84
Predial a cell call, 52
Predial a home call, 50
PTT, 76–83
Pulse dialing, 47
Push-to-talk, 76–83

Q

Quick reference guide, 2–8
Quiet mode, 48

R

Receive a cell call, 52
Receive a home call, 50
Record announcement, 110
Redial, 63–66
Remote access, 115, 127–128

Index

Remote voice control, 32–34
Remove a bluetooth device, 26
Repeat messages, 123–124
Replace a bluetooth device, 27
Replace a handset, 131
Review the active devices list, 25
Ringer tone, 37
Ringer volume, 36
Ringtone share, 17, 31

S

Safety information, 160–162
Save a caller ID log entry
 to call block list, 105–106
 to directory, 98–99
Screen messages, 137–141
Set date/time, 39
Share an outside call, 68, 73–75
Silence the ringer, 53
Skip messages, 123–124
Stop messages, 123–124

T

Take a call off mute, 59
Telephone base installation, 9
Telephone base lights, 136
Telephone operating range, 168
Temporary tone dialing, 59
Time, 39
Transfer a call, 73–75
Transfer a call from a handset
 to a headset, 51
Troubleshooting, 142–158
Turn on or off the answering
 system, 111

U

Use a Bluetooth headset, 51
Using the home and cell lines
 together, 57

V

View the directory download
 information, 30
Voice announce caller ID, 40
Voice control, 32–34
Voice guide, 112
Voicemail, 54, 118
Volume, 36, 58, 123–124

W

Wall-mounting, 15–16
Warranty, 166–167

Remote access wallet card

The wallet card lists the commands needed to control your answering system from any touch-tone telephone.

Cut along dotted line.



Call your telephone number, then enter your 2-digit remote access code (preset to **19**).

Action	Remote command
Play all messages	1
Play new messages.....	2
Delete the message	3 (during message playback)
Delete all old messages	33
Repeat or go back	4

Fold here.

Stop	5
Help menu	*5
Skip the message	6
Record announcement	*7
Turn system on or off	0
End remote access call	8 (or hang up)

TL96276/TL96456

DECT 6.0 cordless telephone/answering system with BLUETOOTH® wireless technology

© 2016 Advanced American Telephones. All Rights Reserved.
AT&T and the AT&T logo are trademarks of AT&T Intellectual Property licensed to Advanced American Telephones, San Antonio, TX 78219.
Printed in China.



www.telephones.att.com

The *Bluetooth*® word mark and logos are owned by Bluetooth SIG, Inc. and any use of such marks by Advanced American Telephones and its parent, VTech Holdings Limited, is under license. VTech Holdings Limited is a member of Bluetooth SIG, Inc. Other trademarks and trade names are those of their respective owners.

© 2016 Advanced American Telephones. All Rights Reserved.

AT&T and the AT&T logo are trademarks of AT&T Intellectual Property licensed to Advanced American Telephones, San Antonio, TX 78219.

iPhone® and Siri® are registered trademarks of Apple Inc.

Connect to Cell™ is a trademark of Advanced American Telephones.

Android® and Google Play® are registered trademarks of Google Inc.

Google Now™ is a trademark of Google Inc.

S Voice® is a registered mark of Samsung Electronics Co., Ltd.

RBRC® and 1-800-8-BATTERY® are registered trademarks of the Rechargeable Battery Recycling Corporation.

Printed in China. Issue 1.0 AT&T 05/16.