

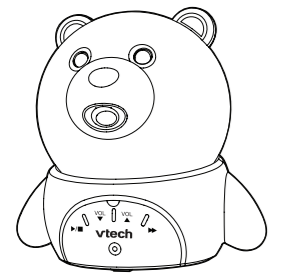

User's manual VM306

Accessory baby unit for use with VTech model VM341-216/VM346/VM346-2



Congratulations

on purchasing your new VTech product. Before using this product, please read **Important safety instructions**.

This manual has instructions on how to set up and pair your new baby unit. For complete instructions on using the baby unit, see the user's manual that comes with your video and audio monitor.

For support, shopping, and everything new at VTech, visit our website at www.vtechphones.com.

Register online to get an additional 3-month warranty!

Visit www.vtechphones.com.

Registration
Register your product online for enhanced warranty support.

Product news
Learn about the latest VTech products.

What's in the box

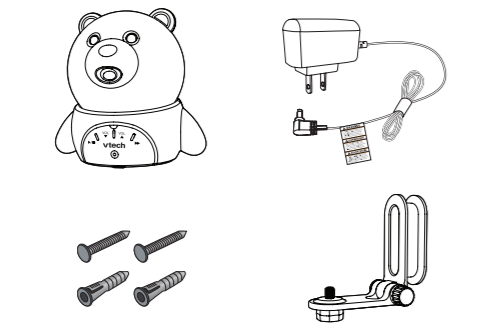

Connect the baby unit

NOTES

- Use only the power adapter supplied with this product.
- Make sure the electrical outlet is not controlled by a wall switch.
- The power adapter is intended to be correctly oriented in a vertical or floor mount position. The prongs are not designed to hold the plug in place if they are plugged into a ceiling, under-the-table or cabinet outlet.
- Make sure the baby unit and the power adapter cord are out of reach of children.

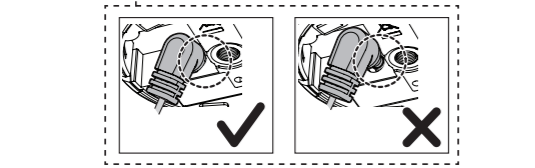
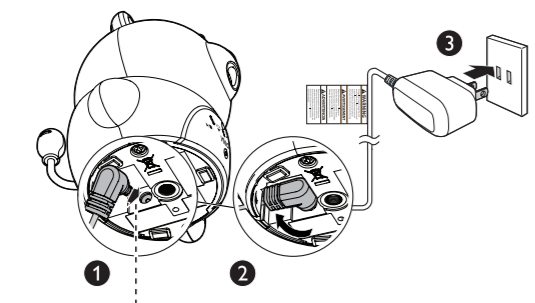

Overview

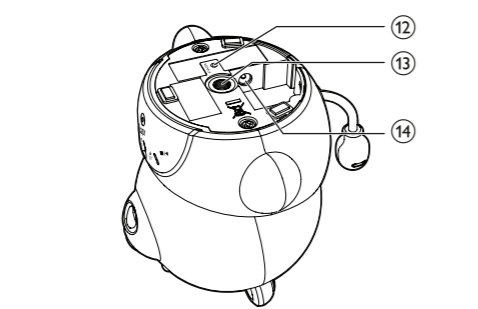
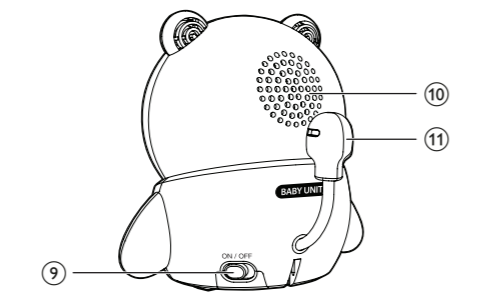
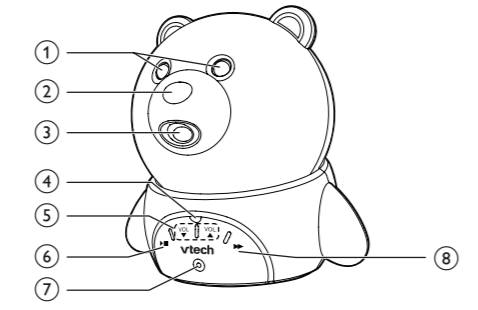

1	Infrared LEDs
2	Light sensor
3	Camera
4	ON/OFF light <ul style="list-style-type: none">On when the baby unit is turned on and is paired to the parent unit.Flashes when the baby unit is not being viewed; or when the link to the parent unit is lost.
5	▼/VOL/▲ <ul style="list-style-type: none">Press to adjust the speaker volume. It determines the lullaby volume and talkback volume transmitted from parent unit.
6	▶/■ Play/Stop <ul style="list-style-type: none">Press to play or stop lullaby on the baby unit.
7	Microphone
8	▶▶ Skip <ul style="list-style-type: none">Press to play the next lullaby.
9	ON/OFF switch <ul style="list-style-type: none">Slide to turn on or off the baby unit.
10	Speaker
11	Temperature sensor
12	PAIR <ul style="list-style-type: none">Press and hold to pair to the parent unit.
13	Threaded socket <ul style="list-style-type: none">For wall mount installation use.
14	Power jack

Before use

Pair extra new baby unit

Each newly purchased baby unit (VM306) must be paired to your video and audio monitor system (VM341-216/VM346/VM346-2).

- You can pair a maximum of four baby units to your parent unit. Each new baby unit must be paired to the parent unit before use.
- Make sure you power on the parent unit before pairing.

- Press **MENU** when the parent unit is idle.
- Press ▼ or ▲ to choose **Pair/Unpair CAM**, then press **SELECT**.
- Press **SELECT** again to choose **Pair CAM**.
- Press ▼ or ▲ to choose an empty baby unit slot, then press **SELECT**.
- The parent unit screen displays **Press and hold the pair button at the CAM for 5 seconds until the power indicator flashes..** Immediately press and hold **PAIR** on the bottom of the baby unit. The LED light flashes quickly.

When pairing is successful, the screen displays the view of newly paired baby unit in **SINGLE-CAM** mode. The LED light on the new baby unit remains on.

- If pairing fails, the screen displays **Pairing failed.** Try the pairing process again.
- Only one baby unit can be paired at a time.

Positioning the baby monitor

CAUTION

- Keep the baby units out of the reach of your baby. Never place or mount the baby units inside the baby's crib or playpen.

NOTE

- To avoid interference from other electronic devices, place your baby monitor far away from devices such as wireless routers, microwaves, cell phones and computers.

- Place the baby units more than 1 meter (3 feet) away from your baby. Adjust the angle of the camera to aim at your baby.

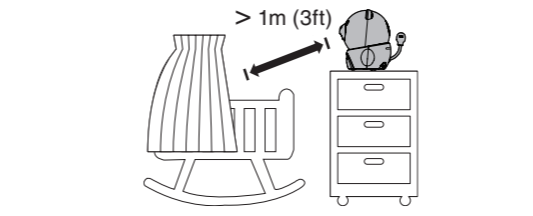

- Place the parent unit more than 1 meter (3 feet) away from the baby units.

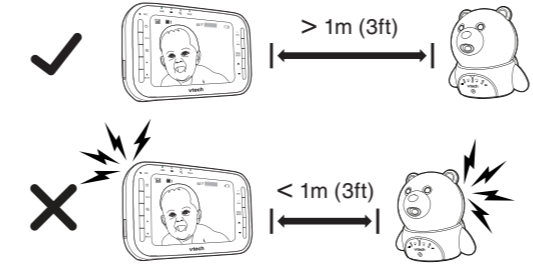

CAUTION

- The default volume of your parent unit is level 4. If you experience high-pitched screeching noise from your baby monitor while positioning:
 - Make sure your baby units and parent unit are more than 1 meter (3 feet) apart, OR
 - Turn down the volume of your parent unit.

Mount the baby monitor (optional)

NOTE

- Check for reception strength and camera angle before drilling the holes.

- Place the wall mount bracket on a wall and then use a pencil to mark the top and the bottom holes as shown. Remove the wall mount bracket and drill two holes in the wall (7/32 inch drill bit).

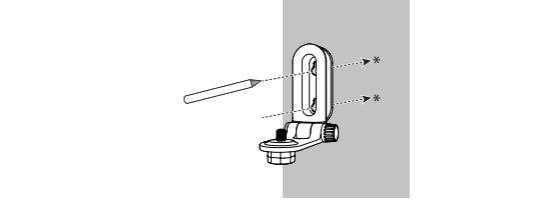

- If you drill the holes into a stud, go to step 3.

-OR-

If you drill the holes into an object other than a stud, insert the wall anchors into the holes. Tap gently on the ends with a hammer until the wall anchors are flush with the wall.

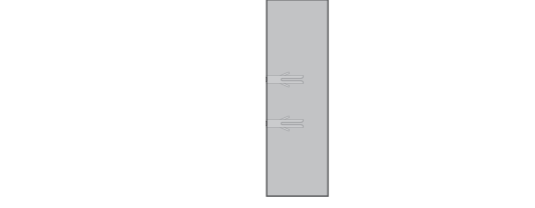

- Align the wall mount bracket and screws with the holes in the wall as shown. Tighten the screw in the middle hole first, so that the wall mount bracket position is fixed. You can tighten the other screw in the top hole.

Place the baby unit on the wall mount bracket. Tighten the screw into the threaded socket at the bottom to secure the baby unit.

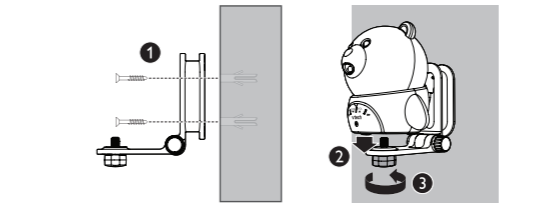

-OR-

Insert the screws into the holes and tighten the screws until only 1/4 inch of the screws are exposed.

Place the baby unit on the wall mount bracket. Tighten the screw into the threaded socket at the bottom to secure the baby unit. Align the holes on the wall mount bracket with the screws on the wall, and slide the wall mount bracket down until it locks into place.

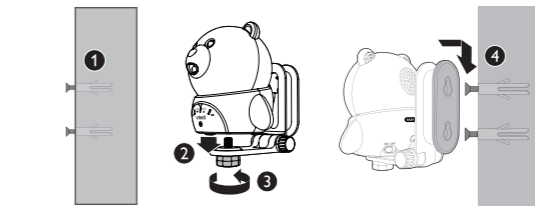

- The default angle of the wall mount bracket is 90 degrees. You can maximize your baby unit's viewing angles by tilting the wall mount bracket.

Hold the baby unit, and then rotate the knob in anticlockwise direction. This will loosen the joint of the wall mount bracket. Tilt your baby unit up or down to adjust to your preferred angle. Then, rotate the knob in clockwise direction to tighten the joint and secure the angle.

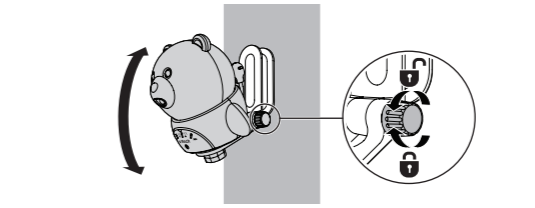

Operating range

The operating range of the baby monitor is up to 300 meters (1,000 feet) outdoors or 50 meters (160 feet) indoors. The actual operating range may vary depending on the environmental conditions and other interferences such as walls, doors and other obstructions.

Unpair a baby unit

NOTE

Make sure you power on the baby unit and the parent unit before unpairing the baby unit.

- Press **MENU** when the parent unit is idle.
- Press ▼ or ▲ to choose **Pair/Unpair CAM**, then press **SELECT**.
- Press ▼ or ▲ to choose **Unpair CAM**, then press **SELECT**.
- Press ▼ or ▲ to choose a desired baby unit, then press **SELECT**.
- The screen displays **To unpair CAM X, press the [ZOOM] key at the Parent Unit..** Press **Q** on the parent unit.
- The screen displays **Then, press the [MENU/SELECT] key to confirm..** Press **SELECT** to continue.
- When unpairing is successful, the screen displays **CAM X is unpaired** and returns to previous menu. If there is no paired baby unit, the screen displays **No CAM is paired.** The LED light on the selected baby unit flashes slowly.

General product care

To keep this product working well and looking good, follow these guidelines:

- Avoid putting it near heating appliances and devices that generate electrical noise (for example, motors or fluorescent lamps).
- DO NOT expose it to direct sunlight or moisture.
- Avoid dropping the product or treating it roughly.
- Clean with a soft cloth.
- DO NOT immerse the baby unit in water and do not clean them under the tap.
- DO NOT use cleaning spray or liquid cleaners.
- Make sure the baby unit is dry before you connect them to the mains again.

Important safety instructions

When using your equipment, basic safety precautions should always be followed to reduce the risk of fire, electric shock and injury, including the following:

- Follow all warnings and instructions marked on the product.
- Adult setup is required.
- This product is intended as an aid. It is not a substitute for responsible and proper adult supervision and should not be used as such.
- This product is not intended for use as a medical monitor.
- Do not use this product near water. For example, do not use it next to a bath tub, wash bowl, kitchen sink, laundry tub or swimming pool, or in a wet basement or shower.
- Use only the adapters included with this product. Incorrect adapter polarity or voltage can seriously damage the product. Baby unit power adapter: Output: 5V DC 1A
- The power adapters are intended to be correctly oriented in a vertical or floor mount position. The prongs are not designed to hold the plug in place if it is plugged into a ceiling, under-the-table or cabinet outlet.
- For pluggable equipment, the socket-outlet shall be installed near the equipment and shall be easily accessible.
- Unplug this product from the wall outlet before cleaning. Do not use liquid or aerosol cleaners. Use a damp cloth for cleaning.
- Do not cut off the power adapters to replace them with other plugs, as this causes a hazardous situation.
- Do not allow anything to rest on the power cords. Do not install this product where the cords may be walked on or crimped.
- This product should be operated only from the type of power source indicated on the marking label. If you are not sure of the type of power supply in your home, consult your dealer or local power company.
- Do not overload wall outlets or use an extension cord.
- Do not place this product on an unstable table, shelf, stand or other unstable surfaces.
- This product should not be placed in any area where proper ventilation is not provided. Slots and openings in the back or bottom of this product are provided for ventilation. To protect them from overheating, these openings must not be blocked by placing the product on a soft surface such as a bed, sofa or rug. This product should never be placed near or over a radiator or heat register.

