

Go to  
**businessphones.vtech.com**  
to register your product for  
enhanced warranty support and  
the latest VTech product news.

**VH6220**

Over-the-ear Office  
Wireless Headset

**VH6221**

Over-the-ear Office  
Wireless Headset  
with Lifter

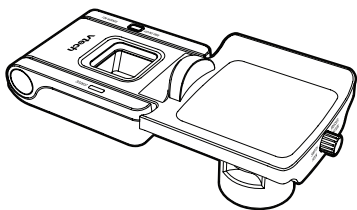
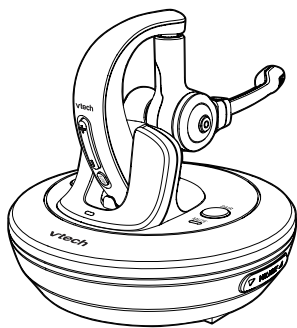

**vtech**®

Abridged user's manual

# Congratulations

on your purchase of this VTech product. Before using this product, please read the **Important safety information**.

This Abridged user's manual provides you with the basic installation and use instructions. A limited set of features are described in abbreviated form.

Visit **[businessphones.vtech.com/support/downloads](https://businessphones.vtech.com/support/downloads)** to download a full set of installation and operation instructions.

- **Headset connection methods**

**"Option 1: Connect to IP phone via EHS"**

**"Option 2: Connect to traditional corded phone"**

**"Option 3: Connect to traditional corded phone with Lifter"**

**"Option 4: Connect to a computer"**

- **The software application**

**"Software application - Installation and Operation Guide"**

For customer service or product information, visit our website at **[businessphones.vtech.com](https://businessphones.vtech.com)** or call **1 (800) 595-9511**. In Canada, please dial **1 (800) 267-7377**.

**For VH6221/VH6220 headset:**

HVIN: 35-800001HD

FCC ID: EW780-1360-00

IC: 1135B-80136000

# Introduction

The **VH6220/VH6221** includes a wireless headset and base that allow you to have handsfree phone conversations.

The package also comes with the EHS (Electronic Hookswitch) cables. They let you connect the wireless headset to an IP phone, and make and answer telephone calls via the headset.

The EHS cable 1 connects the headset to a SNOM D3 series, or SNOM D735/785 IP phone. The EHS cable 2 connects the headset to a SNOM D7 series IP phone, excluding SNOM D735/D785.

With the EHS cables and headset audio cable, you can connect your headset using either one or both of the following methods:

- **PHONE mode - Connect to a deskphone**

If you want to connect your headset to a deskphone, you can simply use the cables provided to connect the headset to a deskphone directly.

- **PC mode - Connect to a computer**

Use the USB cable to connect the headset base and your PC. You can make and receive VoIP calls through Skype<sup>®\*</sup> or Skype for Business<sup>®</sup>, using the **VTech Control** software application.

## **VH6221 Convertible Office Wireless Headset with Lifter:**

The **VH6221** package also comes with the extra corded handset lifter, making it convenient to answer and end calls right from the headset, so that the product can be used in different ways depending on your needs.

For lifter's information, refer to the section **Lifter**.

Skype<sup>®</sup> and Skype for Business<sup>®</sup> are registered trademarks of Microsoft Corporation.

\* The **VTech Control** supports Skype version 7.1-7.40. Later versions of Skype are not supported by VTech Control for remote headset call control.

# What's in the box

Your product package contains the following items. Save your sales receipt and original packaging in the event warranty service is necessary.

## For VH6220/VH6221:



Abridged user's manual

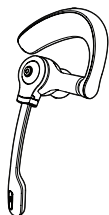

Wireless headset

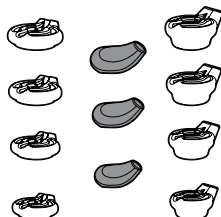

Earbuds

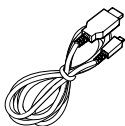

USB cable



Headset base



Headset base power adapter

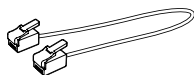

EHS cable 1

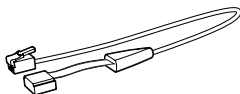

EHS cable 2

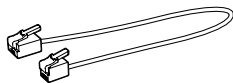

Headset audio cable

# What's in the box

**For VH6221 only:**

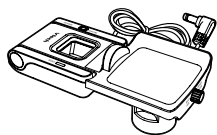

Corded handset lifter

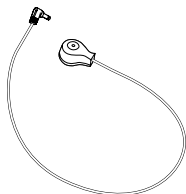

Auxiliary ring detector

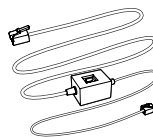

Corded phone connection cable

# Table of contents

## Overview

Headset overview.....	1
Headset base.....	2
Power up the headset base .....	4
Charge the headset battery .....	4
Connection methods.....	5
PHONE mode .....	5
PC mode .....	5
Option 1: Connect to IP phone via EHS .....	6
Option 2: Connect to a traditional corded phone (for VH6221 only) .....	7
Option 3: Connect to a traditional corded phone with Lifter (for VH6221 only) ....	7
Option 4: Connect to a computer .....	7
Wear the headset.....	8
Attach the earbud and wear the headset.....	8

## Before use

Headset operation.....	9
Headset power on/off.....	9
PHONE mode and PC mode...9	

## Operate

PHONE mode.....	10
Operate with IP phone via EHS.....	10
Operate with corded phone (for VH6221 only) .....	11
Operate with corded phone via Lifter (for VH6221 only) .....	11

PC mode.....	12
Call settings .....	13
Auto Answer .....	13
Change Audio Bandwidth .....	13
Adjust the headset earpiece audio.....	14
Headset ringer .....	15
Anti-Startle (G616) .....	15
Temporary ringer silencing...	16
Volume control .....	16
Mute.....	16

## Lifter (for VH6221 only)

Overview .....	17
Connect the Lifter .....	19
Operate with Lifter.....	19

## Appendix

Adding and registering a new headset.....	20
Headset lights.....	21
Headset alert tones .....	22
Headset alert prompts.....	22
Headset base lights .....	23
Frequently asked questions .....	24
Maintenance .....	30
Important safety information .....	31
Safety information .....	31
Especially about wireless headsets .....	32
Precautions for users of implanted cardiac pacemakers .....	33
For C-UL compliance .....	34
Mesures de sécurité importantes .....	34

FCC Part 68 and ACTA .....	38
FCC Part 15 .....	40
California Energy Commission battery charging testing instructions.....	41
Limited warranty .....	42
Disclaimer and Limitation of Liability .....	45
Technical specifications.....	46

# Overview

## Headset overview

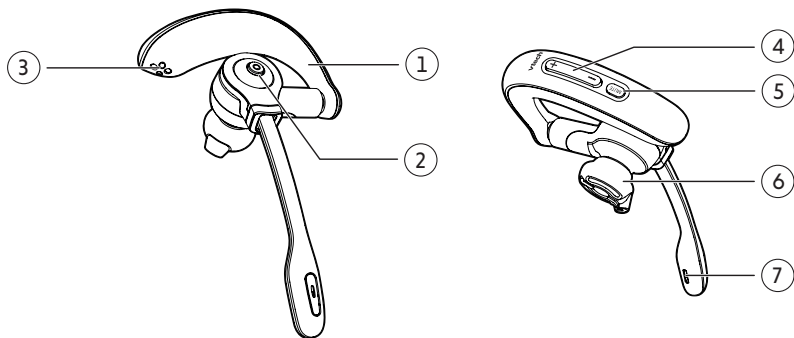

### 1 – Ear hook

### 2 – ON/OFF button and LED light

- Press to make, answer or end a call.
- See **Headset lights** for lights behavior.

### 3 – Magnetic charging contacts

### 4 – + (Volume up) / - (Volume down)

- Press to adjust the headset ringer volume while in idle mode, or the listening volume while on a call.

### 5 – MUTE

- Mute the microphone during a call.

### 6 – Earpiece

### 7 – Microphone



# Overview

## Headset base

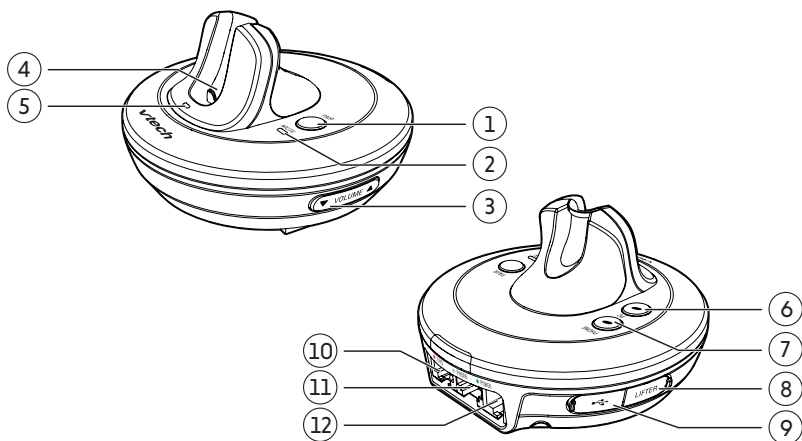

### 1 – PAIR

- Press to initiate headset registration or deregistration.

### 2 – MUTE (light)

- See **Headset base lights** for lights behavior.

### 3 – ▼ VOLUME ▲

- Press to adjust the speaking volume while on a call.

### 4 – Magnetic charging mount

- Place the headset here for charging.

### 5 – Charging LED

### 6 – PC (mode button and light)

- Press to enter the **PC** mode. See **Headset base lights** for lights behavior.

### 7 – PHONE (mode button and light)

- Press to enter the **PHONE** mode. See **Headset base lights** for lights behavior.

### 8 – LIFTER jack (for VH6221 only)

### 9 – (USB port)

- Open the port cover to plug in the USB cable for use with PC mode.

### 10 – EHS jack (red dot)

### 11 – PHONE jack (blue dot)

### 12 – POWER jack (green dot)

# Overview

## Headset base

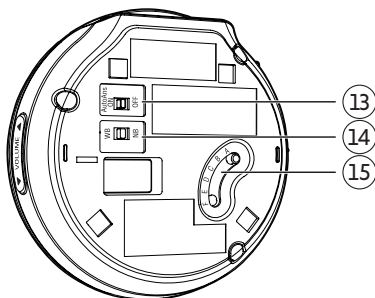

### 13 – AutoAns ON/OFF

- When turned on, your headset will then automatically answer a call when it is lifted from the charging cradle.

### 14 – WB (Wideband) / NB (Narrowband) Switch

- Use this switch to adjust the audio bandwidth. Wideband audio delivers wider frequency response and higher HD audio quality.

### 15 – Audio Adjustment Switch

- When you have connected the headset base to a deskphone, use this switch to adjust the headset earpiece audio between **A** and **F**, until the dial tone is clear.

#### NOTES

- The default setting of the Audio Adjustment Switch is **A**.
- The audio adjustment setting is dependent on
  - the types of deskphones to which the headset base is connected; and
  - the interference caused by other DECT systems operating in the same environment.

# Getting started

## Power up the headset base

1. Plug the small end of the headset base power adapter labelled **POWER JACK (ON HEADSET BASE)** to the ● **POWER** jack (green dot) at the rear of the headset base.
2. Plug the large end into an electrical outlet not controlled by a wall switch.

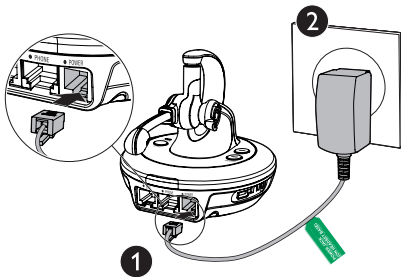

## Charge the headset battery

Hang the headset onto the magnetic charging mount. The magnet holds the headset in place.

- The charging LED on the base will turn steady red while charging.

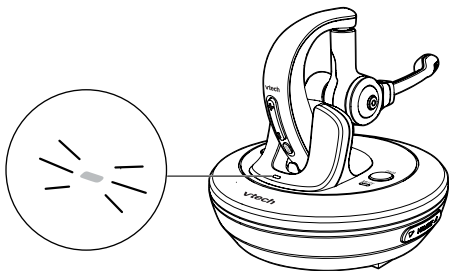

### NOTE

- For optimal performance, charge the headset battery for at least 30 minutes before use. The battery is fully charged after 2 hours of continuous charging. When the headset is not in use, recharge by hanging it onto the headset base.

# Getting started

## Connection methods

Choose one of the following methods to connect your headset for operation in either **PHONE** mode or **PC** mode.

### PHONE mode

---

#### Option 1: Connect to IP phone via EHS

- You can connect the headset to an IP phone using the EHS cable and headset audio cable provided. The headset acts as a supplementary device that can join calls. Use the IP phone connected to make or answer calls.

#### Option 2: Connect to traditional corded phone (for VH6221 only)

- You can connect the headset to a traditional corded phone using the corded phone connection cable provided. You need to physically lift the corded handset off the corded phone base cradle before you can use the headset to join in the call.

#### Option 3: Connect to traditional corded phone with Lifter (for VH6221 only)

- You can connect the headset to a corded phone using the corded phone connection cable and lifter provided (see **Connect the Lifter**). The headset acts as a supplementary device that can join calls. You can simply press  on the headset to use the connected corded phone to make or answer calls.

### PC mode

---

#### Option 4: Connect to a computer

- Connect the headset base to your PC with the USB cable provided. You can make and receive VoIP calls through Skype or Skype for Business, using the software application.

#### NOTE

- The cords have colored labels that guide you to plug them into the correct headset base jacks. The back of the headset base has color-coded dots and the names of the jacks above them that correspond to the colored labels on the cords.

# Getting started

## Connection methods



For detailed instructions of the four options to connect your headset, visit the product page of **VH6220** or **VH6221** at **[businessphones.vtech.com/support/downloads](http://businessphones.vtech.com/support/downloads)** to download the respective instructional document.

### Option 1: Connect to IP phone via EHS

Connect the headset to an IP phone using the EHS cable and headset audio cable provided. Depending on the brand and series of your IP phone, you might need to use either **EHS cable 1** or **EHS cable 2** for connection.

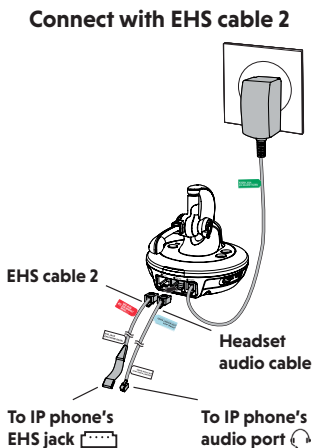
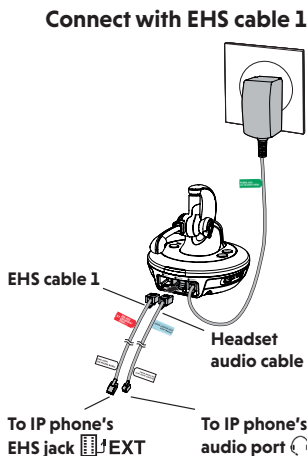
Visit **[businessphones.vtech.com](http://businessphones.vtech.com)** for the compatibility list of IP phone models that are compatible for EHS connection, as well as the respective EHS adapter(s) that you need to purchase separately.



After connect, press  on your IP Phone to turn on the headset mode. The LED light on the  key will turn on or the  status icon will display.

### Test the headset after connection:

Press the  **ON/OFF** button on the headset to make, answer, or end a call, using the telephone line to which the IP phone is connected.

# Getting started

## Connection methods

### Option 2: Connect to a traditional corded phone (for VH6221 only)

---

Use the corded phone connection cable provided to connect the headset to a traditional corded phone.

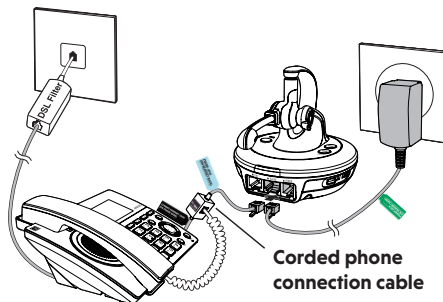

### Option 3: Connect to a traditional corded phone with Lifter (for VH6221 only)

---

Use the corded phone connection cable and lifter provided to connect the headset to a traditional corded phone.

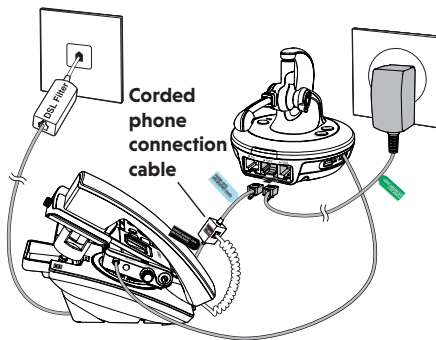

### Option 4: Connect to a computer

---

Use the USB cable provided to connect the headset to your computer. Your headset supports calls through Skype or Skype for Business. Install the software application before operating in **PC mode**.

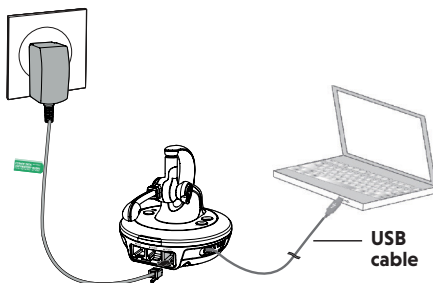

# Getting started

## Wear the headset

### Attach the earbud and wear the headset

---

1. Insert the earbuds to check the best fitting. Remove them from your ear after checking.

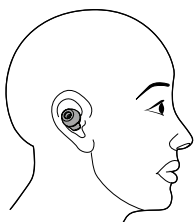

2. Insert your desired earbud to the headset.
  - Make sure the protruding bump is pointing towards your mouth when placed on your ear. The protruding bump on the earbud holds the headset securely in your ear.

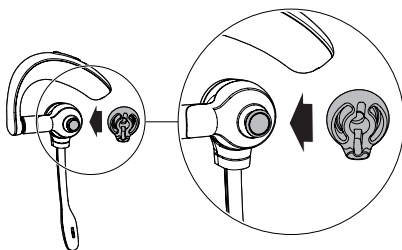

3. Adjust the angle of the headset to fit your ear, and then hook the headset on your ear.
  - The microphone should be pointing towards your mouth, as close to your cheek as possible without touching.



## Before use

### Headset operation

#### Headset power on/off

---

##### To power on the headset:

- Place the headset in the headset base.

**-OR-**

- Press and hold  **ON/OFF** button for two seconds.

The  LED light flashes blue three times, and you hear three beeps when it is being powered on.

##### To power off the headset:

- Press and hold  **ON/OFF** button for four seconds.

The  LED light flashes red three times, and you hear three beeps when it is being powered off.

#### PHONE mode and PC mode

---

Before using the headset, make sure you have chosen the headset operation mode in accordance with the connection method. When the headset is not in use, you can choose between PHONE mode and PC mode.

##### To choose PHONE mode:

- Press the **PHONE** button on the headset base. The **PHONE** light turns on.

##### To choose PC mode:

- Press the **PC** button on the headset base. The **PC** light turns on.

#### NOTE

- You can also switch back and forth between **PHONE** mode and **PC** mode while on a call. Once selected, the **PHONE** mode light or the **PC** mode light flashes twice every three seconds to indicate that line is in use.



# Operate

## PHONE mode

Before using the headset with your telephone connected, make sure you have chosen **PHONE** mode.

### To choose PHONE mode:

- Press the **PHONE** button on the headset base. The **PHONE** light turns on.

## Operate with IP phone via EHS

---

### To make a call:

1. Press the  **ON/OFF** button on the headset. The EHS connection automatically takes the phone line at your IP phone.
  - When you hear a clear dial tone at the headset earpiece, you are now ready to dial a call.
  - If the dial tone is unclear or you do not hear a dial tone, slide the Audio Adjustment Switch at the bottom of the headset base between **A** and **F**, until the dial tone is clear.

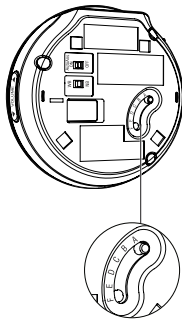

The default setting of the Audio Adjustment Switch is **A**.

2. Dial the telephone number using the dialing keys on the IP phone.

### NOTES

- The audio adjustment setting is dependent on
  - the types of deskphones to which the headset base is connected; and
  - the interference caused by other DECT systems operating in the same environment.
- The headset supports hot swapping, in which the current call on the headset will remain connected if you replace the battery within five minutes.

### To answer a call:

- Press the  **ON/OFF** button on the headset to answer an incoming call, or lift the headset if auto answer is set to on.

The EHS connection automatically takes the line on your IP phone. You hear the caller through the headset earpiece.

### To end a call:

- Press the  **ON/OFF** button on the headset to end a call. The EHS connection automatically releases the line on your IP phone.

# Operate

## PHONE mode

### Operate with traditional corded phone (for VH6221 only)

---

#### To make a call:

1. Lift the corded handset to take the line at your corded phone.
2. Press the **Ⓞ ON/OFF** button on the headset.
  - When you hear a clear dial tone at the headset earpiece, you are now ready to dial a call.
  - If the dial tone is unclear or you do not hear a dial tone, slide the Audio Adjustment Switch at the bottom of the headset base between **A** and **F**, until the dial tone is clear.  
The default setting of the Audio Adjustment Switch is **A**.
3. Dial the telephone number using dialing keys on the corded phone.

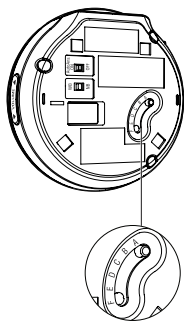

#### NOTES

- The audio adjustment setting is dependent on
  - the types of deskphones to which the headset base is connected; and
  - the interference caused by other DECT systems operating in the same environment.
- The headset supports hot swapping, in which the current call on the headset will remain connected if you replace the battery within five minutes.

#### To answer a call:

1. Lift the corded handset to take the line at your corded phone.
2. Press the **Ⓞ ON/OFF** button on the headset to answer an incoming call.  
You hear the caller through the headset earpiece.

#### To end a call:

1. Press the **Ⓞ ON/OFF** button on the headset to leave the phone conversation at the headset.
2. Place the corded handset back to the corded phone to end the call.

### Operate with traditional corded phone via Lifter (for VH6221 only)

---

For calls operation with a traditional corded phone via Lifter, see **Operate with Lifter**.

# Operate

## PC mode

Make sure you have used the USB cable provided to connect the headset to your computer, have chosen **PC mode** at the headset base, and have already installed the **VTech Control** on your computer before you use your headset.

Download the **VTech Control** application and its **Installation and Operation Guide** at [businessphones.vtech.com/support/downloads](http://businessphones.vtech.com/support/downloads), under the product page of **VH6220** or **VH6221**.

Unzip and install the application after download

## Make and receive calls

---

You can make and receive VoIP calls with your **VTech Control** through Skype and Skype for Business.

## Caller ID announce

---

The Caller ID announce feature with your **VTech Control** lets you know who is calling without having to look at the display.

# Operate

## Call settings

### Auto Answer

---

When the Auto Answer feature is enabled, your headset will automatically answer a call when it is lifted from the charging cradle.

#### To turn the Auto Answer feature on:

- Slide the **AutoAns** knob at the headset bottom to **ON**.

#### To turn the Auto Answer feature off:

- Slide the **AutoAns** knob at the headset bottom to **OFF**.

#### NOTE

- If you connected the headset only to a traditional corded phone, the Auto Answer feature will not apply.

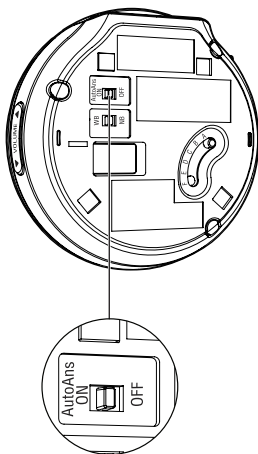

### Change Audio Bandwidth

---

The wideband audio mode works only if the telephone to which your headset is connected supports wideband audio.

When you slide the audio bandwidth from **NB** (Narrowband) to **WB** (Wideband), the frequency response of a call will be widened and the HD audio quality will be enhanced, whilst the battery power consumption will also be increased, thereby resulting in reduced talk time.

#### NOTE

- If you are not certain whether the telephone to which your headset is connected supports wideband audio, keep the audio bandwidth as **NB**.

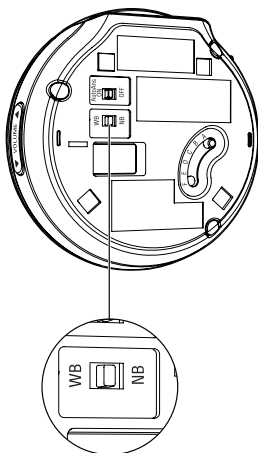

# Operate

## Call settings

### Adjust the headset earpiece audio

---

During a call, you may need to slide the audio adjustment switch at the bottom of the headset base to adjust for clear audio at the headset earpiece, when there is interference caused by other DECT systems operating in the same environment.

#### To adjust the headset earpiece audio during a call:

- Slide the audio adjustment switch at the bottom of the headset base between **A** and **F**, until the dial tone is clear.

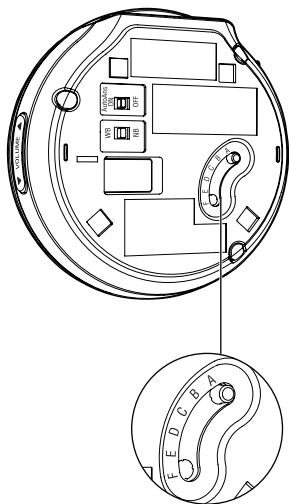

# Setting

## Sound settings

### Headset ringer

---

The headset base and headset do not have external ringers. When you receive calls, the headset earpiece rings.

#### To change the volume of the earpiece ringer:

- Press + or - when the headset is not in use.

#### To turn off the earpiece ringer:

- Press - until you hear two beeps when the headset is not in use.

### Anti-Startle (G616)

---

G616 Acoustic Limiting provides additional hearing protection against acoustic shock. By default, this feature is disabled.

When this feature is enabled, the headset limits sound levels at 102 dBA as recommended in the G616: 2006 guideline issued by the Australian Communications Industry Forum (ACIF).

When this feature is disabled, the headset limits sound levels at 118 dBA to protect your hearing.

#### To enable the G616 Audio Limiting:

- Press the following headset keys in sequence:

⊗, VOL-, VOL+, ⊗, VOL-, VOL+, ⊗

The ⊗ LED light on the headset will flash purple once and flash blue twice. You will also hear a confirmation tone.

#### To disable the G616 Audio Limiting:

- Press the following headset keys in sequence:

⊗, VOL-, VOL+, ⊗, VOL+, VOL-, ⊗

The ⊗ LED light on the headset will flash purple once and flash red twice. You will also hear a confirmation tone.

# Setting

## Sound settings

### Temporary ringer silencing

---

Press **MUTE** on the ringing headset to temporarily silence the ringer in the headset earpiece without disconnecting the call. The next incoming call rings normally at the preset volume.

### Volume control

---

#### To adjust the listening volume during a call:

- Press **+** or **-** to adjust the listening volume of that headset.

#### To adjust the speaking volume during a call:

- Press **▼/VOLUME/▲** on the right side of the headset base to adjust the speaking volume for all registered headsets.



Prolonged exposure to high volume levels using the headset may damage your hearing.

### Mute

---

The mute function turns off the microphone. You can hear the caller, but the caller cannot hear you.

#### To mute a call:

- Press **MUTE** on the headset to turn off the microphone.

You hear the voice prompt *"Mute on"*. The **MUTE** light on the headset base flashes and a short beep plays every 30 seconds.

#### To take a call off mute:

- Press **MUTE** on the headset to resume the conversation.

You hear the voice prompt *"Mute off"*.

# Lifter (for VH6221 only)

## Overview

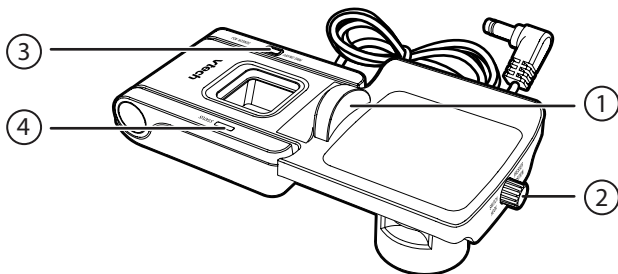

### 1 – Small lifter pad

- Holds the earpiece of the corded telephone handset.

### 2 – Switch hook presser adjustment knob

- Adjusts the position of the switch hook presser.

### 3 – RING ON/OFF

- Press to turn the ring detector on or off. When the ring detector is off, the wireless headset does not ring.

### 4 – STATUS light

Red	<ul style="list-style-type: none"><li>• On when the headset is not in use and the ring detector is turned off.</li><li>• Flashes slowly when the headset is in use and the ring detector is turned off.</li></ul>
Blue	<ul style="list-style-type: none"><li>• On when the headset is not in use and the ring detector is turned on.</li><li>• Flashes four times every three seconds when the ring detector detects an incoming call.</li><li>• Flashes slowly when the headset is in use and the ring detector is turned on.</li></ul>
Off	<ul style="list-style-type: none"><li>• The headset base does not have power.</li><li>• The lifter control cable is not plugged into the <b>LIFTER</b> jack on the headset base.</li></ul>



# Lifter

## Overview

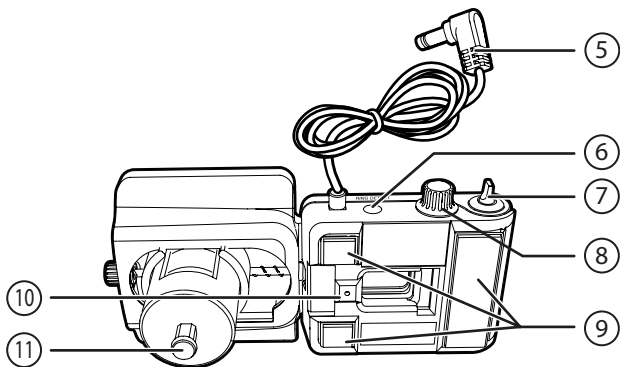

### 5 – Lifter control cable

- Plug this cable into the **LIFTER** jack on the headset base.

### 6 – RING DETECT jack

- Plug in the auxiliary ring detector.

### 7 – SENSOR ADJ knob

- Adjusts the sensitivity of the ring detector.

### 8 – ADJUST LIFTER knob

- Adjusts the height of the lifter arm.

### 9 – Adhesive tapes

- Remove the protective strips before attaching the lifter to the telephone base.

### 10 – Internal ringer detector

- Detects the telephone ringer and sends a ring tone to the headset earpiece.

### 11 – Switch hook presser

- Pressing  on the headset raises or lowers the switch hook presser.

# Lifter

## Connect the Lifter

For conceptual reference of the connection to a traditional corded phone with Lifter, see **Connection methods**.

## Operate with Lifter

### To make a call:

1. Press the  **ON/OFF** button on the headset. The lifter's switch hook presser rises and releases the switch hook.
  - When you hear a clear dial tone at the headset earpiece, you are now ready to dial a call.
  - If the dial tone is unclear or you do not hear a dial tone, slide the Audio Adjustment Switch at the bottom of the headset base between **A** and **F**, until the dial tone is clear.  
The default setting of the Audio Adjustment Switch is **A**.
2. Dial the telephone number using dialing keys on the corded phone.

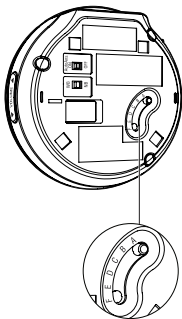

### NOTES

- The audio adjustment setting is dependent on
  - the types of deskphones to which the headset base is connected; and
  - the interference caused by other DECT systems operating in the same environment.
- The headset supports hot swapping, in which the current call on the headset will remain connected if you replace the battery within five minutes.

### To answer a call:

- Press the  **ON/OFF** button on the headset to answer an incoming call, or lift the headset if auto answer is set to on.

The lifter's switch hook presser rises and releases the switch hook. You hear the caller through the headset earpiece.

### To end a call:

- Press the  **ON/OFF** button on the headset to end a call. The lifter's switch hook presser pushes down the switch hook and ends the call.

## Appendix

### **Adding and registering a new headset**

The **VH6220/VH6221** Convertible Office Wireless Headset comes pre-registered to the headset base. You can add one more **VH622** Convertible Office Wireless Accessory Headset to your **VH6220/VH6221** system.

For more details, refer to the user's manual that comes with your new **VH622** Convertible Office Wireless Accessory Headset.

## Appendix

### Headset lights

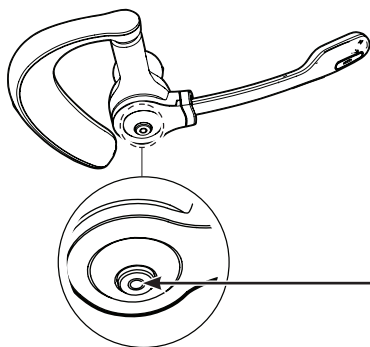

 **ON/OFF button and LED light**

Press to make, answer or end a call.

COLOR	LED LIGHT STATUS	MEANING
Red	Steady light on	The battery is low and the headset is charging in the headset base.
	Flash every 10 seconds	The battery is low and the headset is not in the headset base.
	Flash 3 times	Powering off.
Blue	Steady light on	The battery is fully charged.
	Flash every 10 seconds	The headset is not in the headset base.
	Flash 2 times every 3 seconds	The headset is in use.
	Flash 3 times	Powering on.
	Flash 4 times every 4 seconds	There is an incoming call.
Purple	Steady light on	The battery is well charged.
Red and blue	Alternate slowly	The headset is not registered.
	Alternate quickly	The headset is trying to register to a headset base.
Off	Light off	The battery is depleted.
		No battery is installed.
		The headset is powered off.



# Appendix

## Headset alert

### Headset alert tones

ALERT TONE BEHAVIOR	MEANING
One short beep every 30 seconds	<ul style="list-style-type: none"><li>The microphone is muted.</li></ul>
Two beeps	<ul style="list-style-type: none"><li>Error alert tone.</li><li>The speaking volume has reached its highest or lowest setting.</li><li>Any key is pressed while the headset is out of range.</li></ul>
Two low beeps	<ul style="list-style-type: none"><li>Call waiting alert tone.</li></ul>
Two rapid beeps every 20 seconds	<ul style="list-style-type: none"><li>Low battery warning.</li></ul>
Three rapid beeps every 20 seconds	<ul style="list-style-type: none"><li>The headset is out of range.</li></ul>
Three rapid beeps	<ul style="list-style-type: none"><li>The headset is powering on or off.</li></ul>

### Headset alert prompts

ALERT PROMPT	MEANING
<i>"Mute on"</i>	<ul style="list-style-type: none"><li>The microphone is muted.</li></ul>
<i>"Mute off"</i>	<ul style="list-style-type: none"><li>The microphone is re-activated.</li></ul>
<i>"Not registered"</i>	<ul style="list-style-type: none"><li> <b>ON/OFF</b> button is pressed while the headset is not registered.</li></ul>
<i>"Out of range"</i>	<ul style="list-style-type: none"><li>The headset is on a call and out of range.</li><li>Any key is pressed while the headset is out of range.</li></ul>
<i>"Low battery"</i>	<ul style="list-style-type: none"><li> <b>ON/OFF</b> button is pressed while the headset battery is low.</li></ul>

# Appendix

## Headset base lights

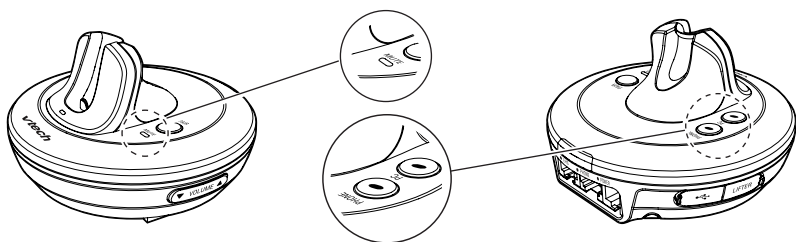

LIGHT	COLOR	LED LIGHT STATUS	MEANING
<b>MUTE</b>	Red	Steady light on	You are registering a headset.
		Flash	You are deregistering headset(s) from the headset base.
			The call is muted.
<b>PHONE</b>	Blue	Steady light on	PHONE mode is selected as the default mode on the idle headset base.
		Flash 4 times every 4 seconds	There is an incoming call in PHONE mode.
		Flash 2 times every 3 seconds	The headset is in use in PHONE mode.
		Flash slowly	The call is on hold in PHONE mode.
<b>PC</b>	Blue	Steady light on	PC mode is selected as the default mode on the idle headset base.
		Flash 4 times every 4 seconds	There is an incoming call in PC mode.
		Flash 2 times every 3 seconds	The headset is in use in PC mode.
		Flash slowly	The call is on hold in PC mode.

# Appendix

## Frequently asked questions

If you have difficulty with your product, please try the following suggestions. For customer service, visit our website at

**businessphones.vtech.com** or call **1 (800) 595-9511**.

In Canada, dial **1 (800) 267-7377**.

<p><b>I cannot find complete instructions on headset connection, lifter setup, or headset wearing styles.</b></p>	<p>Download the complete instructions on the selected topics under the product page of <b>VH6220</b> or <b>VH6221</b> at <b>businessphones.vtech.com/support/downloads</b>.</p> <p><b>For headset connection methods:</b></p> <div data-bbox="299 511 961 770" style="border: 1px solid black; padding: 10px; text-align: center;"><p><b>"Option 1: Connect to IP phone via EHS"</b></p><p><b>"Option 2: Connect to traditional corded phone"</b></p><p><b>"Option 3: Connect to traditional corded phone with Lifter"</b></p><p><b>"Option 4: Connect to a computer"</b></p></div> <p><b>For the VTech Control software application:</b></p> <div data-bbox="299 847 961 954" style="border: 1px solid black; padding: 10px; text-align: center;"><p><b>"Software application - Installation and Operation Guide"</b></p></div>
<p><b>My headset does not work at all.</b></p>	<p>Make sure the headset and headset base are installed properly, and batteries are installed and charged correctly. For optimum daily performance, return the headset to the headset base after use.</p>

# Appendix



## Frequently asked questions

<b>I cannot hear the dial tone.</b>	<p>Disconnect the telephone line cord from the telephone where the headset base is connected. Then, connect the telephone line cord to another telephone. If there is no dial tone on that other telephone either, then the telephone line cord may be defective. Try installing a new telephone line cord.</p> <p>If changing telephone line cord does not help, the wall jack (or the wiring to this wall jack) may be defective. Contact your telephone service provider.</p>
	<p>You may be using a new cable or VoIP service, the existing telephone jacks in your home may no longer work. Contact your service provider for solutions.</p>
<b>I cannot dial out.</b>	<p>Make sure there is a dial tone before dialing. It is normal if the headset takes a second or two to synchronize with the telephone base before producing a dial tone. Wait an extra second before dialing.</p>
<b>The battery does not charge in the headset or the headset battery does not accept charge.</b>	<p>Make sure the headset is placed in the headset base correctly.</p>
	<p>If the battery is completely depleted, charge the battery for at least 30 minutes before use.</p>
	<p>You may need to purchase a new battery.</p>







# Appendix

## Frequently asked questions

<b>I cannot hear any audio or the caller at the other end cannot hear me, when using my headset in PC mode.</b>	Make sure the two ends of the USB cable are securely plugged into the computer and headset base USB ports.
	Make sure PC mode is selected and the <b>PC</b> light is on.
	Make sure you have pressed  on your headset to receive the audio from your computer.
	Make sure you are using a software program that supports VoIP calling (such as Skype or Skype for Business).
	Make sure the headset listening volume is turned on and set to an audible level in your computer audio settings and your VoIP calling software.
	Make sure the audio settings in your VoIP calling software are set to use your "VTech Headset".
<b>My headset isn't working. I want to replace my headset with a new headset.</b>	<p>You need to deregister the headset from the current headset base, and then register it to the new headset base.</p> <p><b>To deregister the headset from the headset base:</b></p> <ol style="list-style-type: none"><li>1. <u>Press and hold</u> the <b>PAIR</b> button on the headset base (at least 10 seconds) until the <b>MUTE</b> light on the headset base turns on and starts to flash in red, then release the <b>PAIR</b> button.</li><li>2. Immediately press and release the <b>PAIR</b> button again. You must press the <b>PAIR</b> button while the <b>MUTE</b> light is still flashing red. (The light flashes for about seven seconds. If the light stops flashing, start again with Step 1.)</li></ol> <p>It takes about 10 seconds to complete the deregistration process. The  LED light flashes slowly in red and blue when the deregistration process is successful.</p>



# Appendix

## Frequently asked questions

<p><b>I have manually or accidentally deregistered my headset from the headset base.</b></p>	<p>You must register a new headset or the accidentally deregistered headset to the headset base for it to operate.</p> <p><b>To register anew headset to the headset base:</b></p> <ol style="list-style-type: none"><li>1. Make sure the battery is properly installed in the headset. The  LED light flashes slowly in red and blue to indicate the headset is not registered.</li><li>2. Place the headset in the headset base and allow it to charge for at least one hour before beginning registration.</li><li>3. Remove the headset from the headset base.</li><li>4. <u>Press and hold</u> the <b>PAIR</b> button for about four seconds until the <b>PHONE</b> light on the headset base turns on, and then release the button.</li><li>5. Return the headset to the headset base for registration. The  LED light alternates quickly in red and blue.</li></ol> <p>It takes about 60 seconds to complete the registration process. Once the headset is registered, The  LED light turns red when the battery is low and being charged, or turns purple when the battery is well charged, or turns blue when the battery is fully charged.</p> <p>If the registration fails, you hear the voice prompt "Not registered" when you press the  <b>ON/OFF</b> button on the headset, and the  <b>ON/OFF</b> button light on the headset alternates slowly in red and blue.</p>
<p><b>I cannot answer or end, and mute or end mute a call directly from my headset when connected to PC.</b></p>	<p>Make sure PC mode is selected on the headset base and the <b>PC</b> light is on.</p> <p>Make sure you have properly installed the software application.</p> <p>Make sure the audio setting is properly configured in your Windows system.</p> <p>If you have installed Skype or Skype for Business for use with your headset, make sure the audio settings are configured correctly in the programs.</p>

# Appendix

## Frequently asked questions

<b>The  light on the headset is off while charging.</b>	Make sure the cables are plugged in correctly and securely, and that the battery is securely installed in the wireless headset.
	Make sure the headset is sitting properly on the base to charge.
<b>The switch hook presser of the handset lifter doesn't rise at all.</b>	Make sure you do not plug in the EHS cable or headset audio cable when you have connected the handset lifter.
	Make sure the lifter control cable is securely plugged into the <b>LIFTER</b> jack on the headset base.
	Make sure all cables are securely connected to the proper sockets.
	Make sure the headset base has power.
<b>When I press  on the headset, the handset lifter rises, but the call is not connected or I do not hear a dial tone.</b>	When using the handset lifter, make sure the telephone line cord is connected to the telephone line jack on the back of the corded phone.
	The handset lifter may not rise high enough to release the switch hook. Try to adjust the height of the lifter arm by turning the <b>ADJUST LIFTER</b> knob until it reaches the desired angle. Adjust the switch hook presser by turning the switch hook presser adjustment knob so that the switch hook is released when the lifter arm rises.
	If you cannot hear a dial tone when you pressed  on the headset, try out the solutions in <b>I cannot hear the dial tone</b> first.  Slide the audio adjustment switch at the bottom of the headset base between <b>A</b> and <b>F</b> until you obtain a good sound quality.

# Appendix

## Frequently asked questions

<b>My corded phone is ringing, but my headset is not ringing.</b>	Make sure that the <b>RING ON/OFF</b> button on the lifter is turned on. If the <b>RING ON/OFF</b> button is turned off, the headset does not ring.
	If the speaker of your corded phone is not located under the lifter, install the auxiliary ring detector.
	Adjust the sensitivity of the ring detector.
	Make sure the cables are plugged in correctly and securely, and that the battery is securely installed in the wireless headset.
	Make sure your headset battery is charged.
<b>My headset is ringing even when there is no incoming call.</b>	The sensitivity level of your ring detector may be too high. Adjust sensitivity of the ring detector to a lower level.
	When you are using the speakerphone of your telephone, the ring detector may send a ring tone to the headset. If you do not want the headset to ring, press the <b>RING ON/OFF</b> button to turn the ring detector off. After the call, you can press the <b>RING ON/OFF</b> button again to turn the ring detector back on.

# Appendix

## Maintenance

### Taking care of your headset

- Your wireless headset contains sophisticated electronic parts, so it must be treated with care.
- Avoid rough treatment.
- Place the headset down gently. Save the original packing materials to protect your headset if you ever need to ship it.

### Avoid water

- Your headset can be damaged if it gets wet. Do not use the headset outdoors in the rain, or handle it with wet hands. Do not install the headset base near a sink, bathtub or shower.

### Electrical storms

- Electrical storms can sometimes cause power surges harmful to electronic equipment. For your own safety, take caution when using electrical appliances during storms.

### Cleaning your headset

- Your headset has a durable plastic casing that should retain its luster for many years. Clean it only with a soft cloth slightly dampened with water or a mild soap.
- Do not use excess water or cleaning solvents of any kind.

Remember that electrical appliances can cause serious injury if used when you are wet or standing in water. If the headset base should fall into water, DO NOT RETRIEVE IT UNTIL YOU UNPLUG THE POWER CORD AND TELEPHONE LINE CORD FROM THE WALL, then pull the unit out by the unplugged cords.

# Appendix

## Important safety information

When using your equipment, basic safety precautions should always be followed to reduce the risk of fire, electric shock and injury, including the following:

### Safety information

---

- **Read and understand all instructions in the user's manual. Observe all markings on the product.**
- **Use only with UL listed phones.**
- **Avoid using the product during a thunderstorm.** There may be a slight chance of electric shock from lightning.
- **Do not use the product to report a gas leak in the vicinity of the leak.** Under certain circumstances, a spark may be created when the adapter is plugged into the power outlet, or when the headset is replaced in its cradle. This is a common event associated with the closing of any electrical circuit. The user should not plug the headset base into a power outlet, and should not put a charged headset into the cradle, if the headset base is located in an environment containing concentrations of flammable or flame-supporting gases, unless there is adequate ventilation. A spark in such an environment could create a fire or explosion. Such environments might include: medical use of oxygen without adequate ventilation; industrial gases (cleaning solvents; gasoline vapors; etc.); a leak of natural gas; etc.
- **Do not use this product near water, or when you are wet.** For example, do not use it in a wet basement or shower, or next to a swimming pool, bathtub, kitchen sink, or laundry tub. Do not use liquids or aerosol sprays for cleaning. If the product comes in contact with any liquids, unplug any line or power cord immediately. Do not plug the product back in until it has dried thoroughly.
- **Install this product in a protected location** where no one can trip over any line or power cords. Protect cords from damage or abrasion.
- **If this product does not operate normally, see the Frequently asked questions section of this user's manual.** If you cannot solve the problem, or if the product is damaged, refer to the **Limited warranty** section. Do not open this product except as may be directed in your user's manual. Opening the product or reassembling it incorrectly may expose you to hazardous voltage or other risks.
- **This power adapter is intended to be correctly oriented in a vertical or floor mount position.** The prongs are not designed to hold the plug in place if it is plugged into a ceiling, an under-the-table or a cabinet outlet.

# Appendix

## Important safety information

### CAUTIONS

- Use only the power adapter provided with this product. To obtain a replacement, visit our website at **businessphones.vtech.com** or call **1 (800) 595-9511**. In Canada, dial **1 (800) 267-7377**.
- Use Only Supplied Battery or equivalent.
- Do not dispose of the battery in a fire. Check with local waste management codes for special disposal instructions.
- Do not open or mutilate the battery. Released electrolyte is corrosive and may cause burns or injury to the eyes or skin. The electrolyte may be toxic if swallowed.
- Exercise care in handling batteries in order not to create a short circuit with conductive materials.
- Charge the battery provided with this product only in accordance with the instructions and limitations specified in this manual.

### Especially about cordless headsets

---

- **Privacy:** The same features that make a cordless headset convenient create some limitations. Telephone calls are transmitted between the headset base and the headset by radio waves, so there is a possibility that your cordless headset conversations could be intercepted by radio receiving equipment within range of the cordless headset. **For this reason, you should not think of cordless headset conversations as being as private as those on corded telephones.**
- **Electrical power:** The headset base of this cordless headset must be connected to a working electrical outlet which is not controlled by a wall switch. **Calls cannot be made from the headset if the headset base is unplugged or switched off, or if the electrical power is interrupted.**
- **Potential TV interference:** Some cordless headsets operate at frequencies that may cause interference to TVs and VCRs. To minimize or prevent such interference, do not place the headset base of the cordless headset near or on top of a TV or VCR. If interference is experienced, moving the cordless headset farther away from the TV or VCR will often reduce or eliminate the interference.
- **Rechargeable batteries:** This product contains lithium-ion rechargeable batteries. Exercise care in handling batteries in order not to create a short circuit with conductive material such as rings, bracelets and keys. The battery or conductor may overheat and cause harm.
- **Lithium-ion rechargeable batteries:** Dispose of these batteries in a safe manner. Do not burn or puncture. Like other batteries of this type, if burned or punctured, they could release caustic material which could cause injury.

# Appendix

## Important safety information



The RBRC® Seal means that the manufacturer is voluntarily participating in an industry program to collect and recycle lithium-ion rechargeable batteries when taken out of service within the United States. These batteries may be taken to a participating local retailer of replacement batteries or recycling center. You may call 1-800-8-BATTERY® for locations accepting spent Li-ion batteries.

RBRC® and 1-800-8-BATTERY® are registered trademarks of the Rechargeable Battery Recycling Corporation.

### CAUTIONS

- Do not open or damage the batteries. Released electrolyte is corrosive and may cause injury to the eyes or skin. The electrolyte may be toxic if swallowed.
- Do not dispose of the batteries in a fire. Check with local waste management codes for special disposal instructions. To prevent fire or shock hazard, do not expose this product to water or any type of moisture.
- Do not disassemble your headset. There are no user-serviceable parts inside. Refer to qualified service personnel for servicing.
- For pluggable equipment, the socket-outlet shall be installed near the equipment and shall be easily accessible.

### **Precautions for users of implanted cardiac pacemakers**

---

Cardiac pacemakers (applies only to digital cordless devices):

Wireless Technology Research, LLC (WTR), an independent research entity, led a multidisciplinary evaluation of the interference between portable digital cordless devices and implanted cardiac pacemakers. Supported by the U.S. Food and Drug Administration, WTR recommends to physicians that:

#### **Pacemaker patients**

- Should keep digital cordless devices at least six inches from the pacemaker.
- Should NOT place digital cordless devices directly over the pacemaker, such as in a breast pocket, when it is turned ON.
- Should use the digital cordless device at the ear opposite the pacemaker.

WTR's evaluation did not identify any risk to bystanders with pacemakers from other persons using digital cordless devices.

### **SAVE THESE INSTRUCTIONS**



# Appendix

## For C-UL compliance

In compliance with the bilingual requirements for safety, caution, and warning markings of Canadian Federal and Provincial/Territorial statutes and regulations, the French version of Important safety information is included.

### Mesures de sécurité importantes

---

Lorsque vous utilisez votre appareil, vous devriez toujours suivre certaines mesures de précaution de base afin de réduire les risques d'incendie, d'électrocution et de blessures corporelles, dont ceux qui suivent :

#### Information relative à la sécurité

---

- **Veillez lire et comprendre toutes les instructions de ce guide d'utilisation. Relectez toutes les inscriptions apparaissant sur le produit.**
- **N'utilisez qu'avec des téléphones homologués UL.**
- **Évitez d'utiliser le casque d'écoute pendant un orage.** Il pourrait y avoir un faible risque d'électrocution.
- **N'utilisez pas un casque d'écoute près d'une fuite de gaz.** Dans certaines circonstances, une flammèche pourrait se produire lorsque l'adaptateur est branché à une prise de courant, ou lorsque le casque d'écoute est déposé sur son chargeur. Ceci est un événement fréquent associé avec la fermeture d'un circuit électrique. L'utilisateur ne devrait pas brancher un téléphone dans une prise de courant, et ne devrait pas déposer un casque d'écoute chargé dans son chargeur, si le chargeur du casque d'écoute se trouve dans un environnement comportant une concentration de gaz inflammables ou ignifuges, à moins de se trouver dans un endroit où la ventilation est adéquate.
- **N'utilisez pas ce produit près de l'eau ou lorsque vous êtes mouillés.** Par exemple, ne l'utilisez pas dans des sous-sols humides ou sous la douche, ou près d'une piscine, d'un bain, d'un évier de cuisine, ou d'une cuve de lavage. N'utilisez pas de liquides, ou de vaporisateurs aérosol de nettoyage. Si le produit entre en contact avec du liquide, débranchez immédiatement le fil téléphonique ou le cordon d'alimentation. Ne rebranchez pas le produit avant qu'il soit complètement sec.
- **Installez cet appareil dans un endroit protégé** où personne ne peut trébucher sur les cordons d'alimentation ou la ligne téléphonique. Protégez les câbles contre les dommages ou l'abrasion.
- **Si le produit ne fonctionne pas correctement, consultez la section Dépannage (Frequently asked questions) de ce guide d'utilisation.** Si vous ne pouvez pas régler le problème, ou si le produit est endommagé, consultez la section **Garantie limitée (Limited warranty)**. N'ouvrez pas ce produit, sauf tel qu'indiqué dans le guide d'utilisation. L'ouverture du produit ou le remontage inadéquat pourrait vous exposer à des tensions dangereuses ou autres dangers.
- **L'adaptateur de courant est conçu pour être orienté verticalement ou installé sur le plancher.** Les broches ne sont pas conçues pour se maintenir en place si la fiche est branchée dans une prise de courant au plafond, sous la table ou sous une armoire.

# Appendix

## For C-UL compliance



### MISES EN GARDE

- N'utilisez seulement l'adaptateur inclus avec ce produit. Pour obtenir une pièce de rechange, visitez notre site Web au **businessphones.vtech.com** ou composez le **1 (800) 595-9511**. Au Canada, composez le **1 (800) 267-7377**.
- N'utilisez que la pile incluse ou l'équivalent.
- Ne jetez pas la pile au feu. Vérifiez les instructions spécifiques de mise aux rebus auprès des autorités locales.
- N'ouvrez pas et ne mutilez pas la pile. L'électrolyte qui s'en échapperait est corrosif et pourrait causer des brûlures ou des blessures aux yeux ou à la peau. L'électrolyte est toxique si avalé.
- Soyez prudents lorsque vous manipulez les piles afin d'éviter les courts-circuits provoqués par des matériaux conducteurs.
- Rechargez la pile incluse avec cet appareil, selon les instructions et limites spécifiées dans ce guide d'utilisation.

### Spécifiquement en rapport avec casque d'écoute sans fil

---

- **Confidentialité** : Les mêmes caractéristiques qui rendent le casque d'écoute sans fil si pratique créent également des restrictions. Les appels téléphoniques sont transmis entre le socle du casque d'écoute et le casque d'écoute par le biais d'ondes radio, et il se peut que vos conversations téléphoniques sur le casque d'écoute sans fil soient interceptées par d'autres équipements de réception d'ondes radio au sein de la portée du casque d'écoute sans fil. **Pour cette raison, vous ne devez pas considérer les conversations sur un téléphone sans fil comme étant aussi confidentielles que celles d'un téléphone à cordon.**
- **Alimentation électrique** : La base de ce téléphone sans fil (de ce casque d'écoute sans fil) doit être branchée à une prise de courant électrique fonctionnelle. La prise électrique ne doit pas être contrôlée par un interrupteur mural. **Les appels ne peuvent pas être effectués à partir du socle du casque d'écoute n'est pas branchée, si elle est hors fonction ou si le courant électrique est coupé.**
- **Interférences potentielles aux téléviseurs**: Certains casques d'écoute sans fil fonctionnent sur des fréquences pouvant causer des interférences aux téléviseurs et magnétoscopes. Pour réduire ou prévenir de tels parasites, ne pas déposer le socle du casque d'écoute à proximité d'un téléviseur ou magnétoscope, ni directement sur celui-ci. Si votre téléviseur affiche des interférences, éloignez le casque d'écoute sans fil de celui-ci afin de réduire les parasites.

# Appendix

## For C-UL compliance

- **Piles rechargeables:** Ce produit comporte des piles rechargeables au lithium-ion. Usez de prudence lorsque vous manipulez de telles piles et veillez à ne pas les court-circuiter avec des matériaux conducteurs, tels que des bagues, bracelets et clés. La pile ou le conducteur peut surchauffer et vous brûler. Respectez la polarité adéquate entre les piles et le chargeur de piles.
- **Piles rechargeables au lithium-ion:** Jetez ces piles de manière sécuritaire. N'incinerez pas et ne percez pas les piles. Comme pour les autres piles du même type, si elles sont brûlées ou percées, des matières corrosives peuvent s'en échapper, ce qui risque de causer des brûlures ou autres blessures corporelles.



Le sceau de l'organisme de recyclage RBRC<sup>MD</sup> sur les piles au lithium-ion signifie que le fabricant de cet appareil participe volontairement au programme industriel visant à reprendre et recycler ce type de piles lorsqu'elles ne servent plus, au sein du territoire des États-Unis et du Canada. Vous devez apporter ces piles chez un détaillant participant ou le centre de recyclage le plus près de chez vous. Ou vous pouvez composer le 1-800-8-BATTERY<sup>MD</sup> afin de connaître les endroits qui acceptent les piles au lithium-ion mortes.

RBRC<sup>MD</sup> et 1-800-8-BATTERY<sup>MD</sup> sont des marques déposées de Rechargeable Battery Recycling Corporation.

### MISES EN GARDE

- N'ouvrez pas et n'endommagez les piles. L'électrolyte qui s'en dégagerait est corrosif et peut causer des blessures aux yeux ou à la peau. L'électrolyte est toxique si avalé.
- N'incinerez pas les piles. Vérifiez auprès des autorités locales pour les instructions de mise aux rebus locales. Afin de prévenir les risques d'incendies, n'exposez pas ce produit à l'eau ou à l'humidité.
- Veuillez respecter la polarité des piles et des bornes métalliques.
- Pour les PRODUITS À BRANCHER À UNE PRISE DE COURANT, la prise de courant doit être installée près du produit, afin d'assurer une accessibilité sécuritaire à la prise de courant

# Appendix

## For C-UL compliance

### Mesures préventives pour les utilisateurs de stimulateurs cardiaques implantés dans l'organisme

---

Stimulateurs cardiaques (ne s'applique qu'aux dispositifs numériques sans fil):

L'organisme 'Wireless Technology Research, LLC (WTR)', une firme de recherche indépendante, a mené une évaluation pluridisciplinaire des interférences entre les dispositifs numériques sans fil et les stimulateurs cardiaques implantés dans l'organisme. Appuyée par l'Administration des aliments et drogues (FDA) des États-unis, la firme WTR recommande aux médecins:

#### Avis aux détenteurs de stimulateurs cardiaques

- Ils doivent tenir les dispositifs numériques sans fil à une distance d'au moins six pouces du stimulateur cardiaque.
- Ils ne doivent PAS placer les dispositifs numériques sans fil directement sur le stimulateur cardiaque, tel que dans une poche de chemise, lorsque celui-ci est en fonction.
- Ils doivent utiliser les dispositifs numériques sans fil en les appuyant sur l'oreille qui se trouve dans la direction opposée au stimulateur cardiaque.

L'étude effectuée par l'organisme WRS n'a pas identifié de risque pour les détenteurs de simulateurs cardiaques causé par les gens qui utilisent des dispositifs numériques sans fil à proximité de ceux-ci.

### **CONSERVEZ CES INSTRUCTIONS**

# Appendix

## FCC Part 68 and ACTA

This equipment complies with Part 68 of the FCC rules and with technical requirements adopted by the Administrative Council for Terminal Attachments (ACTA). The label on the back or bottom of this equipment contains, among other things, a product identifier in the format US: AAAEQ##TXXXX. This identifier must be provided to your telephone service provider upon request.

The plug and jack used to connect this equipment to premises wiring and the telephone network must comply with applicable Part 68 rules and technical requirements adopted by ACTA. A compliant telephone cord and modular plug are provided with this product. It is designed to be connected to a compatible modular jack that is also compliant. An RJ11 jack should normally be used for connecting to a single line and an RJ14 jack for two lines. See the installation instructions in the user's manual.

The Ringer Equivalence Number (REN) is used to determine how many devices you may connect to your telephone line and still have them ring when you are called. The REN for this product is encoded as the 6th and 7th characters following the US: in the product identifier (e.g. if ## is 03, the REN is 0.3). In most, but not all areas, the sum of all RENs should be five (5.0) or less. For more information, please contact your telephone service provider.

This equipment may not be used with party lines. If you have specially wired alarm dialing equipment connected to your telephone line, ensure the connection of this equipment does not disable your alarm equipment. If you have questions about what will disable alarm equipment, consult your telephone service provider or a qualified installer.

If this equipment is malfunctioning, it must be unplugged from the modular jack until the problem has been corrected. Repairs to this telephone equipment can only be made by the manufacturer or its authorized agents. For repair procedures, follow the instructions outlined under the Limited warranty.

If this equipment is causing harm to the telephone network, the telephone service provider may temporarily discontinue your telephone service. The telephone service provider is required to notify you before interrupting service. If advance notice is not practical, you will be notified as soon as possible. You will be given the opportunity to correct the problem and the telephone service provider is required to inform you of your right to file a complaint with the FCC. Your telephone service provider may make changes in its facilities, equipment, operation, or procedures that could affect the proper functioning of this product. The telephone service provider is required to notify you if such changes are planned.

# Appendix

## FCC Part 68 and ACTA

If this product is equipped with a corded or cordless handset, it is hearing aid compatible.

If this product has memory dialing locations, you may choose to store emergency telephone numbers (e.g. police, fire, medical) in these locations. If you do store or test emergency numbers, please:

Remain on the line and briefly explain the reason for the call before hanging up.

Perform such activities in off-peak hours, such as early morning or late evening.

### Industry Canada

This device contains licence-exempt transmitter(s)/receiver(s) that comply with Innovation, Science and Economic Development Canada's licence-exempt RSS(s).

Operation is subject to the following two conditions: (1) this device may not cause interference, and (2) this device must accept any interference, including interference that may cause undesired operation of the device.

Privacy of communications may not be ensured when using this telephone.

The term "IC:" before the certification/registration number only signifies that the Industry Canada technical specifications were met.

The Ringer Equivalence Number (REN) for this terminal equipment is 1.0. The REN is an indication of the maximum number of devices allowed to be connected to a telephone interface. The termination on an interface may consist of any combination of devices subject only to the requirement that the sum of the RENs of all the devices does not exceed five.

This product meets the applicable Innovation, Science, and Economic Development Canada technical specifications.

# Appendix

## FCC Part 15

NOTE: This equipment has been tested and found to comply with the limits for a Class B digital device, pursuant to Part 15 of the FCC Rules. These limits are designed to provide reasonable protection against harmful interference in a residential installation. This equipment generates, uses and can radiate radio frequency energy and, if not installed and used in accordance with the instructions, may cause harmful interference to radio communications.

However, there is no guarantee that interference will not occur in a particular installation. If this equipment does cause harmful interference to radio or television reception, which can be determined by turning the equipment off and on, the user is encouraged to try to correct the interference by one or more of the following measures:

- Reorient or relocate the receiving antenna.
- Increase the separation between the equipment and receiver.
- Connect the equipment into an outlet on a circuit different from that to which the receiver is needed.
- Consult the dealer or an experienced radio/TV technician for help.

Changes or modifications to this equipment not expressly approved by the party responsible for compliance could void the user's authority to operate the equipment.

This device complies with Part 15 of the FCC Rules. Operation is subject to the following two conditions: (1) this device may not cause harmful interference, and (2) this device must accept any interference received, including interference that may cause undesired operation. Privacy of communications may not be ensured when using this device.

To ensure safety of users, the FCC has established criteria for the amount of radio frequency energy that can be safely absorbed by a user or bystander according to the intended usage of the product. This product has been tested and found to comply with the FCC criteria. Use of other accessories may not ensure compliance with FCC RF exposure guidelines. The headset may be safely held against the ear of the user. The headset base shall be installed and used such that parts of the user's body other than the hands are maintained at a distance of approximately 20 cm (8 inches) or more.

This Class B digital apparatus complies with Canadian requirement:  
CAN ICES-3 (B)/NMB-3(B).

# Appendix

## California Energy Commission battery charging testing instructions

This wireless headset is set up to comply with the energy-conserving standards right out of the box. These instructions are intended for California Energy Commission (CEC) compliance testing only. When the CEC battery charging testing mode is activated, all headset functions, except battery charging, will be disabled.

If you have registered the wireless headset to the **VH6220/VH6221** headset base, below are the testing instructions.

### To activate the CEC battery charging testing mode:

1. Unplug the headset base power adapter from the power outlet. Make sure the headset is plugged with the charged battery before proceeding.
2. Press and hold **PAIR** on the headset base while powering up the base by plugging in the adapter.
3. After about 20 seconds, when the blue **PHONE** light on the headset base starts flashing, release **PAIR** and then press it again within two seconds.

The process takes up to one minute to complete. When the headset successfully enters the CEC battery charging testing mode, the  LED light flashes slowly in red and blue.



**NOTE:** When the headset fails to enter this mode, repeat all the steps mentioned above.

### To deactivate the CEC battery charging testing mode:

1. Unplug the headset base power adapter from the power outlet, then plug it back in. The headset base is powered up as normal.
2. Register the headset back to the headset base.

If you have registered the wireless headset to a compatible VTech DECT cordless telephone, please refer to the respective user's manual for the activation and deactivation of CEC battery charging testing mode.

If you have registered the wireless headset to a telephone base that does not have CEC battery charging testing mode, all telephone functions on the wireless headset, except battery charging, will be disabled.



# Appendix

## Limited warranty

### 1. What does this limited warranty cover?

VTech of this VTech product warrants to the holder of a valid proof of purchase ("CONSUMER" or "you") that the product and all accessories provided in the sales package ("PRODUCT") are free from defects in material and workmanship, pursuant to the following terms and conditions, when installed and used normally and in accordance with the PRODUCT operating instructions. This limited warranty extends only to the CONSUMER for products purchased and used in the United States of America and Canada.

### 2. What will be done if the PRODUCT is not free from defects in materials and workmanship during the limited warranty period ("materially defective PRODUCT")?

During the limited warranty period, VTech's authorized service representative will repair or replace at VTech's option, without charge, a materially defective PRODUCT. If VTech repairs the PRODUCT, they may use new or refurbished replacement parts. If VTech chooses to replace the PRODUCT, they may replace it with a new or refurbished PRODUCT of the same or similar design. VTech will retain defective parts, modules, or equipment. Repair or replacement of the PRODUCT, at VTech's option, is your exclusive remedy. VTech will return repaired or replacement products to you in working condition. You should expect the repair or replacement to take approximately 30 days.

### 3. How long is the limited warranty period?

The limited warranty period for the PRODUCT extends for ONE (1) YEAR from the date of purchase. If VTech repairs or replaces a materially defective PRODUCT under the terms of this limited warranty, this limited warranty also applies to repaired or replacement PRODUCT for a period of either (a) 90 days from the date the repaired or replacement PRODUCT is shipped to you or, (b) the time remaining on the original one-year limited warranty; whichever is longer.

# Appendix

## Limited warranty

### 4. What is not covered by this limited warranty?

This limited warranty does not cover:

- PRODUCT that has been subjected to misuse, accident, shipping or other physical damage, improper installation, abnormal operation or handling, neglect, inundation, fire, water, or other liquid intrusion; or
- PRODUCT that has been damaged due to repair, alteration, or modification by anyone other than an authorized service representative of VTech; or
- PRODUCT to the extent that the problem experienced is caused by signal conditions, network reliability or cable or antenna systems; or
- PRODUCT to the extent that the problem is caused by use with non-VTech accessories; or
- PRODUCT whose warranty/quality stickers, PRODUCT serial number plates or electronic serial numbers have been removed, altered or rendered illegible; or
- PRODUCT purchased, used, serviced, or shipped for repair from outside the United States of America or Canada, or used for commercial or institutional purposes (including but not limited to products used for rental purposes); or
- PRODUCT returned without a valid proof of purchase (see item 6 on the next page); -or-
- Charges for installation or setup, adjustment of customer controls, and installation or repair of systems outside the unit.

### 5. How do you get warranty service?

To obtain warranty service in the United States of America, visit **businessphones.vtech.com** or call **1 (800) 595-9511**. In Canada, call **1 (800) 267-7377**.

NOTE: Before calling for service, please review the user's manual; a check of the PRODUCT's controls and features may save you a service call.

Except as provided by applicable law, you assume the risk of loss or damage during transit and transportation and are responsible for delivery or handling charges incurred in the transport of the PRODUCT(s) to the service location. VTech will return repaired or replaced PRODUCT under this limited warranty to you. Transportation, delivery or handling charges are prepaid. VTech assumes no risk for damage or loss of the PRODUCT in transit. If the PRODUCT failure is not covered by this limited warranty, or proof of purchase does not meet the terms of this limited warranty, VTech will notify you and will request that you authorize the cost of repair prior to any further repair activity. You must pay for the cost of repair and return shipping costs for the repair of products that are not covered by this limited warranty.

# Appendix

## Limited warranty

### 6. What must you return with the PRODUCT to get warranty service?

You must:

- a. Return the entire original package and contents including the PRODUCT to the service location along with a description of the malfunction or difficulty; and
- b. Include a "valid proof of purchase" (sales receipt) identifying the PRODUCT purchased (PRODUCT model) and the date of purchase or receipt; and
- c. Provide your name, complete and correct mailing address, and telephone number.

### 7. Other limitations

This warranty is the complete and exclusive agreement between you and VTech of this PRODUCT. It supersedes all other written or oral communications related to this PRODUCT. VTech provides no other warranties for this PRODUCT. The warranty exclusively describes all of VTech's responsibilities regarding the PRODUCT. There are no other express warranties. No one is authorized to make modifications to this limited warranty and you should not rely on any such modification.

**State/Provincial Law rights:** This warranty gives you specific legal rights, and you may also have other rights which vary from state to state or province to province.

**Limitations:** Implied warranties, including those of fitness for a particular purpose and merchantability (an unwritten warranty that the PRODUCT is fit for ordinary use) are limited to one year from date of purchase. Some states/provinces do not allow limitations on how long an implied warranty lasts, so the above limitation may not apply to you. In no event shall VTech be liable for any indirect, special, incidental, consequential, or similar damages (including, but not limited to lost profits or revenue, inability to use the PRODUCT or other associated equipment, the cost of substitute equipment, and claims by third parties) resulting from the use of this PRODUCT. Some states/provinces do not allow the exclusion or limitation of incidental or consequential damages, so the above limitation or exclusion may not apply to you.

**Please retain your original sales receipt as proof of purchase.**

# Appendix

## Disclaimer and Limitation of Liability

VTech Communications, Inc. and its suppliers assume no responsibility for any damage or loss resulting from the use of this user's manual. VTech Communications, Inc. and its suppliers assume no responsibility for any loss or claims by third parties that may arise through the use of this product. VTech Communications, Inc. and its suppliers assume no responsibility for any damage or loss caused by deletion of data as a result of malfunction, dead battery, or repairs. Be sure to make backup copies of important data on other media to protect against data loss.

**Company:** VTech Communications, Inc.

**Address:** 9590 SW Gemini Drive, Suite 120, Beaverton, OR 97008, United States

**Phone:** 1 (800) 595-9511 in the U.S. or 1 (800) 267-7377 in Canada

# Appendix

## Technical specifications

RF frequency band	1921.536MHz - 1928.448MHz
Channels	5
Operating temperature	32°F - 122°F 0°C - 50°C
Headset base voltage (AC voltage, 60Hz)	96Vrms - 127Vrms
Headset base voltage (AC adapter output)	Output 1: 6VDC @450mA Output 2: 6VDC @300mA
Headset operating voltage	3.2VDC - 4.2VDC



Designed to fit your home.  
And your life.

VTech Communications, Inc.

A member of THE VTECH GROUP OF COMPANIES.

VTech is a registered trademark of VTech Holdings Limited.

Specifications are subject to change without notice.

© 2018 VTech Communications, Inc.

All rights reserved. 10/18. VH6220\_VH6221\_ACIB\_V4.0

Document order number: 91-011584-010-100