

# vtech

BASE AND HANDSET SPEAKERPHONE



v 2651

2.4GHz TELEPHONE

## USER'S MANUAL



**vtech**

VTECH TELECOMMUNICATIONS LTD.  
[www.vtechphones.com](http://www.vtechphones.com)

# Important Safety Instructions

---

When using your telephone equipment, basic safety precautions should always be followed to reduce the risk of fire, electric shock and injury, including the following:

1. Read and understand amage to the product.
2. Slots and openings in the cabinet and the back or bottom are provided for ventilation. To protect it from overheating, these openings must not be blocked by placing the product on the bed, sofa, rug, or other similar surface. This product should never be placed near or over a radiator or heat register. This product should not be placed in a built-in installation where proper ventilation is not provided.
3. This product should be operated only from the type of power source indicated on the marking label. If you are not sure of the type of power supply to your home, consult your dealer or local power company.
4. Do not allow anything to rest on the power cord. Do not locate this product where the cord will be abused by persons walking on it.
5. Never push objects of any kind into this product through cabinet slots as they may touch dangerous voltage points or short out parts that could result in a risk of fire or electric shock. Never spill liquid of any kind on the product.
6. To reduce the risk of electric shock, do not disassemble this product, but take it to an authorized service facility. Opening or removing cabinet parts other than specified access doors may expose you to dangerous voltages or other risks. Incorrect reassemb-ling can cause electric shock when the appliance is subsequently used.
7. Do not overload wall outlets and extension cords as this can result in the risk of fire or electric shock.

- 
12. Unplug this product from the wall outlet and refer servicing to a VTech authorized service facility under the following conditions:
    - A. When the power supply cord or plug is damaged or frayed.
    - B. If liquid has been spilled into the product.
    - C. If the product has been exposed to rain or water.
    - D. If the product does not operate normally by following the operating instructions. Adjust only those controls that are covered by the operating instructions, because improper adjustment of other controls may result in damage and will often require extensive work by a VTech authorized technician to restore the product to normal operation.
    - E. If the product has been dropped and the cabinet has been damaged.
    - F. If the product exhibits a distinct change in performance.
  13. Avoid using a telephone (other than a cordless type) during an electrical storm. There may be a remote risk of electric shock from lightning.
  14. Do not use the telephone to report a gas leak in the vicinity of the leak.

## **VTECH COMMUNICATIONS INC**

SERVICE DEPT. at 1-800-595-9511. In Canada, call VTech Telecommunications Canada Ltd. at 1-800-267-7377.

**SAVE THESE INSTRUCTIONS**

# Introduction

---

The **v 2651** is an advanced cordless telephone that operates in the 2.4GHz frequency range. Your **v 2651** is capable of supporting up to a maximum of 4 Handsets. Using additional Handsets, up to three people can be conferenced on a call (2 Handsets and the Base Speakerphone), or two extensions can be conferenced on a call, while two other extensions can be talking internally, using the Intercom feature.

This manual is designed to familiarize you with the **v 2651** cordless telephone. We strongly recommend you read the manual before using your phone.

**To order additional system Handsets(model#v2600), battery packs, or headsets, call VTech Communications Inc at 1-800-595-9511.**

## IMPORTANT

Please record the Base ID#(BS ID) printed on the underside of the 2651 Base in the space below. Please be certain to include all 15 digits/characters.

Base ID # \_\_\_\_\_



**If you have questions about this product, or if you're having difficulty with setup or operation, do not return your phone to the store. Call our Customer Support Center at**

**1-800-595-9511**

**In Canada, call**

**1-800-267-7377**

# Parts Check List

1. Base Unit
2. Handset
3. AC Power Adapter
4. Telephone Cord
5. Battery Pack
6. Owner's Manual
7. Wall Mounting Bracket

To purchase replacement battery packs, call VTech Communications Inc at 1-800-595-9511. In Canada, call VTech Telecommunications Canada Ltd. at 1-800-267-7377.



Handset

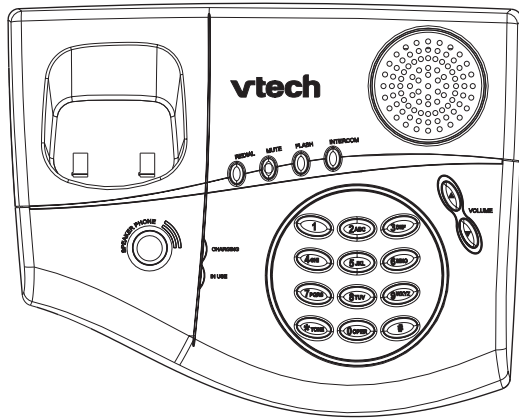

Base Unit

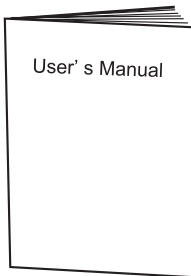

User's Manual

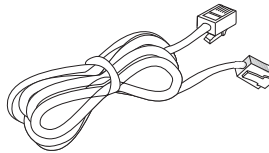

Telephone Cord

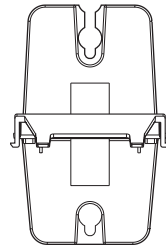

Wall mount

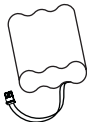

Battery Pack

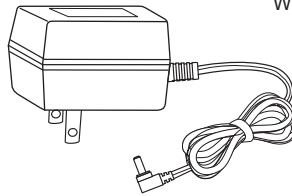

AC Adapter

# The Handset Layout

---

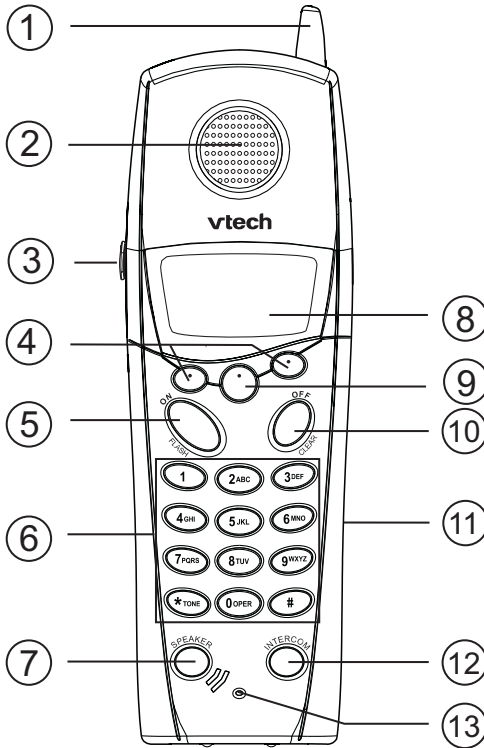

- |                                    |                                |
|------------------------------------|--------------------------------|
| <b>1. Antenna</b>                  | <b>8. LCD Display</b>          |
| <b>2. Earpiece</b>                 | <b>9. Menu/Select</b>          |
| <b>3. Headset Jack (2.5mm)</b>     | <b>10. Off (Clear)</b>         |
| <b>4. Scroll Keys</b>              | <b>11. Battery Compartment</b> |
| <b>5. On (Flash)</b>               | <b>12. Intercom</b>            |
| <b>6. Dialing Keys (0-9, *, #)</b> | <b>13. Microphone</b>          |
| <b>7. Handsfree Speakerphone</b>   |                                |

# The Base Unit Layout

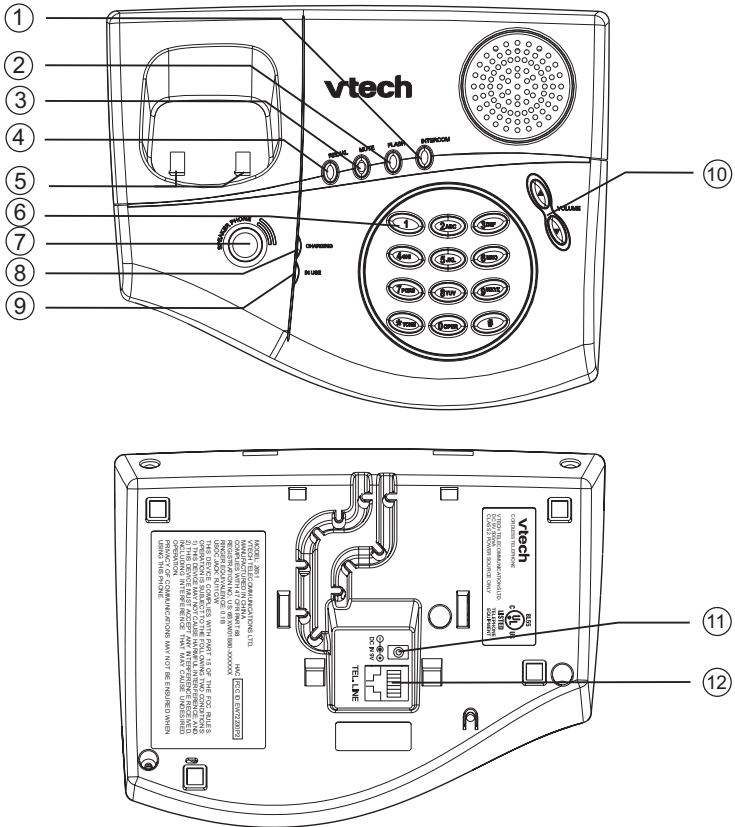

- |                             |                    |
|-----------------------------|--------------------|
| 1. Intercom                 | 7. Speakphone key  |
| 2. Flash                    | 8. Charge Contacts |
| 3. Mute                     | 9. In Use          |
| 4. Redial                   | 10. Volume         |
| 5. Charge Contacts          | 11. DC Connector   |
| 6. Dialing Keys (0-9, *, #) | 12. Telephone Jack |

## Connecting Power to Base Unit

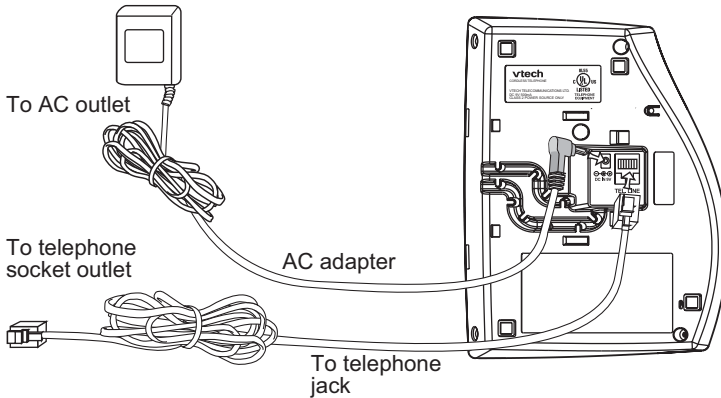

Plug the AC power adapter into an electrical outlet, and the DC connector into the back of the base unit.



**CAUTION:** Use only the VTech power supply provided with your VTech unit.

### **IMPORTANT:** **FOR MAXIMUM PERFORMANCE OF YOUR CORDLESS TELEPHONE SYSTEM:**

1. Choose a central location for your Base Unit.
2. Install your Base Unit and Extension Handsets away from electronic equipment, such as personal computers, television sets and microwave ovens.
3. In locations where there are multiple cordless telephones, separate Base units as much as possible.
4. Install your telephone equipment away from heat sources and sunlight.
5. Avoid excessive moisture, dust or extreme cold.

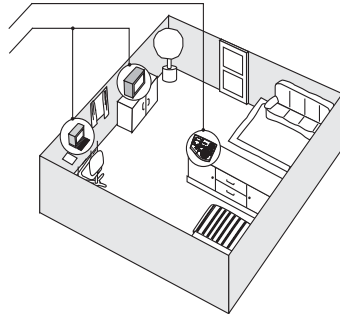



## Installation of Battery Pack in Handset

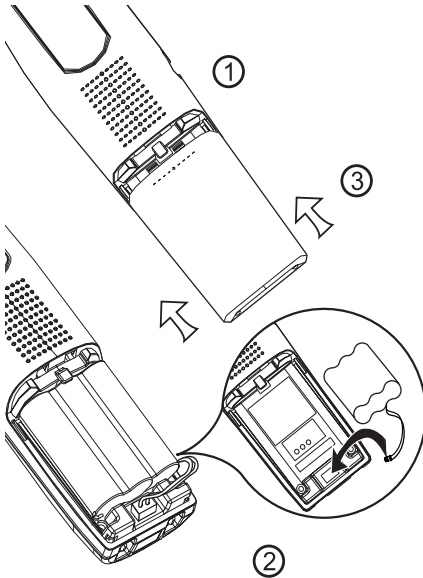

Follow the steps below:

1. Remove the battery cover by pressing on the indent and sliding downward.
2. Align the two holes in the plug with the socket pins. Insert the plug into socket. Place the battery pack into the compartment with the wires coming out of one of the bottom corners of the pack.
3. Replace the battery cover by sliding it upwards.
4. If the new battery pack is not already charged, place the Handset in the Base unit, or a remote charging stand, and allow it to charge for 12 hours. After initial charge, a maintenance charge of 8 hours should be sufficient.

The original Handset that is shipped with your **v2651** system will be automatically registered to the Base. This Handset is **HANDSET 1**.

As you register additional Handsets to the system, they will be assigned extension numbers in the following order: **HANDSET 2**, **HANDSET 3**, and finally **HANDSET 4**.

After a Handset battery pack is installed, the Handset will automatically begin **SEARCHING FOR BASE** (if previously registered), or it will prompt you to **ENTER BASE ID** to register the new Handset.

## Charging Of Handset Battery Pack

The Handset of your **v 2651** cordless telephone is powered by a rechargeable battery pack. It charges automatically whenever the Handset is in the Base Unit. Maximum talk time on a full charge is 8 hours. Maximum standby time is 5 days.

### Connecting to phone line

Plug one end of the telephone line cord into the jack on the back of the Base unit. Plug the other end of this cord into the wall jack.

### Checking for dial tone

After the battery is charged press **ON** on the Handset. The Phone icon  will appear on the handset display, and you will hear dial tone. If not, see In Case of Difficulty.

**You should charge the battery pack for 12 hours when you first receive your phone.** You'll know the battery pack needs charging when:

- The low battery message is displayed :
- The handset seems completely dead, the LCD is completely clear and does not activate when you press the keys.

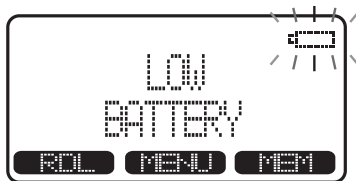

### IMPORTANT:

1. Do not dispose of a battery pack in a fire, the cell may explode.
2. Do not open or mutilate the battery pack. Toxic substances may be released, causing harm to eyes or skin.
3. Exercise care in handling battery packs in order to prevent an accidental short of the charge contacts, potentially causing the battery pack to overheat.
4. Do not dispose of this battery pack into household garbage. For information concerning proper battery recycling or disposal, please contact your local Recycling Center or Disposal Service.

## Charging Of Handset Battery Pack

The Wall Mount bracket is designed for use on standard Wall Mount plates only.

1. Line up the tabs on the wall mount adapter with the holes on the bottom of the base unit. Snap the wall mount bracket firmly in place.
2. Plug the AC adapter into an electrical outlet, and the DC connector to the back of the base unit. If the handset battery pack has not been charged previously, place the handset in the base unit cradle, and allow it to charge for 12 hours.
3. Connect the telephone line cord to the jack on the back of the base unit, and the other end to the wall jack.
4. Mount the base unit on the wall. Position the base unit so the mounting studs will fit into the holes on the wall mount bracket. Slide base unit down on the mounting studs until it locks into place.

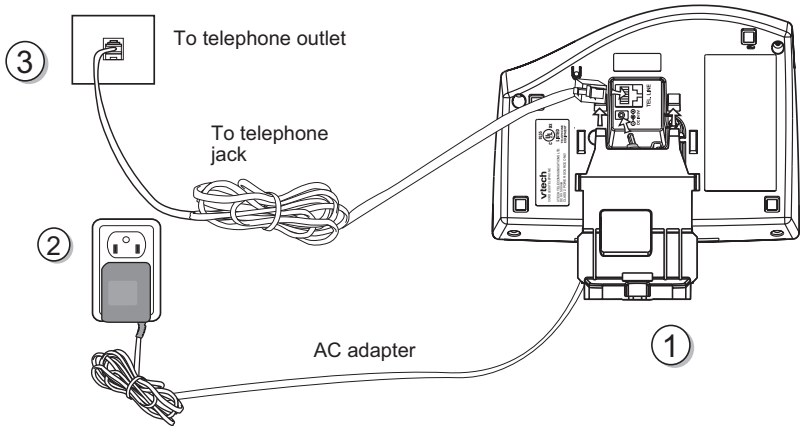

## Registration of Additional Handsets

### Registration And Operation Of The VTech v2600 Accessory Handset

Your VTech v 2651 system can operate up to 4 Handsets.

The VTech accessory Handset consists of the following:



Handset

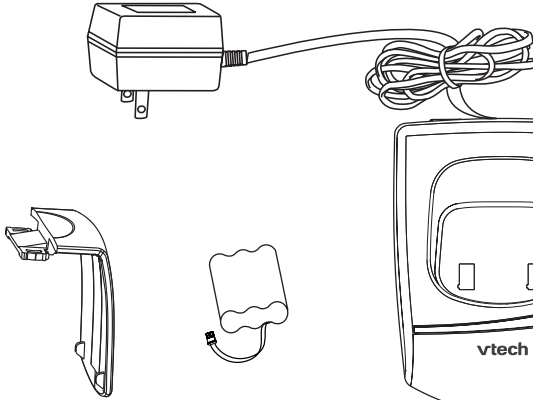

Belt Clip

Battery Pack

Charger Unit

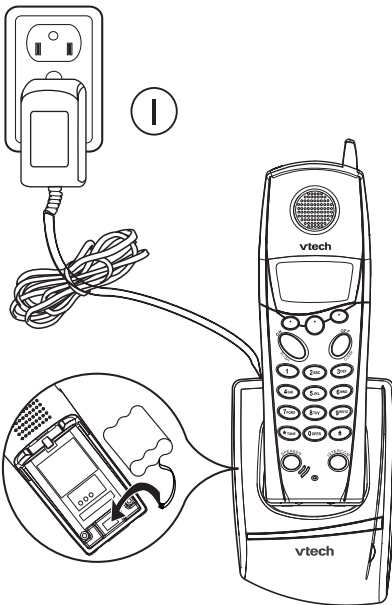

### Setup Of The v 2600 Accessory Handset

1. Plug the AC power adapter into an electrical outlet.
2. Install the battery pack, as described previously.

To order additional Handsets (model v 2600) Call 1-800-595-9511. In Canada, call 1-800-267-7377.

## Registration of Additional Handsets

### Enter Base ID Code

1. After charging the Handset, if the screen displays **SEARCHING FOR BASE**, press **NEW**. You will see **ENTER BASE ID**. If the screen already says **ENTER BASE ID**, go to step 2.

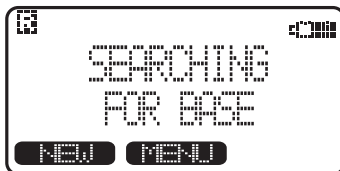

2. Press **NEW**, then enter the 15 digit Base Unit ID code, located on the underside of the Base Unit.

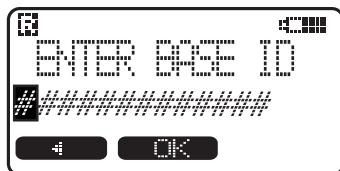

3. Press **OK**. The Handset will display: **PLEASE WAIT!!**

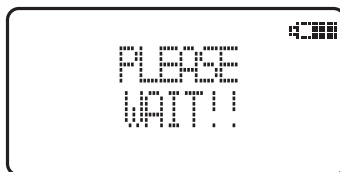

4. Wait approximately 15 seconds. The Handset will display:

**FOUND BASE V17**

**NOTE:** Occasionally, it will take longer than 15 seconds for the Handset to find the Base Unit. This is normal.

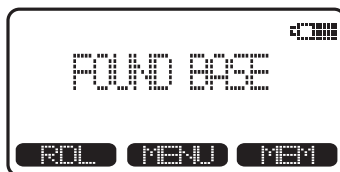



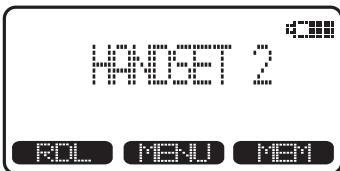



If the Handset displays: **BASE BUSY TRY LATER**, this indicates that the system is in use. Wait until the Base Unit is in the idle (on hook) mode, and repeat steps 2 to 4.



Congratulations! You can now enjoy the benefits of your VTech multi-Handset system.

## Handset and Base Indicators

### Handset Icons

Icon	Description
	<p><u>Line In Use indicator</u> On steady with no number next to it when a parallel set is in use. On steady with one or more numbers next to it, indicating which extensions are using the line. For example,  12 indicates that Handset 1 and Handset 2 are on an outside call.</p>
	<p><u>Intercom indicator</u> On steady with the extension numbers currently on an intercom call. For example,  02 indicates that the Base and Handset 2 are on an intercom call.</p>
	<p><u>Battery indicator</u> Cycles (Low, Medium, and High) when Handset battery is charging. Flashes when a low battery condition is detected.</p>
<b>M</b>	<p><u>Mute indicator</u> On steady when the Handset microphone is muted.</p>
<b>H</b>	<p><u>Hold indicator</u> On steady when the line is on hold.</p>
<b>E</b>	<p><u>Range Extender indicator</u> On steady when the Range Extender is on.</p>
<b>R</b>	<p><u>Handset Registration indicator</u>  is displayed when a Handset is either not registered, or is searching for a Base unit.</p>

## Handset and Base Indicators

### Base LEDs

LED	Description
In Use	<ul style="list-style-type: none"><li>• Lights when line is being used by a Handset of the GIGAPHONE system.</li><li>• Flashes when another telephone on the same line (parallel extension) is in use.</li><li>• Flashes when the phone rings.</li><li>• Flashes when setting Base ringer melody or volume.</li></ul>
Charging	<ul style="list-style-type: none"><li>• Lights whenever the Handset is placed in the Base unit charging cradle.</li></ul>
Mute	<ul style="list-style-type: none"><li>• Lights when Base microphone is muted.</li></ul>
Speakerphone	<ul style="list-style-type: none"><li>• Lights when Base speakerphone is in use.</li><li>• Flashes when the phone rings.</li><li>• Flashes when the Handset places a call on Hold.</li></ul>

The **v 2651** has an advanced design that uses a menu structure and soft keys to access all of the built-in features.

Example of the idle mode display:

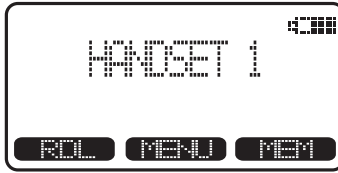

### RDL (Redial)

Press **RDL** to display the last 5 telephone numbers dialed. The number on the top line is the most recent number dialed.

- Use the / scroll keys to select the desired number.
- To dial the number, you can simply press the **ON** or **SPEAKER** key.

### MENU

With the Handset in the idle (OFF) mode, press the **MENU** key to access the following options:

- **CALLS LOG (CALLER ID)**
- **HANDSET SETTINGS**
- **RANGE EXTENDER**
- **TONE/ PULSE**
- **REGISTER**

Use the / scroll keys to select the desired option, then press **OK**.

### Caller ID - Call Waiting ID

Your **v 2651** is capable of displaying the name and /or number of the party calling before you answer the phone (**Caller ID**). It is also capable of displaying Caller ID information in conjunction with a Call Waiting alert signal (**Call Waiting Caller ID**). With Call Waiting Caller ID, the Caller ID data is displayed so you can decide whether to answer the incoming call, or continue with your current conversation.



#### NOTES ABOUT CALLER ID & CALL WAITING CALLER ID

These are subscription services, provided by most regional telephone service providers. You must subscribe to these services to get the benefits of these features. If you do not subscribe to Caller ID services, you can still use your GIGAPNONE and the other features it offers.



Due to regional incompatibilities, Caller ID information may not be available for every call you receive. In addition, the calling party may intentionally block their name and phone number from being sent.



## Calls Log (Caller ID)

From the idle (OFF) mode, press **MENU**, use the  /  scroll keys to select **CALLS LOG**, then press **OK**. The Caller ID information of the most recently received call will be displayed. For example:





To scroll to other records, use the  /  scroll keys.

To dial the number displayed, you can simply press the **ON** or **SPEAKER** key.

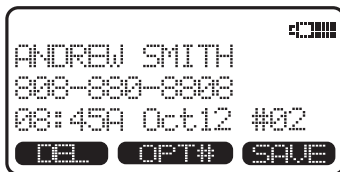
You can also press the **CID** key to access the following options ( DEL, OPT#, SAVE):



- DEL** : Select this option to delete **THIS** or **ALL** records in Caller ID memory.
- OPT#** : Select this option to display up to four possible dialing strings of the number stored in Caller ID memory. If a number is provided in the Caller ID data, the possible options to choose from will be either 7, 8, 10, or 11 digits. For example, if the original number in Caller ID memory was 808-880-8808, then the display options will be:

Use the  /  keys to make selection, and then press **DIAL**, **ON** or **SPEAKER** to dial the number.

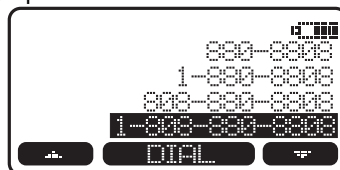



- SAVE** Select this option to save the displayed Caller ID record into Speed Dial Memory. Only Caller ID records with telephone numbers can be saved into Speed Dial Memory. If you need to modify the number after saving, see **TO EDIT A NUMBER** on page 22.

Your **v2651** stores the 50 most recent Caller ID and Call Waiting ID records in memory. As new records are stored, the oldest records are automatically deleted to make room. Therefore, you do not have to manually delete Caller ID records.

From the Handset Settings menu you can select the following options to modify:

- **RINGER VOLUME**

Select this option to adjust the ringer volume. Use the  /  scroll keys to adjust the volume up or down. A Handset will display a graphic indicator of the selected volume setting. Press **OK** to confirm your selection and return to the Handset Settings menu.

- **RINGER MELODY**

Select this option to adjust the ringer melody or tone. Use the  /  scroll keys to select from the six available tones. Press **SAVE** to confirm your selection and return to the Handset Settings menu.

- **LOW BATT TONE (preset to ON)**

Select this option to turn the Low Battery warning tone **ON** or **OFF**. Press the **OFF** or **ON** soft keys, to make your selection. Press **OK** to confirm your selection and return to the Handset Settings menu. When set to **ON**, the Handset will emit a warning tone when a Low Battery condition is detected.



- **RANGE TONE (preset to ON)**

Select this option to turn the Out of Range warning tone **ON** or **OFF**. Press the **OFF** or **ON** soft keys, to make your selection. Press **OK** to confirm your selection and return to the Handset Settings menu. When set to **ON**, the Handset will emit a warning tone whenever the Handset is taken out of range of the Base.



- **KEYPAD TONE (preset to ON)**

Select this option to turn the Keypad tones **ON** or **OFF**. Press the **OFF** or **ON** soft keys, to make your selection. Press **OK** to confirm your selection and return to the Handset Settings menu. When set to **ON**, the Handset will emit a beep whenever a key is pressed.

- **CONTRAST**

Select this option to adjust the contrast level of the Handset display. Use the  /  scroll keys to make your selection. The handset display will automatically adjust as you make your selection. Press **OK** to confirm your selection and return to the Handset Settings menu.

- **LANGUAGE (preset to ENGLISH)**

Select this option to change the display to appear in English or French or Spanish Use the  /  scroll keys to select language, then press **OK** to confirm your choice.

## Range Extender

Your **v 2651** has an enhanced feature that is designed to improve performance. If you are using your **v 2651** in an area with excessive interference, or you require a moderate increase in operating range, the Range Extender feature can help to improve both the sound quality and range. Actual range will depend on your environment.

### Range Extender (preset to AUTO)

To select the Range Extender setting, follow the procedure listed below:

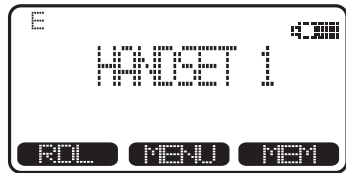
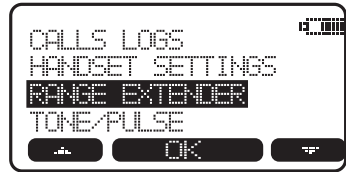

- In the idle(OFF) mode, press **MENU** and use the scroll keys to select **RANGE EXTENDER**, then press **OK**.
- There are 3 option settings in the **RANGE EXTENDER** menu:
  1. Select **OFF** to disable RANGE EXTENDER
  2. Select **ON** to enable RANGE EXTENDER. An "E" icon will appear in the upper left corner of the Handset display, indicating that RANGE EXTENDER is ON.
  3. Select **AUTO** to allow your **v 2651** to automatically monitor the signal strength between the handset and base unit, and activate whenever necessary. When RANGE EXTENDER is enabled, an "E" icon will appear in the upper left corner of the Handset display.
- Use the scroll keys to select the desired setting, and then press **OK** to confirm the selection.



**Note:** When Range Extender mode is enabled, your **v 2651** will consume more battery power. That means the standby and talk time of your Handset will be shorter.

### Tone/Pulse Selection (preset to TONE)

Use this option to select Tone dialing or Pulse dialing.

- The phone must be in the idle (off) mode.
- Select **TONE/PULSE** option from the **MENU**, then press **OK**.
- Use the  /  scroll keys to select the desired option, then press **OK**.

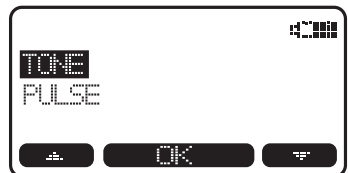

## Register and Memory

Use this option to register additional Handsets to the **v 2651** Base. You can register a total of four.

You will be prompted to enter the 15-digit Base ID code printed on the underside of the base unit. After entering this code, press **OK**. The Handset will display **SEARCHING FOR BASE**, and then **FOUND BASE** when the process is complete. See **Registration of Additional Handset**, pg. 11, for details.

Note : Base ID codes are 15 digits long and can include the following characters: 0, 1, 2, 3, 4, 5, 6, 7, 8, 9, \*, or # .

## MEM (Memory)

The **v2651** can store up to 50 names/numbers in memory. Each memory location can hold up to 32 digits and up to 16 characters for the name.

When prompted to **ENTER NAME**, use the digit keys to 'spell' the name. Each press of a particular key causes characters to be displayed in the following order:

Number Key	Characters (in order)
1	& ' , . 1
2	A B C a b c 2
3	D E F d e f 3
4	G H I g h I 4
5	J K L j k I 5
6	M N O m n o 6
7	P Q R S p q r s 7
8	T U V t u v 8
9	W X Y Z w x y z 9
0	0
*	*
#	#

**To Store a Number/Name:**

- Starting from the idle screen, enter the number you want to store in memory.

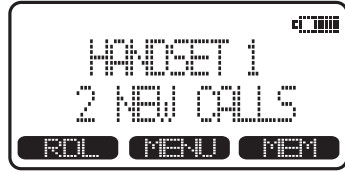

- Be sure to include long distance codes and pauses (using the **PAUSE** softkey) if necessary. When finished, Press the **MEM** softkey.

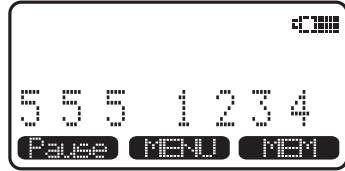

- You will then be prompted to **ENTER NAME**. Use the digit keys to 'spell' the name. If you make a mistake, press the **CLR** softkey. To enter a space press **SPACE**. When finished, press **SAVE**.



- If there is space available in memory, the number/name will be saved and the Handset will return to pre-dial mode.

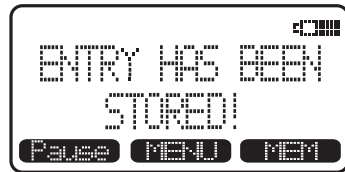

- If the memory is full the Handset will display **PHONEBOOK IS FULL** and exit to pre-dial mode without saving the entry.

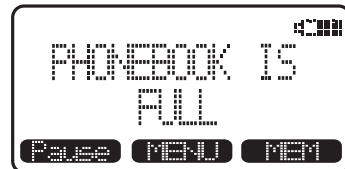

## To Search For and Dial a Number/Name:

- Starting from the idle screen, press the **MEM** softkey to review memory contents.
- Using the **▼\▲** soft keys, scroll through the memory contents in alphabetical order.
- Or, you can press the **FIND** softkey, enter the first few characters of the name and then press **FIND** to search. If you make a mistake, press **CLR** softkey. The closest match, in alphabetical order, will be displayed.
- Once you find the entry you want, simply press **ON** or **SPEAKER** to dial the number.

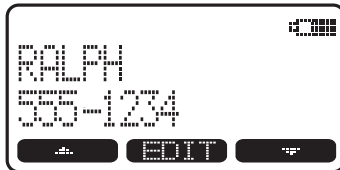
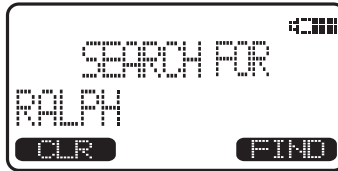
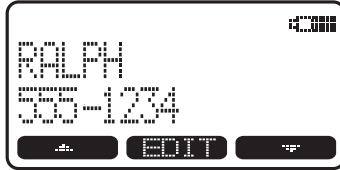

## To Delete a Number/Name:

- Using the steps from in **To Search For and Dial a Name/Number**, locate the entry you want to delete.
- Press the **EDIT** softkey. The Handset will display:

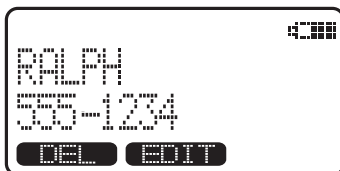
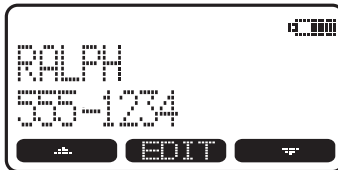

- Press the **DEL** softkey. The Handset will display:

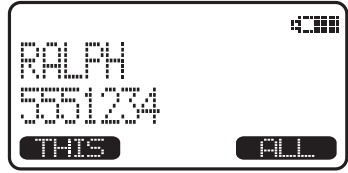

- To delete this record, press **THIS**.

- To confirm the deletion of **ALL** records, press **YES**. To exit without deleting, press **NO**.



### To Edit a Number

- Using the steps from 1 to 3 in **To Search For and Dial a Number/Name**, locate the entry you want to edit.

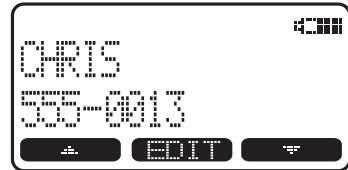

- Press the **EDIT** soft key twice.

- Press either **NAME** or **NUM** for editing.

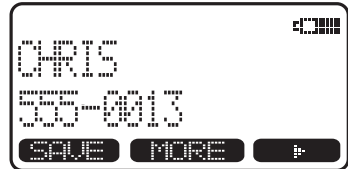

- Using the **▶** soft key, move the cursor to the character you want to edit and then enter the corrections as needed. Press **MORE** to access **DEL**, **BACK** and **PAUSE** (when editing the name-**DEL**, **BACK** and **SPACE**) functions. When finished press the **SAVE** softkey. To exit without saving, press **OFF**.

- When finished the handset will display the edited entry.

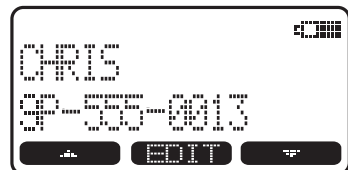

The v **2651** Base unit has several settings that can be adjusted according to your preference and system requirements.

### Select Base Ringer Melody:

- The phone must be off.
- Press the star key three times ( \* \* \* ). The Base will emit a happy tone and the **IN USE** LED will flash rapidly.
- Press the **1,2,3,4,5**, or **6** keys to select the Ringer Melody. After each key press, the Base will emit a 1- second preview of the selected ringer.
- To save the selected ringer (and exit) press # .
- To exit without saving press \* .

### Select Base Ringer Volume (and Volume OFF):

- The phone must be off.
- Press the star key three times ( \* \* \* ). The Base will emit a happy tone and the **IN USE** LED will flash rapidly.
- Press the **VOLUME** ▼\▲ to adjust the Base Ringer volume. After each press of the volume keys, the Base will emit the selected Ringer and volume setting for one second.
- To turn the Base ringer OFF, press the **VOLUME** ▼ until the ringer preview cannot be heard.
- To save the Ringer Volume selection ( and exit ) press # .
- To exit without saving press \* .



## Making Calls

From the Handset



- Press **ON** (or, **SPEAKER** to use the Handset Speakerphone feature). Dial the phone number.
- OR-
- Dial the phone number first; then press **ON** (or **SPEAKER**).
- Press **OFF** to end your call.
- OR-
- Place the Handset in the Base cradle.

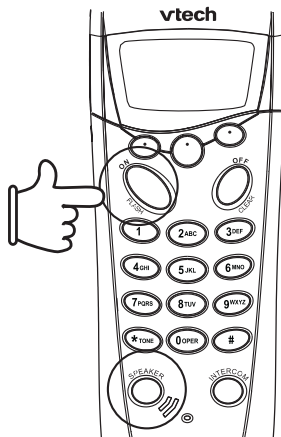

## Answering Calls

From the Handset



- Press any key except **OFF** or the soft keys. If you press **OFF** when the Handset is ringing, the ringer will be temporarily muted.
- Place the Handset in the Base cradle.
- Press **OFF** to end your call.

## Making Calls

From the Base Unit



- Press **SPEAKERPHONE**. Dial the phone number.
- Press **SPEAKERPHONE** to end your call

## Answering Calls

From the Base Unit



- Press **SPEAKERPHONE**.
- Press **SPEAKERPHONE** to end your call.

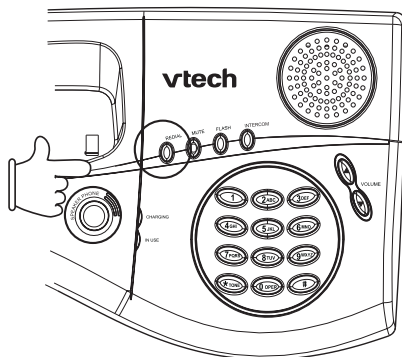

## Redial from Base Unit



- Pressing **REDIAL** will immediately dial the last number in the base unit redial memory.

Hold down the **REDIAL** key for more than 2 seconds to erase the contents in redial memory. This is to prevent the accidental dialing of the number stored in redial memory. You will hear a confirmation tone.

# Handset and Base Operation

in redial memory. This is to prevent the accidental dialing of the number stored in redial memory. You will hear a confirmation tone, redial.

## Mute Function

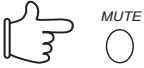

During an active call pressing either the **MUTE** soft key on the Handset or the **MUTE** key on the Base (when in speakerphone mode), will disable the microphone. Press **MUTE** key again to return to normal 2-way conversation.

## Hold Function

During an active call using the Handset, press the **HOLD** soft key to place your call on hold. Press **ON** (or **SPEAKER**) to return to the two-way conversation.

## Flash Function



You can use your **v 2651** with services such as Call Waiting. Simply press the **ON** key on the Handset to flash the line. Using the Base Speakerphone, press the **FLASH** key.

## Volume Control



### From the Handset:

During an active call, press the **VOL** soft key, then use the ◀ and ▶ soft keys to adjust the earpiece (or Handset Speaker) volume.

Notice the change in the display graph as you adjust the volume. An increase in volume will be represented by an increase in shaded area on the graph. A decrease in volume will result in a reduction of the shaded area.

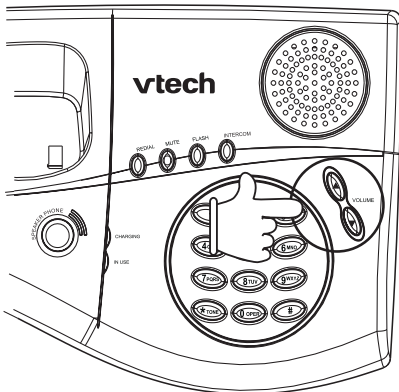

Press **OK** to confirm your setting.

### From the Base:

During an active call, press the **VOLUME ▲/▼** keys to adjust the speakerphone volume. You will hear a special tone when you reach the highest or lowest setting.

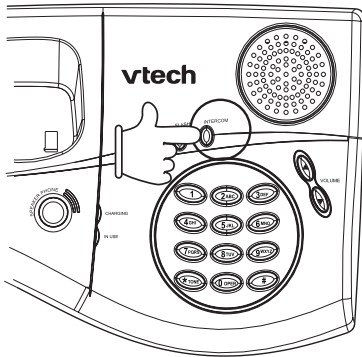

## INTERCOM



From Base to ALL Handsets:

- To page all Handset from the Base press the **INTERCOM** key. This will cause all Handsets linked with this Base to ring.
- Each Handset will display **GLOBAL CALL FROM BASE**.
- Any Handset can then answer the PAGE, and enter INTERCOM mode with the Base by pressing the **INTERCOM** key.
- To end an intercom call, press **OFF** on the Handset or **INTERCOM** on the Base.

From Base to a particular Handset :

- Press the Base **INTERCOM** key, then press by the number of the Handset you want to call (e.g. **INTERCOM 2**).
- Handset 2 can then answer the intercom call by pressing **INTERCOM** key.
- To end an intercom call press **OFF** on the Handset or **INTERCOM** on the base.

From Handset to Base :

- Press the **INTERCOM** key followed by 0.
- The Base will ring once and then automatically enter **INTERCOM** mode.
- To end an intercom call press **OFF** on the Handset or **INTERCOM** on the Base.

From Handset to Handset :

- Press the **INTERCOM** key followed by the number of the other Handset you wish to call (e.g. **INTERCOM 3**).
- Handset 3 can then answer the intercom call by pressing the **INTERCOM** key.
- To end the intercom call press **OFF** on either Handset.

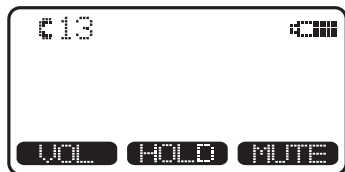

From Handset to Base/Handsets:

- Press the **INTERCOM** key followed by **\***. The initiating Handset will display **PERFORMING GLOBAL PAGE**. All registered Handsets and the Base will ring.
- To end the intercom call, press **OFF** on the Handset, or press **INTERCOM** on the Base.

## Handsfree Speakerphone Operation

Your **v 2651** handset has a built-in handsfree speakerphone. This feature allows you to stand the Handset upright on a table or desktop and have handsfree conversations. For more information, refer to **Making Calls in Handset and Base Operation**.

## Switching between the Handset Earpiece and Speakerphone

If you are using the Handset earpiece, press **SPEAKER** to continue your call using the Handset Speakerphone.

To return to the earpiece, press **SPEAKER** again.

## Base Speakerphone Operation

The Base of your **v 2651** is equipped with a full duplex speakerphone. This is a very useful feature for handsfree conversations or conference calls at the Base unit. For more information, refer to **Making Calls in Handset and Base Operation**.

## Line in Use Indication

On the Handset :

When the telephone line is currently being used by a **v 2651** Handset or the **v 2651** Base, a status message similar to this will display on idle Handset(s):

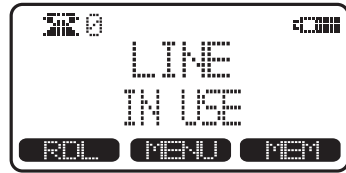

When the telephone line is currently being used by a parallel set (a telephone device other than the **v 2651** on the same line); the phone icon will remain on steadily, and **EXTENSION IN USE** will be displayed.

On the Base :

When a **v 2651** Handset or a **v 2651** Base is currently being used, the **IN USE** LED on the base will illuminate steadily. When a parallel set is currently being used, the **IN USE** LED on the base will flash.

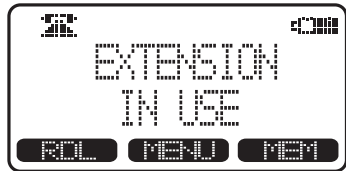

## Low Battery Indication (Handset only)

When a low battery is detected, the Battery icon will flash and a warning beep is played. The status message **LOW BATTERY** will also be displayed when the Handset is in idle mode.

## Message Waiting Indication

The **v2651** is compatible with optional voicemail service provided by many local telephone companies. If you subscribe to this service, and you have new, unplayed messages in your voicemail, a Visual Message Waiting Indicator (VMWI) signal is transmitted by your local telephone company.

When the **v 2651** detects a VMWI signal, the Handset, in the idle mode will displays.

After you check your messages, the Message Waiting screen will be turned off.



Please note that whenever new, unplayed messages are stored in your voicemail, the local Telephone Company will continue to send a VMWI signal.

## Conference Calling

The **v 2651** is capable of supporting conference calls with up to two registered Handsets, and Base unit.

To enter a conference call, simply access the line with two extensions by pressing **ON** (or **SPEAKER**) on the Handset or **SPEAKER PHONE** on the Base.

The phone icon  and two extension numbers will be displayed in the upper left corner of the Handset LCD.

## Transferring Calls

You can transfer calls on the **v 2651** system from the Base to Handset, Handset to Handset, or Handset to Base.

### Blind Transfer

You can directly transfer any active call to another **v 2651** extension without notification by doing the following steps:

- Handset or Base must be on an active call.
- Press the **INTERCOM** key followed by the number of the Handset (1,2,3,4) or Base (0) that you wish to transfer the call to.
- When the other extension answers by pressing **INTERCOM**, the call will automatically be connected to the other extension.
- An unanswered call will ring back to the originating Handset / Base if not answered within 30 seconds.

### Announced Transfer

You can perform an announced transfer (call and advise another extension) of an active call by doing the following steps:

- The transferring extension presses **OFF** to end the intercom call.
- Place the active call on **HOLD**.
- Press the **INTERCOM** key followed by the number of the Handset (1, 2, 3, 4) or Base (0) that you wish to transfer the call to.
- When the other extension answers the intercom call, explain they have an active call waiting.
- The other extension presses **ON** (or **SPEAKER**) on the Handset (or **SPEAKER PHONE** on the base) to pick up the call on hold.

## Headset Operation

Your **v 2651** cordless telephone is equipped with a 2.5mm Headset Jack for use with an optional accessory Headset for hands-free operation. If you choose to use the Headset option, you must obtain an optional accessory Headset, which is compatible with the **v 2651**.

**To purchase a Headset, call VTech Customer Service at 1-800-595-9511, and Canada at 1-800-267-7377.**

Once you have a compatible 2.5mm Headset, locate the Headset Jack on the **v 2651** Handset. Connect the plug on the Headset cord to the jack on the cordless Handset (under a small rubber flap). The plug should fit securely. Do not force the connection.

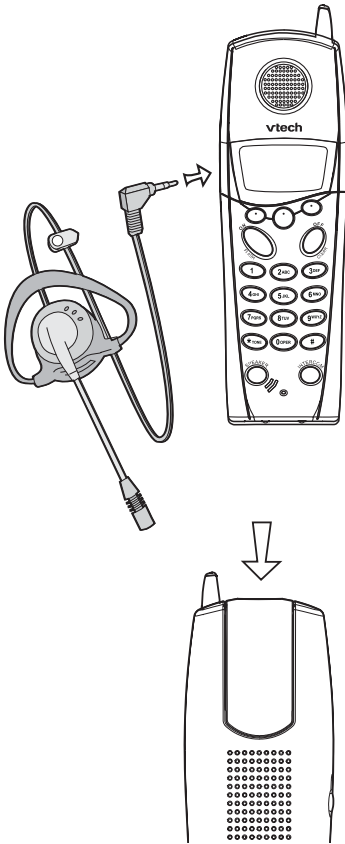

### Belt Clip

Your **v 2651** is equipped with an attached belt clip. At the top of the Handset, slide the clip away from the body of the Handset by pushing in the indent with your finger.

**CAUTION:** The Belt Clip is designed to remain attached to the Handset. Do not attempt to remove it.

### Taking Care Of Your Telephone

Your **v2651** cordless telephone contains sophisticated electronic parts, so it must be treated with care.

#### Avoid rough treatment

Place the Handset down gently. Save the original packing materials to protect your telephone if you ever need to ship it.

#### Avoid water

Your telephone can be damaged if it gets wet. Do not use the Handset outdoors in the rain, or handle it with wet hands. Do not install your Base Unit near a sink, bathtub or shower.

#### Electrical storms

Electrical storms can sometimes cause power surges harmful to electronic equipment.

For your own safety, use caution when using electric appliances during storms.

#### Cleaning your telephone

Your telephone has a durable plastic casing that should retain its luster for many years. Clean it only with a soft cloth slightly dampened with water or a mild soap. Do not use excess water or cleaning solvents of any kind.

Remember that electrical appliances can cause serious injury if used when you are wet or standing in water. If your Base Unit should fall into water, **DO NOT RETRIEVE IT UNTIL YOU UNPLUG THE POWER CORD AND TELEPHONE LINE CORDS FROM THE WALL.** Then pull the unit out by the unplugged cords.

#### Periodic cleaning of the charge contacts

For optimum performance, regularly clean the metal charge contacts located in the Base Unit charge cradle and on the bottom of the Handset. Gently rub the contacts with a clean pencil eraser. In most environments, monthly contact maintenance is sufficient.

## In Case Of Difficulty

---

If you have difficulty operating your phone, the suggestions below should solve the problem. If you still have difficulty after trying these suggestions, call Customer VTech communication at 1-800-595-9511. In Canada, call VTech Telecommunication Canada Ltd. at 1-800-267-7377.

### The Phone Doesn't Work At All

- Make sure the Power Cord is plugged in.
- Make sure the telephone line cord is plugged firmly into the Base Unit and the telephone wall jack.
- Make sure the batteries are properly charged. If the 'LOW BATTERY' message is shown, the battery pack needs charging.

### No Dial Tone

- First check all the suggestions above.
- If you still don't hear a dial tone, disconnect the Base Unit from the telephone jack and connect a different phone. If there is no dial tone on that phone either, the problem is in your wiring or local service. Contact your local telephone company.

### You Get Noise, Static, Or A Weak Signal Even When You're Near The Base Unit

- Household appliances plugged into the same circuit as the Base Unit can sometimes cause interference. Try moving the appliance or the Base Unit to another outlet.

### You Get Noise, Static, Or A Weak Signal When You're Away From The Base Unit

- You may be out of range. Either move closer to the Base, or relocate the Base Unit.
- The layout of your home may be limiting the range. Try moving the Base Unit to another position.

### The Handset Does Not Ring When You Receive A Call

- Make sure you have the Handset ringer activated. To set the ringer, see **HANDSET SETTINGS** and **BASE SETTINGS**.
- Make sure the telephone line cord is plugged firmly into the Base Unit and the telephone jack. Make sure the power cord is plugged in.
- You may be too far from the Base Unit.
- You may have too many extension phones on your telephone line to allow all of them to ring. Try unplugging some of the other phones.



### You Hear Other Calls While Using Your Phone

- Disconnect your Base Unit from the telephone jack, and plug in a regular telephone. If you still hear other calls, the problem is probably in your wiring or local service. Call your local telephone company.

### You Hear Noise In The Handset, And None Of The Keys Or Buttons Work

- Make sure the power cord is plugged in.

### Common Cure For Electronic Equipment

If the unit does not seem to be responding normally, then try putting the Handset in the cradle. If it does not seem to respond, do the following (in the order listed) :

1. Disconnect the power to the Base.
2. Disconnect the Handset battery, pack.
3. Wait a few minutes.
4. Connect power to the Base.
5. Re-install the battery pack.
6. Watch for Handset to display :

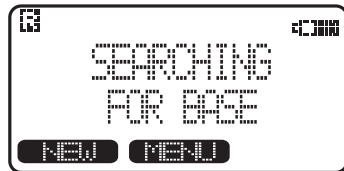

then

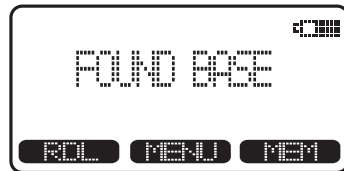

## What does this limited warranty cover?

- The manufacturer of this VTech product, VTech Communications, warrants to the holder of a valid proof of purchase (“Consumer” or “you”) that the product and all accessories provided by VTech in the sales package (“Product”) are free from material defects in material and workmanship, pursuant to the following terms and conditions, when installed and used normally and in accordance with operation instructions, This limited warranty extends only to the Consumer for Products purchased and used in the United States of America.

## What will VTech Communications do if the Product is not free from material defects in materials and workmanship during the limited warranty period (“Materially Defective Product”)?

- During the limited warranty period, VTech’s authorized service representative will repair or replace at VTech’s option, without charge, a Materially Defective Product. If we repair this product, we may use new or refurbished replacement parts. If we choose to replace this product, we may replace it with a new or refurbished product of the same or similar design. VTech will return repaired or replacement products to you in working condition. VTech will retain defective parts, modules, or equipment. Repair or replacement of Product, at VTech’s option, is your exclusive remedy. You should expect the repair or replacement to take approximately 30 days.

## How long is the limited warranty period?

- The limited warranty period for the product extends for ONE(1) YEAR from the date of purchase if we repair or replace a Materially Defective Product under the terms of this limited warranty. This limited warranty also applies to repaired or replacement Products for a period of either (a) 90 days from the date the repaired or replacement Product is shipped to you or (b) the time remaining on the original one-year warranty; whichever is longer.

## What is not covered by this limited warranty?

This limited warranty does not cover

1. Product that has been subjected to misuse, accident, shipping or other physical damage, improper installation, abnormal operation or handling, neglect, inundation, fire, water or other liquid intrusion; or
2. Product that has been damaged due to repair, alteration or modification by anyone other than an authorized service representative of VTech; or
3. Product to the extent that the problem experienced is caused by signal conditions, network reliability or cable or antenna systems; or
4. Product to the extent that the problem is caused by use with non-VTech electrical accessories; or
5. Product whose warranty/quality stickers, Product serial numbers plates or electronic serial numbers have been removed, altered or rendered illegible; or
6. Product purchased, used, serviced, or shipped for repair from outside the United States, or used for commercial or institutional purposes (including but

# Warranty Statement

---

- not limited to Products used for rental purposes); or
- 7. Product returned without valid proof of purchase (see 2 below); or
- 8. Charges for installation or set up, adjustment of customer controls, and installation or repair of systems outside the unit.

## How do you get warranty service?

- To obtain warranty service in the United States of America, call 1 800-595-9511 for instructions regarding where to return the Product. Before calling for service, please check the user's manual. A check of the Product controls and features may save you a service call.
- Except as provided by applicable law, you assume the risk of loss or damage during transit and transportation and are responsible for delivery or handling charges incurred in the transport of Product(s) to the service location. VTech will return repaired or replaced product under this limited warranty to you, transportation, delivery or handling charges prepaid. VTech assumes no risk for damage or loss of the Product in transit.
- If the Product failure is not covered by this limited warranty, or proof of purchase does not meet the terms of this limited warranty, VTech will notify you and will request that you authorize the cost of repair and return shipping costs for the repair of Products that are not covered by this limited warranty.

## What must you return with the Product to get warranty service?

1. Return the entire original package and contents including the Product to the VTech service location along with a description of the malfunction or difficulty;
2. Include "valid proof of purchase" (sales receipt) identifying the Product purchased (Product model) and the date of purchase or receipt; and
3. Provide your name, complete and correct mailing address, and telephone number.

## Other Limitations

- This warranty is the complete and exclusive agreement between you and VTech. It supersedes all other written or oral communications related to this Product. VTech provides no other warranties for this product. The warranty exclusively describes all of VTech's responsibilities regarding the product.

There are no other express warranties. No one is authorized to make modifications to this limited warranty and you should not rely on any such modification.

State Law Rights: This warranty gives you specific legal rights, and you may also have other rights which vary from state to state.

Limitations: Implied warranties, including those of fitness for a particular purpose and merchantability (an unwritten warranty that the product is fit for ordinary use) are limited to one year from date of purchase. Some states do not allow limitations on how long an implied warranty lasts, so the above limitation may not apply to you.

- In to event shall VTech be liable for any indirect, special, incidental, consequential, or similar damages(including, but not limited to lost profits or revenue, inability

## Warranty Statement

---

to use the product, or other associated equipment, the cost of substitute equipment, and claims by third parties) resulting from the use of this product, some states do not allow the exclusion or limitation of incidental or consequential damages, so the above limitation or exclusion may not apply to you.

## FCC, ACTA and IC Regulations

---

This equipment complies with Parts 15 of the Federal Communications Commission (FCC) rules for the United States. It also complies with regulations RSS210 and CS-03 of Industry and Science Canada. Operation is subject to the following two conditions: (1) this device may not cause interference, and (2) this device must accept any interference, including interference that may cause undesired operation of the device.

A label is located on the underside of the Base Unit containing either the FCC registration number and Ringer Equivalence Number (REN) or the IC registration number and Load Number. You must, upon request, provide this information to your local telephone company.

This equipment is compatible with inductively coupled hearing aids.

Should you experience trouble with this telephone equipment, please contact:

### **VTech Communications Inc.**

CUSTOMER SERVICE at 1-800-595-9511. In Canada, call VTech Telecommunications at 1-800-267-7377.

For repair/warranty information, the telephone company may ask you to disconnect this equipment from the line network until the problem has been corrected.

### **FCC Part 15**

Warning: Changes or modifications to this unit not expressly approved by the party responsible for compliance could void the user's authority to operate the equipment.

The equipment has been tested and found to comply with part 15 of the FCC rules. These limits are designed to provide reasonable protection against harmful interference in a residential installation. This equipment generates, uses and can radiate radio frequency energy and, if not installed and used in accordance with the instructions, may cause harmful interference to radio communications. However, there is no guarantee that interference will not occur in a particular installation. If this equipment does cause harmful interference to radio or television reception, which can be determined by turning the equipment off and on, the user is encouraged to try and correct the interference by one or more of the following measures:

- Reorient or relocate the receiving antenna.
- Increase the separation between the equipment and receiver.
- Connect the equipment into an outlet or on a circuit different from that to which the receiver is connected.
- Consult the dealer or an experienced radio/TV technician for help.

To comply with FCC RF exposure requirements, the Base Unit should be installed with its antenna located at 5 cm or more from persons.

# FCC, ACTA and IC Regulations

## FCC and ACTA Information

If this equipment was approved for connection to the telephone network prior to July 23,2001, it was registered with the Federal Commissions (FCC) in accordance with Part 68 of its rules. If the equipment was approved after that date, it complies with the Part 68 rules and with Technical Requirements for Connection of Equipment to the Telephone Network adopted by the Administrative Council for Terminal Attachments (ACTA). We are required to provide you with the following information.

### 1. Connection and use with the nationwide telephone network

The plug and jack used to connect this equipmet to the premises wiring and the telephone network must comply with the applicable Part 68 rules and technical requirements adopted by ACTA. A compliant telephone cord and modular plug is provided with this product. It is designed to be connected to a compatible modular jack that is also compliant. An RJ11 jack should normally be used for connecting to a single line and an RJ14 jack for two lines. See Installation Instructions in the user's manual. This equipment may not be used with Coin Telephone Lines or with Party Lines.

### 2. Product identifier and REN information

The label on the back or bottom of this equipment contains, among other things, an identifier indicating product approval and the Ringer Equivalence Number (REN). This information must be provided to your local telephone company upon request. For equipment approved prior to July 23,2001, the product identifier is preceded by the phrase "FCC Reg No." and the REN is listed separately. For equipment approved after that date, the product identifier is preceded by "US" and a colon (:), and the REN is encoded in the product identifier as the sixth and seventh characters following the colon. For example, the product identifier US:AAAEQ03T123XYZ would indicate an REN of 0.3.

The REN is used to determine how many devices you may connect to your telephone line and still have them ring when you are called. In most , but not all areas, the sum of all RENS should be five (5.0) or less, You may want to connect your local telephone company for more information.

### 3. Repair instructions

If the equipment is malfunctioning, it must be unplugged from the modular jack until the problem has been corrected. Repairs to this telephone equipment can only be made by the manufacturer or its authorized agents. For repair procedures, follow the instructions outlined under the Limited Warranty.

### 4. Rights of the telephone company

If this equipment is causing harm to the telephone network, the telephone company may temporarily discontinue your telephone service. The telephone company is required to notify you before interrupting service. If advance notice is not practical, you will be notified as soon as possible. You will be given the opportunity to correct the problem and the telephone company is required to inform you of your right to file a complaint with the FCC. Your telephone company may make changes in facilities, equipment, operation, or procedures that could affect the proper functioning of this product. The telephone company is required to notify you if such changes are planned.

## 5. Hearing aid compatibility

If this product is equipped with a corded or cordless handset, it is hearing aid compatible.

## 6. Programming/testing of emergency numbers

If this product has memory dialing locations, you may choose to store police, fire department and emergency medical service telephone number in this locations. If you do, please keep three things in mind:

a. We recommend that you also write the telephone number on the directory card, so that you can still dial the emergency number manually if the memory dialing feature doesn't work.

b. This feature is provided only as a convenience, and the manufacturer assumes no responsibility for customer reliance upon the memory feature.

c. Testing the emergency telephone numbers you have stored is not recommended. However, if you do make a call to an emergency number:

- You must remain on the line and briefly explain the reason for the call before hanging up.
- Programming/testing of emergency numbers should be performed during off-peak hours, such as in the early morning or late evening, when the emergency services tend to be less busy.

## IC (Industry Canada)

This telephone is registered for use in Canada.

### Notice:

This equipment meets the applicable Industry Canada Terminal Equipment Technical Specifications. This is confirmed by the registration number. The abbreviation, IC, before the registration number signifies that registration was performed based on a Declaration of Conformity indicating that Industry Canada technical specifications were met. It does not imply that Industry Canada approved the equipment.

### Notice:

The Ringer Equivalence Number (REN) for this terminal equipment is 0.1. The REN assigned to each terminal equipment provides an indication of the maximum number of terminals allowed to be connected to a telephone interface. The termination on an interface may consist of any combination of devices subject only to the requirement that the sum of the Ringer Equivalence Numbers of all the devices does not exceed five.

Before installing this equipment, users should ensure that it is permissible to be connected to the facilities of the local telecommunications company. The equipment must also be installed using an acceptable method of connection. The customer should be aware that compliance with the above conditions may not prevent degradation of services in some situations.

Repairs to certified equipment should be made by an authorized Canadian

## FCC, ACTA and IC Regulations

---

maintenance facility designated by the supplier. Any repairs or alterations made by the user to this equipment, or equipment malfunctions, may give the telecommunications company cause to request the user to disconnect the equipment.

Users should ensure for their own protection that the electrical ground connections of the power utility, telephone lines and internal metallic water pipe system, if present, are connected together. This precaution may be particularly important in rural areas.

### **Caution :**

Users should not attempt to make such connections themselves, but should contact the appropriate electrical inspection authority, or electrician, as appropriate.

Your **v 2651** is designed to operate at the maximum power allowed by the FCC and IC. This means your Handset and Base Unit can communicate only over a certain distance - which will depend on the location of the Base Unit and Handset, weather, and the construction and layout of your home or office.

## **The RBRC® Seal**



The RBRC® Seal on the nickel-cadmium battery indicates that VTech Communications, Inc. is voluntarily participating in an industry program to collect and recycle these batteries at the end of their useful lives, when taken out of service within the United States and Canada.

The RBRC® program provides a convenient alternative to placing used nickel-cadmium batteries into the trash or municipal waste, which may be illegal in your area.

VTech's participation in RBRC® makes it easy for you to drop off the spent battery at local retailers participating in the RBRC® program or at authorized VTech product service centers. Please call **1-800-8-BATTERY™** for information on Ni-Cd battery recycling and disposal bans/restrictions in your area. VTech's involvement in this program is part of its commitment to protecting our environment and conserving natural resources.

**RBRC® is a registered trademark of Rechargeable Battery Recycling Corporation.**



# Technical Specifications

---

## FREQUENCY CONTROL

Crystal controlled  
PLL synthesizer

## TRANSMIT FREQUENCY

2401.056 - 2481.408 MHz

## RECEIVE FREQUENCY

2401.056 - 2481.408 MHz

## CHANNELS

95 Channels

## NOMINAL EFFECTIVE RANGE

Maximum power allowed by FCC. Actual operating range may vary according to environmental conditions at the time of use.

## SIZE

Handset : 171.5mm x 53mm x 45mm

Base : 184.2mm x 142mm x 70.10mm

## WEIGHT

Handset : 134 grams

Base : 360 grams

## POWER REQUIREMENTS

Handset : 600mAh NiCd  
Battery Pack

Base : 9 VDC @ 500mA

## MEMORY

Directory: 50 Memory locations;  
32 digits per location

CID : Alphanumeric Display;  
50 Memory locations

**SPECIFICATIONS ARE TYPICAL  
AND MAY CHANGE WITHOUT  
NOTICE.**

# Table Of Contents

---

Important Safety Instructions .....	1
<b>Introduction</b> .....	3
Parts Check List .....	4
The Handset Layout .....	5
The Base Unit Layout .....	6
<b>Getting Started</b> .....	7
Setup .....	7
Charging of Handset Battery Pack .....	9
Registration of Additional Handsets .....	12
<b>Basic Operation</b> .....	13
Handset and Base Indicators .....	13
Soft Menu Functions .....	15
Calls Log (Caller ID) .....	16
Handset Settings .....	17
Range Extender .....	18
Register and Memory .....	19
Memory .....	20
Base Settings .....	23
<b>Advanced Operations</b> .....	24
Handset and Base Operation .....	24
<b>Additional Information</b> .....	29
Headset Operation .....	29
Maintenance .....	30
In Case Of Difficulty .....	31
Warranty Statement .....	33
FCC, ACTA and IC Regulations .....	36
The RBRC® Seal .....	39
Technical Specifications .....	40

