



Important Safety Instructions

When using your telephone equipment, basic safety precautions should always be followed to reduce the risk of fire, electric shock and injury, including the following:

1. Read and understand all instructions.
2. Follow all warnings and instructions marked on the product.
3. Unplug this product from the wall outlet before cleaning. Do not use liquid cleaners or aerosol cleaners. Use a damp cloth for cleaning.
4. Do not use this product near water (for example, near a bath tub, kitchen sink, or swimming pool).
5. Do not place this product on an unstable cart, stand, or table. The product may fall, causing serious damage to the product.
6. Slots and openings in the cabinet and the back or bottom are provided for ventilation. To protect it from overheating, these openings must not be blocked by placing the product on the bed, sofa, rug, or other similar surface. This product should never be placed near or over a radiator or heat register. This product should not be placed in a built-in installation where proper ventilation is not provided.
7. This product should be operated only from the type of power source indicated on the marking label. If you are not sure of the type of power supply to your home, consult your dealer or local power company.
8. Do not allow anything to rest on the power cord. Do not locate this product where the cord will be abused by persons walking on it.
9. Never push objects of any kind into this product through cabinet slots as they may touch dangerous voltage points or short out parts that could result in a risk of fire or electric shock. Never spill liquid of any kind on the product.
10. To reduce the risk of electric shock, do not disassemble this product, but take it to an authorized service facility. Opening or removing cabinet parts other than specified access doors may expose you to dangerous voltages or other risks. Incorrect reassembling can cause electric shock when the appliance is subsequently used.
11. Do not overload wall outlets and extension cords as this can result in the risk of fire or electric shock.
12. Unplug this product from the wall outlet and contact VTECH under the following conditions:
 - A. When the power supply cord or plug is damaged or frayed.
 - B. If liquid has been spilled into the product.
 - C. If the product has been exposed to rain or water.
 - D. If the product does not operate normally by following the operating instructions. Adjust only those controls that are covered by the operating instructions, because improper adjustment of other controls may result in damage and will often require extensive work to restore the product to normal operation.
 - E. If the product has been dropped and the cabinet has been damaged.
 - F. If the product exhibits a distinct change in performance.
13. Avoid using a telephone (other than a cordless type) during an electrical storm. There may be a remote risk of electric shock from lightning.



Important Safety Instructions

14. Do not use this or any cordless telephone to report a gas leak in the vicinity of the leak.



If you have questions about this product, or if you're having difficulty with setup or operation, do not return your phone to the store. Call our Customer Support Center at

1-800-595-9511

In Canada, call

1-800-267-7377

SAVE THESE INSTRUCTIONS



Introduction

This is an advanced cordless telephone, capable of supporting 2 Handsets.

This manual is designed to familiarize you with this cordless telephone. We strongly recommend you read the manual before using your phone.





Parts Check List

1. Base Unit
2. Handsets
3. Handset Charger
4. Base AC Power Adapter
5. Telephone Line Cord
6. Belt Clip
7. Base Wall Mounting Bracket
8. Charger Wall Mounting Bracket
9. Owner's Manual
10. Battery Cells

To purchase replacement battery cells, call VTech Communications, Inc. at 1-800-595-9511. In Canada, call VTech Telecommunications Canada Ltd. at 1-800-267-7377.

Note : Use only VTech batteries P/N 80-5380-00-00 or equivalent AAA NiMH rechargeable batteries.



Handsets

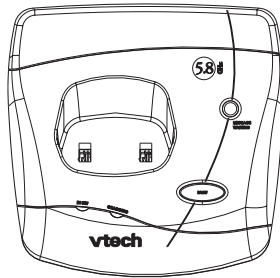

Base Unit

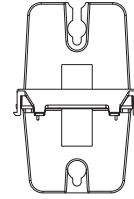

Wall Mounting Bracket

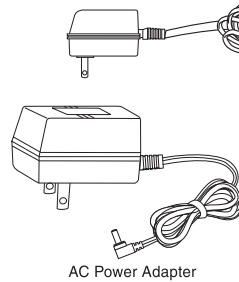

AC Power Adapter

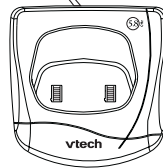

Handset Charger

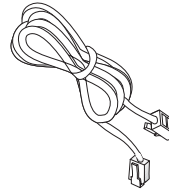

Telephone Cord



Charger Wall Mounting Bracket



Belt Clip

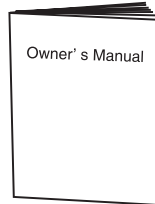

Owner' s Manual

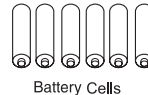

Battery Cells



The Handset Layout

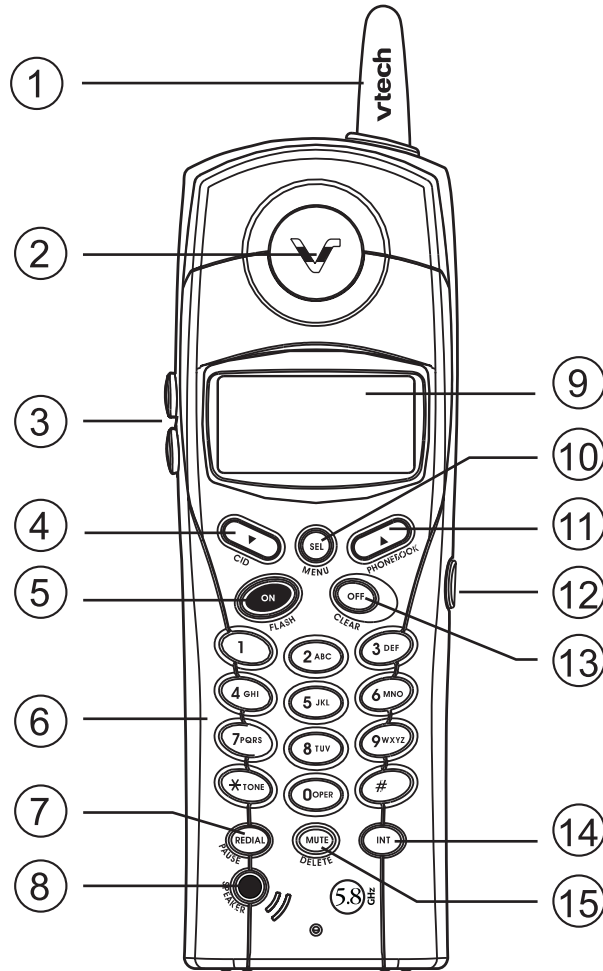

- 1. Antenna
- 2. Earpiece
- 3. Volume Control
- 4. CID (Scroll Up)
- 5. On (Flash)
- 6. Dialing Keys (0-9, *, #)
- 7. Redial (Pause)

- 8. Speakerphone
- 9. LCD Display
- 10. Select (Menu)
- 11. Phonebook (Scroll Down)
- 12. Headset jack (2.5mm)
- 13. Off (Clear)
- 14. Intercom
- 15. Mute (Delete)



The Base Unit Layout

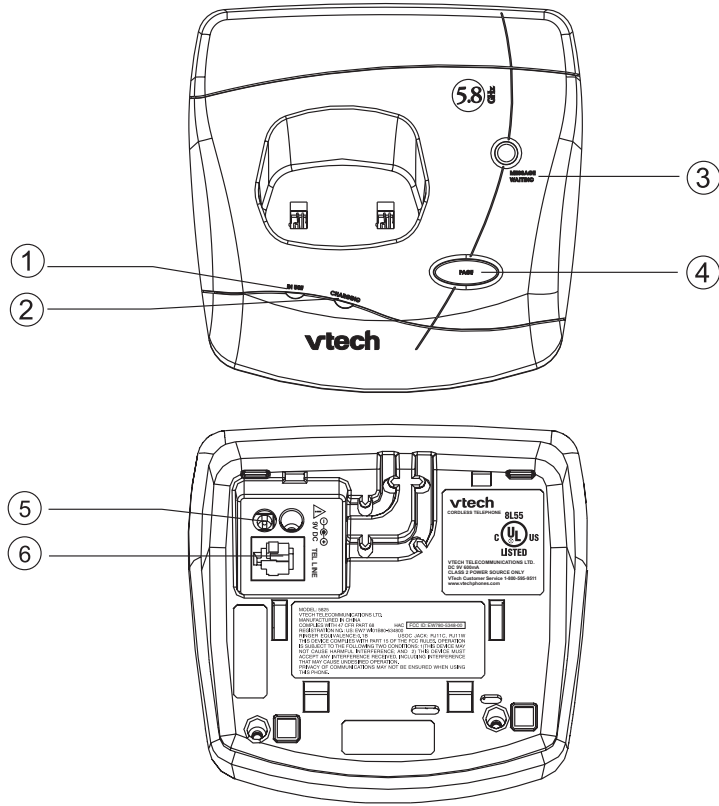

- 1. In Use LED
- 2. Charging LED
- 3. Message Waiting LED
- 4. Page key
- 5. DC Connector
- 6. Telephone Jack



Setup

Connecting power to Base Unit/Handset Charger

1. Plug the AC power adapter into an electrical outlet, and the DC connector into the bottom of the Base Unit.

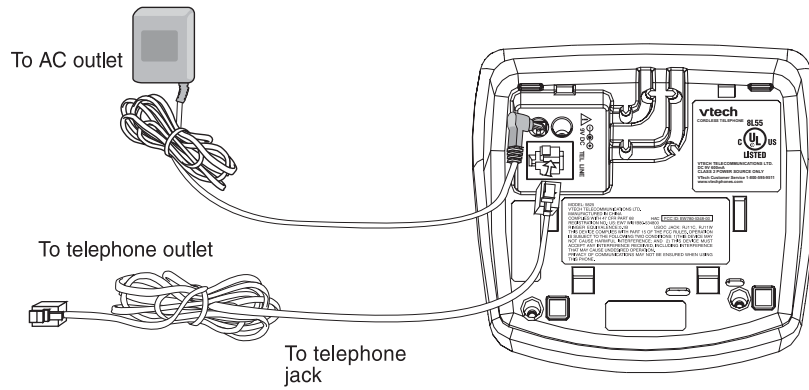

2. Choose the location for your Handset Charger, and plug its power supply into an electrical outlet.

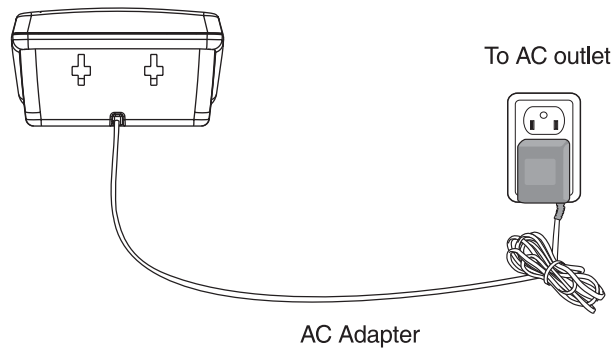

Installation of Battery Cells in Handset

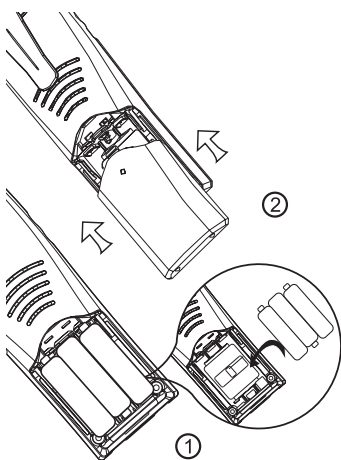

Follow the steps below:

1. Place the new battery cells in the handset with the positive and negative poles aligned in the battery compartment.
2. Place the battery cover by sliding it upwards
3. If the new battery cells are not already charged, place the Handset in its Charger, and allow it to charge for 12 hours. After initial charge, a maintenance charge of 8 hours should be sufficient.

Charging of the Handset Battery Cells

The Handset of your cordless telephone is powered by rechargeable battery cells. It charges automatically whenever the Handset is in its charger.

You should charge the battery pack for 12 hours when you first receive your phone. You'll know the battery pack needs charging when:

- The low battery message is displayed :
- The Handset seems completely dead, the LCD is completely clear and does not activate when you press the keys.



IMPORTANT:

1. Do not dispose of battery cell in a fire, the cell may explode.
2. Do not open or mutilate the battery cell. Toxic substances may be released, causing harm to eyes or skin.
3. Exercise care in handling battery cell in order to prevent an accidental short of the charge contacts, potentially causing the battery pack to overheat.
4. Do not dispose of this battery cell into household garbage. Please refer to the information concerning proper battery recycling.
5. Do not charge the battery cell with other electrical device.



Setup

Connecting to phone line

Plug one end of the telephone line cord into the jack on the back of the Base Unit.

IMPORTANT:

Plug the other end of this cord into the wall jack.

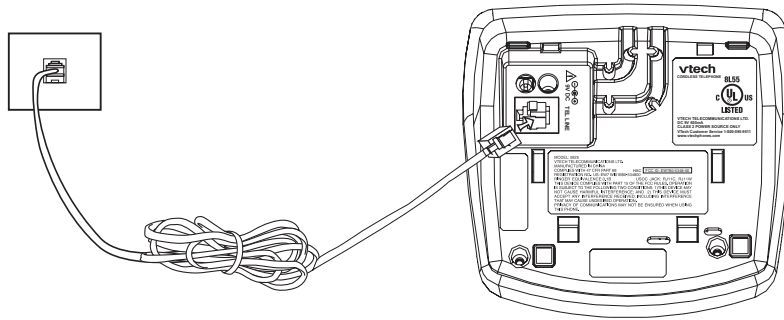

Checking for dial tone

After the battery is charged, press **ON** on the Handset. The LCD displays ACTIVE and shows a call timer. and you will hear dial tone. If not, see **In Case of Difficulty**.

Tone/Pulse selection

Your phone is preset for tone dialing. See **Handset Settings** for details.

CAUTION: Use only the VTech power supply provided with your telephone.

FOR MAXIMUM PERFORMANCE OF YOUR CORDLESS TELEPHONE SYSTEM:

1. Choose a central location for your Base Unit.
2. Install your Base Unit and Extension Handsets way from electronic equipment, such as personal computers, television sets and microwave ovens.
3. In locations where there are multiple cordless telephones, separate Base Units as much as possible.
4. Install your telephone equipment away from heat sources and sunlight.
5. Avoid excessive moisture, dust or extreme cold.

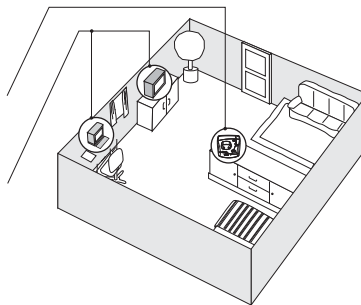

Wall Mounting

The Wall Mount brackets are designed for use on standard wall mount plates only. Wall mounting is optional.

1. Plug the AC adapters into an electrical outlet, and the DC connector to the bottom of the Base Unit.
2. Connect the telephone line cord to the jack on the bottom of the Base Unit, and the other end to the wall jack.
3. Line up the tabs on the wall mount adapters with the holes on the bottom of the Base Unit/back of the Handset Charger. Snap the wall mount bracket firmly in place.
4. Mount the Base Unit/Handset Charger on the wall. Position the Base Unit/Handset Charger so the mounting studs will fit into the holes on the wall mount bracket. Slide Base Unit/Handset Charger down on the mounting studs until it locks into place.

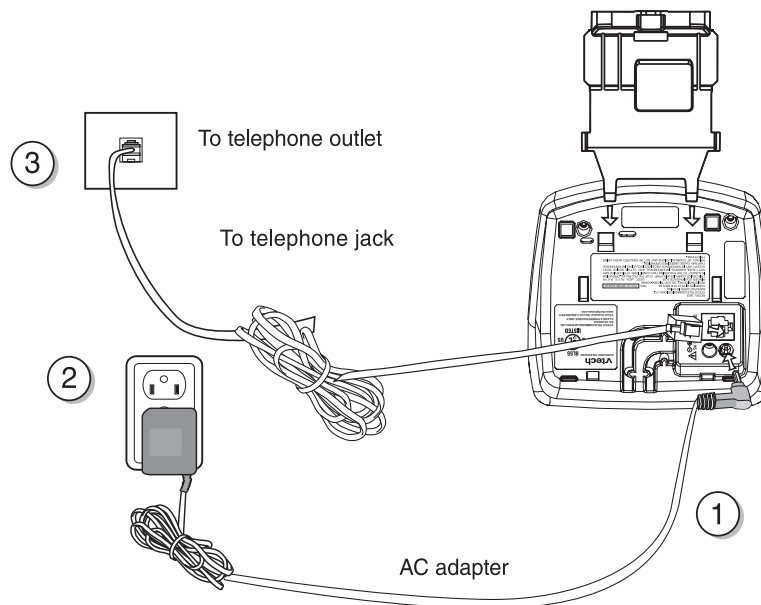



Handset and Base Indicators

Handset Icons

Icon	Description
MUTE	<ul style="list-style-type: none"> Turns on when the microphone is muted.
NEW	<ul style="list-style-type: none"> Turns on when there are new call log entries.
18/0818:58 AM PM	<ul style="list-style-type: none"> CID date and time information.
	<ul style="list-style-type: none"> Turns on when the ringer is muted.
	<ul style="list-style-type: none"> Low battery indicator and charging indicator.

Handset LEDs

LED	Description
SPEAKERPHONE	<ul style="list-style-type: none"> LED is on when in a handsfree mode.

Base LEDs

LED	Description
IN USE	<ul style="list-style-type: none"> On when the phone is off hook. Flash when it is no phone line. Flashes when an extension phone or the Answering Machine is off hook.
CHARGING	<ul style="list-style-type: none"> On when the Handset is charging in the cradle.
MESSAGE WAITING	<ul style="list-style-type: none"> On when Voice mail has been detected.



Handset Operation

Making Calls

- Press **ON** (or, **SPEAKERPHONE** to use the Handset Speakerphone feature). Dial the phone number.
- OR-
- Dial the phone number first; then press **ON** (or **SPEAKERPHONE**).
- Press **OFF** to end your call.

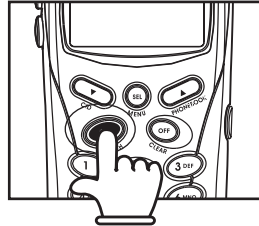

Answering Calls

- Press any key except **OFF** and the softkeys.
- Press **OFF** to end your call.

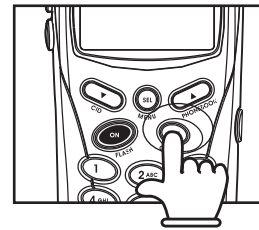

How to Adjust the Handset Volume (also applies to the Handset Speakerphone and Headset)

- The **volume** control is on the **left** edge of the Handset. During a call, press **▲** or **▼** key to adjust the listening volume to a comfortable level.

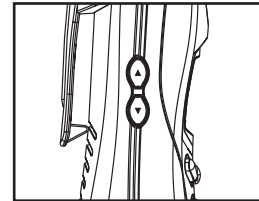

NOTE: The procedure is the same for the Handset earpiece, Speakerphone and Headset.

Flash Function

- You can use your **ip 5825** with services such as Call Waiting. Simply press the **ON/FLASH** key to flash the line.

Redial Funtion

- Press **REDIAL/PAUSE** to display the last telephone number dialed from the Handset. Use **▲** or **▼** to scroll through the 5 previously dialed numbers.
- When reach the desired number, press **ON** or **SPEAKER** to dial.
- Press **OFF** will quit the redial review list.

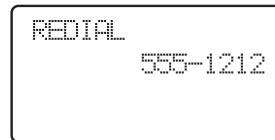

Mute Function

- During an active call, press **MUTE/DEL** key will disable the microphone. The screen will display:
- Press **MUTE/DEL** again to return to normal 2-way conversation.

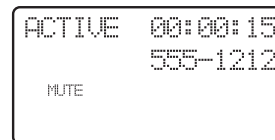



Handset Operation

Intercom Call

- From the idel (OFF) mode, press **INT**. The Handset will display:
- The other Handset will be ringed and the screen will display:
- Press **INT** or **SPEAKER** to answer the interzcom call. The screens will display:
- Press **INT** or **SPEAKER** again to end the call.
- If the other Handset is out of range, turned off or on an external call, a busy tone will be heard in the earpiece, or through the speaker if in hands free mode. The display will also show the following.

CALLING
OTHER HANDSET

OTHER HANDSET
IS CALLING

INTERCOM
OTHER HANDSET

INTERCOM END

UNABLE TO CALL
AT THIS TIME

Call Forward and Call Transfer

An external call can be forwarded or transferred from one Handset to the other Handset. The difference between forward and transfer depends on if the sending Handset needs to talk with the receiving Handset, before the external call is actually sent to the other Handset.

- A Handset, says HS1, on an external call can forward it to the other Handset, says HS2, by **press and hold** the **INT** key. The display of HS1 will initially show:
- The other Handset (HS2) can press **ON** to answer the call.

CALL FORWARDED



Handset Operation

NOTE: If the other Handset (HS2) do not response in about 30 seconds, the external call will be returned to the Handset (HS1) and the display will show:



Call Transfer

- A Handset, says HS1, on an external call can forward it to the other Handset, says HS2, by **press** the **INT** key.

NOTE: The external call is put on hold automatically.

- Destination Handset (HS2) will ring, showing an intercom call.
- Press **ON** on the destination Handset (HS2) will answer the intercom call.
- Discussing external call with other Handset.
- Press **OFF**, on the first Handset (HS1), to transfer external call to other Hand set.

NOTE: If there is no answer on the destination Handset, the first Handset can be reconnected to the held call by pressing **ON** to reconnect to the external call.

Conference Call

It is possible to establish a conference between two Handsets and the external line.

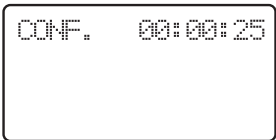

If a Handset already has a connection to the external line, and another Handset goes off-hook, a conference is immediately established. Both Handsets will show:

Base Operation

From the Base Unit, you can use **PAGE** key to page the Handsets.

- When the Handset is in idle, press **PAGE**. The Handsets will display:
- To end the page at the Base, press **PAGE** again.
- To end the page at the Handset, press **OFF**.





Phone Book Operation

The **ip 5825** can store up to 50 names/numbers in memory. Each memory location can hold up to 32 digits and up to 16 characters for the name.

NOTE: The Handsets share a common phone book, which is stored in the base station. This means that entries inserted by one Handset are available for both Handsets, and if one deletes a phone book entry, it will disappear from both Handsets.

When prompted to **ENTER NAME**, use the digit keys to 'spell' the name. Each press of a particular key causes characters to be displayed in the following order:

key	Characters by number of key presses								
1	1	2	3	4	5	6	7	8	9
2	space	1							
3	A	B	C	2	a	b	c		
4	D	E	F	3	d	e	f		
5	G	H	I	4	g	h	i		
6	J	K	L	5	j	k	l		
7	M	N	O	6	m	n	o		
8	P	Q	R	S	7	p	q	r	s
9	T	U	V	8	t	u	v		
0	W	X	Y	Z	9	w	x	y	z
*	0								
#	*	?	!	/	()			
	#	'	,	-	.	&			

The phone book is entered via the menu, as described below or by pressing the ▲ key in idle (quick access key) whereby the Handset jumps directly to the phone book search menu.

The phone book is accessed as follows:

- Press **SEL**, to enter the menu.
- Press **SEL** again to enter the phone book sub-menu.

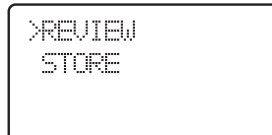



Phone Book Operation

Storing a new entry

- Followed the steps in page 13 to enter the Phone Book sub-menu. Press (upper arrow) or (down arrow) to scroll to **STORE** then press **SEL**.

```
>STORE
REVIEW
```

- Enter the number you want to store in memory. Press **DELETE** key to backspace.

```
STORE NUMBER
123-3457-
```

- In case the number exceeds 16 digits, the top line will be used to show the entire number. Press **SEL** to confirm the number.

```
1233-
45-789-123-1456..
```

NOTE: If there is duplicate number in the Phone Book, the display will show:

```
NUMBER ALREADY
IN PHONE BOOK!
```

- You will then be prompted to **ENTER NAME**. Use the digit keys to 'spell' the name. If you make a mistake, press the **DELETE** key to backspace. When finished, press **SEL**.

```
STORE NAME
-
```

- If there is space available in Phone Book, the number/name will be saved and the Handset will return to pre-dial mode.

- If the Phone Book is full, the Handset will display **PHONEBOOK IS FULL** and exit the pre-dial mode without saving the entry.

```
PHONEBOOK IS FULL
ALL
Pause MENU MEM
```

Reviewing/Dialing from the phone book

A number can be recalled and dialed from the phone book by:

- Followed the steps in page 13 to enter the Phone Book sub-menu. With the **REVIEW** in the first line, press **SEL**. The first phone book entry will be shown.

```
Kevin James
432-5434
```



Phone Book Operation

- Scroll through the Phone Book entries using ▲ and ▼ keys or enter first character of the name to be searched (using the dial digit keys) and continue navigating using the ▲ or ▼ as scroll keys, until you reach the entry to be dialed.

```
John Smith
      555-1212
```

- Press **ON** or **SPEAKER**, to dial the number.

```
ACTIVE 00:00:10
      555-1212
```

editing a Phone Book Entry

- Follow the two steps in Reviewing/Dialing a phone book entry to reach the entry to be edited.

```
John Smith
      555-1212
```

- Press **SEL** to enter number edit mode.

```
EDIT NUMBER
      123-4567_
```

- Press **DELETE** to backspace then press the digit for the correct number.

```
EDIT NAME
John  _
```

- Press **SEL** to edit mode. Press **DELETE** key to backspace and use the digit keys to enter the name

- Press **SEL** to confirm change.

```
John Smith
      123-4567
```

Delete a phone book entry

- 1) Follow the two steps in Reviewing/Dialing a phone book entry to reach the entry to be deleted.

```
John Smith
      555-1212
```

- 2) Press **DELETE** key then the screen will ask **DE LETE?**

```
Kevin James
      432-5434
```

- 3) To confirm the deletion, press **SEL**. To exit with out deleting press **OFF**.



Calls Log (Caller ID - Call Waiting)

Caller ID - Call Waiting ID

Your **ip 5825** is capable of displaying the name and/or number of the party calling before you answer the phone (**Caller ID**). It is also capable of displaying Caller ID information in conjunction with a Call Waiting alert signal (**Call Waiting Caller ID**). With Call Waiting Caller ID, the Caller ID data is displayed so you can decide whether to answer the incoming call, or continue with your current conversation.

NOTES ABOUT CALLER ID & CALL WAITING CALLER ID

These are subscription services, provided by most regional telephone service providers. You must subscribe to these services to get the benefits of these features. If you do not subscribe to Caller ID services, you can still use your **ip 5825** and the other features it offers.

Due to regional incompatibilities, Caller ID information may not be available for every call you receive. In addition, the calling party may intentionally block their name and phone number from being sent.

- As new Caller ID/Call Waiting ID records are received, your Handsets displays will alert you to the new Caller ID records, for example:



- After you review all new Caller ID records, the **NEW** call indication will be turned off and the screen will show the total number of record.

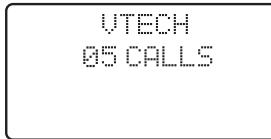

- If the call log is full, the oldest entry is deleted to make room for the new call. If the call log is empty when you try to enter to Call Log review, a message the following message is displayed:



Reviewing Caller ID

You can review the caller ID record via the menu, as described below or by pressing the ▼ key in idle (quick access key) whereby the Handset jumps directly to the caller ID review.



- In idle mode, press **SEL** to enter the menu.
- Press ▼ key to scroll to **CALL LOG** option.



Calls Log (Caller ID - Call Waiting)

- Press **SEL** again to confirm. Use ▲ or ▼ to scroll through the Call Log entries.

```

John Smith!
123-4567
2/2311:59
  
```

NOTE: '!' symbol in the right hand side of the first line indicates the call is not yet reviewed.

Storing a Caller ID

- Follow the steps in **Reviewing Caller ID** to scroll to the record to be stored.
- Press **SEL** then you will prompted to **EDIT NAME**. Use the digit keys to 'spell' the name. If you make a mistake, press the **DELETE** key to backspace. When finished, press **SEL**.
- You will hear a happy tone then the screen will display:

```

EDIT NAME
John _
  
```

```

ADDED TO
PHONE BOOK
8/12 6:20PM
  
```

- If the phone number already exists in the phone book, the entry will not be stored, and the screen will show:

```

NUMBER ALREADY
IN PHONE BOOK!
  
```

- If the phone book is full, the screen will show:

```

PHONE BOOK
IS FULL!
  
```

- If both name and number is missing, for example as in a private listing, the request will be rejected with the message:

```

UNABLE TO SAVE
IN PHONE BOOK!
  
```

Dialing from Caller ID

- Follow the steps in **Reviewing Caller ID** to scroll to the entry to be dialed.
- Press **ON** or **SPEAKERPHONE** key to dial the number.

```

John Smith!
123-4567
2/2311:59
  
```

Deleting Caller ID

- Follow the steps in **Reviewing Caller ID** to scroll to the record to be deleted.
- Press **DELETE** key to delete the desired record.

```

John Smith!
123-4567
2/2311:59
  
```



Calls Log (Caller ID - Call Waiting)

- To delete all the Caller ID records, press and hold the **DELETE** key. The screen will ask you **DELETE ALL CALL LOG?** Press **SEL** for confirmation. Or, press **OFF** to return to the CID record previously displayed.

DELETE ALL
CALL LOG?





Quick Dialing

Up to 10 'quick dial numbers may be entered into each Handset. It is possible to 'quick dial' numbers with just a single key press.

The quick dial list in each Handset is unique to that Handset and is not shared with the other Handset.

Entering a Quick Dial number

- Press **SEL** when the Handset is idle to enter the menu system.
 - Move down to the quick dial option by pressing the ▼ key.
 - Then press **SEL** to enter the quick dial sub menu.
 - Select a quick dial key location using the 0-9 keys. If that location is empty, the screen will show:
 - Then you will be prompted to enter a phone number to be dialed by following:
 - Enter the number and name by following the steps in Storing a ndw entry in page 14.
- OR
- You can press (up arrow) to select an entry from the Phone Book.
 - Press (up arrow) or (down arrow) to scroll through the Phone Book.
 - Press SEL to copy the stored number to the quick dial number.
- OR
- You can press (down arrow) to select an entry from the Call Log.
 - Press (up arrow) or (down arrow) to scroll through the Call Log.

>PHONE BOOK
CALL LOG

>QUICK DIAL
RING VOLUME

SELECT QUICK
DIAL NUMBER

QUICK DIAL ×
IS EMPTY!

STORE NUMBER
.....



Quick Dialing

- Press **SEL** to copy the stored number to the quick dial number.

You are presented with the call log review screen. You can navigate to a desired entry as describe in the call log section. Pressing **SEL** will copy the phone number shown into the quick dial number.

- Press **RDL** to select an entry from the redial list.

You are presented with the call log review screen. You can navigate to a desired entry as describe in the call log section. Pressing **SEL** will copy the phone number shown into the quick dial number. If all cases, while reviewing phone book, call log or redial list to copy to the quick dial, pressing **OFF** will return the user to the quick dial number entry screen.

- Press **SEL** to confirm the number. Once confirmed, a quick dial number cannot be edited, only dialed or deleted.

Reviewing quick dial numbers

- Follow the first 3 steps in **Entering a Quick Dial Number** to enter the Quick Dial sub-menu.

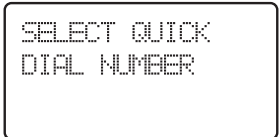

- Select a quick dial key location using the 0-9 keys. If that location has a number assigned to it, the display will show, for example:

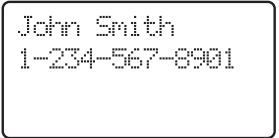

- If the location is empty, the display will show:
or



At this point, you have the following options:

- Press **OFF** to return to the main menu.
- Press **0-9** to review another quick dial location.
- Press **SEL** to edit the currently shown location. The procedure to edit the number is the same as for editing a phone book number.

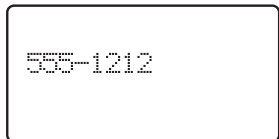

- 3) Press **SEL**, to enter the Handset name sub-



Quick Dialing

- Press **DEL** to delete the currently shown location. The following will be shown:

Where x is the quick dial location number. Pressing **OFF** will return to the quick dial review as shown above.

Pressing **SEL** will confirm the deletion and will be shown, indicating the location has been deleted.

- Press **ON** or **SPK** to dial the displayed number.

CONFIRM DELETE
QUICK DIAL x

Dialing a Quick Dial number

A quick dial number can be dialed in two ways.

1. While reviewing the quick dial numbers as previously shown.
2. While the Handset is idle or in pre-dial, as follows:

While the Handset is idle the user can perform a quick dial by holding down the desired quick dial location key (0-9). If the location is empty then

the message:
will be shown for a few seconds before returning to the idle or pre-dial screen.

QUICK DIAL x
IS EMPTY!

- If the location does have an entry, then that number will be added to any pre-dialed digits and the phone will go off-hook and begin dialing.
- Follow the first 2 steps in **Reviewing Quick Dial Number** to reach the quick dial numbers to be dialed.
- Press **ON** or **SPEAKER** to dial the number.
- OR -
- While the Handset is in idle, press and hold the desired quick dial location key (0-9).

NOTE: If the location is empty, the screen will show **QUICK DIAL NOT ASSIGNED** for a few seconds then returning to the idle screen.



Quick Dialing

Editing a Quick Dial Number

- Follow the first 2 steps in **Reviewing Quick Dial Number** to reach the quick dial numbers to be edited.
- Press **SEL** then you will be prompted to **EDIT NUMBER**. Use **DEL** key to back-space and press the digit keys to enter the number.
- Press **SEL** again for confirmation.

John Smith
1-234-567-8901

EDIT NUMBER
1-234-567-8901

John Smith
3-456-789-0123

Deleting a Quick Dial Number

- Follow the first 2 steps in **Reviewing Quick Dial Number** to reach the quick dial numbers to be deleted.
- Press **DEL** key then the display will show:
- To confirm, press **SEL** then the display will show **QUICK DIAL x IS EMPTY!**. If no, press **OFF** to quit without deleting the quick dial number.

John Smith
1-234-567-8901

CONFIRM DELETE
QUICK DIAL x

QUICK DIAL x
IS EMPTY!



Handset Settings

If the location does have an entry, then that number will be added to any pre-dialed digits and the phone will go off-hook and begin dialing.

Audio Volume

Audio volume is adjusted during an active call by the following key sequence:

Pressing the volume ▲ or ▼ keys on the side of the unit. Separate volume settings are maintained for normal, handsfree and Headset modes. When the volume keys are pressed during a call the screen will show:

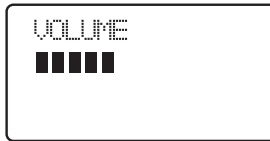

As the volume is increased, the number of blocks shown will increase. As the volume is decreased fewer blocks will be shown.

Ringer Volume

- From the idle (**OFF**) mode, press **SEL** then ▲ or ▼ key to **RINGER VOLUME**.
- Press **SEL** again. The current ringer volume will be shown:
- Press ▲ and ▼ keys or enter digit 0-6 to the desired ringer volume. The current ring tone is played and the volume bar is increased/decreased each time the setting is adjusted. At the lowest setting, the Handset will not ring when a call comes in and the display will show:
- Press **SEL** to confirm the setting.

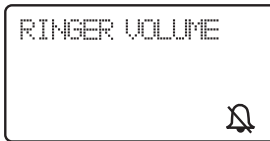
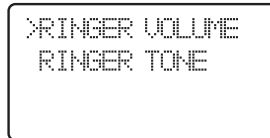

Ringer Tone

- From the idle (**OFF**) mode, press **SEL** then ▼ key to **RINGER VOLUME**.
- Press **SEL** then you are prompted to choose **INTERCOM CALL** or **OUTSIDE CALL**. Press ▲ and ▼ keys to select the desired option.
- Press **SEL** again. You can then use ▲ and ▼ keys or enter digit 0-9 to sampling the ring tone. The screen, for example, will show:

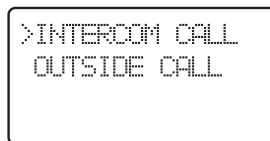



Handset Settings

- Press **SEL** to confirm your setting.

Key Tone (preset to ON)

- From the idle (**OFF**) mode, press **SEL** then **▲** or **▼** key to **KEY TONE**.
- Press **SEL** again. The current setting will be shown. Press **▲** and **▼** keys to scroll to **ON** or **OFF**. When set to **ON**, the handset will emit a beep whenever a key is pressed.
- When the desired option is shown, press **SEL** to confirm your selection.

INTERCOM RINGER
1

*KEY TONE
HANDSET NAME

*KEY TONE
OFF

Key Click (preset to ON)

When you press a key on the Handset, you hear a confirmation 'click'. You can turn this feature Off and On by doing the following:

- 1) Press **SEL**
- 2) Press the **▲** or **▼** key until the **KEY CLICK** option is shown as follows:
- 3) Press **SEL**, to enter the key click sub-menu.
- 4) Enable key click by pressing **1** or **▲**, or disable key click by pressing the **0** or **▼** key.
- 5) Press **SEL**, to confirm the setting.

*PHONE BOOK
CALL LOG

*KEY CLICK
HANDSET NAME

KEY CLICK
IS ON

KEY CLICK
IS OFF

*KEY CLICK
HANDSET NAME



Handset Settings

Handset Name

It is possible to give each Handset its own unique name. The name is shown in the first line during idle replacing the "VTECH", normally shown when the Handset is idle.

The name can be a maximum of 16 characters in length.

The Handset naming procedure is as follows:

- 1) Press **SEL**
- 2) Press the **▲** or **▼** keys until the **HANDSET NAME** option is shown as follows:
- 3) Press **SEL**, to enter the Handset name sub-menu.
- 4) Enter Handset name (characters are entered in the same way as for the phone book)5) Press **SEL**, to confirm the setting.

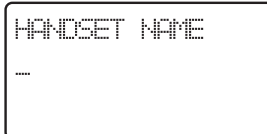
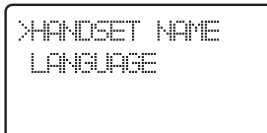

When returning to idle the display shows:

Handset Name (preset as 'VTECH')

- From the idle (**OFF**) mode, press **SEL** then **▲** or **▼** key to **HANDSET NAME**.
- Press **SEL** again. The display will show the current setting, for example:
- Press **DEL** to backspace then 'spell' the desired name.
NOTE: The characters are entered in the same way as for the phone book, see the table in page 27.
- Press **SEL** to confirm the setting.

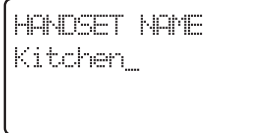
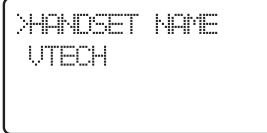
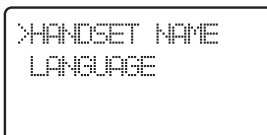



Handset Settings

Language (preset to English)

- From the idle (**OFF**) mode, press **SEL** then ▲ or ▼ key to **LANGUAGE**.
- Press **SEL** to select this option. Press ▲ and ▼ keys to scroll from English to French or Spanish.
- Press **SEL** to confirm the setting.

```

LANGUAGE
CLEAR MSG WAIT

```

```

HANDSET NAME
FRENCH

```

Message Waiting

Your telephone can detect a Visual Message Waiting signal, generated by many telephone service providers. If you subscribe to Voice Mail service from your local telephone company (fee required), and a Visual Message Waiting signal is provided, the Handset will display **MESSAGES WAITING**, alerting you to new messages.

Once you have reviewed all new messages, the Messages Waiting alert will automatically be turned off.

Clear Message Waiting

If, after reviewing all new voice mail messages, the Messages Waiting alert still remains on the screen and the (place the envelope icon here) LED on Base is still ON, you can manually remove the indication from the screen and turn the LED off.

- From the idle (**OFF**) mode, press **SEL** then ▲ or ▼ key to **CLEAR MSG WAIT**.
- Press **SEL** then the display will ask you **TURN INDICATOR OFF?** Press **SEL** again to confirm. To exit, Or press **OFF**.

```

CLEAR MSG WAIT
DIAL TYPE

```

```

TURN INDICATOR
OFF?

```

Dial Type (preset to Tone)

- From the idle (**OFF**) mode, press **SEL** then ▲ or ▲ key to **DIAL TYPE**.

```

DIAL TYPE
PHONE BOOK

```

Handset Settings

- Press **SEL** then use ▲ and ▼ key to scroll TONE to PULSE.
- Press **SEL** to confirm your setting.

NOTE: When the phone is set for PULSE dial mode, it is possible to switch to temporary TONE mode during an ongoing call by pressing *. Once pressed, TONE will be used for rest of the call. After you hang up, the phone will return to pulse dialing for the next call.

Dial Method (Tone)

It is possible to change the method of dialing between Tone and pulse dialing, if your local phone company requires pulse dialing in your area:

- 1) Press **SEL**
- 2) Press the ▲ or ▼ keys until the DIAL TYPE option is shown as follows:
- 3) Press **SEL**, to enter the dial sub-menu.
- 4) Press ▲ or ▼ to choose the method of dialing, the display looks like the one below
- 5) Alternately the user can select pulse dialing by pressing **1** or ▲. Select DTMF dialing by pressing **0** or ▼.
- 6) Press **SEL** to confirm the setting.

DIAL TYPE
PULSE

>PHONE BOOK
CALL LOG

>DIAL TYPE
PHONE BOOK

>DIAL TYPE
TONE

>DIAL TYPE
PULSE

>DIAL TYPE
PHONE BOOK



Handset Settings

Temporary Tone

When the phone is set for pulse dial mode, it is possible to switch to temporary Tone mode during an ongoing call by pressing *. Once pressed, TONE will be used for the rest of the call. After you hang up, the phone will return to pulse dialing for the next call.

Call Forward & Call Transfer

An external call can be forwarded or transferred from one Handset to the other Handset. The difference between forward and transfer depends on if the sending Handset needs to talk with the receiving Handset,

Call Forward

A Handset on an external call can forward it to the other Handset by holding down the **INT** key. The display will initially show:

SENDING CALL TO
OTHER HANDSET

If the Base can connect to the other Handset, the display will change to:

CALL SENT TO
OTHER HANDSET

And then return to the idle display. by pressing **INT** to reconnect to the external call.

If the Base cannot find the other Handset as a result of it being out of range or powered off, the display will show:

OTHER HANDSET
NOT AVAILABLE

And the external will 'call back' to the Handset.

Call Transfer

An external call is transferred by:

1. Press INT key (the external call is put on hold)
2. Destination Handset will ring, showing an intercom call.
3. Pressing the ON key on the destination Handset will answer the intercom call.
4. Inform the person using the destination Handset that they have a call on hold.
5. Press OFF, on the first Handset, to transfer external call to other Handset.

If there is no answer on the destination Handset, the first Handset can reconnect to the held call



Handset Settings

Call Back

After forwarding a call, a CALL BACK is generated in the forwarding Handset if the forwarded call is not answered within 30 seconds. When a call is returned to a Handset, it will show the following while ringing:

If the returned call is not answered within 30 seconds, the phone automatically goes on hook, dropping the external call.



Conference

It is possible to establish a conference between two Handsets and the external line.

If a Handset already has a connection to the external line, and another Handset goes off-hook, a conference is immediately established. Both handsets will show:



If a Handset is on the process of transferring a call to the other Handset it is possible to conference with both calls by holding down the **INT** key. Holding **INT** when connected to either party, when transferring, or call toggling, will immediately conference both Handsets and external line.

A Handset can leave the conference by going on-hook, by pressing **OFF**, or placing the Handset on the Base or charging cradle. The connection continues between the remaining Handset and the external party.

Redial at On-Hook state

Pressing **REDIAL** while the Handset is idle or pre-dialing will access the last dialed number. Subsequent presses of **REDIAL** will access previously dialed numbers. After the fifth number the redial list will cycle back to the most recently dialed number. Alternately, you can use the **▲** and **▼** keys to scroll through the 5 previously dialed numbers.

Pressing **OFF** will cancel the redial list review.

Pressing **ON** or **SPK** will add the shown redial number to any pre-dialed digits, go off-hook and start dialing.

Redial at Off-Hook state

Pressing **REDIAL** when on an external call will display the last dialed number. After two second the shown number will be automatically dialed. If during this time, **REDIAL** is pressed again the display will return to the external call presentation, and the number will not be dialed.



Handset Settings

Flash

During an ongoing external call, press the **FLASH/ON** key to flash the line (to respond to a Call Waiting signal, for example).

Mute

It is possible to mute the microphone during a conversation by pressing the **DELETE/MUTE** key. The microphone is un-muted by pressing **DELETE/MUTE** again.

In case the external line is muted, when establishing an intercom connection, the line is un-muted automatically after the intercom call is terminated. The line is also un-muted after the FLASH feature is used.

A text message in the display indicates when the microphone is first muted.

The MUTE icon will also be shown whenever the microphone is muted.

When mute is disabled, this message will briefly be shown:

And the MUTE icon will turn off.

BASE IS
PAGING!

ACTIVE 00:00:12
MICROPHONE MUTED
MUTE

MUTE
ACTIVE 00:00:15
555-1212
MUTE

ACTIVE 00:00:12
MICROPHONE ON!

ACTIVE 00:00:15
555-1212





Handset Settings

Page

The page function is used as an aid to locate the Handsets. It can be only done from the Base.

To activate paging press the **PAGE** button on the base.

All Handsets not currently active on a call will show:

BASE IS
PAGING!

and start the paging sound.

Either Handset can cancel the page by pressing any of the **PHONE, 0-9, *, #** or **SPK** keys.

Or, press **PAGE** at the Base to cancel the page.



Handset Operation

Headset Operation

Your **ip 5825** Handset is equipped with a 2.5mm Headset Jack for use with an optional accessory Headset for hands-free operation. If you choose to use the Headset option, you must obtain an optional accessory Headset, which is compatible with the **ip 5825**.

To purchase a Headset, call VTech Customer Service at 1-800-595-9511.

Once you have a compatible 2.5mm Headset, locate the Headset Jack on the **ip 5825** Handset. Connect the plug on the Headset cord to the jack (under a small rubber flag) on the cordless Handset. The plug should fit securely. Do not force the connection.

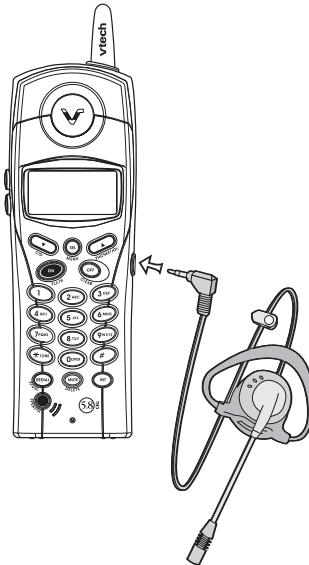

NOTE:

Whenever a compatible Headset is connected to the cordless Handset, the microphone on the Handset will be muted. This is done to limit the effect of background noise.

Advanced Operation

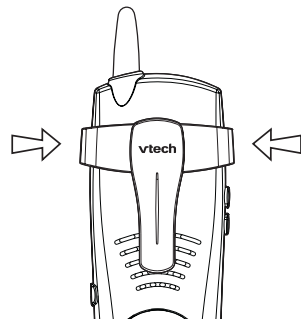

Belt Clip

The **ip 5825** is also equipped with a detachable belt clip. Align the pins on the inside edge of the clip with the notches on the sides of the Handset. The belt clip should snap securely into place. Do not force the connection.





Maintenance

Taking Care Of Your Telephone

Your cordless telephone contains sophisticated electronic parts, so it must be treated with care.

Avoid rough treatment

Place the Handset down gently. Save the original packing materials to protect your telephone if you ever need to ship it.

Avoid water

Your telephone can be damaged if it gets wet. Do not use the Handset outdoors in the rain, or handle it with wet hands. Do not install your Base Unit near a sink, bathtub or shower.

Electrical storms

Electrical storms can sometimes cause power surges harmful to electronic equipment. For your own safety, use caution when using electric appliances during storms.

Cleaning your telephone

Your telephone has a durable plastic casing that should retain its luster for many years. Clean it only with a soft cloth slightly dampened with water or a mild soap. Do not use excess water or cleaning solvents of any kind.

Remember that electrical appliances can cause serious injury if used when you are wet or standing in water. If your Base Unit should fall into water, **DO NOT RETRIEVE IT UNTIL YOU UNPLUG THE POWER CORD AND TELEPHONE LINE CORDS FROM THE WALL.** Then pull the unit out by the unplugged cords.

In Case Of Difficulty

If you have difficulty operating your phone, the suggestions below should solve the problem. If you still have difficulty after trying these suggestions, call VTECH Communications at 1-800-595-9511. In Canada, call VTECH Telecommunications Canada Ltd at 1-800-267-7377.

The Phone Doesn't Work At All

- Make sure the Power Cord is plugged in.
- Make sure the telephone line cord is plugged firmly into the Base Unit and the telephone wall jack.
- Make sure the batteries are properly charged. If you get a 'LOW BATTERY' message or indication, the battery pack needs charging.

No Dial Tone

- First check all the suggestions above.
- If you still don't hear a dial tone, disconnect the Base Unit from the telephone jack and connect a different phone. If there is no dial tone on that phone either, the problem is in your wiring or local service. Contact your local telephone company.



In Case Of Difficulty

You Get Noise, Static, Or A Weak Signal Even When You're Near The Base Unit

- Household appliances plugged into the same circuit as the Base Unit can sometimes cause interference. Try moving the appliance or the Base Unit to another outlet.

You Get Noise, Static, Or A Weak Signal When You're Away From The Base Unit

- You may be out of range. Either move closer to the Base, or relocate the Base Unit.
- The layout of your home may be limiting the range. Try moving the Base Unit to another position.

The Handset Does Not Ring When You Receive A Call

- Make sure you have the ringers activated. Refer to the section(s) on **setting the ringer** in this User's Manual.
- Make sure the telephone line cord is plugged firmly into the Base Unit and the telephone jack. Make sure the power cord is plugged in.
- You may be too far from the Base Unit.
- You may have too many extension phones on your telephone line to allow all of them to ring. Try unplugging some of the other phones.

You Hear Other Calls While Using Your Phone

- Disconnect your Base Unit from the telephone jack, and plug in a corded telephone. If you still hear other calls, the problem is probably in your wiring or local service. Call your local telephone company.

You Hear Noise In The Handset, And None Of The Keys Or Buttons Work

- Make sure the power cord is plugged in.

Common Cure For Electronic Equipment

If the unit does not seem to be responding normally, then try putting the Handset in the cradle. If it does not seem to respond, do the following (in the order listed):

1. Disconnect the power to the Base.
2. Disconnect the Handset battery, and spare battery pack, if applicable.
3. Wait a few minutes.
4. Connect power to the Base.
5. Re-install the battery pack (s)
6. Watch for Handset to display:
"VTECH"

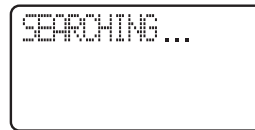

then





Warranty Statement

What does this limited warranty cover?

• The manufacturer of this VTech product, VTech Communications, warrants to the holder of a valid proof of purchase (“Consumer” or “you”) that the product and all accessories provided by VTech in the sales package (“Product”) are free from material defects in material and workmanship, pursuant to the following terms and conditions, when installed and used normally and in accordance with operation instructions, This limited warranty extends only to the Consumer for Products purchased and used in the United States of America.

What will VTech Communications do if the Product is not free from material defects in materials and workmanship during the limited warranty period (i°Materially Defective Productj±)?

• During the limited warranty period, VTech’s authorized service representative will repair or replace at VTech’s option, without charge, a Materially Defective Product. If we repair this product, we may use new or refurbished replacement parts. If we choose to replace this product, we may replace it with a new or refurbished product of the same or similar design. VTech will return repaired or replacement products to you in working condition. VTech will retain defective parts, modules, or equipment. Repair or replacement of Product, at VTech’s option, is your exclusive remedy. You should expect the repair or replacement to take approximately 30 days.

How long is the limited warranty period?

• The limited warranty period for the product extends for ONE(1) YEAR from the date of purchase if we repair or replace a Materially Defective Product under the terms of this limited warranty. This limited warranty also applies to repaired or replacement Products for a period of either (a) 90 days from the date the repaired or replacement Product is shipped to you or (b) the time remaining on the original one-year warranty; whichever is longer.

What is not covered by this limited warranty?

This limited warranty does not cover

1. Product that has been subjected to misuse, accident, shipping or other physical damage, improper installation, abnormal operation or handling, neglect, inundation, fire, water or other liquid intrusion; or
2. Product that has been damaged due to repair, alteration or modification by anyone other than an authorized service representative of VTech; or
3. Product to the extent that the problem experienced is caused by signal conditions, network reliability or cable or antenna systems; or
4. Product to the extent that the problem is caused by use with non-VTech electrical accessories; or
5. Product whose warranty/quality stickers, Product serial numbers plates or electronic serial numbers have been removed, altered or rendered illegible; or

Additional Information



Warranty Statement

- 6. Product purchased, used, serviced, or shipped for repair from outside the United States, or used for commercial or institutional purposes (including but not limited to Products used for rental purposes); or
- 7. Product returned without valid proof of purchase (see 2 below); or
- 8. Charges for installation or set up, adjustment of customer controls, and installation or repair of systems outside the unit.

How do you get warranty service?

- To obtain warranty service in the United States of America, call 1 800-595- 9511 for instructions regarding where to return the Product. Before calling for service, please check the user's manual. A check of the Product controls and features may save you a service call.
- Except as provided by applicable law, you assume the risk of loss or damage during transit and transportation and are responsible for delivery or handling charges incurred in the transport of Product(s) to the service location. VTech will return repaired or replaced product under this limited warranty to you, transportation, delivery or handling charges prepaid. VTech assumes no risk for damage or loss of the Product in transit.
- If the Product failure is not covered by this limited warranty, or proof of purchase does not meet the terms of this limited warranty, VTech will notify you and will request that you authorize the cost of repair and return shipping costs for the repair of Products that are not covered by this limited warranty.

What must you return with the Product to get warranty service?

1. Return the entire original package and contents including the Product to the VTech service location along with a description of the malfunction or difficulty;
2. Include valid proof of purchase" (sales receipt) identifying the Product purchased (Product model) and the date of purchase or receipt; and
3. Provide your name, complete and correct mailing address, and telephone number.

Other Limitations

- This warranty is the complete and exclusive agreement between you and VTech. It supersedes all other written or oral communications related to this Product. VTech provides no other warranties for this product. The warranty exclusively describes all of VTech's responsibilities regarding the product.
- There are no other express warranties. No one is authorized to make modifications to this limited warranty and you should not rely on any such modification.
- State Law Rights: This warranty gives you specific legal rights, and you may also have other rights, which vary from state to state.

Limitations: Implied warranties, including those of fitness for a particular purpose and merchantability (an unwritten warranty that the product is fit for ordinary use) are limited to one year from date of purchase. Some states do not allow limitations on how long an implied warranty lasts, so the above limitation may not apply to you.

Additional Information





FCC, ACTA and IC Regulations

• In to event shall VTech be liable for any indirect, special, incidental, consequential, or similar damages (including, but not limited to lost profits or revenue, inability to use the product, or other associated equipment, the cost of substitute equipment, and claims by third parties) resulting from the use of this product, some states do not allow the exclusion or limitation of incidental or consequential damages, so the above limitation or exclusion may not apply to you.

FCC, ACTA and IC Regulations

This equipment complies with Parts 15 of the Federal Communications Commission (FCC) rules for the United States. It also complies with regulations RSS210 and CS-03 of Industry and Science Canada. Operation is subject to the following two conditions: (1) this device may not cause interference, and (2) this device must accept any interference, including interference that may cause undesired operation of the device.

A label is located on the underside of the Base Unit containing either the FCC registration number and Ringer Equivalence Number (REN) or the IC registration number and Load Number. You must, upon request, provide this information to your local telephone company.



This equipment is compatible with inductively coupled hearing aids. Should you experience trouble with this telephone equipment, please contact:



VTech Communications Inc

CUSTOMER SERVICE at 1-800-595-9511. In Canada, call VTech Telecommunications Canada Ltd. at 1-800-267-7377.

For repair/warranty information. The telephone company may ask you to disconnect this equipment from the line network until the problem has been corrected.

FCC Part 15

Warning: Changes or modifications to this unit not expressly approved by the party responsible for compliance could void the user's authority to operate the equipment.

The equipment has been tested and found to comply with part 15 of the FCC rules. These limits are designed to provide reasonable protection against harmful interference in a residential installation. This equipment generates, uses and can radiate radio frequency energy and, if not installed and used in accordance with the instructions, may cause harmful interference to radio communications.

However, there is no guarantee that interference will not occur in a particular installation. If this equipment does cause harmful interference to radio or television reception, which can be determined by turning the equipment off and on, the user is encouraged to try and correct the interference by one or more of the following measures:

- Reorient or relocate the receiving antenna.





FCC, ACTA and IC Regulations

- Increase the separation between the equipment and receiver.
- Connect the equipment into an outlet or on a circuit different from that to which the receiver is connected.
- Consult the dealer or an experienced radio/TV technician for help.

To ensure safety of users, the FCC has established criteria for the amount of radio frequency energy that can be safely absorbed by a user or bystander according to the intended usage of the product. This product has been tested and found to comply with the FCC criteria. The handset has such a low power that it does not require testing. It may be safely held against the ear of the user. The base unit shall be installed & used such that parts of the user's body other than the hands should be maintained at a comfortable distance of approximately 20 cm or more.

FCC and ACTA Information

If this equipment was approved for connection to the telephone network prior to July 23, 2001, it complies with Part 68 of the Federal Communications Commission (FCC) rules. If the equipment was approved after that date, it complies with the Part 68 rules and with Technical Requirements for Connection of Equipment to the Telephone Network adopted by the Administrative Council for Terminal Attachments (ACTA). We are required to provide you with the following information.

1. Product identifier and REN information

The label on the back or bottom of this equipment contains, among other things, an identifier indicating product approval and the Ringer Equivalence Number (REN). This information must be provided to your local telephone company upon request. For equipment approved prior to July 23, 2001, the product identifier is preceded by the phrase "FCC Reg No." and the REN is listed separately. For equipment approved after that date, the product identifier is preceded by "US" and a colon (:), and the REN is encoded in the product identifier without a decimal point as the sixth and seventh characters following the colon. For example, the product identifier US:AAAEQ01B123XYZ would indicate an REN of 0.3. The REN is used to determine how many devices you may connect to your telephone line and still have them ring when you are called. In most, but not all areas, the sum of all RENs should be five (5.0) or less. You may want to contact your local telephone company for more information.

2. Connection and use with the nationwide telephone network

The plug and jack used to connect this equipment to the premises wiring and the telephone network must comply with the applicable Part 68 rules and technical requirements adopted by ACTA. A compliant telephone cord and modular plug is provided with this product. It is designed to be connected to a compatible modular jack that is also compliant. An RJ11 jack should normally be used for connecting to a single line and an RJ14 jack for two lines. See Installation Instructions in the user's manual. This equipment may not be used with Coin Telephone Lines or with





FCC, ACTA and IC Regulations

Party Lines. If you have specially wired alarm dialing equipment connected to your telephone line, ensure the connection of this equipment does not disable your alarm equipment. If you have questions about what will disable alarm equipment, consult your telephone company or a qualified installer.

3. Repair instructions

If this equipment is malfunctioning, it must be unplugged from the modular jack until the problem has been corrected. Repairs to this telephone equipment can only be made by the manufacturer or its authorized agents. For repair procedures, follow the instructions outlined under the Limited Warranty.

4. Rights of the telephone company

If this equipment is causing harm to the telephone network, the telephone company may temporarily discontinue your telephone service. The telephone company is required to notify you before interrupting service. If advance notice is not practical, you will be notified as soon as possible. You will be given the opportunity to correct the problem and the telephone company is required to inform you of your right to file a complaint with the FCC. Your telephone company may make changes in its facilities, equipment, operation, or procedures that could affect the proper functioning of this product. The telephone company is required to notify you if such changes are planned.

5. Hearing aid compatibility

If this product is equipped with a corded or cordless Handset, it is hearing aid compatible.

6. Programming/testing of emergency numbers

If this product has memory dialing locations, you may choose to store police, fire department and emergency medical service telephone numbers in these locations. If you do, please keep three things in mind:

a We recommend that you also write the telephone number on the directory card, so that you can still dial the emergency number manually if the memory dialing feature doesn't work.

b This feature is provided only as a convenience, and the manufacturer assumes no responsibility for customer reliance upon the memory feature.

c Testing the emergency telephone numbers you have stored is not recommended. However, if you do make a call to an emergency number:

- You must remain on the line and briefly explain the reason for the call before hanging up.

- Programming/testing of emergency numbers should be performed during off-peak hours, such as in the early morning or late evening, when the emergency services tend to be less busy.

IC (Industry Canada)



FCC, ACTA and IC Regulations

This telephone is registered for use in Canada.
The term "IC:" before the radio certification number only signifies that Industry Canada technical specifications were met.

Notice:

This equipment meets the applicable Industry Canada Terminal Equipment Technical Specifications. This is confirmed by the registration number. The abbreviation, IC, before the registration number signifies that registration was performed based on a Declaration of Conformity indicating that Industry Canada technical specifications were met. It does not imply that Industry Canada approved the equipment.

Notice:

The Ringer Equivalence Number (REN) for this terminal equipment is 0.1. The REN assigned to each terminal equipment provides an indication of the maximum number of terminals allowed to be connected to a telephone interface. The termination on an interface may consist of any combination of devices subject only to the requirement that the sum of the Ringer Equivalence Numbers of all the devices does not exceed five.

Repairs to certified equipment should be made by an authorized Canadian maintenance facility designated by the supplier. Any repairs or alterations made by the user to this equipment, or equipment malfunctions, may give the telecommunications company cause to request the user to disconnect the equipment.

Users should ensure for their own protection that the electrical ground connections of the power utility, telephone lines and internal metallic water pipe system, if present, are connected together. This precaution may be particularly important in rural areas.

Caution:

Users should not attempt to make such connections themselves, but should contact the appropriate electrical inspection authority, or electrician, as appropriate.

Your Cordless Phone is designed to operate at the maximum power allowed by the FCC and IC. This means your Handset and Base Unit can communicate only over a certain distance - which will depend on the location of the Base Unit and Handset, weather, and the construction and layout of your home or office.

Additional Information





The RBRC® Seal

The RBRC® Seal



The RBRC® Seal on the nickel-metal-hydrate battery indicates that VTech Communications, Inc. is voluntarily participating in an industry program to collect and recycle these batteries at the end of their useful lives, when taken out of service within the United States and Canada.

The RBRC® program provides a convenient alternative to placing used nickel-metal-hydrate batteries into the trash or municipal waste, which may be illegal in your area.

VTech's partnership in RBRC® makes it easy for you to drop off the spent battery at local retailers participating in the RBRC® program or at authorized VTech product service centers. Please call **1-800-8-BATTERY** for information on Ni-MH battery recycling and disposal bans/restrictions in your area. VTech's involvement in this program is part of its commitment to protecting our environment and conserving natural resources.

RBRC® is a registered trademark of Rechargeable Battery Recycling Corporation.



Technical Specifications

FREQUENCY CONTROL

Crystal controlled
PLL synthesizer

TRANSMIT FREQUENCY

Base : 5744.736 - 5825.952 MHz
Handset: 2401.056 - 2482.272 MHz

RECEIVE FREQUENCY

Base: 2401.056 - 2482.272 MHz
Handset : 5744.736 - 5825.952 MHz

CHANNELS

95 Channels

NOMINAL EFFECTIVE RANGE

Maximum power allowed by FCC and IC. Actual operating range may vary according to environmental conditions at the time of use.

SIZE

Handset : 182mm x 55.3mm x 40mm
(including antenna)
Base : 115.8mm x 112.2mm x 62.6mm
Charger: 76.5mm x 79.4mm x 45.2mm

WEIGHT

Handset : 146 grams
(excluding Batteries)
Base : 210 grams
Charger : 225 grams

POWER REQUIREMENTS

Handset : 3.6V 750mAh NiMH
(3 AAA cells)
Base : 9 V @ 600mA
Charger : 9 V @ 150mA

MEMORY

Speed Dial: 50 Memory locations; up to 32 digits per location
CID : Alphanumeric Display
50 Memory locations

**SPECIFICATIONS ARE TYPICAL
AND MAY CHANGE WITHOUT
NOTICE.**





Table Of Contents

IMPORTANT SAFETY INSTRUCT.....	1
INTRODUCTION.....	3
Parts Check List.....	4
The Handset Layout.....	5
The Base Unit Layout.....	6
GETTING STARTED.....	7
SETUP.....	7
Connecting power to Base Unit/Handset Charger.....	7
Installation of Battery Cells in Handset.....	8
Charging of the Handset Battery Cells.....	8
Connecting to phone line.....	9
Checking for dial tone.....	9
Wall Mounting.....	10
BASIC OPERATION.....	11
Handset and Base Indicators.....	11
Handset Icons.....	11
Handset LEDs.....	11
Base LEDs.....	11
Handset Operation.....	12
Making Calls.....	12
Answering Calls.....	12
Intercom Call.....	13
Phone Book Operation.....	15
Storing a new entry.....	16
Reviewing/Dialing from the phone book.....	16
Editing a phone book entry.....	17
Delete a phone book entry.....	17
Calls Log (Caller ID - Call Waiting).....	18
Quick Dialing.....	21
Entering a Quick Dial number.....	21
Reviewing quick dial numbers.....	22
Dialing a Quick Dial number.....	23
Editing a Quick Dial Number.....	24
Deleting a Quick Dial Number.....	24
Handset Setting.....	25
Audio Volume.....	25
Ringer Volume.....	25
Ringer tone.....	25
Key Tone (preset to ON).....	26
Key Click.....	26
Handset Name.....	27
Language.....	28
Message Waiting.....	28
Clear Message waiting.....	28
Dial Type (preset to Tone).....	28



Table Of Contents

Dial Method.....	29
Temporary Tone.....	30
Call Forward & Call Transfer.....	30
Call Forward.....	30
Call Transfer.....	30
Call Back.....	31
Conference.....	31
Redial at On-Hook state.....	31
Redial at Off-Hook state.....	31
ADVANCED OPERATION.....	31
Flash.....	32
Mute.....	32
Page.....	33
HEADSET OPERATION.....	34
ADDITIONAL INFORMATION.....	35
Maintenance.....	35
In Case Of Difficulty.....	36
Warranty Statement.....	37
FCC, ACTA and IC Regulations.....	39
The RBRC® Seal.....	43
Technical Specifications (this part will change accordingly).....	44



vtech

VTECH TELECOMMUNICATIONS LTD.

vtech A member of THE VTECH GROUP OF COMPANIES.

Distributed in the U.S.A. by VTech Communications, Inc. Beaverton,
Oregon, 97008

Distributed in Canada by VTech Telecommunications Canada Ltd.
7671 Alderbridge Way, Richmond, B.C. V6X 1Z9.

Printed in China

91-5467-10-00
ISSUE 0

