



## Important Safety Instructions

---

When using your telephone equipment, basic safety precautions should always be followed to reduce the risk of fire, electric shock and injury, including the following:

1. Read and understand all instructions.
2. Follow all warnings and instructions marked on the product.
3. Unplug this product from the wall outlet before cleaning. Do not use liquid cleaners or aerosol cleaners. Use a damp cloth for cleaning.
4. Do not use this product near water (for example, near a bath tub, kitchen sink, or swimming pool).
4. Do not place this product on an unstable cart, stand, or table. The product may fall, causing serious damage to the product.
5. Do not place this product on an unstable cart, stand, or table. The product may fall, causing serious damage to the product.
6. Slots and openings in the cabinet and the back or bottom are provided for ventilation. To protect it from overheating, these openings must not be blocked by placing the product on the bed, sofa, rug, or other similar surface. This product should never be placed near or over a radiator or heat register. This product should not be placed in a built-in installation where proper ventilation is not provided.
7. This product should be operated only from the type of power source indicated on the marking label. If you are not sure of the type of power supply to your home, consult your dealer or local power company.
8. Do not allow anything to rest on the power cord. Do not locate this product where the cord will be abused by persons walking on it.
9. Never push objects of any kind into this product through cabinet slots as they may touch dangerous voltage points or short out parts that could result in a risk of fire or electric shock. Never spill liquid of any kind on the product.
10. To reduce the risk of electric shock, do not disassemble this product, but take it to an authorized service facility. Opening or removing cabinet parts other than specified access doors may expose you to dangerous voltages or other risks. Incorrect reassembling can cause electric shock when the appliance is subsequently used.
11. Do not overload wall outlets and extension cords as this can result in the risk of fire or electric shock.
12. Unplug this product from the wall outlet and contact VTECH under the following conditions:
  - A. When the power supply cord or plug is damaged or frayed.
  - B. If liquid has been spilled into the product.
  - C. If the product has been exposed to rain or water.
  - D. If the product does not operate normally by following the operating instructions. Adjust only those controls that are covered by the operating instructions, because improper adjustment of other controls may result in damage and will often require extensive work to restore the product to normal operation.
  - E. If the product has been dropped and the cabinet has been damaged.
  - F. If the product exhibits a distinct change in performance.



## **Important Safety Instructions**

---

13. Avoid using a telephone (other than a cordless type) during an electrical storm. There may be a remote risk of electric shock from lightning.
14. Do not use this or any cordless telephone to report a gas leak in the vicinity of the leak.



**If you have questions about this product, or if you're having difficulty with setup or operation, do not return your phone to the store. Call our Customer Support Center at**

**1-800-595-9511**

**In Canada, call**

**1-800-267-7377**

**SAVE THESE INSTRUCTIONS**





## Introduction

---

This is an advanced cordless telephone, capable of supporting 2 Handsets. This manual is designed to familiarize you with this cordless telephone. We strongly recommend you read the manual before using your phone.

### **STOP!!**

**If you have questions about this product, or if you're having difficulty with setup or operation, do not return your phone to the store. Call our Customer Support Center at 1-800-595-9511 In Canada, call 1-800-267-7377**



## Parts Check List

1. Base Unit
2. Handset
3. Handset Charger
4. Base AC Power Adapter
5. Telephone Line Cord
6. Belt Clip
7. Base Wall Mounting Bracket
8. Charger Wall Mounting Bracket
9. Owner's Manual
10. 6 AAA Cells

To purchase replacement battery cells, call VTech Communications, Inc. at 1-800-595-9511. In Canada, call VTech Telecommunications Canada Ltd. at 1-800-267-7377.

Note: Use only VTech batteries P/N 80-5380-00-00 or equivalent AAA NiMH rechargeable batteries.

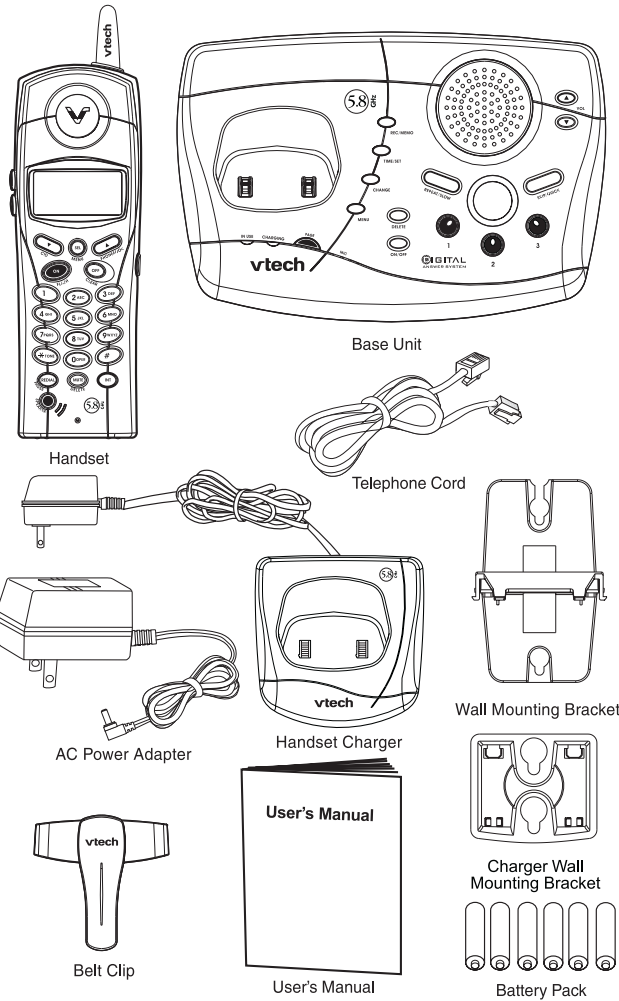

## The Handset Layout

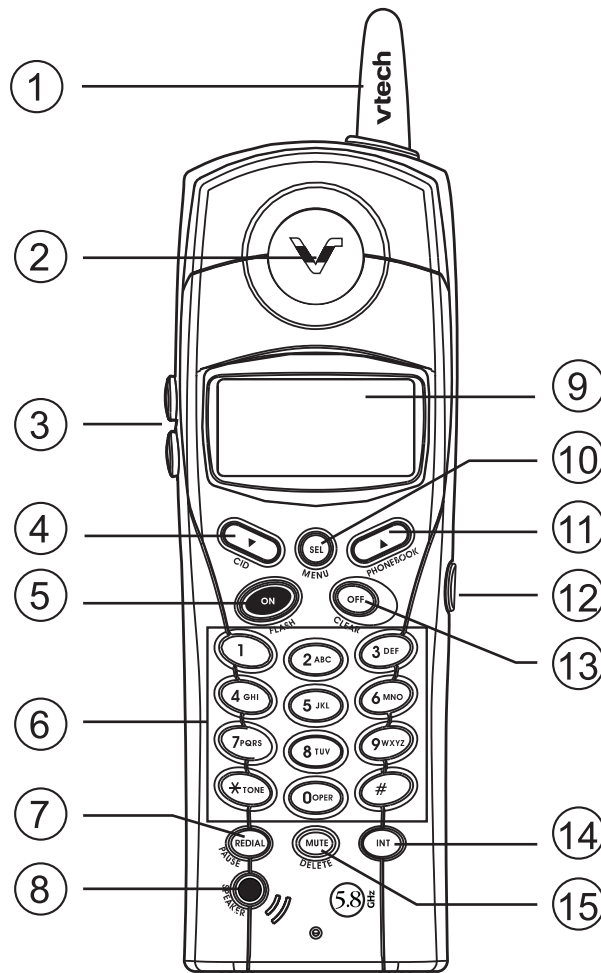

- |                             |                          |
|-----------------------------|--------------------------|
| 1. Antenna                  | 9. LCD Display           |
| 2. Earpiece                 | 10. Select (Menu)        |
| 3. Volume Control           | 11. Phonebook            |
| 4. CID                      | 12. Headset jack (2.5mm) |
| 5. On (Flash)               | 13. Off (Clear)          |
| 6. Dialing Keys (0-9, *, #) | 14. Intercom             |
| 7. Redial (Pause)           | 15. Mute (Delete)        |
| 8. Speakerphone             |                          |

## The Base Unit Layout

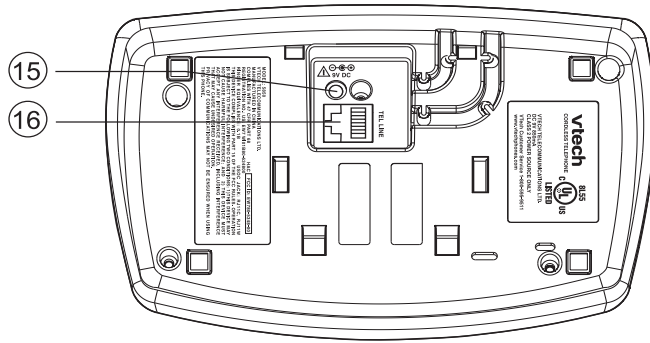
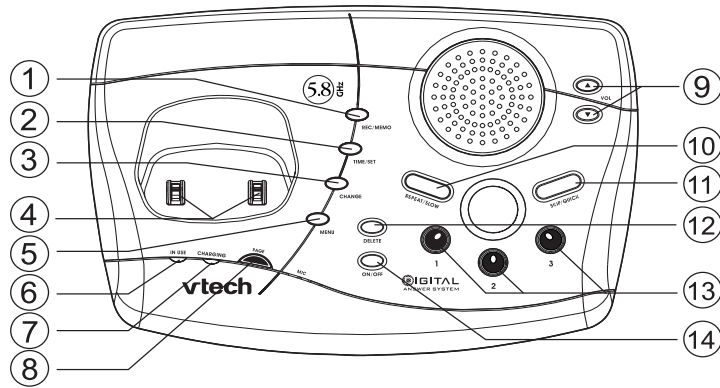

- 1.
- 2.
- 3.
- 4.
- 5.
- 6.
- 7.
- 8.

- 9.
- 10.
- 11.
- 12.
- 13.
- 14.
- 15.

**Connecting power to Base Unit/Handset Charger**

1. Plug the AC power adapter into an electrical outlet, and the DC connector into the bottom of the Base Unit.

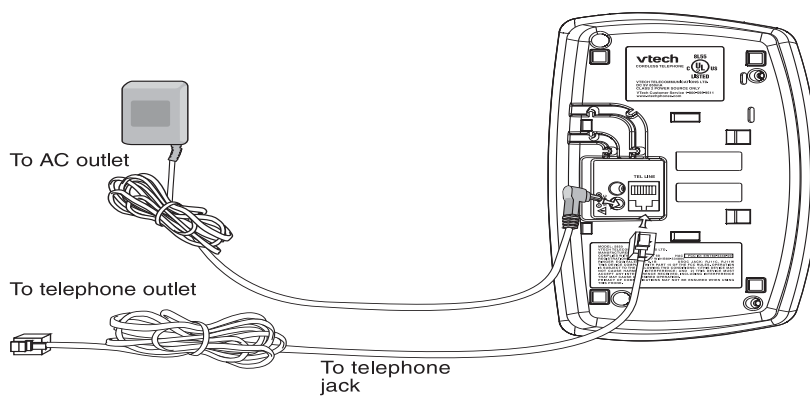

2. Choose the location for your Handset Charger, and plug its power supply into an electrical outlet.

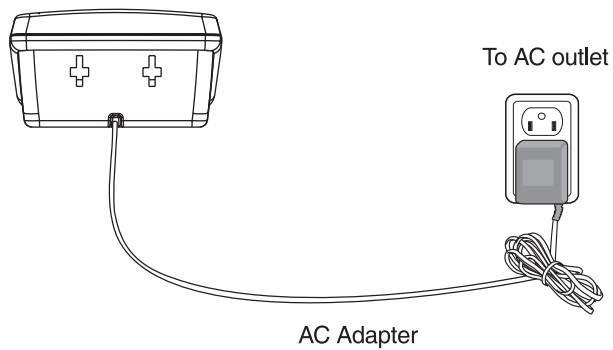

### Installation of Battery Cells in Handset

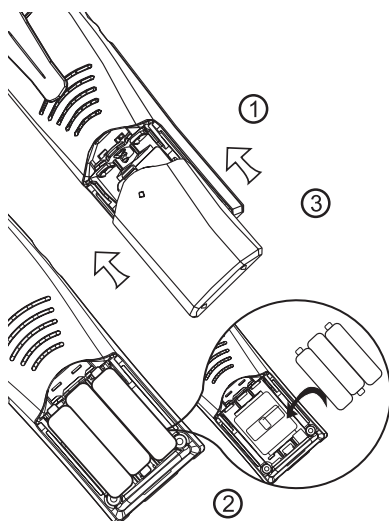

Follow the steps below:

1. Remove the battery cover by pressing on the indent and sliding downward.
2. Place the new battery cells in the Handset with the positive and negative poles aligned in the battery compartment.
3. Replace the battery cover by sliding it upwards.
4. If the new battery cells are not already charged, place the Handset in its Charger, and allow it to charge for 12 hours. After initial charge, a maintenance charge of 8 hours should be sufficient.

### Charging of the Handset Battery Cells

The Handset of your cordless telephone is powered by rechargeable battery cells. It charges automatically whenever the Handset is in its charger.

**You should charge the battery pack for 12 hours when you first receive your phone.** You'll know the battery pack needs charging when:

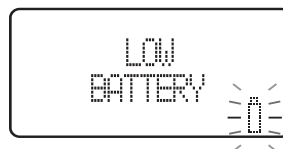

- The low battery message is displayed :
- The Handset seems completely dead, the LCD is completely clear and does

not activate when you press the keys.

#### **IMPORTANT:**

1. Do not dispose of battery cell in a fire, the cell may explode.
2. Do not open or mutilate the battery cell. Toxic substances may be released, causing harm to eyes or skin.
3. Exercise care in handling battery cell in order to prevent an accidental short of the charge contacts, potentially causing the battery pack to overheat.
4. Do not dispose of this battery cell into household garbage. Please refer to the information concerning proper battery recycling.



5. Do not charge the battery cell with other electrical device.

**Connecting to phone line**

Plug one end of the telephone line cord into the jack on the back of the Base Unit. Plug the other end of this cord into the wall jack.

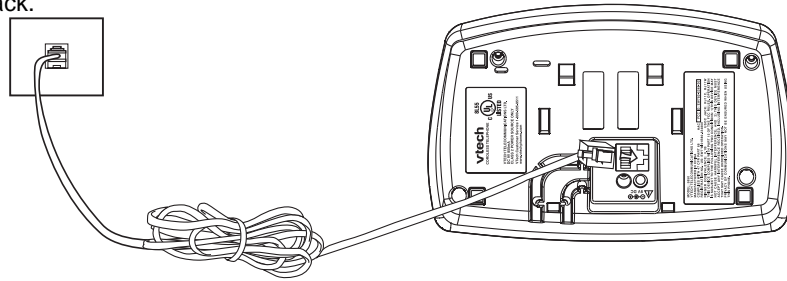

**Checking for dial tone**

After the battery is charged, press **ON** on the Handset. The Phone icon will appear on the Handset display, and you will hear dial tone. If not, see **In Case of Difficulty**.

**Tone/Pulse selection**

Your phone is preset for tone dialing. See **BASE SETTINGS** for details.

**CAUTION:** Use only the VTech power supply provided with your telephone.

**IMPORTANT:**

FOR MAXIMUM PERFORMANCE OF YOUR CORDLESS TELEPHONE SYSTEM:

1. Choose a central location for your Base Unit.
2. Install your Base Unit and Extension Handsets way from electronic equipment, such as personal computers, television sets and microwave ovens.
3. In locations where there are multiple cordless telephones, separate base units as much as possible.
4. Install your telephone equipment away from heat sources and sunlight.
5. Avoid excessive moisture, dust or extreme cold.

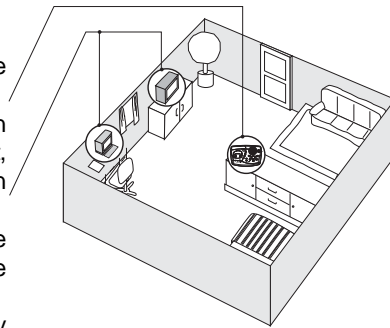

## Wall Mounting

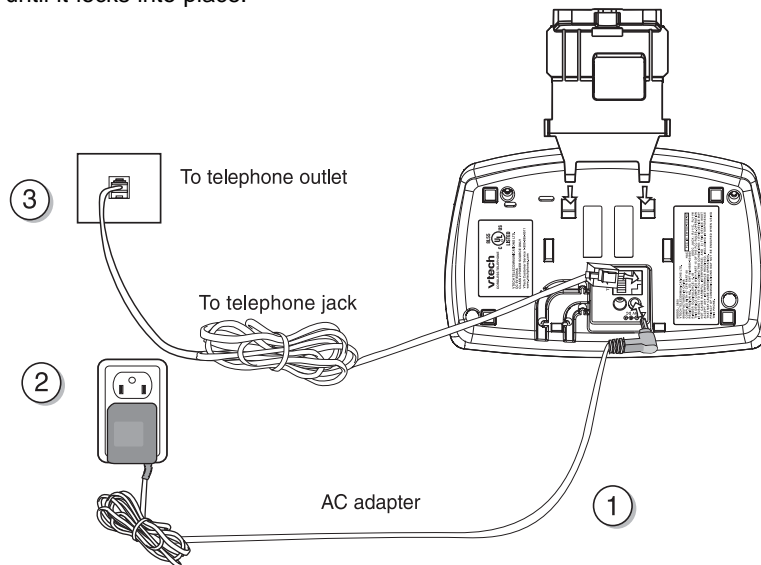

The Wall Mount brackets are designed for use on standard wall mount plates only. Wall mounting is optional.

1. Plug the AC adapters into an electrical outlet, and the DC connector to the bottom of the Base Unit.
2. Connect the telephone line cord to the jack on the bottom of the Base Unit, and the other end to the wall jack.
3. Line up the tabs on the wall mount adapters with the holes on the bottom of the Base Unit/back of the Handset Charger. Snap the wall mount bracket firmly in place.
4. Mount the Base Unit/Handset Charger on the wall. Position the Base Unit/Handset Charger so the mounting studs will fit into the holes on the wall mount bracket. Slide Base Unit/Handset Charger down on the mounting studs until it locks into place.



## Handset and Base Indicators

### Handset Icons

Icon	Description
<b>MUTE</b>	<ul style="list-style-type: none"> <li>• Turns on when the microphone is muted</li> </ul>
<b>NEW</b>	<ul style="list-style-type: none"> <li>• Turns on when there are new call log entries.</li> </ul>
18/8818: 88 PM	<ul style="list-style-type: none"> <li>• CID date and time information</li> </ul>
	<ul style="list-style-type: none"> <li>• Turns on when the ringer is muted.</li> </ul>
	<ul style="list-style-type: none"> <li>• Low battery indicator and charging indicator</li> </ul>

## Handset and Base Indicators

### Handset LEDs

LED	Description
	<ul style="list-style-type: none"> <li>• Speaker LED (Orange)</li> <li>• LED is on when in a handsfree mode.</li> </ul>

### Base Unit Icons

Icon	Description

### Base LEDs

LED	Description
<b>IN USE</b>	<ul style="list-style-type: none"> <li>• On when the phone is off hook.</li> <li>• Flashes when an extension phone or the TAD is off hook.</li> </ul>
<b>CHARGING</b>	<ul style="list-style-type: none"> <li>• On when the handset is charging in the cradle.</li> </ul>
<b>PAGE</b>	<ul style="list-style-type: none"> <li>• Will perform a global page.</li> </ul>
<b>MAILBOX 1,2,3</b>	<ul style="list-style-type: none"> <li>• Flashes when new messages are in the appropriate mailbox. On when only old messages are in the appropriate mailbox. Off when no messages are in the appropriate mailbox.</li> </ul>
<b>VOLUME<sup>^</sup>/v</b>	<ul style="list-style-type: none"> <li>• Adjusts the ITAD speaker volume. There are 7 volume levels.</li> </ul>
<b>MENU</b>	<ul style="list-style-type: none"> <li>• This key is used to scroll through the ITAD menu options</li> </ul>
<b>CHANGE</b>	<ul style="list-style-type: none"> <li>• This key is used to select the various menu options.</li> </ul>
<b>TIME/SET</b>	<ul style="list-style-type: none"> <li>• When pressed in idle mode, the current time will be announced. When pressed in menu mode, the current setting will be confirmed or reviewed.</li> </ul>
<b>REC/MEMO</b>	<ul style="list-style-type: none"> <li>• This key will put the ITAD into record mode to record the OGM or a memo.</li> </ul>
<b>DELETE</b>	<ul style="list-style-type: none"> <li>• This key will cause the ITAD to erase the ICM, OGM or memo. One or all messages can be erased.</li> </ul>
<b>REPEAT/ SLOW</b>	<ul style="list-style-type: none"> <li>• This key is used to repeat a message or play a message slowly. If the key is pressed and released, the message will be repeated. If the key is held, the message will play back at half the normal speed.</li> </ul>
<b>S K I P / QUICK</b>	<ul style="list-style-type: none"> <li>• This key is used to skip a message or play a message quickly. If the key is pressed and released, the message will be skipped. If the key is held, the message will play back at twice the normal speed.</li> </ul>

## Handset Operation

### Making Calls

- Press **ON** (or, **SPEAKERPHONE** to use the Handset Speakerphone feature). Dial the phone number.
- OR-
- Dial the phone number first; then press **ON** (or **SPEAKERPHONE**).
- Press **OFF** to end your call

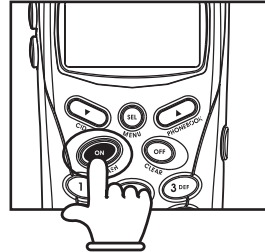

### Answering Calls

From the Handset

- Press any key except **OFF** and the softkeys.
- Press **OFF** to end your call.

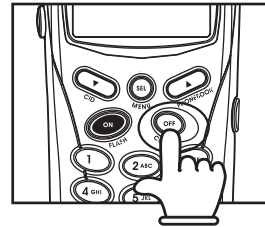

### Intercom Call

Pressing INT key when the handset is idle initiates an intercom call.

- Press **INT**

The call is performed and when the other handset answers, the display will change to:

CALLING  
OTHER HANDSET

If the other handset is out of range, turned off or on an external call, the display will show and a busy tone will be heard on the earpiece, or through the speaker if in handsfree mode.

INTERCOM  
OTHER HANDSET

An intercom call is terminated by:

- Pressing **OFF** or **INT**,
- Placing the handset in the charger

UNABLE TO CALL  
AT THIS TIME

After terminating an INTERCOM CALL, the display on both handsets will show:

On the handset that did not terminate the call, a busy tone will be heard, indicating the other handset has ended the call. After several seconds the display will return to idle and the busy tone will stop.

INTERCOM ENDED



## Phone Book Operation

The handsets share a common phone book, which is stored in the base station. This means that entries inserted by one handset are available for both handsets, and if one deletes a phone book entry, it will disappear from both handsets. The phone book size will hold 50 entries, with names of a maximum length of 16 characters and a 32-digit maximum phone number. The phone book entries are sorted and presented to the user in alphabetical order.

Names are entered using the numerical keys. Multiple key presses of the dialing digit keys is used to generate characters, see the table below. The cursor moves to the next position if another numerical key is pressed or by pressing the ▲ key. The last entered character is deleted by pressing **DELETE** or ▼. The entire name is cleared by holding down **DELETE**.

Key	Characters by number of key presses								
	1	2	3	4	5	6	7	8	9
1	space	1							
2	A	B	C	2	a	b	c		
3	D	E	F	3	d	e	f		
4	G	H	I	4	g	h	i		
5	J	K	L	5	j	k	l		
6	M	N	O	6	m	n	o		
7	P	Q	R	S	7	p	q	r	s
8	T	U	V	8	t	u	v		
9	W	X	Y	Z	9	w	x	y	z
0	0								
*	*	?	!	/	(	)			
#	#	'	,	-	.	&			

The phone book is entered via the menu, as described below or by pressing the ^ key in idle (quick access key) whereby the handset jumps directly to the phone book search menu.

The phone book is accessed as follows:

1) Press **SEL**, to enter the menu.

```
>PHONE BOOK
CALL LOG
```

2) **SEL**, to enter the Phone book sub-menu.

```
>REVIEW
STORE
```





## Phone Book Operation

### Storing a new entry

1) Press the ▲ key in idle, or scroll through the sub-menu with the ▲ and ▼ keys and press **SEL** with "STORE" in the first line.

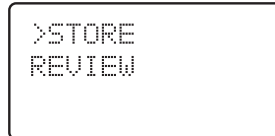

2) If the phone book is full the screen will show,

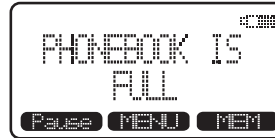

3) If the phone book is not full, the user will be prompted to enter the phone number to be stored as shown below:

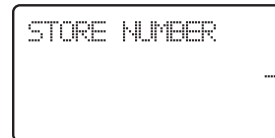

4) Enter the number, up to 32 digits. Press **DELETE** to backspace.

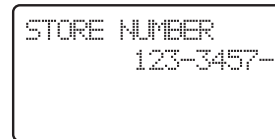

In cases the number exceeds 16 digits, the top line will be used to show the entire number.

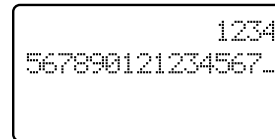

5) Press **SEL** to confirm the number. If there is duplicate number in the phone book, the screen will show:

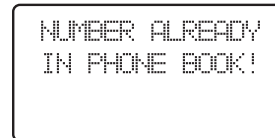

and the Handset will return to the 'STORE NUMBER' screen. If the number is unique, you will move to the name entry screen,

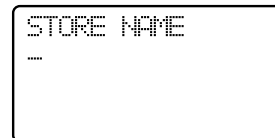

6) Enter the associated name. Use 1 to add a space and **DELETE** to backspace.

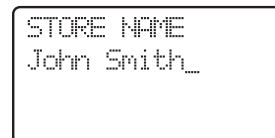

7) Press **SEL** to confirm the name. A name must be entered, or you cannot proceed to the next step. Unlike phone numbers, duplicate names are allowed. The new record will be stored in the phone book.

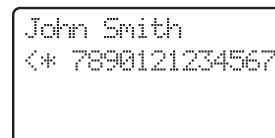

## Phone Book Operation

The user can press **CLEAR** to return to the phone book operation screen, which will show the last operation:

```
>STORE  
REVIEW
```

### Dialing from the phone book

A number can be recalled and dialed from the phone book by:

- 1) Press the **▲** key in idle, or scroll through the menu with the **▲** & **▼** keys and press **SEL** with "REVIEW" in the first line. The first phone book entry will be shown.
- 2) Scroll through the phone book entries using **▲** and **▼** keys or enter first character of the name to be searched (using the dial digit keys) and continue navigating using the **▲** or **▼** as scroll keys, until you reach the entry to be dialed.
- 3) Press **ON** or **SPK**, to dial the number.

```
Kevin James  
432-5434
```

```
John Smith  
555-1212
```

```
ACTIVE 00:00:10  
555-1212
```

### Editing a phone book entry

- 1) Press the **▲** key in idle, or scroll through the menu with the **▲** & **▼** keys and press **SEL** with "REVIEW" in the first line.
- 2) Scroll through the phone book entries using **▲** and **▼** keys or enter first character of the name to be searched (using the dialing keys) and continue navigating using the **▲** or **▼** as scroll keys, until you reach the entry to be edited.
- 3) Press **SEL** to enter number edit mode
- 4) Edit the number as required, using the following options:

```
Kevin James  
432-5434
```

```
John Smith  
555-1212
```

```
EDIT NUMBER  
123-4567_
```

When editing or storing a number, you may do any of the following:

- Enter a digit by pressing **0-9**,



## Phone Book Operation

- Enter a pause by holding **REDIAL**,
  - Delete a digit by pressing **DELETE**,
  - Delete the entire string by holding **DELETE**,
  - Position the cursor to another location by pressing **▲** or **▼**,
  - Insert a number from the redial list by pressing **REDIAL**.
- 5) Press **SEL** to confirm the number and enter name edit mode.
  - 6) Edit the name as required, using the following options:
    - Enter characters using the keys 0-9, \* and # (See the key/characters table),
    - Press **DELETE** to delete the character under the cursor, or to the left if at the end of the string.
    - Hold **DELETE** to delete the entire string,
    - Press **▲** and **▼** to position move to another character.
  - 7) Press **SEL** to confirm change.

```
EDIT NAME
John Smith_
```

```
John Smith
      555-1212
```

```
Kevin James
      432-5434
```

```
John Smith
      555-1212
```

```
Kevin James
      432-5434
```

### Delete a phone book entry

- 1) Press the **▲** key in idle, or scroll through the sub-menu with the **▲** & **▼** keys and press **SEL** with "REVIEW" in the first line.
- 2) Scroll through the phone book entries using **▲** and **▼** keys or enter first character of the name to be searched (using the dial digit keys) and continue navigating using the **▲** or **▼** as scroll keys, until you reach the entry to be removed.
- 3) Press **DELETE** to delete the entry. The phone returns to the previous entry, or the next entry if the first entry was the entry that was deleted.





## Phone Book Operation

### **Additional note on long phone numbers.**

When reviewing the phone book the second line of the display will display phone number up to 16 digits. For numbers larger than 16 digits only the last 13 digits will be displayed, as shown in the following example:

```
John Smith
< * 12345678990123
```

The "<\*" indicates there are additional digits to the left, and the \* key can be pressed to scroll the display over to see them.

```
John Smith
< * 7890123456 # >
```

"<" and ">" indicate additional digits of the left or right side respectively, and the keys "\*" or "#" can be used to scroll the phone number to see the additional digits,

### **Calls Log (Caller ID - Call Waiting)**

All incoming calls with valid caller ID number are stored in a call log. Name and time/date information is also stored in the call log if the central office sends it out.

```
UTECH
5 NEW CALLS
---
```

The number of entries stored in the call log is indicated in idle mode:

The number of unanswered calls (new), if any, is indicated:

```
UTECH
23 CALLS/5 NEW
```

The new call indication is removed when all calls in the call log have been reviewed. The NEW icon indicates, in all screens, that there are new calls log entries that have not been reviewed.

The call log is entered via the menu, as described below or by pressing the ▼ key in idle (quick access key) whereby the handset jumps directly to the call log review.

```
>PHONE BOOK
CALL LOG
```

The call log is reviewed as follows:

- 1) Press **SEL**, to enter the menu.

## Calls Log (Caller ID - Call Waiting)

2) Press ▼ to get to the call log option

```
>CALL LOG
QUICK DIAL
```

3) **SEL**, to enter the **CALL LOG** menu.

4) The caller name is shown in the first line of the display, and the number in the second line. If time and date information is contained in the CID and there are three lines in the display, it is shown in the third line.

```
John Smith
123-4567
2/2311:59
```

The name contained in the received CID is replaced by the name in the phone book, if the phone book contains a matching number, i.e. the phone book name takes precedence.

5) Scroll through the Call Log entries using ▲ and ▼ keys.

```
A. Person
555-1212
2/2311:57
```

The following actions are possible from the Call Log:

- Dialing the caller displayed by pressing the **ON** or **SPK** keys.
- Deleting the caller displayed by pressing the **DELETE** key. The phone returns to call log review.
- Deleting all entries in the call log by pressing and holding **DELETE**. After this, you will be asked for confirmation by either accepting the deletion with **SEL** (= yes) or canceling it with **OFF** (= no).

If you press **SEL**, all entries in the call log will be deleted and the handset indicates the call log is empty and then returns to the idle state. If you select **OFF**, the phone returns to the last viewed entry.

```
DELETE ALL
CALL LOG?
```

- Storing the caller displayed in the phone book by pressing the **SEL** key. If the call log entry has a name and a number it will be added to the phone book and the screen will show:

```
ADDED TO
PHONE BOOK
```

before returning the call log entry.

If the phone number already exists in the phone



## Calls Log (Caller ID - Call Waiting)

book, the entry will not be stored, and the screen will show:

NUMBER ALREADY  
IN PHONE BOOK!

If there is no room in the phone book for the new entry, the display will show:

PHONE BOOK  
IS FULL!

If the call log entry is missing a name or number, you will be prompted to enter one before the item is stored in the phone book.

If both a name and number is missing, for example as in a private listing, the request will be rejected with the message:

UNABLE TO SAVE  
IN PHONE BOOK!

- Exit the Call Log review by pressing the **OFF** key.
- '!'-character in the right hand side of the first line indicates that the call has not previously been reviewed. The '!'-character is cleared when stepping to the next entry in the log or when leaving the call log.
- The maximum length of the name shown in the first line is 16 characters. If the name as received is longer, only the first 16 characters will be seen.
- The incoming calls are sorted by the order of arrival; the latest is shown first. Calls from the same number will each have separate call log entries.

If the call log is full, the oldest entry is deleted to make room for the new call. If the call log is empty when the user tries to enter to Call log review, a message the following message is displayed:

CALL LOG  
IS EMPTY!

It is possible to change the number format in the call log before storing the name/number in the phone book or dialing the caller. Pressing the '#' key will toggle the number format. The available number formats depend on the number of digits received number.





## Quick Dialing

Up to 10 'quick dial' numbers may be entered into each handset. It is possible to 'quick dial' numbers with just a single key press.

The quick dial list in each handset is unique to that handset and is not shared with the other handset.

### Entering a Quick Dial number

- 1) Press **SEL** when the handset is idle to enter the menu system.
- 2) Move down to the quick dial option by pressing the ▼ key.
- 3) Then press **SEL** to enter the quick dial sub menu.
- 4) Select a quick dial key location using the 0-9 keys. If that location is empty the screen will show:

```
>PHONE BOOK
CALL LOG
```

```
>QUICK DIAL
RING VOLUME
```

```
SELECT QUICK
DIAL NUMBER
```

```
QUICK DIAL x
IS EMPTY!
```

```
STORE NUMBER
.....
```

where 'x' is the location that was selected (0-9). At this point pressing **OFF** will return you to the quick dial select screen as shown in Step 2, or pressing **SEL** will allow you enter a phone number into the selected location. The user will then be prompted to enter a phone number to be dialed, as shown,

A phone number can be entered in much the same way as the phonebook. The following options are also available, if the displayed number has no digits:

- Press ▲ to select an entry from the phone book.

You are presented with the phone book review screen. You can navigate to a desired entry as





## Quick Dialing

described in the phone book section. Pressing **SEL** will copy the stored number to the quick dial number.

- Press **▼** to select an entry from the call log.

You are presented with the call log review screen. You can navigate to a desired entry as describe in the call log section. Pressing **SEL** will copy the phone number shown into the quick dial number.

- Press **RDL** to select an entry from the redial list.

You are presented with the call log review screen. You can navigate to a desired entry as describe in the call log section. Pressing **SEL** will copy the phone number shown into the quick dial number.

If all cases, while reviewing phone book, call log or redial list to copy to the quick dial, pressing **OFF** will return the user to the quick dial number entry screen.

5) The user presses **SEL** to confirm the number. Once confirmed, a quick dial number cannot be edited, only dialed or deleted.

### Reviewing quick dial numbers

- 1) Press **SEL** when the handset is idle to enter the menu system
- 2) Move down to the quick dial option by pressing the **▼** key,

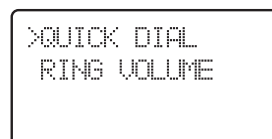
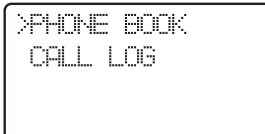



## Quick Dialing

3) Then press **SEL** to enter the quick dial sub menu.

SELECT QUICK  
DIAL NUMBER

4) Select a quick dial key location using the 0-9 keys. If that location has a number assigned to it, it will be displayed as follows:

John Smith  
1-234-567-8901

or

555-1212

At this point, you have the following options:

- Press **OFF** to return to the main menu.
- Press **0-9** to review another quick dial location.
- Press **SEL** to edit the currently shown location. The procedure to edit the number is the same as for editing a phone book number.
- Press **DEL** to delete the currently shown location. The following will be shown:

CONFIRM DELETE  
QUICK DIAL x

Where x is the quick dial location number. Pressing **OFF** will return to the quick dial review as shown above. Pressing **SEL** will confirm the deletion and

QUICK DIAL x  
IS EMPTY!

will be shown, indicating the location has been deleted.

- Press **ON** or **SPK** to dial the displayed number.

### Dialing a Quick Dial number

A quick dial number can be dialed in two ways.

1. While reviewing the quick dial numbers as previously shown.





## Handset Settings

2. While the handset is idle or in pre-dial, as follows:

While the handset is idle the user can perform a quick dial by holding down the desired quick dial location key (0-9). If the location is empty then will be shown for a few seconds before returning to the idle or pre-dial screen.



If the location does have an entry, then that number will be added to any pre-dialed digits and the phone will go off-hook and begin dialing.

### Audio Volume

Audio volume is adjusted during an active call by the following key sequence:

Pressing the volume ▲ or ▼ keys on the side of the unit. Separate volume settings are maintained for normal, handsfree and headset modes. When the volume keys are pressed during a call the screen will show:



As the volume is increase the number of blocks shown will increase. As the volume is decreased fewer blocks will be shown.

### Ring Volume

The volume of the ringer signal can be adjusted by the following key sequence:

- 1) Press **SEL**
- 2) Press the ▼ key until the following is shown on the display.
- 3) Press **SEL** to enter the ring volume sub-menu.
- 4) Enter volume 0 - 6, or adjust using ▲ and ▼ keys. The current ring tone/melody is played

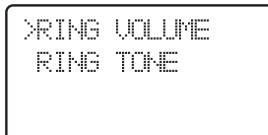
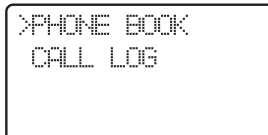

## Handset Settings

each time the setting is adjusted.

- 5) Press **SEL** to confirm the setting.

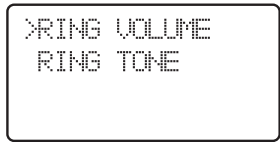

With no bars displayed (Volume Level 0), the ringer has been turned **OFF**.

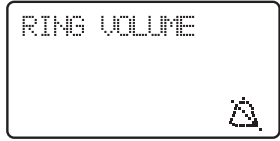

A "ringer off" ICON  is shown in the display when the ringer has been switched off.



### Ring tone

The ring tone of an incoming external/intercom call can be changed by the following key sequence:

- 1) Press **SEL**
- 2) Press the **▲** or **▼** keys until the **RING TONE** option is shown as follows:
- 3) Press **SEL**, to enter the ring pattern menu.
- 4) Press the **▲** & **▼** keys followed by the **SEL** key to choose either **OUTSIDE** or **INTERCOM** ring tone setting.

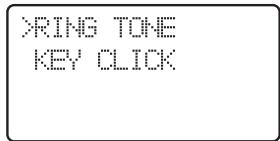
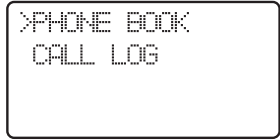

or

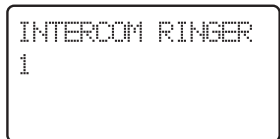
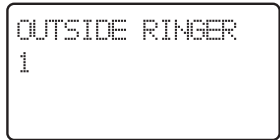

- 5) Enter setting 0 - 9, or adjust using **▲** and **▼** keys. When changed the indicated ring tone will be played in the speaker.
- 6) Press **SEL**, to confirm the setting.

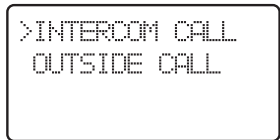





## Handset Settings

### Key Click (preset to ON)

When you press a key on the Handset, you hear a confirmation 'click'. You can turn this feature Off and On by doing the following:

- 1) Press **SEL**
- 2) Press the ▲ or ▼ key until the KEY CLICK option is shown as follows:
- 3) Press **SEL**, to enter the key click sub-menu.
- 4) Enable key click by pressing 1 or ▲, or disable key click by pressing the 0 or ▼ key.
- 5) Press **SEL**, to confirm the setting.

```
>PHONE BOOK
CALL LOG
```

```
>KEY CLICK
HANDSET NAME
```

```
KEY CLICK
IS ON
```

```
KEY CLICK
IS OFF
```

```
>KEY CLICK
HANDSET NAME
```

### Handset Name

It is possible to give each handset its own unique name. The name is shown in the first line during idle replacing the "VTECH", normally shown when the Handset is idle.

The name can be a maximum of 16 characters in length.

The handset naming procedure is as follows:

- 1) Press **SEL**
- 2) Press the ▲ or ▼ keys until the **HANDSET NAME** option is shown as follows:

```
>PHONE BOOK
CALL LOG
```

```
>HANDSET NAME
LANGUAGE
```

